

Technical Service Instruction

Models: RTG 199HE / RTG 199ME

High Temperature kit

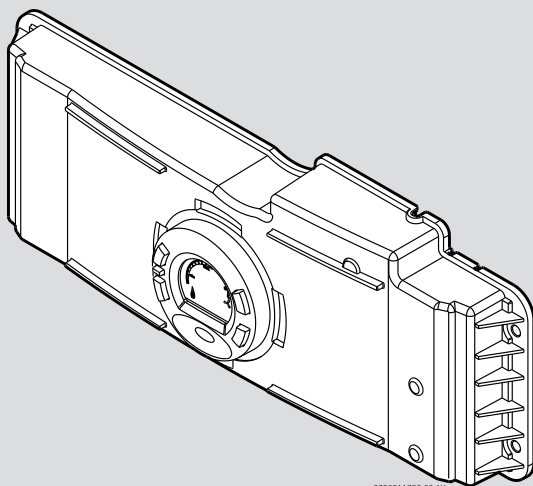

6720811758-00.1V

6720811758 (2014/05) US

Table of contents

1 Key to symbols and safety instructions 2
 1.1 Key to symbols 2

2 Introduction 3

3 Preparation 3

4 Appliance identification 3

5 Control unit service position 3

6 RTG 199ME Models 4
 6.1 Jumper installation 4
 6.2 Software configuration 4

7 RTG 199HE Models 5
 7.1 Jumper installation 5
 7.2 Software configuration 5

1 Key to symbols and safety instructions

1.1 Key to symbols

Warnings



Warnings in this document are identified by a warning triangle printed against a grey background. Keywords at the start of a warning indicate the type and seriousness of the ensuing risk if measures to prevent the risk are not taken.

The following keywords are defined and can be used in this document:

- **NOTICE** indicates a situation that could result in damage to property or equipment.
- **CAUTION** indicates a situation that could result in minor to medium injury.
- **WARNING** indicates a situation that could result in severe injury or death.
- **DANGER** indicates a situation that will result in severe injury or death.

Important information



This symbol indicates important information where there is no risk to people or property.

Additional symbols

Symbol	Explanation
▶	Step in an action sequence
→	Cross-reference to another part of the document
•	List entry
–	List entry (second level)

Table 1

2 Introduction



Note: The installation of this high temperature kit will reduce the heat exchanger warranty to 5 years from the date of original installation and operation. For more details consult the water heater's installation manual for warranty period.

Tools needed:

- Phillips head screw driver
- Small flat head screw driver
- Needle-nosed pliers



NOTICE: Damages to the PCB!

- ▶ Avoid touching printed circuit board (PCB) as static discharge may damage circuitry.



DANGER: Risk of fatal injury from electric shock!

- ▶ Before servicing the water heater, unplug power supply cord from outlet. Failure to do so could result in severe personal injury or death.

3 Preparation

- ▶ Push power button to "OFF" and unplug power cord.
- ▶ Loosen two Phillips head screws on bottom rear of front cover.
- ▶ Pull cover bottom outwards then lift cover upwards to remove.

4 Appliance identification

The high temperature activation is different for RTG 199ME and RTG 199HE models. Here is how to identify which model you have:

Type	Model Number	Model
Condensing	7 736 502 725	RTG 199HE
	7 736 502 726	RTG 199HE

Table 2

Type	Model Number	Model
Non-condensing	7 736 502 727	RTG 199ME
	7 736 502 728	RTG 199ME

Table 2

For RTG 199ME models see chapter 6, for RTG 199HE models see chapter 7.

5 Control unit service position

- ▶ Remove three Phillips screws on front of control unit (Fig. 1).

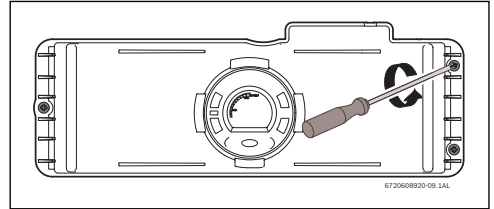

Fig. 1 Control unit front

- ▶ Turn control unit to expose the rear.
- ▶ Remove rear hatch from control unit to expose circuit board electrical connections. (Fig. 2).

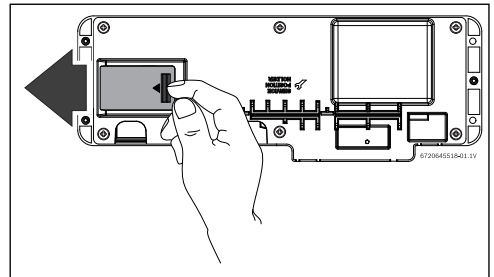

Fig. 2 Control unit rear

- ▶ Control unit rear (wiring not shown for clarity purposes).

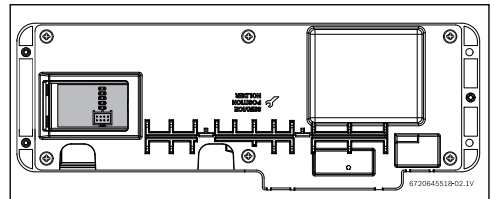

Fig. 3 Control unit rear

6 RTG 199ME Models

6.1 Jumper installation

- ▶ Jumpers 5 and 6 may also be populated based on the model. Do not remove those jumpers.

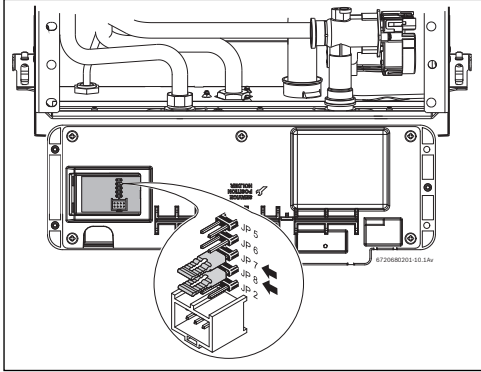

Fig. 4 Optional jumpers 5 and 6 not shown for clarity.

- ▶ Install jumpers from the kit on positions JP7 and JP8.
- ▶ Reinstall the rear hatch.
- ▶ Reinstall the control unit securing the 3 Philips head screws.
- ▶ Plug in power cord.

Jumper	Temperature range	
	ON	OFF (default)
JP7 + JP8	38 °C - 84 °C 100 °F - 184 °F	38 °C - 60 °C 100 °F - 140 °F

Table 3



For DHW recirculating applications, contact a qualified technician, to avoid damage in internal components.

6.2 Software configuration

Setting the desired hot water temperature:

- ▶ Power on the appliance by pressing the  On/Off button.

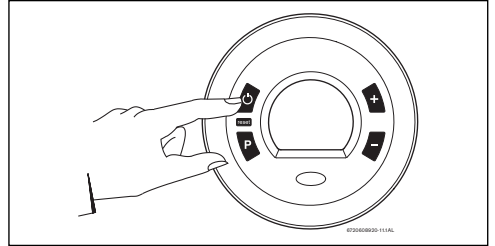



Fig. 5

- ▶ Press the  button in order to reach temperatures above 140 °F (60 °C).

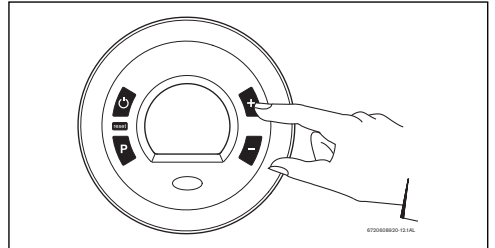

Fig. 6

The Therm appliance is now set at the desired elevated temperature.

7 RTG 199HE Models

7.1 Jumper installation

- ▶ Install jumpers from the kit on positions JP2 and JP5.

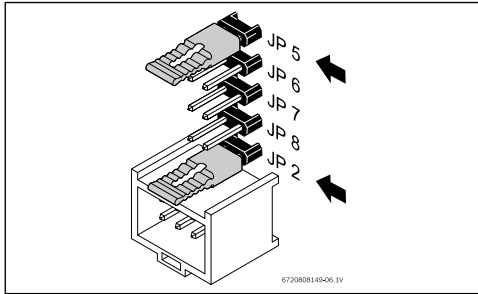

Fig. 7 Jumper configuration

Temperature range	
C	H
38 °C - 84 °C	38 °C - 60 °C
100 °F - 184 °F	100 °F - 140 °F

Table 4

7.2 Software configuration

1. Press ON/OFF button  into ON.
2. The key symbol must appear on the display (Fig. 8).

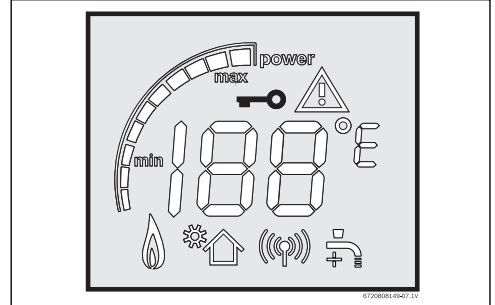











Fig. 8 Key symbol

3. Press and hold buttons  or  and  simultaneously for 3 seconds, until display reads P2.
4. Use the  or  button to cycle through different programs modes, until display shows PE.
5. Press  to enter PE adjustment. The current setting will appear on the display. If not, repeat process.
6. Use the  or  button on the control board to select "C".
7. Hold the  button for 5 seconds until display flashes selection "C".
8. Press ON/OFF button to turn OFF the appliance.
9. Remove the jumpers from the PCB and store them with the technical documentation.



From now on the temperature range is 100 °F - 184 °F.

- ▶ Reinstall the rear hatch.
- ▶ Reinstall the control unit securing the 3 Philips head screws.
- ▶ Plug in power cord.



For DHW recirculating applications, contact a qualified technician, to avoid damage in internal components.

To adjust the temperature:

- ▶ Power on the appliance by pressing the  On/Off button.

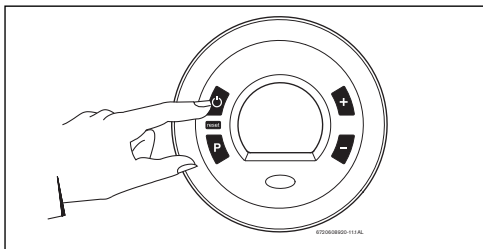



Fig. 9

- ▶ Press the  button in order to reach temperatures above 140 °F (60 °C).

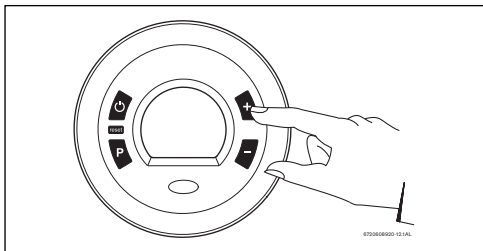

Fig. 10

Notes



6720811758



BRADFORD WHITE®
W A T E R H E A T E R S

Ambler, PA

For U.S. and Canada field service,
Contact your professional installer or
local Bradford White representative.

Sales/800-523-2931

Fax/215-641-1670

Parts Fax/215-641-2180

Technical Support/800-334-3393

Fax/269-795-1089

Warranty/800-531-2111

Fax/269-795-1089

International:

Telephone/215-641-9400

Telefax/215-641-9750



BRADFORD WHITE-CANADA™ INC.
A SUBSIDIARY OF BRADFORD WHITE CORPORATION

Mississauga, ON

Sales/866-690-0961

905-238-0100

Fax/905-238-0105

Technical Support/800-334-3393

Email

parts@bradfordwhite.com

techserv@bradfordwhite.com

www.bradfordwhite.com