

The Bradford White
**ECO-
DEFENDER**

Safety System[®]

Ultra Low NOx Gas Water Heaters



SERVICE MANUAL

**Troubleshooting Guide
and Instructions for Service**

(To be performed ONLY by qualified service providers)



SAFETY SYSTEM[®] WITH SCREENLOK[®] TECHNOLOGY

**For the Bradford White
Eco-Defender Safety**

System[®]

Models:

U130T*FRN
U130S*FRN
U140T*FRN
U1403T*FRN
U1403S*FRN
U1404T*FRN
U1503*FRN

U150L*FRN
U1504S*FRN
U430T*FRN
U440T*FRN
U4403S*FRN
U4503*FRN
U1XR403S*FRN

(*) Denotes Warranty Years.



The Bradford White
**ECO-
DEFENDER**
Safety System[®]

Ultra Low NOx Gas Water Heaters

Table of Contents

	<u>Page</u>	<u>Service Procedure</u>
Introduction	3	---
Gas Control Troubleshooting Chart	5	---
Tools Required for Service	4	---
Burner and Inner Door Gasket Removal, Inspection, Replacement and Installation	7	ED-I
Thermopile Testing and Replacement	10	ED-II
Pilot Assembly Inspection, Cleaning and Replacement	12	ED-III
Igniter and Electrode Testing and Replacement	13	ED-IV
Gas Control Replacement Thermal Well and Chamber Door Sensor Testing and Replacement	14	ED-V
Burner Operation Inspection, Cleaning and Replacement	19	ED-VI
Resettable Thermal Switch Testing and Replacement	21	ED-VII
ScreenLok [®] Flame Arrestor Cleaning	23	ED-VIII
Dip Tube and Anode Inspection and Replacement	24	ED-IX
Generic Parts List	26	---

INTRODUCTION

The Bradford White ECO-DEFENDER Safety System[®]

The Bradford White ECO-DEFENDER Safety System was designed to resist the ignition of flammable vapors that can occur outside of the water heater. In addition, the ECO-DEFENDER Safety System is designed to meet the stringent NOx emissions standards required in the South Coast Air Quality Management District (SCAQMD) Rule 1121. Use and installation are nearly identical to previous versions of atmospherically fired and vented water heaters. A number of exclusive design features are incorporated in the system that will require additional knowledge on the part of the qualified service provider. The following information will instruct service professionals on the function, proper diagnosis and repair of water heaters employing the Bradford White ECO-DEFENDER Safety System.[®]

How the Safety System Works

During normal operation, most air for combustion is drawn into the water heater through the openings in the jacket door. This air travels into the burner venturi, mixing with the gas jet. This air is then mixed with gas inside the burner and drawn to the burner screen and is efficiently combusted producing Ultra Low NOx emissions. Additional air is drawn through the openings in the jacket. This air travels down and around the combustion chamber and enters through holes in the bottom of the corrosion-resistant combustion chamber. The air then travels up through the oriented flame arrestor plate louvers, where the velocity of the air is increased and its direction altered. The air then mixes in a normal manner with the combustion products from the burner.

In the case where trace amounts of flammable vapors are present in the air flowing into the combustion chamber and burner venturi, the vapors are harmlessly ignited by the burner / pilot flame. If flammable vapors are in sufficient quantity to prevent normal combustion, the burner and pilot flames are designed to shut down.

Should the flammable vapors continue to the burner, the flame arrestor plate and burner screen prevent the flames from traveling backwards and igniting vapors outside of the combustion chamber. This causes the thermopile to overheat and shuts down the main pilot and burner. The thermopile powers the intelligent diagnostic control which is capable of recognizing restricted airflow conditions caused by severe lint, dust and oil accumulation on the burner screen and arrestor plate. The intelligent diagnostic control will deactivate the burner and pilot in the unlikely event of restricted airflow.

It is intended for this manual to be used by qualified service personal for the primary purpose of troubleshooting and repair of the Bradford White ECO-DEFENDER Series of water heaters.

The Honeywell WW8860Q Gas Control will display error codes in the event of abnormal operation. Error codes are listed in the troubleshooting chart beginning on page 5 of this service manual. The troubleshooting chart will also indicate the probable cause for the error code and direct the service professional to a service procedure to properly diagnose the abnormal operation.

Contact the Bradford White technical support group immediately if diagnosis can not be made using the methods described in this service manual.

Tools Required for Service

Manometer:	A liquid "U" tube type or a digital (magna-helic) type can be used. This device is used to measure gas and/or air pressure and vacuum.
Multi-Meter:	A digital type is strongly recommended. This device is used to measure electrical values. The meter you select must have the capability to measure volts AC, volts DC, Amps, micro-amps and ohms.
Electronic Probes:	In some cases, standard multi-meter probes will damage or simply not be effective to obtain certain voltage and ohm reading. It will be necessary to have special electronic "pin" type multi-meter probes. These probes are available at most electronic wholesale outlets.
Thermometer:	Used to measure water temperature. An accurate thermometer is recommended.
Water Pressure Gage:	Used to measure water supply pressure. Also used to determine tank pressure by adapting to the drain valve of the heater.
Gas Control Service Tool:	BWC part number 239-45991-00. A specialized tool designed to remove the gas control from gas control thermal well. Available from your Bradford White parts supplier.
Various Hand Tools:	Pipe wrench, channel locks, open end wrenches (3/8", 7/16", 1/2"), 12" crescent wrench, Allen wrench set, screw drivers (common & Phillips), 1/4" nut driver, pliers (common & needle nose), socket set, side cutters wire cutters, wire strippers, wire crimpers, torpedo level, small shop vac, step ladder, flashlight and 5 gallon pail.

Observe red LED indicator on gas control. Error flash codes are displayed with a three second pause before repeating. Check and repair the system as noted in the troubleshooting table below.

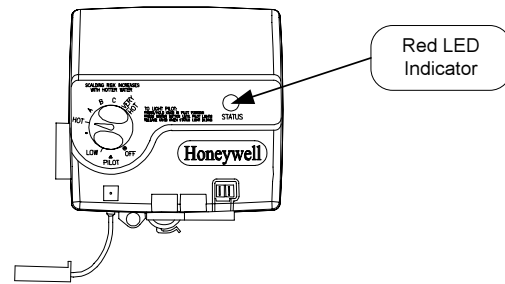

LED Status	Control Status	Probable Cause	Service Procedure
None (LED not on or flashing)	Gas valve is operating normally. Pilot flame may not be present. Check for pilot flame through sight glass and light if necessary.	<ol style="list-style-type: none"> 1. Gas valve is functioning normally 2. Gas valve is not powered. Light pilot 	If the pilot will not stay lit replace thermopile, see page 10. If problem persists replace gas valve, see page 16.
One flash and three second pause.	If set point knob is in "PILOT" position then pilot flame is detected. Turn set point knob to desired setting	Gas valve is powered and waiting for the set point knob to be turned to a water temperature setting.	Normal operation. Adjust thermostat to desired temperature level.
LED on continuously.	Set point knob has been recently turned to the "OFF" position. Wait until LED goes out before attempting to relight	Set point knob was turned to "OFF" position.	LED will go out and the control will function normally when the pilot is lit.
Two flashes and three second pause.	Weak pilot flame detected. System will reset when pilot flame is sufficient.	<ol style="list-style-type: none"> 1. Thermopile failure 2. Unstable pilot. 3. Pilot tube block or restricted. 4. Resettable thermal switch has opened. 	<ol style="list-style-type: none"> 1. See page 10. 2&3. See page 12. 4. See page 21.
Three flashes and three second pause.	Insufficient water heating. System will reset.	<ol style="list-style-type: none"> 1. Thermowell sensor and chamber temperature sensor out of calibration. 2. Possible short. 	1&2. See pages 14 and 18.
Four flashes and three second pause.	Excessive tank temperature. System must be reset.	<ol style="list-style-type: none"> 1. Thermowell sensor out of calibration. 2. Faulty gas valve. 	<ol style="list-style-type: none"> 1. See page 14. 2. See page 16.

LED Status	Control Status	Probable Cause	Service Procedure
Five flashes and three second pause.	Thermostat well fault.	1. Damage to the thermowell wire. 2. Thermowell sensor resistance out of range.	See page 14.
Six flashes and three second pause.	Chamber door temperature sensor out of specification. Possible electrical short.	1. Chamber door temperature sensor out of calibration. 2. Possible electrical short.	See page 18.
Seven flashes and three second pause.	Gas valve electronic fault detected.	1. Control needs to be reset 2. Control is wet or physically damaged	1. Turn gas control knob to "OFF" position and then follow lighting instructions. 2. Replace gas control, see page 16.
Eight flashes and three second pause	False pilot flame present.	Pilot valve stuck in open position.	Replace gas control, see page 16.
Ten flashes and three second pause	Insufficient combustion air detected. Reset system.	Insufficient combustion air.	See page 19 and 23.

ECO-DEFENDER

SERVICE PROCEDURE ED-I

Burner and Inner Door/Gasket Removal, Inspection, Replacement and Reinstallation

Inner Door Removal Procedure

- Step 1. Rotate the gas control knob to the "OFF" position.
- Step 2. Remove outer jacket burner access door
- Step 3. Inner Door Removal.

Gas Control Knob Shown In "OFF" Position



- Disconnect chamber door temperature sensor wire harness from the gas valve.
- Disconnect resettable thermal switch white wire lead (leading from gas valve). Disconnect the red wire leading from the gas valve from the red thermopile wire.
- Disconnect main burner feed line (3/4" wrench), pilot tube (7/16" wrench) and igniter wire from gas valve.
- Remove (2) 1/4" hex drive screws from right side inner door.
- Remove (2) 1/4" drive screws from flange section of inner door.
- Remove (3) 1/4" drive screws from burner door. The burner door and burner are one-piece.
- Remove burner and inner door and inspect per step 4.

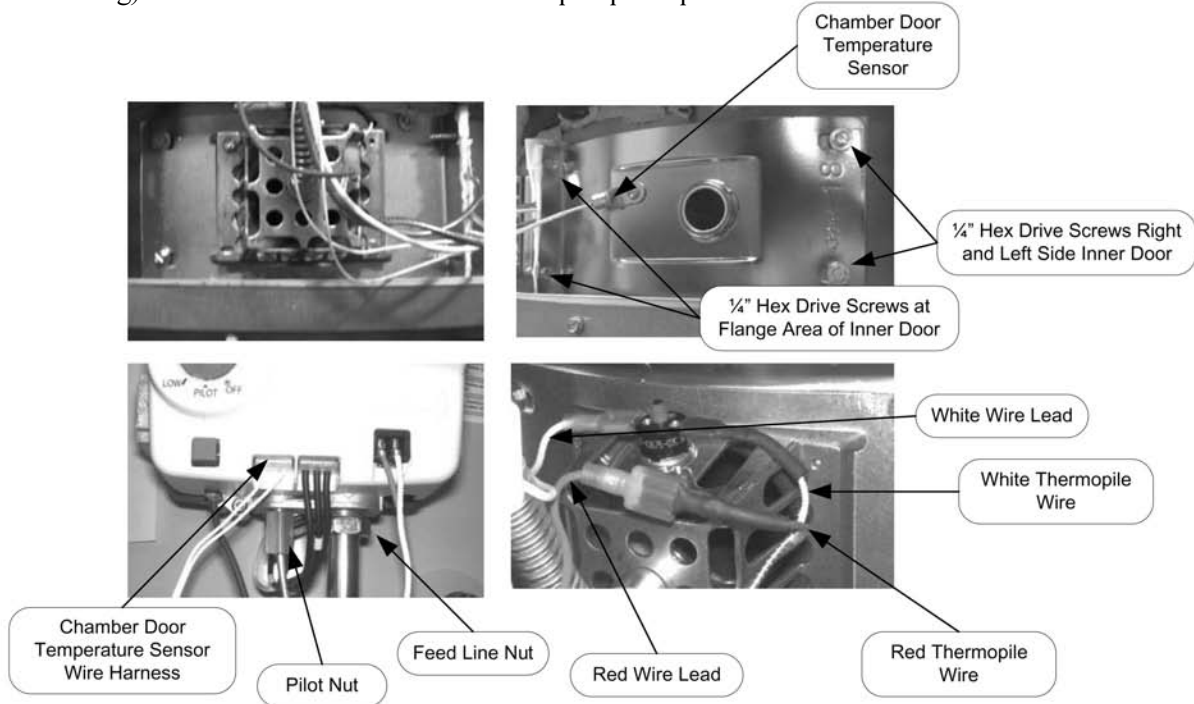

- Step 4. Fully inspect burner and inner door gaskets for the following:
- >Tears
 - >Missing Material
 - >Cracks
 - >Dirt or debris
 - >Other imperfections that will inhibit proper seal
 - >Gasket adhesion to inner door
 - >Material left on combustion chamber (around opening)

If the gasket is not effected by any of the above, gasket replacement is not required. If replacement is required, proceed to **Inner Door Gasket Replacement Procedure.**

ECO-DEFENDER

SERVICE PROCEDURE ED-I

Burner and Inner Door/Gasket Removal,
Inspection, Replacement and
Reinstallation

Inner Door Gasket Replacement Procedure.

⚠ WARNING
If the information in these instructions is not followed exactly, a fire or explosion may result causing property damage, personal injury or death.

- Step 5. After inspection of inner door as noted in step 4, completely remove gasket and adhesive residue from burner and left side inner doors as needed.
- Step 6. Use RTV sealant (recommended bead size 1/8") to secure the inner door gasket to the inner door sections (right & burner). The burner door gasket must be sliced in the location shown on the illustration below in order to slide the gasket over the burner venturi. Refer to illustration below for proper RTV sealant application. Note the overlap configuration in the flange area of the inner door. Set the flange section first, this will help to achieve the proper over lap position.

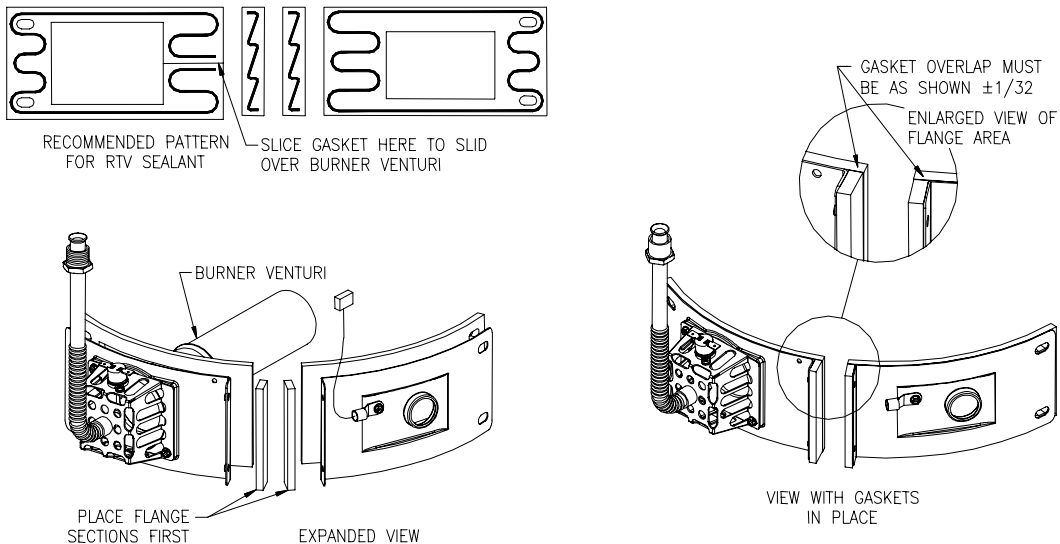

Installation of Inner Door With Gasket.

- Step 7. Clean any residual gasket residue or other debris from combustion chamber surface before installing the inner door/gasket assembly.
- Step 8. Place the burner door into position first. Tighten the feed line nut to the gas valve. Use the 1/4" hex drive screw without the built-in washer to secure the right side of the burner door to the chamber. Use the 1/4" hex drive screws with the built-in washer to secure the left side of the burner door in place. **DO NOT OVER TIGHTEN SCREWS.**
- Step 9. Position thermopile wires, pilot tube and igniter wire against burner door flange gasket.

⚠ WARNING
Stripped fastener connections may allow for seal breach of inner door. A seal breach may result in a fire or explosion causing property damage, personal injury or death. Do not over tighten screws in steps 8, 10 and 11.

If a fastener connection is stripped, contact the manufacturer listed on the water heater rating plate.

ECO-DEFENDER

SERVICE PROCEDURE ED-I

Burner and Inner Door/Gasket Removal, Inspection, Replacement and Reinstallation

Position Thermopile Wire,
Pilot Tube and Igniter Wire

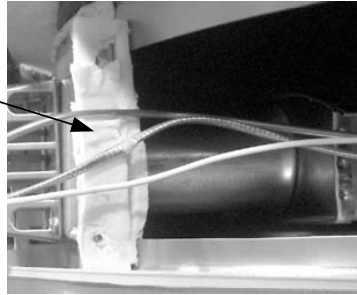

- Step 10. Firmly place right side inner door flange against the burner door flange and secure with two 1/4" drive screws from step 3e. **DO NOT OVER TIGHTEN SCREWS.**
- Step 11. Align right side inner door to combustion chamber and verify the fastener holes of the combustion chamber are aligned with the right side inner door slotted opening. Verify seal integrity around combustion opening. Secure right side inner door using 1/4" hex drive screws from step 3b. **DO NOT OVER TIGHTEN SCREWS.** Verify both burner and right sides of the inner door are properly positioned and sealed against the combustion chamber.

Secure flange with
1/4" drive screws.

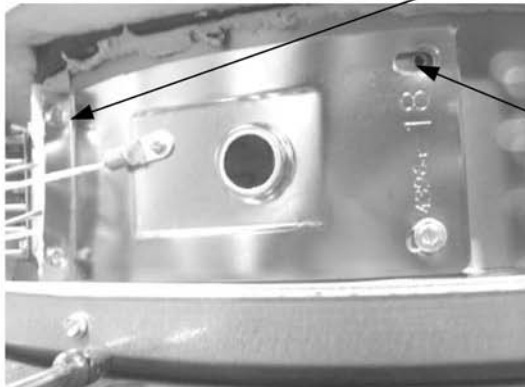

Verify threaded hole
alignment with slotted
openings in inner door.

- Step 12. Reconnect lead wires from gas valve to resettable thermal switch (See photo in step 3). Note, the white wire needs to be connected to the thermal switch and the red wire needs to be connected to the red wire from the thermopile.
- Step 13. Reconnect the wire harness from the chamber door temperature sensor to the gas valve (See photo in step 3).
- Step 14. Tighten the pilot nut to the gas valve.
- Step 15. Replace outer jacket burner access door.
- Step 16. To resume operation follow the instructions located on the lighting instruction label or the lighting instructions located in the installation and operation manual.

CLOSED CIRCUIT THERMOPILE TESTING (Honeywell Control)

- Step 1. Closed circuit testing is the preferred method for testing thermopile. Following the lighting instruction label on the heater, proceed to light the pilot and allow to operate for three minutes. If the pilot will not stay lit, hold the pilot button (rotate the gas control knob to the pilot position, push and hold in) during this test
- Step 2. Using a multimeter capable of measuring millivolts, place one lead of the multi meter on the left side of the wire harness and place the second lead of the multi meter on the right side of the wire harness.
- Step 3. If meter reads 300 millivolts or higher, the thermopile is OK. If reading is below 300 millivolts, replace the thermopile. For maximum thermopile life the thermopile should be replaced with a genuine Honeywell thermopile (BWC P/N 233-47063-00).

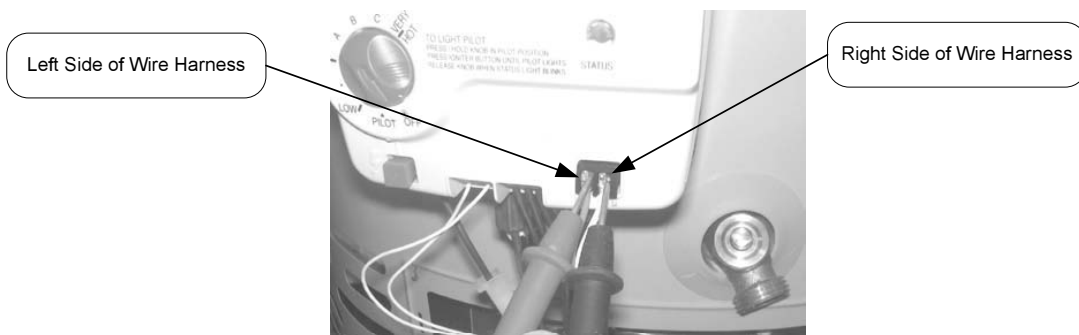

OPEN CIRCUIT THERMOPILE TESTING

- Step 1. Disconnect red thermopile wire from wire harness leading to the gas valve. Disconnect the white thermopile wire from the resettable thermal switch

- Step 2. Using a multimeter capable of measuring millivolts, connect one lead to the red thermopile wire and one lead to the white thermopile wire.

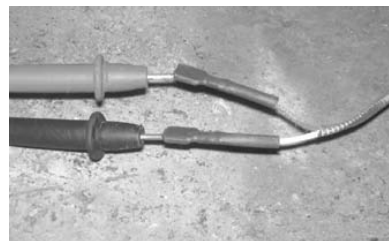

- Step 3. Following the lighting instruction label on the heater, proceed to light the pilot and allow to operate for three minutes. **It will be necessary to hold gas control knob down in the "PILOT" position continuously throughout this test.** Any reading over 400 millivolts indicates good thermopile output.

ECO-DEFENDER

SERVICE PROCEDURE ED-II Thermopile Testing and Replacement

THERMOPILE REPLACEMENT

Step 1. Turn off gas supply to water heater. Rotate gas control knob to the "OFF" position.

Gas Control Knob Shown In
"OFF" Position



Step 2. Remove outer jacket door.

Step 3. Remove right side inner door and burner door per SERVICE PROCEDURE RG-I, steps 3a through 3g.

Step 4. Disconnect the red thermopile wire from the wire harness and the white thermopile wire from the resettable thermal switch. Follow the thermopile leads to the pilot bracket. Disconnect the thermopile from the pilot bracket (7/16" wrench).

Step 5. Install new thermopile into pilot bracket and tighten the nut to the pilot bracket (7/16" wrench). Position thermopile wire against left side inner door flange at its original position. Connect the red thermopile wire to the red lead from the wire harness. Connect the white thermopile wire to the resettable thermal switch.

Step 6. Inspect inner door gasket per SERVICE PROCEDURE ED-I, Step 4.

Step 7. Install right side inner door and burner door per SERVICE PROCEDURE ED-I, Step 7 through Step 16.

Step 8. To resume operation follow the instructions located on the lighting instruction label or the lighting instructions located in the installation and operation manual.

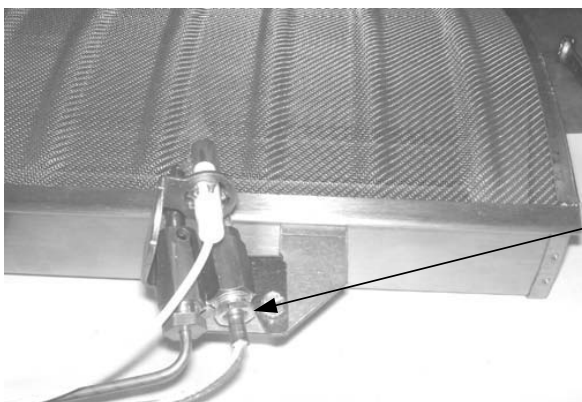

Thermopile Position

ECO-DEFENDER

SERVICE PROCEDURE ED-III

Pilot Assembly Inspection, Cleaning and Replacement

PILOT/ELECTRODE ASSEMBLY INSPECTION, CLEANING AND REPLACEMENT

- Step 1. Turn off gas supply to water heater. Rotate gas control knob to the "OFF" position.
- Step 2. Remove outer jacket door.
- Step 3. Remove burner and right side of inner door per SERVICE PROCEDURE ED-I, steps 3a through 3g.
- Step 4. Remove burner assembly from combustion chamber.
- Step 5. Remove pilot/electrode assembly from burner (1/4" drive tool)
- Step 6. Inspect pilot for the following:
- a) Primary air openings for blockage. Must be free from any debris (dirt, lint, etc).
 - b) Kinks or cracks in the pilot tube. If found, the pilot must be replaced.
- Step 7. Inspect pilot orifice:
- a) Remove 7/16" nut from bottom of pilot assembly.
 - b) Remove pilot tube and pilot orifice.
 - c) inspect pilot orifice for blockage, must be cleaned or replaced.
- Step 8. Install pilot/electrode assembly to burner, secure with screw from step 5.
- Step 9. Install burner and inner door per SERVICE PROCEDURE ED-I, step 4 through 16.
- Step 10. To resume operation follow the instructions located on the lighting instruction label or the lighting instructions located in the installation and operation manual.

Gas Control Knob Shown In "OFF" Position

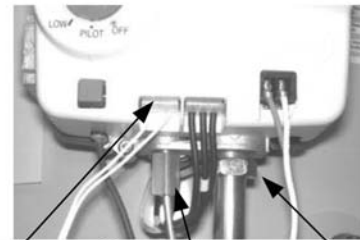

Chamber Door Temperature Sensor

Pilot Nut

Feed Line Nut

Primary Air Opening

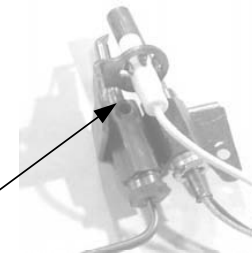

Pilot Orifice

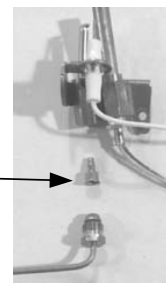

ECO-DEFENDER

SERVICE PROCEDURE ED-IV

Igniter and Electrode Testing and Replacement

IGNITER, ELECTRODE TESTING AND REPLACEMENT

With the pilot not in operation (no pilot flame) you can check the igniter and electrode circuit by viewing pilot thru the sight glass located on the inner door and observing the spark action.

- Step 1. Remove outer jacket door.
- Step 2. Repeatedly depress the igniter button while viewing the pilot thru the sight glass. If a spark is present, the circuit is OK. If there is no spark, proceed to step 3.



- Step 3. Remove white wire from igniter. Hold the igniter lead from the gas valve to an unpainted surface such as the feed line or gas valve and depress the igniter. If there is a spark, the igniter is OK, the pilot is not functioning and must be replaced, see SERVICE PROCEDURE ED-III for pilot replacement. If no spark is present the igniter is not functioning and the control must be replaced, see SERVICE PROCEDURE ED-V

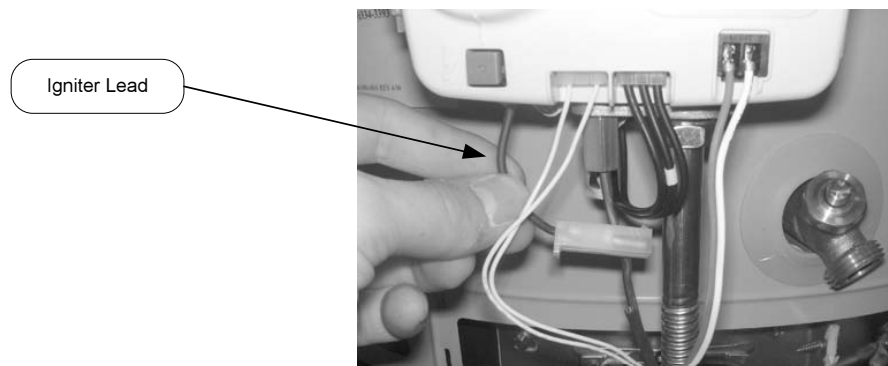

Thermal Well Testing

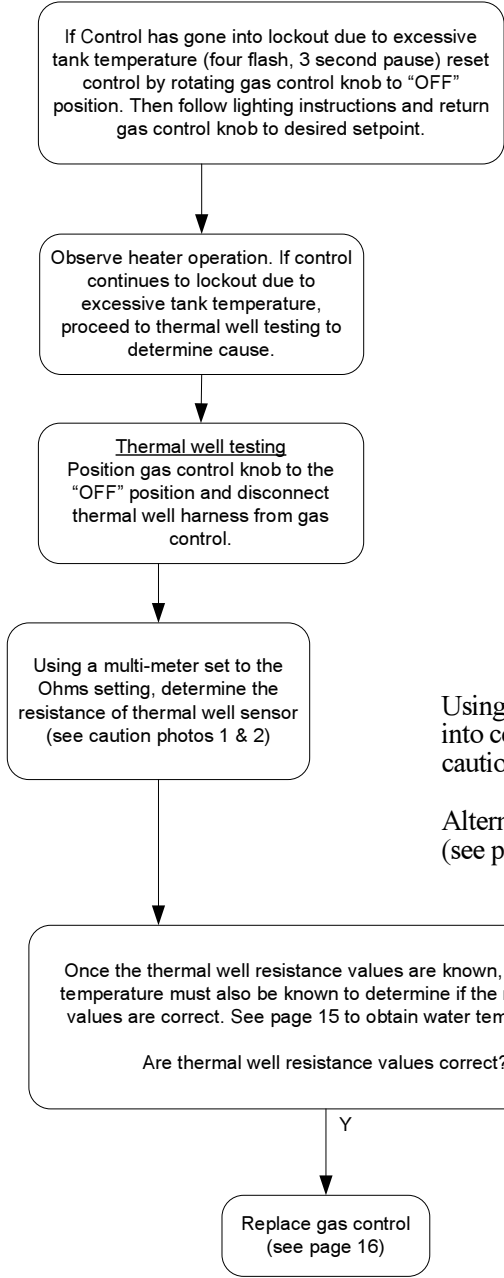

Disconnect thermal well wire harness

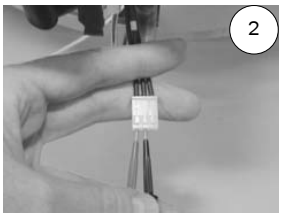
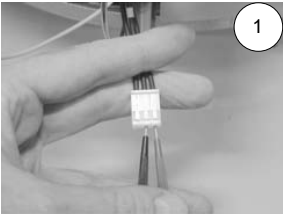
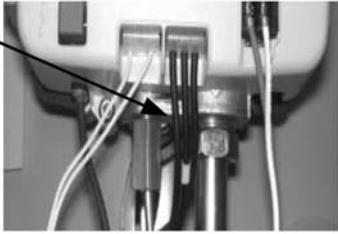

CAUTION
 DO NOT use standard multimeter probes for this test. Doing so will damage connector. Use special pin type electronic probes or small diameter wire pins inserted into connector.

Using a multi-meter set to the ohms setting, insert one meter probe (see caution) into center wire position of thermal well connector, insert the second probe (see caution) into either of the outside wire positions (see photo 1).

Alternate the probe on the outside position to the opposite outside wire position (see photo 2).

ECO-DEFENDER

Gas Control Replacement Thermal
Well and Chamber Door Sensor
Testing and Replacement

⚠ WARNING

Stored water may be **HOT** when performing the following steps in this procedure.
Take necessary precaution to prevent personal injury.

Determine Water Temperature Inside Tank

Note: It is important to understand once the resistance for the thermal well is determined from page 14, water flow through the heater should not occur. Prior to performing the steps below, turn off the cold water supply to the water heater. This will prevent cold water flow into the tank affecting the resistance value of thermal well.

- Step 1. Position gas control power switch to “OFF” position.
- Step 2. Draw approximately 4 gallons of water from drain valve into a container and discard. Draw an additional gallon and immediately measure water temperature using an accurate thermometer. It may be necessary to open a hot water faucet to allow heater to drain.
- Step 3. Using the chart below, determine correct resistance value for the water temperature from step 2.

Example: If temperature of water is 84°F, then the resistance through the sensor would be 8449 (see shaded area). NOTE: Sensor resistance increases as the temperature falls.

Sensor Resistance at Various Temperatures

In Degrees F										
°F	0	1	2	3	4	5	6	7	8	9
40	26109	25400	24712	24045	23399	22771	22163	21573	21000	20445
50	19906	19383	18876	18383	17905	17440	16990	16553	16128	15715
60	15314	14925	14548	14180	13823	13477	13140	12812	12494	12185
70	11884	11592	11308	11032	10763	10502	10248	1000	9760	9526
80	9299	9078	8862	8653	8449	8250	8057	7869	7685	7507
90	7333	7165	7000	6839	6683	6531	6383	6238	6098	5961
100	5827	5697	5570	5446	5326	5208	5094	4982	4873	4767
110	4663	4562	4464	4368	4274	4183	4094	4006	3922	3839
120	3758	3679	3602	3527	3453	3382	3312	3244	3177	3112
130	3048	2986	2925	2866	2808	2752	2697	2643	2590	2538
140	2488	2439	2391	2344	2298	2253	2209	2166	2124	2083
150	2043	2004	1966	1928	1891	1856	1820	1786	1753	1720
160	1688	1656	1625	1595	1566	1537	1509	1481	1454	1427
170	1402	1376	1351	1327	1303	1280	1257	1235	1213	1191
180	1170	1150	1129	1110	1090	1071	1953	1035	1017	999
190	982	965	949	933	917	901	886	871	857	842
200	828	814	801	788	775	762	749	737	725	713

ECO-DEFENDER

Gas Control & Thermal Well Removal From Water Heater

- Step 1. Turn the gas control knob to the "OFF" position.
- Step 2. Drain heater to a point below the gas control level.
- Step 3. Turn off gas supply to water heater and disconnect gas piping from gas control.
- Step 4. Disconnect wire harnesses and burner assembly from gas control.
- Step 5. Remove gas control & thermal well by rotating flats of Thermal Well counter clockwise (1-5/16" wrench).

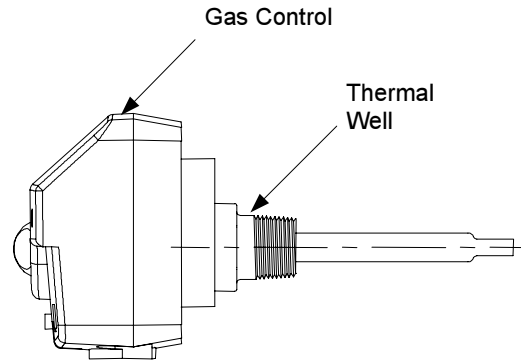

Gas Control Removal From Thermal Well

Follow the steps below allows removal gas control from thermal well without removing thermal well from tank.

- Step 1. Turn the gas control knob to the "OFF" position.
- Step 2. Turn off gas supply to water heater and disconnect gas piping from gas control.
- Step 3. Disconnect wire harnesses & burner assembly from gas control.
- Step 4. Using gas control service tool (239-45991-00) available from your BWC parts supplier, Insert tool into back of gas control (see photos below)

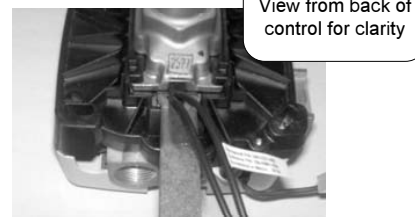
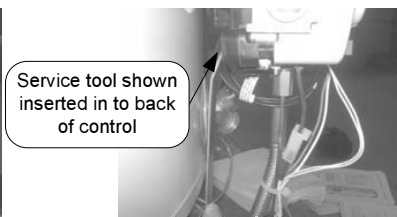
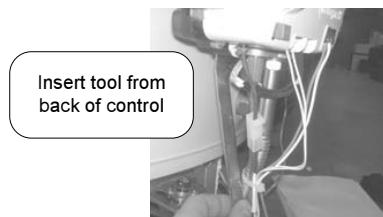

- Step 5. Pivot tool towards heater as far as possible (see photo below). Lift straight up on gas control. The control should move about 1/8". Hold control in position and remove tool. Lift straight up on control to remove completely from Thermal Well.



With service tool inserted, pivot tool back towards heater as far as possible. Lift straight up on control, control will move 1/8". Remove tool and continue to lift straight up on control to remove from Thermal Well.

ECO-DEFENDER

Gas Control Assembly to Thermal Well

- Step 1. Install threaded end of thermal well into tank. Be sure thermal well flange is positioned as shown in photo 3 for proper control alignment.
- Step 2. Route wire leads back into relief opening. (see photo 3).
- Step 3. Align slots located on thermal well flange with tabs located on back of gas control (see photos 3 & 4).
- Step 4. Carefully push control back onto thermal well flange as far as possible towards water heater. Slide control down to lock into position.
- Step 5. Install burner and connect pilot and feed line to gas control.

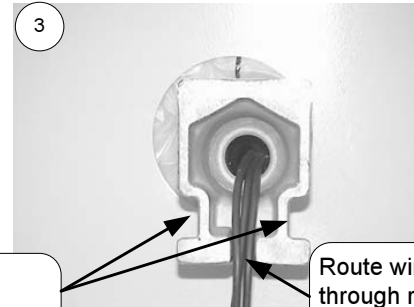

Thermal well flange slots

Route wires through relief opening

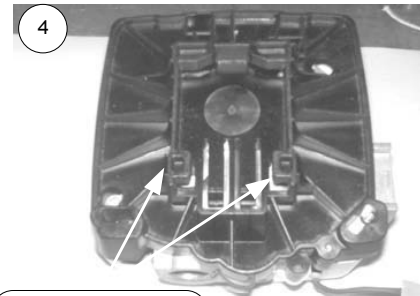

Gas control Tabs

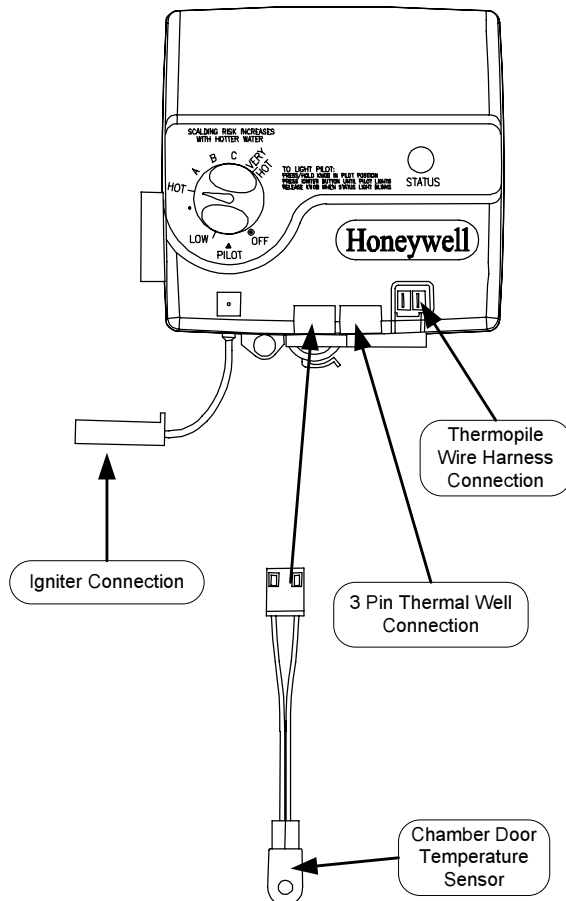

- Step 6. Reconnect wire harnesses and igniter wire to gas control per the illustration to the left.
- Step 7. Reconnect gas piping to gas control. Restore gas supply and check for gas leaks.
- Step 8. To resume operation, follow the instruction located on the lighting instruction label or the lighting instruction located in the installation and operation manual.

ECO-DEFENDER

SERVICE PROCEDURE ED-V

Gas Control Replacement Thermal Well and Chamber Door Sensor Testing and Replacement

CHAMBER SENSOR TESTING

- Step 1. Turn the gas control knob to the "OFF" position
- Step 2. Disconnect the chamber sensor wire harness from the gas valve.
- Step 3. Remove the chamber door temperature sensor from the right side inner door (Phillips screw driver).
- Step 4. Make sure that the ring terminal of the chamber door temperature sensor is not touching any surface. Using a multi-meter set to the ohms setting, insert one meter probe (see caution) into each of the wire positions (see photo 5).
- Step 5. Measure the ambient air temperature near the sensor. Compare the ambient temperature range to the expected resistance range on the chart below. Note that resistance increases as temperature decreases.

Gas Control Knob Shown In "OFF" Position

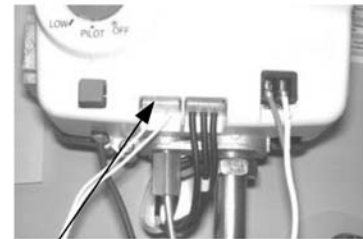

Chamber Door Temperature Sensor Wire Harness

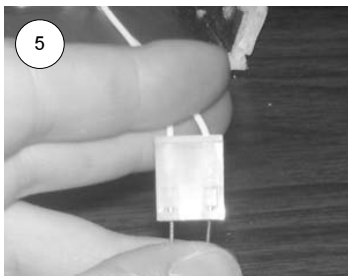

CAUTION

DO NOT use standard multimeter probes for this test. Doing so will damage connector. Use special pin type electronic probes or small diameter wire pins inserted into connector.

Sensor Resistance at Various Temperatures

Temperature Range (°F)	Resistance Range (kOhms)
41-50	279-175
50-59	219-139
59-68	173-112
68-77	137-90
77-86	110-72
86-104	89-59
104-113	73-48
113-122	60-39
122-131	49-32

- Step 6. Replace the chamber door temperature sensor if it is out of specification.
- Step 7. Secure the chamber door temperature sensor to the right side inner door using the screw from step 3.
- Step 8. Connect the chamber door temperature sensor wire harness to the gas valve.
- Step 9. To resume operation, follow the instruction located on the lighting instruction label or the lighting instruction located in the installation and operation manual.

ECO-DEFENDER

SERVICE PROCEDURE ED-VI

Burner Operation Inspection,
Cleaning and Replacement

MAIN BURNER: Inspection, Cleaning and Replacement

At periodic intervals (not more than 6 months) a visual inspection should be made of the main burner for proper operation and to insure no debris is accumulating.

Main burner should light smoothly from pilot and burn with a blue flame with a minimum of yellow tips. After 5 minutes of operation the burner screen will become radiant and the flame will soften and turn orange. If the burner screen does not become radiant after 5 minutes of operation it must be cleaned (see burner cleaning procedure below).

Main burner must be free from any debris accumulation that may effect burner operation (see burner cleaning procedure below).

⚠ DANGER

Under no circumstances shall flammable materials be used or stored in the vicinity of the water heater. With the inner door removed the Bradford White Defender Safety System will be inactivated. If flammable vapors are present, a fire or explosion may result causing property damage, personal injury or death.

⚠ WARNING

Inner door and burner components may be HOT when performing this operation. Take necessary precaution to prevent personal injury.

BURNER CLEANING

- Step 1. Remove burner and inner door assembly per SERVICE PROCEDURE ED-I, steps 1 through 3g.
- Step 2. Remove manifold mount from burner inner door by removing (2) ¼" hex drive screws.
- Step 3. Thoroughly inspect burner screen and burner venturi and remove any loose debris accumulation. Inspect burner screen for any openings larger than the normal screen openings.
- Step 4. Use compressed air and/or a vacuum to remove any scale or other debris accumulation from the burner screen and venturi.

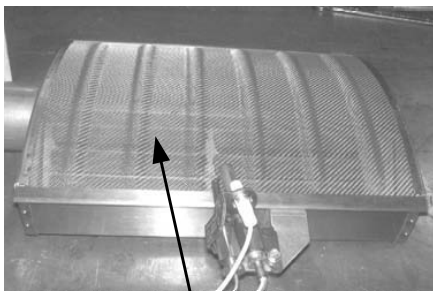

Burner Screen

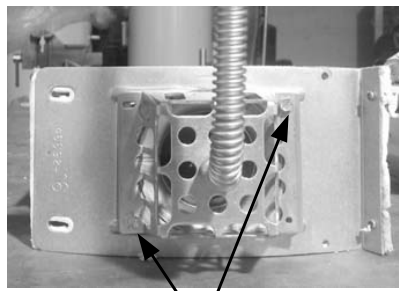

¼" Hex Drive Screws

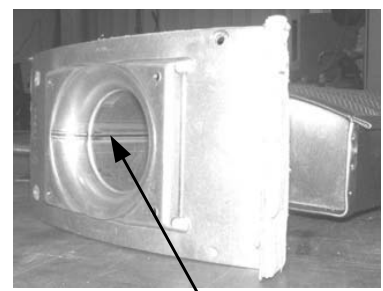

Burner Venturi

ECO-DEFENDER

SERVICE PROCEDURE ED-VI

Burner Operation Inspection, Cleaning and Replacement

BURNER CLEANING (Cont.)

- Step 5. Disconnect (unscrew) manifold mount from feed line. Use a stiff brush, compressed air and/or shop vacuum to remove any debris build up from the manifold mount.



- Step 6. Remove main burner orifice from feed line (3/8" wrench). Inspect and clean if necessary



- Step 7. Remove pilot assembly, refer to SERVICE PROCEDURE ED-III for cleaning and inspection.
- Step 8. Reassemble burner.
- Step 9. Inspect combustion chamber area of heater prior to reinstallation of burner assembly. If cleaning is required, refer to SERVICE PROCEDURE ED-VIII
- Step 10. Reinstall burner and inner door per SERVICE PROCEDURE ED-I, steps 4 through 16.
- Step 11. To resume operation, follow the instructions located on the lighting instruction label or the lighting instructions located in the installation and operation manual.

ECO-DEFENDER

SERVICE PROCEDURE ED-VII

Resettable Thermal Switch Testing and Replacement

RESETTABLE THERMAL SWITCH CONTINUITY TESTING

- Step 1. Remove outer jacket door.
- Step 2. Disconnect white wire leads from resettable thermal switch.
- Step 3. Using a multimeter capable of measuring continuity (Ohms), place one probe of meter on one of the brass connection tabs of the resettable thermal switch, and the remaining probe on the other connection tab.
- Step 4. If continuity is indicated, the switch is closed, allowing millivolt current to pass.
- Step 5. If continuity is not indicated, the switch is open, possibly due to an over heating condition. The switch is designed to open at predetermined temperatures. An open switch can be reset by depressing the red colored button located at the center of the switch. The overheating condition must be determined prior to putting the water heater back in service.

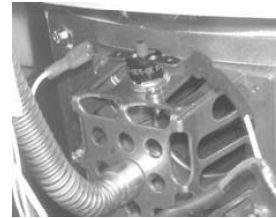

<u>PROBABLE CAUSE FOR RESETTABLE THERMAL SWITCH ACTIVATION</u>	
<u>PROBABLE CAUSE</u>	<u>CORRECTIVE ACTION</u>
Burner Failure	1. Inspect burner per SERVICE PROCEDURE ED-VI 2. Replace burner per SERVICE PROCEDURE ED-VI
Weak switch or switch out of calibration.	1. Replace resettable thermal switch
Flammable vapor incident	1. Replace water heater.

ECO-DEFENDER

SERVICE PROCEDURE ED-VII

Resettable Thermal Switch Testing and Replacement

RESETTABLE THERMAL SWITCH REPLACEMENT

Step 1. Rotate gas control knob to the “OFF” position.

Gas Control Knob Shown In
“OFF” Position

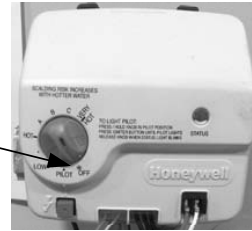

Step 2. Remove outer jacket door.

Step 3. Disconnect wire leads from resettable thermal switch.

Step 4. Remove (2) ¼” hex drive screws from the manifold mount.

Step 5. Bend the flexible feed line so the resettable thermal switch is easily accessible.

Step 6. Remove resettable thermal switch from manifold mount (Phillips screw driver).

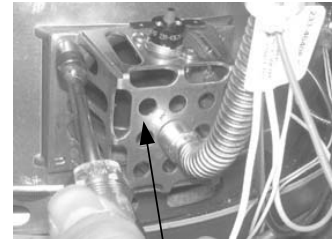

Manifold Mount



Step 7. Place new resettable thermal switch in place. Be sure contact surface of resettable thermal switch and manifold mount are free of any debris. Secure resettable thermal switch into place using screws from step 6. **DO NOT OVER TIGHTEN SCREWS.**

Step 8. Bend flexible feed line back in place and secure the manifold mount using the screws from step 4.

Step 9. Reconnect wire leads from gas valve and thermopile to resettable thermal switch.

Note: Wire termination are interchangeable with either resettable thermal switch connection.

Step 10. Replace outer jacket door.

Step 11. To resume operation follow the instructions located on the lighting instruction label or the lighting instruction located in the installation and operation manual.

ECO-DEFENDER

SERVICE PROCEDURE ED-VIII

ScreenLok Flame Arrestor Cleaning

ScreenLok Flame Arrestor Cleaning

Step 1. Rotate gas control knob to the “OFF” position.

Gas Control Knob Shown In
“OFF” Position



Step 2. Remove outer jacket door.

Step 3. Remove burner and inner door per SERVICE PROCEDURE ED-I, step 3a through 3g.

Step 4. Clean ScreenLok Flame Arrestor using stiff brush, compressed air and/or shop vacuum to remove any scale or other debris accumulation. It is only necessary to clean the ScreenLok Flame Arrestor in the areas that are not covered by the secondary air restrictor plate. Using a soft brush, clear jacket openings of any dirt, dust, restrictions or other obstructions.

Step 5. Remove any debris from burner assembly per SERVICE PROCEDURE ED-VI and reinstall burner assembly into combustion chamber.

Step 8. Reinstall burner and inner door per SERVICE PROCEDURE ED-I, steps 4 through 16.

Step 9. To resume operation follow the instructions located on the lighting instruction label or the lighting instruction located in the installation and operation manual.

ECO-DEFENDER

SERVICE PROCEDURE ED-IX

Dip Tube and Anode
Inspection and Replacement

DIP TUBE INSPECTION AND REPLACEMENT

WARNING

Water Heater components and stored water may be HOT when performing the following steps in this procedure. Take necessary precaution to prevent personal injury.

Step 1. Rotate gas control knob to the “OFF” position.

Gas Control Knob Shown In
“OFF” Position



Step 2. Turn off cold water supply to water heater. Connect hose to drain spigot of water heater and route to an open drain. Open a nearby hot water faucet to vent heater for draining. Open drain spigot of water heater and allow water heater to drain to a point below the inlet connection nipple.

Step 3. Disconnect inlet nipple from plumbing system.

Step 4. With an appropriate wrench, remove inlet nipple/dip tube from the water heater. Use caution not to damage pipe threads.

Step 5. Visually Inspect inlet nipple/dip tube. Inlet nipple/dip tube should be free of cracks and any blockage. Hydro-jets located near the bottom of the dip tube should be open and free of any blockage. Anti-siphon hole located approximately 6" from the bottom of nipple, should be free of any blockage.

Any damage such as cracks, restriction due to deformation or unintentional holes are not field repairable and the inlet nipple/dip tube must be replaced.

Step 6. Upon completion of inspection or subsequent replacement, reinstall inlet nipple/dip tube into heater. Connect nipple to plumbing system, resume water supply and refill water heater with water.

Step 7. To resume operation follow the instructions located on the lighting instruction label or the lighting instructions located in the installation and operation manual.

ECO-DEFENDER

SERVICE PROCEDURE ED-IX

Dip Tube and Anode
Inspection and Replacement

ANODE INSPECTION AND REPLACEMENT

WARNING

Heater components and stored water may be **HOT** when performing the following steps in this procedure. Take necessary precaution to prevent personal injury.

Step 1. Turn off water supply to water heater. Rotate gas control knob to the “OFF” position.

Gas Control Knob Shown In
“OFF” Position



- Step 2. Turn off cold water supply to heater. Connect hose to drain spigot of water heater and route to an open drain. Open a nearby hot water faucet to vent heater for draining. Open drain spigot of hot water heater and allow heater to drain to a point below the outlet connection nipple.
- Step 3. Disconnect outlet nipple from plumbing system.
- Step 4. With an appropriate wrench, remove outlet nipple/anode from the water heater. Use caution not to damage pipe threads.
- Step 5. Visually Inspect outlet nipple/anode. Outlet nipple/anode should show signs of depletion, this is normal. If depletion is $\frac{1}{2}$ of the original anode diameter (approximately $\frac{3}{4}$ ” diameter), replacement is recommended. If any of the steel core of the anode is exposed, replacement is recommended.
- Step 6. Upon completion of inspection or subsequent replacement, reinstall outlet nipple/anode into heater. Connect nipple to plumbing system, resume water supply and refill heater with water.
- Step 7. To resume operation, follow the instructions located on the lighting instruction label or the lighting instructions located in the installation and operation manual.

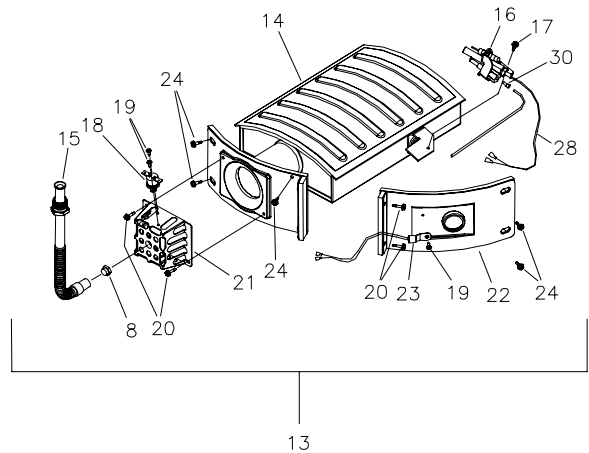
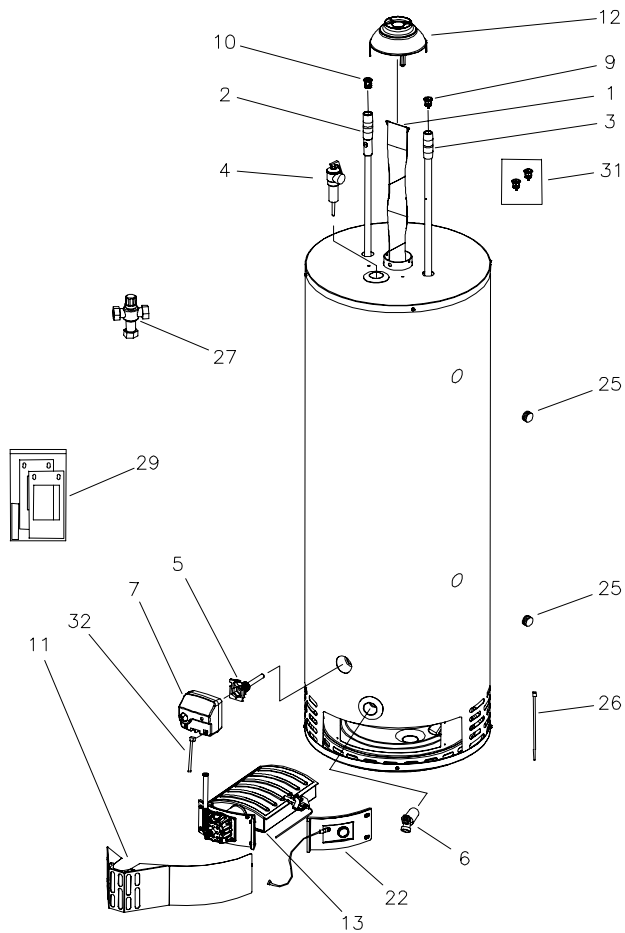

- 1 Flue Baffle
- 2 Hot Water Outlet/Anode
- 3 Cold Water Inlet Tube
- 4 T&P Relief Valve
- 5 Thermal Well
- 6 Brass Drain Valve
- 7 Gas Valve
- 8 Main Burner Orifice
- 9 Heat Trap Inlet
- 10 Heat Trap Outlet
- 11 Outer Door
- 12 Draft Diverter
- 13 Complete Burner Assembly
- 14 RN Burner and Door
- 15 Flexible Gas Feed Line
- 16 Pilot Assembly

- 17 Screw #8-18 x 1/2 Hex Washer Head
- 18 Resettable Thermal Switch
- 19 Screw #6-20 x 3/8 PHCR
- 20 Screw #8-18 x 3/4 Hex Washer Head
- 21 Manifold Mount
- 22 Complete Right Side Inner Door
- 23 Resistance Temperature Detector (RTD)
- 24 Screw #10-12 x 3/4 Hex Washer Head
- 25 3/4 NPT Tank Plug (XR Models)
- 26 Wire Tie
- 27 ASSE Approved Mixing Valve (Optional)
- 28 Thermopile
- 29 Inner Door Gasket Set
- 30 Pilot Orifice
- 31 Kit-Heat Trap Insert
- 32 Intermediate Gas Valve Harness



BRADFORD WHITE®
C O R P O R A T I O N

Ambler, PA

For U.S. and Canada field service,
contact your professional installer or
local Bradford White sales representative.

Sales/800-523-2931
Fax/215-641-1670
Parts Fax/215-641-2108

Technical Support/800-334-3393
Fax/269-795-1089

Warranty/800-531-2111
Fax/269-795-1089

International:
Telephone/215-641-9400
Telefax/215-641-9750



BRADFORD WHITE-CANADA® INC.

Mississauga, ON

Sales/866-690-0961
905-238-0100

Fax/905-238-0105

Technical Support/800-334-3393

Email

parts@bradfordwhite.com
techserv@bradfordwhite.com

www.bradfordwhite.com