

User's Manual for

Copper Brute™ II

includes **LOW TEMP Copper Brute II**

Hydronic Boiler
Model BWCH

Water Heater
Model BWCV

Sizes 500-2000

U.S. Reg. 2,765,423

FOR YOUR SAFETY: This product must be installed and serviced by a professional service technician, qualified in hot water boiler installation and maintenance. Improper installation and/or operation could create carbon monoxide gas in flue gases which could cause serious injury, property damage, or death. Improper installation and/or operation will void the warranty. For indoor installations, as an additional measure of safety, Laars strongly recommends installation of suitable Carbon Monoxide detectors in the vicinity of this appliance and in any adjacent occupied spaces.

⚠ WARNING

If the information in this manual is not followed exactly, a fire or explosion may result causing property damage, personal injury or loss of life.

Do not store or use gasoline or other flammable vapors and liquids in the vicinity of this or any other appliance.

WHAT TO DO IF YOU SMELL GAS

- Do not try to light any appliance.
- Do not touch any electrical switch; do not use any phone in your building.
- Immediately call your gas supplier from a nearby phone. Follow the gas supplier's instructions.
- If you cannot reach your gas supplier, call the fire department.

Installation and service must be performed by a qualified installer, service agency, or gas supplier.

⚠ AVERTISSEMENT

Assurez-vous de bien suivre les instructions données dans cette notice pour réduire au minimum le risque d'incendie ou d'explosion ou pour éviter tout dommage matériel, toute blessure ou la mort.

Ne pas entreposer ni utiliser d'essence ni d'autres vapeurs ou liquides inflammables dans le voisinage de cet appareil ou de tout autre appareil.

QUE FAIRE SI VOUS SENTEZ UNE ODEUR DE GAZ:

- Ne pas tenter d'allumer d'appareils.
- Ne touchez à aucun interrupteur. Ne pas vous servir des téléphones dans le bâtiment où vous vous trouvez.
- Appelez immédiatement votre fournisseur de gaz depuis un voisin. Suivez les instructions du fournisseur.
- Si vous ne pouvez rejoindre le fournisseur de gaz, appelez le service des incendies.

L'installation et l'entretien doivent être assurés par un installateur ou un service d'entretien qualifié ou par le fournisseur de gaz.

TABLE OF CONTENTS

SECTION 1 Caring For Your Copper Brute II	3	SECTION 3 Electrical Connections	11
1.A General Care	3	3.A Installation Warnings	11
1.B Annual Inspection of Flue and Vents	3	3.B Line Voltage Connections	11
1.C In the Event of a Power Failure	3	3.B.1 Main Power	11
1.D Full Service Every Three (3) Years	3	3.B.2 Pump Power	11
SECTION 2 Touchscreen and System Ops	4	3.B.3 Boiler/Heater Pump	11
2.A The Home Screen	4	3.B.4 Auxiliary Power Output	11
2.A.1 Home Screen Status Window	4	3.C Low Voltage Connections	12
2.A.2 Home Screen Active Icons	5	3.C.1 Field Wiring - Inputs	12
2.B Lock/Unlock Display Screen	6	3.C.1.a Safety Interlocks	12
2.C Keypad Operations	7	3.C.1.b BWCH/BWCV Heat Demands	12
2.D Quick Start	8	3.C.1.c Field Inputs (Open/Closed)	12
2.D.1 CH /DHW	8	3.C.1.d Temperature Sensors	12
2.D.1.a CH1 /DHW1	8	3.C.2 Field Wiring - Outputs	13
2.D.1.b CH2/DHW2	8	3.C.2.a Dry Contacts	13
2.D.2 DHW/DHW3	9	3.C.1.e Analog (BAS) Input	13
2.D.3 Outdoor Reset	9	3.C.2.b Cascade RS485	14
2.D.4 Warm Weather Shut Down	9	3.C.2.c BAS RS485	14
2.D.5 Anti-Short Cycle	10	3.C.2.d 24VAC	14
2.D.6 Time & Date	10	3.D Cascade Wiring Connections	15
		SECTION 4 Burner Set Up	15
		4.A Set Up for 0 to 2500 Feet Altitude	15
		4.B Set Up for High Altitude	
		(>2500 Feet)	16

SECTION 1 Caring For Your Copper Brute II

Your Copper Brute II will require very little Maintenance. However, as with any fine appliance there are certain steps that should be taken to ensure continuing optimum performance.

1.A General Care

Keep the area around the Copper Brute II clean and free from combustible materials, gasoline and other flammable liquids and vapors.

The Copper Brute II must be completely isolated and protected from any source of corrosive chemical fumes such as trichlorethylene, perchlorethylene, chlorine, etc.

Keep grille openings on the boiler free for proper ventilation of interior components.

Do not obstruct or block a free flow of air to the boiler to ensure proper ventilation.

If desired, clean the jacket surfaces with a damp cloth and mild detergent. Do not use flammable cleaning materials.

If sidewall vented, keep the vent terminal clear of obstructions — do not pile snow against the vent terminal. Clean the air filter(s) often, and then develop an appropriate maintenance schedule.

1.B Annual Inspection of Flue and Vents

Visually inspect the vent pipe once a year. Should any deterioration exist, have the affected parts replaced by a qualified service person.

1.C In the Event of a Power Failure

The Copper Brute II can not be operated during an electrical power outage. If there is an extended power outage with danger from freezing, then the Copper Brute II (and all other water systems) should be drained completely. When draining the boiler, turn off main electrical disconnect switch. When placing back in service, refer to start-up instructions in the Installation and Operation Manual for filling and purging. Draining and filling shall only be done by a qualified service person.

1.D Full Service Every Three (3) Years

In addition to the annual visual inspections, a qualified service agency should conduct a detailed inspection of all flue product carrying areas of the boiler and its venting system.

WARNING

Do not use this boiler if any part has been under water. Immediately call a qualified service technician to inspect the boiler and to replace any part of the control system and any gas control which has been under water.

WARNING

Should overheating occur or the gas supply fail to shut off, do not turn off or disconnect the electrical supply to the pump. Instead, shut off the gas supply at a location external to the boiler.

FOR SERVICE

Contact your installing contractor, gas utility, Bradford White dealer, or call Bradford White for the nearest authorized representative in your area.

WARNING

Carbon Monoxide Hazard

This product burns gas to produce heat. The appliance must be properly installed, operated, and maintained to avoid exposure to appreciable levels of carbon monoxide and the installer is required to confirm that at least one carbon monoxide alarm is installed in the living space before the appliance is put into operation.

It is important for carbon monoxide alarms to be installed, maintained, and replaced following the alarm manufacturer's instructions and applicable local codes.

AVERTISSEMENT

Danger lié au monoxyde de carbone

Ce produit brûle des gaz pour produire de la chaleur. L'appareil requiert une installation, un fonctionnement et une maintenance adéquates afin d'éviter l'exposition à des niveaux appréciables de monoxyde de carbone; l'installateur est requis de confirmer qu'au moins une alarme de détection de monoxyde de carbone est installée dans l'espace de vie avant que l'appareil ne soit mis en service.

Il importe que les alarmes de détection de monoxyde de carbone soient installées, maintenues et remplacées selon les directives du manufacturier et les codes locaux applicables.

SECTION 2 Touchscreen and System Operations

2.A The Home Screen

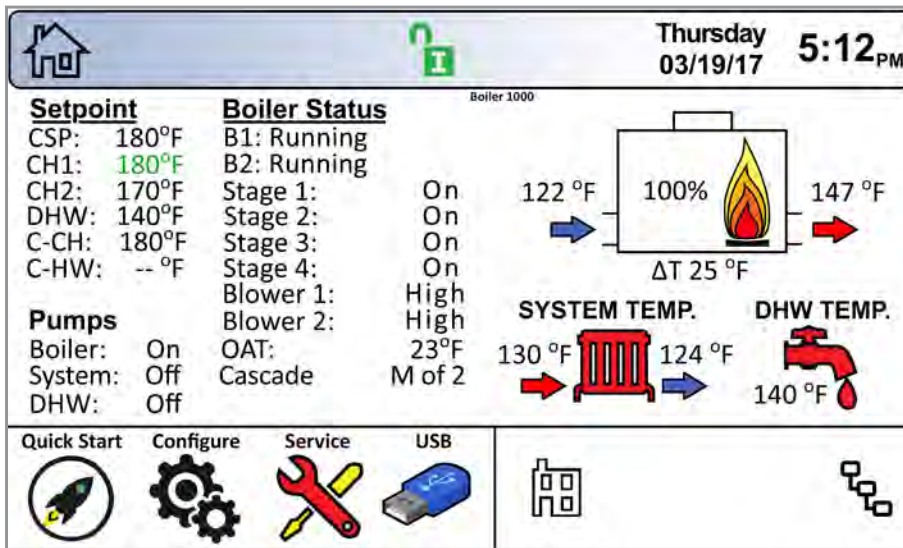

Figure 1. The Home Screen

Model	Stages
Low Temp	On/Off
500 - 750	2
1000	3
1250 - 2000	4

Table 1. Stages per Model

2.A.1 Home Screen Status Window

The central area of the home screen displays the current status information for the unit.

Heat Demand Setpoints.

Pump Status.

Boiler Status (Boiler Bank).

System Temp.

and DHW Temp (if installed)

Heat Demand Setpoints.

NOTE: The heat demand set point will turn green in color when active

Inlet & Outlet Temperature.

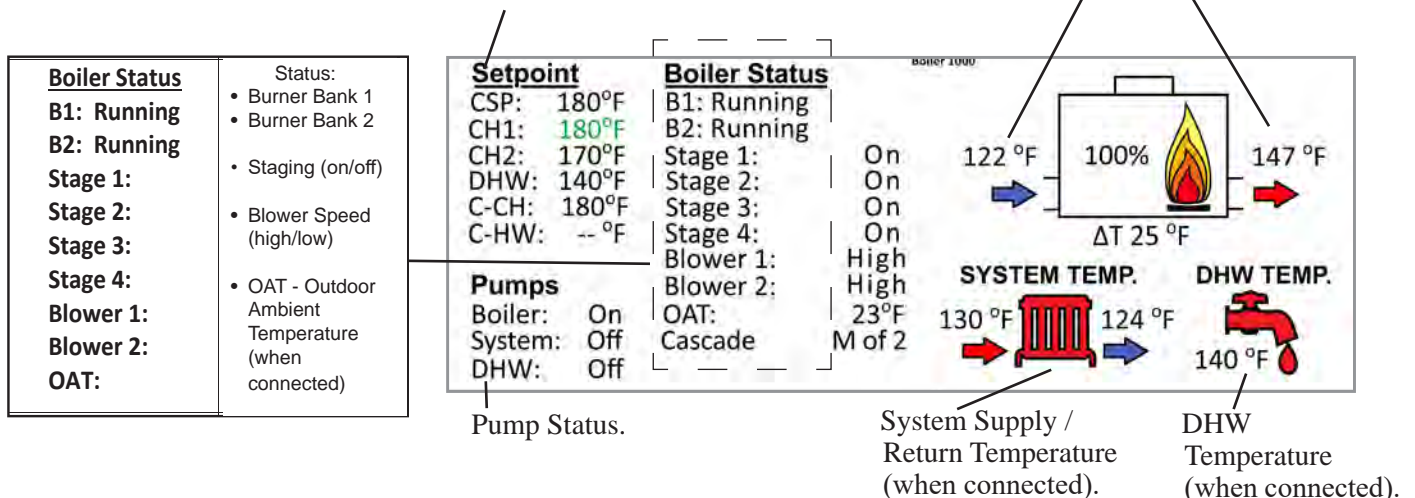

Figure 2. The Status Display Area, defined.

2.A.2 Home Screen Active Icons









Name	Icon	Description
<i>Security</i>		Displays the current lock status. Touch the lock icon to lock or unlock the Touchscreen Display.
<i>Quick Start</i>		Provides quick touch access to the most commonly used parameters for easy installation.
<i>Configure</i>		Will take you to ALL of your configurations and parameters for a detailed setup of the unit. This is the largest group of menu screens.
<i>Service</i>		Allows the service technician to access the basic diagnostic and troubleshooting information.
<i>Messages</i>	 	Will show an 'Exclamation' when there is a message. Clicking onto the Message icon will take you to the message itself. The USB functionality will show the USB Icon at this location, if being used.
<i>Active Demands</i>		Will show icons that indicate the active parameters that are currently in demand.
<i>Navigation Bar</i>		The Navigation Bar is the constant indicator of where you are as you navigate into and out of the touchscreens. See Screen 2 on page 7 ERROR Codes also show in the <i>Navigation Bar</i> when there is one of several unit errors or shut-downs that have occurred.
<i>Date & Time</i>	Thursday 03/19/17 5:12 PM	For Display Only. To change date and time, go to the Configuration menu.

Table 2. The Active Icons on the Home Screen, and what they do.

2.B Lock / Unlock Display Screen



Password Protection:

To change parameters, a password is required. The control system includes three levels of password protection. Touch the 'Current Lock Status' Icon.

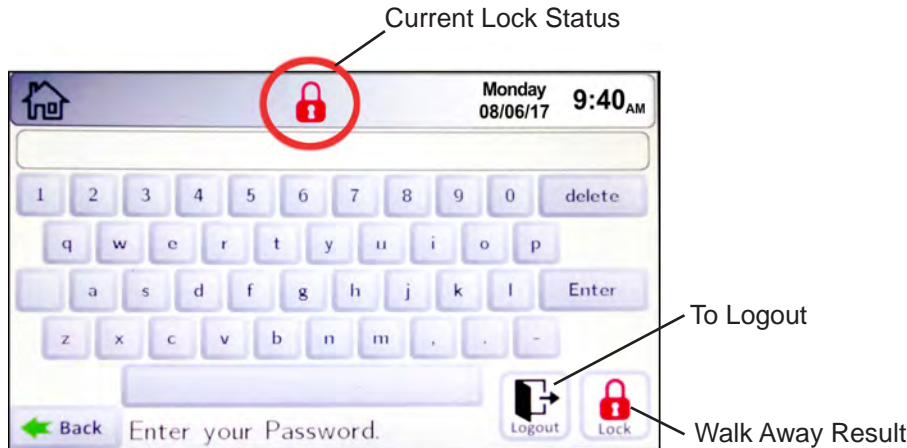

Screen 1. Sign in Screen

-USER Password: Non-critical adjustments and functions. **The user password is lhs.** When unlocked in the User mode, the icon will change to-



-INSTALLER Password: Setup and parameter changes made during the initial setup and commissioning. **The installer password is 17.** When unlocked in the Installer mode, the icon will change to-



-OEM Password: Setup and parameter changes available only to the factory.

Walk-Away Result. The unit will either Lock or stay Un-locked if you walk away. What it will do is displayed in the bottom right corner. The default delay time to lock is 5 minutes of inactivity.

This time duration can be adjusted in Service -> Screen -> Auto Lock Timeout. And it can also be set up to never Lock.



If the Installer is done and wants to lock the display immediately, tap the Logout Icon to get out of Installer or User Mode.



2.C Keypad Operations

As you navigate in, you will find that all screens have either a numeric keypad to enter in your customizable parameters OR selection buttons to choose the device of your configuration.

NOTE: You can always tell exactly where you have navigated to by looking at the icons in the *Navigation Bar*.

In this example you are in

Home/Configure/Central Heat/Central Heat One

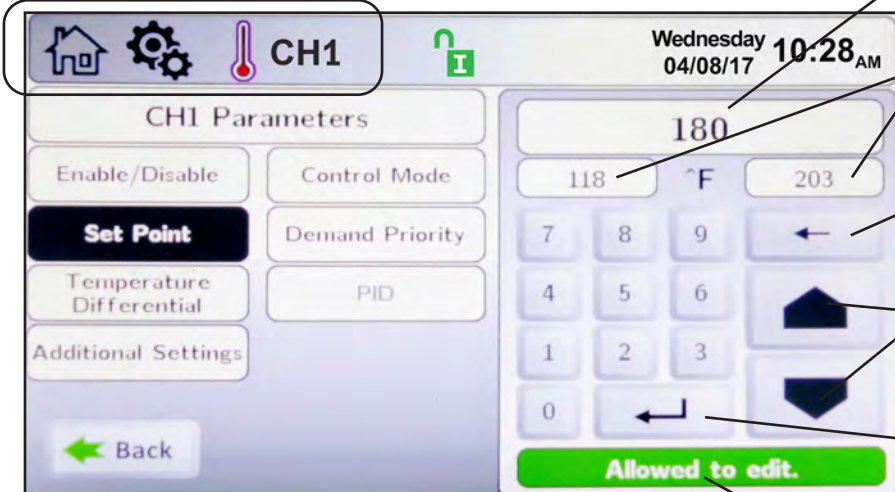

Shows the current setting of the Parameter.

These windows will reflect the allowable ranges that the setting can be adjusted to.

To delete the current setting before entering in the new value.

“Up and Down” arrows are used to increment the setting accordingly.

The “Enter” button is used to accept the new value that was just entered.

Screen 2. A typical numeric keypad entry screen.

This is the indicator that will be shown when the correct password has been entered to allow the setting to change.

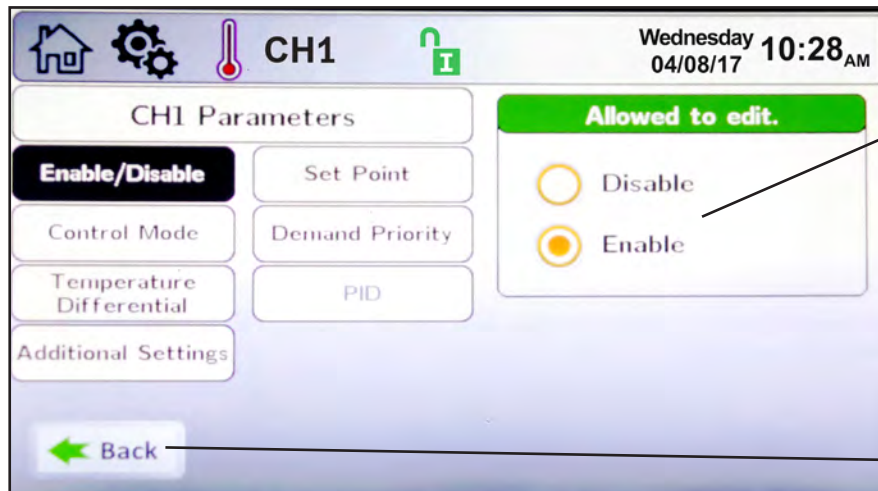

The highlighted button (orange) shows which one is selected. Some screens may only allow you to set one or the other, while some other screens (example: pump selection) will allow you to select any or all of the options.

The “Back” button jumps to the previous screen.

Screen 3. A Typical selection screen.

2.D Quick Start

To navigate to the Quick Start Screen, touch the Quick Start Icon in the lower left-hand portion of the Home Screen.

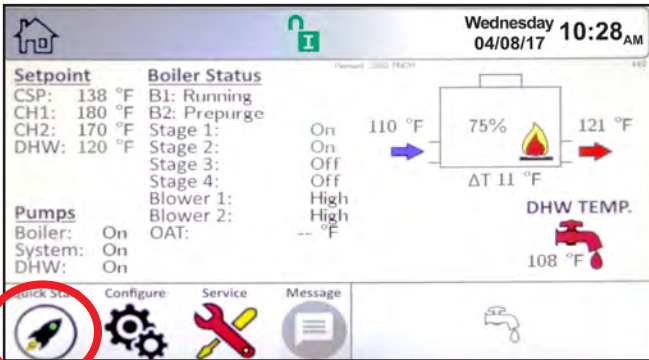

Screen 4. Home Screen

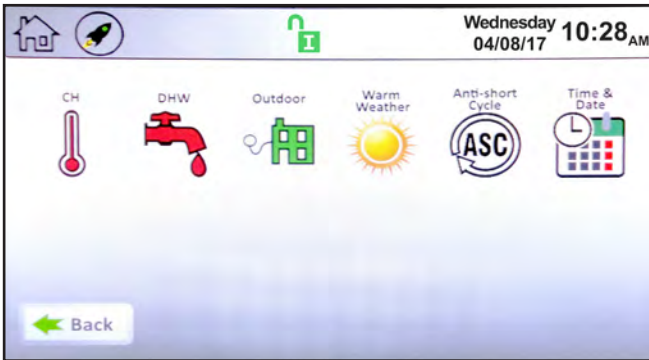

Screen 5. Quick Start Screen

CH is Central Heat	DHW is Domestic Hot Water
--------------------	---------------------------

2.D.1 CH /DHW

On the Quick Start Screen, touch the CH/DHW thermometer icon to navigate to the CH Selection Screen

There are two identical heat demands, CH1/DHW1 and CH2/DHW2, each with independent control algorithms and independent inputs on the input terminal strip.

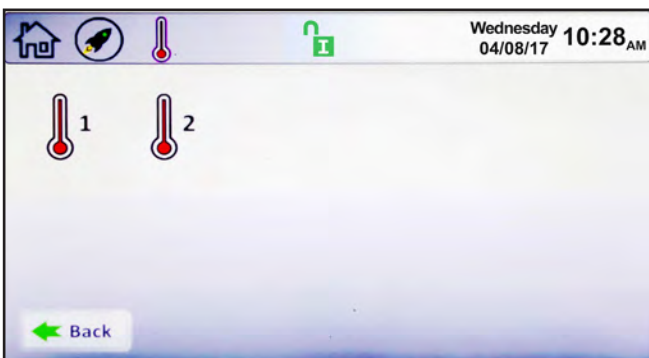

Screen 6. CH/DHW Quick Start Selection Screen

Touching CH1/DHW1 navigates to the CH1/DHW1 Quick Start Screen

2.D.1.a CH1 /DHW1

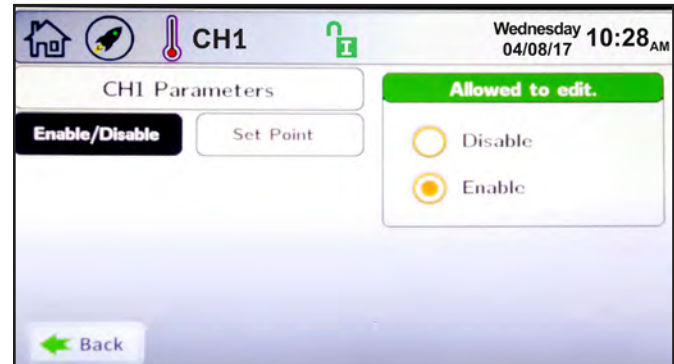

Screen 7. CH1/DHW1 Quick Start Screen

NOTE: CH1 applies to hydronic units (BWCH), while DHW1 applies to volume water units (BWCV).

- **Enable/Disable** – This allows CH1/DHW1 to be enabled/disabled. The default setting is Enabled.
- **Set Point** – This is the temperature that this heat demand will control to.

2.D.1.b CH2/DHW2

To navigate to the CH2/DHW2 Quick Start Screen, touch the CH2 Icon on the CH/DHW Quick Start Selection Screen.

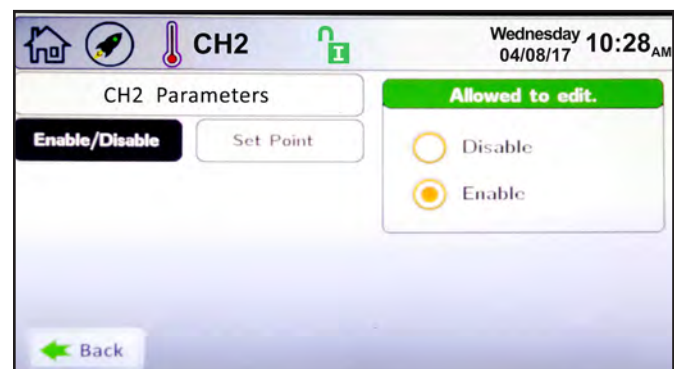

Screen 8. CH2/DHW2 Quick Start Screen

NOTE: CH2 applies to hydronic units (BWCH), while DHW2 applies to volume water units (BWCV).

2.D.2 DHW/DHW3

To navigate to the DHW/DHW3 Quick Start Screen, touch the DHW faucet icon on the Quick Start Screen.

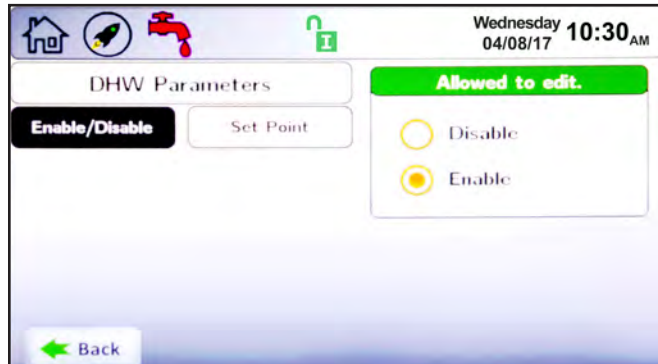

Screen 9. DHW/DHW3 Quick Start Screen

The DHW/DHW3 Quick Start Screen allows adjustment of the following parameter:

- **Enable/Disable** – This allows DHW/DHW3 to be enabled/disabled. The default setting is Enabled.
- **Set Point** – This is the temperature that this heat demand will control to.

NOTE: A DHW/DHW3 heat demand can be initiated by an aquastat or sensor, see Sections 5.3.1.2 and 5.3.1.4 respectively.

2.D.3 Outdoor Reset

To navigate to the Outdoor Quick Start Screen, touch the Outdoor Icon on the Quick Start Screen.

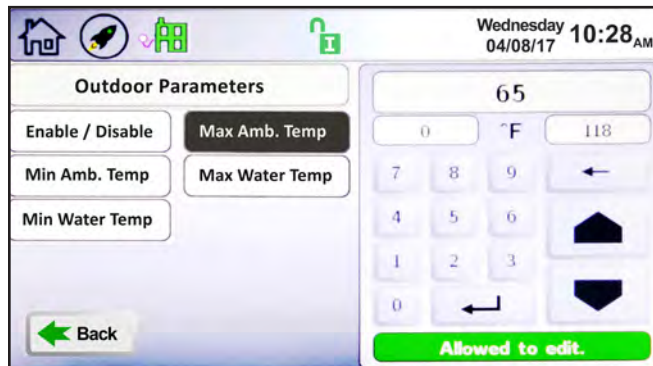

Screen 10. Outdoor Quick Start Screen

The Outdoor Quick Start Screen allows the adjustment of the following parameters:

- **Enable/Disable** – This allows Outdoor Reset to be enabled/disabled. The default setting is Enabled.
- **Maximum Ambient Temperature** – The outdoor temperature at which the Copper Brute II will limit the boiler outlet temperature to the Minimum Water Temperature.
- **Minimum Ambient Temperature** – The outdoor temperature at which the Copper Brute II

will maximize the boiler outlet temperature to the Maximum Water Temperature.

NOTE: Outdoor functionality is applicable to hydronic units only, and is explained in Installation Manual (Doc 1392)

2.D.4 Warm Weather Shut Down

To navigate to the Warm Weather Quick Start Screen, touch the Warm Weather Icon on the Quick Start Screen.



Screen 11. Warm Weather Quick Start Screen

The Warm Weather Quick Start Screen allows adjustment of the following parameters:

- **Temp Min** – Upon an active warm weather shutdown condition, this is the temperature at which the Copper Brute II will reset the shutdown condition to satisfy a heat demand.
- **Temp Max** – This is the temperature at which the warm weather shutdown condition will occur.
- **Feature Options** – This parameter provides the ability to either disable warm weather shutdown or upon a warm weather condition, configure the Copper Brute II to shut down immediately or to shut down after the current heat demand is satisfied.

2.D.5 Anti-Short Cycle

To navigate to the Anti-Short Cycle Quick Start Screen, touch the Anti-Short Cycle Icon on the Quick Start Screen.

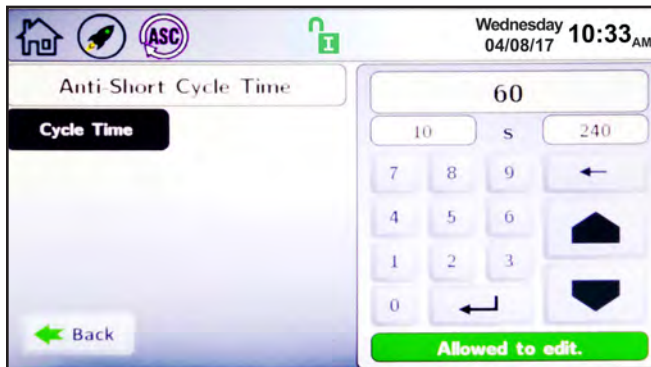

Screen 12. Anti-Short Cycle Quick Start Screen

The Anti-Short Cycle Quick Start Screen allows adjustment of the following parameter:

- **Cycle Time** – The amount of time after a heat demand is satisfied that the Copper Brute II will wait to satisfy the next active heat demand.

NOTE: Anti-Short Cycle Time does not apply to DHW/DHW3 heat demands.

2.D.6 Time & Date

To navigate to the Time & Date Quick Start Screen, touch the Time & Date Icon on the Quick Start Screen.

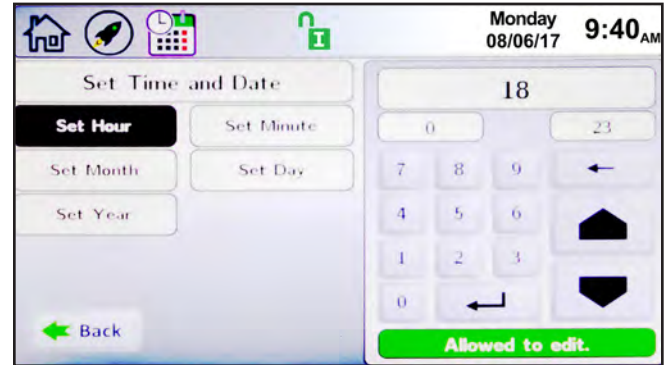

Screen 13. Time & Date Quick Start Screen

The Time & Date Quick Start Screen allows adjustment of the following parameters:

- **Hour** – The hour that will be displayed in the upper banner on each screen, and the time captured in the date/time stamp for lock-out conditions displayed on the history screen.
- **Minute** – The minute that will be displayed in the upper banner on each screen, and the time captured in the date/time stamp for lock-out conditions displayed on the history screen.
- **Month** – The month that will be displayed in the upper banner on each screen, and the date captured in the date/time stamp for lock-out conditions displayed on the history screen.
- **Day** – The day that will be displayed in the upper banner on each screen, and the date captured in the date/time stamp for lock-out conditions displayed on the history screen.
- **Year** – The month that will be displayed in the upper banner on each screen, and the date captured in the date/time stamp for lock-out conditions displayed on the history screen.

SECTION 3 Electrical Connections

3.A Installation Warnings

⚠ WARNING

This appliance must be electrically grounded in accordance with the requirements of the authority having jurisdiction or, in the absence of such requirements, with the latest edition of the National Electrical Code, ANSI/NFPA 70, in the U.S. and with the latest edition of CSA C22.1 Canadian Electrical Code, Part 1, in Canada. Do not rely on the gas or water piping to ground the metal parts of the boiler. Plastic pipe or dielectric unions may isolate the boiler electrically. Service and maintenance personnel, who work on or around the boiler may be standing on wet floors could be electrocuted by an ungrounded boiler. Electrocution can result in severe injury or death.

Single pole switches, including those of safety controls and protective devices, must not be wired in a grounded line.

All electrical connections are made at the power terminals, which are located at the rear of the appliance, or at the input/output terminal strips which are located on the right side of the appliance.

All internal electrical components have been prewired. No attempt should be made to connect electrical wires to any other location except the terminal blocks.

3.B Line Voltage Connections

Incoming power must be protected by the appropriate circuit breaker (fuse) and installed by a qualified electrician or authorized/qualified personnel. Recommended over current protection ratings are shown in Table 3.

3.B.1 Main Power

All non-pump mounted Copper Brute IIs require a single 120-volt supply. Pump mounted Copper Brute II sizes 500-1500 also use a single 120-volt supply, and Copper Brute II sizes 1750-2000 require two separate 120-volt supplies.

Copper Brute II sizes 500-1500 main power (L1, N1, and Ground) shall be connected to the three wires supplied. This main power circuit is identified by three solid colored wires (10 AWG) – black (L1), white (N1), and green (Ground).

Copper Brute II sizes 1750-2000 main power (L1, N1, and Ground) is identified by three solid colored wires (10 AWG) – black (L1), white (N1), and green (Ground). The pump circuit is identified by three 12 AWG wires.

3.B.2 Pump Power

The pump circuit is identified by three 12 AWG wires: black with a white stripe (L2), white (N2), and green (Ground).

If desired, an installer can change the pump mounted single service units to use a separate circuit for the pump. Instructions to make this change are found in the Installation Manual (Doc 1392)

Over Current Recommendations (Amps)			
Size	Boiler Only		Pump Only
	Without Pump	With Pump	Pump
500	15	20	15
750	15	20	15
1000	20	25	15
1250	25	30	15
1500	25	30	15
1750	25	–	15
2000	25	–	20

Table 3. Circuit Protection

3.B.3 Boiler/Heater Pump

Conversion to a separate pump circuit requires bringing in a separate circuit for the pump and removing the three jumper wires within the internal wiring of the 120-volt portion of the Copper Brute II (see Figure 3). This action should only be performed by qualified personnel, with the power disconnected from the unit.

To rewire the pump circuit, bring in a separate 120-volt circuit (L2, N2, and Ground). Remove the jumper wires shown in Figure 3. Connect the incoming line voltage (L2) to the main power switch using a ¼" female insulated push on terminal. From the other side of the main power switch, connect to the main power terminal block, in the rear of the unit, using a ¼" female insulated push on terminal. This will be in the same position where the line voltage jumper terminated. Connect N2 and Ground to the main terminal block, in the rear of the unit, using ¼" female insulated push terminals. These connections will also be the same positions where the neutral and ground jumpers were terminated.

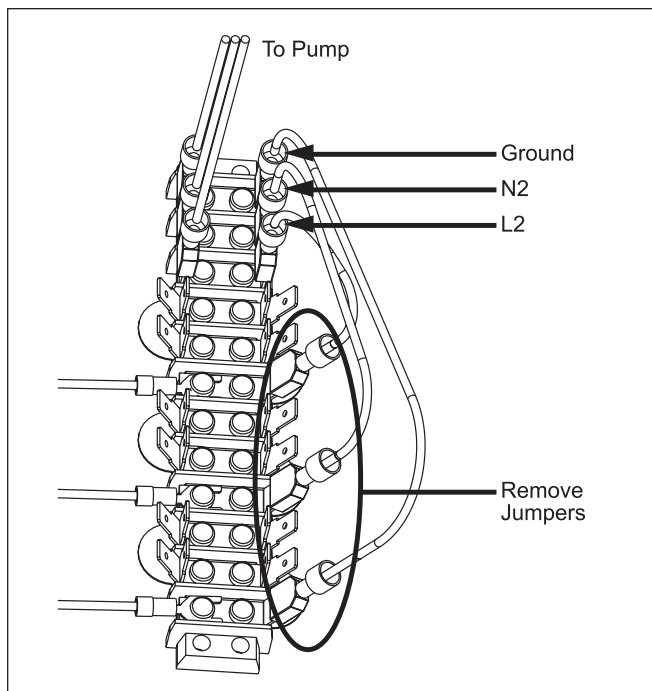

Figure 3. Removing Jumpers.

3.B.4 Auxiliary Power Output

The Auxiliary Power Output, if used, is controlled by Field Input 2. When Field Input 2 is closed, line voltage is supplied at terminal 7 and neutral on terminal 8 of the output terminal strip. This output is rated for 250VAC, 2.5A maximum.

3.C Low Voltage Connections

Route all wires through the knockouts on the right side of the Copper Brute II. Connect low voltage wiring to the input and output terminals shown in Figure 4. Connect all wiring as shown on the wiring diagram.

3.C.1 Field Wiring - Inputs

3.C.1.a Safety Interlocks

Field Interlock: If the Field Interlock is utilized, remove the jumper from the terminals 1 and 2 of the input terminal strip and wire the interlock to these terminals. Only dry contacts can be connected to the Field Interlock terminals.

NOTE: Safety chain voltage is 24VDC.

3.C.1.b BWCH/BWCV Heat Demands

CH1/DHW1: Connect the thermostat/aquastat or end switch (isolated contact only) wires to terminals 3 and 4 of the input terminal strip.

CH2/DHW2: Connect an additional thermostat/aquastat or end switch (isolated contact only) wires to terminals 7 and 8 of the input terminal strip.

DHW/DHW3: Connect the aquastat or end switch (isolated contact only) wires to terminals 5 and 6 of the input terminal strip. If preferred, a DHW tank sensor can be used in lieu of an aquastat to generate a heat demand, refer the Installation Manual (Doc 1392)

NOTE: The heat demand contacts must be dry contacts. The Copper Brute II controller heat demand voltage is 24VDC.

3.C.1.c Field Inputs (Open/Closed)

Field Input 1: Field Input 1, if used, is connected across terminals 9 and 10 of the input terminal strip. When connected, Field Input 1 controls the Auxiliary Dry Contact. If Field Input 1 is open, the Auxiliary Dry Contact is open. If Field Input 1 is closed, the Auxiliary Dry Contact is closed. Only dry contacts can be connected to Field Input 1.

Field Input 2: Field Input 2, if used, is connected across terminals 11 and 12 of the input terminal strip. When connected, Field Input 2 controls the Auxiliary Power Output. If Field Input 2 is open, the Auxiliary Power Output is off. If Field Input 2 is closed, the controller turns power on at the Auxiliary Power Output.

NOTE: The controller applies 24VDC to the Field Inputs to detect the status of the contacts.

3.C.1.d Temperature Sensors

System Supply: The system supply sensor, if used, is connected to terminals 14 and 15 of the input terminal strip. When connected, the controller automatically detects the presence of this sensor. If installed, the Copper Brute II controls the staging of the burners to maintain the system supply temperature to the heat demand set point. The system supply temperature is shown on the home screen above the red system input arrow, see Figure 1 on page 4. This sensor is supplied loose with the Copper Brute II and is installed in the piping or tank per the suggested piping diagrams.

System Return: The system return sensor, if used, is connected to terminals 16 and 17 of the input terminal strip. When connected, the controller automatically detects the presence of this sensor. There is no control logic associated with this sensor. When connected, this temperature is shown on the home screen above the blue system output arrow. This sensor is supplied loose with the Copper Brute II and is installed in the piping or tank per the suggested piping diagrams.

Domestic Hot Water (DHW): The DHW sensor, if used, is connected to terminals 18 and 19 on the input terminal strip. When connected, the Copper Brute II will use this sensor to perform the DHW thermostat

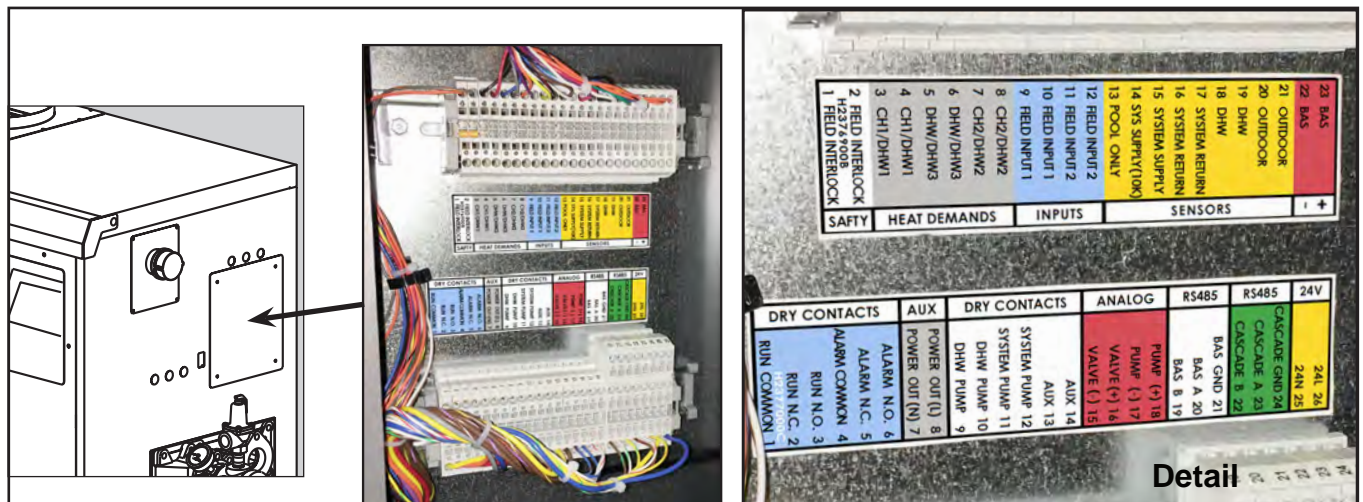

Figure 4. Input and Output Terminal Strips

function. The controller automatically detects the presence of this sensor and initiates a call for heat when the DHW temperature drops below the DHW set point by the value of the DHW On Hysteresis (DHW Set Point – DHW On Hysteresis = DHW heat demand). The DHW heat demand is satisfied when the DHW temperature rises above the DHW set point by the value of the DHW Off Hysteresis (DHW Set Point + DHW Off Hysteresis = DHW heat demand satisfied). When connected, this temperature is shown on the home screen below the faucet icon. This sensor is supplied loose with the Copper Brute II and is installed in the tank per the suggested piping diagrams.

Outdoor: The outdoor sensor, if used, is connected to terminals 20 and 21 of the input terminal strip. When connected, the controller automatically detects the presence of this sensor. If installed, options such as outdoor reset and warm weather shutdown can be enabled through the display.

3.C.1.e Analog (BAS) Input

Building Automation System (BAS): The BAS input, if used, is connected to terminals 22 and 23 of the input terminal strip. When making the connection, adhere to the polarity designations shown on the label or wiring diagram. The input signal can be 0 – 10 VDC or 4 – 20 mA, and can be used to control the firing rate or set point.. The factory default setting is for a 0 – 10VDC signal. Configure for 4 – 20 mA by placing a jumper on CN20 on the control board, see Figure 5.

3.C.2 Field Wiring - Outputs

3.C.2.a Dry Contacts

Run: These contacts, when used, are connected to

terminals 1 (common), 2 (normally closed), and 3 (normally open) of the output terminal strip. The controller closes the normally open set of contacts whenever the Copper Brute II is running. This is typically used by a BAS to verify the Copper Brute II is satisfying a heat demand. Contact ratings are 250VAC, 0.6A maximum.

Alarm: These contacts, when used, are connected to terminals 4 (common), 5 (normally closed), and 6 (normally open) of the output terminal strip. The controller closes the normally open set of contacts whenever the Copper Brute II is locked out or power is turned off. Contact ratings are 250VAC, 0.6A maximum.

DHW Pump: When connecting a domestic hot water (DHW) pump, use terminals 9 and 10 of the output terminal strip. As this is a dry contact, the DHW pump contact must be wired with either the DHW pump supply voltage or DHW pump relay coil voltage. DHW pump functionality is configured using the touch screen. Contact ratings are 250VAC, 1.5A maximum.

System Pump: When connecting a system pump, use terminals 11 and 12 of the output terminal strip. As this is a dry contact, the system pump contact must be wired with either the system pump supply voltage or the system pump relay coil voltage. System pump functionality is configured using the touch screen. Contact ratings are 250VAC, 1.5A maximum.

AUX: These contacts, when used are connected to terminals 13 and 14 of the output terminal strip. The controller closes this contact when Field Input 1 is closed; otherwise, this contact remains open. Contact ratings are 250VAC, 1.5A maximum.

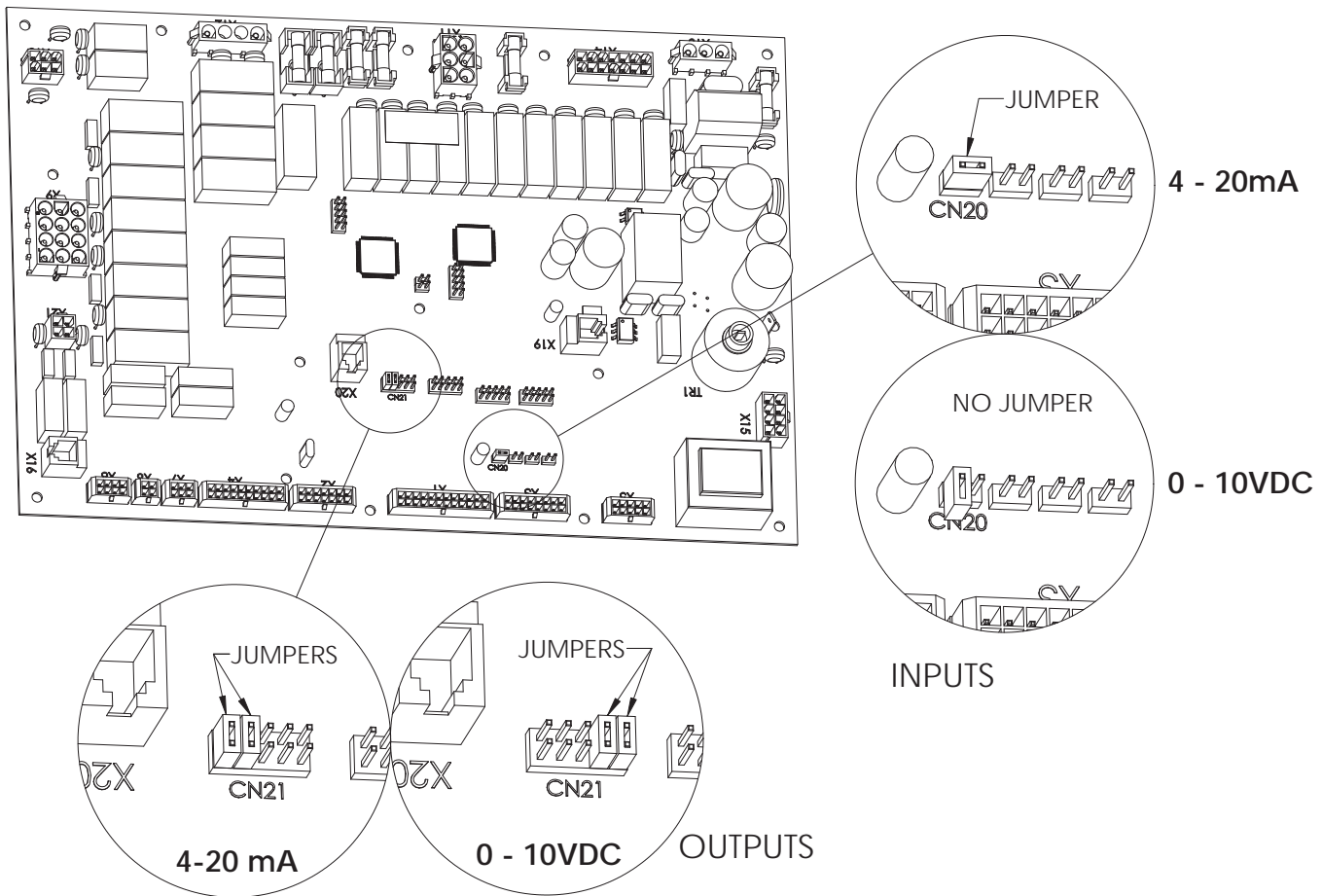

Figure 5. Analog Input and Output Jumper Placement

3.C.2.b Cascade RS485

Prior to wiring Copper Brute II units for cascade operations, select one Copper Brute II as the lead boiler/heater. Other Copper Brute IIs connected to the lead boiler/heater will be referred to as lag units.

Communication between lead and lag units is accomplished using RS485. When wiring Copper Brute II units for cascade operations, use terminals 22 (B), 23 (A), and 24 (GND) of the output terminal strip. Use 2-wire twisted pair, shielded w/drain, communication cable between units. Referring to Figure 6, connect one end of the twisted pair wires to A (terminal 23), and the other to terminal B (terminal 22), and the drain wire to GND (terminal 24). Connect the other end of the cable to the next Copper Brute II, matching the termination wiring on the previous unit, except for GND. Only connect the drain wire to ground on one end of the cable to avoid ground loop issues. If more than two Copper Brute II units are cascaded together, daisy chain the wiring from Copper Brute II to Copper Brute II, keeping the cables as short as possible.

A system supply sensor must be installed and connected to the lead boiler, see System Supply in Section 5.3.1.4 – Temperature Sensors. The lead boiler will use this system supply sensor as the temperature control sensor for cascade operations.

CH1/DHW1 terminals are used to initiate a heat demand at the lead boiler, refer to CH1/DHW1 in Heat Demands of the Installation Manual (Doc 1392).

3.C.2.c BAS RS485

These terminals, when used, are for RS485 serial communication with a BAS system using BACnet MS/TP or Modbus protocols. Use 2-wire twisted pair, shielded w/drain, communication cable between the BAS and Copper Brute II.

3.C.2.d 24VAC

There are terminals for 24VAC on the output terminal strip. These terminals are reserved for Copper Brute II low-temp units or a low water cuto-off option kit.

3.D Cascade Wiring Connections

For the complete list of wiring diagrams and logic diagrams, please reference the Installation and Operating Manual. Document 1392

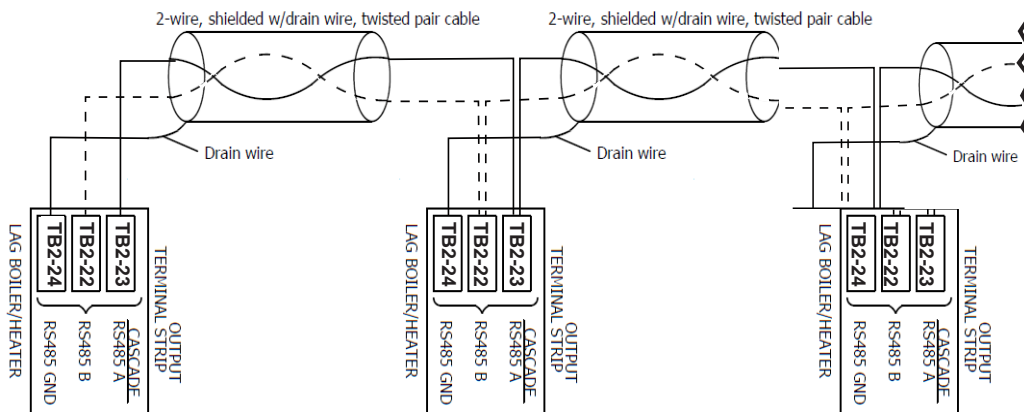

Figure 6. Cascade Wiring Connections

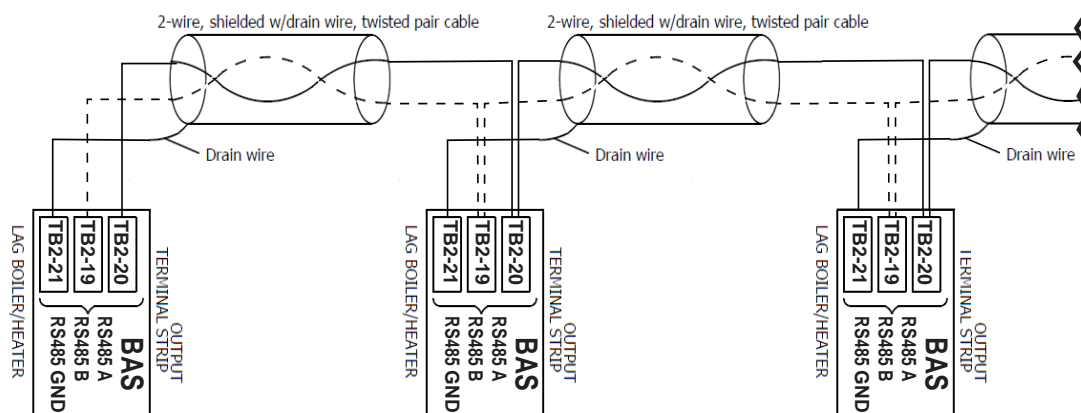

Figure 7. Cascade BAS Wiring Connections

SECTION 4 Burner Set Up

4.A Set Up for 0 to 2500 Feet Altitude

The Copper Brute II appliance utilizes a modular design to achieve its stage-firing. The setup must be checked before the unit is put in operation. Problems such as failure to start, rough ignition, strong exhaust odors, etc. can be due to improper setup. Damage to the Copper Brute II resulting from improper setup is not covered by the limited warranty.

- Using this manual, make sure the installation is complete and fully in compliance with the instructions.
- Determine that the appliance and system are filled with water and all air has been bled from both. Open all valves.
- Observe all warnings on the Operating Instructions label and turn on gas and electrical power to appliance.
- Switch on the appliance power switch located on the right side of the unit.
- The Copper Brute II will enter the start sequence, as long as the unit is being called for heat. The blower and pump come on for pre-purge, then the ignitor warm-up sequence starts and after the ignitor warm-up is complete and all safety devices are verified, the gas valves open. If ignition doesn't occur, check that there is proper gas supply. Wait 5 minutes and start the unit again. During initial start up, air in the gas line may cause the Copper Brute II to "lock out" during the first few trials for ignition. Depending on the ignition modules installed, the manual reset button on the ignition modules may need to be depressed to restart the Copper Brute II.
- With the unit running, verify the supply gas pressure, manifold gas pressure, and CO₂ according to the Table 4 on page 16

		Natural Gas	Propane
Supply Gas Pressure	Typical	7" w.c. (1.7kPa)	11" w.c. (2.7kPa)
	Range	4" w.c. ≤ (supply pressure) ≤ 13" w.c.	
Manifold Gas Pressure		2.5" w.c. (0.62 kPa)	
CO ₂		8%	9.2%

Table 4. Supply Gas Pressure

7. After placing the appliance in operation, the Burner Safety Shutoff Device must be tested.

To test:

- Close gas shutoff valve with burner operating.
- The flame will go out and blower will continue to run for the post purge cycle. One additional attempt to light will follow. Ignition will not occur as the gas is off. The ignition control will lockout, and will have to be reset before the unit will operate.
- Open gas shutoff valve. Restart the appliance. The ignition sequence will start again and the burner will start. The appliance will return to its previous mode of operation.

NOTE: Sizes 1000–2000 have two ignition controls and two ignitors, which work independently of one another. If the ignition control for stages 1 and 2 fails to properly light the main burners for those stages, the second ignition control will still be active, and will be able to energize stages 3 and 4. This, of course, will only occur if all other safety devices confirm that the unit will run in a safe condition.

4.B Set Up for High Altitude (>2500 Feet)

Copper Brute II appliances may be operated at high altitude (7700 ft., 2347 m) with a reduction in output of approximately 10%. At altitudes of less than or more than 7700 ft. (2347 m) the appliance will perform equally as well, but with differing reductions in output. At elevations higher than 7700 ft. (2347 m) the reduction in output will exceed 10% and at elevations below 7700 ft. (2347 m) it will be less than 10%. High altitude adjustment must not be made on appliances operating at elevations below 2500 ft. (762 m).

No orifice changes are required to adjust the Copper Brute II appliances for high altitude. High altitude adjustment is accomplished by adjustment of the gas valve manifold pressure and the air shutter(s).

The required instruments used to assist in these adjustments are a CO₂ or O₂ Analyzer and a U-Tube Manometer or other device capable of reading a pressure of 2.5-3.0 inches w.c. (0.62-0.75 kPa).

Start the adjustment process by checking the CO₂ in the "as installed" condition. Adjust the air shutter(s) so that the CO₂ is about 8% or the O₂ is about 6.8% for appliances operating on Natural Gas. For appliances operating on LP Gas adjust the air shutter(s) so that the CO₂ is about 9.2% or the O₂ is about 6.8%. Appliances with two blowers should be adjusted so that the air shutters below each blower are open the same amount.

Once the CO₂ or O₂ has been set, the manifold pressure may be adjusted. Remove the 1/8 NPT plug from the lower side of the gas valve that is to be set and install a fitting, hose and manometer. Start the appliance and observe the manifold pressure. Manifold pressure must be adjusted to 3.0 in. w.c. (0.75 kPa) (for high altitude only, standard operating pressure is 2.5 in. w.c. (0.62 kPa)). It is adjusted by removing the slotted cap on the gas valve and turning the adjustment screw (beneath the cap) clockwise to increase pressure and replaced after the adjustments have been completed and the fitting, hose and manometer have been removed and the 1/8" plug has been replaced. Repeat this process until all gas valves have been set. **Note:** The pressure can be set only when the appliance is operating and only when the particular gas valve being adjusted is energized by a call for heat from the staging control.

After all of the gas valve manifold pressures have been set, the CO₂ or O₂ must be reset. CO₂ or O₂ will have changed when the manifold pressure was adjusted. Open the air shutter(s) to reduce the CO₂ or O₂ to the values achieved previously.

The procedure is complete when all gas valves are adjusted to a manifold pressure of 3.0 in. w.c. (0.75 kPa) and the CO₂ is adjusted to 8.0% for Natural Gas appliances or 9.2% for LP appliances. When using an O₂ analyzer, the correct O₂ is 6.8% for both Natural Gas and LP appliances.

⚠ Caution

Should any odor of gas be detected, or if the gas burner does not appear to be functioning in a normal manner, close main shutoff valve, do not shut off switch, and contact your heating contractor, gas company, or factory representative.



H2380200A