

Installation and Operation Instructions for

Copper Brute™ II

includes **Low Temp Copper Brute II**

Hydronic Boiler

Model BWCH

Water Heater

Model BWCV

Sizes 500-2000

U.S. Reg. 2,765,423

FOR YOUR SAFETY: This product must be installed and serviced by a professional service technician, qualified in hot water boiler installation and maintenance. Improper installation and/or operation could create carbon monoxide gas in flue gases which could cause serious injury, property damage, or death. Improper installation and/or operation will void the warranty. For indoor installations, as an additional measure of safety, Laars strongly recommends installation of suitable Carbon Monoxide detectors in the vicinity of this appliance and in any adjacent occupied spaces.

⚠ WARNING

If the information in this manual is not followed exactly, a fire or explosion may result causing property damage, personal injury or loss of life.

Do not store or use gasoline or other flammable vapors and liquids in the vicinity of this or any other appliance.

WHAT TO DO IF YOU SMELL GAS

- Do not try to light any appliance.
- Do not touch any electrical switch; do not use any phone in your building.
- Immediately call your gas supplier from a nearby phone. Follow the gas supplier's instructions.
- If you cannot reach your gas supplier, call the fire department.

Installation and service must be performed by a qualified installer, service agency, or gas supplier.

⚠ AVERTISSEMENT

Assurez-vous de bien suivre les instructions données dans cette notice pour réduire au minimum le risque d'incendie ou d'explosion ou pour éviter tout dommage matériel, toute blessure ou la mort.

Ne pas entreposer ni utiliser d'essence ni d'autres vapeurs ou liquides inflammables dans le voisinage de cet appareil ou de tout autre appareil.

QUE FAIRE SI VOUS SENTEZ UNE ODEUR DE GAZ:

- Ne pas tenter d'allumer d'appareils.
- Ne touchez à aucun interrupteur. Ne pas vous servir des téléphones dans le bâtiment où vous vous trouvez.
- Appelez immédiatement votre fournisseur de gaz depuis un voisin. Suivez les instructions du fournisseur.
- Si vous ne pouvez rejoindre le fournisseur de gaz, appelez le service des incendies.

L'installation et l'entretien doivent être assurés par un installateur ou un service d'entretien qualifié ou par le fournisseur de gaz.

TABLE OF CONTENTS

SECTION 1 General Information	4	4.B.5	Freeze Protection – Water Heater	25	
1.A	Introduction.....	4	4.B.6	Filling the Water Heater System.....	30
1.B	Warranty	5	SECTION 5 Electrical Connections.....		31
1.C	Model Identification (Nomenclature).....	5	5.A	Installation Warnings	31
1.D	Dimensions.....	6	5.B	Line Voltage Connections.....	31
1.E	Locating the Appliance	7	5.B.1	Main Power.....	31
1.F	Locating Pump-Mounted Water Heater with Respect to Storage Tank(s).....	7	5.B.2	Pump Power	31
1.G	Locating Pump-Mounted Boiler with Respect to Return/Supply Header	7	5.B.3	Boiler/Heater Pump	31
1.H	Locating Appliance for Correct Horizontal Vent/Ducted Air Distance From Outside Wall	8	5.B.4	Auxiliary Power Output.....	32
1.I	Installation Kit	8	5.C	Low Voltage Connections	32
SECTION 2 Venting and Combustion Air		9	5.C.1	Field Wiring - Inputs.....	32
2.A	Combustion Air	9	5.C.1.a	Safety Interlocks.....	32
2.A.1	Combustion Air From Room	9	5.C.1.b	Boiler/Heater Heat Demands.....	32
2.A.2	Intake Combustion Air	9	5.C.1.c	Field Inputs (Open/Closed).....	32
2.B	Venting.....	10	5.C.1.d	Temperature Sensors	32
2.B.1	Vent Categories.....	10	5.C.1.e	Analog (BAS) Input.....	33
2.B.2	Category I Vent.....	10	5.C.2	Field Wiring - Outputs	33
2.B.3	Common Venting Systems	11	5.C.2.a	Dry Contacts.....	33
2.B.4	Category III Vent.....	13	5.C.2.b	Cascade RS485	34
2.C	Locating Vent & Combustion Air Terminals.....	13	5.C.2.c	BAS RS485 (BACnet MS/TP or Modbus).....	34
2.C.1	Side Wall Vent Terminal.....	13	5.C.2.d	24VAC	34
2.C.2	Side Wall Combustion Air Terminal.....	15	5.D	Cascade Wiring Connections	35
2.C.3	Vertical Vent Terminal.....	15	5.E	Wiring Diagram	36
2.C.4	Vertical Combustion Air Terminal.....	15	5.F	Ladder Diagram.....	38
2.D	Common Vent Test — Boilers.....	15	SECTION 6 Touchscreen and System Ops		40
2.E	Vent Terminals for Outdoor Units.....	16	6.A	The Home Screen	40
SECTION 3 Gas Supply and Piping		17	6.A.1	Home Screen Status Window.....	40
3.A	Gas Supply and Piping.....	17	6.A.2	Home Screen Active Icons	41
SECTION 4 Water Connections BOILER or WATER HEATER.....		18	6.B	LOGIN, Lock / Unlock Display Screen	42
4.A	Boiler	18	6.C	Keypad Operations.....	43
4.A.1	Heating System Piping: Hot Supply Connections — Boiler	18	6.D	Quick Start	44
4.A.2	Cold Water Make-Up — Boiler	18	6.D.1	CH /DHW	44
4.A.3	Water Flow Requirements —Boiler	18	6.D.1.a	CH1 /DHW1.....	44
4.A.4	Water Flow Requirements — Low Temperature Copper Brute II Boilers	18	6.D.1.b	CH2/DHW2 2.....	44
4.A.5	Freeze Protection — Boiler	19	6.D.2	DHW/DHW3	45
4.A.6	Filling the Boiler System.....	22	6.D.3	Outdoor Reset	45
4.B	Water Heaters	24	6.D.4	Warm Weather Shut Down	45
4.B.1	Water System Piping —Water Heater	24	6.D.5	Anti-Short Cycle	46
4.B.2	Hot Water Supply Piping —Water Heater.....	25	6.D.6	Time & Date	46
4.B.3	Water Flow Requirements —Water Heater	25	6.E	Configure Screen.....	47
4.B.4	Combined Water Heating (potable) and Space Heating — Water Heater	25	6.E.1	CH/DHW	47
			6.E.1.a	CH1/DHW1.....	47
			6.E.1.b	Additional Settings	50
			6.E.2	CH2/DHW2.....	50
			6.E.3	DHW/DHW3	51
			6.E.4	Outdoor Reset	51

6.E Configure Screen (continued)

6.E.5 Cascade 53

6.E.5.a Configure Lead Unit..... 53

6.E.5.b Configure Lag Unit..... 54

6.E.5.c Cascade CH 55

6.E.5.d Cascade DHW..... 56

6.E.5.e Cascade Rotation 56

6.E.5.f Cascade Redundancy 57

6.E.5.g Cascade Hybrid 57

6.E.6 Pumps 58

6.E.7 Firing Rate 58

6.E.8 Temp Limits 59

6.E.9 External 59

6.E.9.a External – Remote Set Point 60

6.E.9.b External Firing Rate..... 61

6.E.10 Setting the Time and Date 62

6.E.11 Miscellaneous Features 62

6.E.11.a Mixing Valve. Low Temp Copper Brute II 62

6.E.11.b Anti-Short Cycle 63

6.E.11.c Wireless Setup 63

6.E.11.d Warm Weather 63

6.E.11.e COM Port 64

6.E.11.f Temperature Conversion 65

6.E.11.g Frost Protection 65

6.E.12 Login 65

6.F Service Screens..... 66

6.F.1 Burner..... 66

6.F.2 Digital I/O (Input / Output)..... 66

6.F.3 Analog I/O..... 67

6.F.4 Screen Settings 67

6.F.5 History 68

6.F.6 Restart..... 68

6.F.7 Factory Reset 68

6.G Messages and USB 68

6.G.1 Messages 68

6.G.2 USB Functionality..... 69

6.H Active Demands..... 70

6.I The Navigation Bar 70

6.J Date and Time Display Area 70

SECTION 7 Sequence of Operation71

7.A Restarting the Copper Brute II 71

7.B Sequence of Operation 71

7.C Shutting Down the Copper Brute II 72

SECTION 8 Burner Set Up73

8.A Set Up for 0 to 2500 Feet Altitude 73

8.B Set Up for High Altitude (>2500 Feet) 73

SECTION 9 Maintenance.....75

9.A System Maintenance 75

9.B Appliance Maintenance and Component Description75

9.B.1 Burners 75

9.B.2 Filter..... 75

9.B.3 Gas Valves 75

9.B.4 Manual Reset High Limit Control..... 75

9.B.5 Automatic Reset High Limit Control..... 76

9.B.6 Controller 76

9.B.7 Igniters..... 77

9.B.8 Ignition Sensors..... 77

9.B.9 Transformer 77

9.B.10 Blowers..... 77

9.B.11 Flow Switch 77

9.B.12 Heat Exchanger Coil 77

SECTION 10 Trouble Shooting.....78

10.A Resolving Lockouts 78

10.B Delayed Ignition — Possible Causes 79

10.C Short Cycling — Boiler 79

10.D Short Cycling — Water Heater 79

10.E High Gas Consumption 79

10.F Troubleshooting Errors and Lockouts..... 80

10.G Parameter Tables 82

10.G.1 Boiler Parameters (including Low Temp)..... 82

10.G.2 Water Heater Parmeters (including Low Temp)..... 86

10.G.3 Modbus Memory Map..... 90

10.G.4 BACnet MSTP Memory Map 92

SECTION 11 Replacement Parts94

11.A General Information..... 94

11.B Parts List..... 94

11.C Parts Illustrations..... 100

SECTION 1 General Information

USING THIS MANUAL – Because the Copper Brute II Boilers and Copper Brute II Water Heaters are identical appliances, with the exception of materials of manufacture, labels and ultimate use application, this manual provides information for the proper installation, operation and maintenance of both products. Where differences exist between the application of the appliances and their operation, the sections pertinent to only one appliance or the other will be so identified.

In the Commonwealth of Massachusetts, this appliance must be installed by a licensed plumber or gas fitter.

1.A Introduction

This manual provides information necessary for the installation, operation, and maintenance of Bradford White Copper Brute II appliances (including the Low Temp Copper Brute II). Read this manual carefully before installation.

All application and installation procedures should be reviewed completely before proceeding with the installation. Consult the Bradford White factory, or local factory representative, with any issues or questions regarding this equipment. Experience has shown that most operating issues are caused by improper installation.

The Copper Brute II appliance is protected against over pressurization. A pressure relief valve is fitted to all appliances. It is installed on the outlet header, at the water outlet of the appliance.

IMPORTANT: The inlet gas pressure to the appliance must not exceed 13" w.c. (3.2kPa).

All installations must be made in accordance with:

- 1) In the U.S., the "National Fuel Gas Code" ANSI Z223.1/NFPA54, Latest Edition and all applicable local codes as required by the Authorities Having Jurisdiction (AHJ), or
- 2) In Canada, the "Natural Gas and Propane Installation Code", CSA B149.1, latest edition and all applicable local codes as required by the AHJ.

All electrical wiring is to be done in accordance with:

- 1). In the U.S., the "National Electrical Code" (NEC), ANSI/NFPA 70, latest Edition and all applicable local codes as required by the AHJ, or
- 2). In Canada, the "Canadian Electrical Code - Part 1", CSA STD. C22.1 and all applicable local codes as required by the AHJ.

This appliance must be electrically grounded in accordance with the applicable codes and standards referenced above.

WARNING

The Copper Brute II hydronic, boiler or water heater **must** be installed in accordance with the procedures detailed in this manual, or the Bradford White warranty may be voided. The installation must conform to the requirements of the local jurisdiction having authority, and, in the United States, to the latest edition of the National Fuel Gas Code, ANSI Z223.1/NFPA54. In Canada, the installation must conform to the latest edition of the Natural Gas and Propane Installation Code, CSA B149.1 and/or local codes. Where required by the authority having jurisdiction, the installation of Copper Brute II appliances must conform to the Standard for Controls and Safety Devices for Automatically Fired Boilers, ANSI/ASME CSD-1. Any modifications to the boiler, its gas controls, or wiring may void the warranty. If field conditions require modifications, consult the factory representative before initiating such modifications.

AVERTISSEMENT

Afin de réduire au minimum les risques de commotion électrique, de feu ou d'autre nature, qui pourraient causer des dommages matériels, des blessures ou des accidents mortels, les chaudières à eau chaude ou les chauffe-eau Copper Brute II **doivent** être installés conformément aux directives détaillées contenues dans ce manuel, à défaut de quoi la garantie fournie par Bradford White serait annulée. L'installation doit être conforme aux exigences de la réglementation locale en vigueur et, aux États-Unis, à l'édition la plus récente du National Fuel Gas Code (Code pour le gaz combustible naturel) ANSI Z223.1/NFPA54. Au Canada, l'installation doit respecter les exigences de la plus récente édition du Code d'installation du gaz naturel et du propane CSA B149.1, et/ou des codes locaux de construction en vigueur. Lorsque la réglementation locale l'exige, l'installation des appareils électroménagers Copper Brute II doit respecter les exigences du Standard for Controls and Safety Devices for Automatically Fired Boilers (Code pour les équipements de commande et de sécurité des chaudières à combustion automatique), ANSI/ASME CSD-1. Toute modification apportée à la chaudière, aux régulateurs de gaz ou au câblage, peut compromettre la garantie. Si certaines conditions particulières rendent des adaptations nécessaires, consulter un représentant du fabricant avant d'entreprendre ces modifications.

1.B Warranty

Bradford White' appliances are covered by a limited warranty. Owners should submit online warranty registration at www.BradfordWhite.com.

All warranty claims must be made to an authorized Bradford White representative, directly to Customer Service, or online at www.BradfordWhite.com.

Claims must include the serial number and model number (this information can be found on the rating plate), installation date, and name of the installer. Shipping costs are not included in the warranty coverage.

Some accessory items are shipped in separate packages. Verify receipt of all packages listed on the packing slip. Inspect everything for damage immediately upon delivery, and advise the carrier of any shortages or damage. Any such claims should be filed with the carrier. The carrier, not the shipper, is responsible for shortages and damage to the shipment whether visible or concealed.

1.C Model Identification (Nomenclature)

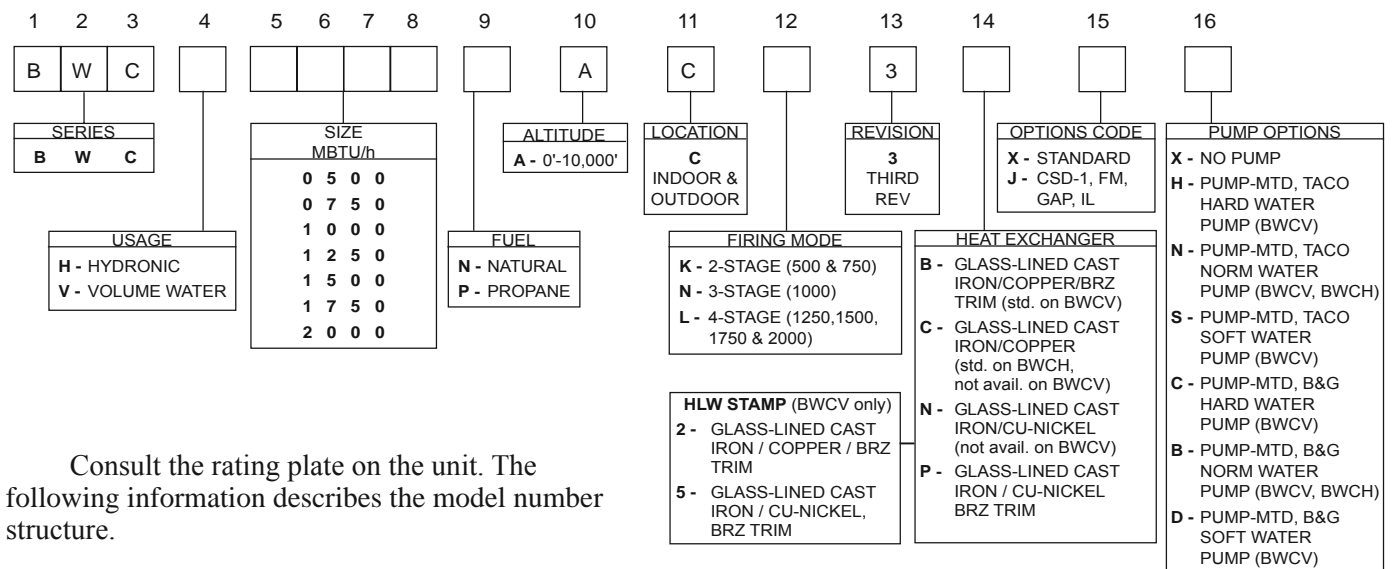

Consult the rating plate on the unit. The following information describes the model number structure.

Model Character Designation

1-3 Model Series Designation

B W C = Bradford White, Copper Brute II

4 Usage

H = Hydronic
V = Volume Water

5-8 Size

0 5 0 0 = 500,000 BTU/h input
0 7 5 0 = 750,000 BTU/h input
1 0 0 0 = 999,000 BTU/h input
1 2 5 0 = 1,250,000 BTU/h input
1 5 0 0 = 1,500,000 BTU/h input
1 7 5 0 = 1,750,000 BTU/h input
2 0 0 0 = 1,999,000 BTU/h input

9 Fuel

N = Natural Gas
P = Propane

10 Altitude

A = 0-10,000 feet

11 Location

C = Indoor and Outdoor

12 Firing Mode

K = Two-stage (models 500 & 750)
N = Three-stage (model 1000)
L = Four-stage (models 1250 - 2000)

13 Revision

3 = Third version

14 Heat Exchanger

B = Glass-lined CI / copper / brz trim (std. BWCV)
C = Glass-lined cast iron / copper (standard BWCH)
N = Glass-lined cast iron / cu-nickel
P = Glass-lined cast iron / cu-nickel / brz trim

15 Option Code

X = Standard unit
J = CSD-1, FM, IRI, IL

16 Pump Options

X = No Pump
H = Pump mounted, TACO, hard water pump
N = Pump mounted, TACO, normal pump
S = Pump mounted, TACO, soft water pump
C = Pump mounted, B&G, hard water pump
B = Pump mounted, B&G, normal pump
D = Pump mounted, B&G, soft water pump

1.D Dimensions

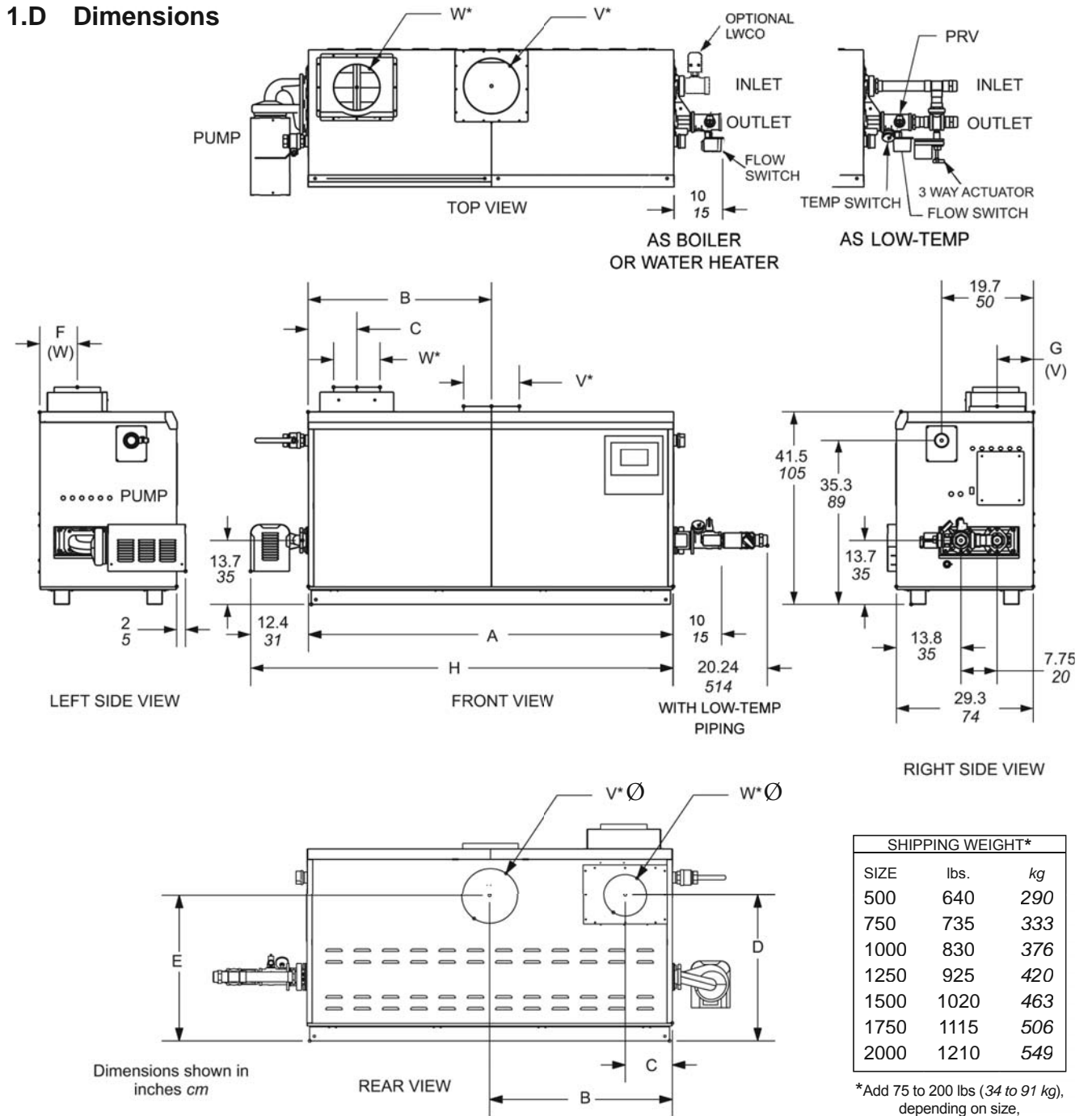

SHIPPING WEIGHT*		
SIZE	lbs.	kg
500	640	290
750	735	333
1000	830	376
1250	925	420
1500	1020	463
1750	1115	506
2000	1210	549

*Add 75 to 200 lbs (34 to 91 kg), depending on size, for pump-mounted units.

Size	A		B		C		D		E		F		G		H		Air Conn. W*	Vent Conn. V*	Horiz. Vent Pipe			
500	33½	85	15¾	40	5¾	15	29¾	76	33¾	86	7¾	20	8¾	22	46	117	6	15	8	20	6	15
750	45½	116	21¾	55	5¾	15	29¾	76	33¾	86	7¾	20	8¾	22	58	147	8	20	10	25	8	20
1000	57½	146	28¾	73	5¾	15	29¾	76	33¾	86	7¾	20	7	18	70	178	8	20	10	25	8	20
1250	68	172	34	86	10⅞	26	30¾	78	31⅞	79	8¾	22	8¾	22	80	203	12	30	12	30	10	25
1500	78½	199	39¾	101	10⅞	26	30¾	78	31⅞	79	8¾	22	8¾	22	91	231	12	30	12	30	10	25
1750	89	226	44½	113	10⅞	26	30¾	78	31⅞	79	8¾	22	8¾	22	101	256	12	30	14	36	12	30
2000	99½	253	49¾	126	10⅞	26	30¾	78	31⅞	79	8¾	22	8¾	22	112	284	12	30	14	36	12	30

*Air and vent connections may be on top or back of the unit and are field convertible.

Dimensions in inches cm

Figure 1. Dimensional Data.

SIZE	VENT COLLAR SIZE		HORIZONTAL VENT PIPE DIAMETER		INTAKE AIR PIPE DIAMETER		MAX. PIPE LENGTH	MAX. NO. OF ELBOWS	SIDE WALL VENT TERMINAL PART NUMBER	SIDE WALL COMBUSTION AIR TERMINAL PART NUMBER	
	in.	cm	in.	cm	in.	cm					ft.
500	8	20	6	15	6	15	50	15	3	CA001401	CA20260701
750	10	25	8	20	8	20	50	15	3	CA001402	CA20260703
1000	10	25	8	20	8	20	50	15	3	CA001402	CA20260703
1250	12	30	10	25	12	30	50	15	3	CA001405	CA20260706
1500	12	30	10	25	12	30	50	15	3	CA001405	CA20260706
1750	14	36	12	30	12	30	50	15	3	CA001404	CA20260706
2000	14	36	12	30	12	30	50	15	3	CA001404	CA20260706

Table 1. Horizontal Vent / Combustion Air Parameters.

1.E Locating the Appliance

The appliance should be located to provide clearances on all sides for maintenance and inspection. It should not be located in an area where leakage of any connections will result in damage to the area adjacent to the appliance or to lower floors of the structure.

When such a location is not available, it is recommended that a suitable drain pan, adequately drained, be installed under the appliance.

The appliance is design certified by CSA-International for installation on combustible flooring; in basements; in closets, utility rooms or alcoves.

Copper Brute II Boilers or Water Heaters must never be installed on carpeting. The location for the appliance should be chosen with regard to the vent pipe lengths and external plumbing. The unit shall be installed such that the gas ignition system components are protected from water (dripping, spraying, rain, etc.) during operation and service (circulator replacement, control replacement, etc.). When vented vertically, the Copper Brute II must be located as close as practical to a chimney or outside wall. If the vent terminal and/or combustion air terminal terminate through a wall, and there is potential for snow accumulation in the local area, both terminals should be installed at an appropriate level above grade.

The dimensions and requirements that are shown in Table 2 should be met when choosing the locations for the appliance.

1.F Locating Pump-Mounted Water Heater with Respect to Storage Tank(s)

For best results, a pump-mounted Copper Brute II water heater should be located within 15 feet (4.6m) of the storage tank(s). The pump is sized for 30 feet (9.1m) of piping.

If the appliance must be installed with longer piping runs, then larger diameter pipe or tubing shall be used. Consult the factory for assistance.

1.G Locating Pump-Mounted Boiler with Respect to Return/Supply Header

For the best results, a pump-mounted Copper Brute II Boiler should be located within 15 feet (4.6m) of the supply and return headers. The pump is sized for 30 feet (9.1m) of piping.

If the appliance must be installed with longer piping runs, then larger diameter tubing shall be used. Consult the factory for assistance.

APPLIANCE SURFACE	REQUIRED CLEARANCE FROM COMBUSTIBLE MATERIAL		RECOMMENDED SERVICE ACCESS CLEARANCE	
	inches	cm	inches	cm
Left Side	1	2.5	24	61
Right Side	1	2.5	24	61
Top	1	2.5	12	30
Back	1	2.5	12**	30**
Front	1	2.5	36	91
Vertical (Category 1) Vent	6*	15.2*		
Horizontal (Category 3) Vent	per UL1738 venting system supplier's instructions			

*1" (2.5cm) when b-vent is used.
 **When vent and/or combustion air connects to the back, recommended clearance is 36" (91cm).

Table 2. Clearances.

1.H Locating Appliance for Correct Horizontal Vent/Ducted Air Distance From Outside Wall

The forced draft combustion air blower/blowers in the appliance has/have sufficient power to pull air and vent properly when the following guidelines for horizontal air and vent are followed (see Table 1 on page 7).

NOTE: On all model sizes, the vent collar size is larger than the size of the vent pipe that can be used. Vent collar size and horizontal pipe diameters can be found in Table 1 The larger vent collar size is to accommodate Category I (vertical) vent systems.

NOTE: When located on the same wall, the Copper Brute II combustion air intake terminal must be installed a minimum of 12" (30cm) below the exhaust vent terminal and separated by a minimum of 36 inches (91cm) horizontally.

The air intake terminal must be installed high enough to avoid blockage from snow, leaves and other debris.

1.I Installation Kit

All units are shipped with an Installation Kit which contains the following items.

Description	Qty
1. Terminal Block Insertion/Removal Tools	1
2. Well, Immersion, for 3/16" Bulb	1
3. Well, Immersion, 1/2" NPT	1
4. Sensor, Outlet, Thermistor, Dual, 10K,	1
5. Tapered Rubber Stopper	1
6. Resistor, 1.5K, 1/4 Watt, 250V, Axial	2
7. Bushing, Nylon	3
8. Capillary Clamp	1
9. Outdoor Sensor	1
10. Sensors, Inlet, Temperature, Water	3
11. Label, Box, Remote Sensor	1

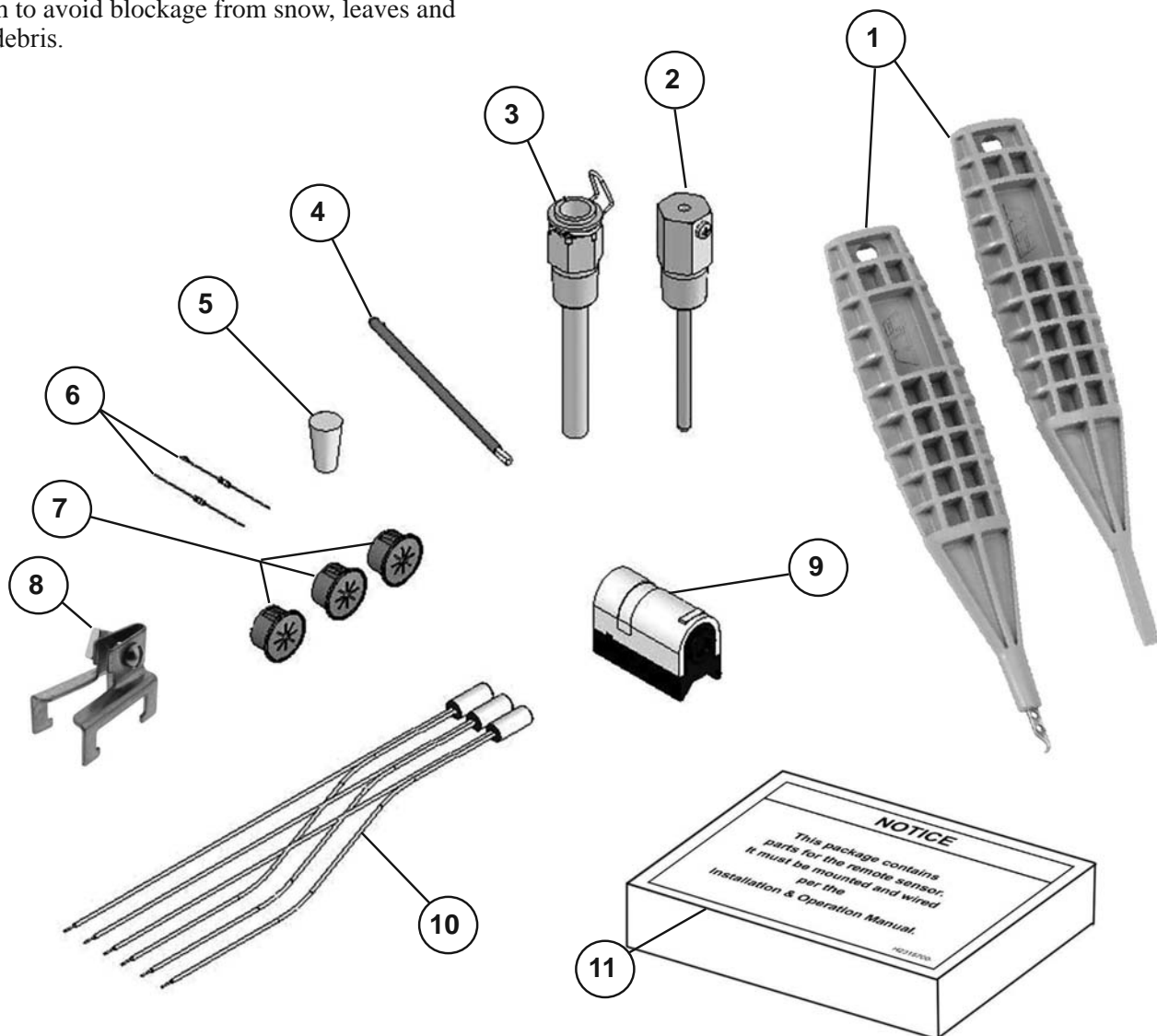

Figure 2. Installation Kit Components

SECTION 2 Venting and Combustion Air

2.A Combustion Air

Copper Brute II boilers and water heaters must have provisions for combustion and ventilation air in accordance with Section 5.3, Air for Combustion and Ventilation, of the National Fuel Gas Code, ANSI Z223.1, or Sections 7.2, 7.3 or 7.4 of CSA B149.1, Installation Codes, or applicable provisions of the local building codes.

A Copper Brute II appliance may receive combustion air from the space in which it is installed, or it can be ducted directly to the unit from the outside. Ventilation air must be provided in either case.

2.A.1 Combustion Air From Room

In the United States, the most common requirements specify that the space shall communicate with the outdoors in accordance with method 1 or 2, which follow. Where ducts are used, they shall be of the same cross-sectional area as the free area of the openings to which they connect.

Method 1: Two permanent openings, one commencing within 12 inches (30 cm) of the top and one commencing within 12 inches (30 cm) of the bottom, of the enclosure shall be provided. The openings shall communicate directly, or by ducts, with the outdoors or spaces that freely communicate

with the outdoors. When directly communicating with the outdoors, or when communicating to the outdoors through vertical ducts, each opening shall have a minimum free area of 1 square inch per 4000 Btu/hr (5.5 square cm/kW) of total input rating of all equipment in the enclosure. When communicating to the outdoors through horizontal ducts, each opening shall have a minimum free area of not less than 1 square inch per 2000 Btu/hr (11 square cm/kW) of total input rating of all equipment in the enclosure. Table 3 shows data for this sizing method, for each Copper Brute II model.

Method 2: One permanent opening, commencing within 12 inches (30 cm) of the top of the enclosure, shall be permitted. The opening shall directly communicate with the outdoors or shall communicate through a vertical or horizontal duct to the outdoors or spaces that directly communicate with the outdoors and shall have a minimum free area of 1 square inch per 3000 Btu/hr (7 square cm/kW) of the total input rating of all equipment located in the enclosure. This opening must not be less than the sum of the areas of all vent connectors in the confined space.

Other methods of introducing combustion and ventilation air are acceptable, providing they conform to the requirements in the applicable codes listed above.

In Canada, consult local building and safety codes or, in absence of such requirements, follow CSA B149.1.

WARNING

For indoor installations, as an additional measure of safety, Bradford White strongly recommends installation of suitable Carbon Monoxide detectors in the vicinity of this appliance and in any adjacent occupied spaces.

AVERTISSEMENT

Pour des installations intérieures, Bradford White recommande fortement, comme mesure de sécurité supplémentaire, l'installation de détecteurs de monoxyde de carbone adaptés dans le voisinage de l'appareil et dans chacune des pièces habitées adjacentes.

2.A.2 Intake Combustion Air

The combustion air can be taken through the wall, or through the roof. When taken from the wall,

SIZE	EACH OPENING*	
	SQUARE INCHES	SQUARE CM
500	125	807
750	188	1213
1000	250	1613
1250	313	2020
1500	375	2420
1750	438	2826
2000	500	3226

*Net Free Area in Square Inches / Square cm
Area indicated is for one of two openings; one at floor level and one at the ceiling, so the total net free area could be double the figures indicated.

This chart is for use when communicating directly with the outdoors. For special conditions and alternate methods, refer to the latest edition of ANSI Z223.1.

Note: Check with louver manufacturers for net free area of louvers. Correct for screen resistance to the net free area if a screen is installed. Check all local codes applicable to combustion air.

Table 3. Combustion Air Openings.

it must be taken from out-of-doors by means of the Bradford White horizontal wall terminal (see Table 1). When taken from the roof, a field-supplied rain cap or an elbow arrangement must be used to prevent entry of rain water (see Figure 3).

Use single-wall galvanized pipe, per Table 4, for the combustion air intake (see Table 1) for appropriate size. Route the intake to the heater as directly as possible. Seal all joints with tape. Provide adequate hangers. The unit must not support the weight of the combustion air intake pipe. Maximum linear pipelength allowed is 50 feet (15.2m). Three elbows have been calculated into the 50-foot (15.2m) linear run. Subtract 10 allowable linear feet (3.0m) for every additional elbow used (see Table 1). When fewer than 3 elbows are used, the maximum linear pipe length allowed is still 50 feet (15.2m).

The connection for the intake air pipe is on the filter box. The Copper Brute II appliances may have venting and combustion air ducting attached to the top or the back. They are shipped with the connections at the top. For attaching either or both pipes to the back, the mounting flanges are reversible by removing the mounting screws and orienting the flanges in the desired position. Replace the screws after positioning flanges. Run a bead of silicone around the collar and slide the pipe over the collar. Secure with sheet metal screws.

In addition to air needed for combustion, air shall also be supplied for ventilation, including all air required for comfort and proper working conditions for personnel. The Copper Brute II loses less than 1 percent of its input rating to the room, but other heat sources may be present.

TERM	DESCRIPTION
Pipe	Single-wall galvanized steel pipe, 24 gauge minimum (either insulated or non-insulated)
Joint Sealing	Permanent duct tape or aluminum tape

Table 4. Required Combustion Air Piping Material.

2.B Venting

2.B.1 Vent Categories

Depending upon desired Copper Brute II venting, it may be considered a Category I or a Category III appliance. In general, a vertical vent system will be a Category I system. However, in rare instances, a Copper Brute II's vertical vent system may be considered Category III. In the U.S., the National Fuel Gas Code (ANSI Z223.1-Latest Edition), or in Canada the CSA B149.1 (latest edition), defines a Category I vent system, and includes rules and tables to size these vent systems. If the Copper Brute II's vertical vent system does not satisfy the criteria for Category I venting, it must be vented as a Category III system.

All Copper Brute II vent systems which discharge horizontally (without the use of a power venter) are considered Category III vent systems.

2.B.2 Category I Vent

When vented as a category I appliance, the vent system must conform to the National Fuel Gas Code (ANSI Z223.1-Latest Edition) in the U.S., or in Canada, to CSA B149.1 (latest edition). The vent system must be sized and installed for a Category I Fan-Assisted Appliance.

If chimney height is greater than 25 feet, or if multiple units are vented into the same vertical vent, a barometric damper must be installed on each appliance, such that the flue draft does not exceed (negative) 0.1" w.c.

If using a power venter for any type of Category I venting, the draft should be set between (negative) 0.01 and 0.10" w.c.

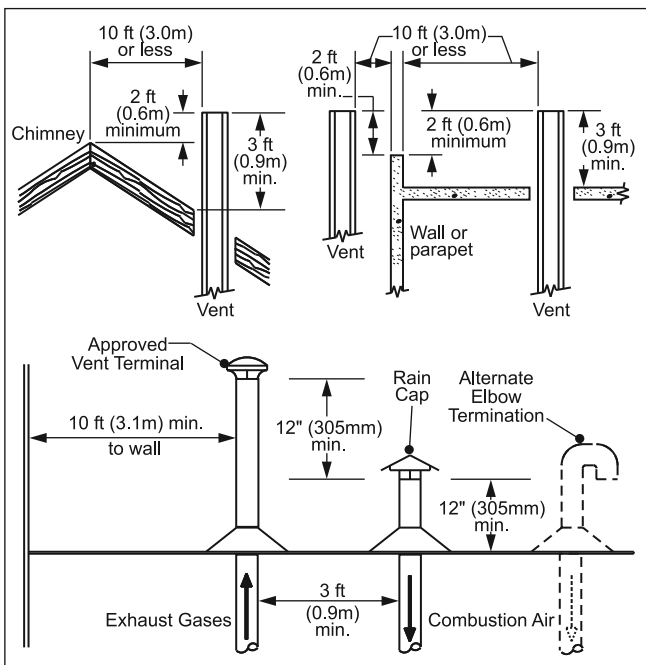

Figure 3. Combustion Air and Vent Through Roof.

2.B.3 Common Venting Systems

Copper Brute II units are Category I fan-assisted when vented vertically and adhering to all applicable codes. Copper Brute II units are not allowed to be vented into a common horizontal Cat III vent system (horizontal discharge or other configuration for Cat III), unless a properly sized vent fan is used, and the common vent system is properly designed by the vent fan manufacturer or a qualified engineer. When common venting Copper Brute II fan-assisted unit with other appliances through one shared vertical duct called a “common vent”, special care must be taken by the installer to ensure safe operation. In the event that the common vent is blocked, it is possible, especially for fan-assisted devices, to vent backwards through non-operating appliances sharing the vent, allowing combustion products to infiltrate occupied spaces.

If the appliances are allowed to operate in this condition, serious injury or death may occur.

WARNING

Operation of appliances with a blocked common vent may lead to serious injury or death. Safety devices must be implemented to prevent blocked common vent operation. If safe operation of all appliances connected to a common vent cannot be assured, including prevention of spillage of flue gasses into living spaces, common venting should not be applied, and appliances should each be vented separately.

AVERTISSEMENT

Le fonctionnement d'appareils connectés à un évent commun bouché peut provoquer de sérieuses blessures corporelles ou la mort. Des dispositifs de sécurité doivent être mis en place pour empêcher que les appareils soient utilisés avec un évent commun bouché. Si un fonctionnement sécuritaire de tous les appareils reliés à un évent commun et si la prévention des dégagements accidentels de gaz de combustion dans des zones habitées ne peuvent pas être assurés, un évent commun ne doit pas être mis en place et les appareils doivent être munis d'évents individuels séparés.

condition, that all appliances attached to the vent be locked out and prevented from operating. Note that the Copper Brute II is equipped with a blocked vent safety (pressure) switch, as shipped. However, this safety switch has only been designed and tested to be effective in installations where the Copper Brute II is vented separately and NOT common vented with other appliances. As an additional precaution, it is recommended that a Carbon Monoxide (CO) alarm be installed in all enclosed spaces containing combustion appliances. If assistance is required in determining how a blocked vent safety system should be connected to a Bradford White product, please call Applications Engineering at the Rochester phone number listed on back cover of this manual.

Refer to the installation and operating instructions on all appliances to be common vented for instructions, warnings, restrictions and safety requirements. If safe operation of all appliances connected to a common vent cannot be assured, including prevention of spillage of flue gasses into living spaces, common venting should not be applied, and appliances should each be vented separately.

It is for this reason that, in addition to following proper vent sizing, construction and safety requirements from the National Fuel Gas Code, ANSI Z223.1 or in Canada, from CSA B149.1 as well as all applicable local codes, it is required that installers provide some means to prevent operation with a blocked common vent. It is suggested that a blocked vent safety system be employed such that if the switch from one appliance trips due to excessive stack spill or backpressure indicating a blocked vent

	U.S. Installations (see note 1)	Canadian Installations (see note 2)
A = Clearance above grade, veranda, porch, deck, or balcony	12 inches (30 cm)	12 inches (30 cm)
B = Clearance to window or door that may be opened	4 feet (1.2 m) below or to side of opening; 1 foot (30 cm) above opening	36 inches (91 cm)
C = Clearance to permanently closed window	See note 4	See note 5
D = Vertical clearance to ventilated soffit located above the terminal within a horizontal distance of 2 feet (61cm) from the center line of the terminal	See note 4	See note 5
E = Clearance to unventilated soffit	See note 4	See note 5
F = Clearance to outside corner	See note 4	See note 5
G = Clearance to inside corner	See note 4	See note 5
H = Clearance to each side of center line extended above meter/regulator assembly	See note 4	3 feet (91 cm) within a height 15 feet above the meter/regulator assembly
I = Clearance to service regulator vent outlet	See note 4	3 feet (91 cm)
J = Clearance to nonmechanical air supply inlet to building or the combustion air inlet to any other appliance	4 feet (1.2 m) below or to side of opening; 1 foot (30 cm) above opening	36 inches (91 cm)
K = Clearance to a mechanical air supply inlet	3 feet (91 cm) above if within 10 feet (3 m) horizontally	6 feet (1.83 m)
L = Clearance above paved sidewalk or paved driveway located on public property	Vent termination not allowed in this location for category IV appliances. For Category III appliances, vent must terminate at least 7 feet (2.13m) above the sidewalk or driveway.	Vent termination not allowed in this location for category IV appliances. A vent shall not terminate directly above a sidewalk or paved driveway that is located between two single family dwellings and serves both dwellings. For Category III appliances that do not violate the previous condition, vent must terminate at least 7 feet (2.13m) above the sidewalk or driveway.
M = Clearance under veranda, porch, deck, or balcony	See note 4	12 inches (30 cm) (see note 3)

Notes:

1. In accordance with the current ANSI Z223.1 / NFPA 54 National Fuel Gas Code.
2. In accordance with the current CSA-B149.1 Installation Codes.
3. Permitted only if veranda, porch, deck, or balcony is fully open on a minimum of two sides beneath the floor.
4. For clearances not specified in ANSI Z223.1 / NFPA 54, clearance is in accordance with local installation codes and the requirements of the gas supplier.
5. For clearances not specified in CSA-B149.1, clearance is in accordance with local installation codes and the requirements of the gas supplier.

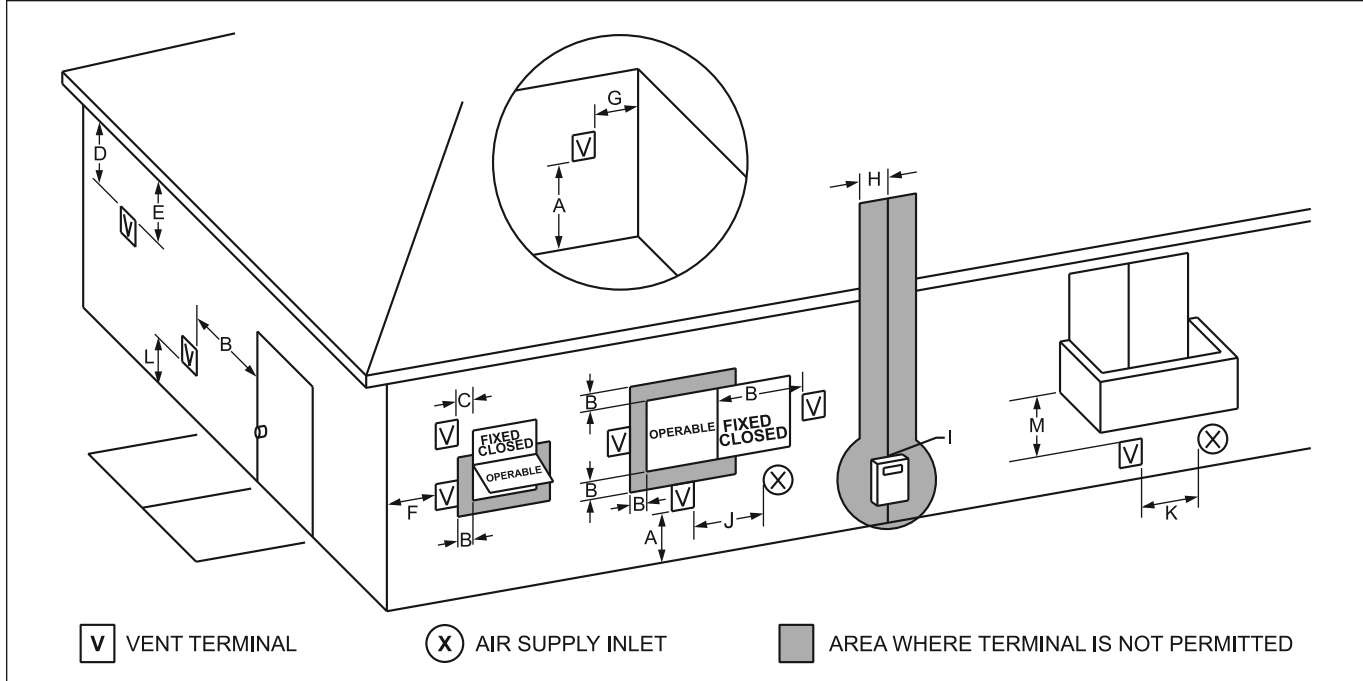

Figure 4. Combustion Air and Vent Through Side Wall.

2.B.4 Category III Vent

When the Copper Brute II is vented with horizontal discharge, it must be installed per this installation manual and the venting system manufacturer’s installation instructions. The vent system must be sealed stainless steel, per Table 5.

Route the vent pipe to the heater as directly as possible. Seal all joints and provide adequate hangers as required in the venting system manufacturer’s Installation Instructions. Horizontal portions of the venting system must be supported to prevent sagging and may not have any low sections that could trap condensate.

The unit must not support the weight of the vent pipe. Horizontal runs must slope downwards not less than ¼ inch per foot (2 cm/m) from the unit to the vent terminal.

L'appareil ne doit pas supporter le poids de la gaine d'évent. Les parties horizontales doivent être installées avec une pente de 2 cm/m (1/4 inch par pied) descendant de l'appareil vers la sortie de l'évent.

Reference Table 1 for the size of the Category III vent system. Up to three elbows can be used with 50 linear feet (15.2m) of pipe. Subtract 10 allowable linear feet (3.0m) for every additional elbow used.

TERM	DESCRIPTION
Pipe	Must comply with UL Standard 1738 such as Type 29-4C Stainless Steel (either insulated or non-insulated).
Joint Sealing	Follow vent manufacturer’s instructions

Table 5. Required Horizontal Venting Material.

WARNING

The outdoor vent terminal gets hot. Unit must be installed in such a way as to reduce the risk of burns from contact with the vent terminal.

2.C Locating Vent & Combustion Air Terminals

2.C.1 Side Wall Vent Terminal

The appropriate Bradford White side wall vent hood must be used, and is listed in the installation and operation manual. The terminal provides a means of installing the vent piping through the building wall, and must be located in accordance with ANSI Z223.1/ NFPA 54 and applicable local codes. In Canada, the installation must be in accordance with CSA B149.1 or .2 and local applicable codes. Consider the following when installing the terminal:

- Figure 4 shows the requirements for mechanical vent terminal clearances for the U.S. and Canada.

- Vent terminals for condensing appliances or appliances with condensing vents are **not** permitted to terminate above a public walkway, or over an area where condensate or vapor could create a nuisance or hazard.
- Locate the vent terminal so that vent gases cannot be drawn into air conditioning system inlets.
- Locate the vent terminal so that vent gases cannot enter the building through doors, windows, gravity inlets or other openings. Whenever possible, locations under windows or near doors should be avoided.
- Locate the vent terminal so that it cannot be blocked by snow. The installer may determine that a vent terminal must be higher than the minimum shown in codes, depending upon local conditions.
- Locate the terminal so the vent exhaust does not settle on building surfaces or other nearby objects. Vent products may damage such surfaces or objects.
- If the boiler or water heater uses ducted combustion air from an intake terminal located on the same wall, locate the vent terminal at least 3 feet (0.9m) horizontally from the combustion air terminal, and locate the vent terminal at least 1 foot (0.3m) above the combustion air terminal.

WARNING

The outdoor vent terminal gets hot. Unit must be installed in such a way as to reduce the risk of burns from contact with the vent terminal.

AVERTISSEMENT

La sortie d'évent à l'extérieur devient très chaude. Elle doit être installée de façon à réduire le risque de brûlures au contact de l'extrémité de l'évent.

Important Note: Massachusetts Code Requirement.

From Massachusetts Rules and Regulations 248 CMR 5.08:

- For all side wall horizontally vented gas fueled equipment installed in every dwelling, building or structure used in whole or in part for residential purposes, including those owned or operated by the Commonwealth and where the side wall exhaust vent termination is less than seven (7) feet above finished grade in the area of the venting, including but not limited to decks and porches, the following requirements shall be satisfied:**

1. INSTALLATION OF CARBON MONOXIDE DETECTORS.

At the time of installation of the side wall horizontal vented gas fueled equipment, the installing plumber or gasfitter shall observe that a hard-wired carbon monoxide detector with an alarm and battery back-up is installed on the floor level where the gas equipment is to be installed. In addition, the installing plumber or gasfitter shall observe that a battery operated or hard-wired carbon monoxide detector with an alarm is installed on each additional level of the dwelling, building or structure served by the side wall horizontal vented gas fueled equipment. It shall be the responsibility of the property owner to secure the services of qualified licensed professionals for the installation of hard-wired carbon monoxide detectors.

- a. In the event that the side wall horizontally vented gas fueled equipment is installed in a crawl space or an attic, the hard-wired carbon monoxide detector with alarm and battery back-up may be installed on the next adjacent floor level.
- b. In the event that the requirements of this subdivision cannot be met at the time of completion of installation, the owner shall have a period of thirty (30) days to comply with the above requirements; provided, however, that during said thirty (30) day period, a battery operated carbon monoxide detector with an alarm shall be installed.

2. APPROVED CARBON MONOXIDE DETECTORS.

Each carbon monoxide detector as required in accordance with the above provisions shall comply with NFPA 720 and be ANSI/UL 2034 listed and IAS certified.

3. SIGNAGE.

A metal or plastic identification plate shall be permanently mounted to the exterior of the building at a minimum height of eight (8) feet above grade directly in line with the exhaust vent terminal for the horizontally vented gas fueled heating appliance or equipment. The sign shall read, in print size no less than one-half (1/2) inch in size, "GAS VENT DIRECTLY BELOW. KEEP CLEAR OF ALL OBSTRUCTIONS".

4. INSPECTION.

The state or local gas inspector of the side wall horizontally vented gas fueled equipment shall not approve the installation unless, upon inspection, the inspector observes carbon monoxide detectors and signage installed in accordance with the provisions of 248 CMR 5.08(2)(a) 1 through 4.

(b) EXEMPTIONS: The following equipment is exempt from 248 CMR 5.08(2)(a) 1 through 4:

1. The equipment listed in Chapter 10 entitled "Equipment Not Required To Be Vented" in the most current edition of NFPA 54 as adopted by the Board; and
2. Product Approved side wall horizontal vented gas fueled equipment installed in a room or structure separate from the dwelling, building or structure used in whole or in part for residential purposes.

(c) MANUFACTURER REQUIREMENTS – GAS EQUIPMENT VENTING SYSTEM PROVIDED. When the manufacturer of Product Approved side wall horizontally vented gas equipment provides a venting system design or venting system components with the equipment, the instructions provided by the manufacturer for installation of the equipment and the venting system shall include:

1. Detailed instructions for the installation of the venting system design or the venting system components; and
2. A complete parts list for the venting system design or venting system.

(d) MANUFACTURER REQUIREMENTS – GAS EQUIPMENT VENTING SYSTEM NOT PROVIDED. When the manufacturer of a Product Approved side wall horizontally vented gas fueled equipment does not provide the parts for venting the fuel gases, but identifies "special venting systems", the following requirements shall be satisfied by the manufacturer:

1. The referenced "special venting system" instructions shall be included with the appliance or equipment installation instructions; and
2. The "special venting systems" shall be Product Approved by the Board, and the instructions for that system shall include a parts list and detailed installation instructions.

(e) A copy of all installation instructions for all Product Approved side wall horizontally vented gas fueled equipment, all venting instructions, all parts lists for venting instructions, and/or all venting design instructions shall remain with the appliance or equipment at the completion of the installation.

2.C.2 Side Wall Combustion Air Terminal

The Bradford White side wall combustion air terminal (listed in Table 1) must be used when the unit takes its combustion air through a duct from a side wall. Consider the following when installing the terminal:

1. Do not locate the air inlet terminal near a source of corrosive chemical fumes (e.g., cleaning fluid, chlorinated compounds, etc.)
2. Locate the terminal so that it will not be subject to damage by accident or vandalism.
3. Locate the combustion air terminal so that it cannot be blocked by snow. The National Fuel Gas Code requires that it be at least 12 inches (30 cm) above grade, but the installer may determine it should be higher, depending upon local conditions.
4. If the Copper Brute II is side-wall vented to the same wall, locate the vent terminal at least 3 feet (0.9m) horizontally from the combustion air terminal, and locate the vent terminal at least 1 foot (0.3m) above the combustion air terminal (see Figure 4).

2.C.3 Vertical Vent Terminal

When the unit is vented through the roof, the vent must extend at least 3 feet (0.9m) above the point at which it penetrates the roof. It must extend at least 2 feet (0.6m) higher than any portion of a building within a horizontal distance of 10 feet (3.0m), and high enough above the roof line to prevent blockage from snow. When the combustion air is taken from the roof, the combustion air must terminate at least 12" (30cm) below the vent terminal (see Figure 3).

2.C.4 Vertical Combustion Air Terminal

When combustion air is taken from the roof, a field-supplied rain cap or an elbow arrangement must be used to prevent entry of rain water (see Figure 3). The opening on the end of the terminal must be at least 12" (30cm) above the point at which it penetrates the roof, and high enough above the roof line to prevent blockage from snow. When the vent terminates on the roof, the combustion air must terminate at least 12" (30cm) below the vent terminal.

2.D Common Vent Test — Boilers

When an existing boiler is removed from a common venting system, the common venting system is likely to be too large for proper venting of the appliances remaining connected to it.

At the time of removal of an existing boiler, the following steps shall be followed with each appliance remaining connected to the common

venting system placed in operation, while the other appliances remaining connected to the common venting system are not in operation.

1. Seal any unused openings in the common venting system.
2. Visually inspect the venting system for proper size and horizontal pitch and determine there is no blockage or restriction, leakage, corrosion and other deficiencies which could cause an unsafe condition.
3. Insofar as it is practical, close all building doors and windows and all doors between the space in which the appliances remaining connected to the common venting system are located and other spaces of the building. Turn on clothes dryers and any appliance not connected to the common venting system. Turn on any exhaust fans, such as range hoods and bathroom exhausts, so they will operate at maximum speed. Do not operate a summer exhaust fan. Close fireplace dampers.
4. Place in operation the appliance being inspected. Follow the lighting instructions. Adjust thermostat so appliance will operate continuously.
5. Test for spillage at the draft hood relief opening after 5 minutes of main burner operation. Use the flame of a match or candle, or smoke from a cigarette, cigar or pipe.
6. After it has been determined that each appliance remaining connected to the common venting system properly vents when tested as outlined above, return doors, windows, exhaust fans, fireplace dampers and any other gas burning appliance to their previous conditions of use.
7. Any improper operation of the common venting system should be corrected so that the installation conforms to the National Fuel Gas Code, ANSI Z223.1/NFPA 54 and/or CSA B149.1, Installation Codes. When resizing any portion of the common venting system, the common venting system should be resized to approach the minimum size as determined using the appropriate tables in Part II of the National Fuel Gas Code, ANSI Z223.1/NFPA 54 and/or CSA B149.1, Installation Codes.

2.D Vérification des événements communs — Chaudières

Lorsqu'une chaudière existante est déconnectée du réseau d'événements commun, ce réseau d'événements commun devient probablement trop grand pour les appareils qui lui restent connectés. Lorsqu'une chaudière existante est retirée, les étapes suivantes doivent être accomplies pour chaque appareil qui reste connecté au réseau d'événements commun utilisé, alors que les autres appareils qui sont encore connectés au réseau commun d'événements ne sont pas en fonctionnement.:

1. *Sceller toutes les ouvertures non utilisées du*

- système d'évacuation.
2. *Inspecter de façon visuelle le système d'évacuation pour déterminer la grosseur et l'inclinaison horizontale qui conviennent et s'assurer que le système est exempt d'obstruction, d'étranglement, de fuite, de corrosion et autres défaillances qui pourraient présenter des risques.*
 3. *Dans la mesure du possible, fermer toutes les portes et les fenêtres du bâtiment et toutes les portes entre l'espace où les appareils toujours raccordés au système d'évacuation sont installés et les autres espaces du bâtiment. Mettre en marche les sècheuses, tous les appareils non raccordés au système d'évacuation commun et tous les ventilateurs d'extraction comme les hottes de cuisinière et les ventilateurs des salles de bain. S'assurer que ces ventilateurs fonctionnent à la vitesse maximale. Ne pas faire fonctionner les ventilateurs d'été. Fermer les registres des cheminées.*
 4. *Mettre l'appareil inspecté en marche. Suivre les instructions d'allumage. Réglez le thermostat de façon continue.*
 5. *Faire fonctionner le brûleur principal pendant 5 min ensuite, déterminer si le coupe-tirage déborde à l'ouverture de décharge. Utiliser la flamme d'une allumette ou d'une chandelle ou la fumée d'une cigarette, d'un cigare ou d'une pipe.*
 6. *Une fois qu'il a été déterminé, selon la méthode indiquée ci-dessus, que chaque appareil raccordé au système d'évacuation est mis à l'air libre de façon adéquate. Remettre les portes et les fenêtres, les ventilateurs, les registres de cheminées et les appareils au gaz à leur position originale.*
 7. *Tout mauvais fonctionnement du système d'évacuation commun devrait être corrigé de façon que l'installation soit conforme au National Fuel Gas Code, ANSI Z223.1/NFPA 54 et (ou) aux codes d'installation CSA-B149.1. Si la grosseur d'une section du système devrait être modifiée, le système devrait être modifié pour respecter les valeurs minimales des tableaux pertinents de l'appendice F du National Fuel Gas Code, ANSI Z223.1/NFPA 54 et (ou) les codes d'installation CSA-B149.1*

2.E Vent Terminals for Outdoor Units

For outdoor applications, the vent and combustion air openings must be covered with proper terminals to prevent rain, snow and other objects from falling into the Copper Brute II.

If local codes allow, outdoor installations may use 1' of appropriately sized galvanized single wall or B-Vent and a rain cap for exhaust vent termination in the default configuration (venting out of the top). An appropriately sized galvanized 90° ell, positioned with the opening facing down, may be used on the combustion air inlet in the default configuration on the back of the unit. Note that some local codes may require a higher vertical vent height, extending above any perimeter fencing, etc. In installations where the appearance of the vent is objectionable, the low profile vent terminals in Table 6 may be used.

Part numbers for the low profile terminals to cover the vent and combustion air openings are shown in Table 6.

SIZE	OUTDOOR VENT TERMINAL	OUTDOOR COMBUSTION AIR TERMINAL
500	20254703	D2007900
750	20254705	D2008000
1000	20254705	D2008000
1250	D2007700	D2008200
1500	D2007700	D2008200
1750	D2007800	D2008200
2000	D2007800	D2008200

Table 6. Vent Terminals for Outdoor Units.

WARNING

Do not use open flame to check for leaks. An open flame could lead to explosion, which could result in property damage, serious injury or death.

AVERTISSEMENT

Ne recherchez pas les fuites avec une flamme nue. Une flamme nue peut provoquer une explosion qui peut causer des dommages matériels, de sérieuses blessures corporelles ou la mort.

SECTION 3 Gas Supply and Piping

3.A Gas Supply and Piping

Gas piping should be supported by suitable hangers or floor stands, not by the appliance.

The Copper Brute II's gas train allows the user to pipe the gas from either the right side or the left side of the unit. As shipped, the right side of the gas train is capped off, and there is a manual valve on the left side. If desired, the manual valve on the left side of the gas train may be moved to the right side, and the cap on the right side may be moved to the left.

Review the following instructions before proceeding with the installation.

1. Verify that the appliance is fitted for the proper type of gas by checking the rating plate. Copper Brute II appliances are equipped to operate at elevations up to 10,000 feet (3050m). Copper Brute II appliances may be adjusted to operate properly at altitudes above 2500 feet (see SECTION 8 on page 73) and the input will be reduced if the heating value of the gas supply is below sea level values.
2. The maximum inlet gas pressure must not exceed 13" w.c. (3.2kPa). The minimum inlet gas pressure is 5" w.c. (1.2kPa).
3. Refer to Table 7, size supply.
4. Run gas supply line in accordance with all applicable codes.
5. Locate and install manual shutoff valves in

6. accordance with state and local requirements.
7. A sediment trap must be provided upstream of the gas controls.
8. All threaded joints should be coated with piping compound resistant to action of liquefied petroleum gas.
9. The appliance and its individual shutoff valve must be disconnected from the gas supply piping during any pressure testing of that system at test pressures in excess of 1/2 PSIG (3.45kpa).
10. The unit must be isolated from the gas supply system by closing its individual manual shutoff valve during any pressure testing of the gas supply piping system at test pressures equal to or less than 1/2 PSIG (3.45kpa).
11. The appliance and its gas connection must be leak tested before placing it in operation.
12. Purge all air from gas lines.

NOTE: The Copper Brute II appliance and all other gas appliances sharing the gas supply line must be firing at maximum capacity to properly measure the inlet supply pressure. The pressure can be measured at the supply pressure port on the gas valve. Low gas pressure could be an indication of an undersized gas meter, undersized gas supply lines and/or an obstructed gas supply line.

SIZE AND GAS TYPE	DISTANCE FROM GAS METER OR LAST STAGE REGULATOR					
	0-100'	0-31m	100-200'	31-61m	200-300'	61-91m
500 natural	1-1/2"	3.8cm	2"	5.1cm	2"	5.1cm
500 propane	1"	2.5cm	1-1/2"	3.8cm	1-1/2"	3.8cm
750 natural	2"	5.1cm	2"	5.1cm	2-1/2"	6.4cm
750 propane	1-1/2"	3.8cm	1-1/2"	3.8cm	2"	5.1cm
1000 natural	2"	5.1cm	2-1/2"	6.4cm	3"	7.6cm
1000 propane	1-1/2"	3.8cm	2"	5.1cm	2-1/2"	6.4cm
1250 natural	2-1/2"	6.4cm	2-1/2"	6.4cm	3"	7.6cm
1250 propane	2"	5.1cm	2"	5.1cm	2-1/2"	6.4cm
1500 natural	2-1/2"	6.4cm	3"	7.6cm	3"	7.6cm
1500 propane	2"	5.1cm	2-1/2"	6.4cm	2-1/2"	6.4cm
1750 natural	2-1/2"	6.4cm	3"	7.6cm	3"	7.6cm
1750 propane	2"	5.1cm	2-1/2"	6.4cm	2-1/2"	6.4cm
2000 natural	3"	7.6cm	3"	7.6cm	3-1/2"	8.9cm
2000 propane	2-1/2"	6.4cm	2-1/2"	6.4cm	3"	7.6cm

Notes:

1. These figures are based on 1/2" (0.12kPa) water column pressure drop.
2. Check supply pressure and local code requirements before proceeding with work.
3. Pipe fittings must be considered when determining gas pipe sizing.

Table 7. Gas Piping Size.

SECTION 4 Water Connections — BOILER or WATER HEATER

4.A Boiler

4.A.1 Heating System Piping:

Hot Supply Connections — Boiler

NOTE: This appliance must be installed in a closed pressure system with a minimum of 12 psi (82.7kPa) static pressure at the boiler.

Hot water piping should be supported by suitable hangers or floor stands. Do not support piping with this appliance. Due to expansion and contraction of copper pipe, consideration should be given to the type of hangers used. Rigid hangers may transmit noise through the system resulting from the piping sliding in the hangers. It is recommended that padding be used when rigid hangers are installed. Maintain 1" clearance to combustibles for hot water pipes.

Pipe the discharge of the relief valve (full size) to a drain or in a manner to prevent injury in the event of pressure relief. Install an air purger, an air vent, a diaphragm-type expansion tank, and a hydronic flow check in the system supply loop. Minimum fill pressure must be 12psig (82.7kPa). Install shutoff valves where required by code.

Suggested piping diagrams are shown in Figures 4 through 8. These diagrams are meant only as a guide. Components required by local codes must be properly installed.

NOTE: the recommended location of the temperature sensor on the diagrams; you must provide a location for the additional sensor shipped with the Copper Brute II. This sensor may be strapped onto pipe from 1" to 4" diameter, or inserted into an immersion well.

4.A.2 Cold Water Make-Up — Boiler

1. Connect the cold water supply to the inlet connection of an automatic fill valve.
2. Install a suitable back flow preventer between the automatic fill valve and the cold water supply.
3. Install shut off valves where required.

NOTE: The boiler, when used in connection with a refrigeration system, must be installed so the chilled medium is piped in parallel with the boiler with appropriate valves to prevent the chilled medium from entering the boiler.

The boiler piping system of a hot water heating boiler connected to heating coils located in air handling appliances where they may be exposed to refrigerated air circulation must be equipped with flow

control valves or other automatic means to prevent gravity circulation of the boiler water during the cooling cycle.

A boiler installed above radiation level, or as required by the authority having jurisdiction, must be provided with a low water cutoff device either as a part of the boiler or at the time of boiler installation.

4.A.3 Water Flow Requirements —Boiler

A hydronic heating (closed loop) application re-circulates the same fluid in the piping system. As a result, no new minerals or oxygen is introduced into the system. To ensure a proper operating temperature leading to long boiler life, a flow rate has been established based on the fluid temperature rise for this specific size boiler.

Pump-mounted boilers can be ordered for use in primary secondary piping systems. The pumps used are sized for the headloss through the heater, plus 30 feet (9.1m) of full-sized piping (same size as boiler outlet) and a normal number of fittings.

Table 8 specifies water flow rates for boilers, which will enable the user to size a pump. The headloss shown is for the heater only, and the user will need to add the headloss of the system piping to properly size the pump.

The minimum inlet water temperature for the Copper Brute II is 120°F (49°C) to avoid condensing on the copper coils.

4.A.4 Water Flow Requirements — Low Temperature Copper Brute II Boilers

are equipped with a mounted pump. The pumps are sized for the boiler's head loss and 30 feet of full-size piping (same size as boiler outlet), with a normal number of fittings. The boilers must be piped in a primary-secondary system, such that the boiler's pump only serves the boiler. Figure 6 and Figure 7 show examples of this type of piping.

The minimum inlet water temperature to the Copper Brute II is 70°F (20°C). The mixing system on the Copper Brute II will ensure that the heat exchanger in the Copper Brute II does not see water that is less than 120°F (49°C), so that excessive condensation does not form on the heat exchanger.

Table 8 shows a relationship between water flow through the boiler and the temperature difference (rise) between the inlet and outlet of the boiler. This table will enable the user to test the boiler for proper water flow. Since the boiler has a mixing system that sends a portion of the hot water from the boiler outlet to the boiler inlet, the water flow coming out of the mixing system will vary, depending on the return water temperature.

SIZE	20°F		25°F		30°F		35°F	
	flow gpm	H/L feet	flow gpm	H/L feet	flow gpm	H/L feet	flow gpm	H/L feet
500	43	1.7	34	1.1	28	0.9	24	0.7
750	64	3.3	51	2.3	43	1.7	36	1.2
1000	85	5.0	68	3.6	57	3.1	49	2.2
1250	106	8.1	85	6.1	71	4.7	61	3.4
1500	128	10.0	102	7.2	85	5.5	73	4.2
1750	N/R	N/R	119	10.5	99	8.4	85	5.8
2000	N/R	N/R	136	12.5	113	10.4	97	8.3
Metric Equivalent								
SIZE	11°C		14°C		17°C		19°C	
	flow lpm	H/L m	flow lpm	H/L m	flow lpm	H/L m	flow lpm	H/L m
500	161	0.5	129	0.3	107	0.3	92	0.2
750	241	1.0	193	0.7	161	0.5	138	0.4
1000	321	1.5	257	1.1	214	0.9	184	0.7
1250	401	2.5	322	1.9	269	1.4	231	1.0
1500	483	3.0	386	2.2	322	1.7	276	1.3
1750	N/R	N/R	451	3.2	375	2.6	322	1.8
2000	N/R	N/R	515	3.8	429	3.2	368	2.5
<p>Notes: gpm = gallons per minute, lpm = liters per minute, H/L = headloss, ft = headloss in feet, m = headloss in meters. Maximum temperature rise is 35°F (19°C), as shown. Headloss is for boiler's heat exchanger only. N/R = not recommended.</p>								

Table 8. Water Flow Requirements - Boiler.

4.A.5 Freeze Protection — Boiler

Boiler installations are not recommended in areas where the danger of freezing exists unless proper precautions are made for freeze protection. A non toxic, heating system, anti-freeze may be added to the hydronic system provided that the concentration does not exceed 50% and the anti freeze contains an anti foamant. When a 50/50 mixture is used, increase the water flow requirements by 15%, and increase the headloss requirements by 20%.

Power outage, interruption of gas supply, failure of system components, activation of safety devices, etc., may prevent a boiler from firing. **Any time a boiler is subjected to freezing conditions, and the boiler is not able to fire, and/or the water is not able to circulate, there is a risk of freezing in the boiler or in the pipes in the system.** When water freezes, it expands. This can result in bursting of pipes in the system, or damage to the boiler, which could result in leaking or flooding conditions.

IMPORTANT NOTES: Different glycol products may provide varying degrees of protection. Glycol products must be maintained properly in a heating system, or they may become ineffective. Consult the glycol specifications, or the glycol manufacturer, for information about specific products, maintenance of solutions, and set up according to your particular conditions.

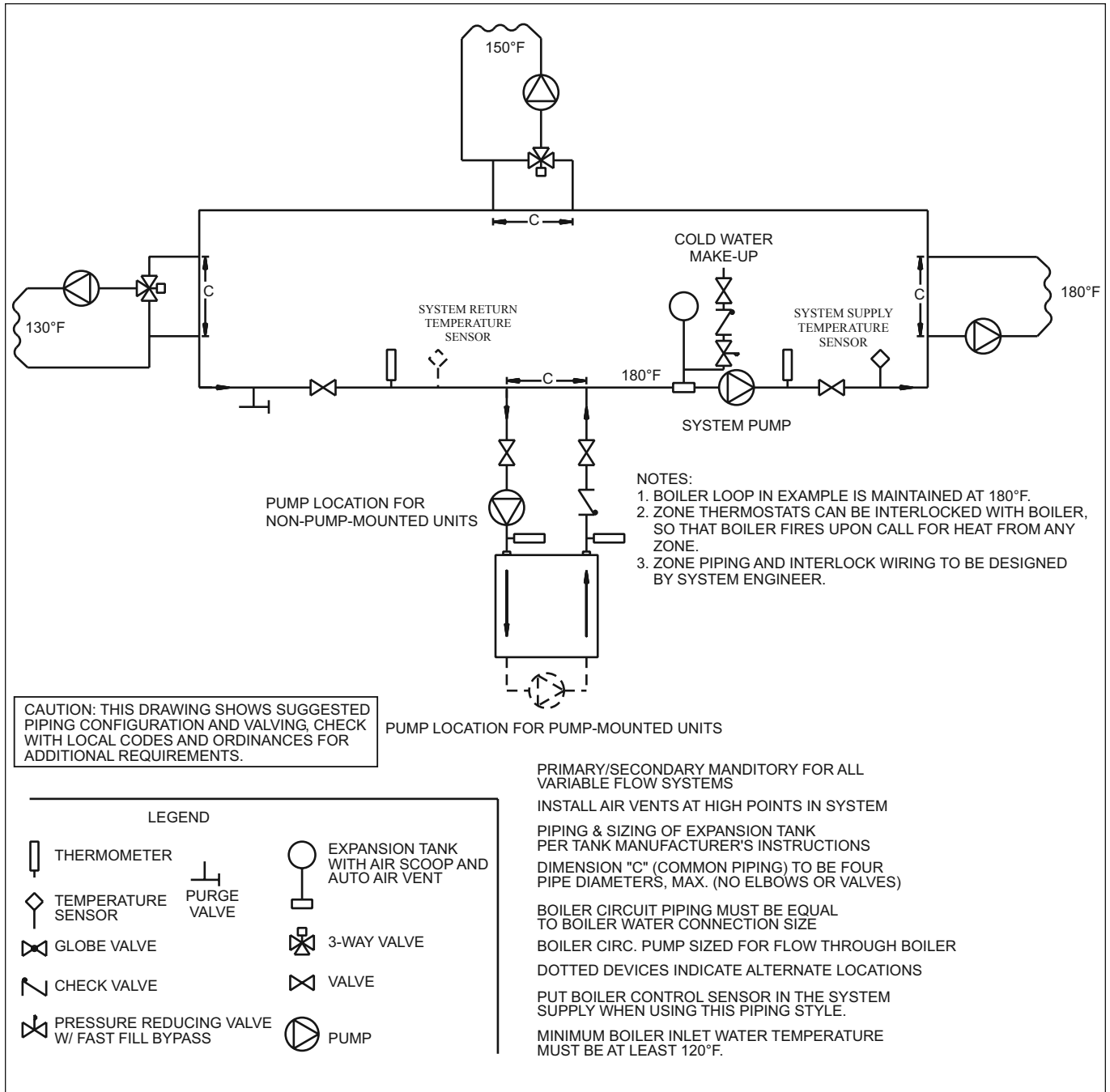

Figure 5. Hydronic Piping — One Boiler, Multi-Temperature System.

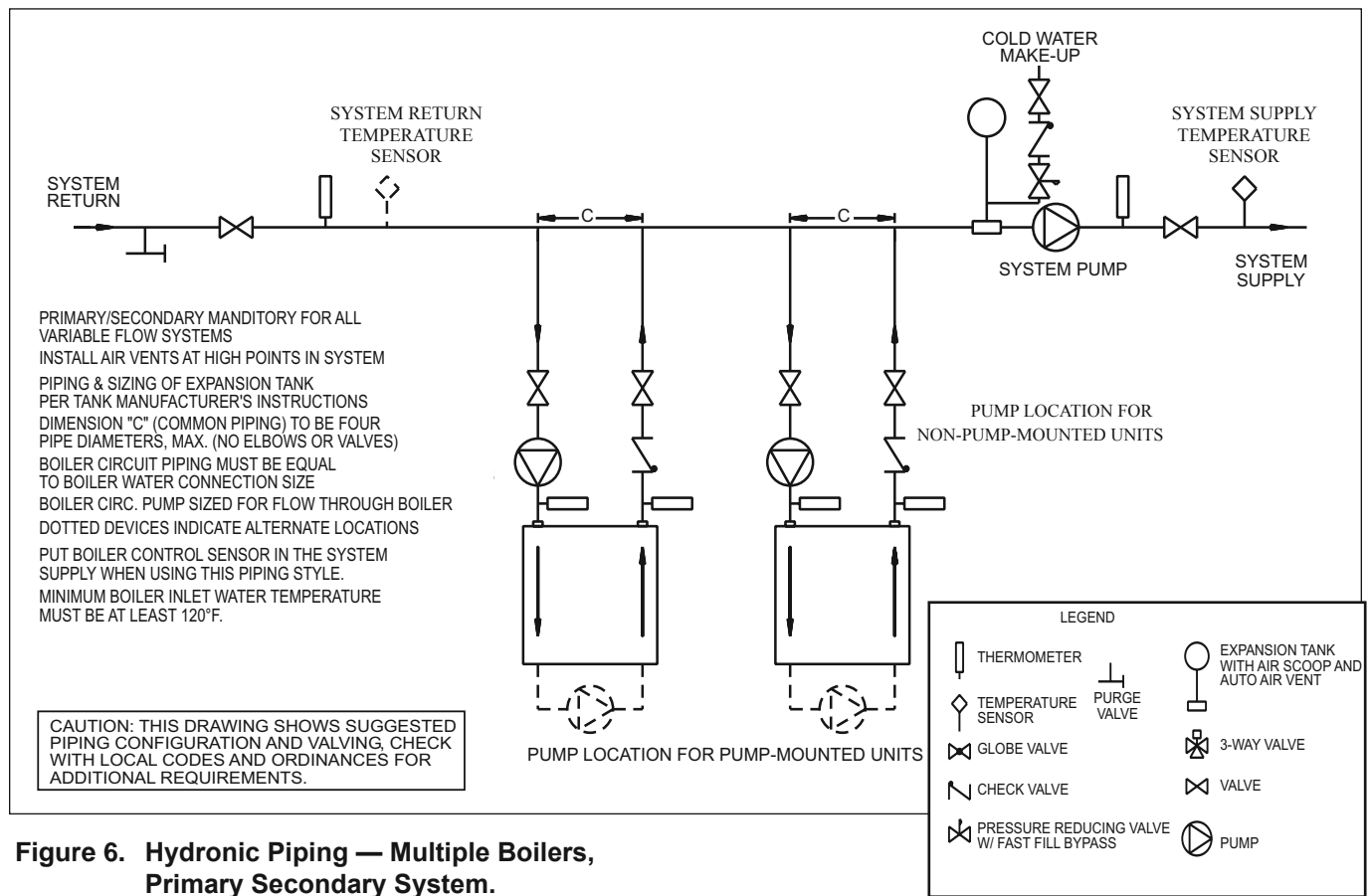

Figure 6. Hydronic Piping — Multiple Boilers, Primary Secondary System.

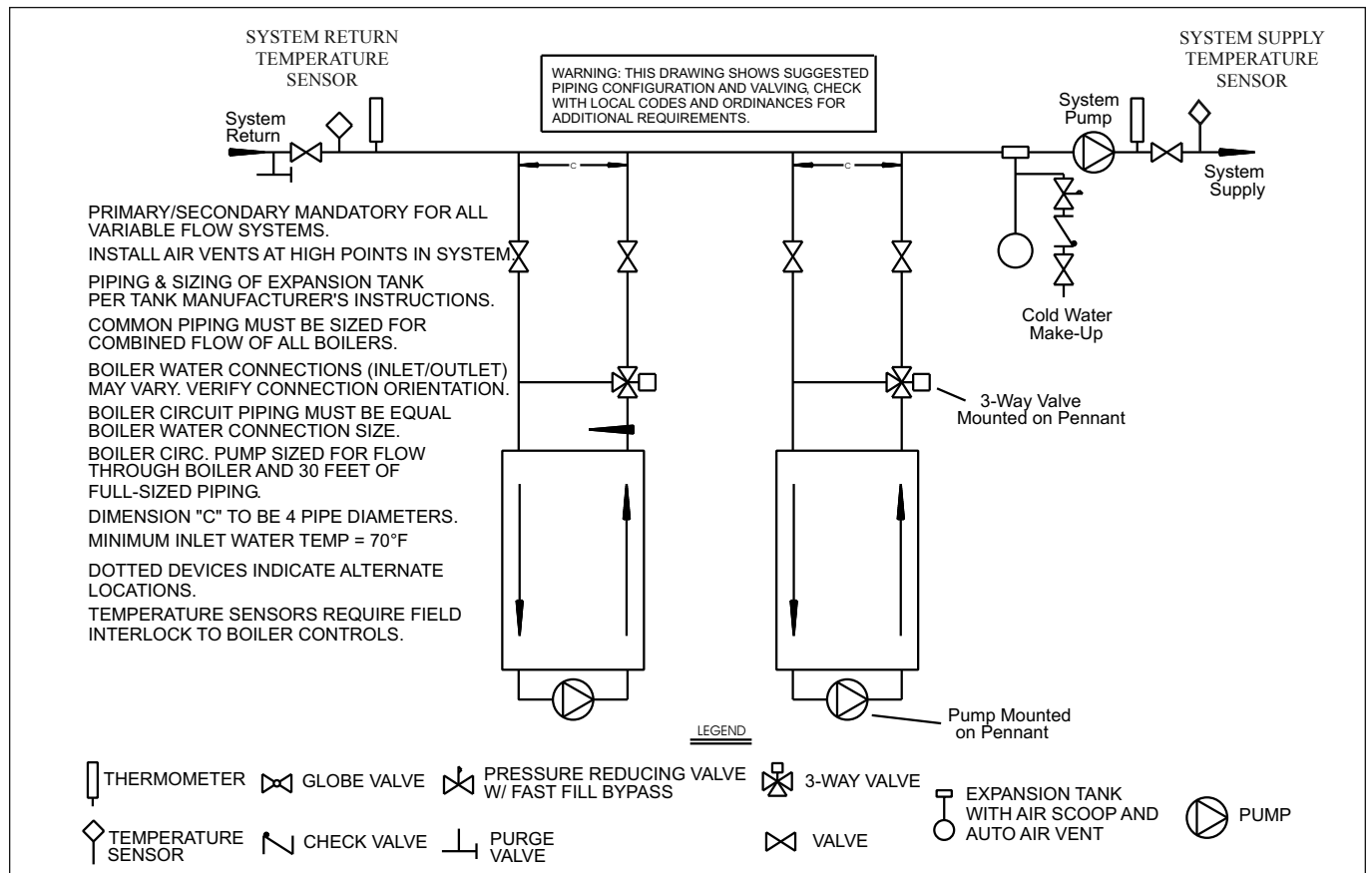

Figure 7. Suggested Piping, Low Temperature, Primary - Secondary System.

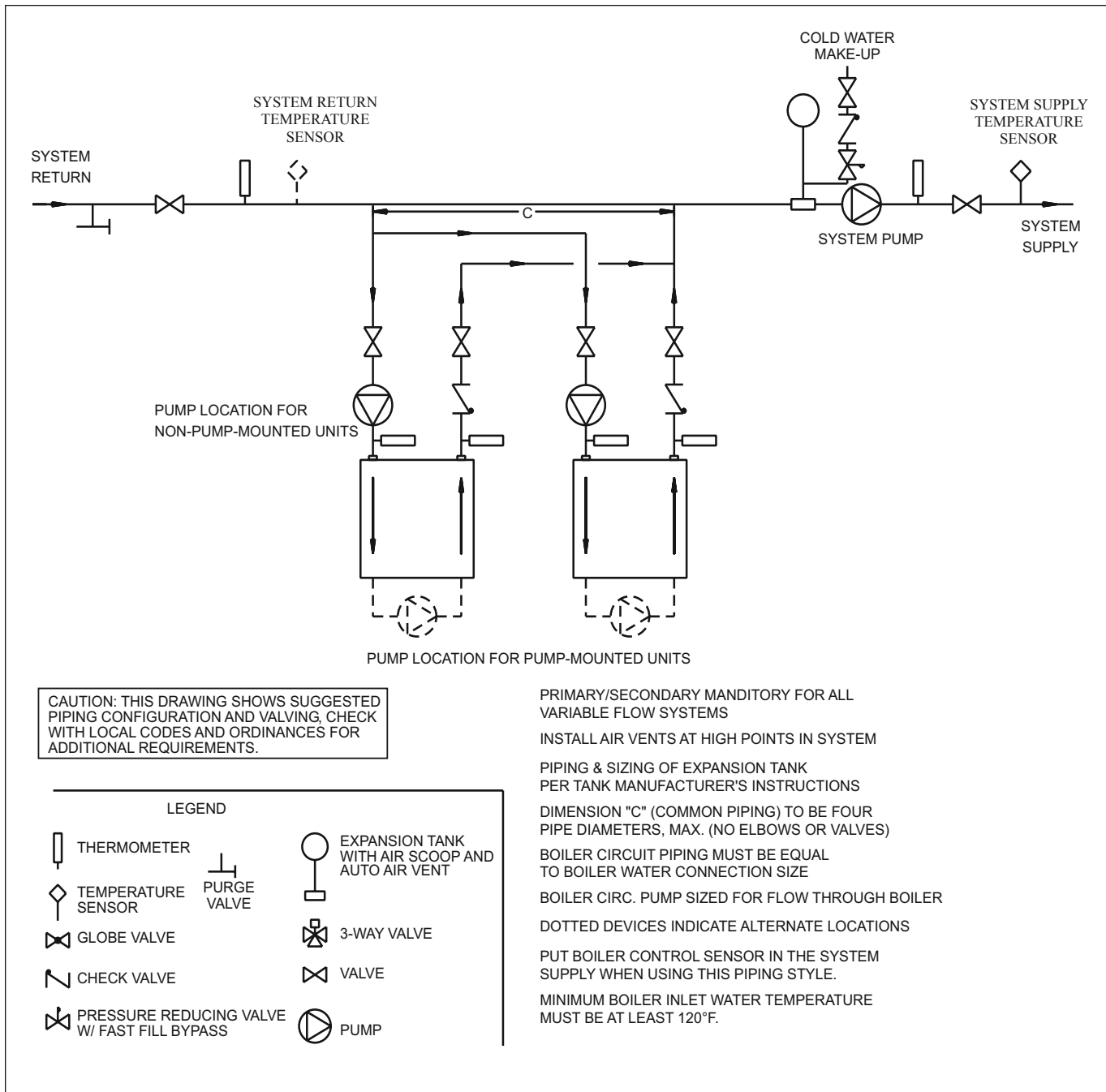

Figure 8. Hydronic Piping - Primary-Secondary, Reverse-Return.

4.A.6 Filling the Boiler System

1. Ensure the system is fully connected. Close all bleeding devices and open make-up water valve. Allow system to fill slowly.
2. If make-up water pump is employed, adjust pressure switch on pumping system to provide a minimum of 12 psi (81.8 kPa) at the highest point in the heating loop.
3. If a water pressure regulator is provided on the make-up water line, adjust the pressure regulator to provide at least 12 psi (81.8 kPa) at the highest point in the heating loop.
4. Open bleeding devices on all radiation units at the high points in the piping throughout the system, unless automatic air bleeders are provided at such points.
5. Run system circulating pump for a minimum of 30 minutes with the boiler shut off.
6. Open all strainers in the circulating system, check flow switch operation, and check for debris. If debris is present, clean out to ensure proper circulation.
7. Recheck all air bleeders as described in Step 4.

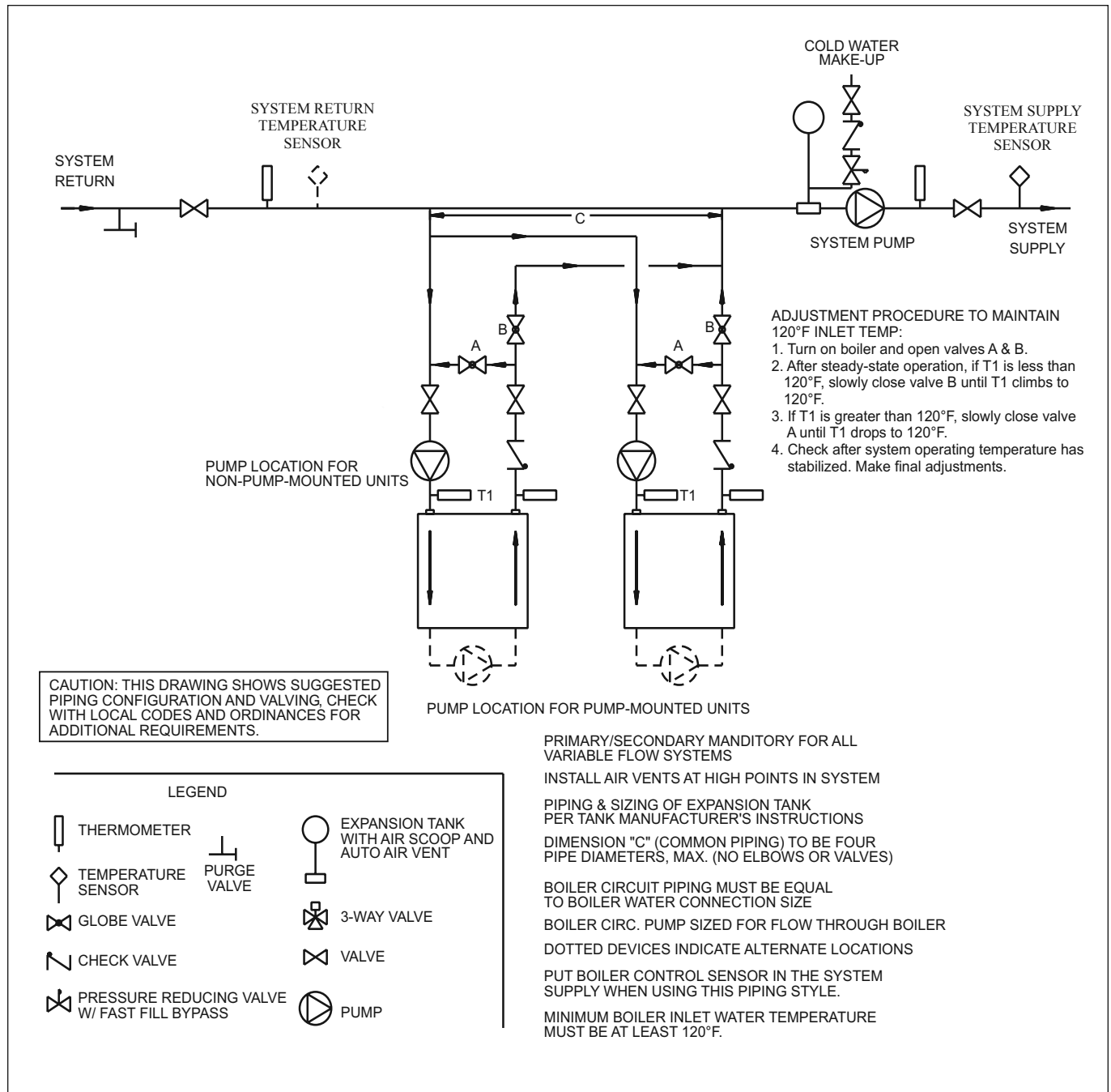

Figure 9. Hydronic Piping - Primary-Secondary, Reverse-Return, Low Temperature.

8. Check liquid level in expansion tank. With the system full of water and under normal operating pressure, the level of water in the expansion tank should not exceed $\frac{1}{4}$ of the total, with the balance filled with air.
9. Start up boiler according to the procedure in this manual. Operate the entire system, including the pump, boiler, and radiation units for one (1) hour.
10. Recheck the water level in the expansion tank. If the water level exceeds $\frac{1}{4}$ of the volume of the expansion tank, open the tank drain, and drain to that level.
11. Shut down the entire system and vent all radiation units and high points in the system piping, as described in Step 4.
12. Close make-up water valve and check strainer in pressure-reducing valve for sediment or debris from the make-up water line. Reopen make-up water valve.
13. Check gauge for correct water pressure and also check water level in the system. If the height indicated above the boiler insures that water is at the highest point in the circulating loop, then the system is ready for operation.

14. Refer to local codes and the make-up water valve manufacturer's instructions as to whether the make-up water valve should be left open or closed.
15. After placing the unit in operation, the ignition system safety shutoff device must be tested. First, shut off the manual gas valve, and call the unit for heat. After the pre-purge and ignitor heat-up time, the main gas terminals will be energized, attempting to light, for four (4) seconds, and then will de-energize. The unit will go into lockout mode. Second, turn the power off and then on again, open the manual gas valve and allow the unit to light. While the unit is operating, close the manual gas valve and ensure that power to the main gas valve has been cut.
16. Within three (3) days of start-up, recheck all air bleeders and the expansion tank as described in Steps 4 and 8 above.

Important: The installer is responsible for identifying to the owner/operator the location of all emergency shutoff devices.

⚠ WARNING

Do not use this appliance if any part has been under water. Immediately call a qualified service technician to inspect the appliance and to replace any part of the control system and any gas control that may have been under water.

4.B Water Heaters

4.B.1 Water System Piping —Water Heater

Hot water piping should be supported by suitable hangers or floor stands. Do not support piping with this appliance. Due to expansion and contraction of copper pipe, consideration should be given to the type of hangers used. Rigid hangers may transmit noise through the system resulting from the piping sliding in the hangers. It is recommended that padding be used when rigid hangers are installed.

The Copper Brute II can be used with several different types of readily available storage tanks. A pump draws water from the storage tank and pumps the water through the heater and back into the tank. Pump-mounted units have a circulating pump built into the water heater. The pumps used are sized for the headloss through the heater, plus 30 feet (9.1m) of full-sized piping (same size as boiler outlet) and a normal number of fittings. Pumps used on pump-mounted unit are sized for soft/normal or hard water, so make sure a pump-mounted unit matches the water quality of the installation.

Pipe the outlet from the heater's relief valve such that any discharge from the relief valve will be conducted to a suitable place for disposal when relief occurs. Do not reduce line size or install any valves in this line. The line must be installed to allow complete drainage of both the valve and the line.

Suggested piping diagrams are shown in Figures 9 through 12. These diagrams are meant only as a guide. Components required by local codes must be properly installed.

Note the recommended location of the temperature sensor on the diagrams. The Copper Brute II is shipped with an additional sensor that can be used the storage tank, in lieu of a separate tank thermostat, or for more full-featured domestic water heating control. To get these features, you must provide a location for the additional sensor. It can be strapped to a pipe from 1" to 4" diameter, or inserted into a tank immersion well.

The minimum inlet water temperature for a Copper Brute II Boiler / Water Heater is 120°F (49°C) to avoid condensing on the copper coils.

The minimum inlet water temperature for the Low-Temp Copper Brute II is 70°F (20°C). The mixing system on the Copper Brute II will ensure that the heat exchanger in the Copper Brute II does not see water that is less than 120°F (49°C), so that excessive condensation does not form on the heat exchanger.

4.B.2 Hot Water Supply Piping —Water Heater

Follow the tank manufacturer's guidelines for completion of the hot water system connections.

NOTE: A listed temperature and pressure relief valve listed as complying with the Standard for Relief Valves and Automatic Gas Shutoff Devices for Hot Water Supply Systems (ANSI Z21.22 / CSA 4.4) of suitable discharge capacity must be installed in the separate storage tank system.

If the Copper Brute II water heater is installed in a closed water supply system, such as one having a backflow preventer in the cold water supply line, the relief valve may discharge periodically, due to thermal expansion. Means (such as a properly-sized expansion tank) shall be provided to control thermal expansion. Contact the water supplier or local plumbing inspector on how to control this situation.

4.B.3 Water Flow Requirements —Water Heater

In a water heating application (an open system), new water is constantly being introduced. With the new water comes a fresh supply of minerals that can be deposited on the unit's heat exchanger. This is commonly known as scaling. The amount of minerals will depend upon the hardness of the water. Water can also be aggressive, and can erode metals, including copper, if the water is moved too quickly. The water flow requirements for the Copper Brute II water heater are based upon the hardness of the water. The water flow is kept high enough to prevent scaling, but low enough to prevent tube erosion. For extremely soft or hard water, cupro-nickel tubes are available. Contact a Bradford White Representative if you have questions or concerns about water quality.

Pump-mounted water heaters can be ordered with standard pumps for soft or normal water or with pumps for hard water. The pumps used are sized for the headloss through the heater, plus 30 feet (9.1m) of full-sized piping (same size as heater outlet) and a normal number of fittings.

Table 9 on page 30 specifies water flow rates for water heaters, which will enable the user to size a pump. The headloss shown is for the heater only, and the user will need to add the headloss of the piping system to properly size the pump.

4.B.4 Combined Water Heating (potable) and Space Heating — Water Heater

NOTE: These systems are not allowed in the Commonwealth of Massachusetts.

Piping and components connected to this water heater for the space heating application shall be suitable for use with potable water.

Toxic chemicals, such as used for boiler treatment, shall not be introduced into the potable water used for space heating.

This water heater when used to supply potable water shall not be connected to any heating system or component(s) previously used with a non-potable water heating appliance.

When the system requires water for heating at temperatures higher than required for other uses, an anti-scald mixing or tempering valve shall be installed to temper the water for those uses in order to reduce scald hazard potential.

4.B.5 Freeze Protection – Water Heater

Although Copper Brute II water heaters are design-certified for outdoor installations, such installations are not recommended in areas subject to freezing temperatures, unless proper precautions are taken.

Power outage, interruption of gas supply, failure of system components, activation of safety devices, etc., may prevent a heater from firing. **Any time a heater is subjected to freezing conditions, and the heater is not able to fire, and/or the water is not able to circulate, there is a risk of freezing in the heater or in the pipes in the system.** When water freezes, it expands. This can result in bursting of pipes in the system, or damage to the heater, which could result in leaking or flooding conditions.

Contact the local factory representative or Bradford White for additional information.

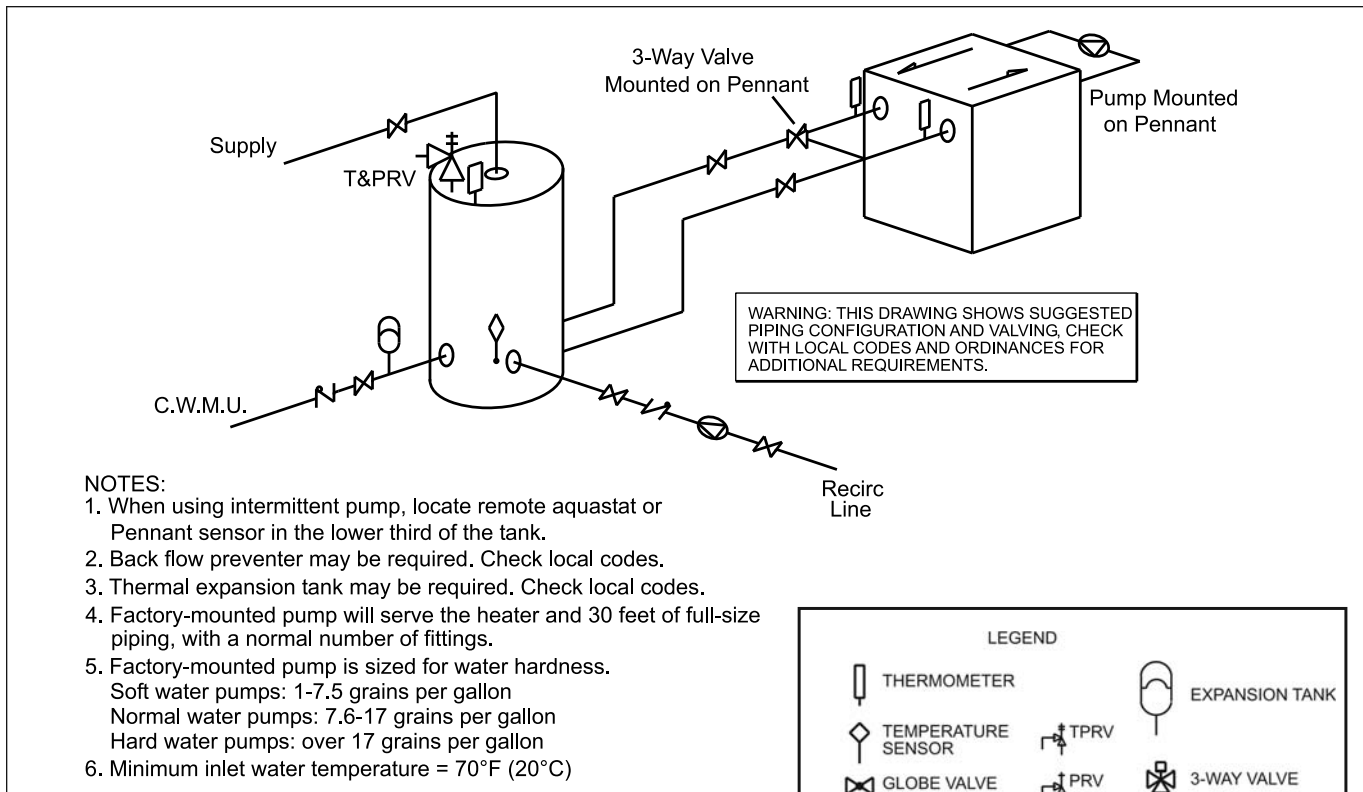

Figure 10. Water Heater Piping, Low Temperature System — One Heater, One Tank.

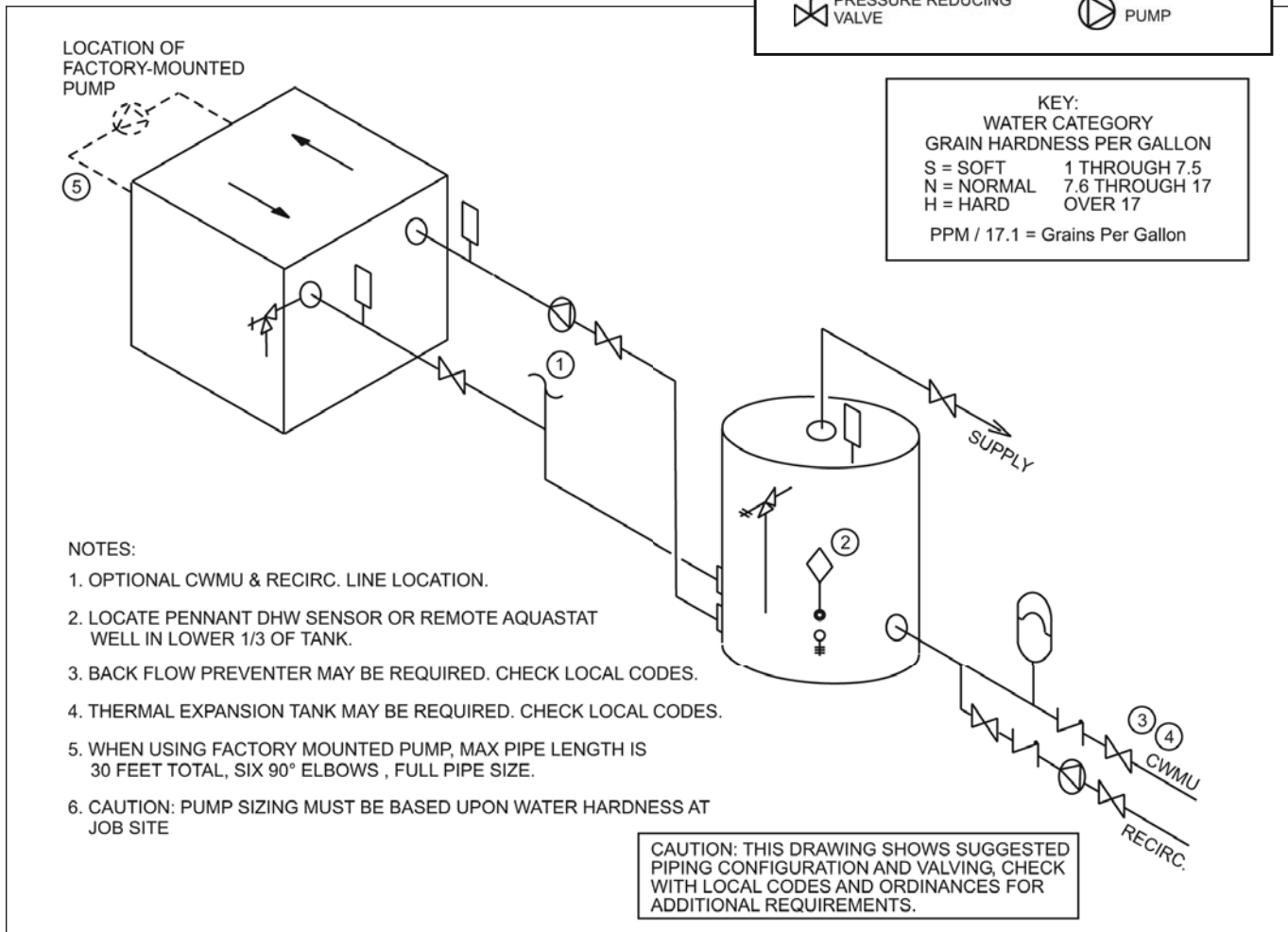
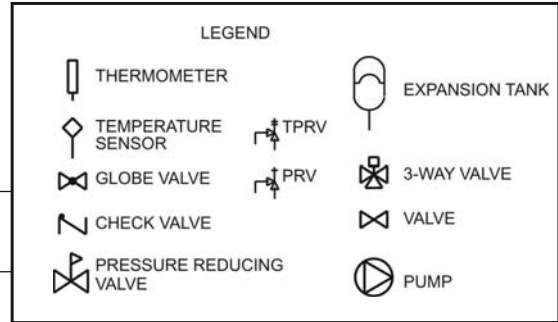

Figure 11. Water Heater Piping — One Heater, One Tank.

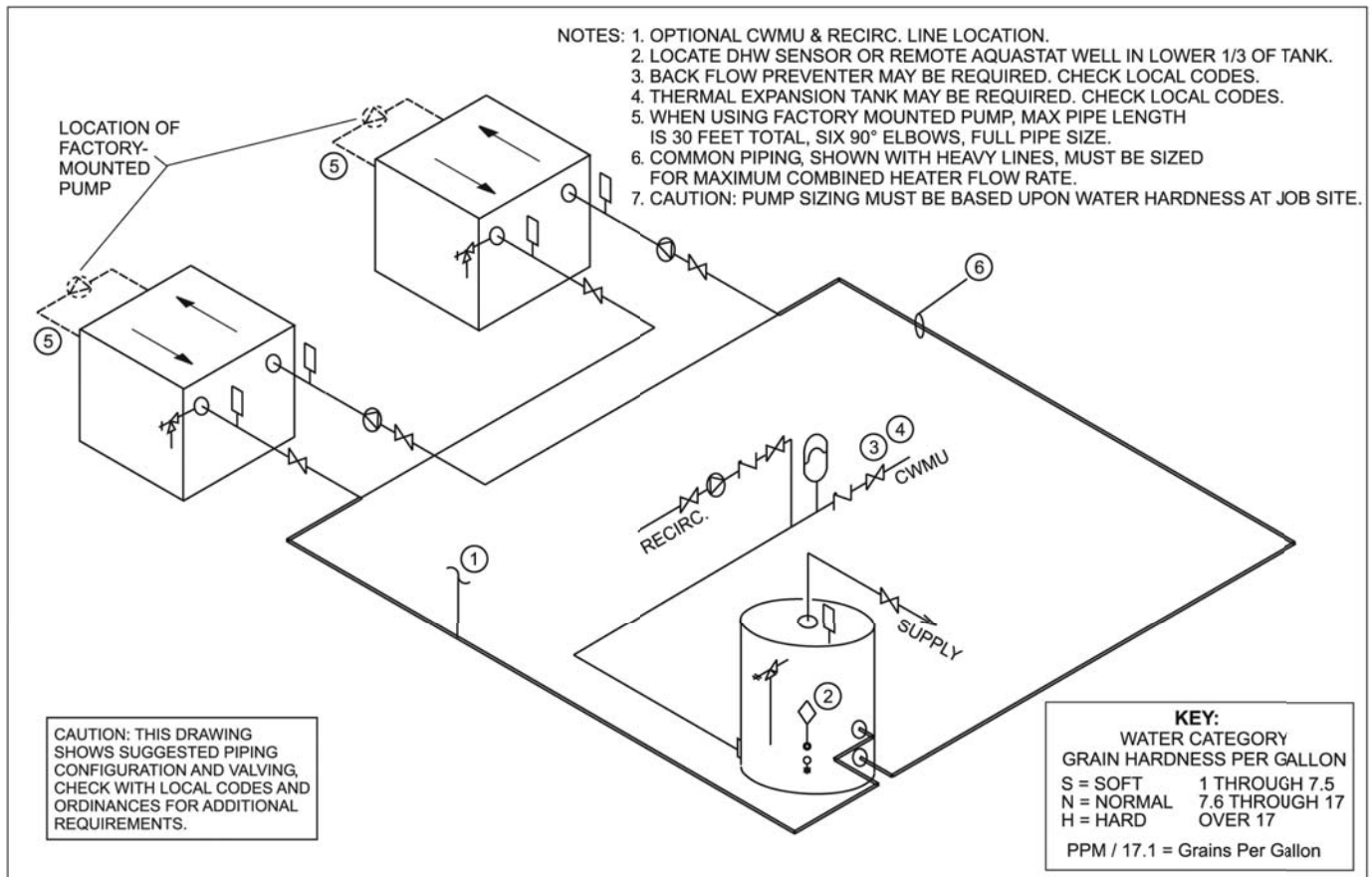

Figure 12. Water Heater Piping — Multiple Heaters, One Tank.

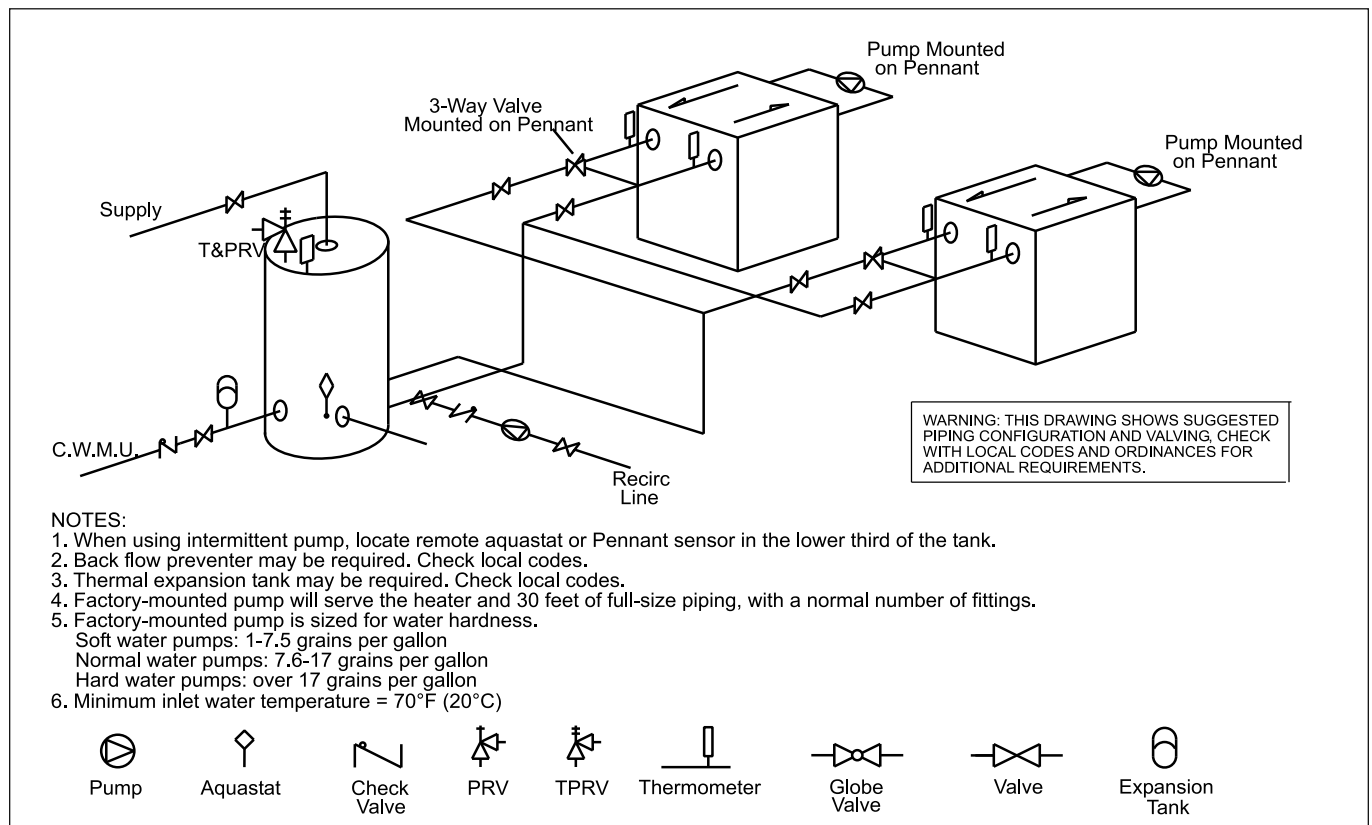

Figure 13. Suggested Piping, Low Temp System — Multiple Water Heaters, One Tank.

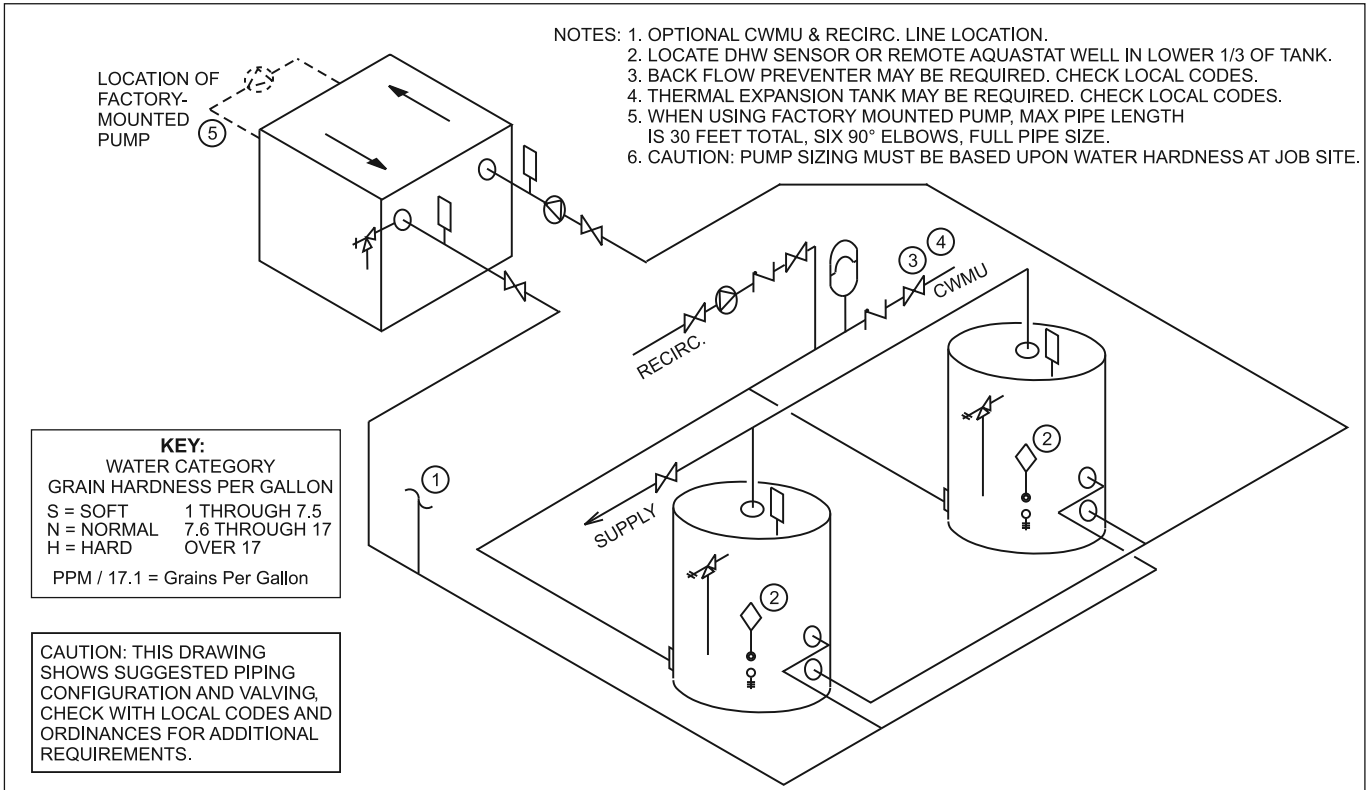

Figure 14. Water Heater Piping — One Heater, Multiple Tanks.

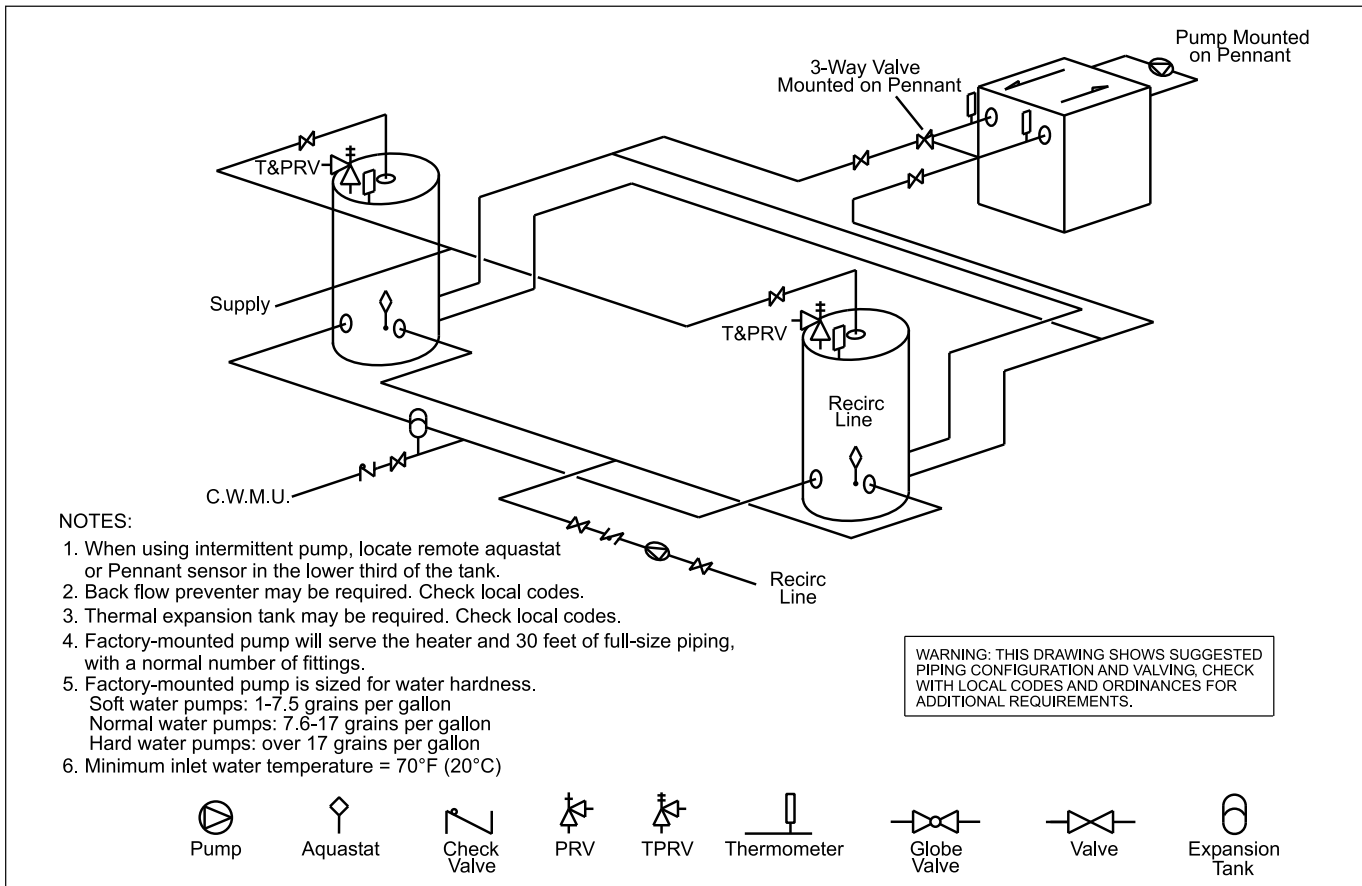

Figure 15. Suggested Piping, Low Temp System — One Water Heater, Multiple Tanks.

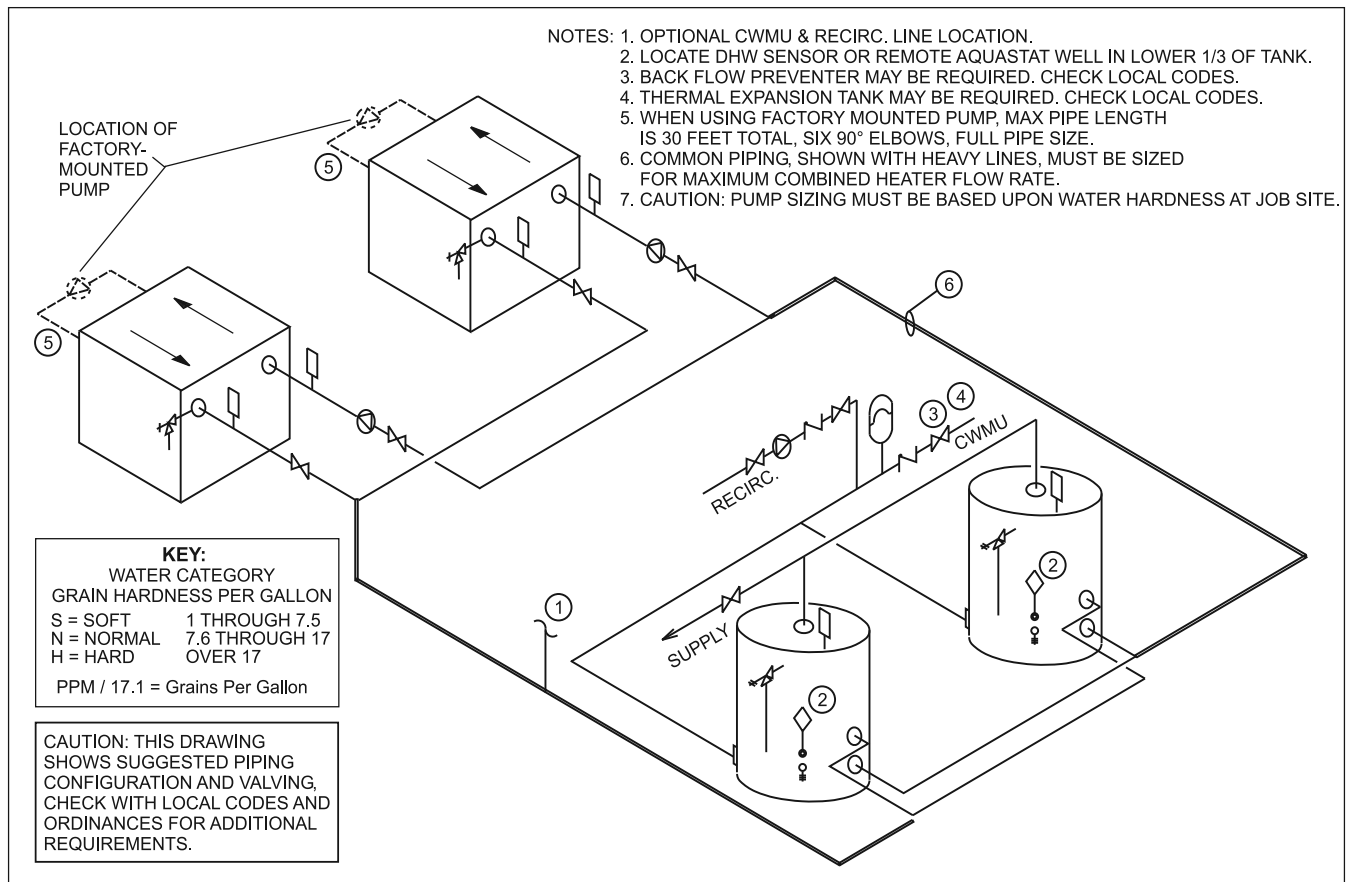

Figure 16. Water Heater Piping — Multiple Heaters, Multiple Tanks.

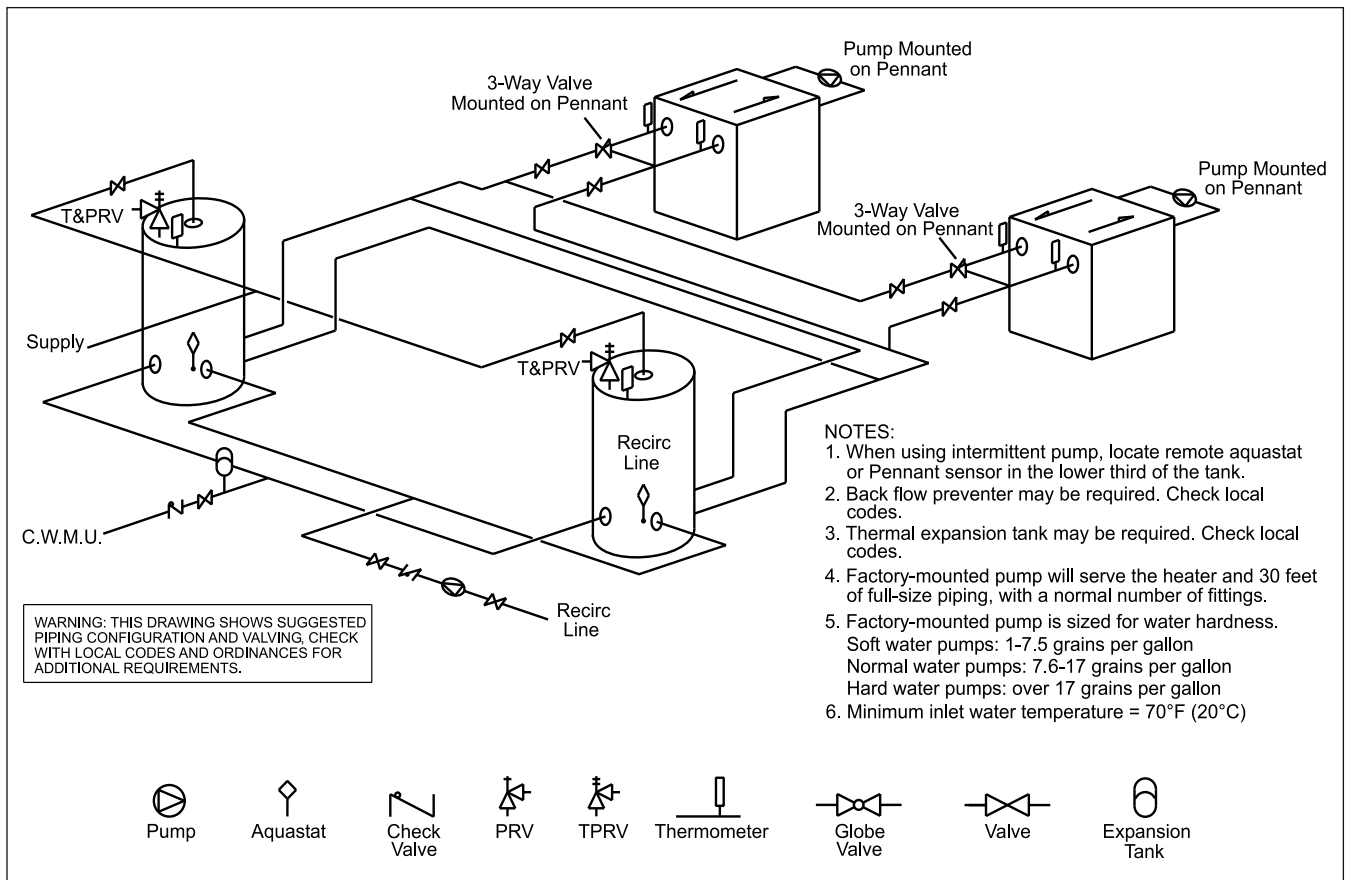

Figure 17. Suggested Piping, Low Temperature — Multiple Water Heaters, Multiple Tanks.

SIZE	GPM			FT			TEMP RISE °F			LPM			M			TEMP RISE °C		
	S	N	H	S	N	H	S	N	H	S	N	H	S	N	H	S	N	H
500	45	68	90	1.8	2.3	3.5	19	13	9	170	257	341	0.5	0.7	1.1	10	7	5
750	45	68	90	2.1	3.0	6.0	28	19	14	170	257	341	0.6	0.9	1.8	16	10	8
1000	45	68	90	2.3	3.6	6.1	38	25	19	170	257	341	0.6	1.1	1.9	21	14	10
1250	68	68	90	3.8	3.8	6.3	31	31	24	257	257	341	1.2	1.2	1.9	17	17	13
1500	68	68	90	3.9	3.9	6.5	38	38	28	257	257	341	1.2	1.2	2.0	21	21	16
1750	68	68	90	4.0	4.0	6.7	44	44	33	257	257	341	1.2	1.2	2.0	24	24	18
2000	112	112	112	10.0	10.0	10.0	30	30	30	424	424	424	3.0	3.0	3.0	17	17	17

NOTES:

1. S = soft water (1 to 7.5 grains hardness)
2. N = normal water (7.6 to 17 grains hardness)
3. H = hard water (more than 17 grains hardness)
4. gpm = gallons per minutes, lpm = liters per minute, ft = headless in feet, m = headloss in meters
5. Headloss is for heater's heat exchanger only

Table 9. Water Flow Requirements – Heater.

4.B.6 Filling the Water Heater System

1. Ensure the system is fully connected. Close all bleeding devices and open make-up water valve. Allow system to fill slowly.
2. If make-up water pump is employed, adjust pressure switch on pumping system to provide a minimum of 12 psi (81.8 kPa) at the highest point in the heating loop.
3. If a water pressure regulator is provided on the make-up water line, adjust the pressure regulator to provide at least 12 psi (81.8 kPa) at the highest point in the heating loop.
4. Open bleeding devices on all radiation units at the high points in the piping throughout the system, unless automatic air bleeders are provided at such points.
5. Run system circulating pump for a minimum of 30 minutes with the boiler shut off.
6. Open all strainers in the circulating system, check flow switch operation, and check for debris. If debris is present, clean out to ensure proper circulation.
7. Recheck all air bleeders as described in Step 4.
8. Check liquid level in expansion tank. With the system full of water and under normal operating pressure, the level of water in the expansion tank should not exceed $\frac{1}{4}$ of the total, with the balance filled with air.
9. Start up the water heater according to the procedure in this manual. Operate the entire system, including the pump, boiler, and radiation units for one (1) hour.
10. Recheck the water level in the expansion tank. If the water level exceeds $\frac{1}{4}$ of the volume of the expansion tank, open the tank drain, and drain to that level.
11. Shut down the entire system and vent all radiation units and high points in the system piping, as described in Step 4.
12. Close the make-up water valve and check strainer in pressure reducing valve for sediment or debris from the make-up water line. Reopen make-up water valve.

13. Check gauge for correct water pressure and also check water level in the system. If the height indicated above the boiler insures that water is at the highest point in the circulating loop, then the system is ready for operation.
14. Refer to local codes and the make-up water valve manufacturer's instructions as to whether the make-up water valve should be left open or closed.
15. After placing the unit in operation, the ignition system safety shutoff device must be tested. First, shut off the manual gas valve, and call the unit for heat. After the pre-purge and ignitor heat-up time, the main gas terminals will be energized, attempting to light, for four (4) seconds, and then will de-energize. The unit will go into lockout mode. Second, turn the power off and then on again, open the manual gas valve and allow the unit to light. While the unit is operating, close the manual gas valve and ensure that power to the main gas valve has been cut.
16. Within three (3) days of start-up, recheck all air bleeders and the expansion tank as described in Steps 4 and 8 above.

Important: The installer is responsible for identifying to the owner/operator the location of all emergency shutoff devices.

WARNING

Do not use this appliance if any part has been under water. Immediately call a qualified service technician to inspect the appliance and to replace any part of the control system and any gas control that may have been under water.

SECTION 5 Electrical Connections

5.A Installation Warnings

⚠ WARNING

This appliance must be electrically grounded in accordance with the requirements of the authority having jurisdiction or, in the absence of such requirements, with the latest edition of the National Electrical Code, ANSI/NFPA 70, in the U.S. and with the latest edition of CSA C22.1 Canadian Electrical Code, Part 1, in Canada. Do not rely on the gas or water piping to ground the metal parts of the boiler. Plastic pipe or dielectric unions may isolate the boiler electrically. Service and maintenance personnel, who work on or around the boiler may be standing on wet floors could be electrocuted by an ungrounded boiler. Electrocution can result in severe injury or death.

Single pole switches, including those of safety controls and protective devices, must not be wired in a grounded line.

All electrical connections are made at the power terminals, which are located at the rear of the appliance, or at the input/output terminal strips which are located on the right side of the appliance.

All internal electrical components have been prewired. No attempt should be made to connect electrical wires to any other location except the terminal blocks.

5.B.2 Pump Power

The pump circuit is identified by three 12 AWG wires: black with a white stripe (L2), white (N2), and green (Ground).

If desired, an installer can change the pump mounted single service units to use a separate circuit for the pump. Instructions to make this change are found in the next Section.

Over Current Recommendations (Amps)				
Pennant			Pump Only	
Size	Without Pump	With Pump	Taco	B & G
500	15	20	15	15
750	15	20	15	15
1000	20	25 – Taco 30 – B & G	15	15
1250	25	30	15	15
1500	25	30	15	15
1750	25	–	15	20
2000	25	–	20	20

Table 10. Circuit Protection

5.B Line Voltage Connections

Incoming power must be protected by the appropriate circuit breaker (fuse) and installed by a qualified electrician or authorized/qualified personnel. Recommended over current protection ratings are shown in Table 3 on page 11.

5.B.1 Main Power

All non-pump mounted Copper Brute IIs require a single 120-volt supply. Pump mounted Copper Brute II sizes 500-1500 also use a single 120-volt supply, and Copper Brute II sizes 1750-2000 require two separate 120-volt supplies.

Copper Brute II sizes 500-1500 main power (L1, N1, and Ground) shall be connected to the three wires supplied. This main power circuit is identified by three solid colored wires (10 AWG) – black (L1), white (N1), and green (Ground).

Copper Brute II sizes 1750-2000 main power (L1, N1, and Ground) is identified by three solid colored wires (10 AWG) – black (L1), white (N1), and green (Ground). The pump circuit is identified by three 12 AWG wires, as outlined in the next Section.

5.B.3 Boiler/Heater Pump

Conversion to a separate pump circuit requires bringing in a separate circuit for the pump and removing the three jumper wires within the internal wiring of the 120-volt portion of the Copper Brute II (see Figure 3). This action should only be performed by qualified personnel, with the power disconnected from the unit.

To rewire the pump circuit, bring in a separate 120-volt circuit (L2, N2, and Ground). Remove the jumper wires shown in Figure 3. Connect the incoming line voltage (L2) to the main power switch using a ¼” female insulated push on terminal. From the other side of the main power switch, connect to the main power terminal block, in the rear of the unit, using a ¼” female insulated push on terminal. This will be in the same position where the line voltage jumper terminated. Connect N2 and Ground to the main terminal block, in the rear of the unit, using ¼” female insulated push terminals. These connections will also be the same positions where the neutral and ground jumpers were terminated.

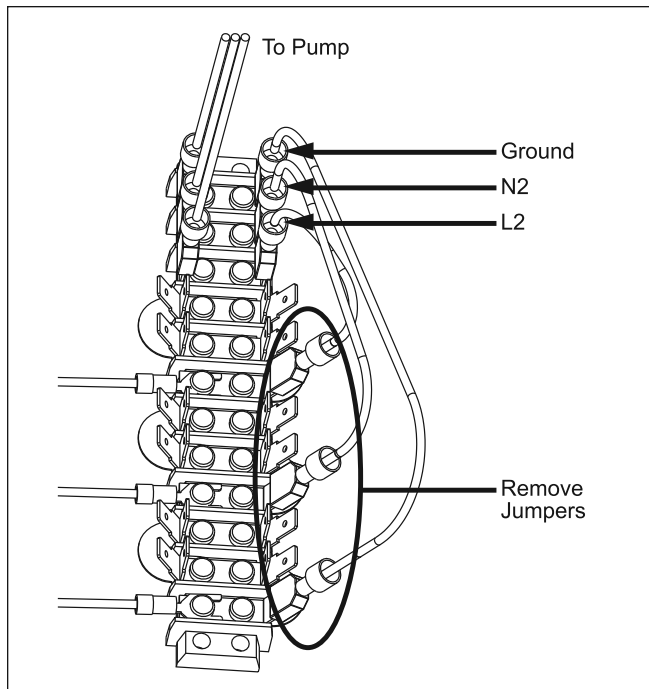

Figure 18. Removing Jumpers.

5.B.4 Auxiliary Power Output

The Auxiliary Power Output, if used, is controlled by Field Input 2. When Field Input 2 is closed, line voltage is supplied at terminal 7 and neutral on terminal 8 of the output terminal strip. This output is rated for 250VAC, 2.5A maximum.

5.C Low Voltage Connections

Route all wires through the knockouts on the right side of the Copper Brute II. Connect low voltage wiring to the input and output terminals shown in Figure 19. Connect all wiring as shown on the wiring diagram.

5.C.1 Field Wiring - Inputs

5.C.1.a Safety Interlocks

Field Interlock: If the Field Interlock is utilized, remove the jumper from the terminals 1 and 2 of the input terminal strip and wire the interlock to these terminals. Only dry contacts can be connected to the Field Interlock terminals.

NOTE: Safety chain voltage is 24VDC.

5.C.1.b Boiler/Heater Heat Demands

CH1/DHW1: Connect the thermostat/aquastat or end switch (isolated contact only) wires to terminals 3 and 4 of the input terminal strip.

CH2/DHW2: Connect an additional thermostat/aquastat or end switch (isolated contact only) wires to terminals 7 and 8 of the input terminal strip.

DHW/DHW3: Connect the aquastat or end switch (isolated contact only) wires to terminals 5 and 6 of the input terminal strip. If preferred, a DHW tank sensor can be used in lieu of an aquastat to generate a heat demand, refer to Section 5.C.1.d.

NOTE: The heat demand contacts must be dry contacts. The Copper Brute II controller heat demand voltage is 24VDC.

5.C.1.c Field Inputs (Open/Closed)

Field Input 1: Field Input 1, if used, is connected across terminals 9 and 10 of the input terminal strip. When connected, Field Input 1 controls the Auxiliary Dry Contact. If Field Input 1 is open, the Auxiliary Dry Contact is open. If Field Input 1 is closed, the Auxiliary Dry Contact is closed. Only dry contacts can be connected to Field Input 1.

Field Input 2: Field Input 2, if used, is connected across terminals 11 and 12 of the input terminal strip. When connected, Field Input 2 controls the Auxiliary Power Output. If Field Input 2 is open, the Auxiliary Power Output is off. If Field Input 2 is closed, the controller turns power on at the Auxiliary Power Output.

NOTE: The controller applies 24VDC to the Field Inputs to detect the status of the contacts.

5.C.1.d Temperature Sensors

System Supply: The system supply sensor, if used, is connected to terminals 14 and 15 of the input terminal strip. When connected, the controller automatically detects the presence of this sensor. If installed, the Copper Brute II controls the staging of the burners to maintain the system supply temperature to the heat demand set point. The system supply temperature is shown on the home screen above the red system input arrow, see Figure 25 on page 40. This sensor is supplied loose with the Copper Brute II and is installed in the piping or tank per the suggested piping diagrams.

System Return: The system return sensor, if used, is connected to terminals 16 and 17 of the input terminal strip. When connected, the controller automatically detects the presence of this sensor. There is no control logic associated with this sensor. When connected, this temperature is shown on the home screen above the blue system output arrow. This sensor is supplied loose with the Copper Brute II and is installed in the piping or tank per the suggested piping diagrams.

Domestic Hot Water (DHW): The DHW sensor, if used, is connected to terminals 18 and 19 on the input

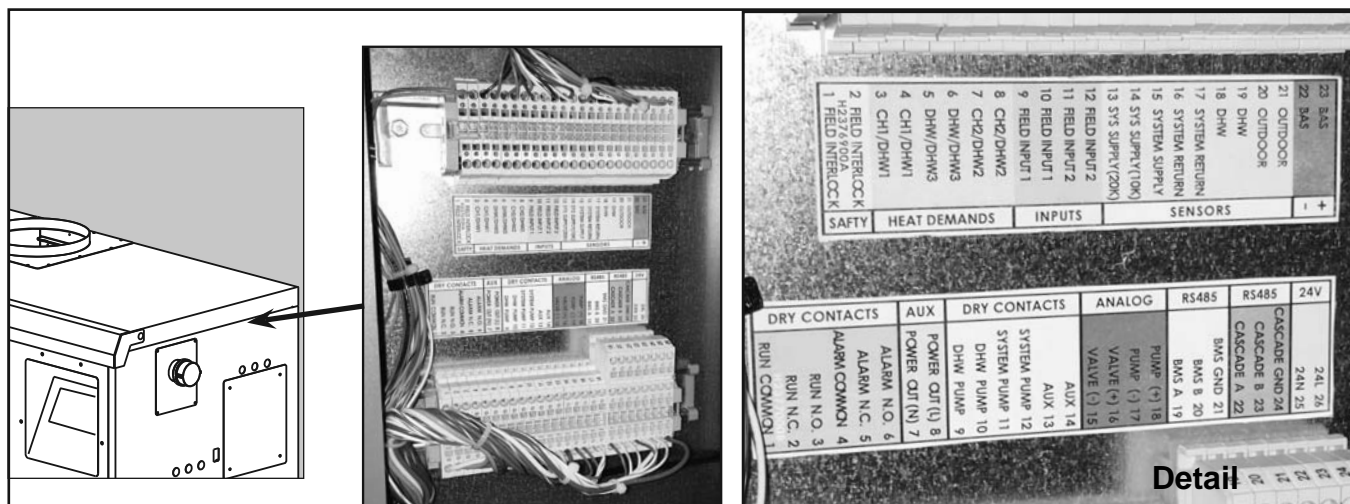

Figure 19. Input and Output Terminal Strips

terminal strip. When connected, the Copper Brute II will use this sensor to perform the DHW thermostat function. The controller automatically detects the presence of this sensor and initiates a call for heat when the DHW temperature drops below the DHW set point by the value of the DHW On Hysteresis (DHW Set Point – DHW On Hysteresis = DHW heat demand). The DHW heat demand is satisfied when the DHW temperature rises above the DHW set point by the value of the DHW Off Hysteresis (DHW Set Point + DHW Off Hysteresis = DHW heat demand satisfied). When connected, this temperature is shown on the home screen below the faucet icon. This sensor is supplied loose with the Copper Brute II and is installed in the tank per the suggested piping diagrams.

Outdoor: The outdoor sensor, if used, is connected to terminals 20 and 21 of the input terminal strip. When connected, the controller automatically detects the presence of this sensor. If installed, options such as outdoor reset and warm weather shutdown can be enabled through the display.

5.C.1.e Analog (BAS) Input

Building Automation System (BAS): The BAS input, if used, is connected to terminals 22 and 23 of the input terminal strip. When making the connection, adhere to the polarity designations shown on the label or wiring diagram. The input signal can be 0 – 10 VDC or 4 – 20 mA, and can be used to control the firing rate or set point, refer to 6.E.9 on page 59. The factory default setting is for a 0 – 10VDC signal. Configure for 4 – 20 mA by placing a jumper on CN20 on the control board, see Figure 5.

5.C.2 Field Wiring - Outputs

5.C.2.a Dry Contacts

Run: These contacts, when used, are connected to terminals 1 (common), 2 (normally closed), and 3 (normally open) of the output terminal strip. The controller closes the normally open set of contacts whenever the Copper Brute II is running. This is typically used by a BAS to verify the Copper Brute II is satisfying a heat demand. Contact ratings are 250VAC, 0.6A maximum.

Alarm: These contacts, when used, are connected to terminals 4 (common), 5 (normally closed), and 6 (normally open) of the output terminal strip. The controller closes the normally open set of contacts whenever the Copper Brute II is locked out or power is turned off. Contact ratings are 250VAC, 0.6A maximum.

DHW Pump: When connecting a domestic hot water (DHW) pump, use terminals 9 and 10 of the output terminal strip. As this is a dry contact, the DHW pump contact must be wired with either the DHW pump supply voltage or DHW pump relay coil voltage. DHW pump functionality is configured using the touch screen. Contact ratings are 250VAC, 1.5A maximum.

System Pump: When connecting a system pump, use terminals 11 and 12 of the output terminal strip. As this is a dry contact, the system pump contact must be wired with either the system pump supply voltage or the system pump relay coil voltage. System pump functionality is configured using the touch screen. Contact ratings are 250VAC, 1.5A maximum.

AUX: These contacts, when used are connected to terminals 13 and 14 of the output terminal strip. The controller closes this contact when Field Input 1 is

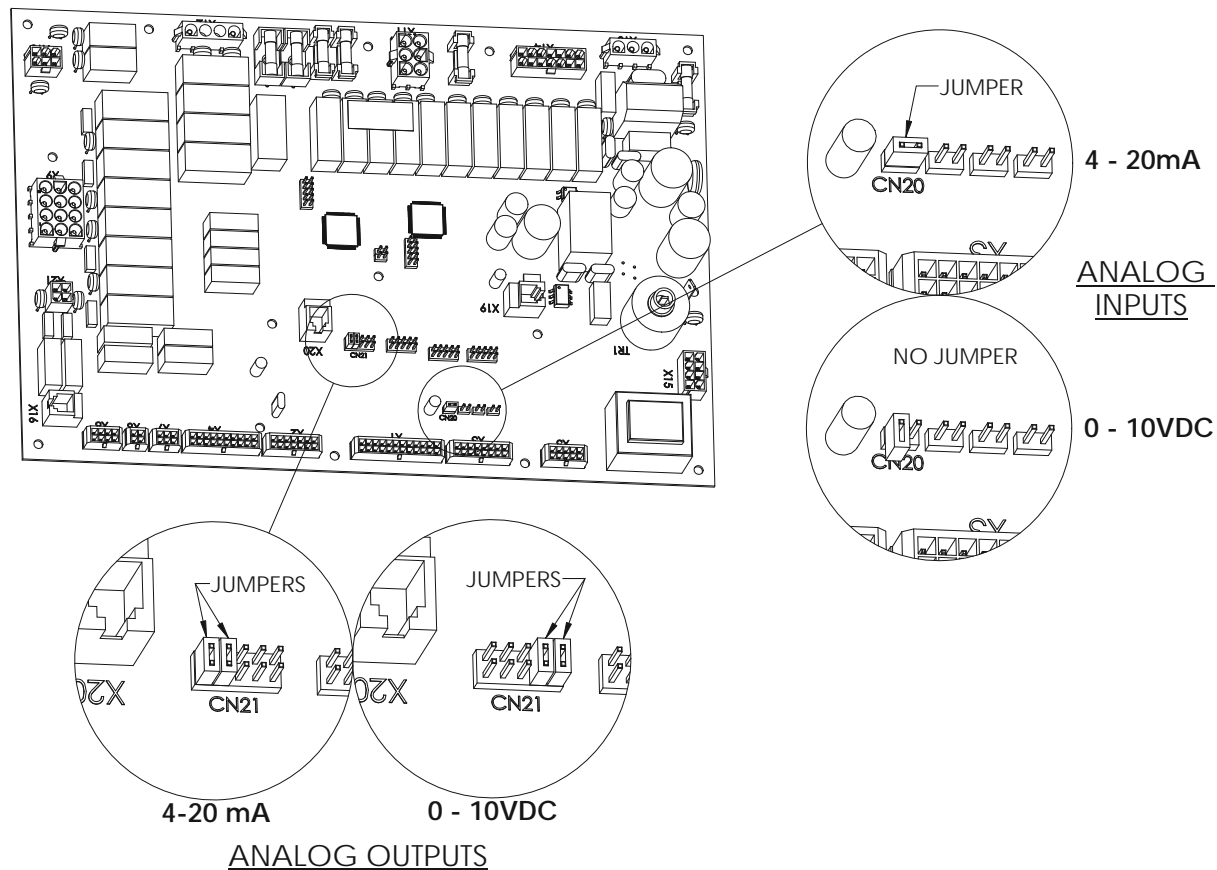

Figure 20. Analog Input and Output Jumper Placement

closed; otherwise, this contact remains open. Contact ratings are 250VAC, 1.5A maximum.

5.C.2.b Cascade RS485

Prior to wiring Copper Brute II units for cascade operations, select one Copper Brute II as the lead boiler/heater. Other Copper Brute IIs connected to the lead boiler/heater will be referred to as lag units.

Communication between lead and lag units is accomplished using RS485. When wiring Copper Brute II units for cascade operations, use terminals 23 (A), 22 (B), and 24 (GND) of the output terminal strip. Use 2-wire twisted pair, shielded w/drain, communication cable between units. Referring to Figure 21, connect one end of the twisted pair wires to A (terminal 23), and the other to terminal B (terminal 22), and the drain wire to GND (terminal 24). Connect the other end of the cable to the next Copper Brute II, matching the termination wiring on the previous unit, except for GND. Only connect the drain wire to ground on one end of the cable to avoid ground loop issues. If more than two Copper Brute II units are cascaded together, daisy chain the wiring from Copper Brute II to Copper Brute II, keeping the cables as short as possible.

A system supply sensor must be installed and

connected to the lead boiler, see System Supply in 5.C.1.d on page 32 – Temperature Sensors. The lead boiler will use this system supply sensor as the temperature control sensor for cascade operations.

CH1/DHW1 terminals are used to initiate a heat demand at the lead boiler, refer to CH1/DHW1 in 5.C.1.b on page 32– Heat Demands.

5.C.2.c BAS RS485 (BACnet MS/TP or Modbus)

These terminals, when used, are for RS485 serial communication with a BAS system using BACnet MS/TP or Modbus protocols. Use 2-wire twisted pair, shielded w/drain, communication cable between the BAS and Copper Brute II.

5.C.2.d 24VAC

There are terminals for 24VAC on the output terminal strip. These terminals are reserved for Copper Brute II low-temp units or a low water cuto-off option kit.

5.D Cascade Wiring Connections

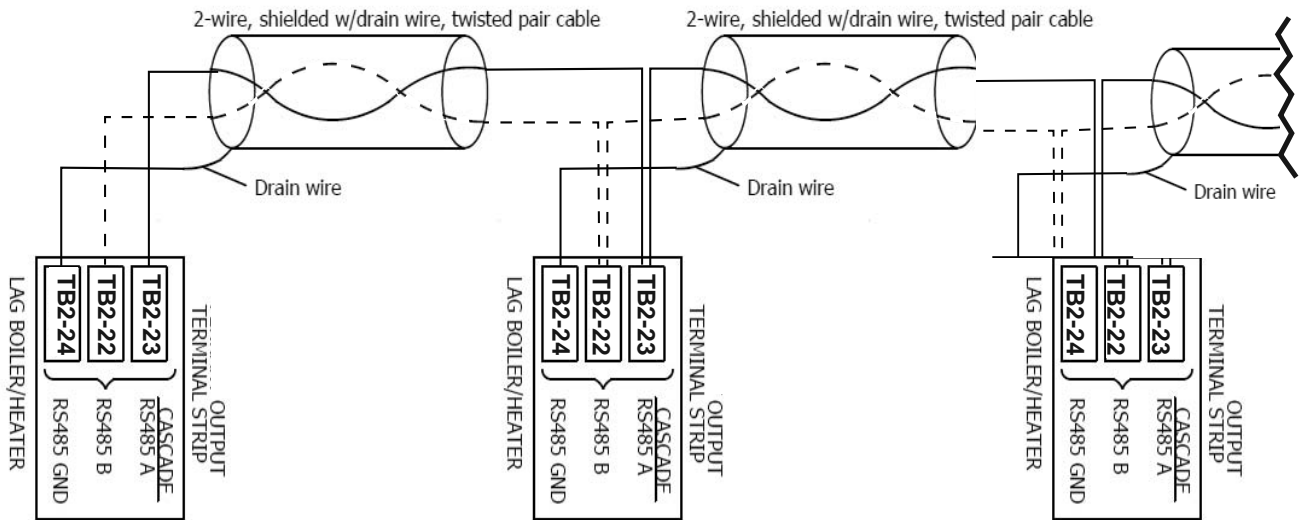

Figure 21. Cascade Wiring Connections

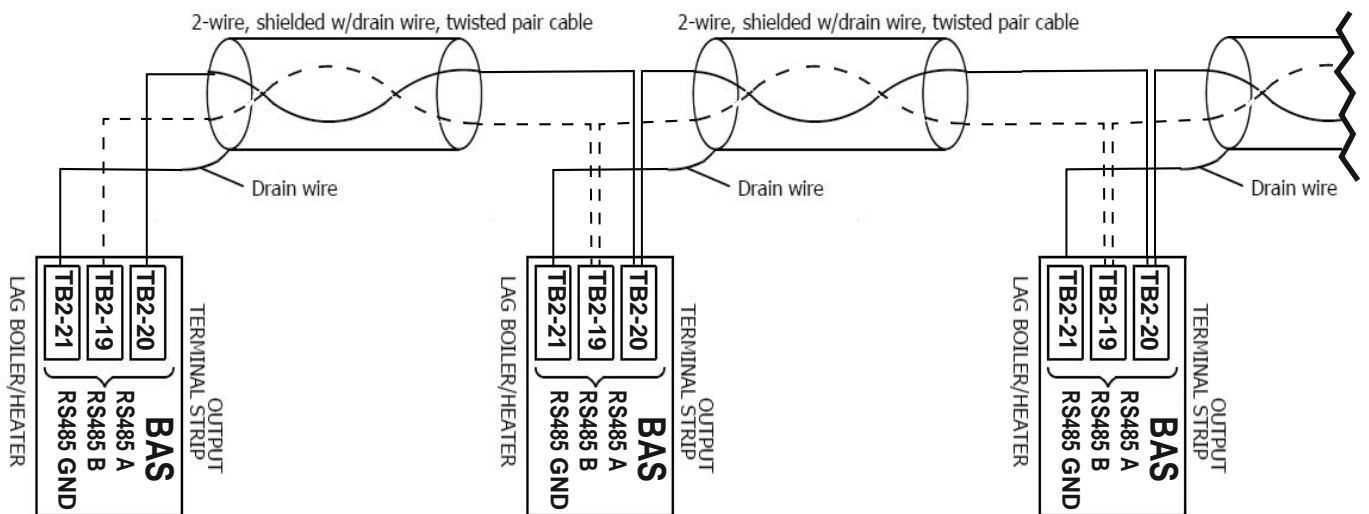
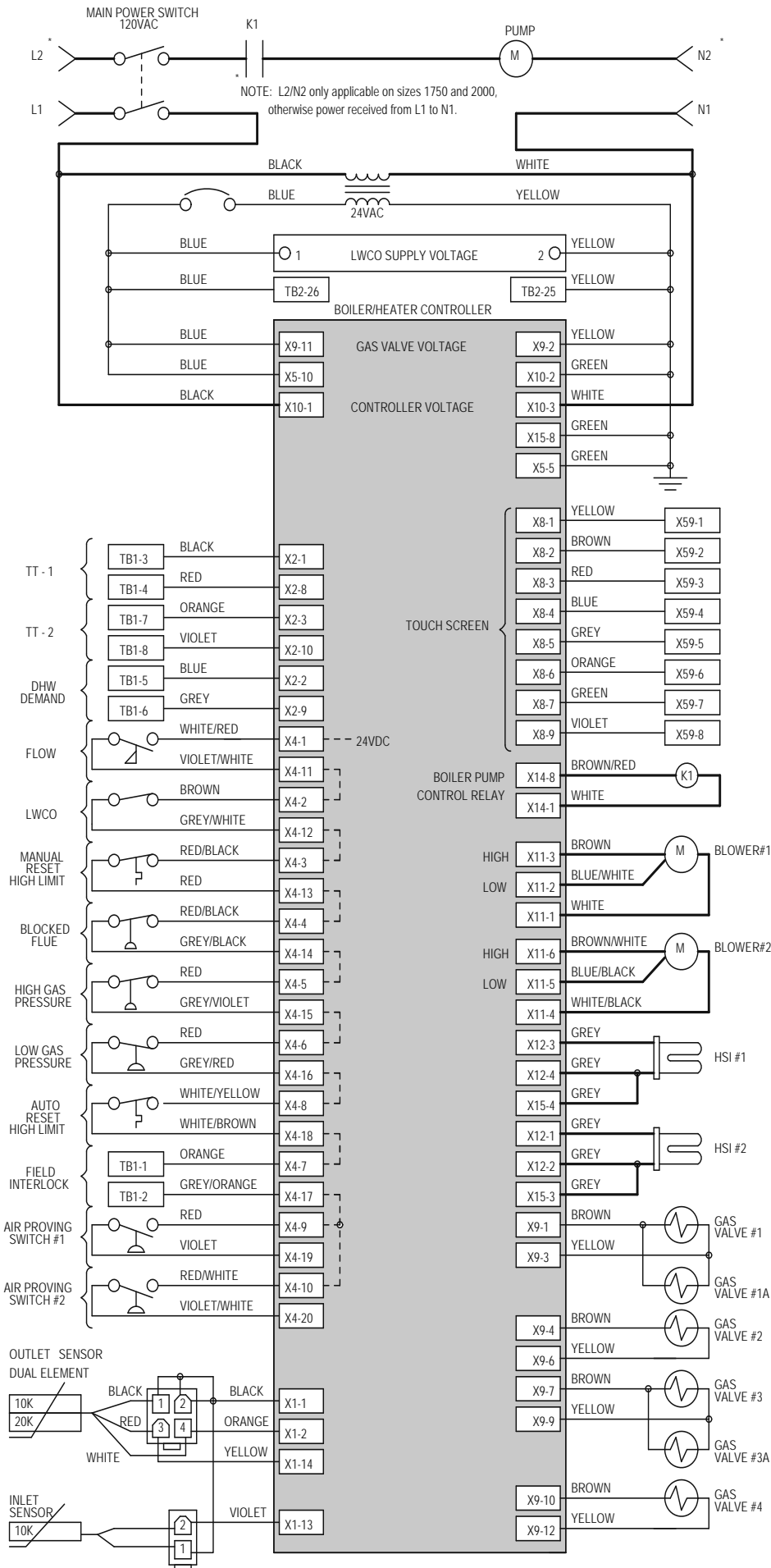

Figure 22. BAS Wiring Connections

5.E Wiring Diagram

Voltage Legend	
120 VAC	
Low Voltage	



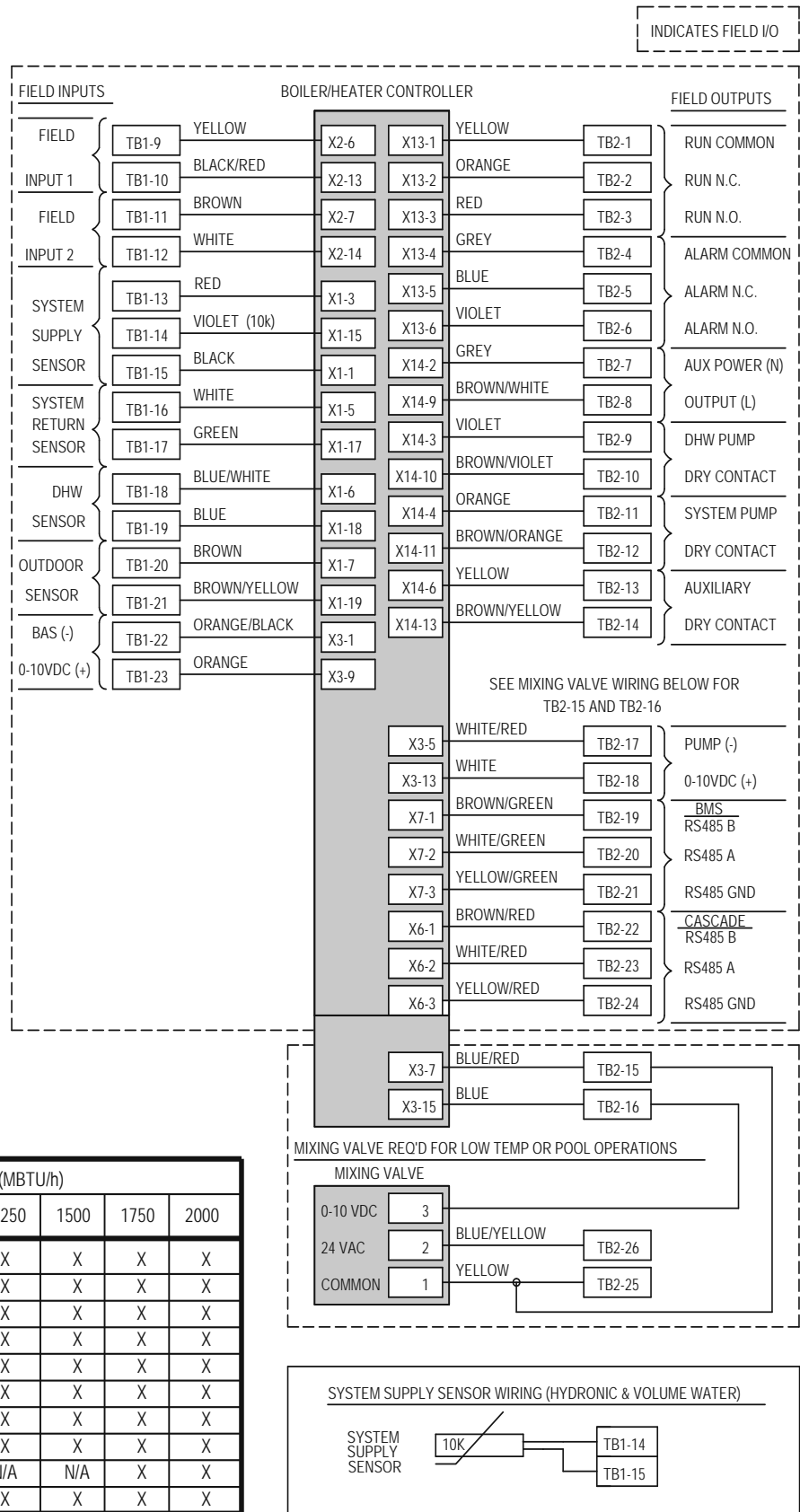

Figure 23. Wiring Diagram.
Sizes 500 - 2000.

5.F Ladder Diagram

Voltage Legend	
120 VAC	
Low Voltage	

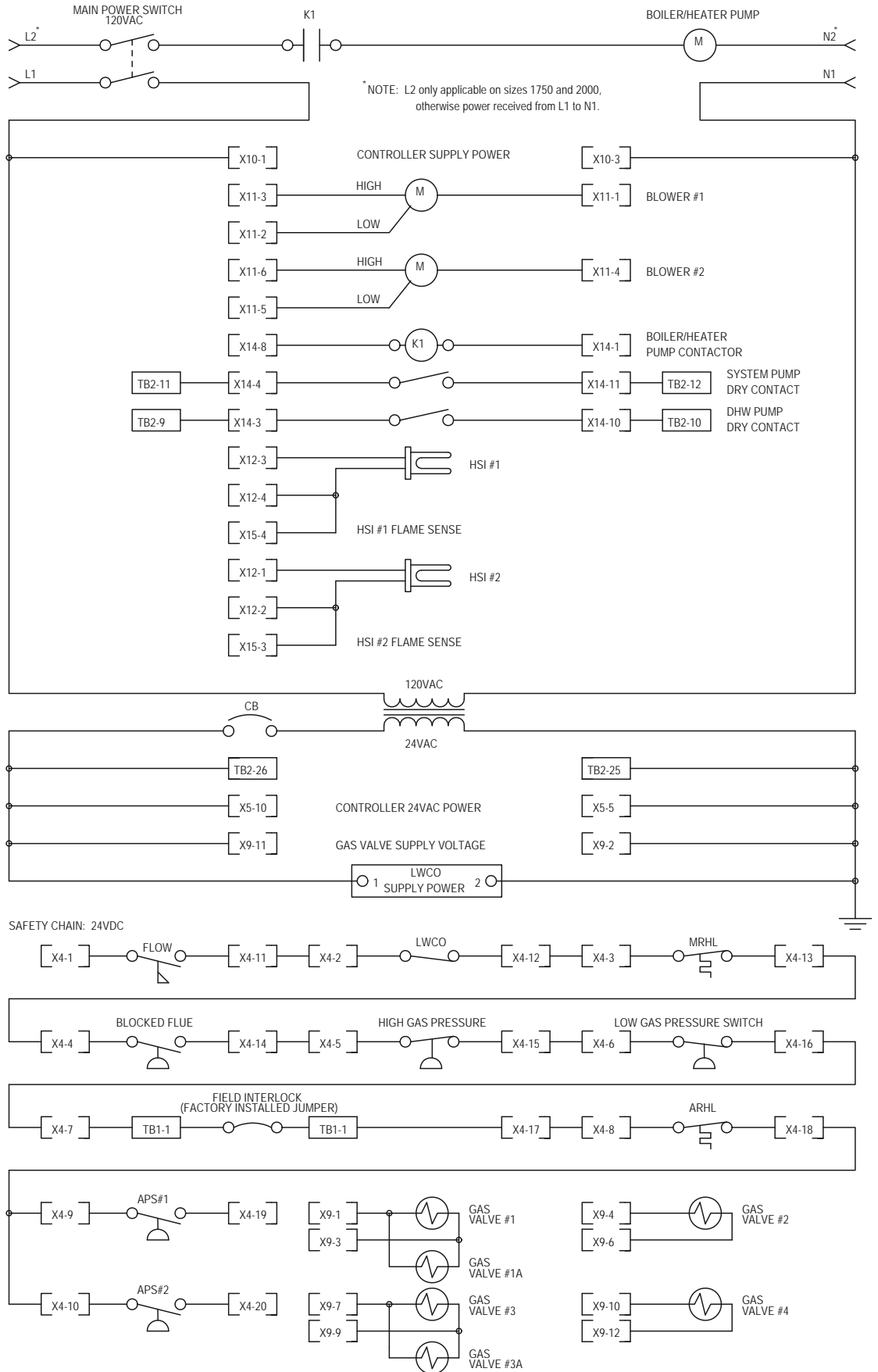
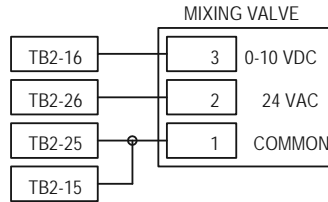
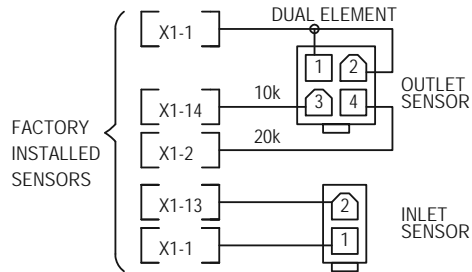

Figure 24. Ladder Diagram. Sizes 500 - 2000.



MIXING VALVE REQ'D FOR LOW TEMP OPERATIONS



COMPONENT	SIZE (MBTU/h)						
	500	750	1000	1250	1500	1750	2000
BLOWER #1	X	X	X	X	X	X	X
BLOWER #2	N/A	N/A	N/A	X	X	X	X
HSI #1	X	X	X	X	X	X	X
HSI #2	N/A	N/A	X	X	X	X	X
GAS VALVE #1	X	X	X	X	X	X	X
GAS VALVE #1A	N/A	N/A	N/A	X	X	X	X
GAS VALVE #2	X	X	X	X	X	X	X
GAS VALVE #3	N/A	N/A	X	X	X	X	X
GAS VALVE #3A	N/A	N/A	N/A	N/A	N/A	X	X
GAS VALVE #4	N/A	N/A	N/A	X	X	X	X

INDICATES FIELD I/O

FIELD INPUTS			FIELD OUTPUTS		
TB1-1	FIELD	SAFETY CHAIN	TB2-1	COMMON	RUN RELAY DRY CONTACTS
TB1-2	INTLK		TB2-2	N.C.	
TB1-3	CH1		TB2-3	N.O.	
TB1-4	CH1	HEAT DEMANDS	TB2-4	COMMON	ALARM RELAY DRY CONTACTS
TB1-5	DHW		TB2-5	N.C.	
TB1-6	DHW		TB2-6	N.O.	
TB1-7	CH2		TB2-7	AUX	
TB1-8	CH2	TB2-8	AUX		
TB1-9	FIELD	FIELD INPUTS	TB2-9	DHW	DRY CONTACTS
TB1-10	INPUT1		TB2-10	PUMP	
TB1-11	FIELD		TB2-11	SYSTEM	
TB1-12	INPUT2	TB2-12	PUMP		
TB1-13	SYSTEM SUPPLY	SENSOR INPUTS	TB2-13	AUX	RS485 BMS
TB1-14			TB2-14	AUX	
TB1-15			TB2-17	PUMP(-)	
TB1-16	TB2-18		0-10V(+)		
TB1-17	RETURN	ANALOG INPUT	TB2-19	B	RS485 BMS
TB1-18	DHW		TB2-20	A	
TB1-19	DHW		TB2-21	GND	
TB1-20	OUTDOOR	ANALOG INPUT	TB2-22	B	RS485 CASCADE
TB1-21	OUTDOOR		TB2-23	A	
TB1-22	BAS (-)		TB2-24	GND	
TB1-23	0-10V (+)				

SEE MIXING VALVE WIRING BELOW FOR TB2-15 AND TB2-16

SYSTEM SUPPLY SENSOR WIRING (HYDRONIC & VOLUME WATER)

SECTION 6 Touchscreen and System Operations

6.A The Home Screen

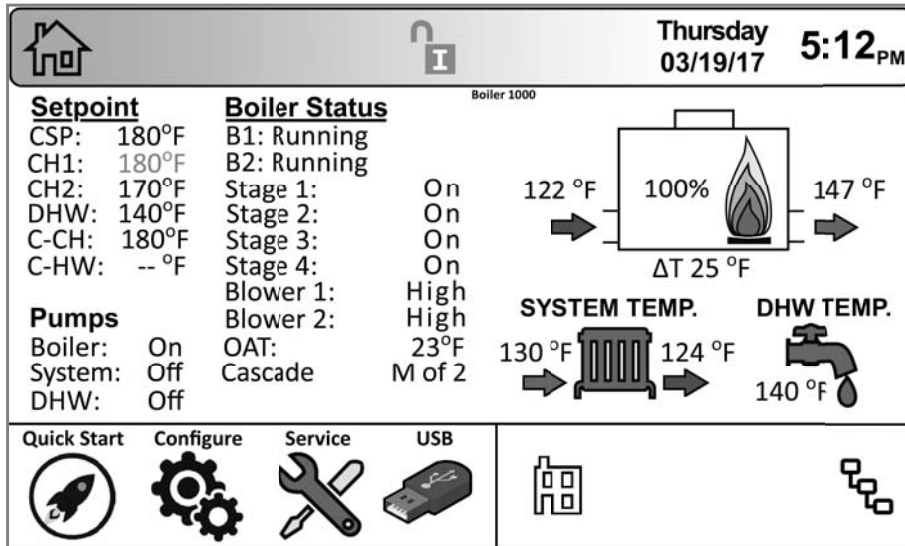

Figure 25. The Home Screen

Model	Stages
Low Temp	On/Off
500 - 750	2
1000	3
1250 - 2000	4

Table 11. Stages per Model

6.A.1 Home Screen Status Window

The central area of the home screen displays the current status information for the unit.

Heat Demand Set Points.

Pump Status.

Boiler Status (Boiler Bank).

System Temp.

DHW Temp (if installed).

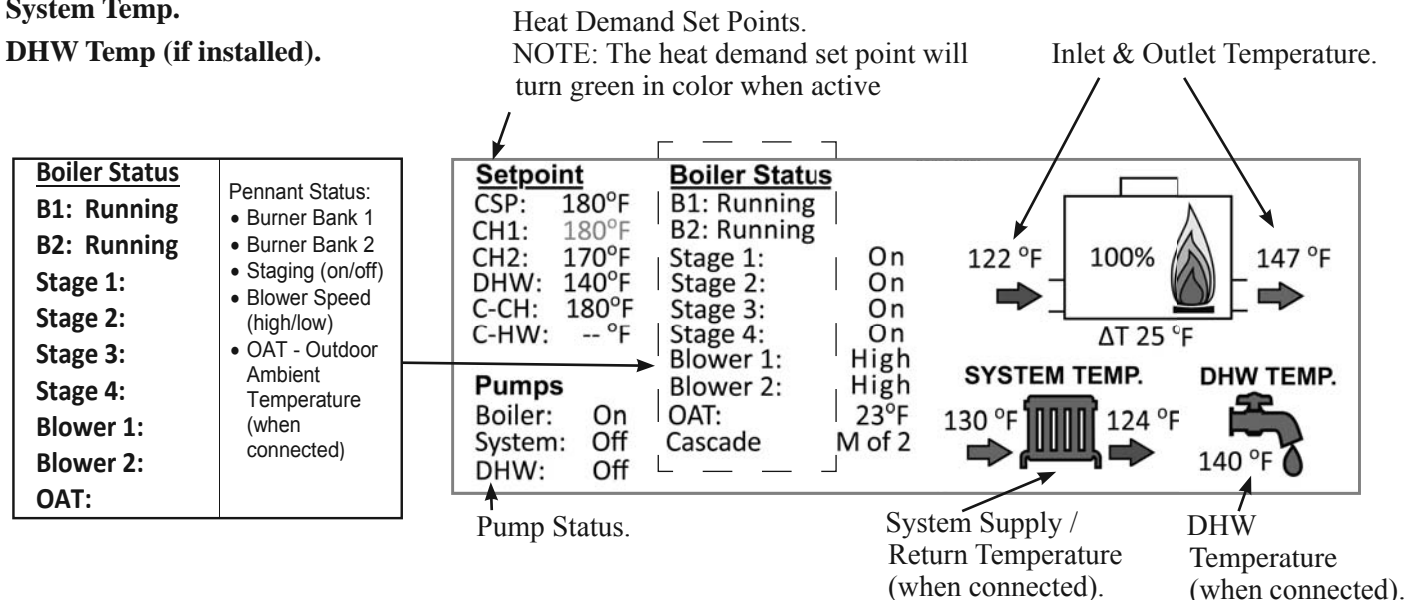

Figure 26. The Status Display Area, defined.

6.A.2 Home Screen Active Icons









Name	Icon	Description
<i>Security</i>		Displays the current lock status. Touch the lock icon to lock or unlock the Touchscreen Display. See Section 6.B on page 42
<i>Quick Start</i>		Provides quick touch access to the most commonly used parameters for easy installation. See Section 6.D on page 44
<i>Configure</i>		Will take you to ALL of your configurations and parameters for a detailed setup of the unit. This is the largest group of menu screens. See Section 6.E on page 47
<i>Service</i>		Allows the service technician to access the basic diagnostic and troubleshooting information. See Section 6.F on page 66
<i>Messages</i>		<p>Will show an 'Exclamation' when there is a message. Clicking onto the Message icon will take you to the message itself. </p> <p>The USB functionality will show the USB Icon at this location, if being used. See Section 6.G on page 68</p>
<i>Active Demands</i>		Will show icons that indicate the active parameters that are currently in demand. See Section 6.H on page 70
<i>Navigation Bar</i>		<p>The Navigation Bar is the constant indicator of where you are as you navigate into and out of the touchscreens. See Section 6.I on page 70</p> <p>ERROR Codes also show in the <i>Navigation Bar</i> when there is one of several unit errors or shut-downs that have occurred.</p>
<i>Date & Time</i>	<p>Thursday 03/19/17 5:12^{PM}</p>	For Display Only. To change date and time, go to the Configuration menu. Section 6.J on page 70

Table 12. The Active Icons on the Home Screen, and what they do.

6.B Lock / Unlock Display Screen



Password Protection:

To change parameters, a password is required. The control system includes three levels of password protection. Touch the 'Current Lock Status' Icon.

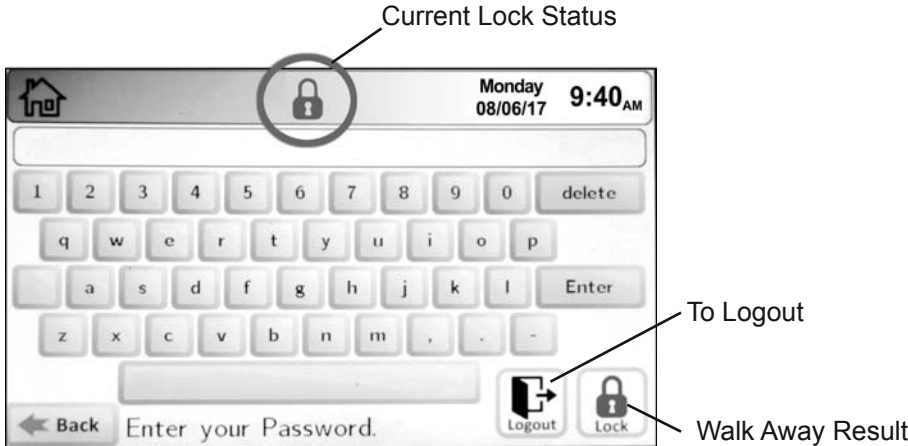

Screen 1. Sign in Screen

-USER Password: Non-critical adjustments and functions. **The user password is lhs.** When unlocked in the User mode, the icon will change to-



-INSTALLER Password: Setup and parameter changes made during the initial setup and commissioning. **The installer password is 17.** When unlocked in the Installer mode, the icon will change to-



-OEM Password: Setup and parameter changes available only to the factory.

Walk-Away Result. The unit will either Lock or stay Un-locked if you walk away. What it will do is displayed in the bottom right corner. The default delay time to lock is 5 minutes of inactivity.

This time duration can be adjusted in Service -> Screen -> Auto Lock Timeout.

And it can also be set up to never Lock.



If the Installer is done and wants to lock the display immediately, tap the Logout Icon to get out of Installer or User Mode.



6.C Keypad Operations

As you navigate in, you find that all screens have either a numeric keypad to enter in your customizable parameters OR selection buttons to choose the options for your configuration.

NOTE: You can always tell exactly where you have navigated to by looking at the icons in the *Navigation Bar*.

In this example you are in

Home/Configure/Central Heat/Central Heat One

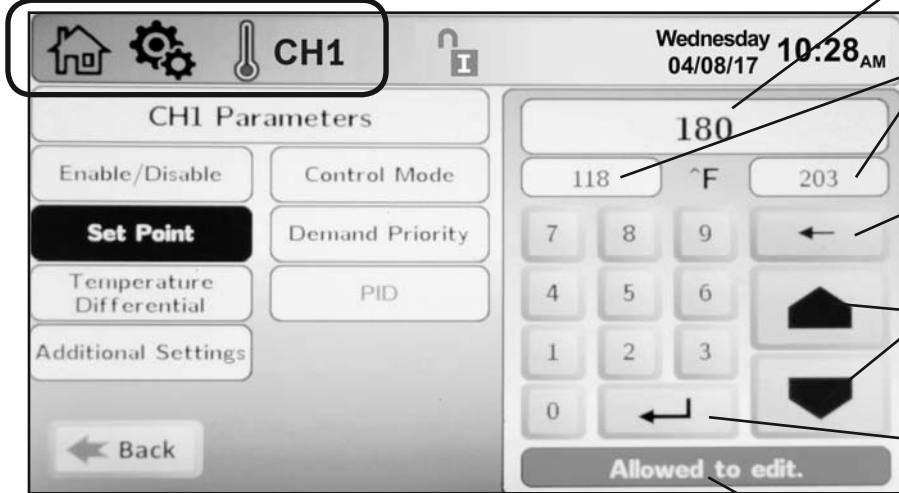

Shows the current setting of the Parameter.

These windows will reflect the allowable ranges that the setting can be adjusted to.

To delete the current setting before entering in the new value.

“Up and Down” arrows are used to increment the setting accordingly.

The “Enter” button is used to accept the new value that was just entered.

Screen 2. A typical numeric keypad entry screen.

This is the indicator that will be shown when the correct password has been entered to allow the setting to change.

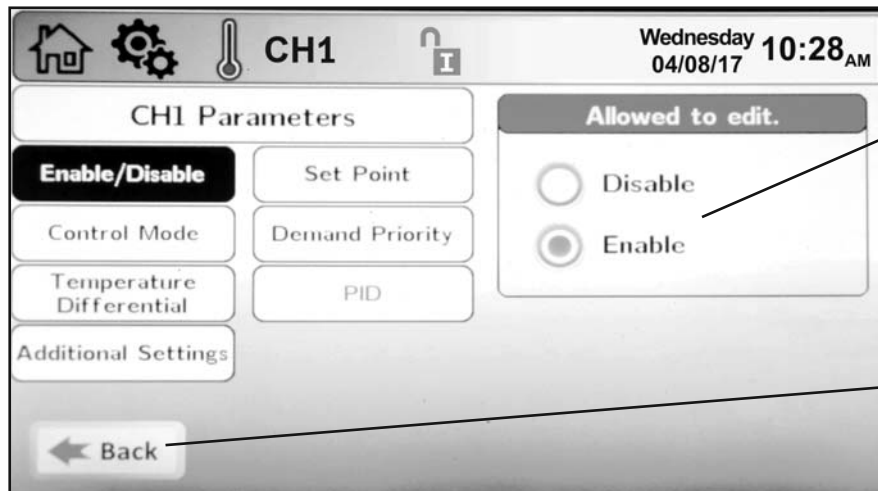

The highlighted button (orange) shows which one is selected. Some screens may only allow you to set one or the other, while some other screens (example: pump selection) will allow you to select any or all of the options.

The “Back” button jumps to the previous screen.

Screen 3. A typical selection screen.

6.D Quick Start

To navigate to the Quick Start Screen, touch the Quick Start Icon in the lower left-hand portion of the Home Screen.

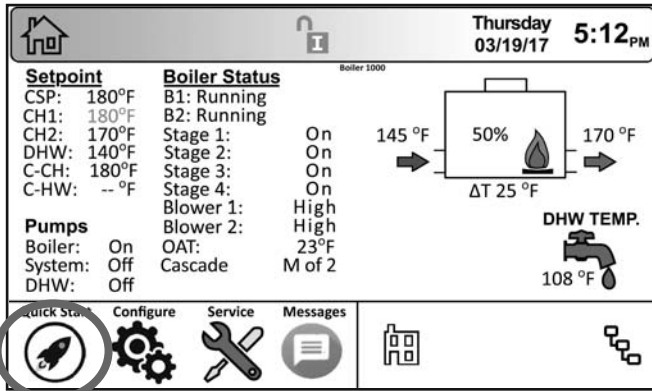

Screen 4. Home Screen

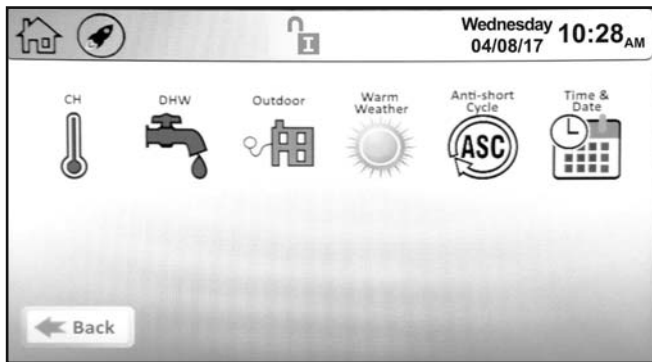

Screen 5. Quick Start Screen

6.D.1 CH

On the Quick Start Screen, touch the CH thermometer icon to navigate to the CH Selection Screen

There are two identical heat demands, CH1 and CH2, each with independent control algorithms and independent inputs on the input terminal strip, see Figure 19 on page 33.

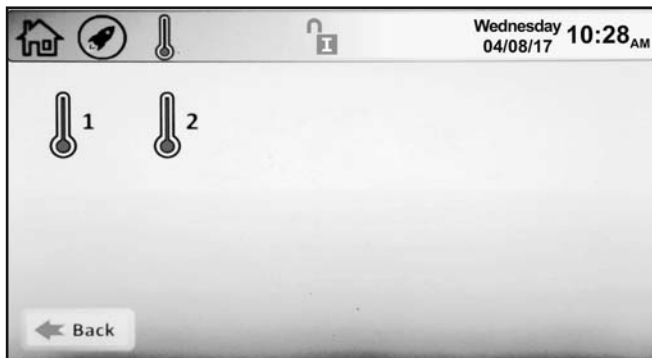

Screen 6. CH Quick Start Selection Screen

Touching CH1 navigates to the CH1 Quick Start Screen

6.D.1.a CH1

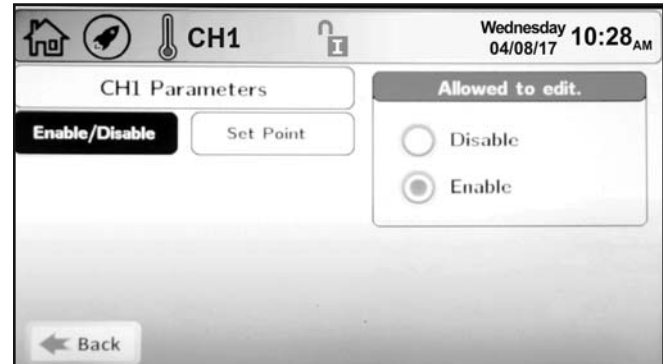

Screen 7. CH1 Quick Start Screen

- **Enable/Disable** – This allows CH1 to be enabled/disabled. The default setting is Enabled.
- **Set Point** – This is the temperature that this heat demand will control to.

6.D.1.b CH2

To navigate to the CH2 Quick Start Screen, touch the CH2 Icon on the CH Quick Start Selection Screen.

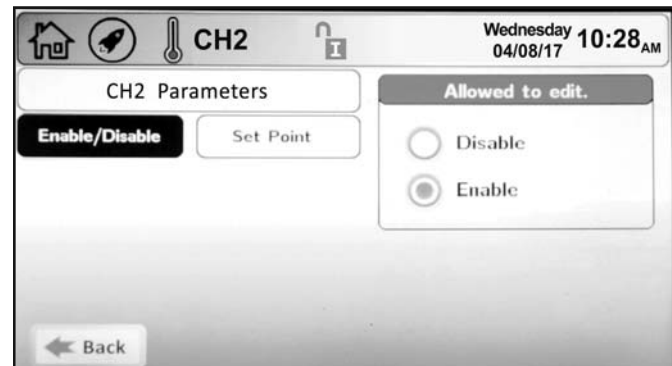

Screen 8. CH2 Quick Start Screen

6.D.2 DHW/DHW3

To navigate to the DHW/DHW3 Quick Start Screen, touch the DHW faucet icon on the Quick Start Screen.

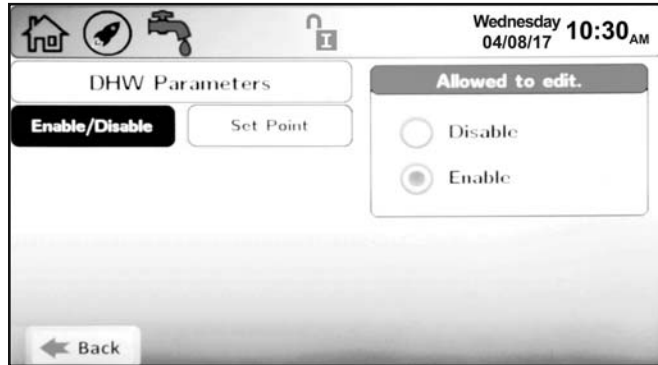

Screen 9. DHW/DHW3 Quick Start Screen

The DHW/DHW3 Quick Start Screen allows adjustment of the following parameter:

- **Enable/Disable** – This allows DHW/DHW3 to be enabled/disabled. The default setting is Enabled.
- **Set Point** – This is the temperature that this heat demand will control to.

NOTE: A DHW/DHW3 heat demand can be initiated by an aquastat or sensor, see Sections 5.C.1.b and 5.C.1.d respectively.

6.D.3 Outdoor Reset

To navigate to the Outdoor Quick Start Screen, touch the Outdoor Icon on the Quick Start Screen.

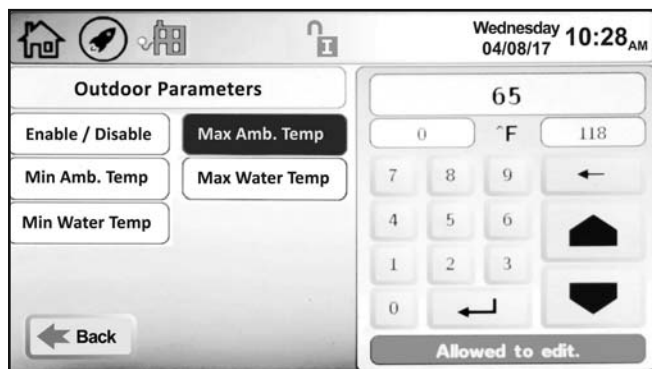

Screen 10. Outdoor Quick Start Screen

The Outdoor Quick Start Screen allows the adjustment of the following parameters:

- **Enable/Disable** – This allows Outdoor Reset to be enabled/disabled. The default setting is Enabled.
- **Maximum Ambient Temperature** – The outdoor temperature at which the Copper Brute II will limit the boiler outlet temperature to the Minimum Water Temperature.
- **Minimum Ambient Temperature** – The

outdoor temperature at which the Copper Brute II will maximize the boiler outlet temperature to the Maximum Water Temperature.

- **Max Water Temp** – To set max water temp.
- **Min Water Temp** – To set minimum water temp.

NOTE: Outdoor functionality is applicable to hydronic units only and is explained in Section 6.E.4 on page 51. Wiring of the outdoor sensor is covered in Section 5.C.1.d on page 32

6.D.4 Warm Weather Shut Down

To navigate to the Warm Weather Quick Start Screen, touch the Warm Weather Icon on the Quick Start Screen.



Screen 11. Warm Weather Quick Start Screen

The Warm Weather Quick Start Screen allows adjustment of the following parameters:

- **Temp Min** – Upon an active warm weather shutdown condition, this is the temperature at which the Copper Brute II will reset the shutdown condition to satisfy a heat demand.
- **Temp Max** – This is the temperature at which the warm weather shutdown condition will occur.
- **Feature Options** – This parameter provides the ability to either disable warm weather shutdown or upon a warm weather condition, configure the Copper Brute II to shut down immediately or to shut down after the current heat demand is satisfied.

6.D Quick Start (continued)

6.D.5 Anti-Short Cycle

To navigate to the Anti-Short Cycle Quick Start Screen, touch the Anti-Short Cycle Icon on the Quick Start Screen.

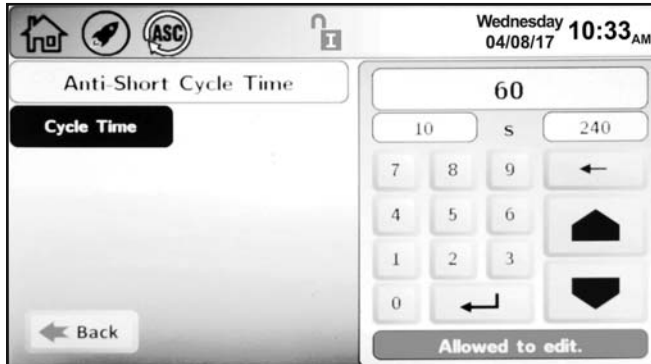

Screen 12. Anti-Short Cycle Quick Start Screen

The Anti-Short Cycle Quick Start Screen allows adjustment of the following parameter:

- **Cycle Time** – The amount of time after a heat demand is satisfied that the Copper Brute II will wait to satisfy the next active heat demand.

NOTE: Anti-Short Cycle Time does not apply to DHW/DHW3 heat demands.

6.D.6 Time & Date

To navigate to the Time & Date Quick Start Screen, touch the Time & Date Icon on the Quick Start Screen.

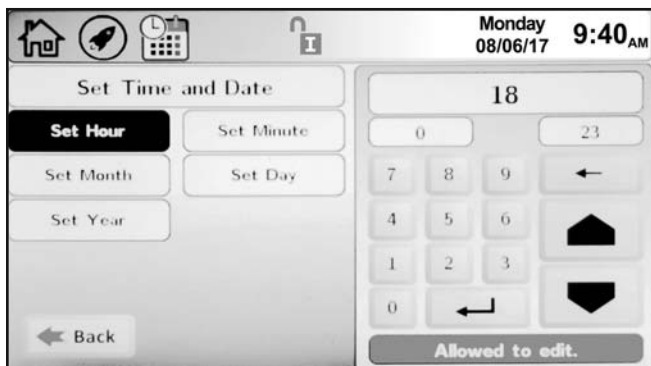

Screen 13. Time & Date Quick Start Screen

NOTE: The Time is set in a 24 hour parameter, but displays only as a 12 hour clock with the AM/PM automatically added.

The Time & Date Quick Start Screen allows adjustment of the following parameters:

- **Hour** – The hour that will be displayed in the

upper banner on each screen, and the time captured in the date/time stamp for lock-out conditions displayed on the history screen.

- **Minute** – The minute that will be displayed in the upper banner on each screen, and the time captured in the date/time stamp for lock-out conditions displayed on the history screen.

- **Month** – The month that will be displayed in the upper banner on each screen, and the date captured in the date/time stamp for lock-out conditions displayed on the history screen.

- **Day** – The day that will be displayed in the upper banner on each screen, and the date captured in the date/time stamp for lock-out conditions displayed on the history screen.

- **Year** – The month that will be displayed in the upper banner on each screen, and the date captured in the date/time stamp for lock-out conditions displayed on the history screen.

6.E Configure Screen

To navigate to the Configure Screen, touch the Configure Icon in the lower left-hand portion of the Home Screen.

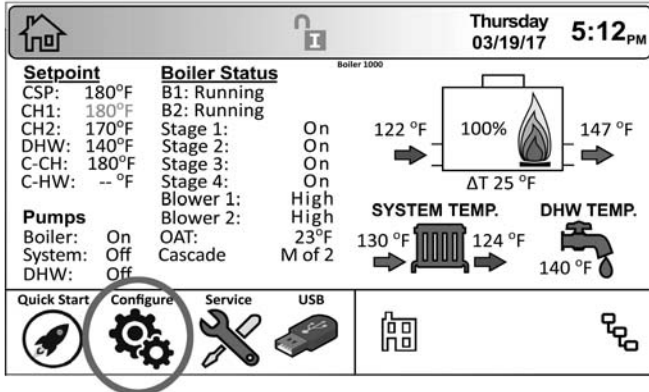

Screen 14. Home Screen

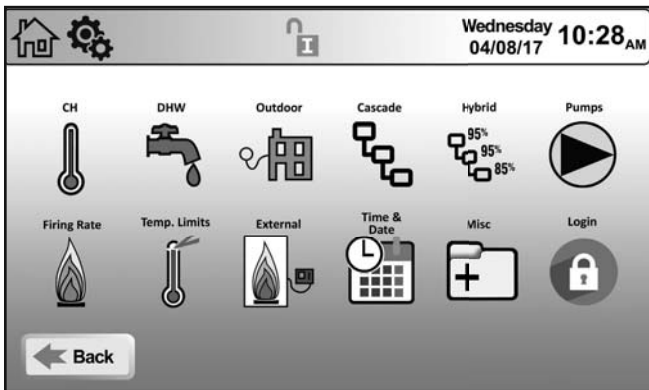

Screen 15. Configure Screen

From the Configure Screen, the Copper Brute II functionality can be configured for the specific application/installation. The following sections give an overview of each configuration sub menu.

6.E.1 CH

On the Configure Screen, touch the CH thermometer icon to navigate to the CH Selection Screen

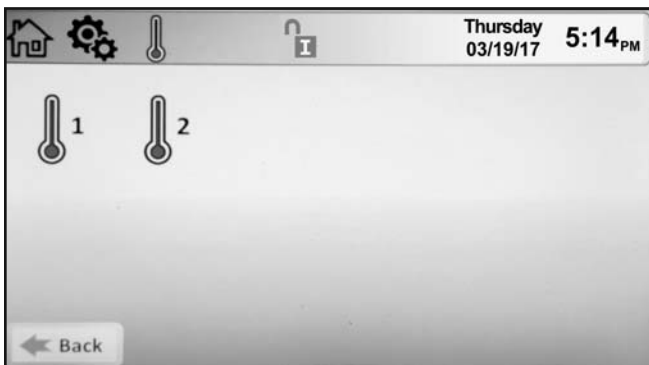

Screen 16. CH Selection Screen

There are two identical heat demands, CH1 and CH2, each with independent control algorithms and independent inputs on the input terminal strip, see Figure 19 on page 33.

From the CH Selection Screen, touching CH1/ navigates to the CH1.

6.E.1.a CH1

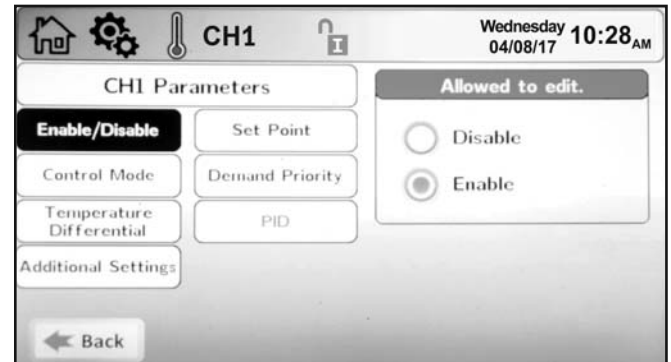

Screen 17. CH1 Configuration Screen

The CH1 Configuration Screen allows adjustment of the following parameters:

- **Enable/Disable** – This allows CH1 to be enabled/disabled. The default setting is Enabled.
- **Control Mode** – This provides the ability to select either Temperature Differential control or PID control. The default setting is Temperature Differential.
- **Set Point** – This is the temperature that this heat demand will control to.
- **Demand Priority** – This allows the user to prioritize the heat demand, such as DHW before CH. The higher the number, the higher the priority. See Table 13 on page 48
- **Temperature Differential** This button navigates to the parameters applicable to temperature differential control.
- **PID** This button navigates to the parameters applicable to PID (Proportional, Integral, Derivative) control.
- **Additional Settings** This button navigates to additional CH control parameters.

Heat Demand	Source		Priority
	BWCH	BWCV	
DHW	DHW	DHW3	90
	DHW Sensor (Section 5.3.1.4)		
Cascade	CH1	DHW1	80
	Applied at the lead boiler/heater		
TT1	CH1	DHW1	60
TT2	CH2	DHW2	50
External Demand	Analog Input (0 – 10VDC/4 – 20mA)		20
Frost Protection	Inlet Temperature		10

Table 13. Demand Priority

6.E.1.a.1 Temperature Differential & PID

Temperature Control

The Copper Brute II stages on & off burners to satisfy heat demands. Staging control is designed to operate up to 4 stages using two separate hot surface igniters (HSI) and multiple gas valves. The igniters are associated with stages 1 and 3, and gas valves control stages 2 and 4. The control algorithm will treat stages 1 and 2 as a boiler, and on applicable units, stages 3 and 4 as a separate boiler. As a result, for sizes 1250 – 2000, if stage 1 is running, but stage 3 is not running, the fan for stage 3 would need to be running at low speed to prevent flue gases from recirculating. Similarly, if stage 3 is running, but stage 1 is not running, the fan for stage 1 would need to be running at low speed to prevent flue gases from recirculating. For single blower models, the fan operates only at high speed.

Copper Brute IIs have two modes of temperature control, either Temperature Differential control or Proportional, Integral, Derivative (PID) control. Temperature Differential control is the default control mode. The heat demand set point is independent of the method of temperature control being used.

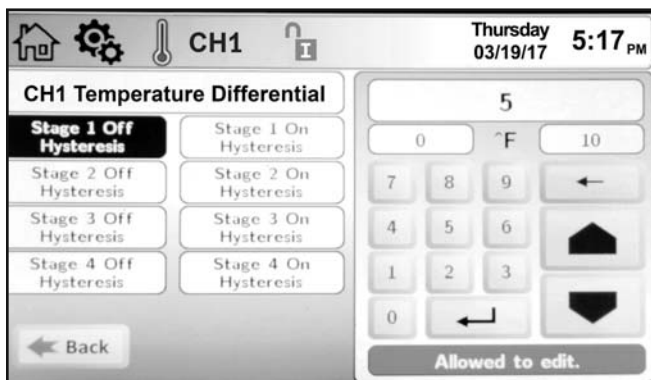

Screen 18. CH1/DHW1 Temp Differential Screen

NOTE: If controlling to the system sensor, the Copper Brute II will continue to use the outlet sensor for Auto/Manual Reset Limit conditions.

The CH1/DHW1 Temperature Differential Screen allows the adjustment of the following parameters:

- **Stage 1/2/3/4 Off Hysteresis** – an offset of the temperature set point at which the stage turns off. Each stage has an off hysteresis associated with it.
- **Stage 1/2/3/4 On Hysteresis** – an offset of the temperature set point at which the stage turns on. Each stage has an on hysteresis associated with it.

NOTE: Stage 3 applies to 1000 – 2000 sizes, and stage 4 applies to 1.250 – 2000 sizes. See Table 11 on page 40

Temperature Differential parameters are:

- Stage Off Hysteresis** – the temperature at which the next stage turns off. Each stage has an off hysteresis associated with it.
- Stage On Hysteresis** – the temperature at which the next stage turns on. Each stage has an on hysteresis associated with it.
- Stage Delay On Time** – the amount of time that must elapse prior to turning on the next stage.
- Stage Delay Off Time** – the amount of time that must elapse prior to turning off the next stage.
- Minimum Stage On Time** – the minimum time that a stage must be on before it is allowed to turn off.
- Minimum Stage Off Time** – the minimum time that a stage must be off before it is allowed to turn on.

6.E.1.a.2 Thermostat/Aquastat/Zone Control/ BACnet

There are three “TT” or “CH” heat demand inputs available, CH1/CH2/DHW for Boiler, and DHW1/DHW2/DHW3 for Heater. Each demand has an independent set point and control settings. See Section 5.C.1 on page 32 for wiring information and configuration information.

NOTE: BACnet can also be used to initiate a CH1/CH2/DHW (boilers) or DHW1/DHW2/DHW3 (water heaters) heat demand. See Section 6.E.11.e on page 64 for configuration information.

Parameter	Value	Stage On/Off Temperature	Action
Stage 1 Off Hysteresis	5°F	Set Point + (Stage 1 Off + Stage 2 Off) 180°F + (5°F + 5°F) = 190°F	Turn Off Stage 1
Stage 2 Off Hysteresis	5°F	Set Point + (Stage 2 Off) 180°F + 5°F = 185°F	Turn Off Stage 2
Set Point	180°F	N/A	None
Stage 1 On Hysteresis	5°F	Set Point – (Stage 1 On) 180°F - 5°F = 175°F	Turn On Stage 1
Stage 2 On Hysteresis	5°F	Set Point – (Stage 1 On + Stage 2 On) 180°F - (5°F + 5°F) = 170°F	Turn On Stage 2
NOTE: Stage 1 will always ignite prior to stage 2 since the HSI is associated with stage 1.			

Using a set point of 180°F and the default values for each stage on and off hysteresis, this table shows the temperatures at which stages 1 and 2 will turn on/off for a Copper Brute II 500/750.

Table 16. Temperature Differential Staging of a 2 Stage Copper Brute II

Parameter	Value	Stage On/Off Temperature	Action
Stage 1 Off Hysteresis	5°F	Set Point + (Stage 1 Off + Stage 2 Off + Stage 3 Off) 180°F + (5°F + 5°F + 5°F) = 195°F	Turn Off Stage 1
Stage 2 Off Hysteresis	5°F	Set Point + (Stage 2 Off + Stage 3 Off) 180°F + (5°F + 5°F) = 190°F	Turn Off Stage 2
Stage 3 Off Hysteresis	5°F	Set Point + (Stage 3 Off) 180°F + 5°F = 185°F	Turn Off Stage 3
Set Point	180°F	N/A	None
Stage 1 On Hysteresis	5°F	Set Point – (Stage 1 On) 180°F - 5°F = 175°F	Turn On Stage 1
Stage 2 On Hysteresis	5°F	Set Point – (Stage 1 On + Stage 2 On) 180°F - (5°F + 5°F) = 170°F	Turn On Stage 2
Stage 3 On Hysteresis	5°F	Set Point – (Stage 1 On + Stage 2 On + Stage 3 On) 180°F - (5°F + 5°F + 5°F) = 165°F	Turn On Stage 3

Using a set point of 180°F and the default values for each stage on and off hysteresis, this table shows the temperatures at which stages 1, 2, and 3 will turn on/off for Copper Brute II 1000.

Table 14. Temperature Differential Staging of a 3 Stage Copper Brute II

Parameter	Value	Stage On/Off Temperature	Action
Stage 1 Off Hysteresis	5°F	Set Point + (Stage 4 Off + Stage 3 Off + Stage 2 Off + Stage 1 Off) 180°F + (5°F + 5°F + 5°F + 5°F) = 200°F	Turn Off Stage 1
Stage 2 Off Hysteresis	5°F	Set Point + (Stage 4 Off + Stage 3 Off + Stage 2 Off) 180°F + (5°F + 5°F + 5°F) = 195°F	Turn Off Stage 2
Stage 3 Off Hysteresis	5°F	Set Point + (Stage 4 Off + Stage 3 Off) 180°F + (5°F + 5°F) = 190°F	Turn Off Stage 3
Stage 4 Off Hysteresis	5°F	Set Point + (Stage 4 Off) 180°F + 5°F = 185°F	Turn Off Stage 4
Set Point	180°F	N/A	None
Stage 1 On Hysteresis	5°F	Set Point – (Stage 1 On) 180°F - 5°F = 175°F	Turn On Stage 1
Stage 2 On Hysteresis	5°F	Set Point – (Stage 1 On + Stage 2 On) 180°F - (5°F + 5°F) = 170°F	Turn On Stage 2
Stage 3 On Hysteresis	5°F	Set Point – (Stage 1 On + Stage 2 On + Stage 3 On) 180°F - (5°F + 5°F + 5°F) = 165°F	Turn On Stage 3
Stage 4 On Hysteresis	5°F	Set Point – (Stage 1 On + Stage 2 On + Stage 3 On + Stage 4 On) 180°F - (5°F + 5°F + 5°F + 5°F) = 160°F	Turn On Stage 4

Using a set point of 180°F and the default values for each stage on and off hysteresis, this table shows the temperatures at which stages 1, 2, 3 and 4 will turn on/off for Copper Brute II 1250 - 2000.

Table 15. Temperature Differential Staging of a 4 Stage Copper Brute II

6.E.1.a.3 PID

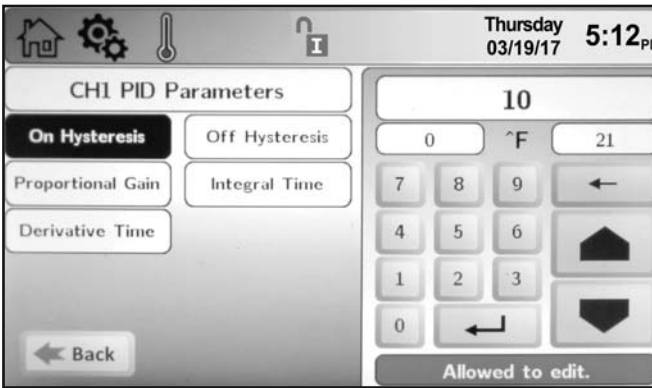

Screen 19. CH1/DHW1 PID Screen

To activate PID you must first go into Control Mode and select PID. You may be prompted to Save any configuration changes that you have made so far. Then come back CH1 Parameters and select PID.

The CH1/DHW1 PID Screen allows adjustment of the following parameters:

- **On Hysteresis** – The temperature below the set point (Set Point – On Hysteresis) at which the control begins calculating the PID output to turn on stages.
- **Off Hysteresis** – The temperature above the set point (Set Point + Off Hysteresis) at which the controller will stop calculating the PID output and set the PID output to 0 to turn off all stages.
- **Proportional Gain** – This value is the corrective action that is proportional to the error (set point – control temperature).
- **Integral Time** – This value is applied to the sum of the error over a period of time.
- **Derivative Time** – This value is applied to the rate of change of the error.

NOTE: By default, the control sensor is the Copper Brute II outlet sensor, or when installed, the system supply sensor.

Model 500/750		Model 1.0MM		Model 1.25–2.0MM	
% PID Output	# of Stages	% PID Output	# of Stages	% PID Output	# of Stages
51 - 100	2	67-100	3	76 - 100	4
		34 – 66	2	51 – 75	3
1 – 50	1	1 - 33	1	26 – 50	2
				1 – 25	1
0	0	0	0	0	0

Table 17. PID Temperature Control, PID Output Stage Firing

6.E.1.b Additional Settings

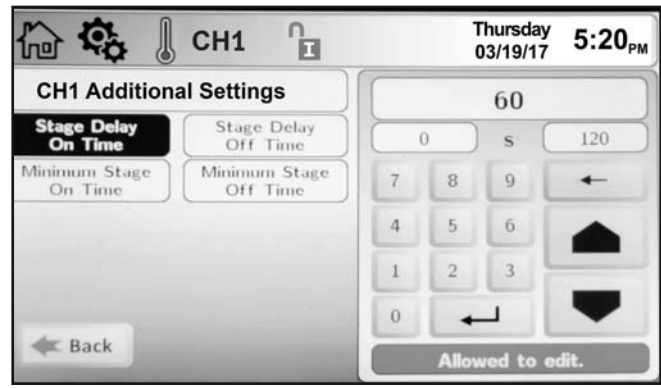

Screen 20. CH1/DHW1 Additional Settings Screen

The CH1/DHW1 Additional Settings Screen allows the adjustment of the following parameters:

- **Stage Delay On Time** – The amount of time that must elapse prior to turning on the next stage.
- **Stage Delay Off Time** – The amount of time that must elapse prior to turning off the next stage.
- **Minimum Stage On Time** – The minimum time that a stage must be on before it is allowed to turn off.
- **Minimum Stage Off Time** – The minimum time that a stage must be off before it is allowed to turn on.

NOTE: These setting only apply to Temperature Differential control.

6.E.2 CH2/DHW2

CH2/DHW2 has all the same parameters as CH1/DHW1.

NOTE: CH2 applies to hydronics units (boilers), while DHW2 applies to volume water units (water heaters).

The PID control algorithm gives an output signal from 0 – 100% and makes a decision to turn a stage on/off based on the table below.

6.E.3 DHW/DHW3

To navigate to the DHW/DHW3 Screen, touch the DHW faucet icon on the Configure Screen.

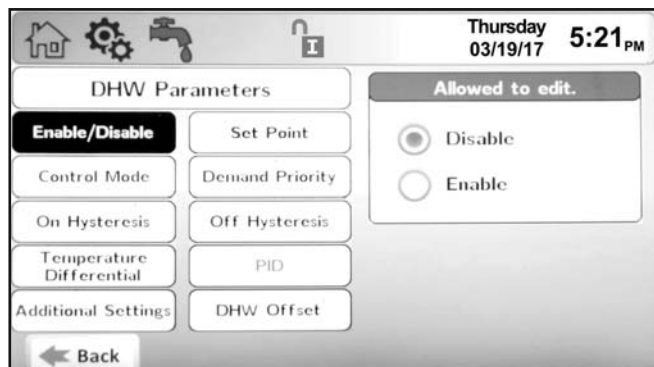

Screen 21. DHW/DHW3 Configuration Screen

DHW/DHW3 has all the same parameters as CH1/DHW1 and CH2/DHW2 with one exception. DHW/DHW3 has the following additional parameter for adjustment:

- **DHW Offset** – Upon a DHW/DHW3 heat demand, the Copper Brute II will control the boiler/heater outlet temperature to the DHW Set Point plus the DHW Offset (set point + DHW Offset). For example, with a DHW/DHW3 Set Point of 140°F and a DHW Offset of 40°F, the Copper Brute II will control the boiler/heater outlet temperature to 180°F (140°F + 40°F) to satisfy the heat demand.

NOTE: A DHW/DHW3 heat demand can be initiated by an aquastat or sensor, see Sections 5.C.1.b on page 32 and 5.C.1.d on page 32 respectively.

6.E.4 Outdoor Reset

Outdoor Reset is applicable to hydronic units only, and since this functionality is not mandatory, it can be enabled/disabled on the outdoor reset configuration screen. Outdoor Reset varies the control set point based on the outdoor temperature. The Outdoor Reset parameters are:

When there is an active outdoor reset condition, the control set point (CSP) will vary from the programmed set point. For example, in the Boiler Status Window shown below, the Outdoor Ambient Temperature (OAT) is 88 °F. This OAT forces the non-DHW heat demand set point to the low point of the outdoor reset curve, which in the graph below is 140 °F. In the Boiler Status Window shown in Figure 27, the CH1 heat demand is active and the programmed set point is 180 °F, however, due to the OAT, the CSP is 140 °F – which is the temperature the Copper Brute II will control to.

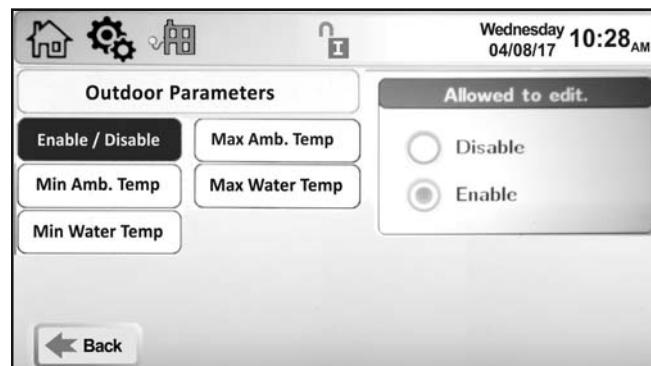

Screen 22. Outdoor Parameters Screen

The Outdoor Parameters Screen allows the adjustment of the following parameters:

- **Enable/Disable** – Enables and disables the outdoor reset functionality.
- **Maximum Ambient Temperature** – The outdoor temperature at which the Copper Brute II will limit the boiler outlet temperature to the Minimum Water Temperature.
- **Minimum Ambient Temperature** – The outdoor temperature at which the Copper Brute II will maximize the boiler outlet temperature to the Maximum Water Temperature.
- **Maximum Water Temperature** – The maximum boiler outlet temperature based on the Minimum Ambient Temperature.
- **Minimum Water Temperature** – The minimum boiler outlet temperature based on the Maximum Ambient Temperature.

<u>Setpoint</u>		<u>Boiler Status</u>	
CSP:	140°F	B1:	Running
CH1:	180°F	B2:	Running
CH2:	170°F	Stage 1:	On
DHW:	120°F	Stage 2:	On
		Stage 3:	On
		Stage 4:	On
		Blower 1:	High
		Blower 2:	High
<u>Pumps</u>		OAT:	88 °F
Boiler:	On		
System:	On		
DHW:	Off		

Figure 27. Boiler Status Window.
CSP with an active outdoor reset condition

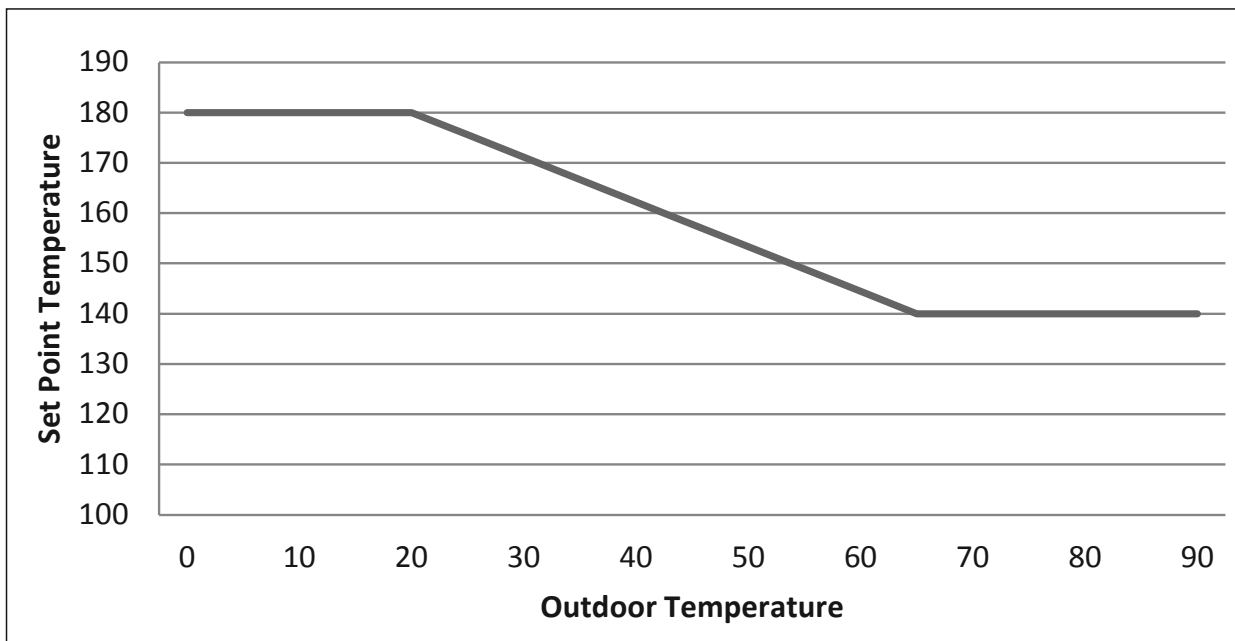

Table 18. Outdoor Reset Curve.

6.E.5 Cascade

An installation with two or more Copper Brute II's may be configured for cascade operations. A maximum of 8 units can be configured in a cascade installation. One Copper Brute II will be configured as the lead unit, with the remaining Copper Brute IIs configured as lag units. Refer to Section 5.C on page 32 for details on wiring for cascade communication between the lead and lag units.

A system supply sensor must be installed and connected to the lead boiler/heater, see Section 5.C.1.d on page 32 – Temperature Sensors. The lead boiler will use this system supply sensor as the temperature control sensor for cascade operations.

A system pump may be wired to the lead Copper Brute II, refer to Section 5.B.3 on page 31 for wiring and 6.E.6 on page 58 for pump configuration.

A cascade heat demand is made at the lead Copper Brute II using CH1/DHW1, external demand (0-10VDC or 4-20mA), or through an RS485 Building Management System (BMS) heat demand command.

Access the Cascade Configuration Screen by selecting Configuration/Cascade.

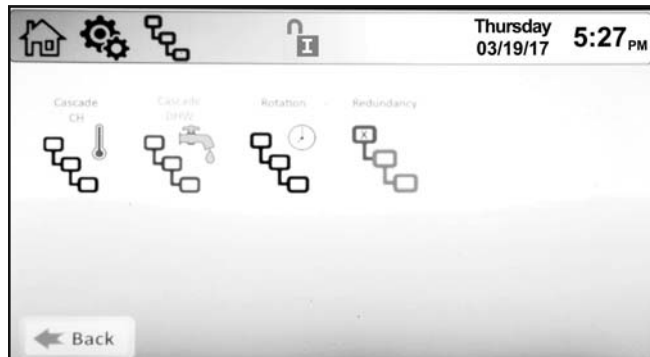

Screen 23. Cascade Configuration Screen

The Cascade Screen provides four navigation icons to configure the system for cascade operations. These navigation icons are:

- **Cascade CH** – This icon navigates to the setup screen for hydronic cascade operations. This icon is available on hydronic units only (boilers).
- **Cascade DHW** – This icon navigates to the setup screen for volume water cascade operations. This icon is available on volume water units only (water heaters).
- **Rotation** – This icon navigates to the cascade rotation screen.
- **Redundancy** – This icon navigates to the setup screen for cascade Leader redundancy functionality.

6.E.5.a Configure Lead Unit

To configure a Copper Brute II as the lead unit, navigate to the Cascade Parameters Screen, shown below, and set the Address to “0”. The Copper Brute II is now configured as the lead boiler/heater. Setting the address to a “-1” takes the unit out of cascade mode.

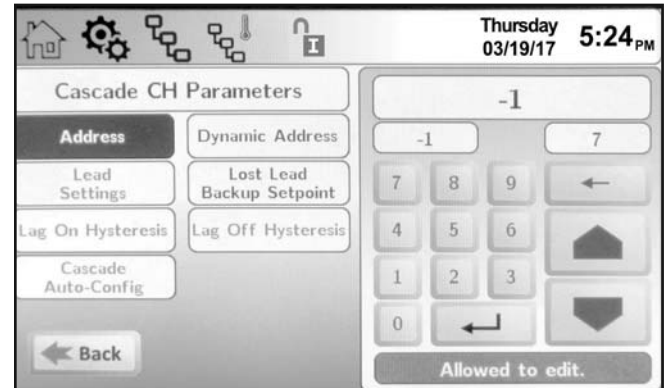

Screen 24. Cascade Parameters

Once configured as the lead Copper Brute II, the “Lead Settings” button becomes selectable. Touching this button navigates to the “Lead Settings” screen.

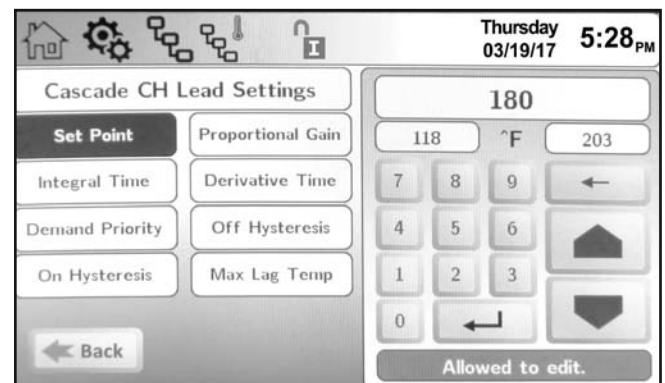

Screen 25. Lead Settings

The Lead Settings Screen allows adjustment of the following parameters:

Set Point – This parameter is the system supply temperature the cascade heat demand is trying to satisfy.

Proportional Gain – This value is the corrective action that is proportional to the error (set point – control temperature). Increasing this parameter increases the response to the error.

Integral Time – This value is applied to the sum of the error over a period of time. Adding the integral term can help to achieve the set point.

Derivative Time – This value is applied to the rate of change of the error. Adding the derivative term can help with sudden changes in temperature, and may help prevent overshooting.

Demand Priority – This parameter sets the heat demand priority in relation to other heat demands. The higher the number, the higher the priority it is assigned.

Off Hysteresis – The temperature above the set point (Set Point + Off Hysteresis) at which the controller will turn off all stages.

On Hysteresis – The temperature below the set point (Set Point – On Hysteresis) at which the controller begins to turn on stages.

Max Lag Temp – The maximum outlet temperature the cascaded boilers/heaters are allowed to supply the system at their individual boiler/heater outlet water sensor.

The home screen of the lead boiler will reflect information regarding the cascade set up. See Screen 60. The C-CH is the set point of the Cascade CH system. An active heat demand is reflected by the cascade icon shown in the lower right hand section of the home screen, and the set point will be shown in green text. If configured for Cascade DHW, the cascade set point will be shown to the right of C-HW. The home screen will also reflect the address and number of units cascaded. In the image below, this unit is configured with an address “0” and is therefore the lead boiler/heater. The lead boiler/heater is denoted by the “M” in the “M of 4”. The “4” in the “M of 4” indicates that there are 4 boilers/heaters cascaded together. The CSP will reflect the “Max Lag Temp” which is the maximum outlet temperature the cascaded boilers/heaters are allowed to supply the system.

6.E.5.b Configure Lag Unit

To configure a Copper Brute II as a lag unit, navigate to the Cascade Parameters Screen, shown below, and set the Address to any number from 1 to 7. The lead boiler is configured as a “0”, therefore, the 8th cascaded boiler is configured with an address of 7. Setting the address to a “-1” takes the unit out of cascade mode.

To automatically configure lag units, after configuring the lead unit, press the Cascad Auto-Config on the Lead unit and it will automatically address the lag units.

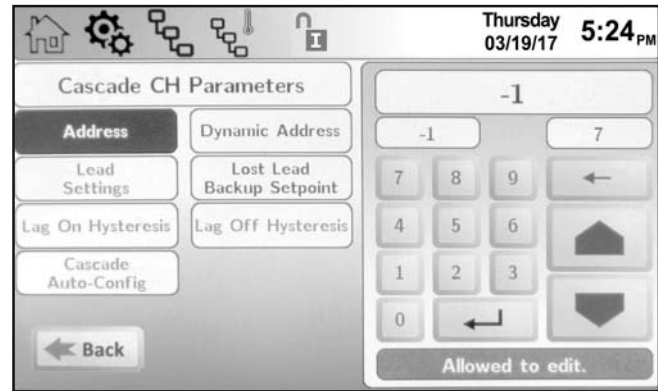

Screen 26. Lag On, Lag Off Hysteresis

Once configured as a lag unit, the “Lag On Hysteresis” and “Lag Off Hysteresis” buttons are selectable. These parameters have the following functionality:

Lag On Hysteresis – the value below the “Max Lag Temp” (Max Lag Temp – Lag On Hysteresis) that the boiler/heater will turn on to satisfy an active cascade demand, based on their local outlet water sensor.

Lag Off Hysteresis – the value above the “Max Lag Temp” (Max Lag Temp + Lag Off Hysteresis) that the boiler/heater will turn off when satisfying an active cascade demand, based on their local outlet water sensor.

Lag boilers/heaters control to their outlet temperature, using the “Max Lag Temp” as the outlet temperature set point. With an active demand from the lead boiler/heater, the lag boilers/heaters will cycle on/off based on the “Lag On Hysteresis” and “Lag Off Hysteresis” set at each individual lag unit. A message will indicate when a unit is off due to a 'Max Lag Temp' condition.

The home screen of a lag boiler will reflect information regarding the cascade set up. See Screen 27.

The C-CH is the set point of the Cascade CH system. If configured for Cascade DHW, the cascade set point will be shown to the right of C-HW. The home screen will also reflect the address and number of units cascaded. In the image below, this unit is configured with an address “1” and is therefore a lag boiler/heater, and is 1 of 4 cascaded units. An active heat demand from the lead boiler is indicated by the cascade icon shown in the lower right hand portion of the home screen. The CSP will reflect the “Max Lag Temp” which is the maximum outlet temperature the cascaded boilers/heaters are allowed to supply the system. The “Max Lag Temp” parameter is covered in the lead boiler/heater settings.

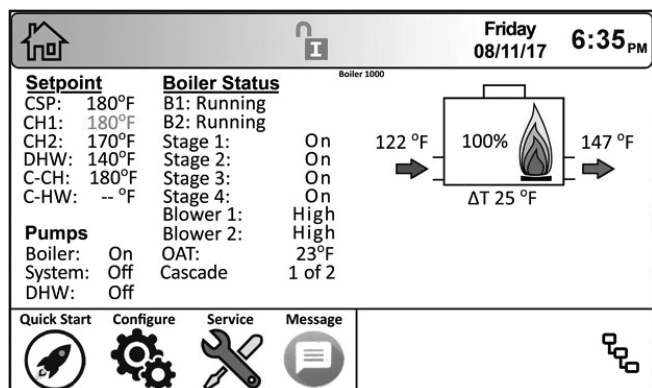

Screen 27. Home Screen of a Lag Boiler

6.E.5.c Cascade CH

An installation with two or more Copper Brute IIs may be configured for cascade operations. A maximum of 8 units can be cascaded.

To navigate to the Cascade CH Configuration Screen, touch the Cascade Icon on the Configure Screen, then touch the Cascade CH Icon on the Cascade Configuration Screen.

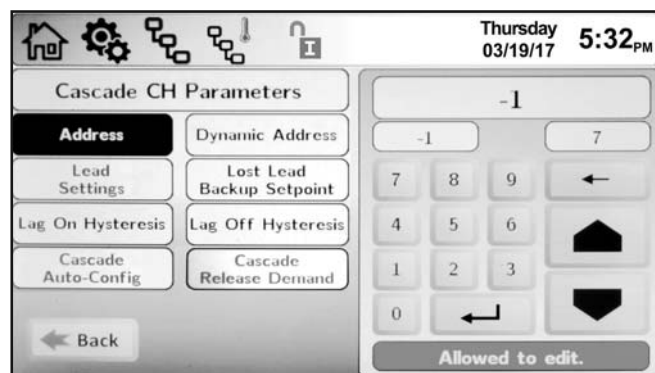

Screen 28. Cascade CH Configuration Screen

The Cascade CH Configuration Screen allows adjustment of the following parameters:

- **Address** – When manually addressing each boiler/heater for cascade operations, this parameter is used to set the local boiler/heater address. Each boiler/heater must have a unique address. A boiler/heater with a value of 0 is the lead boiler/heater. Lag boilers/heaters use values 1 through 7.

When automatically addressing each boiler/heater, set the lead boiler/heater to a value of 0. With a value of 0, the Cascade Auto-Config button is available to use, refer to this parameter below for instructions for automatic addressing the lag boilers/heaters.

- **Dynamic Address** – This function is used for

individual boiler servicing as it will remove the boiler/heater from cascade operations.

Click into Dynamic Address and set this parameter to -1. When finished, return this number to it's previously assigned number.

- **Lead Settings** – This button is only selectable when configured as the lead boiler/heater. When configured as the lead boiler/heater, touching this button navigates to the Lead boiler/heater settings.

- **Lost Lead Backup Set Point** – This is used for cascade redundancy, see Section Screen 31 on page 57. When configured for Cascade Redundancy - Boiler Internal Set Point, this parameter is the maximum outlet temperature the local boiler/heater is allowed to supply the system.

- **Lag On Hysteresis** - The value below the Max Lag Temp (Max Lag Temp – Lag On Hysteresis) that the boiler/heater will turn on to satisfy an active cascade demand, based on the local boiler/heater outlet water temperature. Max Lag Temp is set at the Lead boiler/heater.

- **Lag Off Hysteresis** - The value above the Max Lag Temp (Max Lag Temp + Lag Off Hysteresis) that the boiler/heater will turn off when satisfying an active cascade heat demand, based on the local boiler/heater outlet water temperature. Max Lag Temp is set at the Lead boiler/heater.

- **Cascade Auto-Config** – This is only adjustable at the lead boiler/heater. Once configured as the lead boiler/heater, pressing this button will initiate the lead boiler/heater to find and address all lag boilers automatically.

NOTE: All boilers/heaters must be wired for cascade operations prior to performing Cascade Auto-Config.

- **Cascade Release Demand** - When communications with the master is lost and the lag units continue to satisfy the cascade heat demand, pressing this button will remove the heat demand. **NOTE:** This only applies when configured for cascade - Boiler Internal Set Point Control.

6.E.5.d Cascade DHW 

To navigate to the Cascade DHW Configuration Screen, touch the Cascade Icon on the Configure Screen, then touch the Cascade DHW Icon on the Cascade Configuration Screen.

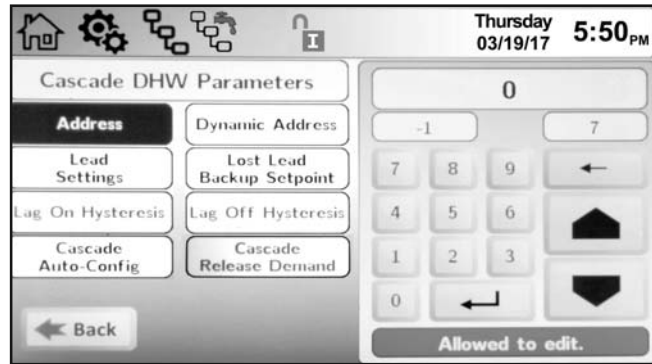

Screen 29. DHW Configuration Screen

Cascade DHW has the same parameters and setup as Cascade CH

NOTE: Cascade DHW applies to volume water (water heaters) units only.

6.E.5.e Rotation 

To navigate to the Cascade Rotation Screen, touch the Cascade Icon on the Configure Screen, then touch the Rotation Icon on the Cascade Configuration Screen.

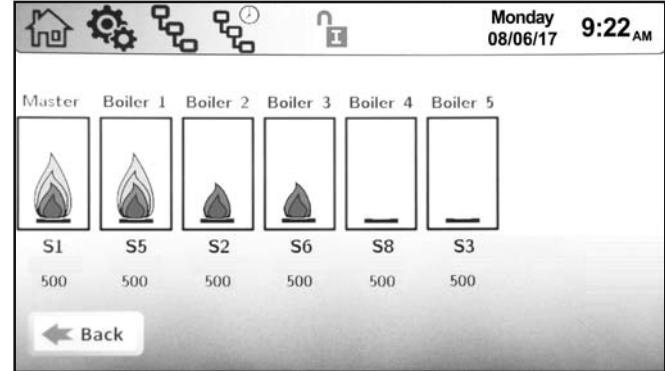

Screen 30. Cascade Rotation Screen

The Cascade Rotation Screen is a view only screen. This screen indicates how many Copper Brute II units are connected in a cascade configuration, the order in which each unit will run, and the percent at which each Copper Brute II is running.

6.E.5.f Cascade Redundancy

To navigate to the Cascade Redundancy Screen (Loss of Lead Setup), touch the Cascade Icon on the Configure Screen, then touch the Redundancy Icon on the Cascade Configuration Screen.

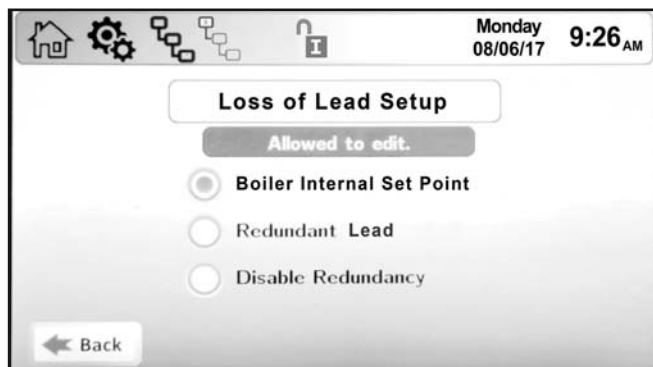

Screen 31. Cascade Redundancy Screen (Loss of Leader Setup)

In circumstances where the communication link between the lead and lag units has been disrupted, there are three options for how lag units respond to this disruption.

The Cascade Redundancy Screen allows the selection of one of three options for redundancy in cascade operations.

These options are:

Option 1: Boiler Internal Set Point – With this option selected, in a cascade configuration, upon loss of communication with the lead Copper Brute II, the lag units will continue to operate. When running in this mode, the lag boiler will use the “Loss Lead Backup Set Point” parameter as the local boiler CSP. The “Loss Lead Backup Set Point” parameter is configured on the Cascade Parameter Screen. If communication to the lead boiler/heater is restored, the lag units will respond to the lead boiler/heater commands without user intervention. All lag units must have this option enabled for this functionality to work, as well as the Loss Lead Backup Set Point configured. If the lag boilers/heaters are not firing when communication with the lead unit is lost, they will not fire to satisfy a cascade heat demand until communications with the lead boiler/heater is restored.

Option 2: Redundant Leader – With this option selected, in a cascade configuration, upon loss of communication with the lead Copper Brute II, the lag boiler with the address of 1 will assume lead boiler responsibilities. This requires that the lead unit (address 0) and redundant lead (address 1) be addressed manually. The remaining cascaded units can be configured manually or automatically. This requires

that the boiler/heater with the address of 1 have the same settings as the lead unit. This also requires that the boiler/heater with the address of 1 have a system supply sensor installed, and if applicable a system pump, or pump contactor. **All cascaded units must have this option selected for this functionality to work.**

Option 3: Disable Redundancy – With this option selected, in a cascade configuration, upon loss of communication with the lead Copper Brute II, all lag boilers will no longer satisfy the cascade heat demand.

6.E.5.g Hybrid



NOTE: This Hybrid Screen is not currently active, but is included for future integration of Bradford White condensing products.

To navigate to the Hybrid Configuration Screen, touch the Hybrid Icon on the Configure Screen.

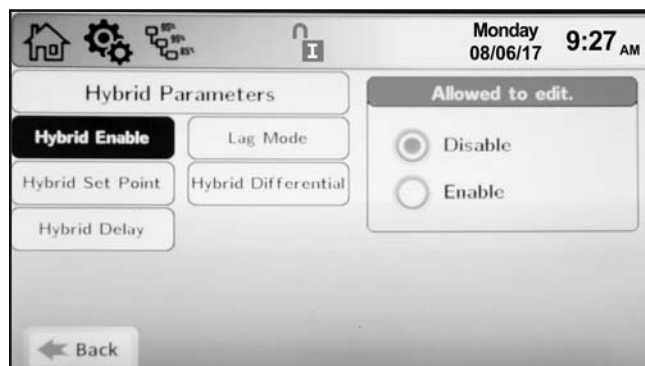

Screen 32. Hybrid Configuration Screen

The Hybrid Configuration Screen allows adjustment of the following parameters:

- **Hybrid Enable** – This parameter allows Hybrid Mode to be enabled or disabled.
- **Lag Mode** – This parameter allows Lag Mode to be enabled or disabled.
- **Hybrid Set Point** – Based on the system return temperature, with Hybrid Mode enabled, this temperature set point determines which type of boiler (condensing or non-condensing) runs first to satisfy a heat demand.
- **Hybrid Differential** – This parameter is a +/- offset of the Hybrid Set Point used to prevent condensing in non-condensing units.
- **Hybrid Delay** – This parameter is a time delay that, in addition to Hybrid Differential, is used to prevent condensing in non-condensing units.

6.E.6 Pumps

The Copper Brute II allows control of three pumps: boiler/heater pump, system pump, and DHW pump. Each pump has an adjustable post circulation time that allows the pump to run after a heat demand has been satisfied or a shutdown condition has occurred. See Section 5.B.2 on page 31. For wiring information, see Section 6.2.6 pump configuration information.

Boiler/Heater Pump

Upon a heat demand, the boiler/heater pump can be configured to operate as follows:

- Auto** – the pump will turn on automatically upon a call for heat.
- Always On** – the pump will run continuously, with or without a heat demand.
- Off During DHW** – the pump will not turn on during a DHW heat demand.

DHW Pump

Upon a heat demand, the boiler/heater pump can be configured to operate as follows:

- Auto** – the pump will turn on automatically upon a call for heat.
- Always On** – the pump will run continuously, with or without a heat demand.
- Disable** – the pump will not turn on upon a DHW heat demand.

System Pump

Upon a heat demand, the system pump can be configured to operate as follows:

- Auto** – the pump will turn on automatically upon a call for heat.
- Always On** – the pump will run continuously, with or without a heat demand.
- Off During DHW** – the pump will not turn on during a DHW heat demand.
- Disable** – the pump will not turn on during a call for heat.

To navigate to the Pump Configuration Screen, touch the Pump Icon on the Configure Screen.

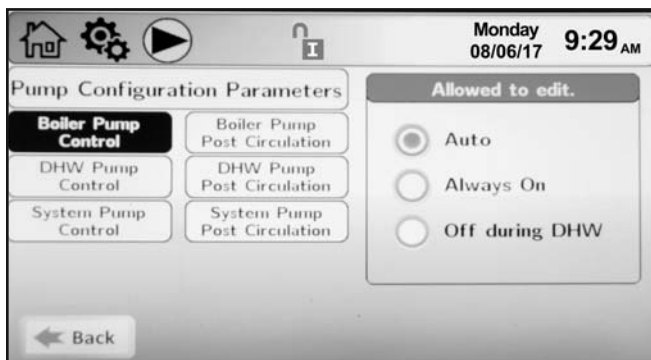

Screen 33. Pump Configuration Screen

The Pump Configuration Screen allows adjustment of the following parameters:

- **Boiler Pump Control** – The parameter provides the ability to set the boiler pump functionality to be: Auto, Always On, or Off during DHW.
- **Boiler Pump Post Circulation** – This parameter is the amount of time the boiler/heater pump will continue to run after a heat demand has been satisfied or after a lock-out condition has occurred.
- **DHW Pump Control** – This parameter provides the ability to set the DHW pump functionality to be: Auto, Disabled, or Always On.
- **DHW Pump Post Circulation** – This parameter is the amount of time the DHW pump will continue to run after a heat demand has been satisfied or after a lock-out condition has occurred.
- **System Pump Control** – This parameter provided the ability to set the system pump functionality to be: Auto, Always On, Off during DHW, or Disabled.
- **System Pump Post Circulation** – This parameter is the amount of time the System pump will continue to run after a heat demand has been satisfied or after a lock-out condition has occurred.

6.E.7 Firing Rate

Firing Rate refers to smooth modulation and is not applicable to the stage fired Copper Brute II.

		Model Size		
		500/750	1MM	1.25-2MM
Stage 4	Blocked			AR - (5*SLH) = Blocked 195°F - (5*2°F) = 185°F
	Unblocked			AR - (6*SLH) = Unblocked 195°F - (6*2°F) = 183°F
Stage 3	Blocked			AR - (3*SLH) = Blocked 195°F - (3*2°F) = 189°F
	Unblocked			AR - (4*SLH) = Unblocked 195°F - (4*2°F) = 187°F
Stage 2	Blocked	AR - SLH = Blocked 195°F - 2°F = 193°F	AR - SLH = Blocked 195°F - 2°F = 193°F	AR - SLH = Blocked 195°F - 2°F = 193°F
	Unblocked	AR - SLH = Blocked 195°F - 2°F = 193°F	AR - (2*SLH) = Unblocked 195°F - (2*2°F) = 191°F	AR - (2*SLH) = Unblocked 195°F - (2*2°F) = 191°F
Stage 1	Blocked	AR 195°F	AR 195°F	AR 195°F
	Unblocked	AR - RD 195°F - 5°F = 190°F	AR - RD 195°F - 5°F = 190°F	AR - RD 195°F - 5°F = 190°F

The number of available stages varies based on boiler/heater size and identifies when stages will be blocked/unblocked. The equations apply to both Boiler and Heater units.

- Stage Limit Hysteresis (SLH) = 2°F
- Auto Reset (AR) = 195°F (boilers)
- Reset Differential (RD) = 5°F

Table 19. Boiler/Heater blocking parameters

6.E.8 Temp Limits

To navigate to the Temp Limits Configuration Screen, touch the Temp Limits Icon on the Configure Screen (2nd Row).

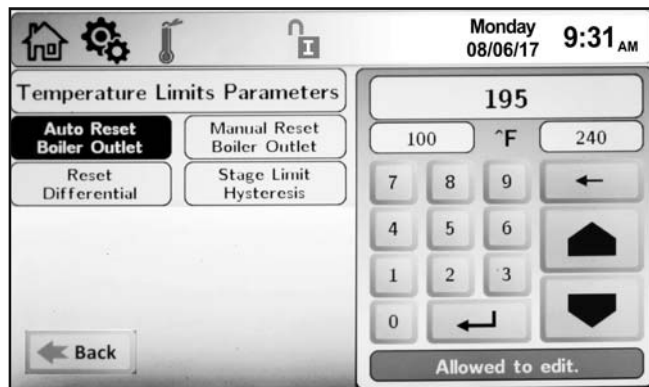

Screen 34. Temp Limits Configuration Screen

The Temp Limits Configuration Screen allows adjustment of the following parameters:

- **Auto Reset Boiler Outlet**– The temperature at which the Copper Brute II with shutdown on an outlet temperature auto reset condition.
- **Manual Reset Boiler Outlet**– The temperature at which the Copper Brute II will shut down on an outlet temperature manual reset condition.
- **Reset Differential** – The value below the Auto Reset temperature at which the Copper Brute II will automatically reset itself and resume functionality.
- **Stage Limit Hysteresis** – The temperature at which a staging boiler / heater will begin to block, or de-rate, to avoid tripping limits.

6.E.9 External

To navigate to the External Configuration Screen, touch the External Icon on the Configure Screen.

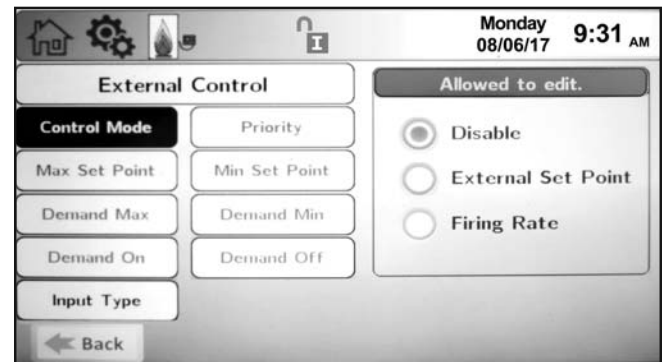

Screen 35. External Configuration Screen

The External Configuration Screen applies to the 0-10VDC (4-20mA) analog input BAS signal, and allows adjustment of the following parameters:

- **Control Mode** – This parameter provides the ability to either disable external control or configure the Copper Brute II for External Set Point or Firing Rate control mode.
- **Priority** – This parameter sets the heat demand priority in relation to other heat demands. The higher the number, the higher the priority it is assigned.
- **Max Set Point** – When the Control Mode is set to External Set Point, this is the maximum value that corresponds to the Demand Max value.
- **Min Set Point** – When the Control Mode is set to External Set Point, this is the minimum value that corresponds to the Demand Min value.
- **Demand Max** – This is the maximum value that corresponds to the control mode selected.

With Firing Rate control mode selected, this is the maximum rate at which the boiler/heater will run. The unit of this parameter is %, so if the value of this parameter is 10000, or 100.00%, this equates to 10.0VDC or 20mA.

- **Demand Min** – This is the minimum value that corresponds to the control mode selected. With Firing Rate control mode selected, this is the minimum rate at which the boiler/heater will run. The unit of this parameter is %, so if the value of this parameter is 2000, or 20.00%, this equates to 2.0VDC or 4.8mA.

- **Demand On** – This is the threshold (VDC/ mA) at which the input signal will initiate the selected control mode behavior. The unit of this parameter is %, so if the value of this parameter is 1500, or 15.00%, this equates to 1.5VDC or 4.6mA.

- **Demand Off** – This is the threshold (VDC/ mA) at which the input signal will deactivate the selected control mode behavior. The unit of this parameter is %, so if the value of this parameter is 1000, or 10.00%, this equates to 1.0VDC or 4.4mA.

- **Input Type** – This parameter allows the user to select between voltage (0-10VDC) and current (4-20mA) input. Jumpers will need to be configured accordingly. See 5.C on page 32

6.E.9.a External – Remote Set Point

With External Set Point selected, the Copper Brute II will initiate a heat demand once the analog input signal exceeds the Demand On value. Once the demand is initiated, the analog input signal must be lower than Demand Off to remove the heat demand. With an active demand, the Copper Brute II will linearize the set point according to the analog input signal as shown in **Figure 28**.

Using the default values for Boiler Max Set Point (180°F), Boiler Min Set Point (140°F), Demand Minimum (2.5VDC), Demand Maximum (10.0VDC), the Copper Brute II will linearize the set point, according to the formula in **Figure 28**.

External (0 – 10VDC or 4 – 20mA)

An External heat demand can be initiated by a Building Automation System (BAS) using a 0 – 10 VDC or 4 – 20 mA signal. This input can be configured for Remote Set Point or External Firing Rate operations. See Section 5.C.1.e on page 33 for wiring and Section 6.E.11.e on page 64 for configuration information.

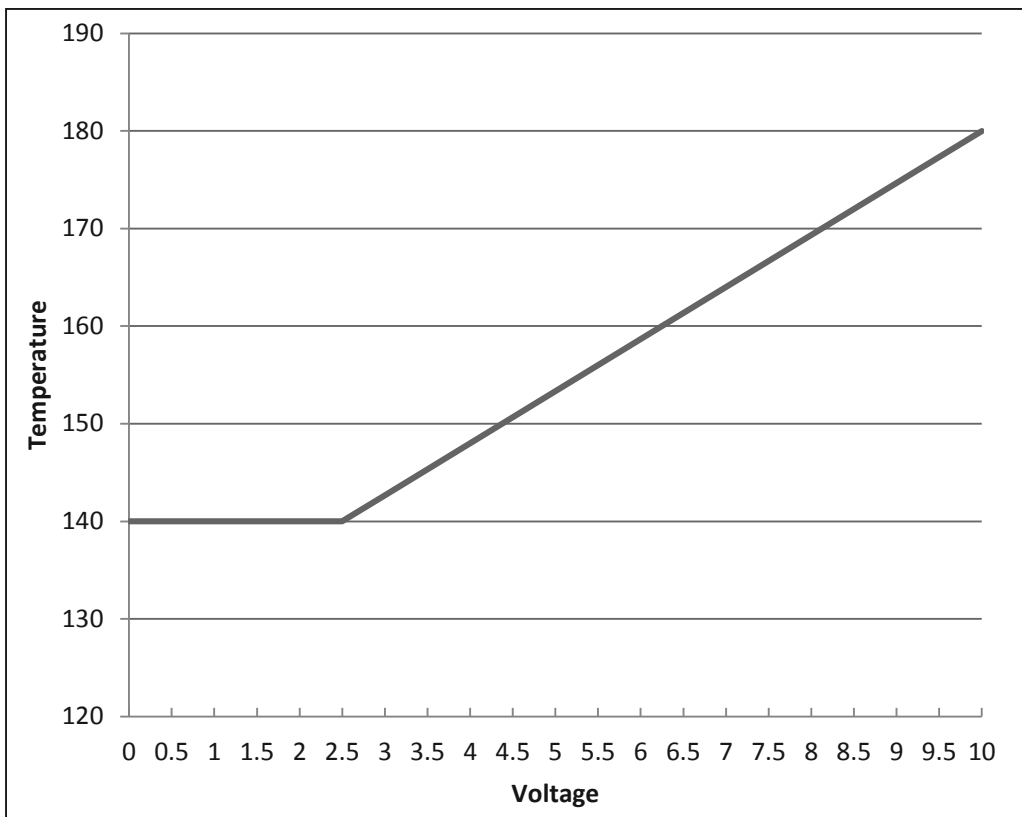

Figure 28. External Control Mode and Temperature

6.E.9.b External Firing Rate

With External Firing Rate selected, the Copper Brute II will initiate a heat demand once the analog input signal exceeds the Demand On value. Once the demand is initiated, the analog input signal must be lower than Demand Off to remove the heat demand. The external analog signal will activate stages based on **Table 20**. In this control mode, if the Copper Brute II outlet temperature exceeds the Auto Reset High Limit setting, the boiler will shut down and an “Auto Reset High Limit” condition will annunciate on the Messages screen. Once the outlet temperature decreases below the value of (Auto Reset High Limit – Reset Differential), the boiler will turn back on at the firing rate set by the analog input signal.

NOTE: Since Low-Temp units are On/Off, using external firing rate will turn all stages on/off once the Demand On Value has been exceeded.

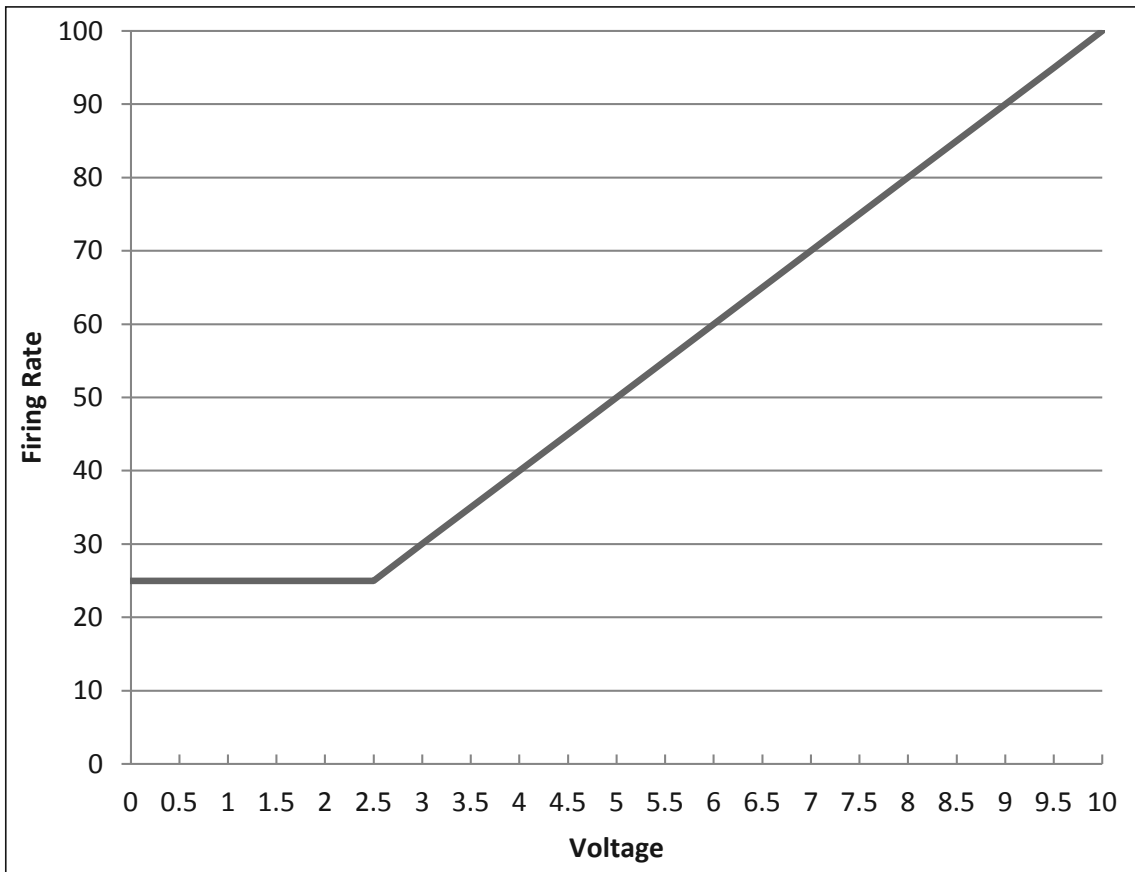

Figure 29. Firing Rate Control

Multi-stage External Demand Firing Rate Control									
Size	Stages	Stage 1		Stage 2		Stage 3		Stage 4	
		On	Off	On	Off	On	Off	On	Off
500 – 750	2	Demand On	Demand Off	6.5VDC 12.8uA	5.5VDC 11.2uA				
1000	3	Demand On	Demand Off	5.1VDC 10.1uA	4.1VDC 8.5uA	7.7VDC 15.4uA	6.8VDC 13.8uA		
1250 – 2000	4	Demand On	Demand Off	4.5VDC 8.8uA	3.5VDC 7.2uA	6.5VDC 12.8uA	5.5VDC 11.2uA	8.5VDC 16.8uA	7.5VDC 15.2uA

Table 20. External Demand - External Firing Rate Control

6.E.10 Setting the Time and Date

To navigate to the Time & Date Configuration Screen, touch the Time & Date Icon on the Configure Screen.

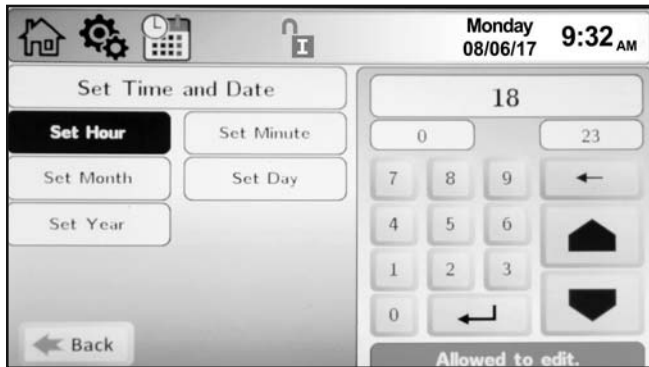

Screen 36. Time & Date Configuration Screen

NOTE: The Time is set in a 24 hour parameter, but displays only as a 12 hour clock with the AM/PM automatically added.

The Time & Date Configuration Screen allows adjustment of the following parameters:

- **Hour** – The hour that will be displayed in the upper banner on each screen, and the time captured in the date/time stamp for lock-out conditions displayed on the history screen.
- **Minute** – The minute that will be displayed in the upper banner on each screen, and the time captured in the date/time stamp for lock-out conditions displayed on the history screen.
- **Month** – The month that will be displayed in the upper banner on each screen, and the date captured in the date/time stamp for lock-out conditions displayed on the history screen.
- **Day** – The day that will be displayed in the upper banner on each screen, and the date captured in the date/time stamp for lock-out conditions displayed on the history screen.
- **Year** – The month that will be displayed in the upper banner on each screen, and the date captured in the date/time stamp for lock-out conditions displayed on the history screen.

6.E.11 Miscellaneous Features

To navigate to the Miscellaneous Features Screen, touch the Miscellaneous Features Icon on the Configure Screen.

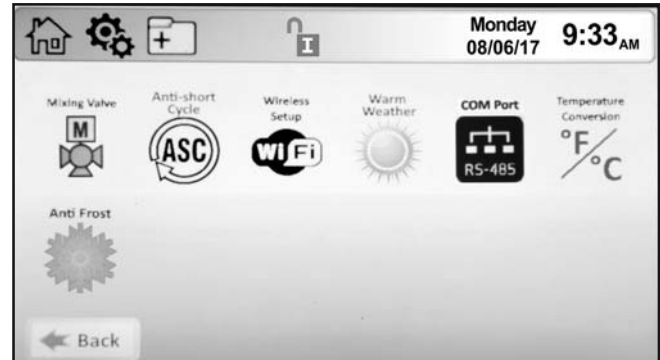

Screen 37. Miscellaneous Features Screen

The Miscellaneous Features screen provides navigation for the following items:

- **Mixing Valve** – This feature applies to Low-Temp Copper Brute IIs.
- **Anti-short Cycle** – This icon navigates to the Anti-short Cycle Configuration Screen.
- **Wireless Setup** – This icon navigates to the Wireless Setup Screen, not available at this time.
- **Warm Weather** – This icon navigates to the Warm Weather Configuration Screen.
- **COM Port** – Icon navigates to a selection menu for either Modbus or BACnet MSTP protocols.
- **Temperature Conversion** – This icon navigates to the Temperature Conversion Configuration Screen.
- **Anti-Frost** – This icon navigates to the Anti-Frost Configuration Screen.

1.a Mixing Valve. Low Temp Copper Brute II

Accessible only on Low Temp Copper Brute II models.

To navigate to the Mixing Valve Configuration Screen, touch the Miscellaneous Features Icon on the Configure Screen, then touch the Mixing Valve Icon on the Miscellaneous Features screen.

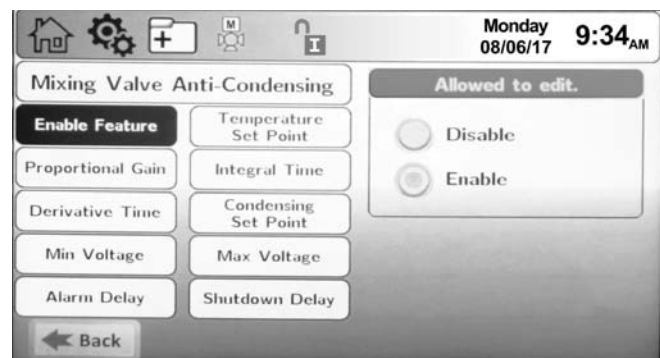

Miscellaneous Features Screen

The Mixing Valve Configuration Screen allows adjustment of the following parameters:

- **Enable Feature** – This allows the mixing valve to be enabled or disabled.
- **Temperature Set Point** – The mixing valve will maintain this temperature at the inlet to the boiler/heater.
- **Proportional Gain** – This value is the corrective action that is proportional to the error (set point – control temperature).
- **Integral Time** – This value is applied to the sum of the error over a period of time.
- **Derivative Time** – The value is applied to the rate of change of the error.
- **Condensing Set Point** – The condensing alarm and shutdown are based on this set point.
- **Min Voltage** – The minimum voltage the controller will send the mixing valve.
- **Max Voltage** – The maximum voltage the controller will send the mixing valve.
- **Alarm Delay** – If the boiler/heater inlet temperature is below Condensing Set Point for the duration of the Alarm Delay time, the boiler/heater will announce a condensing alarm.
- **Shutdown Delay** – If the boiler/heater inlet temperature is below the Condensing Set Point for the duration of the Shutdown Delay time, the boiler/heater will shut down and announce a condensing shutdown condition.

6.E.11.b Anti-Short Cycle

To navigate to the Anti-Short Cycle Configuration Screen, touch the Miscellaneous Features Icon on the Configure Screen, then touch the Anti-Short Cycle Icon on the Miscellaneous Features screen.

After a heat demand has been satisfied, the Copper Brute II will wait the duration of the Anti-Short Cycle Time before satisfying the next heat demand.

NOTE: Anti-Short Cycle does not apply to DHW/DHW3 heat demands.



Screen 38. Anti-Short Cycle Configuration Screen

The Anti-Short Cycle Configuration Screen allows adjustment of the following parameter:

- **Cycle Time** – The amount of time after a heat demand is satisfied that the Copper Brute II will wait to satisfy the next active heat demand.

6.E.11.c Wireless Setup

Wireless control is not available on this version of this Touchscreen Display System

6.E.11.d Warm Weather

Warm Weather Shutdown (WWSD) is applicable to hydronic units only, and since it is not mandatory, it can be enabled/disabled on the WWSD configuration screen. There are three options for WWSD: shutdown immediately, shutdown after demand is satisfied and WWSD disabled. The default option is WWSD disabled. An outdoor sensor must be attached for WWSD operations. A Copper Brute II in a WWSD condition will have a WWSD icon shown on the home screen.

WWSD - Shutdown Immediately

When the outdoor temperature, measured by the outdoor sensor, exceeds the WWSD set point, one of the following two conditions will occur. If the unit is idle, upon a call for heat, the unit will not turn on to satisfy a heat demand. If the unit is running to satisfy a call for heat, the unit will immediately shutdown. In either case, the WWSD icon will appear on the home screen.

WWSD – Shutdown After Demand is Satisfied

When the outdoor temperature, measured by the outdoor sensor, exceeds the WWSD set point, one of the following two conditions will occur. If the unit is idle, upon a call for heat, the unit will not turn on to satisfy a heat demand, and the WWSD icon will be shown on the home screen. If the unit is running to satisfy a call for heat, the unit will satisfy the heat demand and then the WWSD shutdown icon will appear. As long as the unit is in a WWSD condition, no additional heat demands will be satisfied.

WWSD – Disabled

When the outdoor temperature, measured by the outdoor sensor, exceeds the WWSD set point, nothing occurs.

To navigate to the Warm Weather Configuration Screen, touch the Miscellaneous Features on the Configure Screen, then touch the Warm Weather Icon on the Miscellaneous Features screen.



Screen 39. Warm Weather Configuration Screen

The Warm Weather Configuration Screen allows adjustment of the following parameters:

- **Temp Min** – Upon an active warm weather shutdown condition, this is the temperature at which the Copper Brute II will reset the shutdown condition to satisfy a heat demand.
- **Temp Max** – This is the temperature at which the warm weather shutdown condition will occur.
- **Feature Options** – This parameter provides the ability to either disable warm weather shutdown or upon a warm weather condition, configure the Copper Brute II to shut down immediately or to shut down after the current heat demand is satisfied.
- **Summer Kick CH** – This is the amount of time the Copper Brute II pump is energized if it hasn't cycled for an extended period of time.
- **Summer Kick DHW** – This is the amount of time the DHW pump is energized if it hasn't cycled for an extended period of time.
- **Summer Kick SYS** – This is the amount of time the SYS pump is energized if it hasn't cycled for an extended period of time.
- **Summer Kick Period** – The duration of time between heat demands that the boiler will wait before exercising the boiler, DHW, and system pumps.

6.E.11.e COM Port

To navigate to the COM Port Configuration Screen, touch the Misc Icon on the Configure Screen, then touch the COM Port Icon on the Misc Configuration Screen.

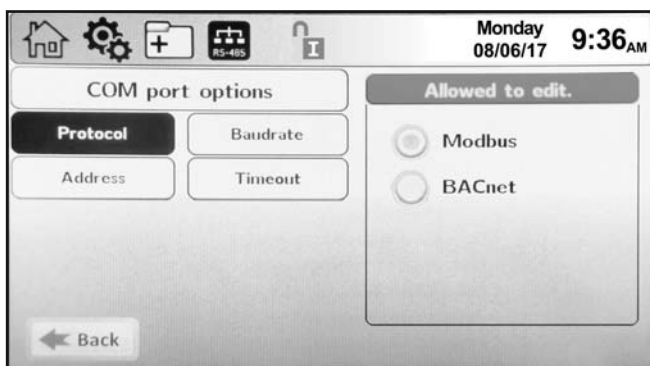

Screen 40. COM Port Config Screen, ModBus

The COM Port Configuration Screen allows adjustment of the following parameters:

- **Protocol** – Allows selection of either Modbus or BACnet MSTP protocols.

NOTE: Changing the protocol requires a power cycle of the unit for the change to take effect.

With Modbus protocol selected, the following parameters are adjustable on this screen:

- **Baudrate** – Modbus can be configured for the following standard baudrates: 9600, 19200, 38400, and 57600.
- **Address** – The address of the Copper Brute II on the Modbus network.
- **Timeout** – Upon loss of communication, this is the duration of time in which the Copper Brute II will wait prior to a timeout conditions occurring.

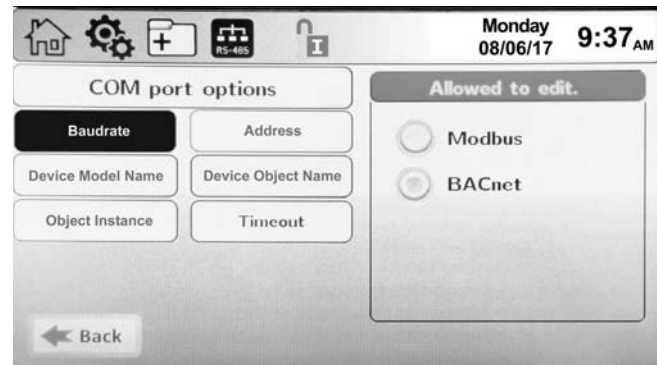

Screen 41. COM Port Config Screen, BACnet

With BACnet protocol selected, the following parameters are adjustable on this screen:

- **Baudrate** – BACnet can be configured for the following standard baudrates: 9600, 19200, 38400, and 76800.
- **Address** – The address of the Copper Brute II on the BACnet network.
- **Device Model Name** – The name of the Copper Brute II Model on the BACnet network.
- **Device Object Name** – The name of the Copper Brute II Object on the BACnet network.
- **Object Instance** – The object number of the Copper Brute II on the BACnet network.
- **Timeout** – Upon loss of communication, this is the duration of time in which the Copper Brute II will wait prior to a timeout conditions occurring.

6.E.11.f Temperature Conversion

To navigate to the Temperature Conversion Configuration Screen, touch the Miscellaneous Features Icon on the Configure Screen, then touch the Temperature Conversion Icon on the Miscellaneous Features screen.

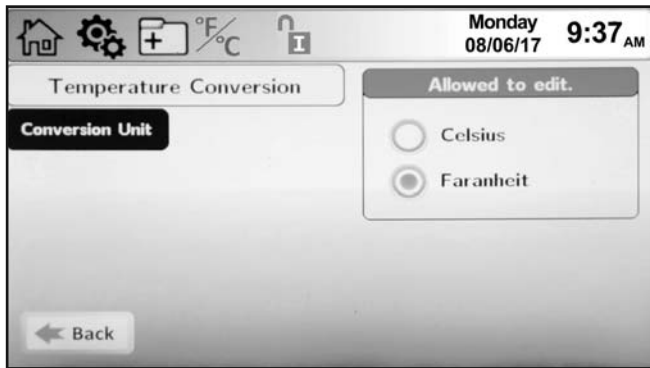

Screen 42. Temp Conversion Config Screen

The Temperature Conversion Configuration Screen allows adjustment of the following parameter:

- **Conversion Unit** – This parameter can be changed between Fahrenheit and Celsius.

6.E.11.g Frost Protection

Frost protection provides some protection for the boiler, and if configured/installed properly, the system as well.

To navigate to the Anti-Frost Configuration Screen, touch the Miscellaneous Features Icon on the Configure Screen, then touch the Anti-Frost Icon on the Miscellaneous Features screen.

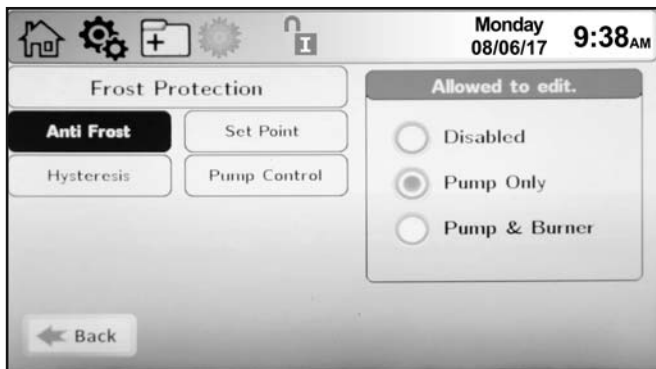

Screen 43. Anti-Frost Configuration Screen

The Anti-Frost Configuration Screen allows adjustment of the following parameters:

- **Anti-Frost** – This parameter provides the ability to either disable anti-frost or upon an anti-frost condition, configure the Copper Brute II to only turn on the pump or to turn on the pump and fire the burner.

- **Set Point** – The temperature at which the Copper Brute II will apply the Hysteresis value to enable the Anti-Frost mode.

- **Hysteresis** – This parameter is a +/- offset of the Anti-Frost Set Point used to turn on/off the Anti-Frost mode.

- **Pump Control** – This parameter provides the ability to select which pump(s) to apply the Anti-Frost Mode to.

Anti-Frost Mode allows an operator to select one of the following three modes: Disabled, Pump Only, Pump and Burner. The Set Point parameter is temperature at which the boiler/heater will apply the Hysteresis value to enable the Anti-Frost mode. For example, if the Set Point is 44°F, and the Hysteresis is 4, the Anti-Frost action will initiate at 40°F (set point – hysteresis) and then will end at 48°F (set point + hysteresis). If Pump Only or Pump and Burner mode is selected, the Pump Control parameter allows configuration of which pump(s) will run during an anti-frost condition. At least one pump must be selected, but all three pumps (Copper Brute II, DHW, or System) can be selected. If Anti-Frost mode is active, a snowflake icon will appear above the Copper Brute II inlet temperature on the home screen. See Figure 30

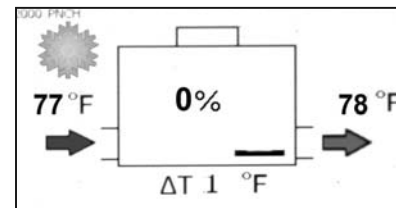
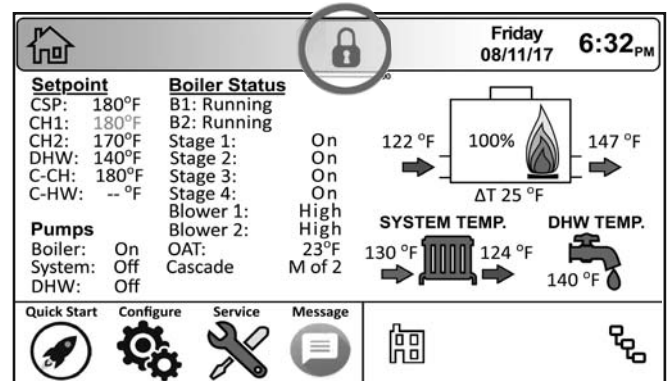

Figure 30. Active Anti Frost Condition

6.E.12 Login

To navigate to the Login Screen, touch the Login Icon on any of the menus. See Section 6.B on page 42



Screen 44. Touch the lock on any screen.

6.F Service Screens

To navigate to the Service Screen, touch the Service Icon in the lower left-hand portion of the Home Screen.

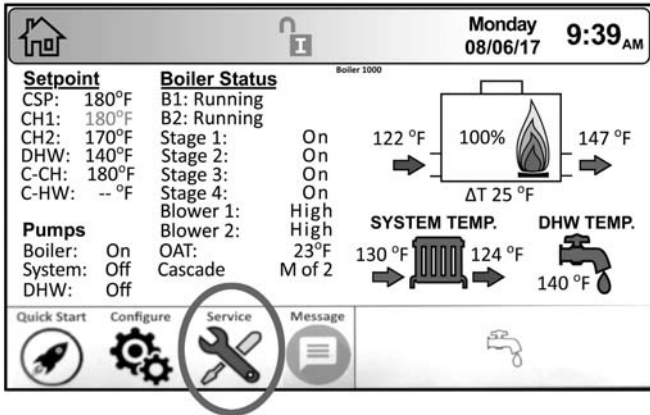

Screen 45. Home Screen

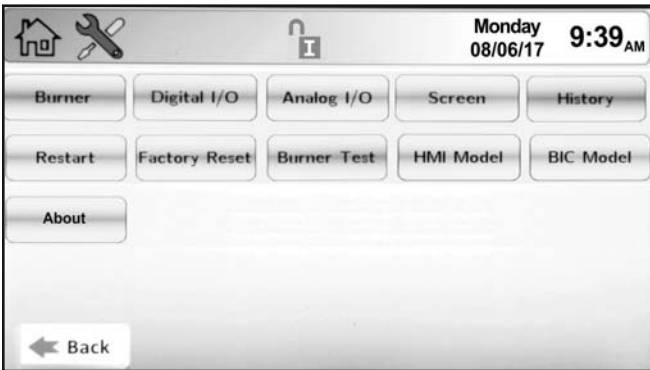

Screen 46. The Service Screen

NOTE: The Navigation Bar does not populate with new icons as you navigate into the various Service Screens.

From the Service Screen, basic diagnostic or service modes can be configured. The following sections give an overview of each service sub menu.

6.F.1 Burner

Navigate to the Burner Screen by touching the Burner Button on the Service Screen.

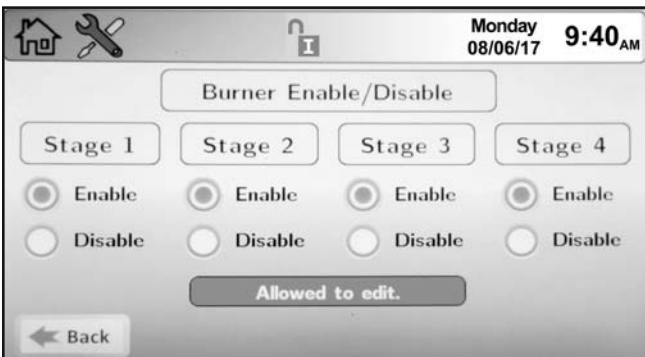

Screen 47. The Burner Screen

The Burner Screen allows each stage to be enabled or disabled for troubleshooting and/or diagnostic purposes. This screen will only display the number of stages associated with the size of the unit. For example, Copper Brute II sizes 500/750 have two stages, size 1000 has three stages, and sizes 1250/1500/1750/2000 have four stages. Low-Temp units are On/Off units only. See Table 11 on page 40

NOTE: The hot surface ignitors (HSI) are associated with Stages 1 and 3. If Stage 1 is disabled, then Stage 2 will automatically be disabled. If Stage 3 is disabled, then Stage 4 will automatically be disabled.

6.F.2 Digital I/O (Input / Output)

Navigate to the Digital I/O Screen by touching the Digital I/O Button on the Service Screen.

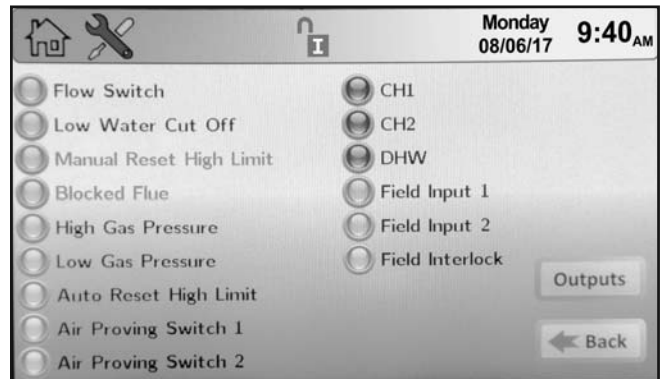

Screen 48. Digital I/O Screen - Inputs

There are two screens associated with the Digital I/O, 1. the Digital I/O Screen – Inputs, see above, and 2. Digital I/O Screen – Outputs, see below.

For digital (on/off) inputs, if the input is satisfied, the indicator light associated with that input is green. For example, if there is adequate flow, the flow switch is satisfied, and the flow switch digital input indicator light is green. Similarly, if the input is not satisfied, the indicator light associated with that input is red. For example, if the blower is off, then the air proving switch is not satisfied and the air proving switch digital input indicator light is red.

For digital (on/off) outputs, if the output is on, the indicator light associated with that output is green. For example, if the boiler pump is running, then the boiler pump output indicator light will be green. Similarly, if the output is off, the indicator light associated with that output is red. For example, if there is no call for heat, then the gas valves are off, and the gas valve indicator lights will be red.

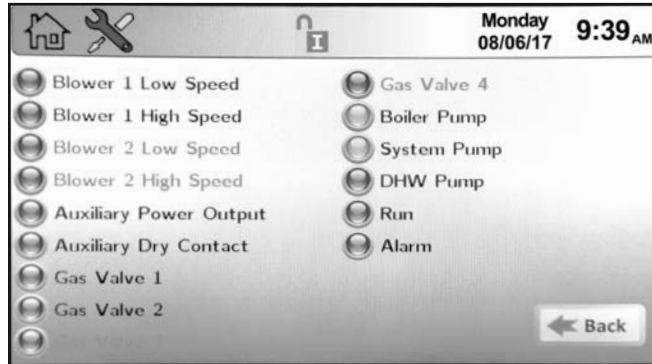

Screen 49. Digital I/O Screen - Outputs

6.F.3 Analog I/O

Navigate to the Analog I/O Screen by touching the Analog I/O Button on the Service Screen.

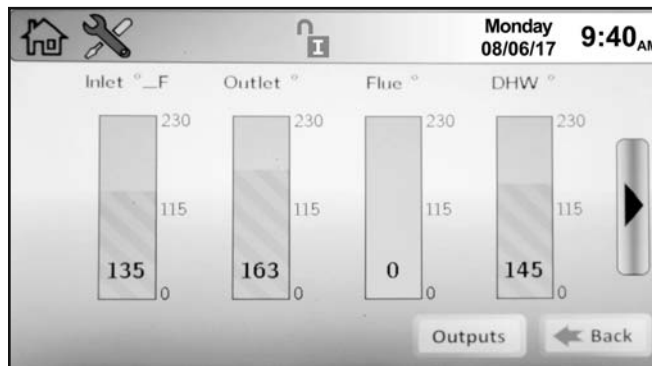

Screen 50. Analog I/O Screen - Inputs

NOTE: Copper Brute II does not use a flue stack sensor.

There are two screens associated with the Analog I/O, the Analog I/O Screen – Inputs, see above, and the Analog I/O Screen – Outputs, see below.

For analog inputs, there are three types of analog inputs: sensors, flame signal, and voltage/current (VDC/mA). Wiring of these inputs are covered in Section 5.C

NOTE: If the input is not attached, the value will be zero.

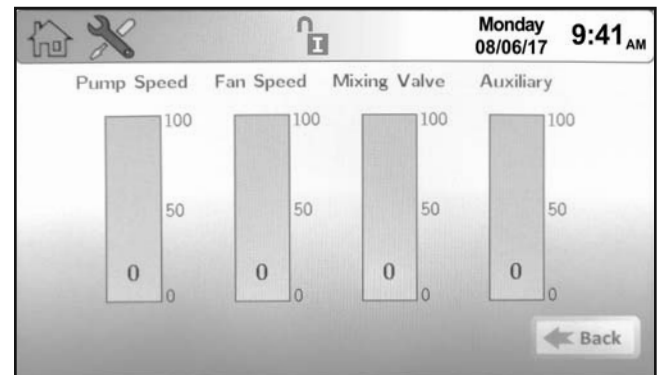

Screen 51. Analog I/O Screen - Outputs

6.F.4 Screen Settings

Navigate to the Screen Settings Screen by touching the Screen Button on the Service Screen.

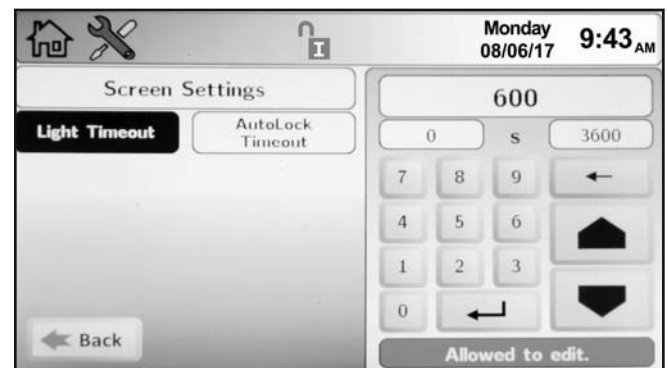

Screen 52. Screen Settings Screen

There are two adjustable screen settings: Light Timeout and AutoLock Timeout. Light Timeout allows the user to adjust the amount of time the touch screen backlight will remain lit after user interaction has ceased. AutoLock Timeout allows the user to adjust the amount of time the touch screen will remain unlocked with no user interaction.

6.F.5 History

Navigate to the History Screen by touching the History Button on the Service Screen.

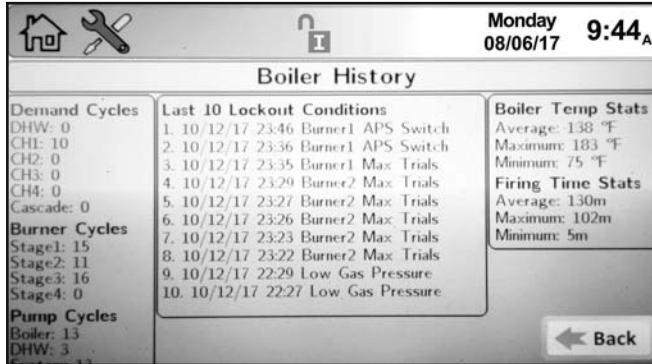

Screen 53. History Screen

The History Screen provides information on boiler operations and cycle counts. The Copper Brute II control accumulates and displays the number of heat demand cycles, burner cycles, and pump cycles. It displays the 10 most recent lock-out conditions, and Copper Brute II temperature and firing statistics.

6.F.6 Restart

Touching the Restart Button on the Service Screen reboots the Copper Brute II display. If the touchscreen seems to be out of alignment, this is used to recalibrate the touchscreen.



Screen 54. Restart Screen

To recalibrate the touch screen. After pressing the Restart Button, promptly touch the touch screen and follow the calibration procedure as shown on the touch screen.

6.F.7 Factory Reset

Touching the Factory Reset Button on the Service Screen resets all touch screen adjustable parameters back to the factory default setting.

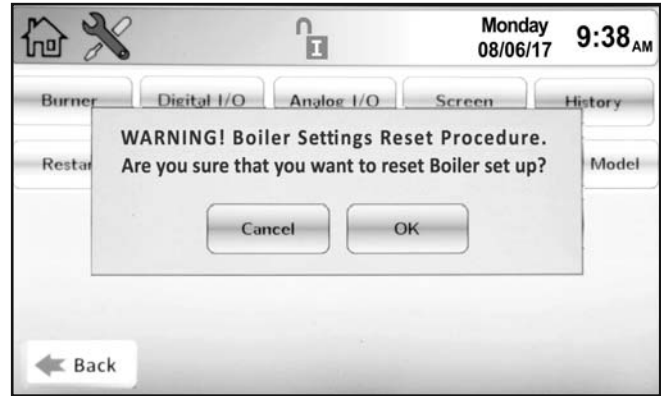

Screen 55. Factory Reset Screen

6.G Messages and USB

6.G.1 Messages

The 'Message' icon at the bottom of the home screen will display an 'Exclamation' when there is a message. Press the icon to see what the message is.

Messages are generally self explanatory and will guide a qualified service technician to the issue or parameter that needs to be adjusted and/or serviced.

A 'Message' will not be a 'Lock-Out' condition which is discussed in Section 10.A on page 78.

Additionally, this area of the home screen will indicate that a USB device has been inserted into the USB port which is located behind the touchscreen display. See Figure 31 on page 69.

6.G.1 Messages

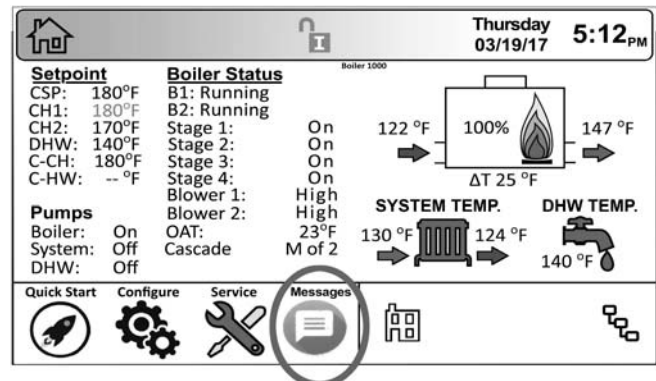

Screen 56. Home Screen, Typical

6.G.2 USB Functionality



The Display has a USB port that can be used to perform the following tasks:

- a. Download parameters from a thumb drive to a boiler.
- b. Upload parameters from a boiler to a thumb drive.
- c. Upload data from the boiler to a thumb drive.

The USB port is integrated into the back of the touchscreen display. To access it, the front panel of the unit must be removed and then the touchscreen removed from it's mounted location. The USB port can then be seen on the back of the touchscreen display.

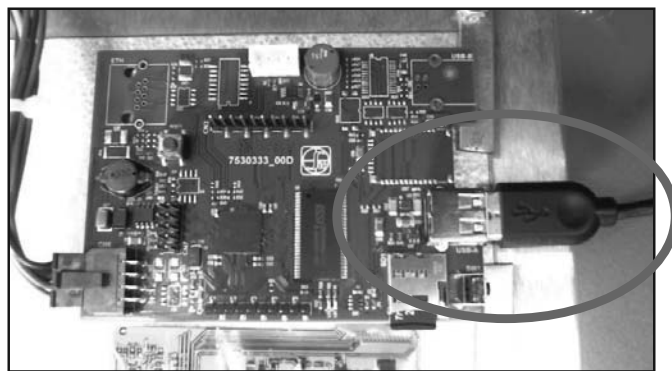
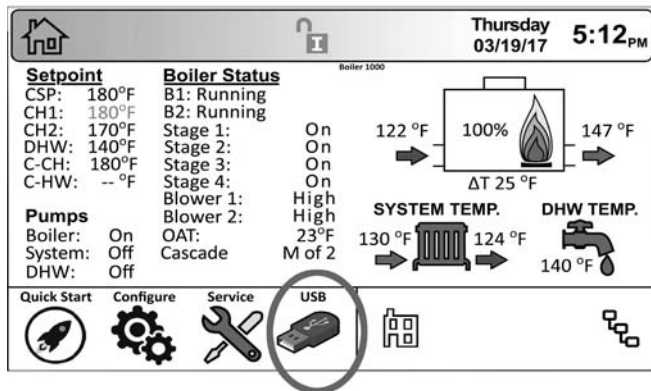

Figure 31. Photo of USB Slot on the back of touchscreen display.

Once a USB thumb drive has been inserted into the USB port, the USB icon will pop up on the home screen.



Screen 57. Home Screen showing USB

Once the USB icon has appeared over the Message icon, you can then select the USB icon and it will switch to the USB menu (See Screen 58). Here you can perform these 3 tasks.

Download Parameters from the boiler: This saves time during a cascade setup or a control replacement where the contractor only has to enter the values in 1 boiler instead of upwards of 8 boilers.

Upload Parameters from the boiler: This feature

is to upload all parameters and settings into a thumb drive for documentation purposes or to be able to copy these settings from boiler to boiler without having to re-enter them individually.

Upload DATA from the boiler: This is used to retrieve runtime data, history, as well as capture all settings in a tab delimited Excel format document.

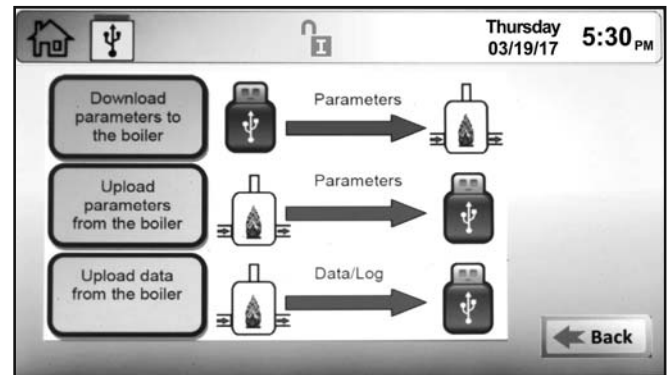

Screen 58. Data Tasks for the USB Port

6.H Active Demands

The Active Demand Window indicates the status of active heat demands.

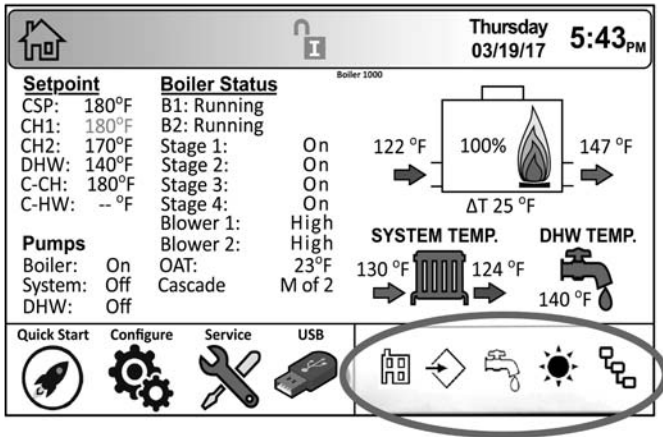

Screen 59. Active Demand Window

The **darker** Active Demand Icon indicates the heat demand that is currently being satisfied. A 'greyed out' Active Demand Icon is either lower in priority than the heat demand that is currently being satisfied, or the heat demand has reached set point, but remains active.

	CH1/2 or DHW1/2
	DHW or DHW3
	External
	Warm Weather Shutdown NOTE: Warm Weather Shutdown is not a heat demand. This icon indicates that a space heating demand is disabled due to high outdoor ambient temperature.
	Cascade

Figure 32. Active Demand Examples

6.I The Navigation Bar

The Navigation Bar is a touch sensitive area at the top left of every screen, that shows you where you are at any time as you navigate into and out of the touchscreens. The further in that you go, the more icons will appear in the Navigation Bar. If you are 4 icons in and want to go back to the Home Screen, simply click onto the Home Icon. If you click onto any icon in the Navigation Bar, you will go to that location directly. If you want to go back just one step, you can click onto the next Icon back, OR use the Back button.



Screen 60. The Navigation Bar

Lock-out Conditions will also display inside the Navigation Bar. Refer to Table 22 on page 80 for a list of possible Lock-out conditions.

6.J Date and Time Display Area

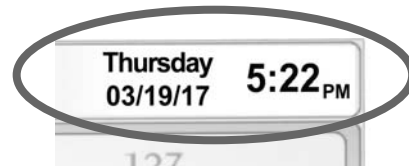

The top right portion of the Home Screen shows the Date and Time. To set the Date and Time, please refer to Section 6.E.10 on page 62.

SECTION 7 Sequence of Operation

7.A Restarting the Copper Brute II

If drained, follow 4.A.6 on page 22 in this manual for proper filling and purging.

1. Switch off the main electrical disconnect switch.
2. Close all manual gas valves.
3. **WAIT FIVE (5) MINUTES.**
4. Set the aquastat or thermostat to its lowest setting.
5. Open all manual gas valves.
6. Reset all safety switches (pressure switch, manual reset high limit, etc.).
7. Set the temperature controller to the desired temperature setting and switch on electrical power.
8. Burner will go through a prepurge period and ignitor warm-up period, followed by ignition.

7.B Sequence of Operation

Copper Brute IIs follow the sequence of operations explained in this section and reflected in the flow chart on the next page.

NOTE: Copper Brute II models 1000 – 2000 have two ignition sources. The controller treats the burners associated with each ignitor as an independent boiler/heater. If one ignitor should fail for any reason, the remaining ignitor and burner(s) will operate independently.

Standby

Upon a call for heat, the pump is energized and once the adequate liquid flow is established, the flow switch is satisfied. If all other safety interlocks are satisfied, the Pre-Purge cycle begins.

Pre-Purge

In Pre-Purge, the Copper Brute II blower turns on high speed and confirms that the Air Proving Switch (APS) transitions from open to closed. The gas valves and Hot Surface Ignitor (HSI) are off. The duration of Pre-Purge is 15 seconds, and once expired, the Copper Brute II transitions to HSI Warmup. If the APS remains open, or if there is a separate lock-out condition, the Copper Brute II locks out and transitions to the Lock-out mode. If the call for heat is removed, the boiler/heater will transition back to the Standby mode.

NOTE: The duration of Pre-Purge is established to ensure proper evacuation of any unspent fuel in the combustion chamber and flue collector.

HSI Warmup

In HSI Warmup, the blower continues to run at

Start Up and Shut Down of the Copper Brute II must be performed by a qualified service person.

high speed, the gas valves remain off, and power is applied to the HSI. The current flowing through the HSI must be between 3.1 – 6.0 Amps 20 seconds. If the HSI amperage meets the threshold and time requirements, the boiler/heater will transition to the Ignition mode. If the amperage doesn't meet the threshold and time requirements, or if there is a separate lock-out condition, the Copper Brute II will transition to Lock-out mode. If the call for heat is removed, the Copper Brute II will return to Standby.

Ignition

In Ignition, the blower continues to run at high speed, the HSI is on, and the gas valve associated with the HSI is energized. Proper ignition has occurred if the flame signal is greater than or equal to 1.1 uAmps in 4 seconds. If a proper flame has been established, the Copper Brute II will transition to Run mode. If proper ignition does not occur, and the maximum attempts for ignition has not occurred, the boiler/heater will transition to Inter-Purge mode. If proper ignition does not occur, and the maximum attempts for ignition has been reached, the boiler/heater will transition to Lock-out mode. If the call for heat is removed, the boiler/heater will transition to Standby.

NOTE: Three attempts for ignition, prior to lock-out, is standard. CSD-1 units have a single attempt for ignition prior to lock-out.

Run

In Run, the blower continues to run at high speed, the HSI is off, and the gas valve associated with the HSI is energized. The stage 2 or stage 4 gas valve will stage on/off as required to satisfy a call for heat. If there is a loss of flame during Run mode, the Copper Brute II will transition to Inter-Purge mode. If a lock-out condition occurs during Run mode, the Copper Brute II will transition to Lock-out mode. If the call for heat is removed, the Copper Brute II will transition to Post-Purge prior to returning to Standby

Inter-Purge

In Inter-purge, the blower continues to run at high speed, the HSI is off, and the gas valves are off. The Copper Brute II will stay in Inter-Purge for 15 seconds. After 15 seconds, the Copper Brute II will transition

to HSI Pre-Heat. If a lock-out condition occurs during Inter-Purge, the Copper Brute II will transition to Lock-out. If the call for heat is removed during Inter-Purge, the Copper Brute II will transition to Post-Purge prior to returning to Standby.

Post-Purge

In Post-purge, the blower continues to run at high speed, the HSI is off, and the gas valves are off. The Copper Brute II will stay in Post-purge for 30 seconds. After this time, the Copper Brute II will return to Standby.

NOTE: The duration of Post-Purge is establish to ensure proper evacuation of any unspent fuel in the

combustion chamber and flue collector.

Lock-out

In Lock-out, the blower continues to run at high speed, the HSI is off, and the gas valves are off. The Copper Brute II blower will stay on for 30 seconds. The lock-out condition will remain until it has been manually reset. Once reset, the Copper Brute II will transition to Standby mode.

7.C Shutting Down the Copper Brute II

1. Switch off the main electrical disconnect switch.
2. Close all manual gas valves.
3. If freezing is anticipated, drain the Copper Brute II and be sure to also protect building piping from freezing.

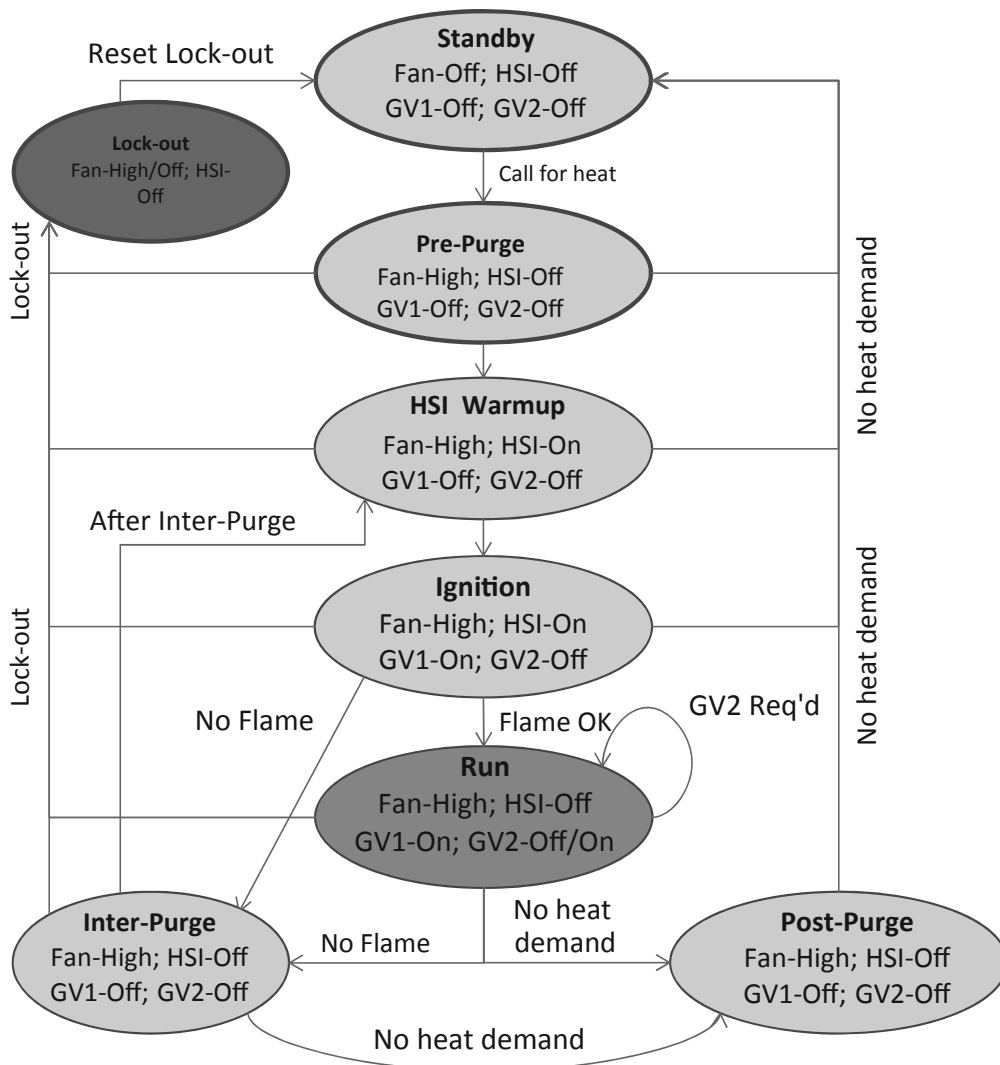

Figure 33. Timing and Ignition Flow

SECTION 8 Burner Set Up

8.A Set Up for 0 to 2500 Feet Altitude

The Copper Brute II appliance utilizes a modular design to achieve its stage-firing. The setup must be checked before the unit is put in operation. Problems such as failure to start, rough ignition, strong exhaust odors, etc. can be due to improper setup. Damage to the Copper Brute II resulting from improper setup is not covered by the limited warranty.

1. Using this manual, make sure the installation is complete and fully in compliance with the instructions.
2. Determine that the appliance and system are filled with water and all air has been bled from both. Open all valves.
3. Observe all warnings on the Operating Instructions label and turn on gas and electrical power to appliance.
4. Switch on the appliance power switch located on the right side of the unit.
5. The Copper Brute II will enter the start sequence, as long as the unit is being called for heat. The blower and pump come on for pre-purge, then the ignitor warm-up sequence starts and after the ignitor warm-up is complete and all safety devices are verified, the gas valves open. If ignition doesn't occur, check that there is proper gas supply. Wait 5 minutes and start the unit again. During initial start up, air in the gas line may cause the Copper Brute II to "lock out" during the first few trials for ignition. Depending on the ignition modules installed, the manual reset button on the ignition modules may need to be depressed to restart the Copper Brute II.
6. With the unit running, verify the supply gas pressure, manifold gas pressure, and CO₂ according to the Table 4

		Natural Gas	Propane
Supply Gas Pressure	Typical	7" w.c. (1.7kPa)	11" w.c. (2.7kPa)
	Range	5" w.c. ≤ (supply pressure) ≤ 13" w.c.	
Manifold Gas Pressure		2.5" w.c. (0.62 kPa)	
CO ₂		8%	9.2%

Table 21. Supply Gas Pressure

7. After placing the appliance in operation, the Burner Safety Shutoff Device must be tested.

To test:

- (a) Close gas shutoff valve with burner operating.
- (b) The flame will go out and blower will continue to run for the post purge cycle. One additional attempt to light will follow. Ignition will not occur as the gas is off. The ignition control will lockout, and will have to be reset before the unit will

operate.

(c) Open gas shutoff valve. Restart the appliance. The ignition sequence will start again and the burner will start. The appliance will return to its previous mode of operation.

NOTE: Sizes 1000–2000 have two ignition controls and two ignitors, which work independently of one another. If the ignition control for stages 1 and 2 fails to properly light the main burners for those stages, the second ignition control will still be active, and will be able to energize stages 3 and 4. This, of course, will only occur if all other safety devices confirm that the unit will run in a safe condition.

8.B Set Up for High Altitude (>2500 Feet)

Copper Brute II appliances may be operated at high altitude (7700 ft., 2347 m) with a reduction in output of approximately 10%. At altitudes of less than or more than 7700 ft. (2347 m) the appliance will perform equally as well, but with differing reductions in output. At elevations higher than 7700 ft. (2347 m) the reduction in output will exceed 10% and at elevations below 7700 ft. (2347 m) it will be less than 10%. High altitude adjustment must not be made on appliances operating at elevations below 2500 ft. (762 m).

No orifice changes are required to adjust the Copper Brute II appliances for high altitude. High altitude adjustment is accomplished by adjustment of the gas valve manifold pressure and the air shutter(s). The required instruments used to assist in these adjustments are a CO₂ or O₂ Analyzer and a U-Tube Manometer or other device capable of reading a pressure of 2.5-3.0 inches w.c. (0.62-0.75 kPa).

Start the adjustment process by checking the CO₂ in the "as installed" condition. Adjust the air shutter(s) so that the CO₂ is about 8% or the O₂ is about 6.8% for appliances operating on Natural Gas. For appliances operating on LP Gas adjust the air shutter(s) so that the CO₂ is about 9.2% or the O₂ is about 6.8%. Appliances with two blowers should be adjusted so that the air shutters below each blower are open the same amount.

Once the CO₂ or O₂ has been set, the manifold pressure may be adjusted. Remove the 1/8 NPT plug from the lower side of the gas valve that is to be set and install a fitting, hose and manometer. Start the appliance and observe the manifold pressure. Manifold pressure must be adjusted to 3.0 in. w.c. (0.75 kPa) (for high altitude only, standard operating

pressure is 2.5 in. w.c. (0.62 kPa)). It is adjusted by removing the slotted cap on the gas valve and turning the adjustment screw (beneath the cap) clockwise to increase pressure and replaced after the adjustments have been completed and the fitting, hose and manometer have been removed and the 1/8" plug has been replaced. Repeat this process until all gas valves have been set. **Note:** The pressure can be set only when the appliance is operating and only when the particular gas valve being adjusted is energized by a call for heat from the staging control.

After all of the gas valve manifold pressures have been set, the CO₂ or O₂ must be reset. CO₂ or O₂ will have changed when the manifold pressure was adjusted. Open the air shutter(s) to reduce the CO₂ or O₂ to the values achieved previously.

The procedure is complete when all gas valves are adjusted to a manifold pressure of 3.0 in. w.c. (0.75 kPa) and the CO₂ is adjusted to 8.0% for Natural Gas appliances or 9.2% for LP appliances. When using an O₂ analyzer, the correct O₂ is 6.8% for both Natural Gas and LP appliances.

 Caution

Should any odor of gas be detected, or if the gas burner does not appear to be functioning in a normal manner, close main shutoff valve, do not shut off switch, and contact your heating contractor, gas company, or factory representative.

SECTION 9 Maintenance

9.A System Maintenance

1. Lubricate the system water-circulating pump, if required, per the instructions on the pump.
2. If a strainer is employed in a pressure reducing valve or the piping, clean it every six months.
3. Inspect the venting system for obstruction or leakage at least once a year. Periodically clean the screens in the vent terminal and combustion air terminal (when used).
4. Keep the appliance area clear and free from combustible materials, gasoline, and other flammable vapors and liquids.
5. If the appliance is not going to be used for extended periods in locations where freezing normally occurs, it should be isolated from the system and completely drained of all water. All systems connected to it should also be drained or protected from freezing.
6. Low water cutoffs, if installed, should be checked every 6 months. Float type low water cutoff should be flushed periodically.
7. Inspect flue passages, and clean with brushes/vacuums, if necessary. Sooting in flue passages indicates improper combustion. Determine the cause and correct.
8. Inspect the vent system and air intake system, and if the vent system is Category III, ensure that all joints are sealed properly. If joints need to be resealed, completely remove existing sealing material, and clean with alcohol. Apply new sealing material, and re-assemble.

9.B Appliance Maintenance and Component Description

Only genuine Bradford White replacement parts should be used.

Caution

Label all wires prior to disconnection when servicing controls. Wiring errors can cause improper and dangerous operation. Verify proper operation after servicing.

See Figure 34 and Figure 35 for location of gas train and control components.

The gas and electric controls on the appliance are engineered for long life and dependable operation, but the safety of the equipment depends on their proper functioning. It is strongly recommended that a qualified service technician inspect the basic items listed below every year:

a. Controller	d. Pressure switches
b. Ignitors	f. Blowers
c. Automatic gas valve	

9.B.1 Burners

Close main manual gas valve before proceeding. Checking the burners for debris - Remove the ignitor inspection panels(s) and ignitor(s) and inspect the burners through the ignitor hole(s) using a flashlight to illuminate. If there is any indication of debris on the burners that are visible, all the burners will need to be inspected more thoroughly. Remove the screws from around the front of the air box (large panel from which the ignitor inspection panel(s) were removed), and remove the large panel. Remove the gas manifold assemblies and the burner panels. Inspect the burners. Clean burners, if necessary, by blowing compressed air from the outside of the burners into the center of the burner. A dirty burner may be an indication of improper combustion or dirty combustion air. Determine the cause, and correct. Replace the burners in the reverse order

9.B.2 Filter

The filter used in the Copper Brute II is washable with an 83% arrestance. Since the filter is washable, it will only need replacement when unwashable, deteriorated or damaged. If filter replacement is needed, it should only be replaced with a factory part. Inspect the air filter. If there is debris on the air filter, remove it from the filter box, and wash it with mild soap and water. Ensure that the filter is completely dry before re-installing, in reverse order.

9.B.3 Gas Valves

The gas valves are designed to operate with supply pressures of 4-13 inches w.c. (1.0 to 3.2 kPa). To remove a valve, shut off 120-volt power and the manual gas shutoff valve. Remove the top front panel from the unit. Disconnect the wires to the valve. Disengage the flanged fitting before and after the valve, and remove the valve. Re-install in reverse order. Ensure o-rings are properly installed for both inlet and outlet. Turn on manual gas shutoff valve and 120 volt power and check appliance operation and tightness of gas valve connections.

9.B.4 Manual Reset High Limit Control

When used, the high limit switch is a manual reset switch with an adjustable set point, up to 240°F (116°C) on boiler models and 200°F (93°C) on water heater models and boilers ordered with low temperature controls. To replace the switch, shut off the 120-volt power to the appliance. Remove the cover from the switch to access the mounting screws. Remove the screws, and pull the switch off the control panel. Remove the capillary and bulb from the thermal well located in the header. Replace in reverse order.

9.B.5 Automatic Reset High Limit Control

When used, an automatic reset high limit switch has an adjustable set point, up to 240°F (116°C) on boiler models and 200°F (93°C) water heater models and boilers ordered with low temperature controls. To replace the switch, shut off the 120-volt power to the appliance. Remove the cover from the switch to access the mounting screws. Remove the screws, and pull the switch off the control panel. Remove the capillary and bulb from the thermal well located in the header. Replace in reverse order.

9.B.6 Controller

The controller is a Bradford White BIC. The controller ensures the proved interrupted-type ignition system. It controls the hot surface ignitor(s) and prove that the flame signal is appropriate for powering the gas valves. It also controls the blower's pre-purge and post-purge.

To replace a controller, shut off the 120-volt power to the appliance. Remove the cover from the control panel. Remove the electrical connectors from the controller. Take out the controller's mounting screws, and pull the controller out. Replace in reverse order.

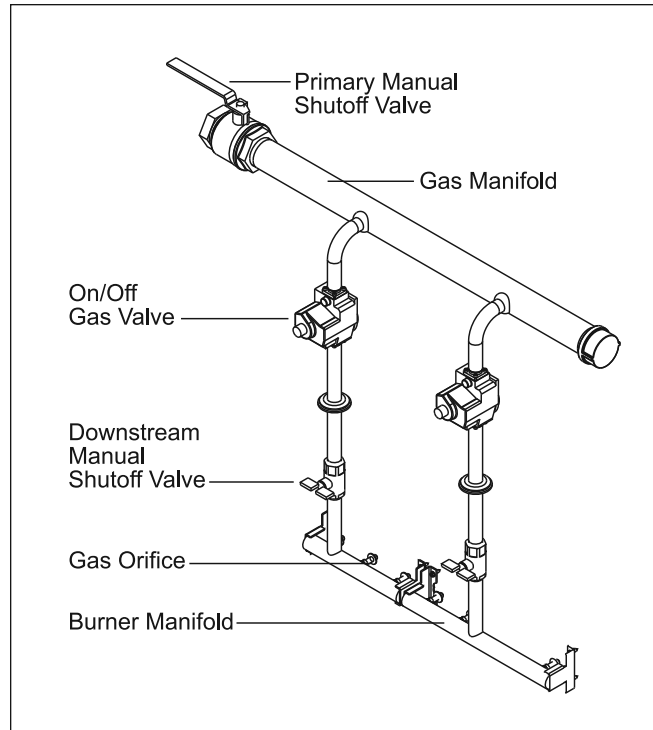

Figure 34. Typical Gas Train Configuration.

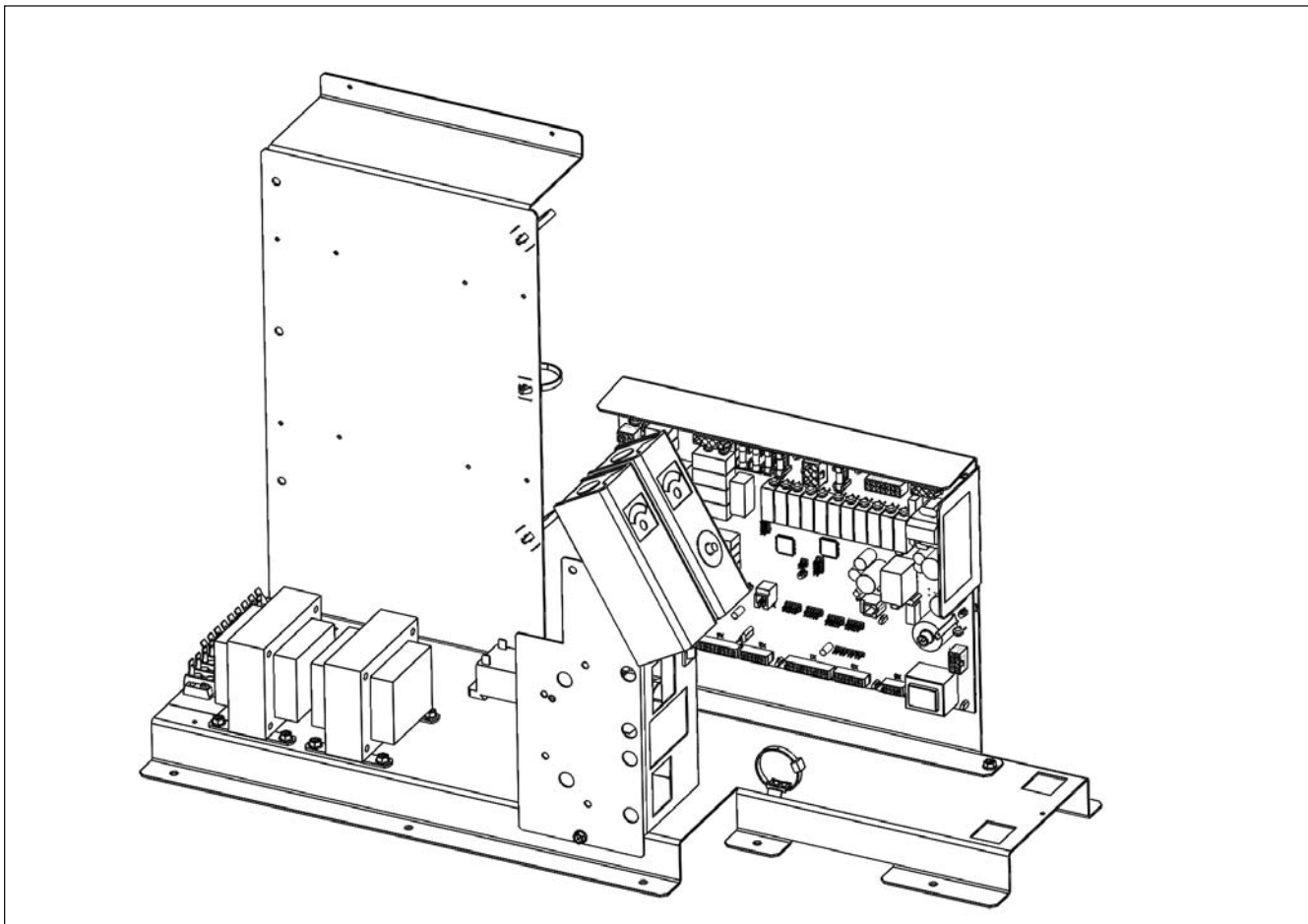

Figure 35. Typical Control Panel.

9.B.7 Ignitors

The ignitors used are 120v “Hot Surface” type. They are energized whenever there is a call for heat and switched off when ignition is established and the flame has been sensed. Copper Brute II sizes 500 and 750 have one ignitor. Sizes 1000 to 2000 have two ignitors. To replace the ignitor, shut off the 120-volt power to the appliance, remove the ignitor access panel, disconnect the Molex connector, remove the two mounting screws on the ignitor flange, and pull the ignitor out. Install in reverse order, always using a new ignitor gasket with the replacement ignitor.

Caution

Ignitor gets hot.

9.B.8 Ignition Sensors

The ignition sensors ensure that the main flame is ignited, so that raw gas is not allowed to fill the combustion chamber. Copper Brute II sizes 500 and 750 have one sensor. Sizes 1000 to 2000 have two sensors (one for each ignition control). The ignitors are the ignition sensors on Copper Brute II appliances. There are no separate ignition sensors.

9.B.9 Transformer

The Copper Brute II’s transformer is not capable of supplying control voltage for external devices such as zone valves, which must have their own separate power supply. Should a transformer need replacing, shut off the 120-volt power. Unplug the transformer wires, remove the mounting screws and remove the transformer. Replace transformer in the reverse order.

9.B.10 Blowers

The combustion air blowers bring the combustion air for the Copper Brute II from the upper chamber to the lower chamber. Mixing of the gas and air occurs in the burners. Sizes 500, 750 and 1000 each have one blower, and sizes 1250 to 2000 each have two blowers (one blower for stages 1 and 2, and one for stages 3 and 4). If a blower change is required, turn off the 120-volt power and gas supply to the unit. Remove the front panel. Disconnect the blower's wire harness. Remove the screws at the blower flange, and pull the blower out. Replace blower in reverse order, ensuring that all joints are made correctly. After replacement, ensure that the unit operates properly, by following the set-up procedure in this manual.

9.B.11 Flow Switch

The Copper Brute II uses a paddle-type flow switch to ensure that the unit has water flow before ignition is allowed.

9.B.12 Heat Exchanger Coil

WARNING

Black carbon soot buildup on a dirty heat exchanger can be ignited by a random spark or flame, thereby creating a risk of fire or explosion.. To prevent this from happening, dampen the soot deposits with a wet brush or fine water spray before servicing the heat exchanger.

The Copper Brute II has a pre-mixed burner system. These systems provide the burners with sufficient air for complete combustion, and black carbon sooting is seldom experienced. If sooting is suspected, view ports for inspection of the heat exchanger are provided on both sides of the boiler. They are located below the headers, and are accessed by opening the small round cover that is attached by one screw. In the unlikely event that there is a buildup of black carbon soot or other debris on the heat exchanger, clean per the following:

1. Disconnect the electrical supply to the unit.
2. Turn off the gas supply by closing the manual gas valve on the heater.
3. Disconnect and remove the wires, conduit and sensors from all components that are attached to the inlet/outlet header.
4. Isolate the heat exchanger from the water supply.
5. Disconnect header flanges from inlet and outlet.
6. Allow the heat exchanger to drain. Remove the front cover(s) by removing the rubber access strip(s) and the retaining screws. Remove the venting and remove the top, by removing the screws that attach the top to the side panels. Remove the side panels. Remove the front lower panels sealing the combustion area. To remove the gas train, disconnect the unions located below the intermediate pan and the field installed union located outside the cabinet, and pull up, bringing the union end connectors through the grommets in the intermediate pan. To remove the intermediate pan, remove the slide out control assembly and blower(s) to reveal the screws. Remove the screws holding the intermediate pan, and lift up to remove it. The heat exchanger has integral metal sections attached, which connect to the frame of the boiler. Locate and remove the screws along the front, rear and bottom of the integral metal sections, and remove the heat exchanger and metal sections by lifting up. On the larger appliances, a center heat exchanger support must be unbolted before it can be removed.
7. Remove the heat exchanger from the unit.

NOTE: The heat exchangers are heavy and may require two people to remove to avoid personal injury.

SECTION 10 Trouble Shooting

10.A Resolving Lockouts

There are many causes of lockouts. The three most common causes are: (1) inadequate gas supply, (2) poor combustion, (3) ignitor failure.

The Troubleshooting Errors & Lockouts list is shown on Table 10.F on page 80.

1. **Inadequate gas supply:** Before proceeding, ensure that the gas supply has not been shutoff or the LP tank (LP boilers) is not empty.

If your boiler is equipped with the optional gas pressure switches, then the Low Pressure switch might have tripped and will need to be reset.

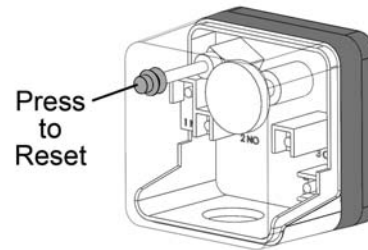

After resetting, restart the boiler and observe the operational cycle. After a 15-second fan pre-purge, the ignitor will heat up for 20 seconds, and then the unit will light. If it does not, check the gas supply pressure to the appliance, after resetting the appliance and attempting another start-up. The gas pressure to the appliance must be above 5" w.c. (1.2kPa) throughout the entire start-up cycle. If it is not, correct the supply problem (check gas valves or supply piping). If the supply pressure is adequate, consult the factory for assistance.

2. **Poor Combustion:** Poor combustion should be suspected if there is a strong flue gas odor. The odor may result from an improper gas/air ratio (high or low O₂ or CO₂). Copper Brute II appliances operate best with 45% excess air (8% CO₂ on natural gas, 9.2% CO₂ on LP). Check the CO₂ of the appliance and adjust if necessary.
3. **Ignitor failure:** If the boiler goes through a normal start cycle but combustion does not occur, ignitor failure should be suspected. Check the ignitor by unplugging the ignitor plug and measuring the ignitor resistance. It should be 50-80 ohms. If the resistance is not 50-80 ohms, replace the ignitor. If the resistance is correct, reset the boiler and check for 120 VAC at the ignitor plug during the start cycle. If there is no voltage, replace the faulty ignitor wire harness or the ignition control.

8. Clean the heat exchanger: A light accumulation of soot or corrosion on the outside of the heat exchanger can be easily removed. Use a wire brush to remove loose soot and scale from the heat exchanger. Do not use water or compressed air for cleaning.
9. While the heat exchanger is out of the unit, inspect the firewall refractory insulation. Replace if necessary.
10. Inspect the inside of the copper tubes for scale buildup. Scale can build up on the inner surface of the heat exchanger tubes, which can restrict water flow. If the tubes show signs of scaling, clean the internal surface. Bradford White offers a tube cleaning kit part number R0010000.
11. Reassemble in the reverse order, and check appliance operation after start-up.

NOTE: The Warranty does not cover damage caused by lack of required maintenance, lack of water flow, or improper operating practices.

10.B Delayed Ignition — Possible Causes

A defective burner can cause a delayed ignition. If the gas supply pressure is proper and the gas valves are functioning properly, then burners should be inspected. There should be no distortion or perforations in the burners outside of the active burner port area. Replace if indicated.

10.C Short Cycling — Boiler

Because the Copper Brute II is a stage-fired boiler, and its input will decrease when there is a reduction in heating load, short cycling is greatly reduced. If the heating load drops below the minimum input of the boiler for an extended period, the boiler will have a tendency to short cycle. This can be a symptom of improper control strategy or Set Points, or a load distribution problem. Contact your Bradford White representative to discuss possible remedies.

10.D Short Cycling — Water Heater

Short cycling will generally occur only in combination space heating and water heating applications when the water heater is operating in the space-heating mode. Because the Copper Brute II is a stage-fired water heater and its input will reduce when there is a reduction in heating load, short cycling is greatly reduced. If the heating load drops below the minimum input of the water heater for an extended period, the water heater will have a tendency to short cycle. If short cycling is frequently experienced, regardless of the control's attempt to limit it, the heating load should be redistributed to control it.

If short cycling occurs in a water heater application, it is probably caused by undersized piping between the water heater and the storage tank or by some other factor that restricts proper water flow through the water heater. The cause should be determined and corrected.

10.E High Gas Consumption

Appliances operating with an improper air/fuel ratio are very inefficient and consequently, have very high gas consumption. Because efficiency is high when the CO₂ is high (or O₂ is low), appliances operating with low CO₂ or high O₂ (especially LP appliances) consume more gas. Adjust the CO₂ or O₂ for optimum efficiency. If no combustion analyzing equipment (CO₂ or O₂) is available then a proper adjustment of the air/fuel ratio (CO₂ or O₂) cannot be accomplished. However, by briefly sniffing the flue gases it is possible to determine if the CO₂ or O₂ is within the proper range. No significant flue gas odor should be detected when combustion is proper. A strong piercing smell indicates poor combustion and generally a lean mixture - low CO₂ or high O₂. The CO₂ should be 8% at high fire. To check the CO₂, first verify that the supply gas pressure is within 5" to 13" w.c. (1.2 to 3.2 kPa) With the Copper Brute II running with all stages firing, set the air box pressure to 1.5" w.c. (0.37 kPa) (as a starting point), by adjusting the air shutter(s) at the bottom of the fan(s). Check the CO₂, and adjust the air shutters if further adjustment to the CO₂ is needed. Sizes 1250 to 2000 have two blowers and two air chambers (boxes). The pressure of each air box must be equal when the final adjustment is made.

10.F Troubleshooting Errors & Lockouts

Error	Description	Corrective Action																																
Flow Switch	Insufficient flow at the outlet of the boiler/heater.	<ul style="list-style-type: none"> Faulty boiler/heater pump – replace pump. Faulty pump contactor – replace contactor. Blown boiler/heater pump fuse – replace fuse F14 on the control board. 																																
Low Water Cut Off	Insufficient water level in the boiler/heater heat exchanger.	<ul style="list-style-type: none"> Reset the LWCO from the reset button on the LWCO module. Verify the system is full of water and all air has been purged from the system. Check for loose jumpers if the LWCO is not installed. 																																
Man Reset High Limit	Outlet water temperature has exceeded the manual reset high limit setting.	<ul style="list-style-type: none"> Verify the system is full of water and all air has been purged from the system. Verify the boiler/heater is piped properly into the heating system. Check for proper pump operations. Check the manual reset high limit set point. 																																
Auto Reset High Limit	Outlet water temperature has exceeded the auto reset high limit setting.	<ul style="list-style-type: none"> Verify the system is full of water and all air has been purged from the system. Verify the boiler/heater is piped properly into the heating system. Check for proper pump operations. Check the manual reset high limit set point. 																																
Pressure Switch	Blocked flue switch contacts are open.	<ul style="list-style-type: none"> Check the wiring connections to the switch. The wires should be connected to the common and normally open terminals. Check reference hose and tubing connected to the pressure switch for blockage/obstruction. Faulty switch – replace switch. Verify blower is operating – replace if necessary. Blown blower fuse – replace fuse F12 on the control board for blower1 or fuse F13 for blower2. 																																
High Gas Pressure	The high gas pressure switch has tripped.	<ul style="list-style-type: none"> Refer to Section 3 for Gas Supply and Piping information. Verify supply and manifold gas pressures satisfy requirements in Section 8 – correct if necessary. 																																
Low Gas Pressure	The low gas pressure switch has tripped.	<ul style="list-style-type: none"> Refer to Section 3 for Gas Supply and Piping information. Verify supply and manifold gas pressures satisfy requirements in Section 8 – correct if necessary. 																																
Field Interlock	Field interlock is open.	<ul style="list-style-type: none"> Check for loose or misplaced jumper if no field interlock device is installed. 																																
Outlet Sensor	Outlet probe is not connected.	<ul style="list-style-type: none"> Check the sensor and wiring. Repair or replace as needed. The outlet probe is a dual element probe with 10K and 20K thermistors. A quick test is to measure resistance and verify one resistance is double the other. Replace if necessary. Measure the resistance of each element of the sensor and compare to the resistance table below. Replace if necessary. <table border="1" style="margin-left: auto; margin-right: auto;"> <thead> <tr> <th rowspan="2">Temp (°F)</th> <th>10K</th> <th>20K</th> </tr> <tr> <th>Resistance (Ω)</th> <th>Resistance (Ω)</th> </tr> </thead> <tbody> <tr><td>68</td><td>12555</td><td>25099</td></tr> <tr><td>86</td><td>8025</td><td>16057</td></tr> <tr><td>104</td><td>5279</td><td>10569</td></tr> <tr><td>122</td><td>3563</td><td>7139</td></tr> <tr><td>140</td><td>2463</td><td>4937</td></tr> <tr><td>158</td><td>1739</td><td>3489</td></tr> <tr><td>176</td><td>1253</td><td>2514</td></tr> <tr><td>194</td><td>919</td><td>1845</td></tr> <tr><td>212</td><td>685</td><td>1376</td></tr> </tbody> </table>	Temp (°F)	10K	20K	Resistance (Ω)	Resistance (Ω)	68	12555	25099	86	8025	16057	104	5279	10569	122	3563	7139	140	2463	4937	158	1739	3489	176	1253	2514	194	919	1845	212	685	1376
Temp (°F)	10K	20K																																
	Resistance (Ω)	Resistance (Ω)																																
68	12555	25099																																
86	8025	16057																																
104	5279	10569																																
122	3563	7139																																
140	2463	4937																																
158	1739	3489																																
176	1253	2514																																
194	919	1845																																
212	685	1376																																
Outlet Sensor Drift	Dual element sensor readings do not agree.	<ul style="list-style-type: none"> Check the sensor and wiring. Repair or replace as needed. The outlet probe is a dual element probe with 10K and 20K thermistors. A quick test is to measure resistance and verify one resistance is double the other. Replace if necessary. Measure the resistance of each element of the sensor and compare to the resistance table below. Replace if necessary. <table border="1" style="margin-left: auto; margin-right: auto;"> <thead> <tr> <th rowspan="2">Temp (°F)</th> <th>10K</th> <th>20K</th> </tr> <tr> <th>Resistance (Ω)</th> <th>Resistance (Ω)</th> </tr> </thead> <tbody> <tr><td>68</td><td>12555</td><td>25099</td></tr> <tr><td>86</td><td>8025</td><td>16057</td></tr> <tr><td>104</td><td>5279</td><td>10569</td></tr> <tr><td>122</td><td>3563</td><td>7139</td></tr> <tr><td>140</td><td>2463</td><td>4937</td></tr> <tr><td>158</td><td>1739</td><td>3489</td></tr> <tr><td>176</td><td>1253</td><td>2514</td></tr> <tr><td>194</td><td>919</td><td>1845</td></tr> <tr><td>212</td><td>685</td><td>1376</td></tr> </tbody> </table>	Temp (°F)	10K	20K	Resistance (Ω)	Resistance (Ω)	68	12555	25099	86	8025	16057	104	5279	10569	122	3563	7139	140	2463	4937	158	1739	3489	176	1253	2514	194	919	1845	212	685	1376
Temp (°F)	10K	20K																																
	Resistance (Ω)	Resistance (Ω)																																
68	12555	25099																																
86	8025	16057																																
104	5279	10569																																
122	3563	7139																																
140	2463	4937																																
158	1739	3489																																
176	1253	2514																																
194	919	1845																																
212	685	1376																																
Inlet Sensor	Inlet sensor is damaged or not connected.	<ul style="list-style-type: none"> Check the sensor and wiring. Repair or replace as needed. Measure the resistance of the sensor and compare to the resistance table below. Replace if necessary. <table border="1" style="margin-left: auto; margin-right: auto;"> <thead> <tr> <th>Temp (°F)</th> <th>Temp (°C)</th> <th>Resistance (Ω)</th> </tr> </thead> <tbody> <tr><td>68</td><td>20</td><td>12555</td></tr> <tr><td>86</td><td>30</td><td>8025</td></tr> <tr><td>104</td><td>40</td><td>5279</td></tr> <tr><td>122</td><td>50</td><td>3563</td></tr> <tr><td>140</td><td>60</td><td>2463</td></tr> <tr><td>158</td><td>70</td><td>1739</td></tr> <tr><td>176</td><td>80</td><td>1253</td></tr> <tr><td>194</td><td>90</td><td>919</td></tr> <tr><td>212</td><td>100</td><td>685</td></tr> </tbody> </table>	Temp (°F)	Temp (°C)	Resistance (Ω)	68	20	12555	86	30	8025	104	40	5279	122	50	3563	140	60	2463	158	70	1739	176	80	1253	194	90	919	212	100	685		
Temp (°F)	Temp (°C)	Resistance (Ω)																																
68	20	12555																																
86	30	8025																																
104	40	5279																																
122	50	3563																																
140	60	2463																																
158	70	1739																																
176	80	1253																																
194	90	919																																
212	100	685																																

Table 22. Troubleshooting Error Codes.

(cont)

Error	Description	Corrective Action
Burner1 APS Switch	Burner1 air proving switch contacts are open.	<ul style="list-style-type: none"> • Check the wiring connections to the switch. The wires should be connected to the common and normally open terminals. • Check reference hose and tubing connected to the pressure switch for blockage/obstruction. • Faulty switch – replace switch. • Verify blower is operating – replace if necessary. • Blown blower fuse – replace fuse F12 on the control board for blower1.
Burner2 APS Switch	Burner2 air proving switch contacts are open. NOTE: 1.25MM – 2.0MM Only	<ul style="list-style-type: none"> • Check the wiring connections to the switch. The wires should be connected to the common and normally open terminals. • Check reference hose and tubing connected to the pressure switch for blockage/obstruction. • Faulty switch – replace switch. • Verify blower is operating – replace if necessary. • Blown blower fuse – replace fuse F13 on the control board for blower2.
Burner1 Parasitic Flame	Sensing flame on burner1 prior to ignition.	<ul style="list-style-type: none"> • Inspect HSI and wiring for damage and continuity. Replace if necessary. • Check HSI by unplugging the ignitor, remove from the system, and measure resistance. It should be between 50Ω - 80Ω, if it is not in this range, replace the HSI.
Burner2 Parasitic Flame	Sensing flame on burner2 prior to ignition. NOTE: 1.0MM – 2.0MM Only	<ul style="list-style-type: none"> • Inspect HSI and wiring for damage and continuity. Replace if necessary. • Check HSI by unplugging the ignitor, remove from the system, and measure resistance. It should be between 50Ω - 80Ω, if it is not in this range, replace the HSI.
Burner1 Max Trials	The maximum attempts for ignition has occurred, without sensing flame.	<ul style="list-style-type: none"> • Verify supply and manifold gas pressures satisfy requirements in Section 8 – correct if necessary. • Verify the proper intake and venting. • Inspect the burner. • During ignition, see Section 7, verify 24VAC at gas valve associated with the HSI.
Burner2 Max Trials	The maximum attempts for ignition has occurred, without sensing flame. NOTE: 1.0MM – 2.0MM Only	<ul style="list-style-type: none"> • Verify supply and manifold gas pressures satisfy requirements in Section 8 – correct if necessary. • Verify the proper intake and venting. • Inspect the burner. • During ignition, see Section 7, verify 24VAC at gas valve associated with the HSI.
Burner1 Max Flame Lost	The maximum allowable occurrences of the unit running and losing flame signal have occurred.	<ul style="list-style-type: none"> • Inspect HSI and wiring for damage and continuity. Replace if necessary. • Check HSI by unplugging the ignitor, remove from the system, and measure resistance. It should be between 50Ω - 80Ω, if it is not in this range, replace the HSI. • Verify supply and manifold gas pressures satisfy requirements in Section 8 – correct if necessary. • Verify the proper intake and venting. • Check combustion. • Inspect the burner. • Inspect the heat exchanger.
Burner2 Max Flame Lost	The maximum allowable occurrences of the unit running and losing flame signal have occurred. NOTE: 1.0MM – 2.0MM Only	<ul style="list-style-type: none"> • Inspect HSI and wiring for damage and continuity. Replace if necessary. • Check HSI by unplugging the ignitor, remove from the system, and measure resistance. It should be between 50Ω - 80Ω, if it is not in this range, replace the HSI. • Verify supply and manifold gas pressures satisfy requirements in Section 8 – correct if necessary. • Verify the proper intake and venting. • Check combustion. • Inspect the burner. • Inspect the heat exchanger.
Burner1 Proven HSI	Burner1 proven HSI failed	<ul style="list-style-type: none"> • Inspect HSI and wiring for damage and continuity. Replace if necessary. • Check HSI by unplugging the ignitor, remove from the system, and measure resistance. It should be between 50Ω - 80Ω, if it is not in this range, replace the HSI. • During the HSI Warmup stage of ignition, see Section 7, verify 120VAC at the HSI. • Blown HSI fuse – replace fuse F10 on the control board for HSI1.
Burner2 Proven HSI	Burner2 proven HSI failed NOTE: 1.0MM – 2.0MM Only	<ul style="list-style-type: none"> • Inspect HSI and wiring for damage and continuity. Replace if necessary. • Check HSI by unplugging the ignitor, remove from the system, and measure resistance. It should be between 50Ω - 80Ω, if it is not in this range, replace the HSI. • During the HSI Warmup stage of ignition, see Section 7, verify 120VAC at the HSI. • Blown HSI fuse – replace fuse F11 on the control board for HSI2.

10.G Parameter Tables

10.G.1 Boiler (including Low Temp)

	User	Installer	Minimum	Maximum	Default
Time & Date					
Hour	x	x	NA	NA	NA
Minute	x	x	NA	NA	NA
Month	x	x	NA	NA	NA
Day	x	x	NA	NA	NA
Year	x	x	NA	NA	NA
CH1					
CH1 Enable/Disable	x	x	Disable	Enable	Enable
CH1 Setpoint	x	x	120 F	240 F	180 F
CH1 Priority		x	1	97	60
CH1 Control Mode		x	PID	Temp Differential	Temp Differential
CH1 Stage 1 OFF Hysteresis		x	0 F	10 F	5 F
CH1 Stage 1 ON Hysteresis		x	0 F	10 F	5 F
CH1 Stage 2 OFF Hysteresis		x	0 F	10 F	5 F
CH1 Stage 2 ON Hysteresis		x	0 F	10 F	5 F
CH1 Stage 3 OFF Hysteresis		x	0 F	10 F	5 F
CH1 Stage 3 ON Hysteresis		x	0 F	10 F	5 F
CH1 Stage 4 OFF Hysteresis		x	0 F	10 F	5 F
CH1 Stage 4 ON Hysteresis		x	0 F	10 F	5 F
CH1 Stage Delay On Time		x	0 secs	120 secs	30 secs
CH1 Stage Delay Off Time		x	0 secs	120 secs	0 secs
CH1 Minimum Stage On Time		x	0 secs	120 secs	10 secs
CH1 Minimum Stage Off Time		x	0 secs	120 secs	10 secs
CH1 PID On Hysteresis	x	x	0 F	21 F	10 F
CH1 PID Off Hysteresis	x	x	0 F	21 F	10 F
CH1 Proportional Gain		x	0	32767	250
CH1 Integral Time		x	0	32767	100
CH1 Derivative Time		x	0	32767	0
CH2					
CH2 Enable/Disable	x	x	Disable	Enable	Enable
CH2 Setpoint	x	x	120 F	240 F	170 F
CH2 Priority		x	1	97	50
CH2 Control Mode		x	PID	Temp Differential	Temp Differential
CH2 Stage 1 OFF Hysteresis		x	0 F	10 F	5 F
CH2 Stage 1 ON Hysteresis		x	0 F	10 F	5 F
CH2 Stage 2 OFF Hysteresis		x	0 F	10 F	5 F
CH2 Stage 2 ON Hysteresis		x	0 F	10 F	5 F
CH2 Stage 3 OFF Hysteresis		x	0 F	10 F	5 F
CH2 Stage 3 ON Hysteresis		x	0 F	10 F	5 F
CH2 Stage 4 OFF Hysteresis		x	0 F	10 F	5 F
CH2 Stage 4 ON Hysteresis		x	0 F	10 F	5 F
CH2 Stage Delay On Time		x	0 secs	120 secs	60 secs
CH2 Stage Delay Off Time		x	0 secs	120 secs	0 secs
CH2 Minimum Stage On Time		x	0 secs	120 secs	10 secs
CH2 Minimum Stage Off Time		x	0 secs	120 secs	10 secs
CH2 PID On Hysteresis	x	x	0 F	21 F	20 F
CH2 PID Off Hysteresis	x	x	0 F	21 F	20 F

Boiler continued	User	Installer	Minimum	Maximum	Default
CH2 Proportional Gain		x	0	32767	250
CH2 Integral Time		x	0	32767	100
CH2 Derivative Time		x	0	32767	0
<u>DHW</u>					
DHW Enable/Disable	x	x	Disable	Enable	Disable
DHW Setpoint	x	x	120 F	200 F	180 F
DHW Priority		x	1	97	90
DHW Control Mode		x	PID	Temp Differential	Temp Differential
DHW PID On Hysteresis	x	x	0 F	21 F	10 F
DHW PID Off Hysteresis	x	x	0 F	21 F	10 F
DHW Stage 1 OFF Hysteresis		x	0 F	10 F	5 F
DHW Stage 1 ON Hysteresis		x	0 F	10 F	5 F
DHW Stage 2 OFF Hysteresis		x	0 F	10 F	5 F
DHW Stage 2 ON Hysteresis		x	0 F	10 F	5 F
DHW Stage 3 OFF Hysteresis		x	0 F	10 F	5 F
DHW Stage 3 ON Hysteresis		x	0 F	10 F	5 F
DHW Stage 4 OFF Hysteresis		x	0 F	10 F	5 F
DHW Stage 4 ON Hysteresis		x	0 F	10 F	5 F
DHW Stage Delay On Time		x	0 secs	120 secs	60 secs
DHW Stage Delay Off Time		x	0 secs	120 secs	0 secs
DHW Minimum Stage On Time		x	0 secs	120 secs	10 secs
DHW Minimum Stage Off Time		x	0 secs	120 secs	10 secs
DHW Offset		x	0 F	72 F	18 F
DHW Proportional Gain		x	0	32767	250
DHW Integral Time		x	0	32767	100
DHW Derivative Time		x	0	32767	0
<u>Outdoor</u>					
Outdoor Reset Enable/Disable	x	x	Disable	Enable	Enable
Maximum Ambient Temperature		x	0 F	120 F	65 F
Minimum Ambient Temperature		x	0 F	100 F	0 F
Maximum Water Temperature		x	120 F	240 F	180 F
Minimum Water Temperature		x	120 F	240 F	120 F
<u>Cascade CH</u>					
Address		x	-1	7	-1
Dynamic Address		x	-1	7	-1
Lost Lead Backup Setpoint		x	120 F	240 F	180 F
Lag On Hysteresis		x	0 F	21 F	10 F
Lag Off Hysteresis		x	0 F	21 F	10 F
Cascade CH Setpoint	x	x	120 F	240 F	180 F
Cascade CH On Hysteresis		x	0 F	21 F	10 F
Cascade CH Off Hysteresis		x	0 F	21 F	10 F
Cascade CH Priority		x	1	97	70
Cascade CH Proportional Gain		x	0	32767	250
Cascade CH Integral Time		x	0	32767	10
Cascade CH Derivative Time		x	0	32767	0
Cascade CH Maximum Lag Temperature		x	120 F	240 F	180 F
<u>Cascade Redundancy</u>					
Loss of Lead Setup		x	Disable	Boiler Internal Setpoint/ Redundant Lead	Boiler Internal Setpoint
<u>Hybrid</u>					
Hybrid Enable/Disable		x	Disable	Enable	Disable

Boiler continued	User	Installer	Minimum	Maximum	Default
Lag Mode Enable/Disable		x	Disable	Enable	Disable
Hybrid Setpoint		x	82 F	181 F	130 F
Hybrid Differential Temperature		x	0 F	21 F	10 F
Hybrid Delay Time		x	0 min	720 min	30 min
<u>Pump Configuration</u>					
Boiler Pump Control		x	Auto	Auto/ Always On/ Off During DHW	Auto
Boiler Pump Post Circulation		x	0 secs	600 secs	60 secs
DHW Pump Control		x	Disable	Auto/ Always On	Auto
DHW Pump Post Circulation		x	0 secs	600 secs	60 secs
System Pump Control		x	Disable	Auto/ Always On/ Off During DHW	Auto
System Pump Post Circulation		x	0 secs	600 secs	60 secs
<u>Temperature Limits</u>					
Auto Reset Boiler Outlet Limit		x	100 F	240 F	195 F
Manual Reset Boiler Outlet Limit		x	100 F	240 F	210 F
Reset Differential		x	1 F	10 F	5 F
Stage Limit Hysteresis		x	0 F	10 F	2 F
<u>External Control</u>					
Control Mode		x	Disable	External Setpoint/ Firing Rate	Disable
External Control Priority		x	1	97	20
Maximum Setpoint		x	120 F	240 F	180 F
Minimum Setpoint		x	120 F	240 F	120 F
Maximum Firing Rate		x	0	10000	10000
Minimum Firing Rate		x	0	10000	0
Demand Max		x	0%	100%	100%
Demand Min		x	0%	100%	20%
Demand On		x	0%	25%	15%
Demand Off		x	0%	25%	10%
<u>Anti- Frost</u>					
Anti Frost Mode		x	Disable	Pump Only/ Pump & Burner	Pump Only
Anti- Frost Setpoint		x	32 F	120 F	40 F
Anti- Frost Hysteresis		x	3 F	10 F	5 F
Anti- Frost Pump Control		x	NA	Boiler/ DHW/ System	Boiler
<u>Warm Weather Shutdown</u>					
Temperature Minimum		x	50 F	140 F	90 F
Temperature Maximum		x	50 F	140 F	95 F
Feature Options		x	Disable	Shutdown Immediately/ Shutdown After Demand is Satisfied	Shutdown Immediately
Summer Kick CH		x	0 secs	600 secs	30 secs
Summer Kick DHW		x	0 secs	600 secs	30 secs
Summer Kick System		x	0 secs	600 secs	30 secs
Summer Kick Period		x	10 min	2000 min	1440 min
<u>Anti- Short Cycle Time</u>					
Cycle Time		x	10 secs	240 secs	60 secs
<u>Temperature Conversion</u>					
Conversion Unit	x	x	Celsius	Fahrenheit	Fahrenheit

Boiler continued	User	Installer	Minimum	Maximum	Default
BACnet					
Baudrate		x	9600	76800	76800
Address		x	0	255	127
Device Model Name		x	NA	NA	NA
Device Object Name		x	NA	NA	NA
Object Instance		x	0	4194303	600000
Timeout		x	0 secs	300 secs	300 secs
Mixing Valve Anti- Condensing (Low Temp Models ONLY)					
Mixing Valve Anti-Condensing Enable/Disable		x	Disable	Enable	Enable
Mixing Valve Anti-Condensing Temperature Setpoint		x	120 F	180 F	120 F
Mixing Valve Anti-Condensing Proportional Gain		x	0	32767	250
Mixing Valve Anti-Condensing Integral Time		x	0	32767	15
Mixing Valve Anti-Condensing Derivative Time		x	0	32767	0
Condensing Alarm Setpoint		x	100 F	120 F	110 F
Minimum Voltage Output		x	0 mV	4000 mV	3500 mV
Maximum Voltage Output		x	4000 mV	10000 mV	6500 mV
Condensing Alarm Delay		x	0 mins	20 mins	10 mins
Condensing Shutdown Delay		x	0 mins	40 mins	20 mins
Service					
Stage 1 Burner Enable/Disable		x	Disable	Enable	Enable
Stage 2 Burner Enable/Disable		x	Disable	Enable	Enable
Stage 3 Burner Enable/Disable (Applicable to 1MM-2MM only)		x	Disable	Enable	Enable
Stage 4 Burner Enable/Disable (Applicable to 1.25MM-2MM only)		x	Disable	Enable	Enable
Screen Settings					
Light Timeout	x	x	0 secs	3600 secs	600 secs
AutoLock Timeout	x	x	0 secs	3600 secs	600 secs

10.G.2 Heater (including Low Temp)	User	Installer	Minimum	Maximum	Default
Time & Date					
Hour	x	x	NA	NA	NA
Minute	x	x	NA	NA	NA
Month	x	x	NA	NA	NA
Day	x	x	NA	NA	NA
Year	x	x	NA	NA	NA
DHW1					
DHW1 Enable/Disable	x	x	Disable	Enable	Enable
DHW1 Setpoint	x	x	120 F	200 F	140 F
DHW1 Priority		x	1	97	60
DHW1 Control Mode		x	PID	Temp Differential	Temp Differential
DHW1 Stage 1 OFF Hysteresis		x	0 F	10 F	5 F
DHW1 Stage 1 ON Hysteresis		x	0 F	10 F	5 F
DHW1 Stage 2 OFF Hysteresis		x	0 F	10 F	5 F
DHW1 Stage 2 ON Hysteresis		x	0 F	10 F	5 F
DHW1 Stage 3 OFF Hysteresis		x	0 F	10 F	5 F
DHW1 Stage 3 ON Hysteresis		x	0 F	10 F	5 F
DHW1 Stage 4 OFF Hysteresis		x	0 F	10 F	5 F
DHW1 Stage 4 ON Hysteresis		x	0 F	10 F	5 F
DHW1 Stage Delay On Time		x	0 secs	120 secs	30 secs
DHW1 Stage Delay Off Time		x	0 secs	120 secs	0 secs
DHW1 Minimum Stage On Time		x	0 secs	120 secs	10 secs
DHW1 Minimum Stage Off Time		x	0 secs	120 secs	10 secs
DHW1 PID On Hysteresis	x	x	0 F	21 F	10 F
DHW1 PID Off Hysteresis	x	x	0 F	21 F	10 F
DHW1 Proportional Gain		x	0	32767	250
DHW1 Integral Time		x	0	32767	100
DHW1 Derivative Time		x	0	32767	0
DHW2					
DHW2 Enable/Disable	x	x	Disable	Enable	Enable
DHW2 Setpoint	x	x	120 F	200 F	130 F
DHW2 Priority		x	1	97	50
DHW2 Control Mode		x	PID	Temp Differential	Temp Differential
DHW2 Stage 1 OFF Hysteresis		x	0 F	10 F	5 F
DHW2 Stage 1 ON Hysteresis		x	0 F	10 F	5 F
DHW2 Stage 2 OFF Hysteresis		x	0 F	10 F	5 F
DHW2 Stage 2 ON Hysteresis		x	0 F	10 F	5 F
DHW2 Stage 3 OFF Hysteresis		x	0 F	10 F	5 F
DHW2 Stage 3 ON Hysteresis		x	0 F	10 F	5 F
DHW2 Stage 4 OFF Hysteresis		x	0 F	10 F	5 F
DHW2 Stage 4 ON Hysteresis		x	0 F	10 F	5 F
DHW2 Stage Delay On Time		x	0 secs	120 secs	60 secs

Heater continued	User	Installer	Minimum	Maximum	Default
DHW2 Stage Delay Off Time		x	0 secs	120 secs	0 secs
DHW2 Minimum Stage On Time		x	0 secs	120 secs	10 secs
DHW2 Minimum Stage Off Time		x	0 secs	120 secs	10 secs
DHW2 PID On Hysteresis	x	x	0 F	21 F	20 F
DHW2 PID Off Hysteresis	x	x	0 F	21 F	20 F
DHW2 Proportional Gain		x	0	32767	250
DHW2 Integral Time		x	0	32767	100
DHW2 Derivative Time		x	0	32767	0
DHW3					
DHW3 Enable/Disable	x	x	Disable	Enable	Enable
DHW3 Setpoint	x	x	120 F	200 F	120 F
DHW3 Priority		x	1	97	90
DHW3 Control Mode		x	PID	Temp Differential	Temp Differential
DHW3 PID On Hysteresis	x	x	0 F	21 F	10 F
DHW3 PID Off Hysteresis	x	x	0 F	21 F	10 F
DHW3 Stage 1 OFF Hysteresis		x	0 F	10 F	5 F
DHW3 Stage 1 ON Hysteresis		x	0 F	10 F	5 F
DHW3 Stage 2 OFF Hysteresis		x	0 F	10 F	5 F
DHW3 Stage 2 ON Hysteresis		x	0 F	10 F	5 F
DHW3 Stage 3 OFF Hysteresis		x	0 F	10 F	5 F
DHW3 Stage 3 ON Hysteresis		x	0 F	10 F	5 F
DHW3 Stage 4 OFF Hysteresis		x	0 F	10 F	5 F
DHW3 Stage 4 ON Hysteresis		x	0 F	10 F	5 F
DHW3 Stage Delay On Time		x	0 secs	120 secs	60 secs
DHW3 Stage Delay Off Time		x	0 secs	120 secs	0 secs
DHW3 Minimum Stage On Time		x	0 secs	120 secs	10 secs
DHW3 Minimum Stage Off Time		x	0 secs	120 secs	10 secs
DHW3 Offset		x	0 F	72 F	18 F
DHW3 Proportional Gain		x	0	32767	250
DHW3 Integral Time		x	0	32767	100
DHW3 Derivative Time		x	0	32767	0
Outdoor (NOT Available on Volume Water Units)					
Cascade CH (NOT Available on Volume Water Units)					
Cascade DHW					
Address		x	-1	7	-1
Dynamic Address		x	-1	7	-1
Lost Lead Backup Setpoint		x	120 F	200 F	140 F
Lag On Hysteresis		x	0 F	21 F	10 F
Lag Off Hysteresis		x	0 F	21 F	10 F
Cascade DHW Setpoint	x	x	120 F	200 F	140 F
Cascade DHW On Hysteresis		x	0 F	21 F	10 F
Cascade DHW Off Hysteresis		x	0 F	21 F	10 F
Cascade DHW Priority		x	1	97	80
Cascade DHW Proportional Gain		x	0	32767	250
Cascade DHW Integral Time		x	0	32767	10
Cascade DHW Derivative Time		x	0	32767	0
Cascade DHW Maximum Lag Temperature		x	120 F	200 F	140 F

Heater continued

Cascade Redundancy					
Loss of Lead Setup		x	Disable	Boiler Internal Setpoint/ Redundant Lead	Boiler Internal Setpoint
Hybrid					
Hybrid Enable/Disable		x	Disable	Enable	Disable
Lag Mode Enable/Disable		x	Disable	Enable	Disable
Hybrid Setpoint		x	82 F	181 F	130 F
Hybrid Differential Temperature		x	0 F	21 F	10 F
Hybrid Delay Time		x	0 min	720 min	30 min
Pump Configuration					
Boiler Pump Control		x	Auto	Auto/ Always On/ Off During DHW	Auto
Boiler Pump Post Circulation		x		600 secs	60 secs
DHW Pump Control		x	Disable	Auto/ Always On	Auto
DHW Pump Post Circulation		x	0 secs	600 secs	60 secs
System Pump Control		x	Disable	Auto/ Always On/ Off During DHW	Auto
System Pump Post Circulation		x	0 secs	600 secs	60 secs
Variprime (Not Available on Volume Water Units)					
Temperature Limits					
Auto Reset Boiler Outlet Limit		x	100 F	200 F	180 F
Manual Reset Boiler Outlet Limit		x	100 F	200 F	190 F
Reset Differential		x	1 F	10 F	5 F
Stage Limit Hysteresis		x	0 F	10 F	2 F
External Control					
Control Mode		x	Disable	External Setpoint/ Firing Rate	Disable
External Control Priority		x	1	97	20
Maximum Setpoint		x	120 F	200 F	140 F
Minimum Setpoint		x	120 F	200 F	120 F
Maximum Firing Rate		x	0	10000	10000
Minimum Firing Rate		x	0	10000	0
Demand Max		x	0%	100%	100%
Demand Min		x	0%	100%	20%
Demand On		x	0%	25%	15%
Demand Off		x	0%	25%	10%
Anti- Frost					
Anti Frost Mode		x	Disable	Pump Only/ Pump & Burner	Pump Only
Anti- Frost Setpoint		x	32 F	120 F	40 F
Anti- Frost Hysteresis		x	3 F	10 F	5 F
Anti- Frost Pump Control		x	NA	Boiler/ DHW/ System	Boiler
Warm Weather Shutdown (NOT Available on Volume Water Units)					
Anti- Short Cycle Time					

Heater continued

Cycle Time		x	10 secs	240 secs	60 secs
Temperature Conversion					
Conversion Unit	x	x	Celsius	Fahrenheit	Fahrenheit
BACnet					
Baudrate		x	9600	76800	76800
Address		x	0	255	127
Device Model Name		x	NA	NA	NA
Device Object Name		x	NA	NA	NA
Object Instance		x	0	4194303	600000
Timeout		x	0 secs	300 secs	300 secs
Mixing Valve Anti- Condensing (Low Temp Models ONLY)					
Mixing Valve Anti-Condensing Enable/Disable		x	Disable	Enable	Enable
Mixing Valve Anti-Condensing Temperature Setpoint		x	120 F	180 F	120 F
Mixing Valve Anti-Condensing Proportional Gain		x	0	32767	250
Mixing Valve Anti-Condensing Integral Time		x	0	32767	15
Mixing Valve Anti-Condensing Derivative Time		x	0	32767	0
Condensing Alarm Setpoint		x	100 F	120 F	110 F
Minimum Voltage Output		x	0 mV	4000 mV	3500 mV
Maximum Voltage Output		x	4 mV	10000 mV	6500 mV
Condensing Alarm Delay		x	0 mins	20 mins	10 mins
Condensing Shutdown Delay		x	0 mins	40 mins	20 mins
Service					
Stage 1 Burner Enable/Disable		x	Disable	Enable	Enable
Stage 2 Burner Enable/Disable		x	Disable	Enable	Enable
Stage 3 Burner Enable/Disable (Applicable to 1MM-2MM only)		x	Disable	Enable	Enable
Stage 4 Burner Enable/Disable (Applicable to 1.25MM-2MM only)		x	Disable	Enable	Enable
Screen Settings					
Light Timeout	x	x	0 secs	3600 secs	600 secs
AutoLock Timeout	x	x	0 secs	3600 secs	600 secs

10.G.3 Modbus Memory Map

MODBUS Address	Type	Bit	Read/Write	Value		
0	S16		Read Only	Inlet Temp		
1	S16		Read Only	Outlet Temp		
2	S16		Read Only	Not used		
3	S16		Read Only	DHW Temp		
4	S16		Read Only	System Inlet Temp		
5	S16		Read Only	System Outlet Temp		
6	S16		Read Only	Outdoor Temp		
7	S16		Read Only	Aux1 Temp		
8	S16		Read Only	Aux2 Temp		
9	S16		Read Only	Aux3 Temp		
10	S16		Read Only	Aux4 Temp		
11	S16		Read Only	Aux5 Temp		
12	S16		Read Only	Flame Signal 1		
13	S16		Read Only	Flame Signal 2		
14	S16		Read Only	Analog Input 1		
15	S16		Read Only	Analog Input 2		
16	S16		Read Only	Analog Input 3		
17	S16		Read Only	Analog Input 4		
18	BitField	b0	Read Only	Flow Switch		
		b1	Read Only	Low Water Cut Off		
		b2	Read Only	Man Reset High Limit		
		b3	Read Only	Pressure Switch		
		b4	Read Only	High Gas Pressure Switch		
		b5	Read Only	Low Gas Pressure Switch		
		b6	Read Only	Field Interlock Swich		
		b7	Read Only	Spare Safety Chain Swich		
19	BitField	b8...b15	Read Only	Not used		
		b0	Read Only	Damper Interlock Swich		
		b1	Read Only	Spare1 Swich		
20	S16		Read Only	Current Demand Source 0 -> No Demand 1 -> Anti Short Cycle 2 -> Service 3 -> DHW 4 -> Slave Cascade 5 -> External 6 -> CH1 7 -> CH2 8 -> CH3 9 -> CH4 10 -> Antifrost		
		21	BitField	b0	Read Only	Boiler Run Contact
				b1	Read Only	Alaram Contact
				b2	Read Only	DHW Pump
				b3	Read Only	System Pump
				b4	Read Only	Louver Contact
				b5	Read Only	Spare1 Contact
				b6	Read Only	Spare2 Contact
				b7	Read Only	Boiler Pump
		b8	Read Only	Spare Output		
b9...b15	Read Only	Not used				
22	BitField	b0	Read Only	Not used		
		b1	Read Only	Valve 1 Stage 1		
		b2	Read Only	Valve 2 Stage 1		
		b3	Read Only	Not used		
		b4	Read Only	Valve 1 Stage 2		
		b5	Read Only	Valve 2 Stage 2		
b6...b15	Read Only	Not used				
23	S16		Read Only	Analog Output 1		
24	S16		Read Only	Analog Output 2		
25	S16		Read Only	Analog Output 3		
26	S16		Read Only	Analog Output 4		
27	S16		Read Only	Not used		
28	S16		Read Only	Not used		
29	S16		Read Only	Blower 1 Speed 0 -> Off 1 -> Low 2 -> High		

MODBUS Address	Type	Bit	Read/Write	Value	
30	S16		Read Only	Blower 2 Speed 0 -> Off 1 -> Low 2 -> Hinh	
		31	S16	Read Only	HSI1 Current
		32	S16	Read Only	HSI2 Current
33	S16		Read Only	Burner 1 Power Rating	
34	S16		Read Only	Burner 2 Power Rating	
35	S16		Read Only	Lockout Code	
36	S16		Read Only	Blocking Code	
37	S16		Read Only	Not used	
38	U16		Read Only	DHW Call For Heat / 10	
39	U16		Read Only	CH1 Call For Heat / 10	
40	U16		Read Only	CH2 Call For Heat / 10	
41	U16		Read Only	Not used	
42	U16		Read Only	Not used	
43	U16		Read Only	Cascade Call For Heat / 10	
44	U16		Read Only	Valve 1 Stage1 Cycles / 10	
45	U16		Read Only	Valve 2 Stage1 Cycles / 10	
46	U16		Read Only	Valve 1 Stage2 Cycles / 10	
47	U16		Read Only	Valve 2 Stage2 Cycles / 10	
48	U16		Read Only	Boiler Pump Cycles / 10	
49	U16		Read Only	DHW Pump Cycles / 10	
50	U16		Read Only	System Pump Cycles / 10	
51	S16		Read Only	Average Outlet Temp	
52	S16		Read Only	Max Outlet Temp	
53	S16		Read Only	Min Outlet Temp	
54	U16		Read Only	Average Firing Time	
55	U16		Read Only	Max Firing Time	
56	U16		Read Only	Min Firing Time	
57	U16		Read Only	Not used	
58	U16		Read Only	Not used	
59	U16		Read Only	Not used	
60	U16		Read Only	Not used	
61	U16		Read Only	Not used	
62	U16		Read Only	Not used	
63	S16		Read Only	Not used	
64	S16		Read Only	Modulation Sensor 0 -> None 1 -> Outlet 2 -> DHW 3 -> System 4 -> Inlet 5 -> Flue 6 -> Svc return	
		65	U16	Read Only	Activate Service
66	U16		Read Only	Slave 1 State 0 -> Not Present 1 -> Not Available 2 -> Available 3 -> Running 4 -> Locked Out	
		67	U16	Read Only	Slave 1 Firing Rate
68	U16		Read Only	Slave 2 State 0 -> Not Present 1 -> Not Available 2 -> Available 3 -> Running 4 -> Locked Out	
		69	U16	Read Only	Slave 2 Firing Rate
70	U16		Read Only	Slave 3 State 0 -> Not Present 1 -> Not Available 2 -> Available 3 -> Running 4 -> Locked Out	
		71	U16	Read Only	Slave 3 Firing Rate
72	U16		Read Only	Slave 4 State 0 -> Not Present 1 -> Not Available 2 -> Available 3 -> Running 4 -> Locked Out	

MODBUS Address	Type	Bit	Read/Write	Value
73	U16		Read Only	Slave 4 Firing Rate
74	U16		Read Only	Slave 5 State 0 -> Not Present 1 -> Not Available 2 -> Available 3 -> Running 4 -> Locked Out
75	U16		Read Only	Slave 5 Firing Rate
76	U16		Read Only	Slave 6 State 0 -> Not Present 1 -> Not Available 2 -> Available 3 -> Running 4 -> Locked Out
77	U16		Read Only	Slave 6 Firing Rate
78	U16		Read Only	Slave 7 State 0 -> Not Present 1 -> Not Available 2 -> Available 3 -> Running 4 -> Locked Out
79	U16		Read Only	Slave 7 Firing Rate
80	U16		Read Only	Master State 0 -> Not Present 1 -> Not Available 2 -> Available 3 -> Running 4 -> Locked Out
81	U16		Read Only	Master Firing Rate
82	S16		Read Only	Not used
83	U16		Read Only	Active CH Setpoint
84	U16		Read Only	Burner 1 Status
85	U16		Read Only	Burner 2 Status
86	U16		Read Only	Not used
87	U16		Read Only	Not used
88	U16		Read Only	Not used
89	U16		Read Only	Boiler Pump Status
90	U16		Read Only	Master Demand
91	U16		Read Only	Burner 1 Run Time
92	S16		Read Only	Burner 2 Run Time
...	S16		Read Only	Not used
127	S16		Read Only	Not used
128	S16		Read/Write	CH1 Enable/Disable
129	S16		Read/Write	CH1 Setpoint
130	S16		Read/Write	CH1 P
131	S16		Read/Write	CH1 I
132	S16		Read/Write	CH1 D
133	S16		Read/Write	CH2 Enable/Disable
134	S16		Read/Write	CH2 Setpoint
135	S16		Read/Write	CH2 P
136	S16		Read/Write	CH2 I
137	S16		Read/Write	CH2 D
138	S16		Read/Write	Not used
139	S16		Read/Write	Not used
140	S16		Read/Write	Not used
141	S16		Read/Write	Not used
142	S16		Read/Write	Not used
143	S16		Read/Write	Not used
144	S16		Read/Write	Not used
145	S16		Read/Write	Not used
146	S16		Read/Write	Not used
147	S16		Read/Write	Not used
148	S16		Read/Write	DHW Enable/Disable
149	S16		Read/Write	DHW Setpoint
150	S16		Read/Write	DHW P
151	S16		Read/Write	DHW I
152	S16		Read/Write	DHW D
153	S16		Read/Write	Not used
154	S16		Read/Write	Not used
155	S16		Read/Write	Cascade Setpoint
156	S16		Read/Write	Cascade P

MODBUS Address	Type	Bit	Read/Write	Value
157	S16		Read/Write	Cascade I
158	S16		Read/Write	Cascade D
159	S16		Read/Write	Not used
160	S16		Read/Write	Not used
161	S16		Read/Write	Not used
162	S16		Read/Write	Not used
163	S16		Read/Write	Hybrid Setpoint
164	S16		Read/Write	Hybrid Differential Temp
165	S16		Read/Write	Not used
166	S16		Read/Write	Not used
167	S16		Read/Write	Not used
168	S16		Read/Write	Not used
169	U16		Read/Write	AntiCondens Enable
170	S16		Read/Write	AntiCondens Temp
171	S16		Read/Write	AntiCondens P
172	S16		Read/Write	AntiCondens I
173	S16		Read/Write	AntiCondens D
174	S16		Read/Write	DHW demand
175	S16		Read/Write	CH1 demand
176	S16		Read/Write	CH2 demand
177	S16		Read/Write	Not used
178	S16		Read/Write	Not used
179	S16		Read/Write	Parameters enable

10.G.4 BACnet MSTP Memory Map

BacNet Address	BacNet Type	Bit	Value	Unit
0	AI		Inlet Temp	[C]/[F]
1	AI		Outlet Temp	[C]/[F]
2	AI		Not used	
3	AI		DHW Temp	[C]/[F]
4	AI		System Inlet Temp	[C]/[F]
5	AI		System Outlet Temp	[C]/[F]
6	AI		Outdoor Temp	[C]/[F]
7	AI		Aux1 Temp	[C]/[F]
8	AI		Aux2 Temp	[C]/[F]
9	AI		Aux3 Temp	[C]/[F]
10	AI		Aux4 Temp	[C]/[F]
11	AI		Aux5 Temp	[C]/[F]
12	AI		Flame Signal 1	[uA]
13	AI		Flame Signal 2	[uA]
14	AI		Analog Input 1	[mv]
15	AI		Analog Input 2	[mv]
16	AI		Analog Input 3	[mv]
17	AI		Analog Input 4	[mv]
18	AI	b0	Flow Switch	bit
		b1	Low Water Cut Off	bit
		b2	Man Reset High Limit	bit
		b3	Pressure Switch	bit
		b4	High Gas Pressure Switch	bit
		b5	Low Gas Pressure Switch	bit
		b6	Field Interlock Swicth	bit
		b7	Spare Safety Chain Swicth	bit
19	AI	b8...b15	Not used	bit
		b0	Damper Interlock Swicth	bit
		b1	Spare1 Swicth	bit
		b2...b15	Not used	bit
20	AI		Current Demand Source 0 -> No Demand 1 -> Anti Short Cycle 2 -> Service 3 -> DHW 4 -> Slave Cascade 5 -> External 6 -> CH1 7 -> CH2 8 -> CH3 9 -> CH4 10 -> Antifrost	
21	AI	b0	Boiler Run Contact	bit
		b1	Alaram Contact	bit
		b2	DHW Pump	bit
		b3	System Pump	bit
		b4	Louver Contact	bit
		b5	Spare1 Contact	bit
		b6	Spare2 Contact	bit
		b7	Boiler Pump	bit
		b8	Spare Output	bit
b9...b15	Not used	bit		
22	AI	b0	Not used	bit
		b1	Valve 1 Stage 1	bit
		b2	Valve 2 Stage 1	bit
		b3	Not used	bit
		b4	Valve 1 Stage 2	bit
		b5	Valve 2 Stage 2	bit
b6...b15	Not used	bit		
23	AI		Analog Output 1	[mV]
24	AI		Analog Output 2	[mV]
25	AI		Analog Output 3	[mV]
26	AI		Analog Output 4	[mV]
27	AI		Not used	[rpm]
28	AI		Not used	[rpm]
29	AI		Blower 1 Speed 0 -> Off 1 -> Low 2 -> High	
30	AI		Blower 2 Speed 0 -> Off 1 -> Low 2 -> High	

BacNet Address	BacNet Type	Bit	Value	Unit
31	AI		HSI1 Current	[mA]
32	AI		HSI2 Current	[mA]
33	AI		Burner 1 Power Rating	[%]
34	AI		Burner 2 Power Rating	[%]
35	AI		Lockout Code	
36	AI		Blocking Code	
37	AI		Not used	
38	AI		DHW Call For Heat / 10	[cycles * 10]
39	AI		CH1 Call For Heat / 10	[cycles * 10]
40	AI		CH2 Call For Heat / 10	[cycles * 10]
41	AI		Not used	[cycles * 10]
42	AI		Not used	[cycles * 10]
43	AI		Cascade Call For Heat / 10	[cycles * 10]
44	AI		Valve 1 Stage1 Cycles / 10	[cycles * 10]
45	AI		Valve 2 Stage1 Cycles / 10	[cycles * 10]
46	AI		Valve 1 Stage2 Cycles / 10	[cycles * 10]
47	AI		Valve 2 Stage2 Cycles / 10	[cycles * 10]
48	AI		Boiler Pump Cycles / 10	[cycles * 10]
49	AI		DHW Pump Cycles / 10	[cycles * 10]
50	AI		System Pump Cycles / 10	[cycles * 10]
51	AI		Average Outlet Temp	[C]/[F]
52	AI		Max Outlet Temp	[C]/[F]
53	AI		Min Outlet Temp	[C]/[F]
54	AI		Average Firing Time	[h]
55	AI		Max Firing Time	[h]
56	AI		Min Firing Time	[h]
57	AI		Not used	
58	AI		Not used	
59	AI		Not used	
60	AI		Not used	
61	AI		Not used	
62	AI		Not used	
63	AI		Not used	
64	AI		Modulation Sensor 0 -> None 1 -> Outlet 2 -> DHW 3 -> System 4 -> Inlet 5 -> Flue 6 -> Swe return	
65	AI		Activate Service	
66	AI		Slave 1 State 0 -> Not Present 1 -> Not Available 2 -> Available 3 -> Running 4 -> Locked Out	
67	AI		Slave 1 Firing Rate	
68	AI		Slave 2 State 0 -> Not Present 1 -> Not Available 2 -> Available 3 -> Running 4 -> Locked Out	
69	AI		Slave 2 Firing Rate	
70	AI		Slave 3 State 0 -> Not Present 1 -> Not Available 2 -> Available 3 -> Running 4 -> Locked Out	
71	AI		Slave 3 Firing Rate	
72	AI		Slave 4 State 0 -> Not Present 1 -> Not Available 2 -> Available 3 -> Running 4 -> Locked Out	
73	AI		Slave 4 Firing Rate	
74	AI		Slave 5 State 0 -> Not Present 1 -> Not Available 2 -> Available 3 -> Running 4 -> Locked Out	

BacNet Address	BacNet Type	Bit	Value	Unit
75	AI		Slave 5 Firing Rate	
76	AI		Slave 6 State 0 -> Not Present 1 -> Not Available 2 -> Available 3 -> Running 4 -> Locked Out	
77	AI		Slave 6 Firing Rate	
78	AI		Slave 7 State 0 -> Not Present 1 -> Not Available 2 -> Available 3 -> Running 4 -> Locked Out	
79	AI		Slave 7 Firing Rate	
80	AI		Master State 0 -> Not Present 1 -> Not Available 2 -> Available 3 -> Running 4 -> Locked Out	
81	AI		Master Firing Rate	
82	AI		Not used	
83	AI		Active CH Setpoint	
84	AI		Burner 1 Status	
85	AI		Burner 2 Status	
86	AI		Not used	
87	AI		Not used	
88	AI		Not used	
89	AI		Boiler Pump Status	
90	AI		Master Demand	
91	AI		Burner 1 Run Time	[h]
92	AI		Burner 2 Run Time	[h]
			Not used	
			Not used	
0	AV		CH1 Enable/Disable	
1	AV		CH1 Setpoint	[C]/[F]
2	AV		CH1 P	
3	AV		CH1 I	
4	AV		CH1 D	
5	AV		CH2 Enable/Disable	
6	AV		CH2 Setpoint	[C]/[F]
7	AV		CH2 P	
8	AV		CH2 I	
9	AV		CH2 D	
10	AV		Not used	
11	AV		Not used	[C]/[F]
12	AV		Not used	
13	AV		Not used	
14	AV		Not used	
15	AV		Not used	
16	AV		Not used	[C]/[F]
17	AV		Not used	
18	AV		Not used	
19	AV		Not used	
20	AV		DHW Enable/Disable	
21	AV		DHW Setpoint	[C]/[F]
22	AV		DHW P	
23	AV		DHW I	
24	AV		DHW D	
25	AV		Not used	
26	AV		Not used	[C]/[F]
27	AV		Cascade Setpoint	[C]/[F]
28	AV		Cascade P	
29	AV		Cascade I	
30	AV		Cascade D	
31	AV		Not used	
32	AV		Not used	
33	AV		Not used	
34	AV		Not used	
35	AV		Hybrid Setpoint	[C]/[F]
36	AV		Hybrid Differential Temp	[C]/[F]
37	AV		Not used	

BacNet Address	BacNet Type	Bit	Value	Unit
38	AV		Not used	
39	AV		Not used	
40	AV		Not used	[C]/[F]
41	AV		AntiCondens Enable	
42	AV		AntiCondens Temp	[C]/[F]
43	AV		AntiCondens P	
44	AV		AntiCondens I	
45	AV		AntiCondens D	
0	BV		DHW demand	
1	BV		CH1 demand	
2	BV		CH2 demand	
3	BV		Not used	
4	BV		Not used	

Item	Description	Size	Size	Size	Size	Size	Size	Size	Size
		500	750	1000	1250	1500	1750	2000	
Internal Components									
<i>See Figure 37 on page 101</i>									
17	Base Assembly	5C1020	7C1020	10C1020	12C1020	15C1020	17C1020	20C1020	
18	Chamber, Front	5C2003	7C2003	10C2003	12C2003	15C2003	17C2003	20C2003	
18A	Chamber, Left Side, Front	5C2015	5C2015	5C2015	5C2015	5C2015	5C2015	5C2015	
18B	Chamber, Right Side, Front	5C2016	5C2016	5C2016	5C2016	5C2016	5C2016	5C2016	
19	Chamber, Rear	5C2006	7C2006	10C2006	12C2006	15C2006	17C2006	20C2006	
20	Chamber Assembly, Left, Bottom	5C2602	5C2602	5C2602	5C2602	5C2602	5C2602	5C2602	
21	Chamber Assembly, Right, Bottom	5C2200	5C2200	5C2200	5C2200	5C2200	5C2200	5C2200	
22	Chamber, Top	5C2001	7C2001	10C2001	12C2001	15C2001	17C2001	20C2001	
23	Chamber, Side, Top	5C2002	5C2002	5C2002	5C2002	5C2002	5C2002	5C2002	
24	Exhaust Plenum	5C2007	10C2007	10C2007	20C2007	20C2007	20C2007	20C2007	
25	Bracket, Chamber, Front	5C2009	7C2009	10C2009					
	Bracket, Chamber, Front Left				12C2011	15C2011	17C2011	20C2011	
26	Bracket, Chamber, Front Right				12C2009	15C2009	17C2009	20C2009	
27	Divider, Chamber, Front						15C2010	20C2002	
27A	Divider, Upper, Chamber, Front				15C2005	15C2005			
27B	Divider, Lower, Chamber, Front				15C2002	15C2002			
28	Cover, Chamber	5C2004	7C2004						
	Cover, Chamber, Front Left			10C2004	12C2010	15C2004	17C2010	20C2010	
29	Door, Chamber Access	5C2005	5C2005	5C2005	5C2005	5C2005	5C2005	5C2005	
		(1)	(1)	(1)	(2)	(2)	(2)	(2)	
30	Cover, Chamber, Front Right			10C2010	12C2008	15C2004	17C2008	20C2008	
32	Ignitor, Hot Surface, with Gasket	2400-286	2400-286	2400-286	2400-286	2400-286	2400-286	2400-286	
		(1)	(1)	(2)	(2)	(2)	(2)	(2)	
33	Tile, Side (Right and Left)	T2015600	T2015600	T2015600	T2015600	T2015600	T2015600	T2015600	
		(2)	(2)	(2)	(2)	(2)	(2)	(2)	
34	Tile, Front	T2017300							
		(1)							
35	Tile, Front, Left Side		T2016200	T2016800	T2016800	T2016800	T2016800	T2016800	
			(1)	(1)	(1)	(1)	(1)	(1)	
35A	Tile, Front, Right Side		T2016300	T2017100	T2017900	T2017100	T2017900	T2017100	
			(1)	(1)	(1)	(1)	(1)	(1)	
35B	Tile, Front, Center			T2016900	T2016900	T2016900	T2016900	T2016900	

Item	Description	Model 500	Model 750	Model 1000	Model 1250	Model 1500	Model 1750	Model 2000
72	Terminal Bus (12 Position)	E2342600	E2342600	E2342600	E2342600	E2342600	E2342600	E2342600
73	Transformer	E2310400	E2310400	E2310400	E2318800 (x2)	E2318800 (x2)	E2318800 (x2)	E2318800 (x2)
74	Circuit Breaker	E2106200	E2106200	E2106200	E2318800	E2318800	E2318900	E2318900
75	Switch, Rocker (main power) <i>not shown</i>	E2343300	E2343300	E2343300	E2343300	E2343300	E2343300	E2343300
Gas Train Components								
See Figure 37 on page 101								
76	Manifold, Gas Supply	5C6700	7C6700	10C6700	12C6700	15C6700	17C6700	20C6700
77	Valve, Ball	V2003100	V2003100	V2003200	V2003300	V2003300	V2003300	V2003300
Burner Trays								
Note: Burner Manifold Assemblies contain item numbers 78 through 81.								
	Burner Manifold Assy, 3 Burners, Right, Nat	5C6600	5C6600	5C6600	5C6600	5C6600	5C6600	5C6600
		(1)	(1)	(1)	(2)	(1)	(1)	(1)
	Burner Manifold Assy, 3 Burners, Left, Nat	5C6500	5C6500	5C6500	5C6500	5C6500	5C6500	5C6500
		(1)	(2)	(2)	(3)	(1)	(2)	(2)
	Burner Manifold Assy, 4 Burners, Right, Nat	10C6600	10C6600	10C6600	10C6600	10C6600	10C6600	10C6600
		(1)	(1)	(1)	(1)	(1)	(1)	(2)
	Burner Manifold Assy, 4 Burners, Left, Nat	10C6500	10C6500	10C6500	10C6500	10C6500	10C6500	10C6500
		(2)	(2)	(2)	(2)	(2)	(2)	(4)
	Burner Manifold Assy, 3 Burners, Right, LP	5C6620	5C6620	5C6620	5C6620	5C6620	5C6600	5C6600
		(1)	(1)	(1)	(2)	(1)	(1)	(1)
	Burner Manifold Assy, 3 Burners, Left, LP	5C6520	5C6520	5C6520	5C6520	5C6520	5C6500	5C6500
		(1)	(1)	(3)	(3)	(1)	(2)	(2)
	Burner Manifold Assy, 4 Burners, Right, LP	10C6620	10C6620	10C6620	10C6620	10C6620	10C6620	10C6620
		(1)	(1)	(1)	(1)	(1)	(1)	(2)
	Burner Manifold Assy, 4 Burners, Left, LP	10C6520	10C6520	10C6520	10C6520	10C6520	10C6520	10C6520
		(2)	(2)	(2)	(2)	(2)	(2)	(4)
78	Valve, Gas, Combination	V2017600	V2017600	V2017600	V2017600	V2017600	V2017600	V2017600
		(2)	(3)	(3)	(5)	(5)	(6)	(6)
79	Valve, Manual Shutoff	V2000200	V2000200	V2000200	V2000200	V2000200	V2000200	V2000200
		(2)	(3)	(3)	(5)	(5)	(6)	(6)
80	Orifice, Gas, Natural	L2013000	L2013000	L2013000	L2013000	L2013000	L2013000	L2013000
		(6)	(9)	(12)	(15)	(18)	(21)	(24)

11.C Parts Illustrations

**NOTE: Size 2000
shown for reference.**

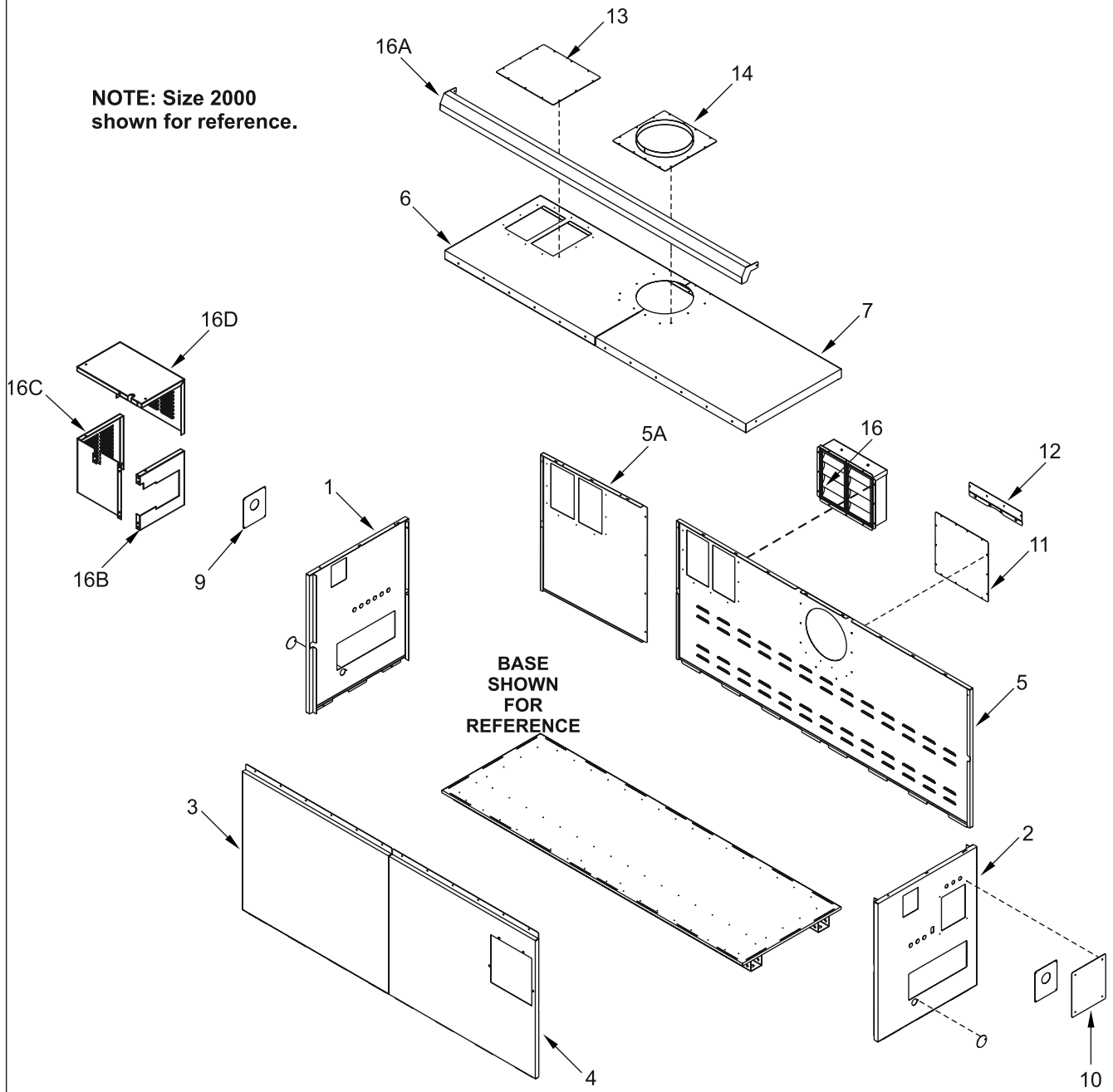

Figure 36. Sheet Metal Components.

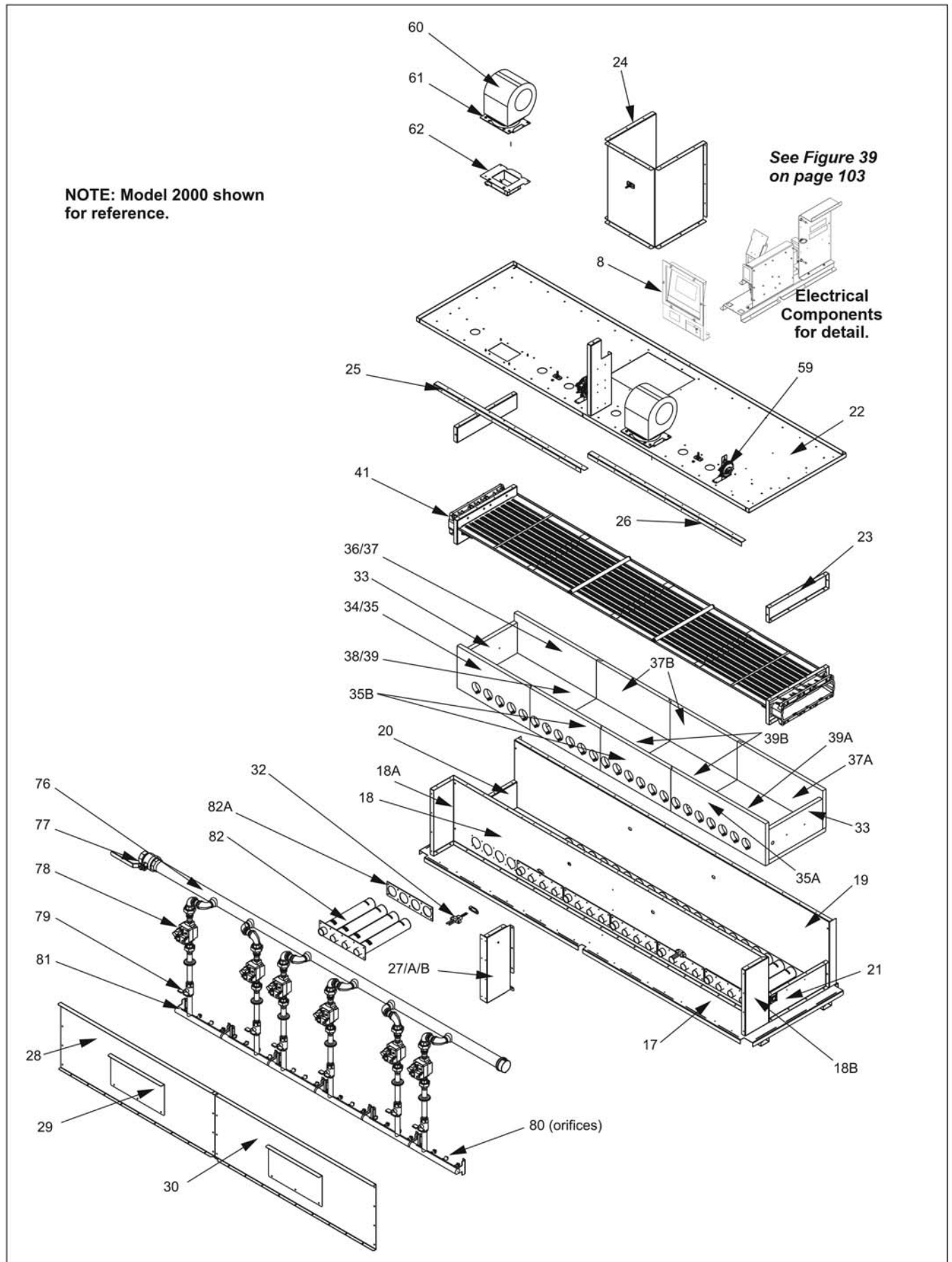
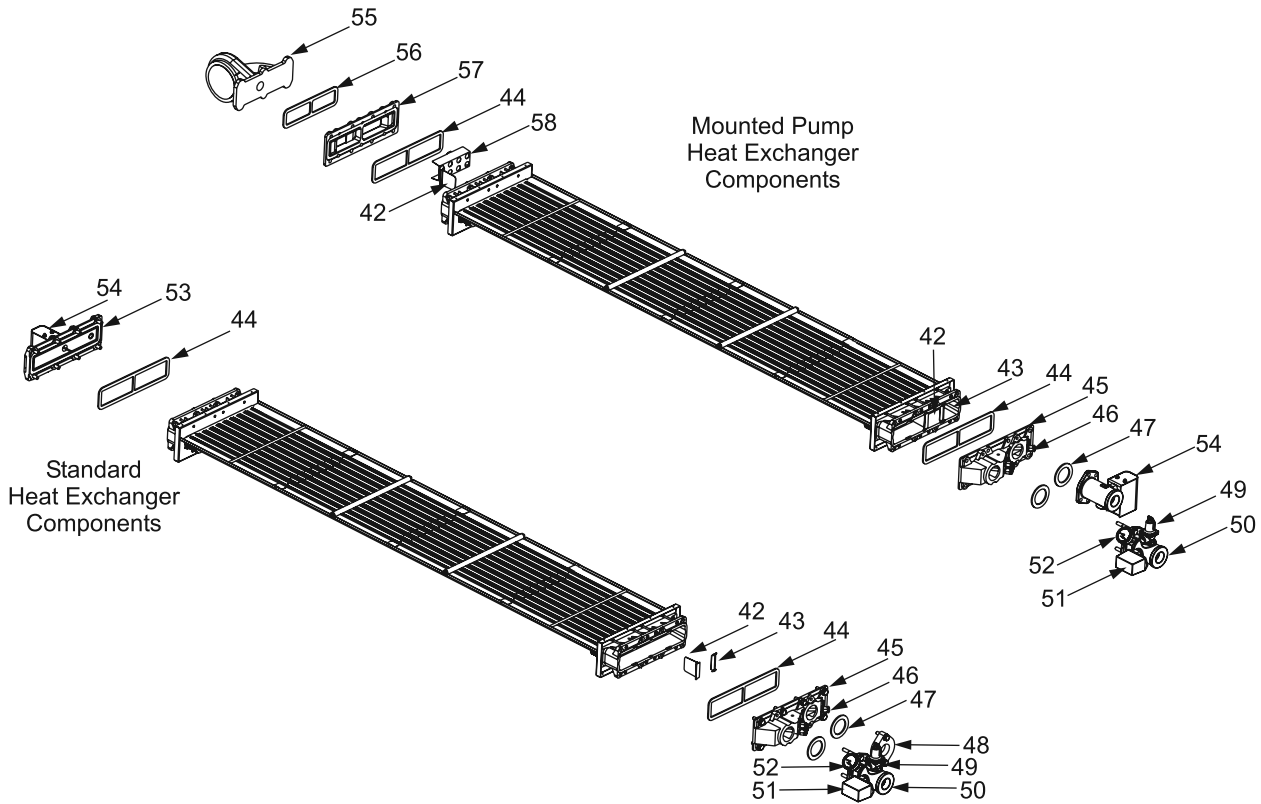

Figure 37. Internal Components.

See pump chart below for pump numbers.



Copper Brute II Hydronic Boiler

SIZE	TACO PUMP P/N	B&G PUMP P/N
500	A2117201	A2121803
750	A2117201	A2121803
1000	A2117202	A2121802
1250	A2117202	A2121802
1500	A2117203	A2121801
1750	A2117203	A2121801
2000	A2117204	A2121800

Copper Brute II Water Heater with TACO Pump

SIZE	TACO PUMP P/N		
	Soft Water	Normal Water	Hard Water
500	A2117201	A2117201	A2117203
750	A2117201	A2117201	A2117203
1000	A2117201	A2117202	A2117203
1250	A2117201	A2117202	A2117203
1500	A2117201	A2117203	A2117203
1750	A2117203	A2117203	A2117203
2000	A2117204	A2117204	A2117204

Copper Brute II Water Heater with B&G Pump

SIZE	B&G PUMP P/N		
	Soft Water	Normal Water	Hard Water
500	A2121803	A2121803	A2121801
750	A2121803	A2121803	A2121801
1000	A2121803	A2121802	A2121801
1250	A2121803	A2121802	A2121801
1500	A2121803	A2121801	A2121801
1750	A2121801	A2121801	A2121801
2000	A2121800	A2121800	A2121800

Figure 38. Heat Exchanger Components.

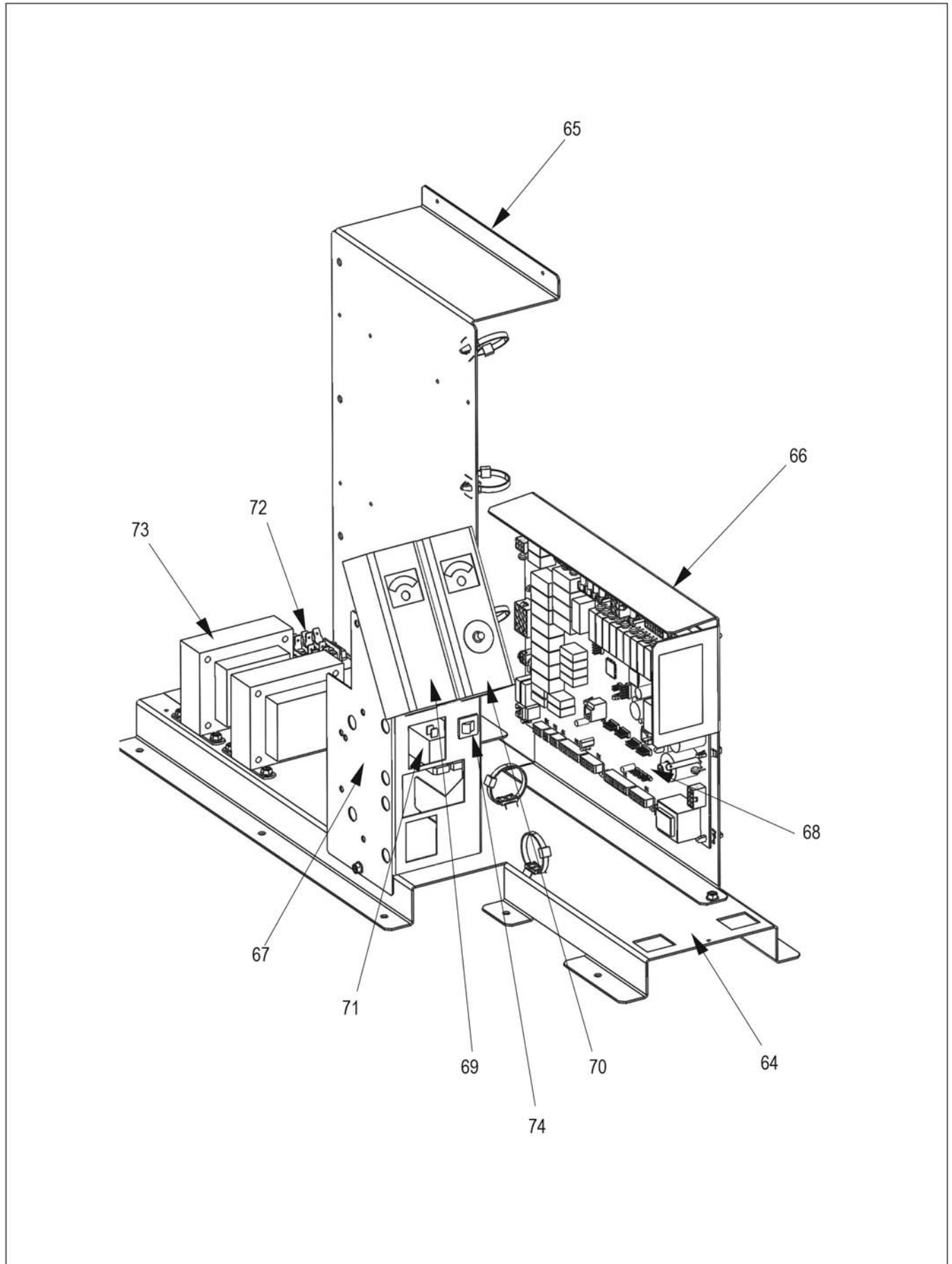

Figure 39. Electrical Components.

