

Approval: _____
Customer Signature Required Upon Order

Customer Company Name: _____

1. Shell Side:
 - Max. Allowable Work Pressure: 150psi @ 150F
 - Min. Design Metal Temp.: -20F @ 150psi
 - Capacity: SEE CHART ft3
 - Type of Fluid (Non-lethal): WATER / ANTIFREEZE
 - Physical State of Fluid: LIQUID
 - Vessel Stamp: NON-CODE
2. Tube Side:
 - Max. Allowable Work Pressure: 225psi @ 150F
 - Min. Design Metal Temp.: -20F @ 225psi
 - Capacity: SEE CHART ft3
 - Type of Fluid (Non-lethal): CFC, HFC, HCFC, OIL
 - Physical State of Fluid: LIQUID / VAPOR
 - Vessel Stamp: UM

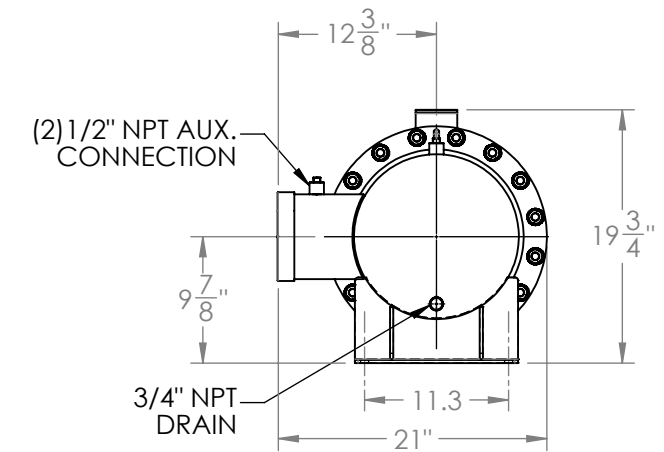
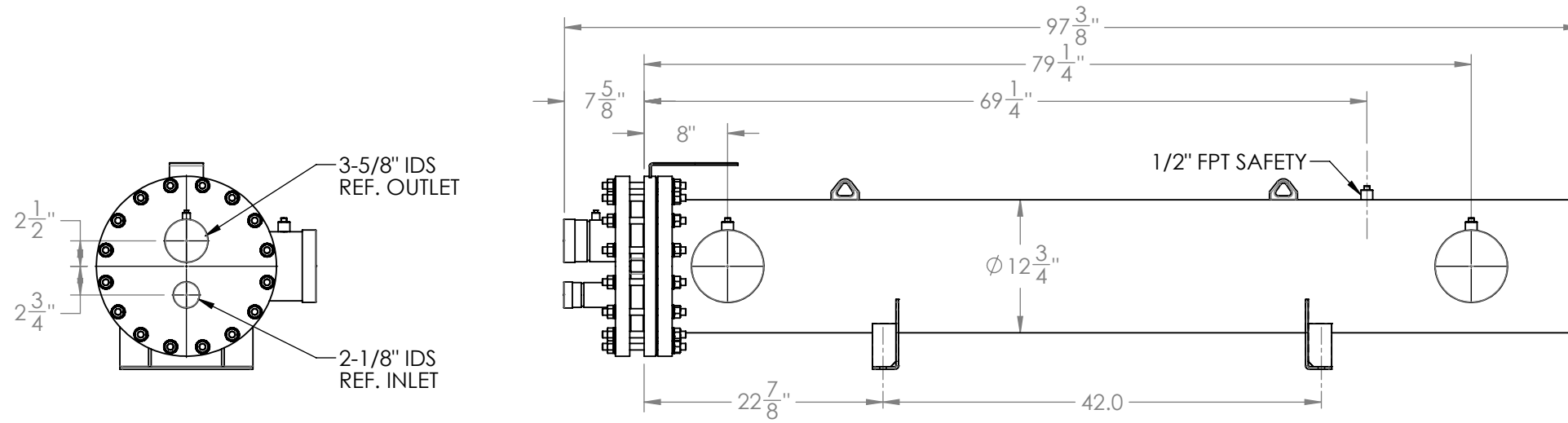
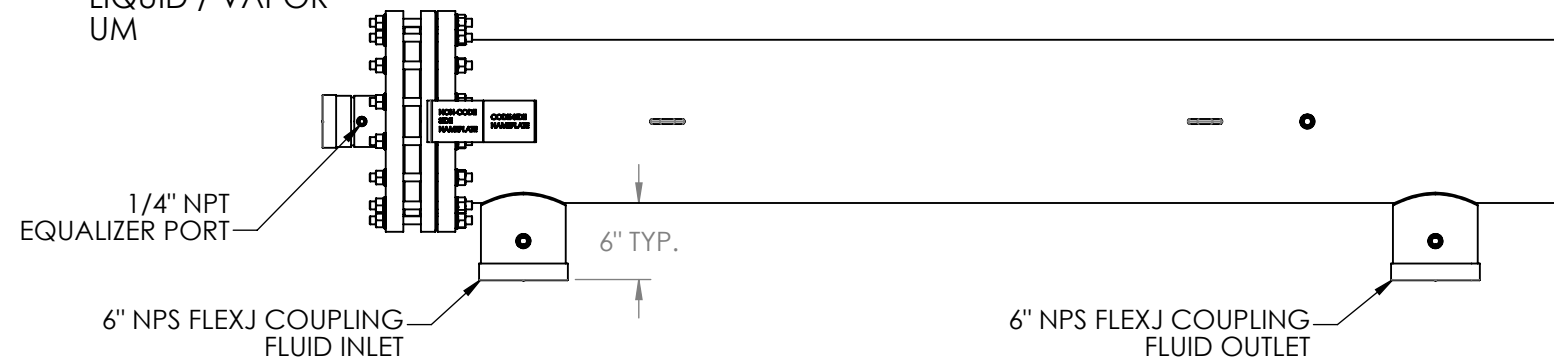
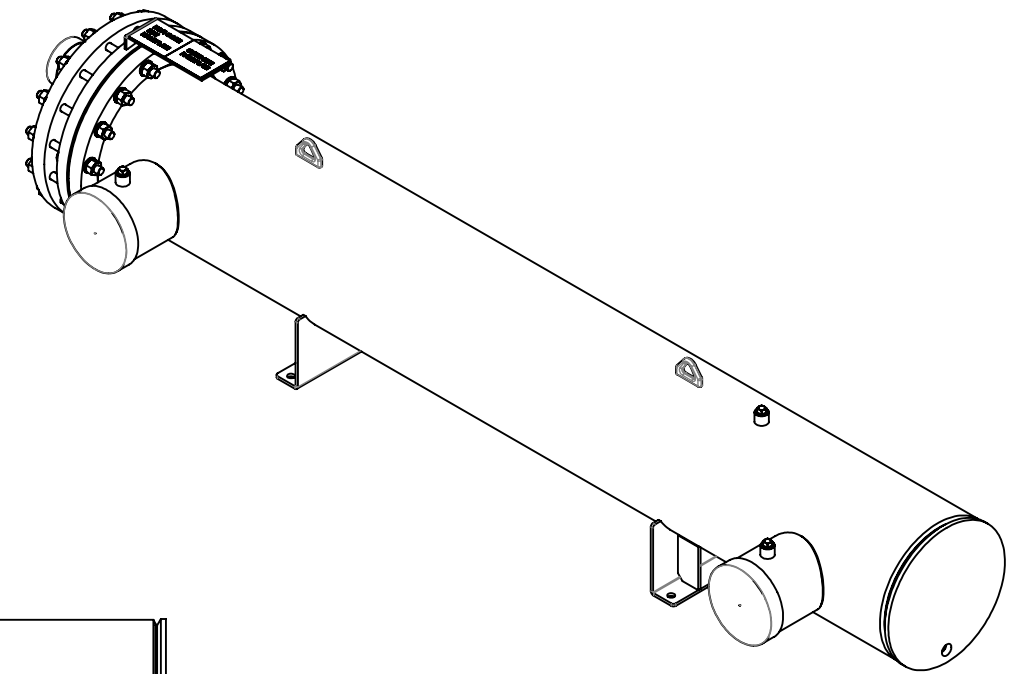

- NOTE:
1. VESSEL TO BE SHIPPED WITH 3/4" INSULATION
 2. DIMENSIONS DO NOT INCLUDE INSULATION
 3. VESSEL WILL BE PAINTED BLACK
 4. THE MATERIAL OF THE TUBE IS COPPER
 5. PRESSURE BOUNDARIES ARE CARBON STEEL

PROPRIETARY AND CONFIDENTIAL
 THE INFORMATION CONTAINED IN THIS DRAWING IS THE SOLE PROPERTY OF BITZER US. ANY REPRODUCTION IN PART OR AS WHOLE WITHOUT THE WRITTEN PERMISSION OF BITZER US IS PROHIBITED.

VIEW CONVENTION
 THIRD ANGLE
 ANGULAR TOL ± 2°
 FRAC TOL ± 1/4
 1 INCH = 25.400000 MM

BREAK SHARP EDGES
 THREADS TO BE CLASS 2
 DIM & TOL PER ANSI Y14.5M

INCHES		METRIC (MM)	
.X	± .125	X.	± 1
.XX	± .063	X.X	± 0.5
.XXX	± .005	X.XX	± 0.25
		X.XXX	± 0.13

NO	REVISIONS (INDICATED BY Δ)	BY	DATE	JOB#
0	ORIGINAL	JEL	10/16/2014	
1				MATERIAL
2				
3				
4				
5				
6				

TITLE: **APPROVAL DRAWING**

SIZE B	VESSEL NO. STEM120-1NRJXTX	REV 00
SCALE: 1:15		SHIPPING WEIGHT: 892 lbs