

***SCOTT***

---

BIKE

SCOTT SCALE  
USER MANUAL

---

INNOVATION  
TECHNOLOGY  
DESIGN

---

**WWW.SCOTT-SPORTS.COM**

All rights reserved © 2017 SCOTT Sports SA

Distribution:  
SSG (Europe) Distribution Center SA, P.E.D. Zone C1, Rue du Kiell 60, 6790 Aubange, Belgium

v6.4/040717



**WWW.SCOTT-SPORTS.COM**

SCOTT Sports SA  
Route du Crochet 17, CH-1762 Givisiez  
Phone: +41 26 460 16 16 | Fax: +41 26 460 16 00  
Email: [scottsupport@scott-sports.com](mailto:scottsupport@scott-sports.com)

---



The SCOTT Scale should be adjusted exactly to the individual rider to achieve maximum safety and fun while riding.

**SCOTT recommends that all adjustments be carried out by your local authorized SCOTT dealer.** Some basic maintenance can be done if strictly following the manuals supplied with this bike.

Please contact your authorized SCOTT dealer for advice in order to avoid any harm and assist you with any questions or technical problems.

**⚠ IMPORTANT**

**SCOTT Scale 3:**

**2017:**

- Scale RC 900/700 SL,
- Scale RC 900/700 Ultimate,
- Scale RC 900/700 World Cup,
- Scale RC 900/700 Pro,
- Scale 900/700,
- Scale 910/710,
- Scale 920/720

**SCOTT Scale 2:**

**2017:**

- Scale 930/730,
- Scale 935/73

**2016:**

- Scale 900/700 SL,
- Scale 900/700 Premium,
- Scale 900/700 RC,
- Scale 910/710,
- Scale 920/720,
- Scale 930/730,
- Scale 935/735

**CONTENTS**

**SCOTT SCALE 3 . . . . . 04**

Scale Concept . . . . . 04

Geometry/Technical Data Scale 3 700 . . . . . 05

Geometry/Technical Data Scale 3 900 . . . . . 06

**RIDELOC . . . . . 07**

Basic Set-Up of Forks . . . . . 08

**SAG . . . . . 09**

Rebound Fork Set-Up . . . . . 10

Replaceable Rear Dropout . . . . . 10

Cable Guides and Cabling . . . . . 12

BB Standards/FD Mounting Details . . . . . 13

Adjustment . . . . . 13

**SCOTT SCALE 2 . . . . . 14**

Scale Concept . . . . . 14

Geometry/Technical Data Scale . . . . . 14

BB Standards/FD Mounting Details . . . . . 16

Chainguide . . . . . 16

Headset Options . . . . . 17

BB Cable Guide/Cable Routing . . . . . 18

Seattube Clamp . . . . . 20

Replaceable Rear Derailleur Hanger . . . . . 20

Rear Disc Brake Mount . . . . . 21

Front Fork Set-Up/Change of Front Fork . . . . . 21

**GUARANTEE ON SCOTT BIKES . . . . . 22**

# SCOTT SCALE 3

## SCALE CONCEPT

From the Carbon fiber to the manufacturing process to the final result- the new Scale has been completely redesigned. The result: a new benchmark for race hardtail frames. The Scale RC 700 SL weighs in at only 849 grams. The incredible lightweight frame characteristics and two dedicated frame platforms for 1x and 2x drivetrains lift the standard of hardtail mountain bikes to a new level.

A mix of high-end carbon fibers has been used on all Scale Carbon frames in order to achieve incredible results. The HMX-SL frame utilizes MR70, YS60 and HR40 Carbon fibers. HR40 is a strong and light filament which, used together with MR70 fibers, attains unachieved tensile strength values. In order to achieve the set stiffness targets, YS60 layers are added into the lay-up. After choosing the Carbon fibers, the engineers are using specific tools, like FEA software, to map out the carbon lay-up. Thanks to SCOTT's proprietary EvoLap-Technology, different forces can be applied on a virtual model and the frame construction is adjusted accordingly.

The SDS2 technology achieves comfort in carbon frames without adding parts or sacrificing stiffness characteristics. In order to achieve this, the engineers use different tube shapes in combination with a strategic alignment of the carbon fibers to avoid any undesired flex that can impair performance.

The Boost standard improves wheel stiffness and allows for increased tire clearance. The new Scale frame has been developed around the Boost standard in order to maximize the advantages of the new norm. The three millimeter outboard chain ring adds clearance to the chainstay area allowing for a significant increase of the chainstay cross-section for both, the 1x and 2x models. This offers more possibilities to find the right position of the rear wheel in the frame in order to achieve improved structural stiffness.

The new Scale is available in two different versions. The HMX-SL and HMX frames are optimized for 1x drivetrains only and therefore dedicated to race-oriented riders. The HMF line-up is designed and optimized around a double chain ring setup. These models can, however, accommodate a single chainring configuration.

On the new Scale introduce a specific brake mount adapter which is linked directly to the chainstay and thru-axle in order to increase stiffness.

Routing the cables internally avoids bulky external hardware and looks cleaner. Due to the improved protection, the cables have a longer lifetime.

The new Scale chain guide weighs in at just 23 grams, is easy to assemble thanks to a smart mounting system and can accommodate 30T to 36T chainrings.

The new Scale dropouts are designed to be integrated on the thru-axle system thanks to a hollow tube design that allows a simple and lightweight structure.

## GEOMETRY/TECHNICAL DATA SCALE 3 700

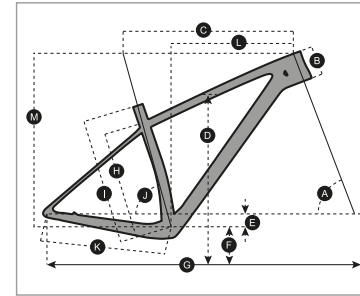

### IMPORTANT

Only a bottle with 0.55L capacity will have the clearance to fit a small frame

Seatpost Diameter	31.6mm
Seattube clamp	34.9
Headset	bearings: 51.9x40x8 45° x 45° / 41.8x30.5x8 45° x 45°
Fork travel	100mm
BB housing	BB PF92
Front derailleur	Shimano high direct mount side swing (none RC models only) <b>Additional parts needed</b>
Chainring size	38T max
Max tyre width	2.3/57mm

**Please note:**  
Tire sizes often vary from brand to brand. Ensure the tire clearance is adequate when replacing your tires!

	S		M		L	
A HEAD TUBE ANGLE	69.0°		69.0°		69.0°	
B HEAD TUBE LENGTH	95.0 mm	3.7 in	100.0 mm	3.9 in	115.0 mm	4.5 in
C TOP TUBE HORIZONTAL	575.0 mm	22.6 in	600.0 mm	23.6 in	625.0 mm	24.6 in
D STANDOVER HEIGHT	726.0 mm	28.6 in	756.0 mm	29.8 in	784.0 mm	30.9 in
E BB OFFSET	-46.0 mm	-1.8 in	-46.0 mm	-1.8 in	-46.0 mm	-1.8 in
F BB HEIGHT	305.5 mm	12.0 in	305.5 mm	12.0 in	305.5 mm	12.0 in
G WHEEL BASE	1,073.7 mm	42.3 in	1,099.0 mm	43.3 in	1,125.2 mm	44.3 in
H BB CENTER TO TOPTUBE CENTER	325.0 mm	12.8 in	375.0 mm	14.8 in	415.0 mm	16.3 in
I BB CENTER TO TOP OF SEATTUBE	390.0 mm	15.4 in	440.0 mm	17.3 in	480.0 mm	18.9 in
J SEAT ANGLE	73.2°		73.2°		73.2°	
K CHAINSTAY	425.0 mm	16.7 in	425.0 mm	16.7 in	425.0 mm	16.7 in
L REACH	401.0 mm	15.8 in	424.6 mm	16.7 in	445.3 mm	17.5 in
M STACK	575.0 mm	22.6 in	579.6 mm	22.8 in	593.6 mm	23.4 in
N STEM LENGTH	60.0 mm	2.4 in	70.0 mm	2.8 in	80.0 mm	3.1 in
O TRAIL	87.8 mm	3.5 in	87.8 mm	3.5 in	87.8 mm	3.5 in

## GEOMETRY/TECHNICAL DATA SCALE 3 900

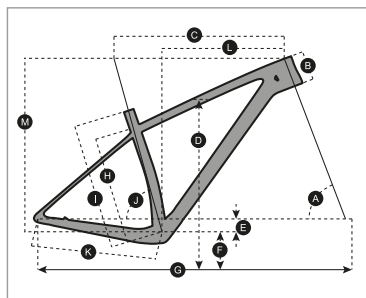

### IMPORTANT

Only a bottle with 0.55L capacity will have the clearance to fit a small frame

Seatpost Diameter	31.6mm
Seattube clamp	34.9
Headset	bearings: 51.9x40x8 45 ° x 45 ° / 41.8x30.5x8 45 ° x 45 °
Fork travel	100mm
BB housing	BB PF92
Front derailleur	Shimano high direct mount side swing (none RC models only) <b>Additional parts needed</b>
Chaining size	38T max
Max tyre width	2.3/57mm

**Please note:**  
Tire sizes often vary from brand to brand. Ensure the tire clearance is adequate when replacing your tires!

	S		M		L		XL	
A HEAD TUBE ANGLE	69.5 °		69.5 °		69.5 °		69.5 °	
B HEAD TUBE LENGTH	95.0 mm	3.7 in	100.0 mm	3.9 in	115.0 mm	4.5 in	125.0 mm	4.9 in
C TOP TUBE HORIZONTAL	575.0 mm	22.6 in	600.0 mm	23.6 in	625.0 mm	24.6 in	650.0 mm	25.6 in
D STANDOVER HEIGHT	743.0 mm	29.3 in	774.0 mm	30.5 in	800.0 mm	31.5 in	835.1 mm	32.9 in
E BB OFFSET	-58.0 mm	-2.3 in	-58.0 mm	-2.3 in	-58.0 mm	-2.3 in	-58.0 mm	-2.3 in
F BB HEIGHT	312.0 mm	12.3 in	312.0 mm	12.3 in	312.0 mm	12.3 in	312.0 mm	12.3 in
G WHEEL BASE	1,076.4 mm	42.4 in	1,101.8 mm	43.4 in	1,127.9 mm	44.4 in	1,153.7 mm	45.4 in
H BB CENTER TO TOP TUBE CENTER	325.0 mm	12.8 in	375.0 mm	14.8 in	415.0 mm	16.3 in	465.0 mm	18.3 in
I BB CENTER TO TOP OF SEATTUBE	390.0 mm	15.4 in	440.0 mm	17.3 in	480.0 mm	18.9 in	530.0 mm	20.9 in
J SEAT ANGLE	73.6 °		73.6 °		73.6 °		73.6 °	
K CHAINSTAY	425.0 mm	16.7 in	425.0 mm	16.7 in	425.0 mm	16.7 in	425.0 mm	16.7 in
L REACH	398.7 mm	15.7 in	422.3 mm	16.6 in	443.2 mm	17.4 in	465.5 mm	18.3 in
M STACK	599.0 mm	23.6 in	603.6 mm	23.8 in	617.7 mm	24.3 in	6271 mm	24.7 in
N STEM LENGTH	60.0 mm	2.4 in	70.0 mm	2.8 in	80.0 mm	3.1 in	90.0 mm	3.5 in
O TRAIL	83.9 mm	3.3 in	83.9 mm	3.3 in	83.9 mm	3.3 in	83.9 mm	3.3 in

### IMPORTANT!

SCOTT Scale 3 is designed around the BOOST platform so many of the fitted parts: cranks/wheels/dropouts/forks differ from traditional cycle parts. Always consult your authorized SCOTT dealer for advice on replacing or repairing any part of your SCOTT bike!

## RIDELOC

This section refers to SCOTT bikes fitted with the RIDELOC system. For all non-RIDELOC systems please refer to the specific fork manual for your setup.

The RIDELOC system offers the rider full control of all 3 modes of the front forks with a single lever, the position and function of the RIDELOC lever make for effortless control over the forks function.

The 3 basic functions of RIDELOC system are:

- **Climb-out Mode**
- **Traction Mode**
- **Descent Mode**

There are 3 positions of the RIDELOC remote lever.

1. **CLIMB MODE:** The fork is nearly locked; climbing on asphalt roads is now possible with little power loss. A simultaneous blow-off-system prevents the forks being damaged in case the rider does not open the system while crossing obstacles.
2. **TRACTION MODE:** Altering the dampening of the forks will result in climbing with reduced "bobbing" and still offers optimum control of the front wheel.
3. **DESCENT MODE:** Full travel of the fork.

You can only assemble the "standard" RIDELOC remote lever in "left side upward position" on the handlebar (this is usually fitted on bikes with x2 front chainrings).

On bikes with X1 chaining on the front the under bar RIDELOC remote lever in "left side downward" position can be fitted as standard.

It is possible to change the RIDELOC lever to the underbar option if the bikes gears have been changed to X1 system, a new alternative lever will be required for this adjustment; please consult your local SCOTT dealer for more information on obtaining the correct lever for your bike.

You will find the following positions on the remote lever:



## ▮ BASIC SET-UP OF FORKS

Recommended tools for the shock setup:

- The SAG tool that came with your bike. **\*Fox forks only**
- A shock pump with a special air valve connector (not supplied with this bike), this will help stop air from escaping while removing the pump from the shock valve.

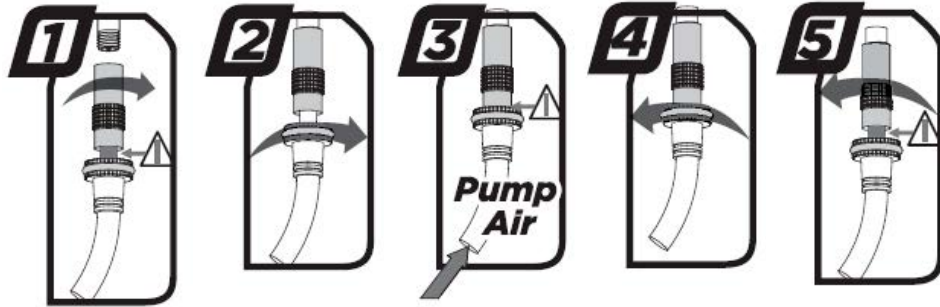

Please note that air will flow into the hose and indicator when counterchecking the air pressure, this will give the appearance that the shock has less air pressure than it was setup, your shock may need to be adjusted once this action is made.

Please also note that the indicators of shock pumps have a tolerance of max. 10%.

For bikes spec'd with Fox forks:

You can find more specific information about Fox set up on Fox's website, please use your fork ID number to find more useful setup tips for your exact fork (visit: [ridefox.com](http://ridefox.com))



## ▮ SAG

Your SCOTT bike will be supplied with a SAG tool to help set up your bikes suspension, these SAG tools can be easily clipped on the fork body and Fork dust seal.

For the best performance it is recommended you start with SAG of 15-20% for forks.

1. Make sure before any adjustment is made that your forks are in the "open" position.
2. With the fork pump attached to the fork valve, pump your desired pressure into the fork. Once the pressure is achieved slowly compress and decompress your fork through 25% of its travel 10 times. This will equalize the positive and negative air chambers and will change the pressure on the pump gauge, if needed add or reduce pressure and repeat.  
**Note the compression/decompression of the fork through the travel must also be done if the pressure is reduced!**
3. Once your desired pressure is reached slide the rubber O-ring on the fork leg against the dust seal, clip on your SAG tool if required.
4. Sit on your bike in your usual riding position (in your riding gear: if you carry a bag/ Hydration-system put it on,) don't "bounce" the suspension while doing this, use a wall or a friend for support if needed.
5. Get off the bike gently without bouncing and check the O-ring position on the fork stanchion, with the SAG adjuster clipped on. This makes it easy to see where your SAG is set. Example below.

### ⚠ IMPORTANT!

**Do not sit on your bike with the shock pump attached to the bike!**

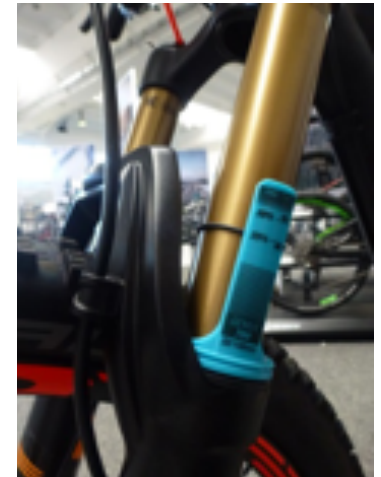

## REBOUND FORK SET-UP

“Rebound” describes the speed the fork returns back to its original length after absorbing an obstacle, setting of this is very important for the handling and correct function of the bike.

The rebound adjustment dial location may vary from fork to fork please consult the manual that came with this bike.

After the fork pressure/SAG is correctly set ride your bike in a safe area with your riding gear/backpack, etc. While remaining in the saddle, ride you bike off a drop/kerb of about 10-15 cm.

- If it bounces 1-2 times and settles the set-up is good.
- If it bounces more than 3 times the rebound is too fast, turn the knob 1-2 “clicks” clockwise and repeat.
- If there is no bounce the rebound is too slow, turn the knob 1-2 click counter clockwise and repeat.
- Repeat these steps until the desired result is achieved.

Your SCOTT Scale bike was designed to be used in conjunction with a specific forks, changing the forks on your bike may cause poor/unsafe riding characteristics or damage to frame and components, please consult your SCOTT dealer for any assistance you need, failure to do this may affect your warranty

This is the basic principle on setting your forks up, please always consult the fork owner’s manual for full instructions to familiarize yourself with the product.



\* Fox rebound adjuster shown

## REPLACEABLE REAR DROPOUT

On SCOTT Scale models for 2017 the rear derailleur hanger is replaceable, this hanger is available in two options depending on if your bike is equipped with a standard or direct mount rear derailleur.

### FOR CARBON SCOTT SCALE 3 FRAMES ONLY:



Sram and non-direct  
mount derailleur  
SCOTT part number 254090



Shimano direct  
mount derailleur  
SCOTT part number 254091

If your dropout needs to be replaced, we recommend this work should be carried out by your local SCOTT dealer as the rear derailleur may need adjustment, failure to adjust this correctly may result in accident or damage to your bike.

### IMPORTANT!

We recommend all work should be carried out by your authorised SCOTT dealer!

If you wish to change this item yourself, please ensure the bike is supported correctly to prevent damage by referring to the general manual instructions supplied with your bike.



Before installing the new hanger first make sure the area is clean; insert the hanger.



Insert the end cap through the frame and into the hanger.

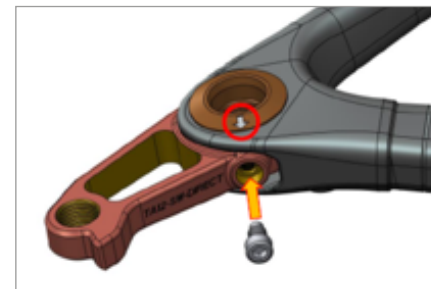

Make sure the location arrow is pointing to the lower bolt hole; insert the bolt (Max torque 1.5 N/M)



Insert the second bolt in the rear of the dropout (Max torque 1.5 N/M)

Once the bike is reassembled please insure the wheels are refitted correctly and the gears are set correctly including the over shift stops, please consult your authorized SCOTT dealer for assistance.



## ▮ CABLE GUIDES AND CABLING.

On the carbon SCOTT Scale the cable guides on the headtube can be changed if required so different cable configurations can be used, the inside of the cable guide is stamped with a number or numbers, these numbers dictate what cables can be used, these are the same for left and right.

The numbers indicate what cables fit the guide; the guide shown will hold 2 mechanical cables and one hydraulic.

They are available in the following combinations and are available from your SCOTT dealer.



4 = mechanical cable

5 = hydraulic cables

D12 = D12

Blank = no cable

### Combinations:

4,	4-5-5,
5,	4-4-5,
4-4,	D12,
4-5,	4-D12,
5-5,	5-D12,
	4-5-D12

These cable guides are fitted with a single bolt, the fixing torque of this must not exceed 0.75-1 N/M.

With the many different cabling options it is possible to customise the cable routing slightly depending what components you wish to run, it is recommended that handlebar cables that come from the right hand side enter the frame on the left, and handlebar cables that come from the left hand side enter the frame on the right, while this is not crucial to the performance of the bike it may help to prevent any cable rub

Below is an example of a bike set up “European style” with a 1X set up and a dropper seatpost.

**Please note that below is an example and that your bikes brakes need to be set up as per the law in your country, please check with your local SCOTT dealer for this information.**

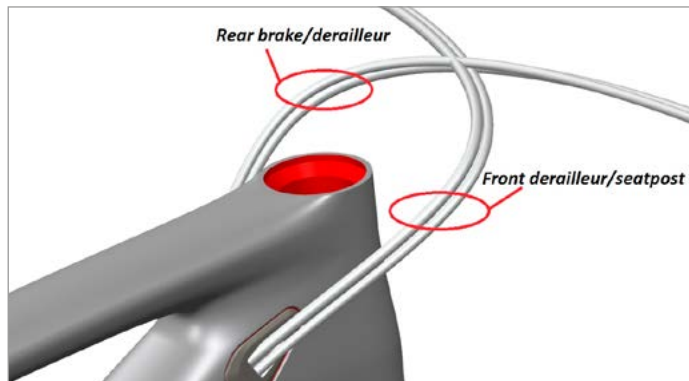

## ▮ BB STANDARDS/FD MOUNTING DETAILS

The SCOTT Scale has a Press fit PF92 bottom bracket with an inner diameter of 41mm, this is a press fit system and special tools are required for removal and refitting, please contact your SCOTT dealer for assistance.

The SCOTT Scale (non RC models) uses a high direct mount side swing front derailleur only, this must be used with the use of an FD adaptor plate.

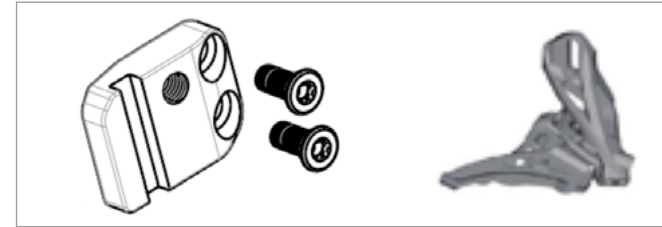

**It is not possible to mount a front derailleur to RC frames/bikes.**

## ▮ ADJUSTMENT

We recommend all adjustments are carried out by your local authorized SCOTT dealer but basic maintenance and checks should be done regularly before each ride as described in the general manual that was supplied with your bike.

Please pay attention to all instructions and torque settings, if you have any doubts please contact your dealer,

\*in addition to the torque settings please note all bikes with a dropper type seatpost have a seatpost clamp maximum torque of 5 N/M.

# SCOTT SCALE 2

## SCALE CONCEPT

Scale is the result of research and development based on the feedback from the SCOTT-ODLO Racing Team searching for one of the lightest cross country racing frames in the market.

SCOTT's focus was not only on creating a lightweight frame, but one that was also a stiff and easy to handle racing frame.

## GEOMETRY/TECHNICAL DATA SCALE

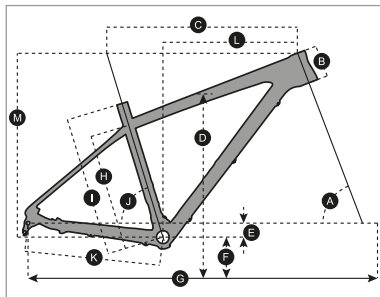

Seatpost diameter	Scale 700 / Plus: 31.6mm (27.5"), Scale 900: 34.9mm (29")
Seattube clamp	Scale 700 / Plus: 34.9mm (27.5"), Scale 900: 38.2mm (29")
Headtube diameter	1 1/8" / 1.5", tapered, cups semi-integrated, 50-61mm cup OD
Fork travel	Scale 700 / 900: 100mm, Scale Plus: 120mm
Technical fork length	Scale 700: 487mm (27.5"), Scale 900: 506mm (29"), Scale Plus: 520mm
BB housing	PF BB 92
Rear Hub Width	Scale 700 / 900: IDS SL2 135-5/135-12/142- 12mm, Scale Plus: Boost 148/12mm
Max tire width	Scale 700 / 900: 57.5mm/2.25", Scale Plus: 74mm/2.9"
Chaining size	Scale 700 / 900: min. 22T, max. 44T, Scale Plus: Max 34T (single)

## GEOMETRY/TECHNICAL DATA SCALE

### SCALE 700

	S	M	L	XL
A HEAD TUBE ANGLE	69.0 °	69.0 °	69.0 °	69.0 °
B HEAD TUBE LENGTH	100.0 mm 3.9 in	100.0 mm 3.9 in	115.0 mm 4.5 in	125.0 mm 4.9 in
C TOP TUBE HORIZONTAL	575.0 mm 22.6 in	600.0 mm 23.6 in	625.0 mm 24.6 in	650.0 mm 25.6 in
D STANDOVER HEIGHT	728.9 mm 28.7 in	758.0 mm 29.8 in	786.8 mm 31.0 in	819.7 mm 32.3 in
E BB OFFSET	-44.0 mm -1.7 in	-44.0 mm -1.7 in	-44.0 mm -1.7 in	-44.0 mm -1.7 in
F BB HEIGHT	307.5 mm 12.1 in	307.5 mm 12.1 in	307.5 mm 12.1 in	307.5 mm 12.1 in
G WHEEL BASE	1'075.2 mm 42.3 in	1'100.2 mm 43.3 in	1'126.3 mm 44.3 in	1'152.0 mm 45.4 in
H BB CENTER TO TOPTUBE CENTER	315.8 mm 12.4 in	369.3 mm 14.5 in	409.3 mm 16.1 in	458.2 mm 18.0 in
I BB CENTER TO TOP OF SEATTUBE	390.0 mm 15.4 in	440.0 mm 17.3 in	480.0 mm 18.9 in	530.0 mm 20.9 in
J SEAT ANGLE	73.0 °	73.0 °	73.0 °	73.0 °
K CHAINSTAY	427.0 mm 16.8 in	427.0 mm 16.8 in	427.0 mm 16.8 in	427.0 mm 16.8 in
L REACH	398.1 mm 15.7 in	423.1 mm 16.7 in	443.8 mm 17.5 in	466.0 mm 18.3 in
M STACK	578.6 mm 22.8 in	578.6 mm 22.8 in	592.6 mm 23.3 in	601.9 mm 23.7 in
N STEM LENGTH	70.0 mm 2.8 in	80.0 mm 3.1 in	90.0 mm 3.5 in	100.0 mm 3.9 in

### SCALE 900

	S	M	L	XL
A HEAD TUBE ANGLE	69.5 °	69.5 °	69.5 °	69.5 °
B HEAD TUBE LENGTH	105.0 mm 4.1 in	105.0 mm 4.1 in	115.0 mm 4.5 in	125.0 mm 4.9 in
C TOP TUBE HORIZONTAL	580.0 mm 22.8 in	600.0 mm 23.6 in	620.0 mm 24.4 in	640.0 mm 25.2 in
D STANDOVER HEIGHT	756.0 mm 29.8 in	783.0 mm 30.8 in	810.0 mm 31.9 in	842.0 mm 33.1 in
E BB OFFSET	-60.0 mm -2.4 in	-60.0 mm -2.4 in	-60.0 mm -2.4 in	-60.0 mm -2.4 in
F BB HEIGHT	310.0 mm 12.2 in	310.0 mm 12.2 in	310.0 mm 12.2 in	310.0 mm 12.2 in
G WHEEL BASE	1'079.0 mm 42.5 in	1'096.8 mm 43.2 in	1'117.0 mm 44.0 in	1'137.9 mm 44.8 in
H BB CENTER TO TOPTUBE CENTER	329.0 mm 13.0 in	375.0 mm 14.8 in	415.0 mm 16.3 in	465.0 mm 18.3 in
I BB CENTER TO TOP OF SEATTUBE	390.0 mm 15.4 in	440.0 mm 17.3 in	480.0 mm 18.9 in	530.0 mm 20.9 in
J SEAT ANGLE	72.5 °	72.5 °	72.5 °	72.5 °
K CHAINSTAY	438.0 mm 17.2 in	438.0 mm 17.2 in	438.0 mm 17.2 in	438.0 mm 17.2 in
L REACH	385.0 mm 15.2 in	405.0 mm 15.9 in	422.0 mm 16.6 in	439.0 mm 17.3 in
M STACK	618.0 mm 24.3 in	618.0 mm 24.3 in	628.0 mm 24.7 in	637.0 mm 25.1 in
N STEM LENGTH	70.0 mm 2.8 in	80.0 mm 3.1 in	90.0 mm 3.5 in	100.0 mm 3.9 in

### SCALE PLUS

	S	M	L	XL
A HEAD TUBE ANGLE	67.6 °	67.6 °	67.6 °	67.6 °
B HEAD TUBE LENGTH	100.0 mm 3.9 in	105.0 mm 4.1 in	115.0 mm 4.5 in	125.0 mm 4.9 in
C TOP TUBE HORIZONTAL	577.0 mm 22.7 in	602.0 mm 23.7 in	627.0 mm 24.7 in	652.0 mm 25.7 in
D STANDOVER HEIGHT	780.0 mm 30.7 in	806.0 mm 31.7 in	829.0 mm 32.6 in	857.0 mm 33.7 in
E BB OFFSET	-50.0 mm -2.0 in	-50.0 mm -2.0 in	-50.0 mm -2.0 in	-50.0 mm -2.0 in
F BB HEIGHT	315.0 mm 12.4 in	315.0 mm 12.4 in	315.0 mm 12.4 in	315.0 mm 12.4 in
G WHEEL BASE	1'108.0 mm 43.6 in	1'133.4 mm 44.6 in	1'159.3 mm 45.6 in	1'185.2 mm 46.7 in
H BB CENTER TO TOPTUBE CENTER	328.0 mm 12.9 in	383.0 mm 15.1 in	425.0 mm 16.7 in	477.0 mm 18.8 in
I BB CENTER TO TOP OF SEATTUBE	390.0 mm 15.4 in	440.0 mm 17.3 in	480.0 mm 18.9 in	530.0 mm 20.9 in
J SEAT ANGLE	72.8 °	72.8 °	72.8 °	72.8 °
K CHAINSTAY	439.0 mm 17.3 in	439.0 mm 17.3 in	439.0 mm 17.3 in	439.0 mm 17.3 in
L REACH	389.0 mm 15.3 in	412.0 mm 16.2 in	435.0 mm 17.1 in	457.0 mm 18.0 in
M STACK	607.0 mm 23.9 in	612.0 mm 24.1 in	621.0 mm 24.4 in	631.0 mm 24.8 in
N STEM LENGTH	50.0 mm 2.0 in	60.0 mm 2.4 in	70.0 mm 2.8 in	80.0 mm 3.1 in



## BB STANDARDS/FD MOUNTING DETAILS

Scale is available for PressFit 92 Cartridges (PF92).

PF BB 92 has a housing width of 92mm (Scale 700) or 89.5mm plus a 2.5mm additional washer (Scale 900, Scale Plus) with an inner diameter for the cartridges of 41mm.



Scale 700 (27.05") FD

The front derailleur (FD) fixation for Scale 700 is a direct mount system.

It is made for Shimano E-Type derailleurs or SRAM S3 assembly.

For Scale Plus the FD fixation is E-Type with 3mm outboard to match with rear hub boost standard.

In addition it has an integrated chainguide assembled on this fixation plate.



Scale 900 (29") FD

The Front Derailleur (FD) clamp is with an inner diameter of 34.9mm, the cable routing on the frame is for "down route/pull - down swing" models.

### ⚠ IMPORTANT!

Please note that the maximum tightening torque on the FD clamp is 5Nm/44in/lbs.

A higher tightening torque might cause damage to the FD camp and/or frame tube!  
Please also refer to the related manuals of the manufacturer of the FD.

## CHAINGUIDE

On some Scale 900 (29") Carbon models you will find a chainguide system to support the shifting performance when using 2 chaining cranksets.

3 different mounting plates are available to match the different sizes of the outer chainrings (39/42/44T).

Please note the max. tightening torque of 5Nm/44 in/lbs on the mounting screw of the plate.

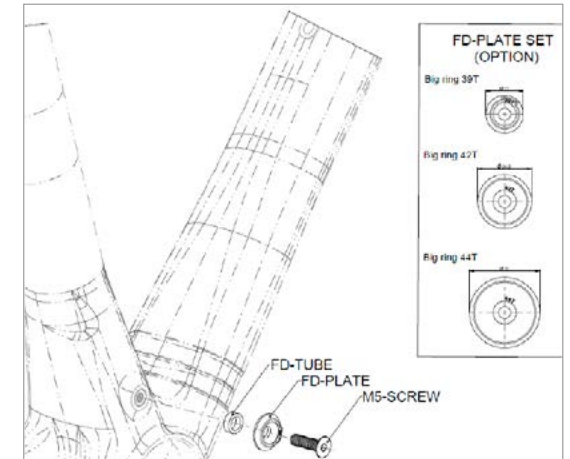

## HEADSET OPTIONS

Scale features a tapered headset and fork steerer system to match with semi-integrated headsets of the "50-61"mm range.

The steerers of those forks are tapered from 1.5" to 11/8".

This bigger diameter of the fork steerer as well as on the frame headtube helps to increase the stiffness and handling of the bike.

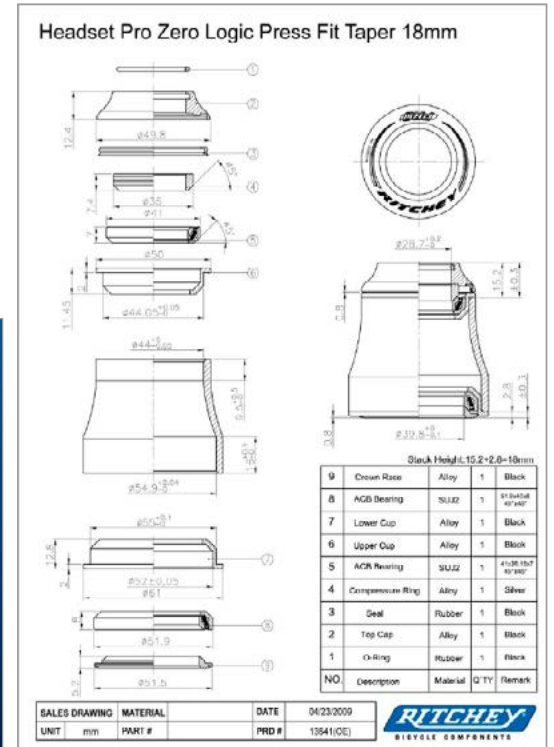

Ritchey WCS Carbon Zero Tapered	PF 50-61mm	18mm UD	PRD 13636
Ritchey PRO Tapered	PF 50-61mm	12.9mm	PRD 13640

It is also possible to use forks with a standard 1 1/8" steerer tube when using a reducer headset such as e.g.

Ritchey WCS Carbon Zero Tapered	PF 50-61mm	18mm UD for 1 1/8" fork	PRD 14860
---------------------------------	------------	-------------------------	-----------

## ▮ BB CABLE GUIDE/CABLE ROUTING

Scale features also an internal cable routing for front and rear derailleur.

A special BB Cable Guide was developed for Scale which is available as a spare part at the SCOTT distribution with article number

for Scale 700

235285	Cableguide BB Scale 700 2014
--------	------------------------------

and for Scale 900

219579	Cableguide BB Scale
--------	---------------------

Please note that those 2 cableguides are not interchangeable between the frame sizes.

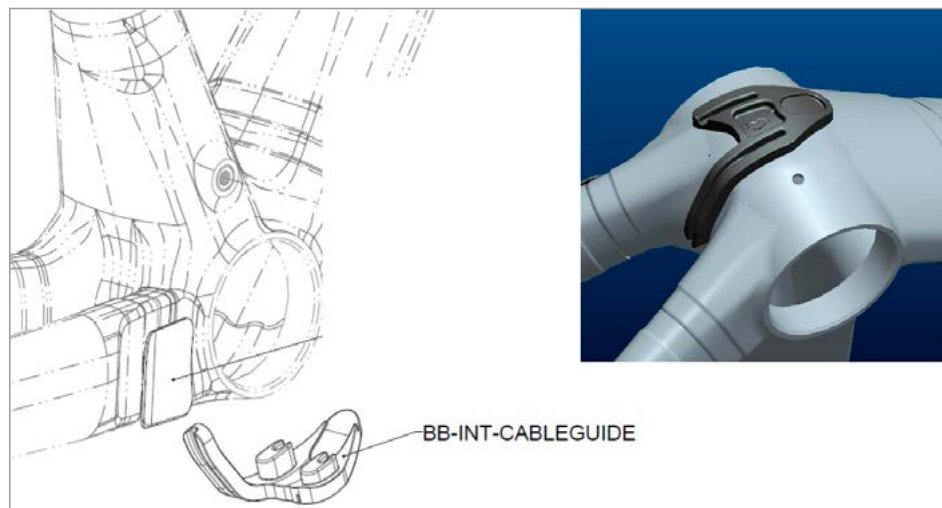

Please note that the outer housing of the FD and RD cables will stop at the cable stop/port on the front end of the down tube.

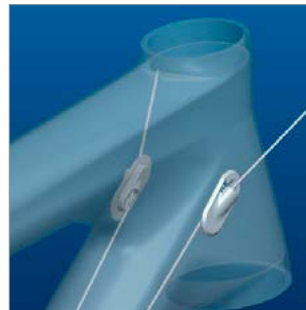

If you want to replace the cables, please follow these steps:

1. Remove the clip-in BB Guide in the BB housing
2. Push the inner cables from the front downward inside the downtube to the BB housing.
3. Pull them out of the related holes (RD on right side, FD on left side) on the BB housing.

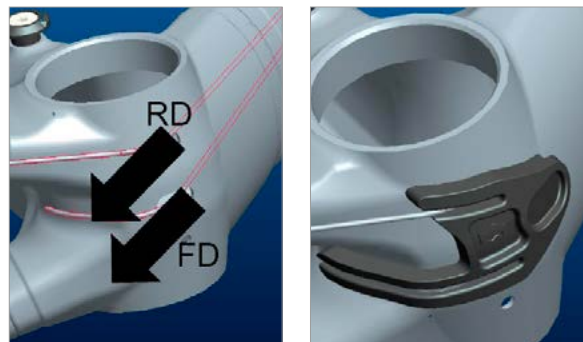

4. Push them through the related holes on the BB Guide and clip the BB Guide into the BB housing
5. Follow the standard set up and assembly instructions of the shifting system manufacturer for final adjustment of the shifting system

## SEATTUBE CLAMP

Please make sure to only use a seatclamp with an inner diameter of 34.9mm (Scale 700 / Plus) or 38.2mm (Scale 900) and please note the maximum tightening torque on the fixing bolt of 5Nm/44 in/lbs

## REPLACEABLE REAR DERAILLEUR HANGER

Scale uses the same replaceable rear derailleur hanger system (called IDS SL2) as SCOTT Spark, Genius and Genius LT.

Depending on the different models you'll find following options:

1. 142mm axle with RWS 142/12

This is available via the SCOTT distribution with:

219574	complete set of RWS 142/12
219577	right side replaceable RD hanger

2. 135mm axle with RWS 135/5

This is available via the SCOTT distribution with:

219572	complete set of RWS 135/5
219575	right side replaceable RD hanger

If you want to use another RWS standard SCOTT can also offer the following as after-market parts for specific wheelsets via the SCOTT distribution:

219574	RWS 135/12 parts set
219576	right side replaceable RD hanger

## REAR DISC BRAKE MOUNT

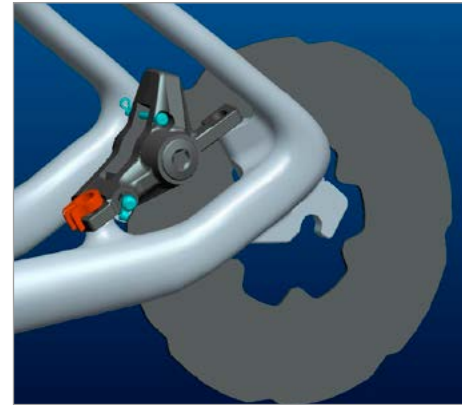

The rear disc brake on Scale is Postmount (PM) Standard on the left chainstay and optimized for 160mm/6" rotors, so the calliper can be mounted directly without adapters on the Postmount fixation.

Please note Scale is designed for disc rotors between 160mm/6" and 185mm/7" (adapter needed from manufacturer of the brake) only.

## FRONT FORK SET-UP/CHANGE OF FRONT FORK

For the set up of the front fork please use the fork specific manual attached to the bike.

We recommend using front forks with distance of

487mm/19.2" for Scale 700,

506mm/19.9" for Scale 900,

520mm/20.5" for Scale Plus

between mid of axle to top of crown, as this will not influence the geometry and alter handling of the bike.

# GUARANTEE ON SCOTT BIKES

## **⚠ WARNING!**

**SCOTT Sports SA is not responsible or liable for any injury caused by any missing compliance with these instructions, particularly but not limited to misuse, incorrect maintenance, incorrect set-up and handling, neglect or abuse. Failure to follow these instructions can result in component failure, serious personal injury. Component failure can lead to loss of control of the bicycle and result in serious personal injury.**

### **What is Covered?**

This warranty covers defects in materials and workmanship at the time of transfer of risks in frames, swingarms and forks (provided it is a fork of SCOTT) on SCOTT branded bikes sold completely assembled by SCOTT or an authorized SCOTT dealer ("Product").

### **How long does coverage last?**

This voluntary manufacturer's warranty is limited to five years for frames and swingarms, respectively two years for forks, from the date of purchase of the Product and is limited to the first purchaser of the Product and subject to the prior registration of your SCOTT bike on [www.scott-sports.com](http://www.scott-sports.com) within 10 days as of the date of purchase. Transfer of the Product from the first purchaser to another person terminates this limited warranty. The limited warranty of five years for the frames and swingarms shall only be granted in case once a year a maintenance service has been effected according to maintenance requirements as set forth in the manual. The effected annual maintenance service shall be confirmed by stamp and signature. In case such an annual maintenance service has not been effected the warranty of five years for the frame shall be reduced to three years. Costs for maintenance and service have to be borne by the owner of the Product.

On Gambler, Voltage FR and Volt-X the warranty period is limited to two years.

Repaired or replaced Products are covered for the remainder of the original warranty period and subject to the conditions outlined in the original warranty, to the extent permitted by law.

Hereby SCOTT grants a worldwide voluntarily manufacturer's warranty. To the extent permitted by law and unless a shorter duration is stipulated by law, any warranties implied by law are limited in duration to maximum five, respectively two years, from the date of purchase of the Product and are limited to the first purchaser of the Product.

### **What will SCOTT do in the event of a guarantee case?**

SCOTT will replace the defective product with a product of a quality or nature and similar level, will repair or refund the purchase price (after presentation of the proof of purchase of the product), at its sole discretion. Non-defective components are replaced at your expense. In such a case, we will contact you before replacing the non-defective part for your agreement.

### **What does this limited warranty not cover?**

This limited warranty does not cover defects which did not exist before the transfer of risks. This limited warranty does not cover Products used in rental operations. This limited warranty does not cover purchases of not completely assembled bikes. This limited warranty does not cover any defect caused by "wear and tear" (a complete list of all parts of "wear and tear" can be found in the general manual that came with your bike), accident, neglect, improper handling, colour fade due to exposure to sunlight, abuse, misuse, an act of God, improper assembly, non-compliance with recommended maintenance and care procedures,

improper or incorrectly performed maintenance or repairs performed by someone other than an authorized SCOTT dealer, use of parts or devices not consistent with the Product, and alteration of the Product.

All Products come with a manual; please carefully follow the instructions located there or affixed elsewhere to the Product. To the extent permitted by law, consequential and incidental damages are not recoverable under this limited warranty.

### **How do you make a claim under this limited warranty?**

To make a claim under this limited warranty, you must notify SCOTT of the claimed defect within the warranty period and timely return the Product to SCOTT at your expense for inspection. Please contact your authorized SCOTT dealer, call SCOTT's customer service or the national SCOTT distributor (dealer locator: [www.scott-sports.com](http://www.scott-sports.com)). All returned Products must be accompanied by proof of purchase (receipt) from an authorized SCOTT dealer or this limited warranty will not apply. In case of replacement or refund, returned Product becomes the property of SCOTT.

A protocol for the handing over of the Product (which you will find at the end of the manual) will remain in copy at the SCOTT dealer after acceptance and signature of the consumer. It is obligatory to show this protocol of handing over together with the defective part in case of a warranty claim given that it provides evidence of purchase or this limited warranty will not apply.

### **How do state laws affect your rights under this limited warranty?**

This limited warranty gives you specific legal rights, and you may also have other rights, which vary from state to state.

### **Recommendation**

We strongly recommend that you use only authorized SCOTT dealers for yearly maintenance services and for repairs, as improper or incorrectly performed maintenance or repairs voids this limited warranty. Costs for maintenance service have to be borne by the consumer.

 <b>SCOTT</b> Bike Warranty Periods	Year 1	Year 2	Year 3	Year 4	Year 5
SCOTT Bikes					
Gambler, Voltage FR, Volt-X					
Regular Warranty Period					
Option for prolongation according to maintenance intervals shown in manuals attached to bikes					