

Assembly Instructions

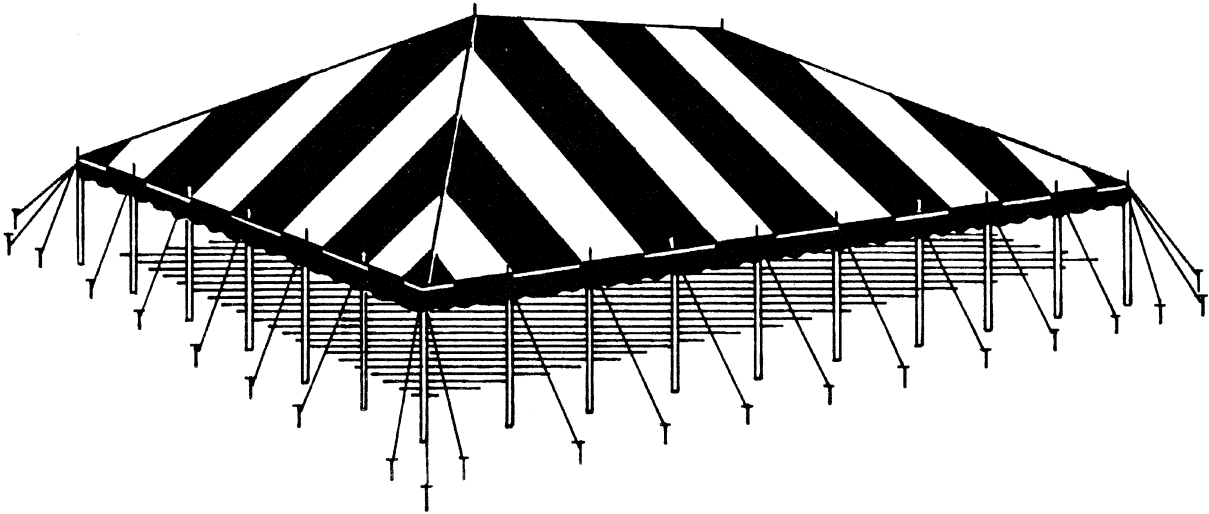

Party® Tents and Party® Mate 12' through 60' Wide Systems With Expandable Middle Sections



SALES OFFICES:
1100 BURCH DR.
P.O. BOX 3477
EVANSVILLE, IN 47733 USA

PHONE 812-867-2421
FAX 812-867-0547
1-800-544-4445

PRODUCTION FACILITIES:
BRADENTON, FL
EVANSVILLE, IN

Quality, Craftsmanship and Service since 1892

PART-396
Copyright © Anchor Ind.

PARTY® TENT PARTS LIST

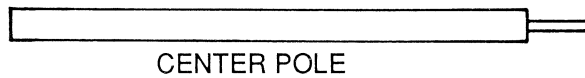

CENTER POLE

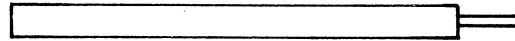

QUARTER POLE
(when applicable)

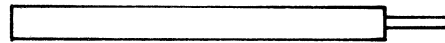

SIDE POLE

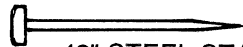

42" STEEL STAKES

MANPOWER REQUIRED

Two experienced installers should be able to assemble up to a 30' wide tent, three for a 40' wide tent, and four for 50' & 60' wide tents.

TOOLS REQUIRED

Sledge Hammers/
Stake Driver
2 Measuring Tapes

INSPECT SITE

CAUTION:

Consult local utility company prior to installation.

Prior to actual tent assembly, be sure to look up, down, above & below for obstacles, pipes, wires, trouble, etc.

LAYOUT & CHECK

Utilize parts list for a quick I.D. and a check list to ensure that you have all the parts.

QUANTITIES FOR PARTY® TENTS & PARTY MATE

TENT SIZE	PITCH	SIDE POLES	QUARTER POLES	CENTER POLES	STAKES
12 x 12 SQ. END - 1 PC	3' 6"	8	0	1	12
14 x 14 SQ. END - 1 PC	4' 0"	8	0	1	12
14 X 20 SQ. END - 1 PC	4' 0"	10	0	2	14
16 x 16 SQ. END - 1 PC	4' 6"	8	0	1	12
20 x 20 RD. END - 2 PC	6' 0"	8	0	1	12
20 x 20 SQ. END - 2 PC	6' 0"	8	0	1	12
20 x 10 MID SECTION	6' 0"	2	0	1	2
20 x 20 MID SECTION	6' 0"	4	0	2	4
30 x 30 RD. END - 2 PC	9' 0"	14	0	1 (A)	18
30 x 30 SQ. END - 2 PC	9' 0"	16	0	1 (A)	20
30 x 15 MID SECTION	9' 0"	4	0	1 (A)	4
30 x 20 MID SECTION	9' 0"	6	0	1 (A)	6
30 x 30 MID SECTION	9' 0"	8	0	2 (A)	8
40 x 40 RD. END - 2 PC	11' 0"	18	0	1 (A)	22
40 x 40 SQ. END - 2 PC	11' 0"	24	0	1 (A)	32
40 x 20 MID SECTION	11' 0"	6	0	1 (A)	6
50 x 50 RD. END - 2 PC	13' 0"	22	6	1 (A)	26
50 x 50 SQ. END - 2 PC	13' 0"	32	8	1 (a)	40
50 x 25 MID SECTION	13' 0"	8	2	1 (A)	8
50 x 30 MID SECTION	13' 0"	8	4	2 (A)	8
60 x 60 RD. END - 2 PC	17' 0"	26	6	1 (A)	30
60 x 60 SQ. END - 2 PC	17' 0"	32	8	1 (A)	40
60 x 20 MID SECTION	17' 0"	6	2	1 (A)	6
60 x 30 MID SECTION	17' 0"	8	4	1 (A)	8

(A) = Aluminum Center Poles, otherwise wood is furnished

1

MEASURE LAYOUT

Mark locations of stakes, side poles and center poles.

40' x 60' tent used as example. For other sizes, refer to tent sections for pole spacing.

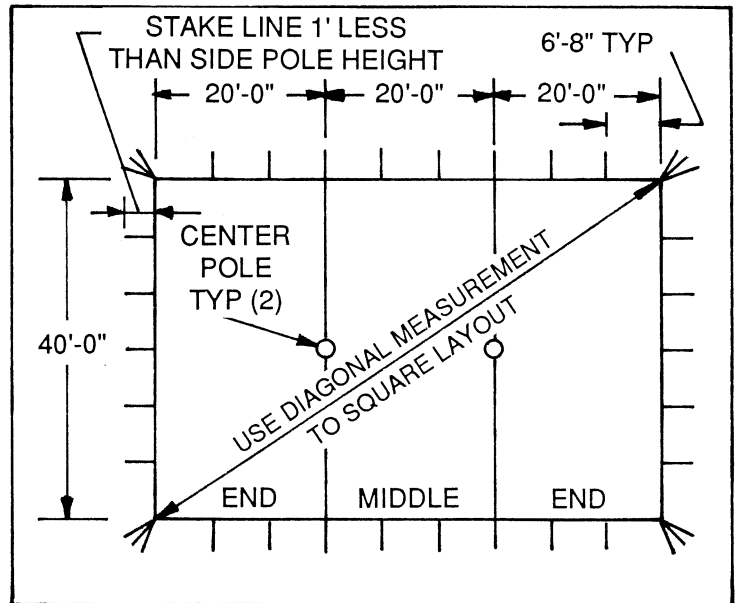
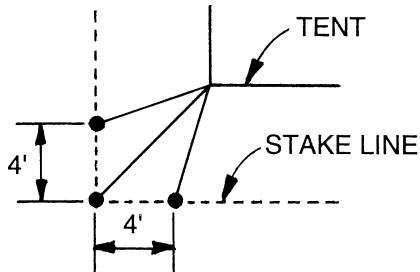

2

LAYOUT AT SITE

Drive stakes vertically at points located.

Spread drop cloths and unroll tent.

Any objects with sharp projections which must remain on site under the tent should be padded and taped.

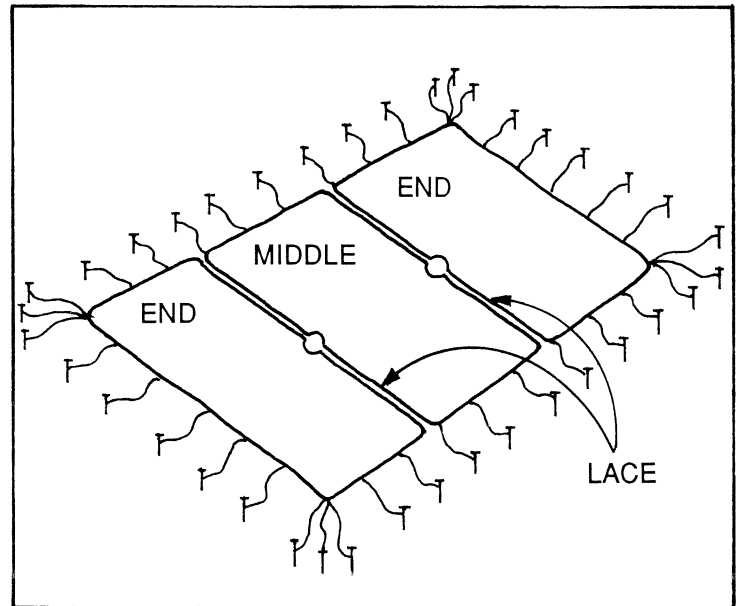

3

LACING INSTRUCTIONS

With tent sections on ground, overlap center pole hole with grommet side on top. Starting at ridge, push first loop through corresponding grommet.

Continue lacing process and cover lacing with protective flap and snap to rings or rope as you move down tent section.

NOTE: One piece tops do not require lacing.

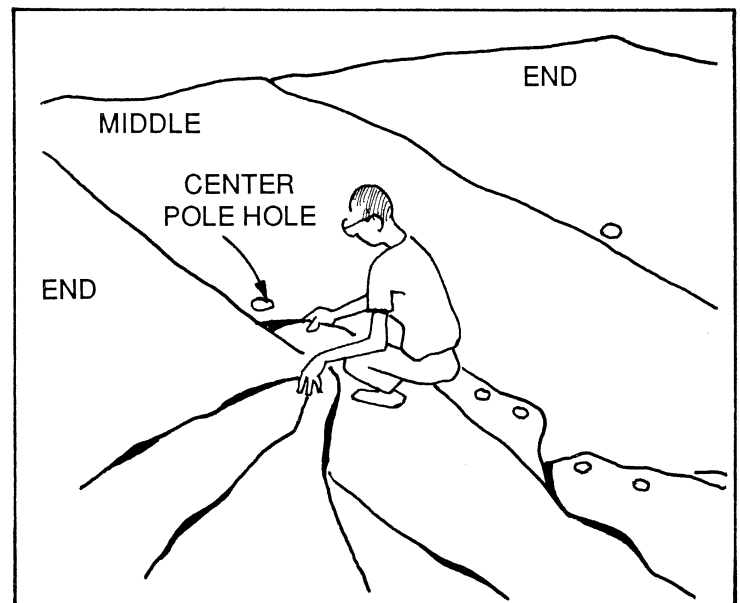

3

CONT'D

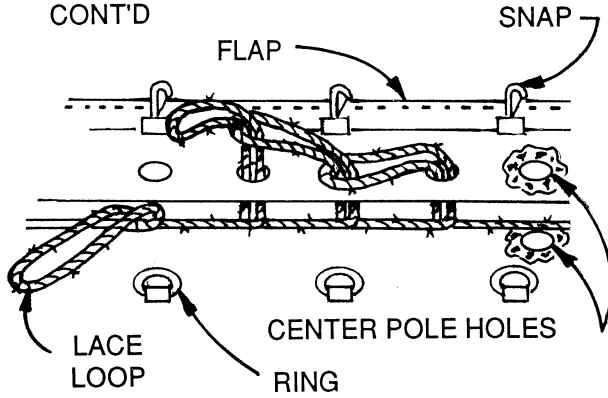

Tie off the last long lacing loop.

Attach snap to ring at eave. Repeat lacing steps on opposite side.

Note: Loops lace up on one side and down on opposite side.

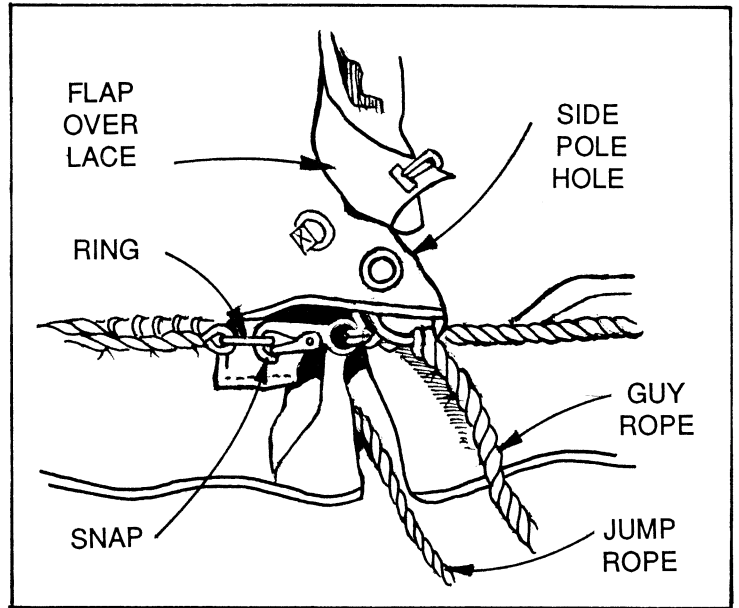

4

TIE DOWN AFTER LACING

After lacing and snapping sections, tie-off guys loosely about 2' from the end of each guy rope.

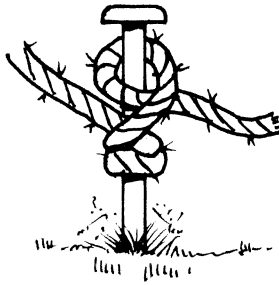

Half hitch knot for quick tie down and easy adjustment on stakes.

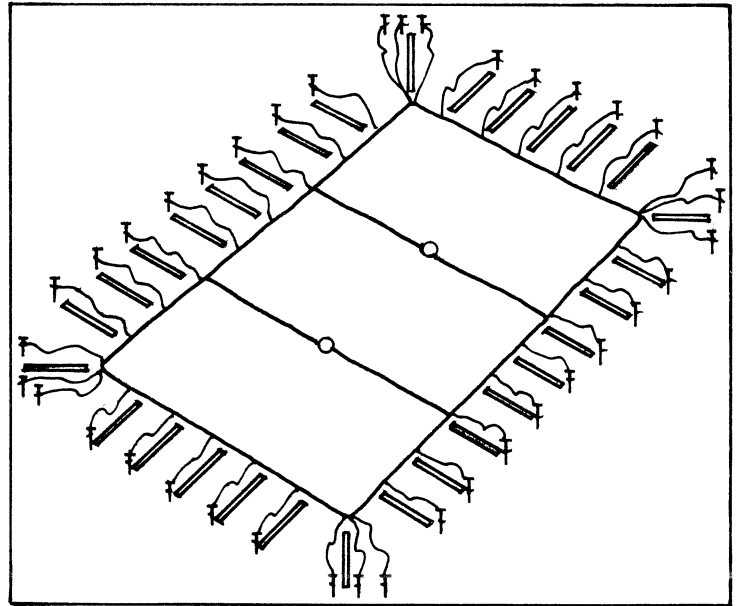

5

RAISE SIDE POLES

Start at side opposite wind. Insert each side pole pin into side pole hole and raise slightly less than perpendicular. Bottom of each pole should be pointed inward toward center of tent.

Wall ropes are to be outside of corner and side posts.

Tie jump rope around each side pole as it is inserted in pole hole.

Continue around tent.

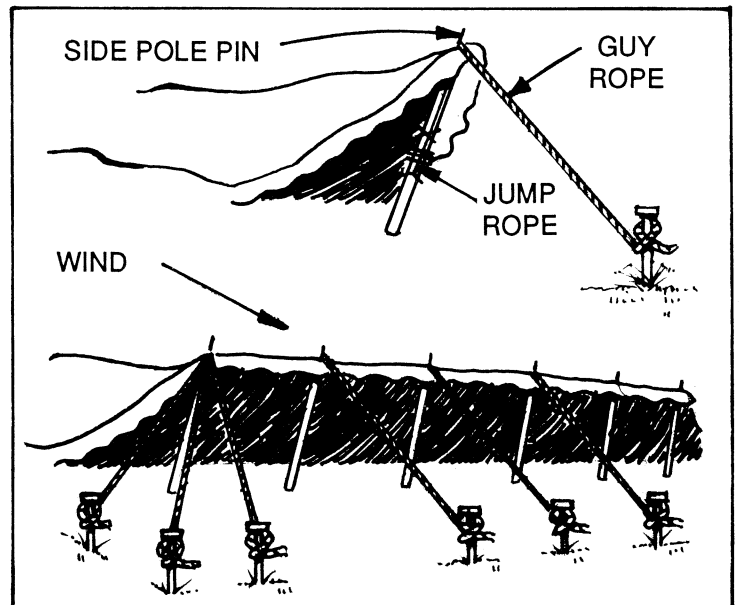

6

RAISE QUARTER AND CENTER POLES

Note: Quarter Poles for Large Tents are raised BEFORE Center Poles.

QUARTER poles will be approximately 2'-0" less than perpendicular with base of pole set in toward center of tent.

Raise poles nearest to wind direction to approximate position. One installer to guide center pole pin through hole to prevent snagging or tearing of fabric as pole is being raised to position. Tie jump ropes after all center poles are in approximate position. Adjust poles to exact location.

CAUTION: At this point, it is required to properly anchor bases of all center and quarter poles to prevent movement.

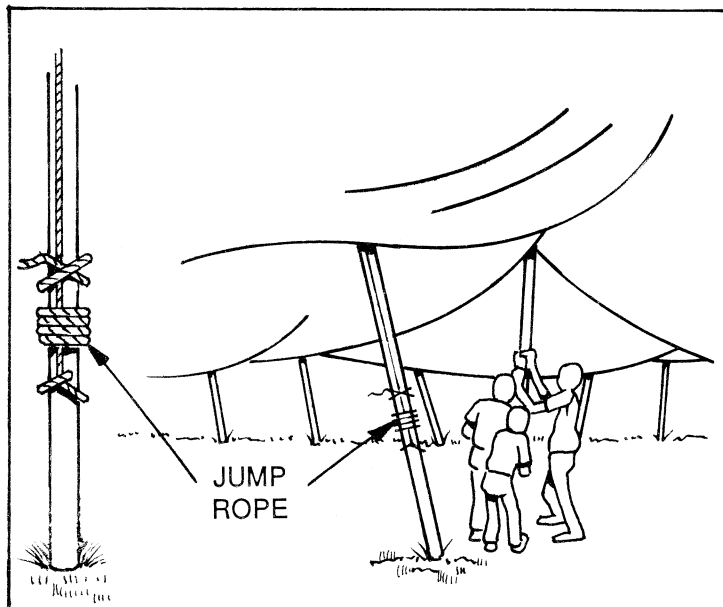

7

FINAL SIDE POLE ADJUSTMENT

Adjust side poles to exact position with taut guy ropes starting with corner pole.

Tighten ropes while pole is on angle then set pole into vertical position. Due to changes in climatic conditions, periodic inspection and adjustment should be made.

Protective covers recommended for all stakes.

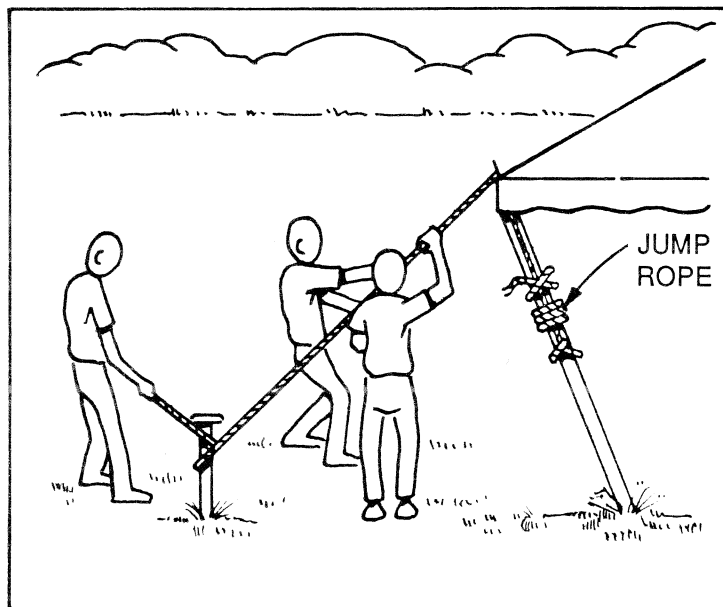

8

TAKE DOWN USE EXTREME CAUTION REMOVING ALL POLES

1. Spread ground cover.
2. Slant side poles inward.
3. Remove center and side poles.
4. Reverse installation steps.

IMPORTANT:

Check Guy Ropes periodically for tightness and maintaining of good condition. Stakes provided are for average soil conditions. Sandy soil or asphalt may require additional staking. Proper installation suitable to site conditions is the responsibility of the installer. Store tent in a cool, dry area. Never store while wet or damp.



Thank you for purchasing an Anchor product. In return, we pledge quality, service and craftsmanship and are available for any questions you may have or assistance you may need.

Phone Number
812 /867-2421

Fax Number
812 /867-0547

Anchor products are of superior design and operate best within the parameters of these instructions. It is imperative that the instructions be carefully read and completely followed.

Caution:

1. For each installation, the installer is solely responsible for evaluating the site and the proper securing method determined. Some soils require different staking or securing than that provided with the tent. Due to this variety of soil conditions, these are the manufacturer's suggested sequence of installation procedures. Anchor's responsibility is limited to the construction of the tent. We are not responsible for methods that installers may choose to secure the tent to the ground.
2. Inasmuch as the weather is unpredictable, good judgment and common sense must be incorporated within installation guidelines. It is the responsibility of the tent installer/maintainer to determine the severity of the weather, proper time and method of installation and/or erection and disassembly. This product has been manufactured for use as a temporary structure. For the safety of all occupants, evacuation is recommended if threatening weather occurs, or if there is any doubt concerning the safe use of this product.
3. Proper safety equipment should be used at all times to ensure a safe installation and take down. We suggest a careful evaluation be made to determine safety equipment needed, such as hard hats, steel toe shoes, safety glasses and other as required.
4. Disclaimer - Anchor Industries disclaims and excludes all express or implied warranties of merchantability and fitness for a particular purpose. The product is sold "as is" and no warranty shall apply. The user shall determine the suitability of the product for the intended use and assumes all risk and liability. Anchor Industries shall not be liable in tort or in contract for any loss or damage, direct, incidental or consequential arising out of the use of or the inability to use the product.