

1a

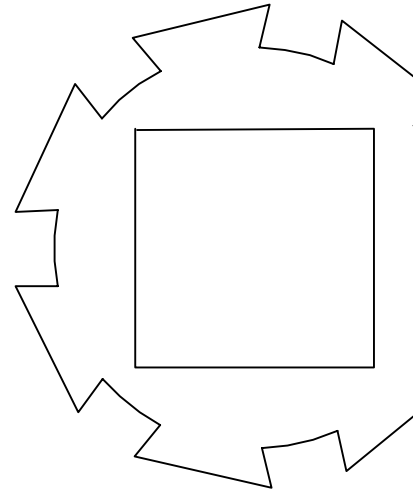

& B

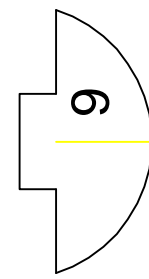
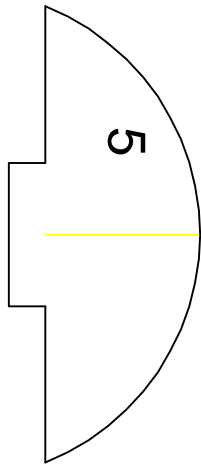
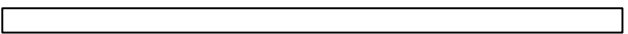

3.25

C

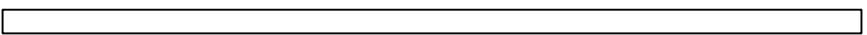

4.5

D

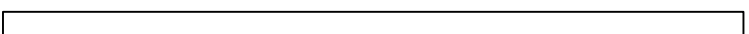

3.88

E

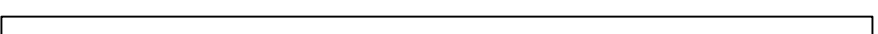

4.56

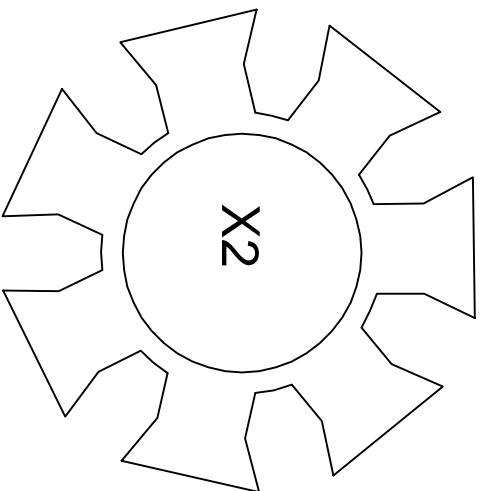

Radial Engine

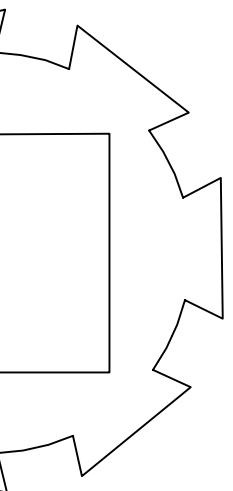

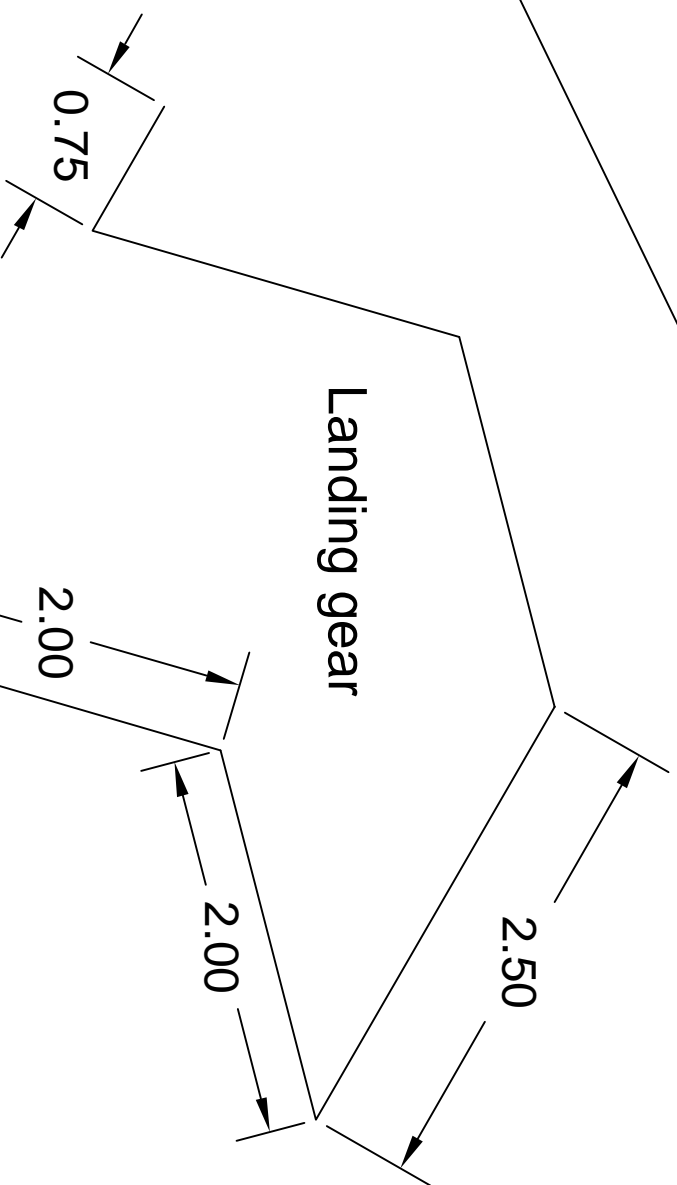
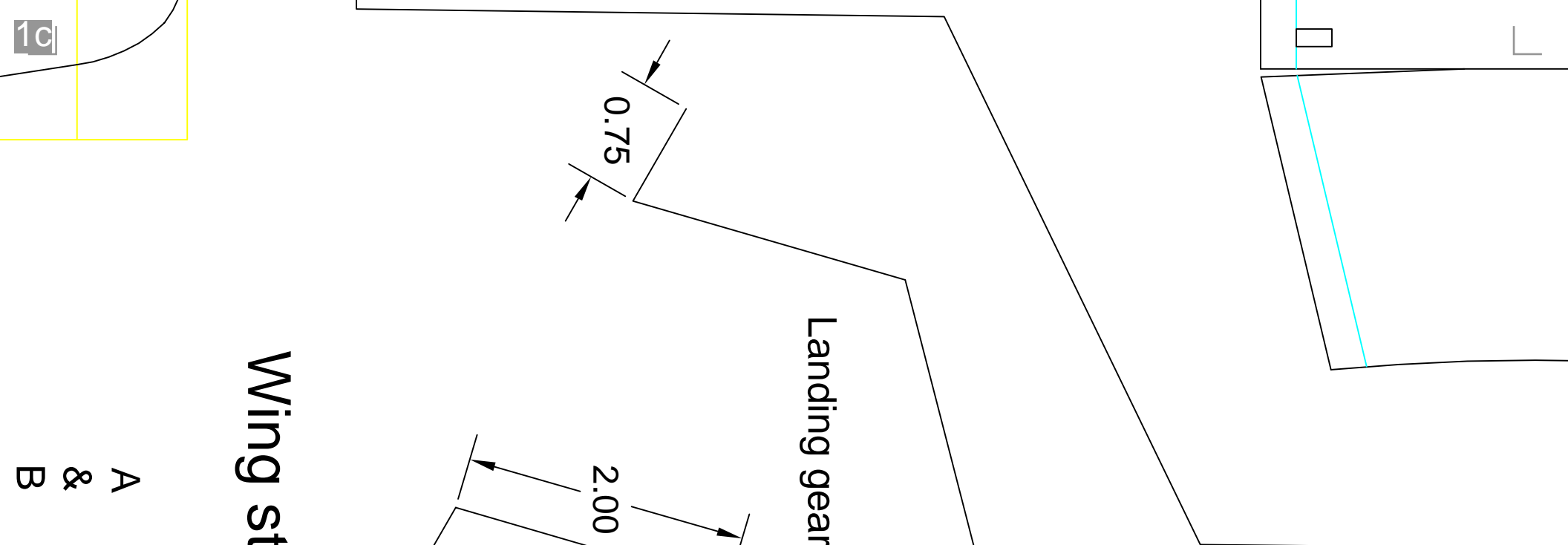

**Wing struts (2 each)**

- A
- B &
- C
- D
- E

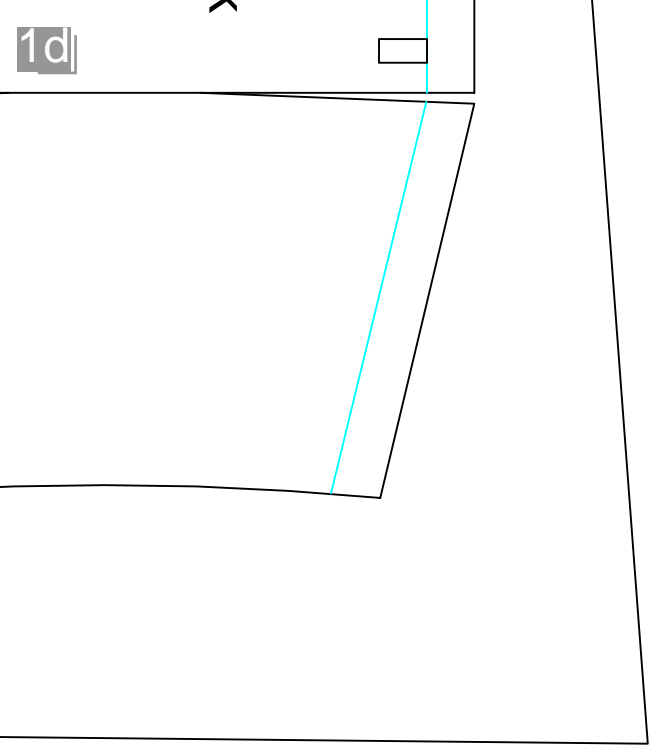

2a

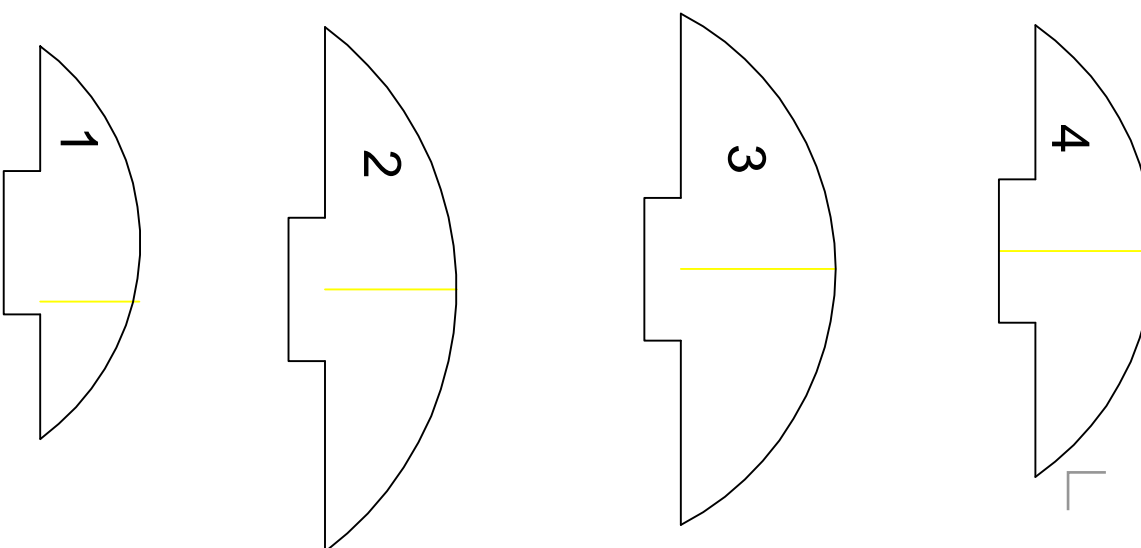
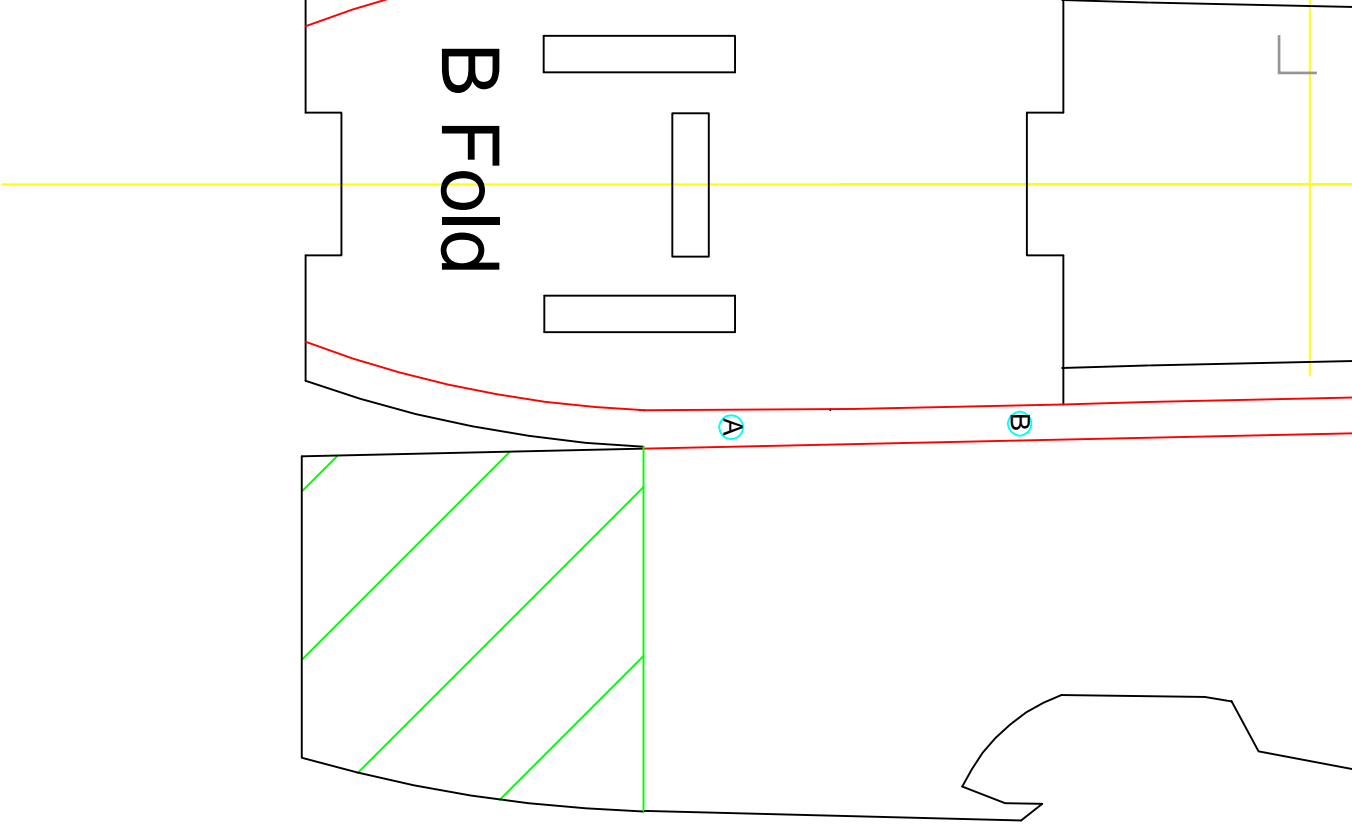

2b

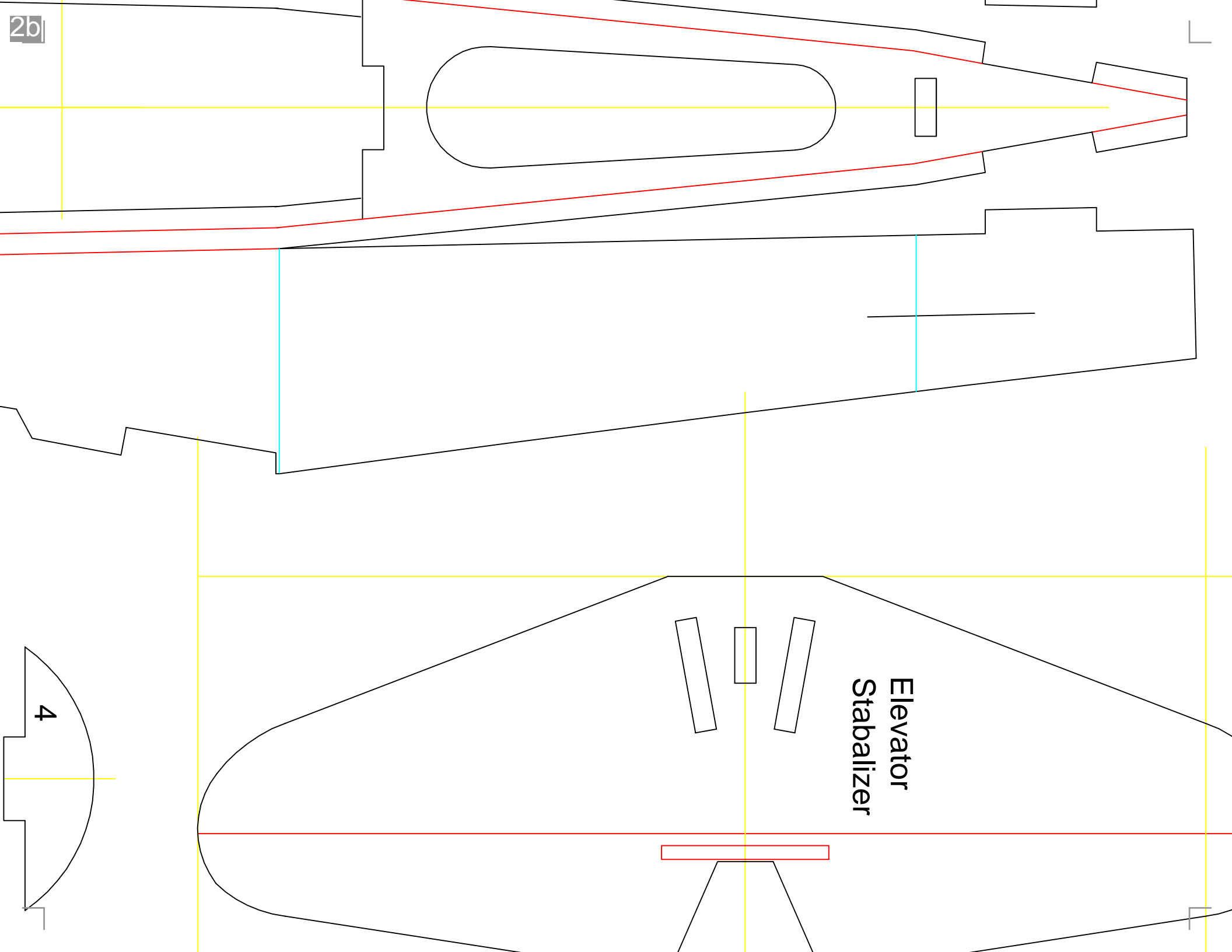

Elevator  
Stabalizer

4

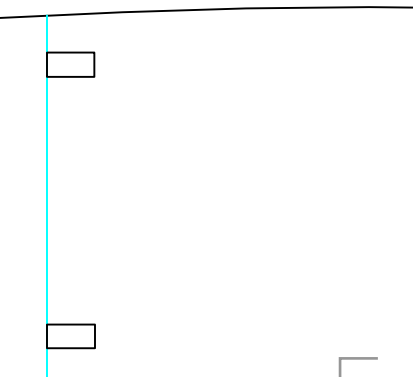
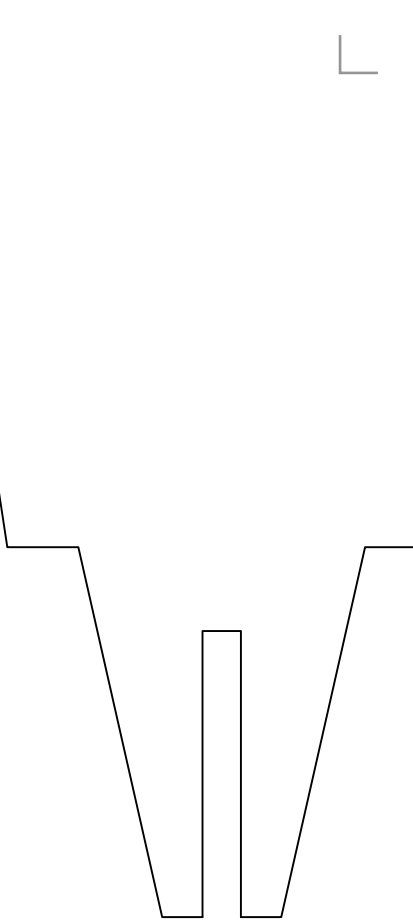

# osterboard

Windshield

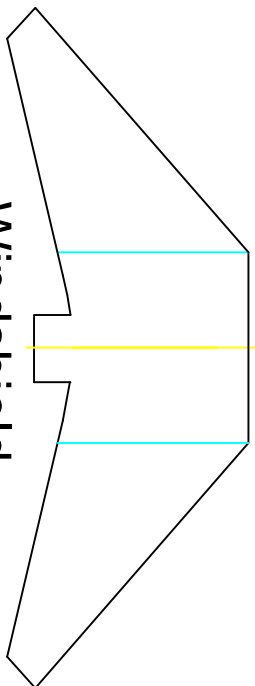

n rear Fuselage

Landing gear cover x2

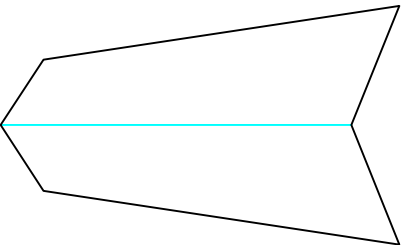

2c

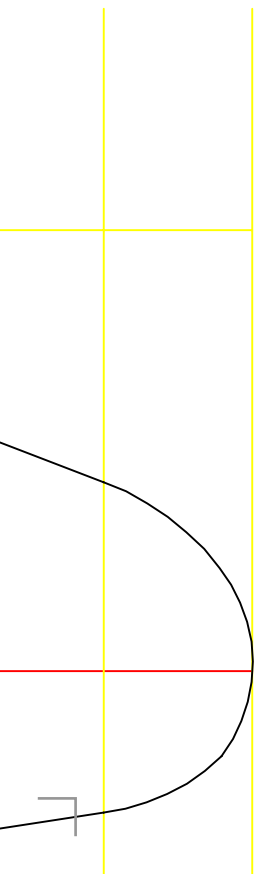
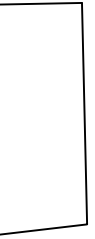
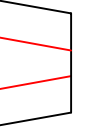



eck

2d

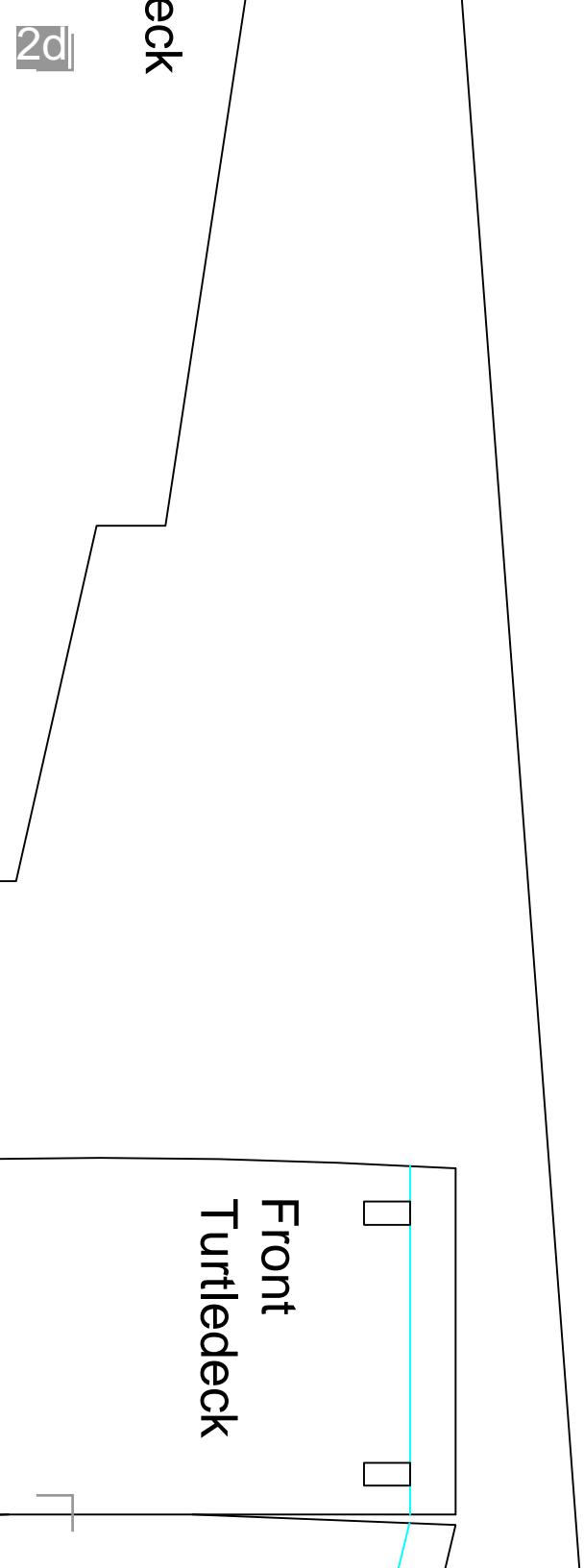

Front  
Turtledeck



Wing gauge

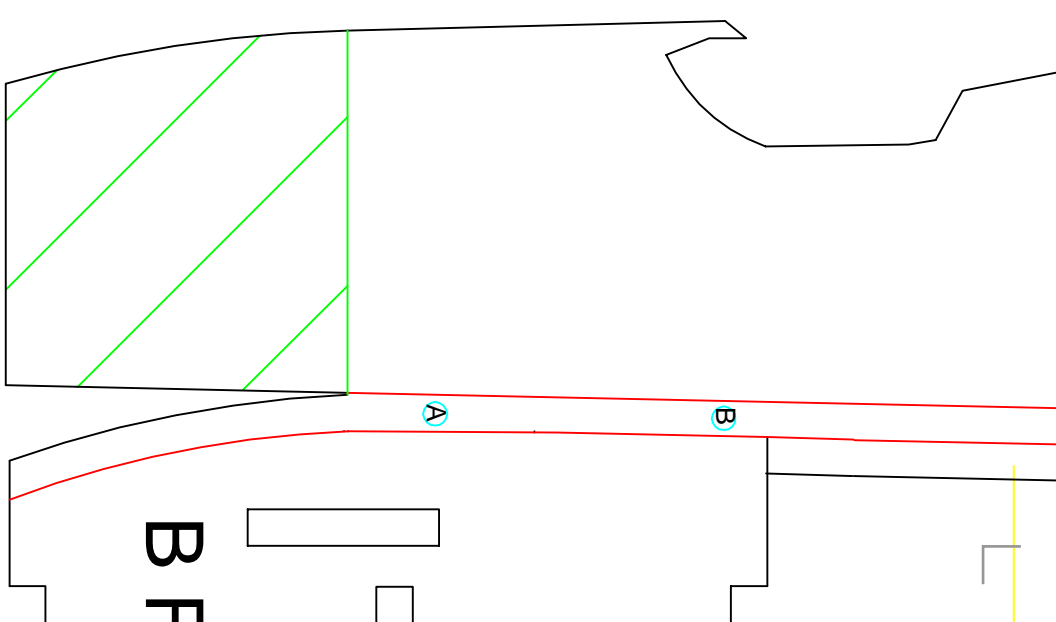
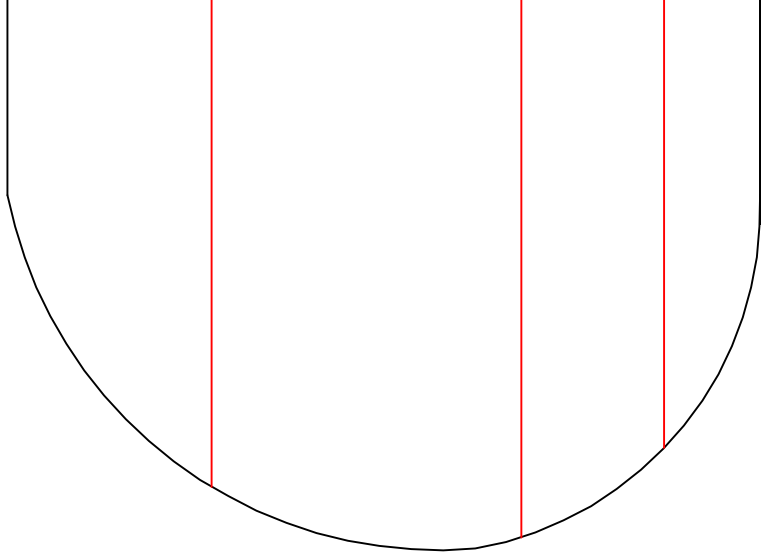

B F

3a

3b

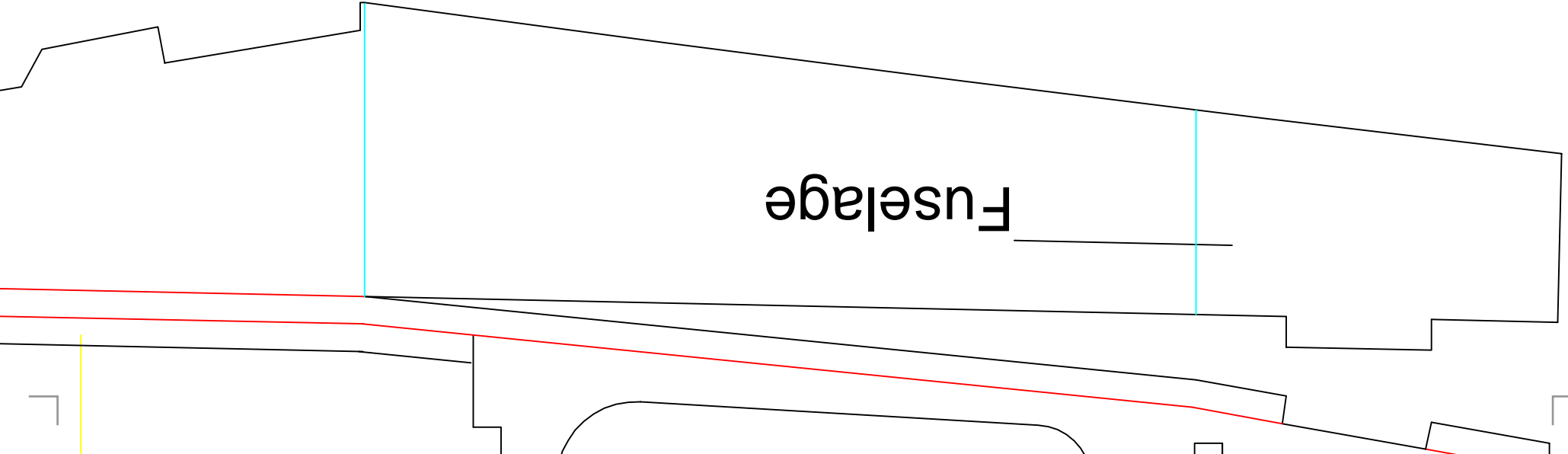
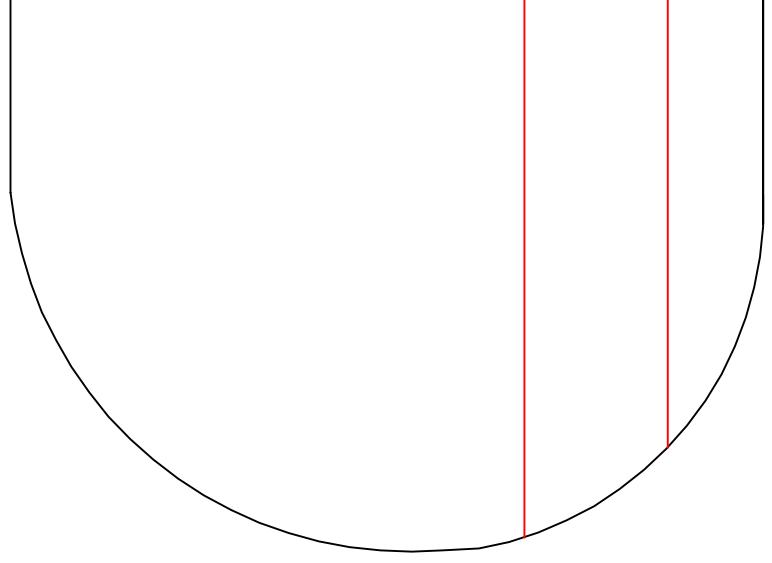
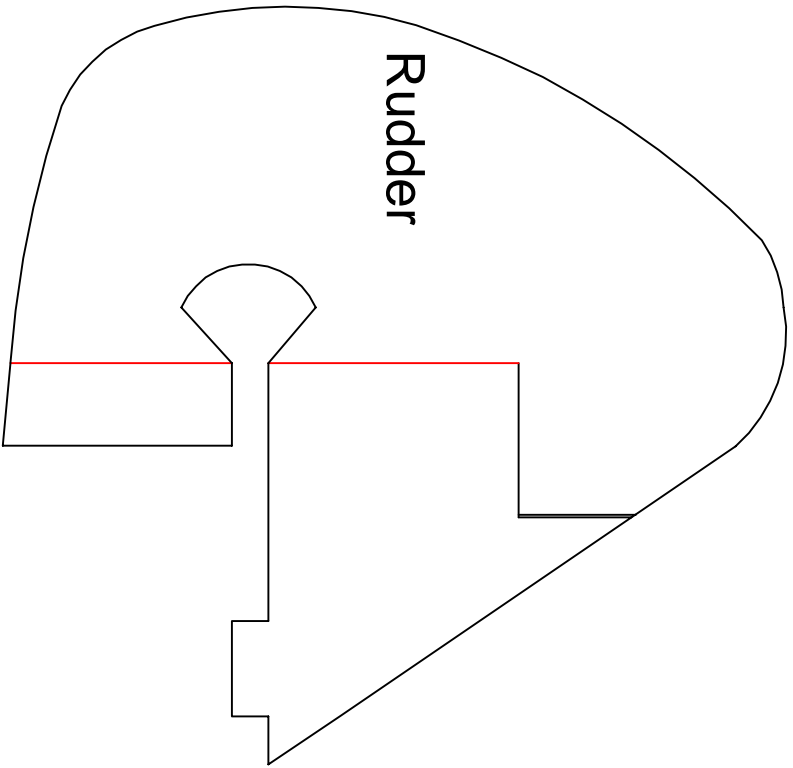

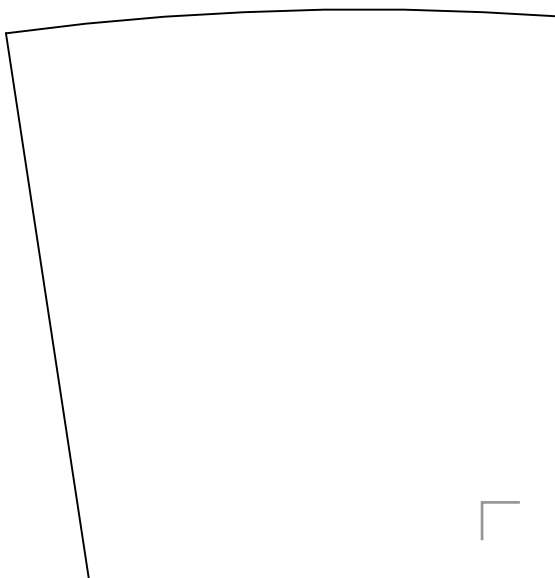
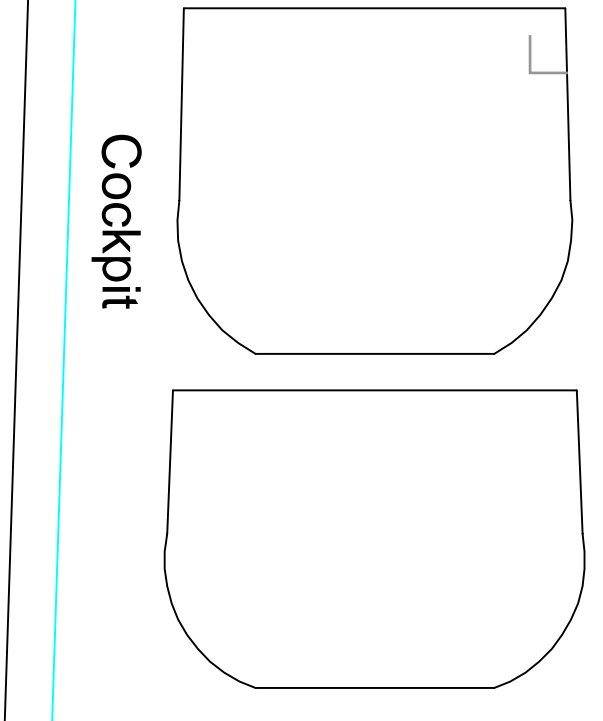

# Poste

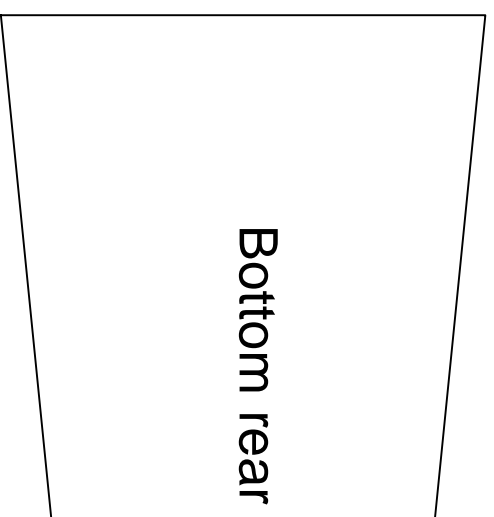
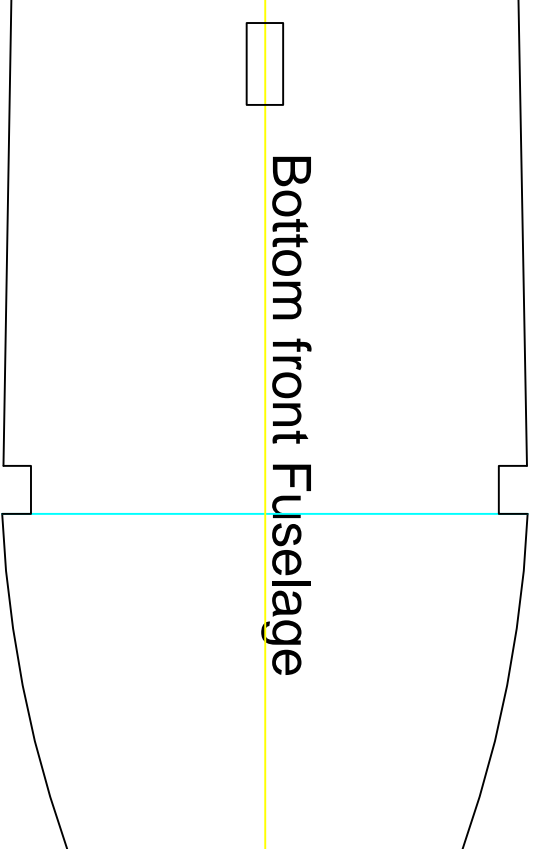

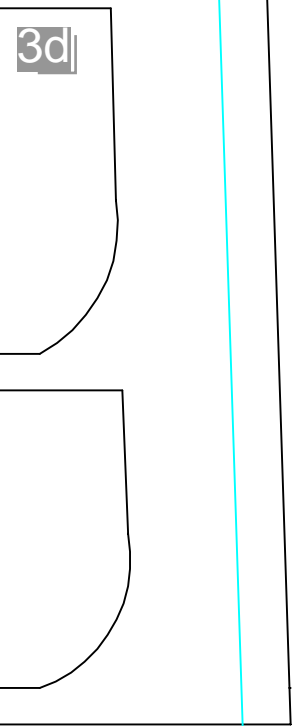
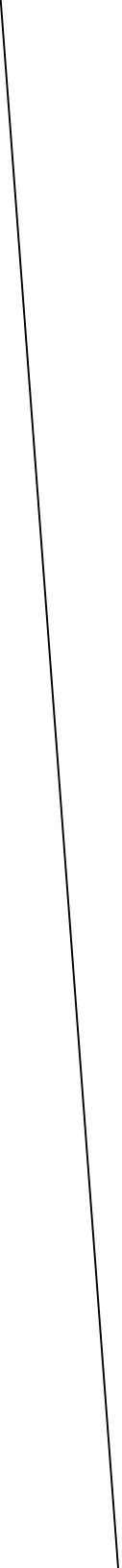
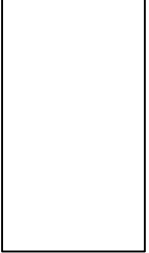

Rear Turtledeck



3d

Wing

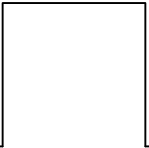

C  
D

E

4a



B ○

C ○

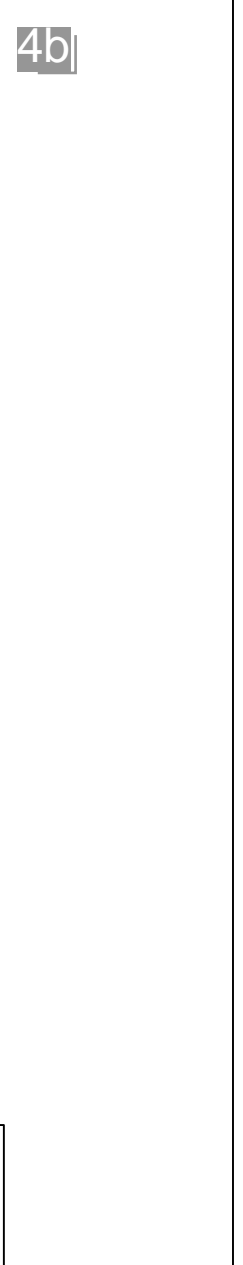
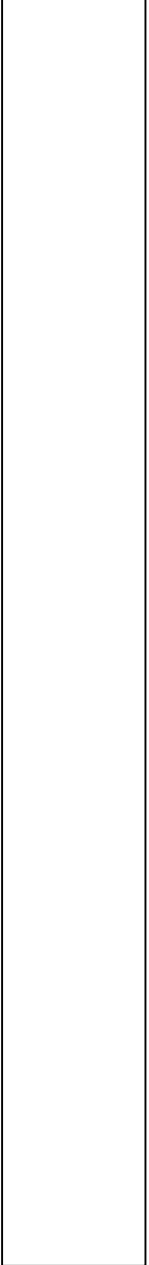
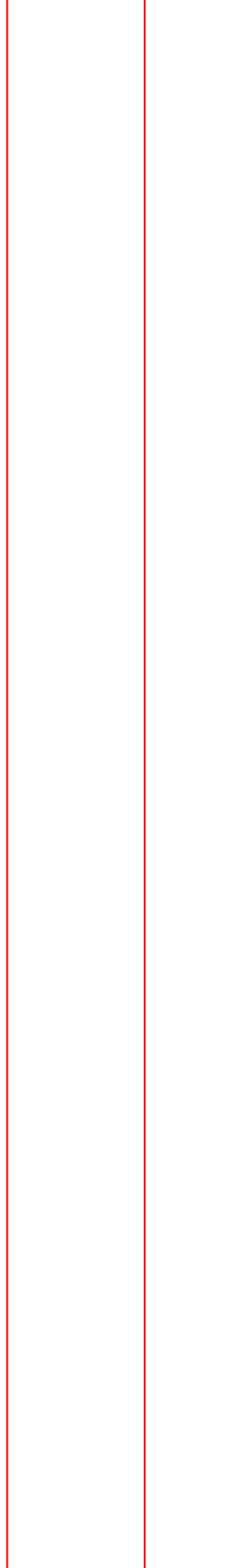

4b

# p Wing Guides

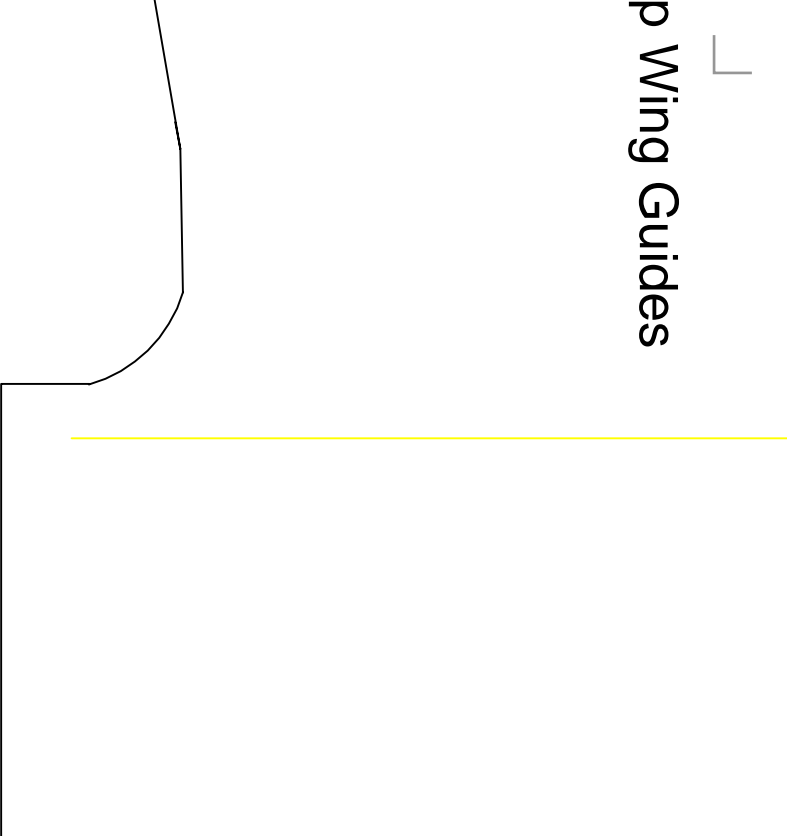

Battery hatch  
Latch

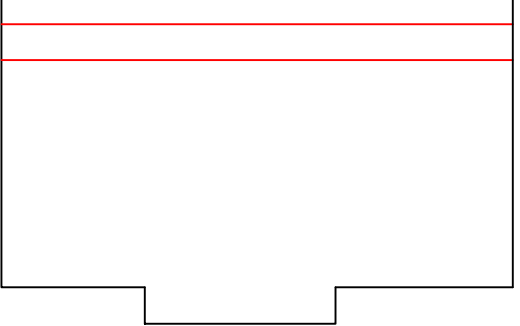
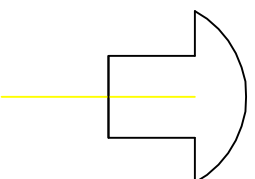

A ○

E D ○○





## Wing Guide supports X2

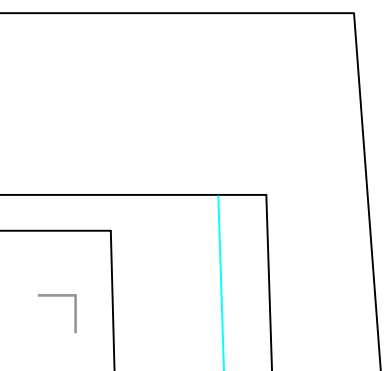





# Bottom Wing

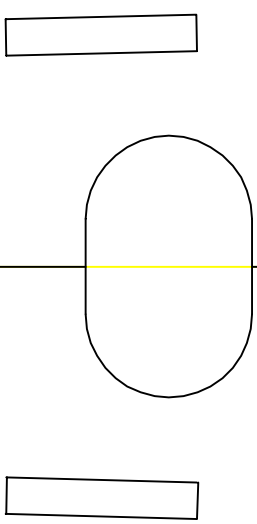

s till after both wings are assembled on aircraft.



○ B

B ○

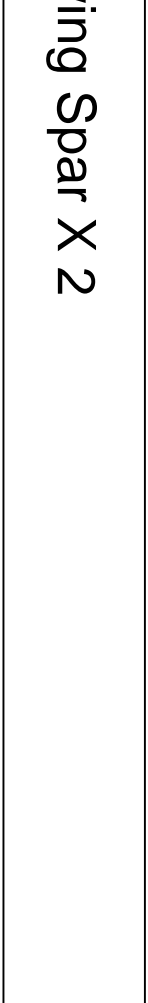
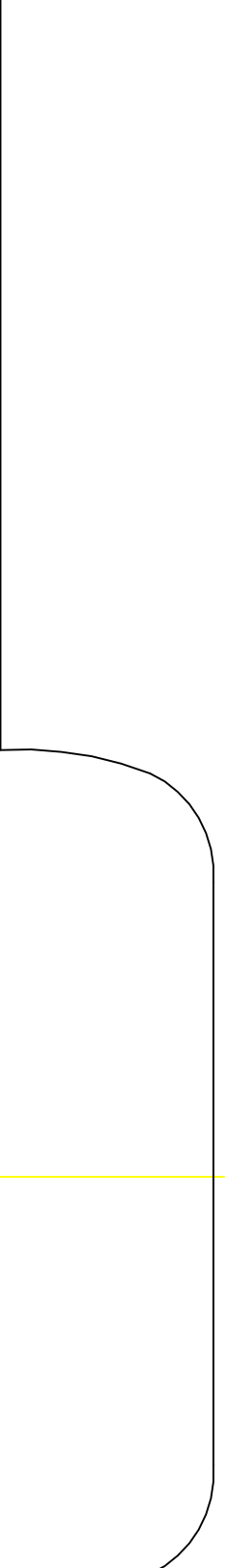

ing Spar X 2

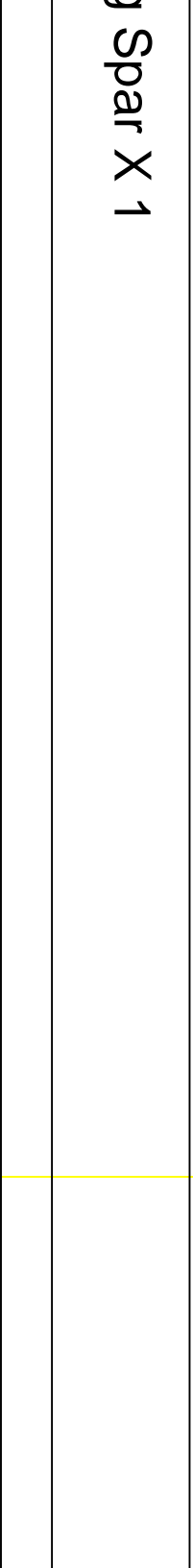

y Spar X 1

5b



# n Kelley

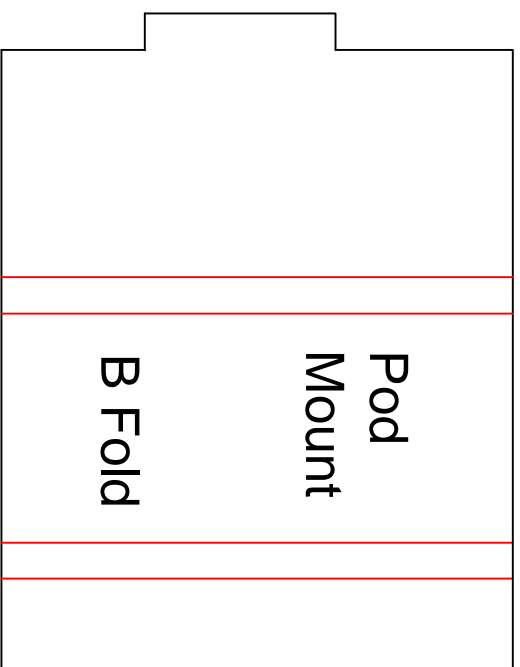
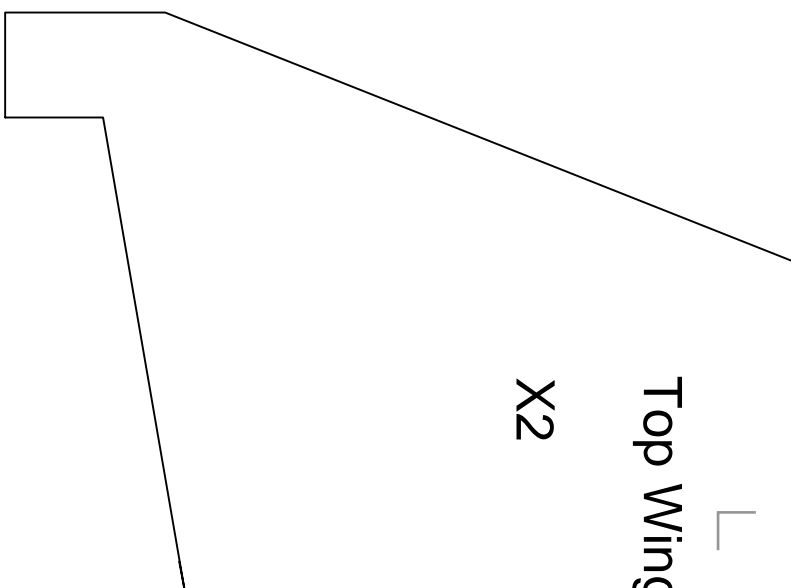
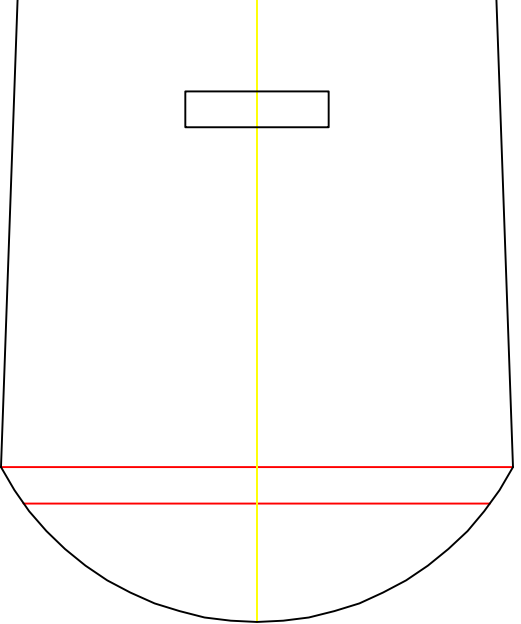
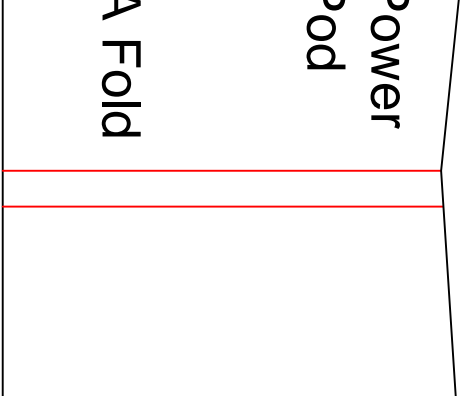

A

A



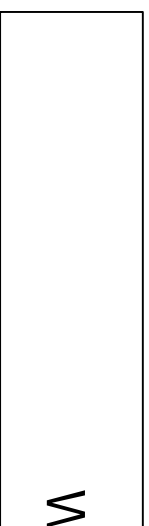
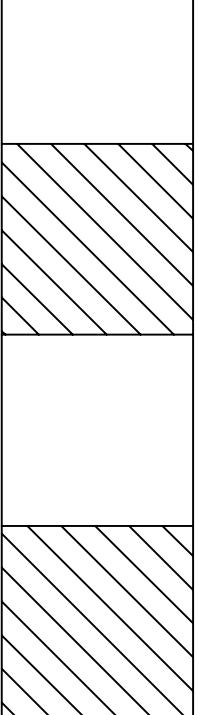

# Stearman

5d  
Kelley

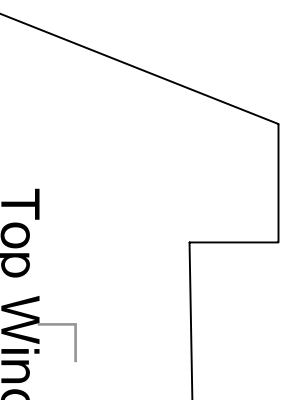

Top Wind

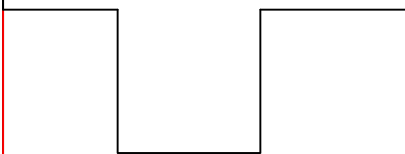

C 8  
D

E

Bottom

Do not fold aileron hinges till after

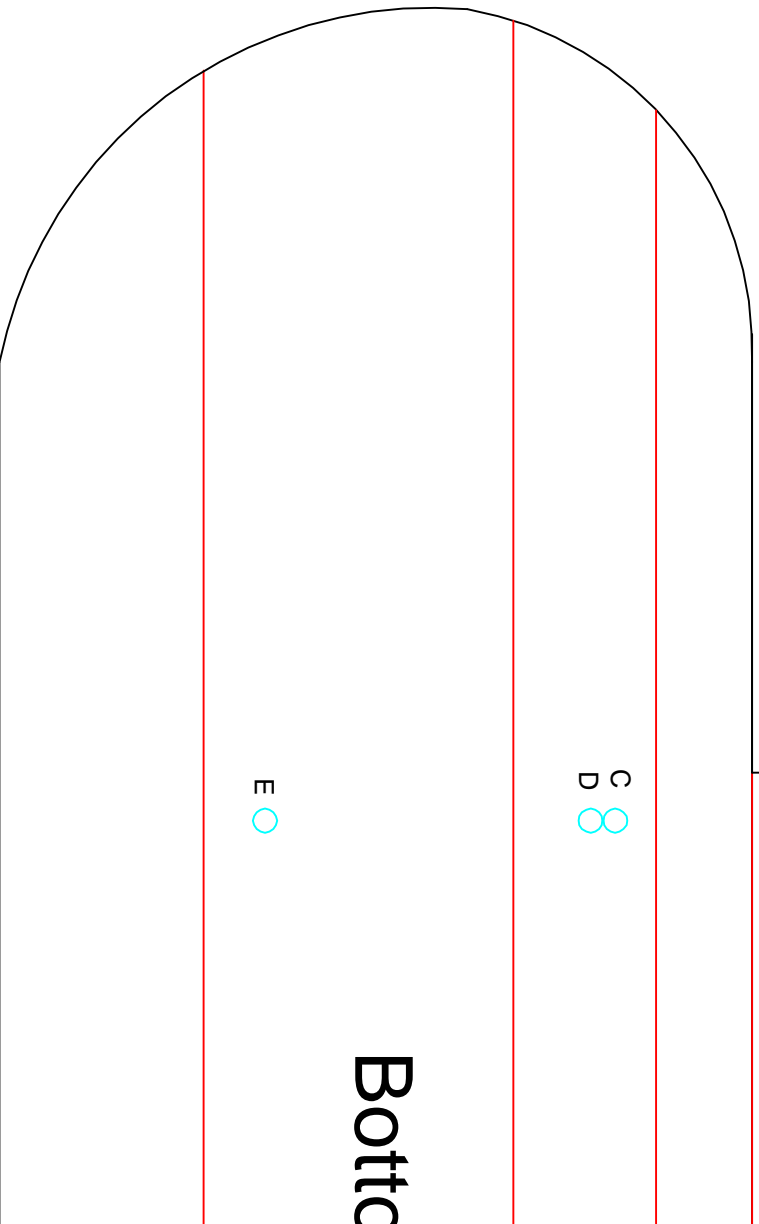

c

Top Wing

Bottom wing Spar

Top Wing Spar

By: Tim K

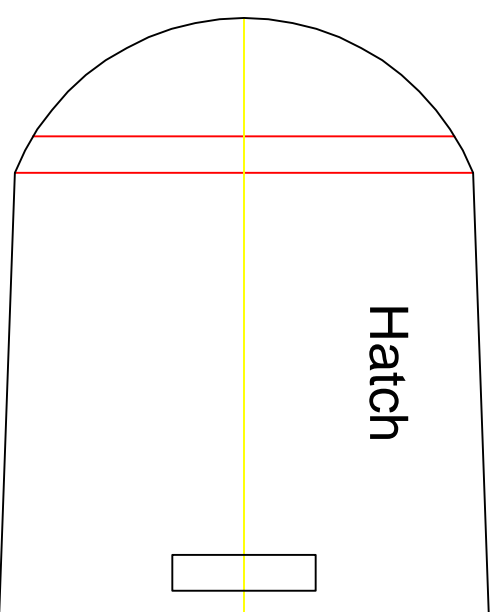
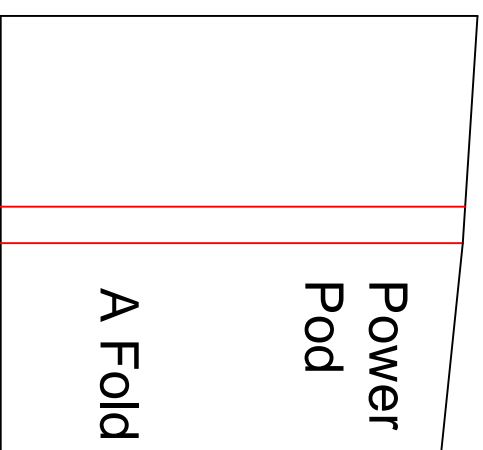

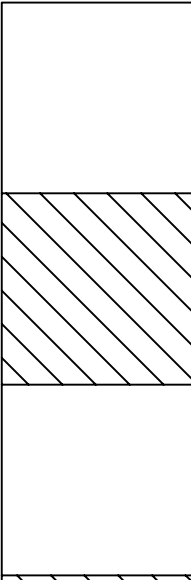

1" X 6"

PT-17 Ste

By: Tim K



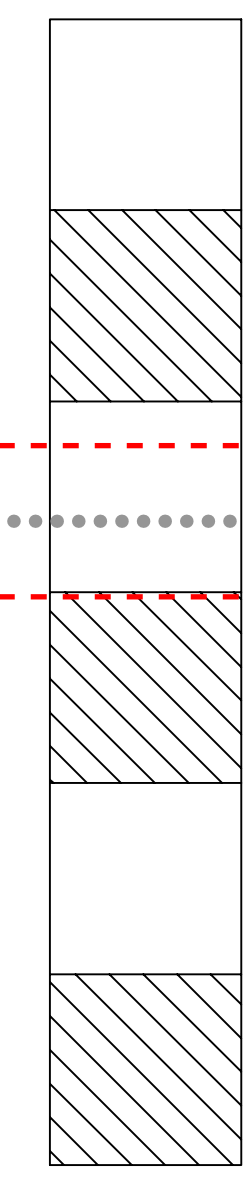

1" x 6"

Wing Guide supports X2

# PT-17 Stearman

By: Tim Kelley

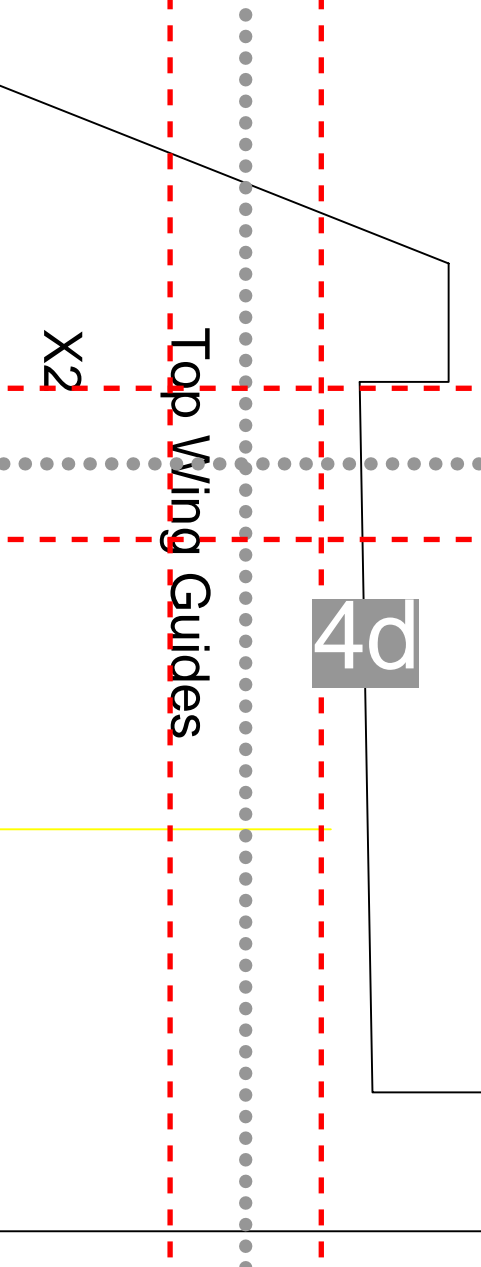
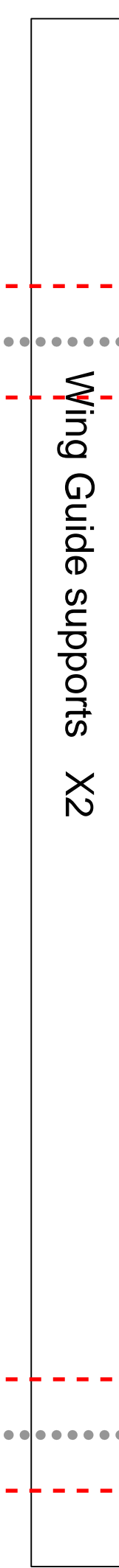

Top Wing Guides X2

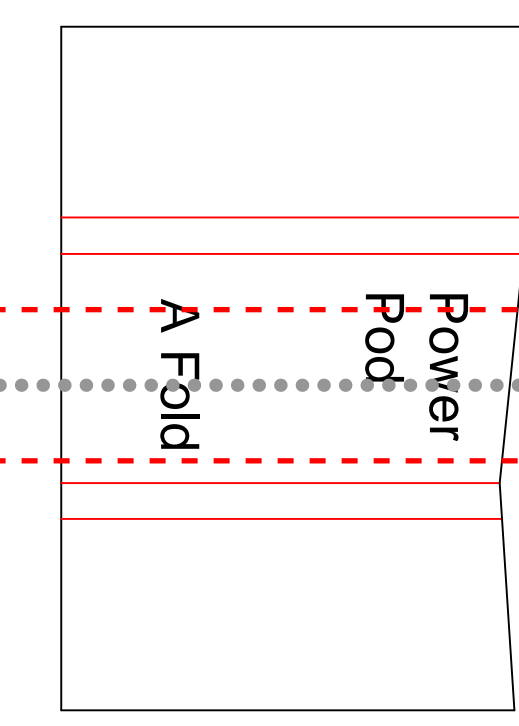

Power Pod

A Fold

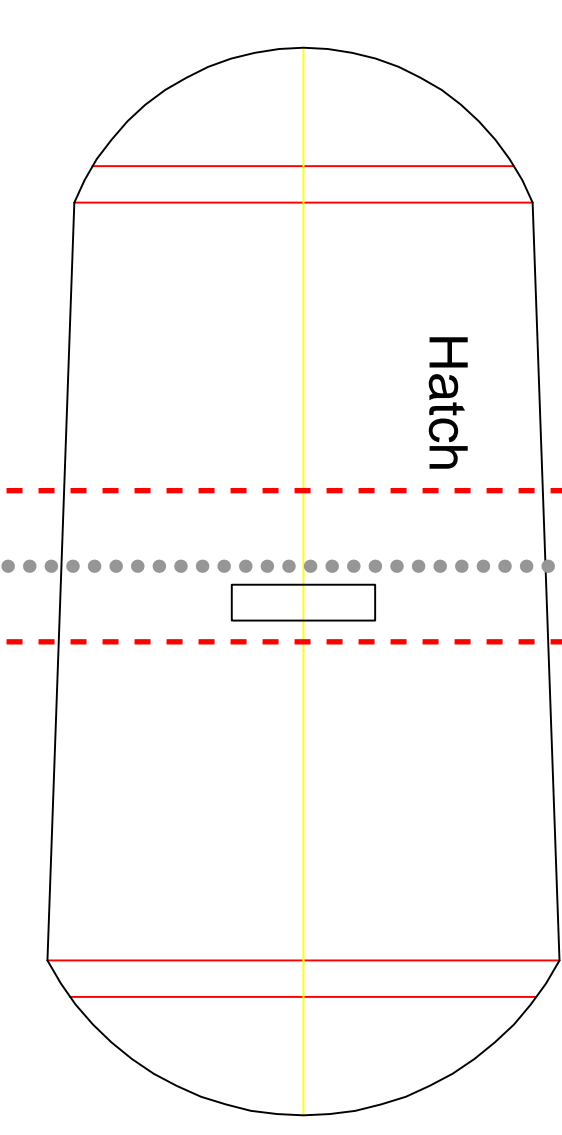

Hatch

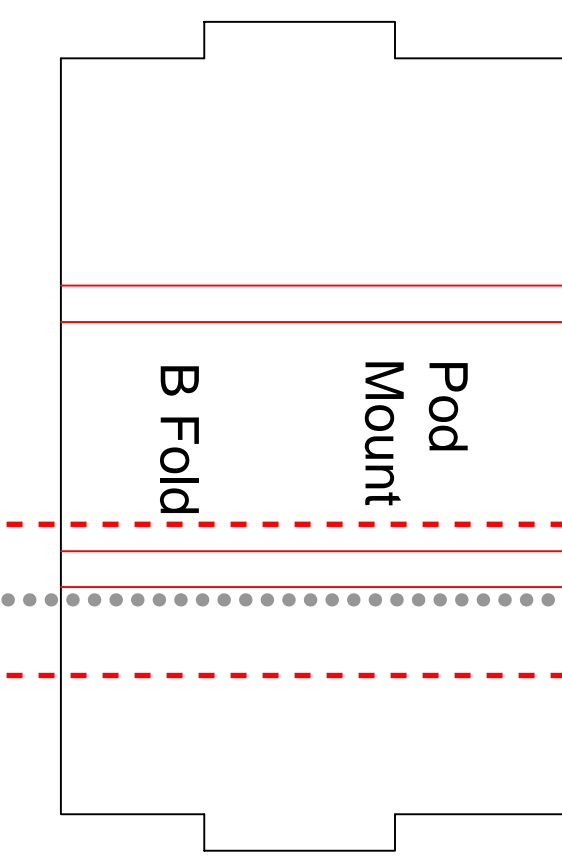

Pod Mount

B Fold

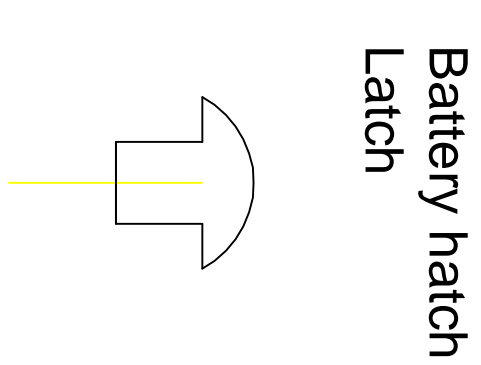

Battery hatch Latch

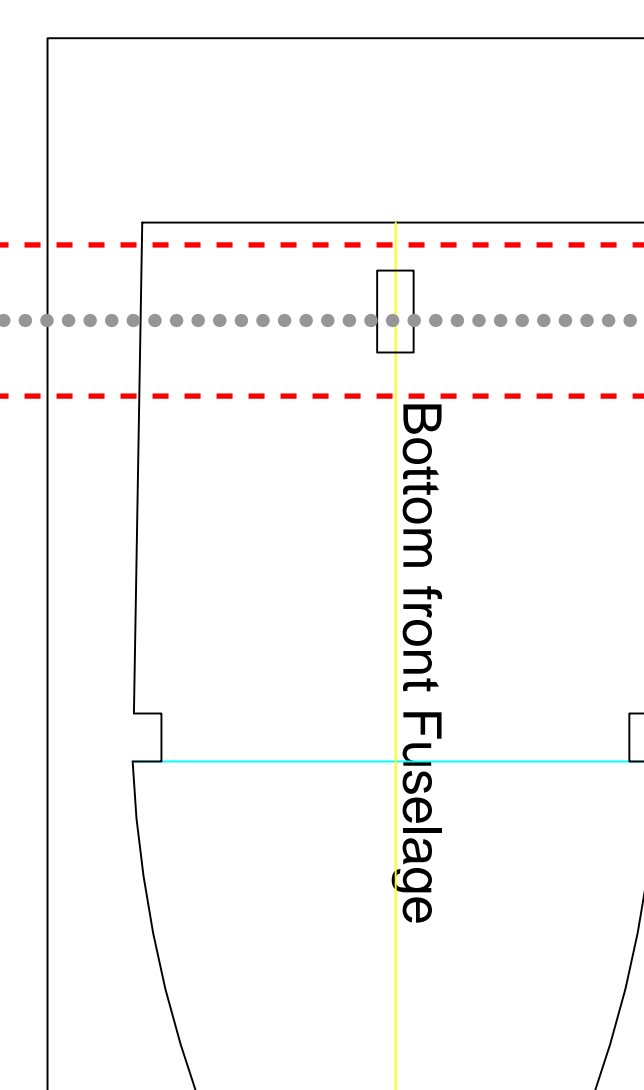

Bottom front Fuselage

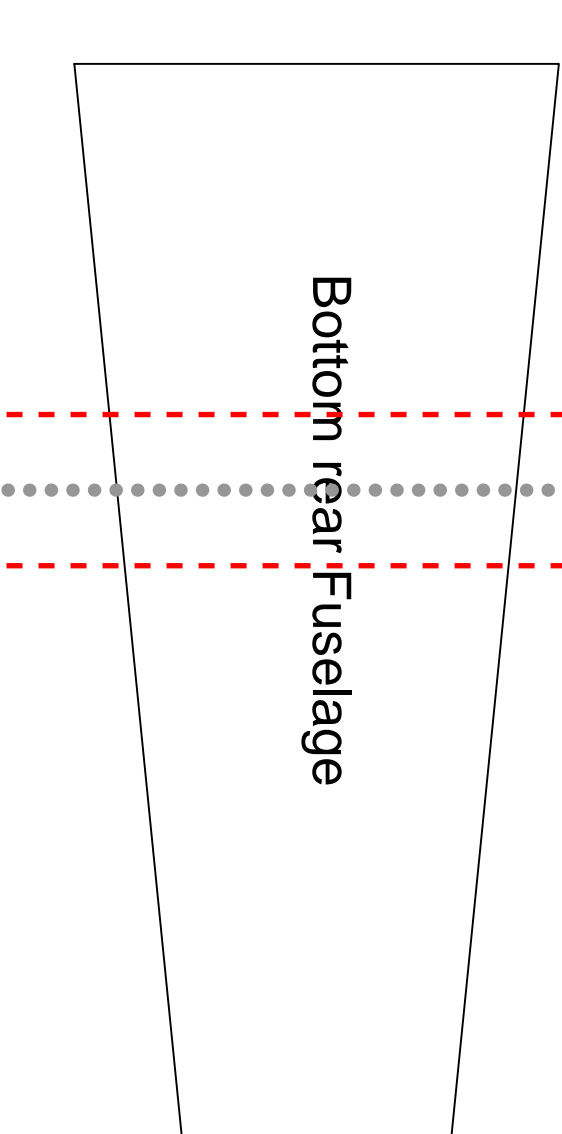

Bottom rear Fuselage

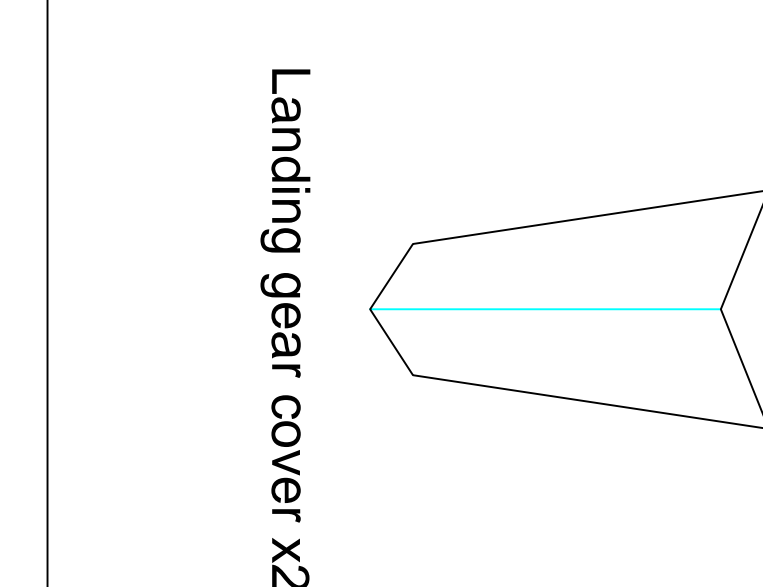

Landing gear cover X2

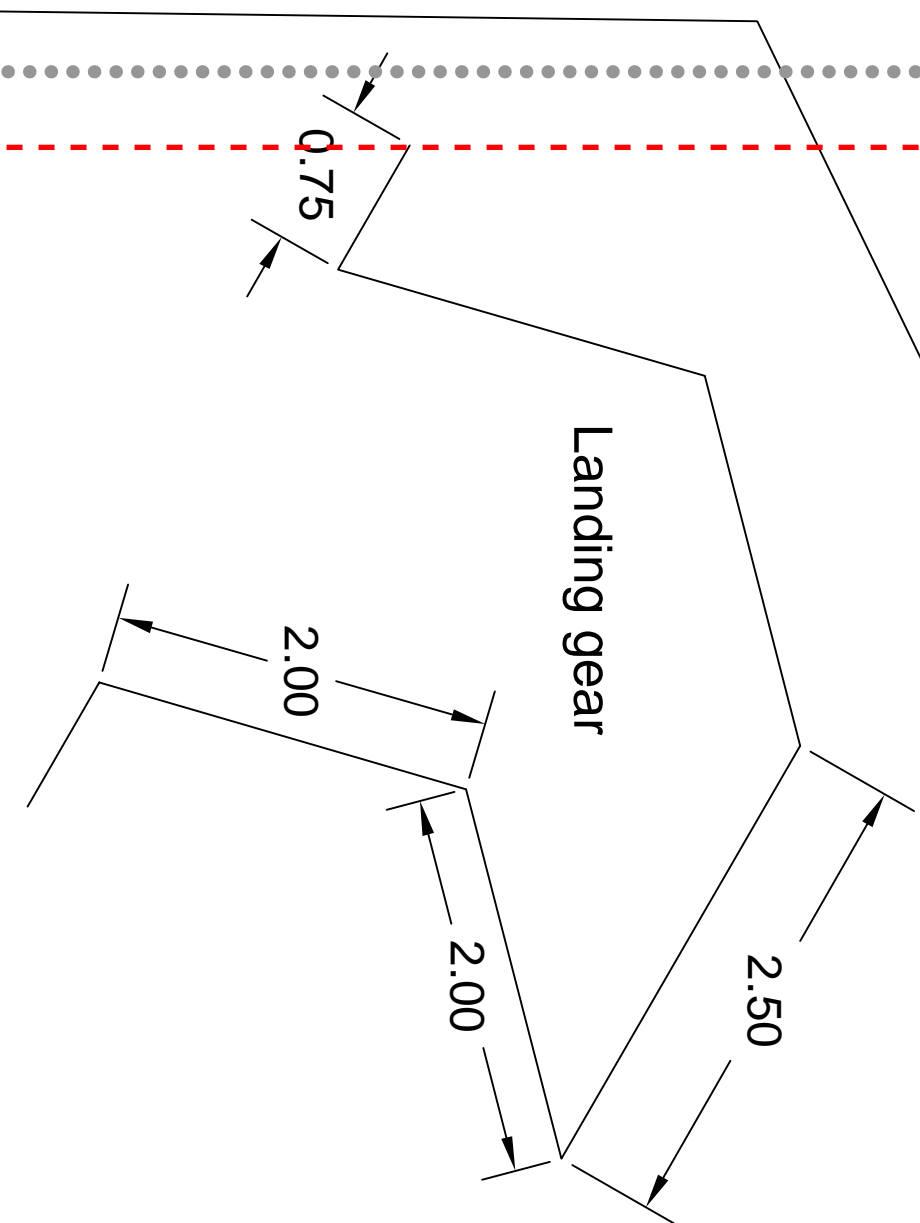

Landing gear

2.50

2.00

2.00

0.75

## Posterboard

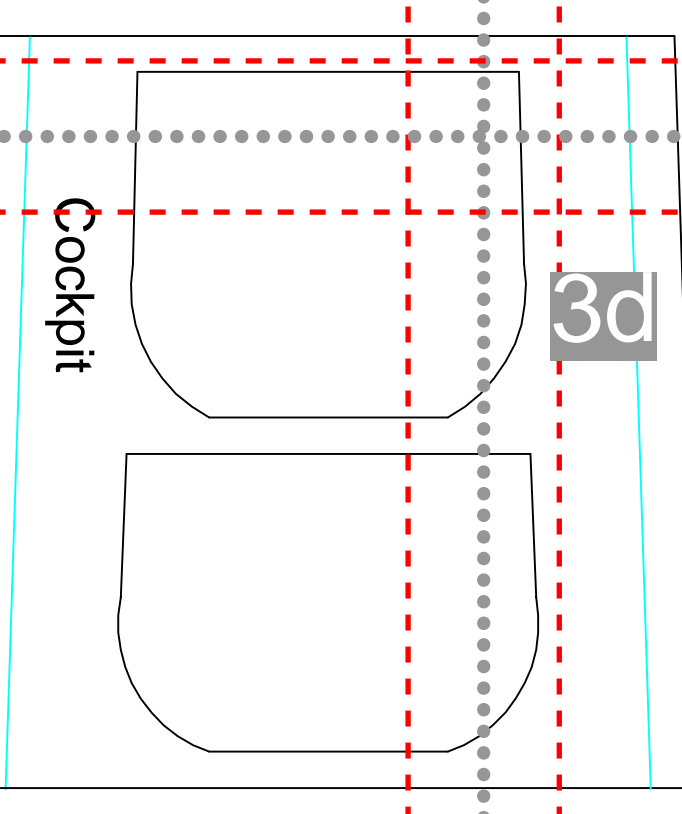

Cockpit

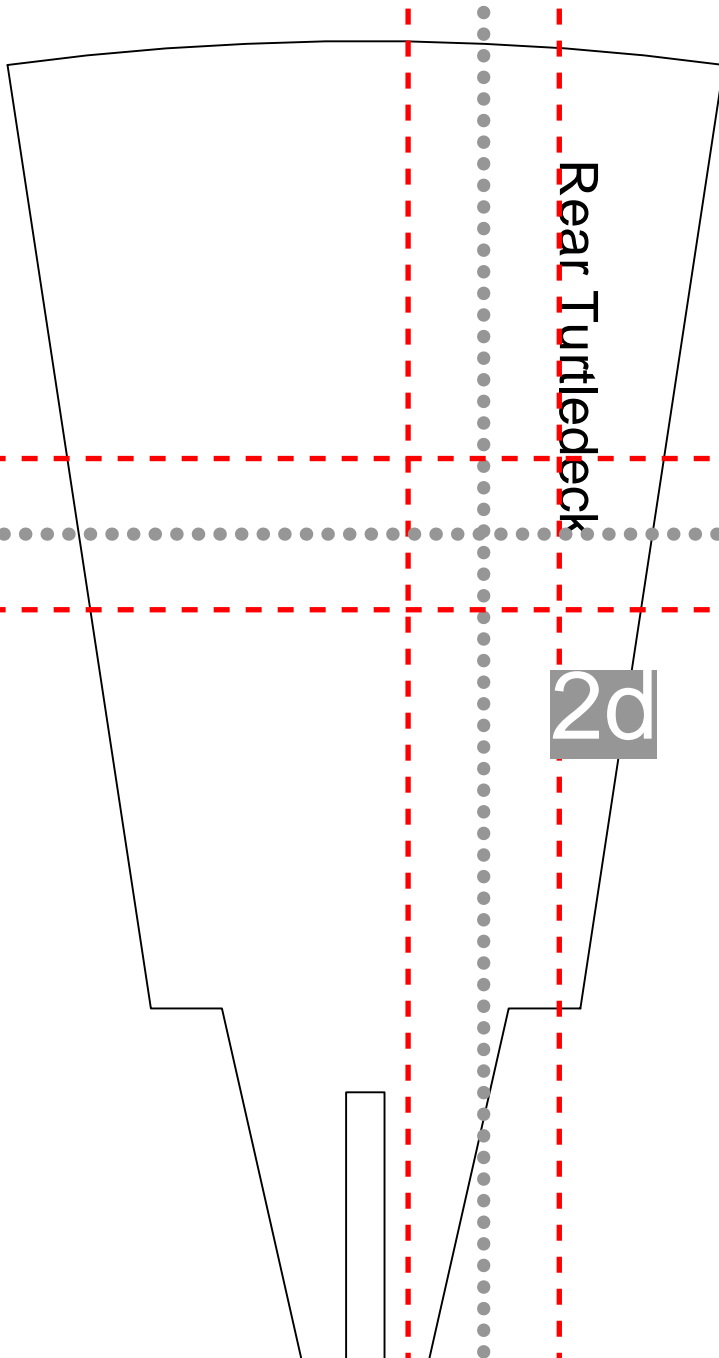

Rear Turtleneck

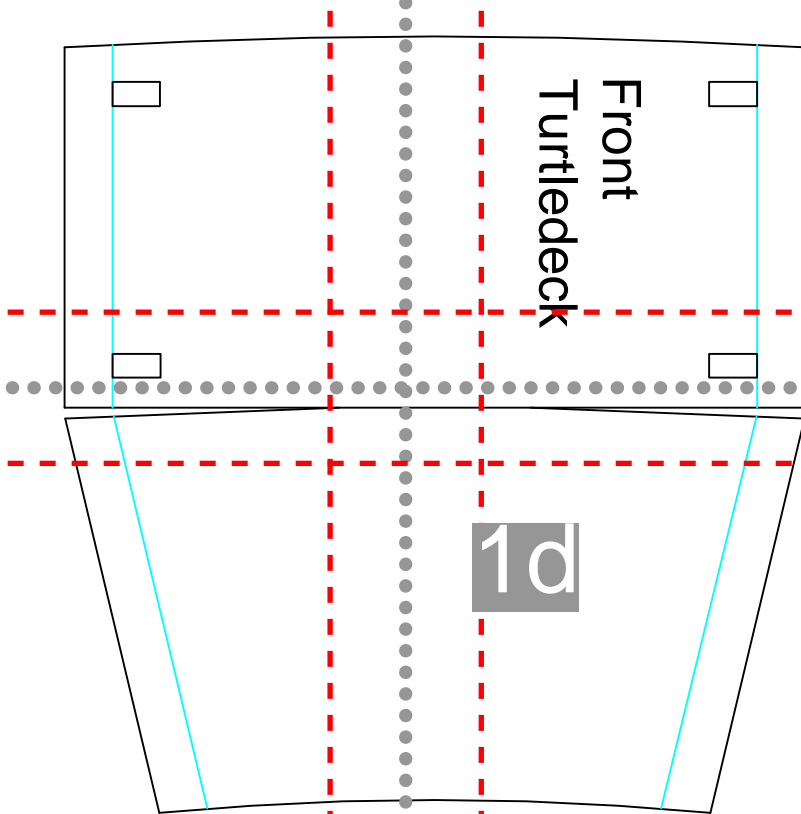

Front Turtleneck

Wing struts (2 each)

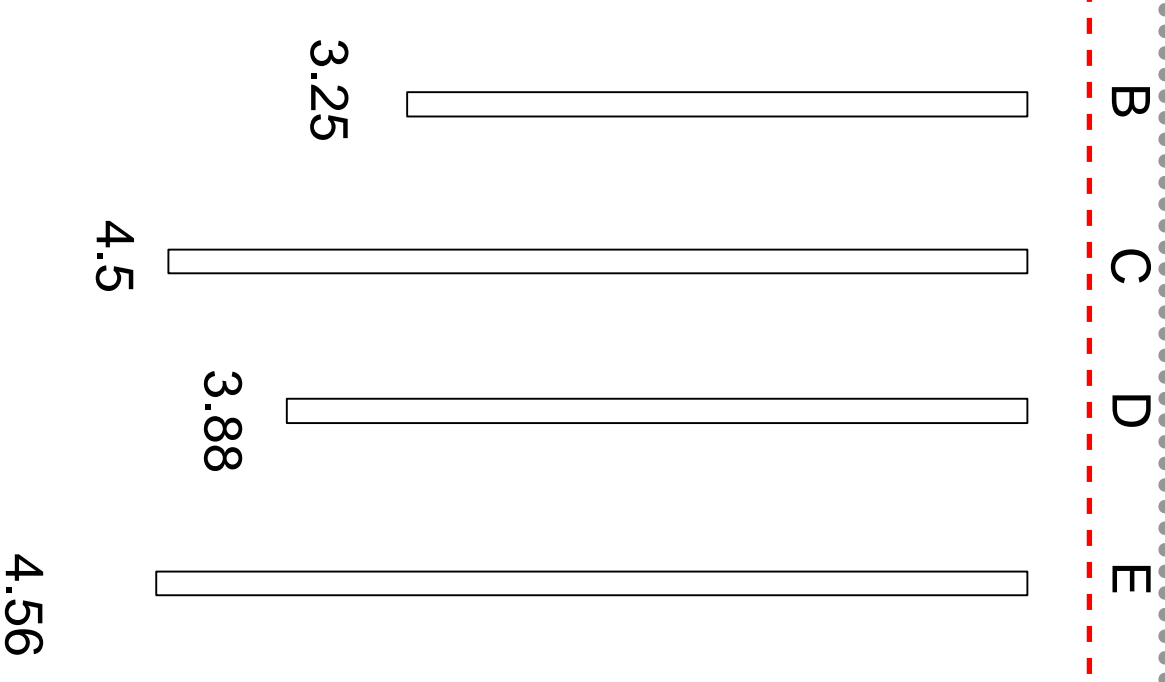

3.25

4.5

3.88

4.56

A

B

C

D

E

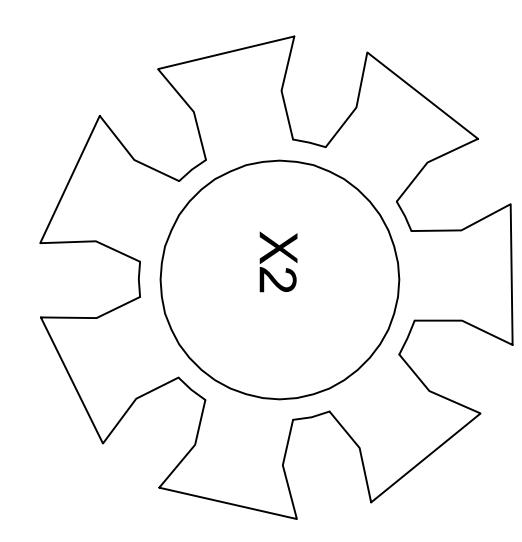

X2

Radial Engine

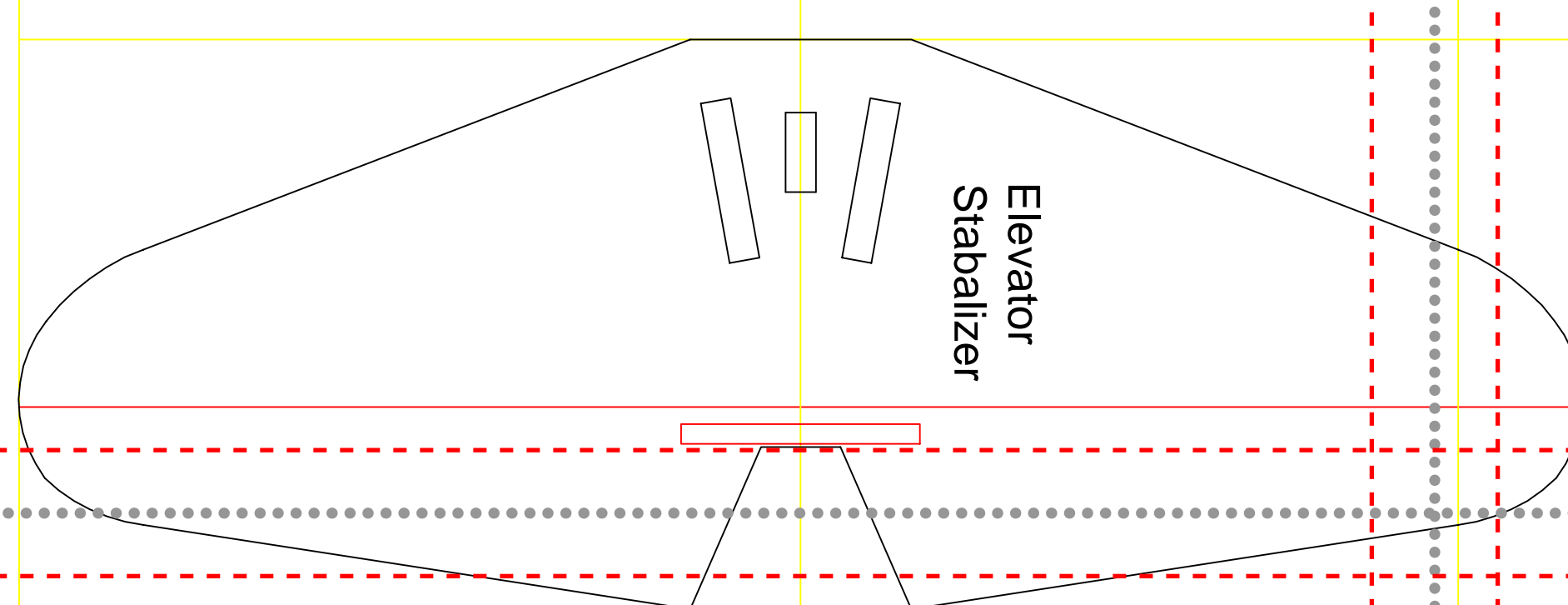

Elevator Stabilizer

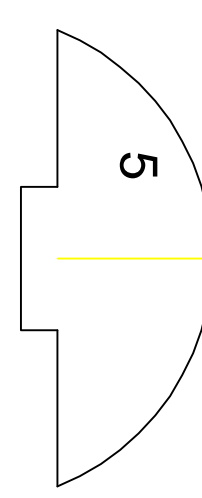
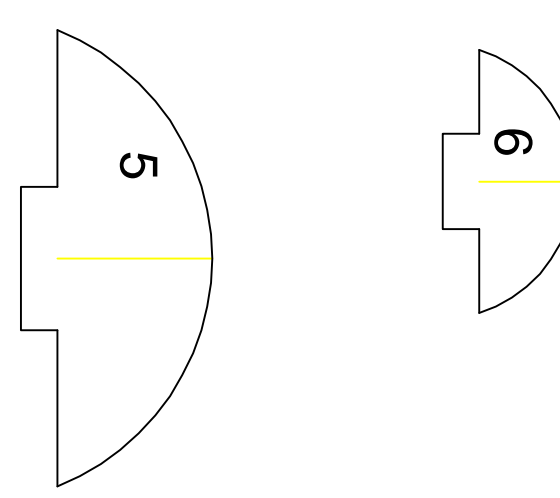
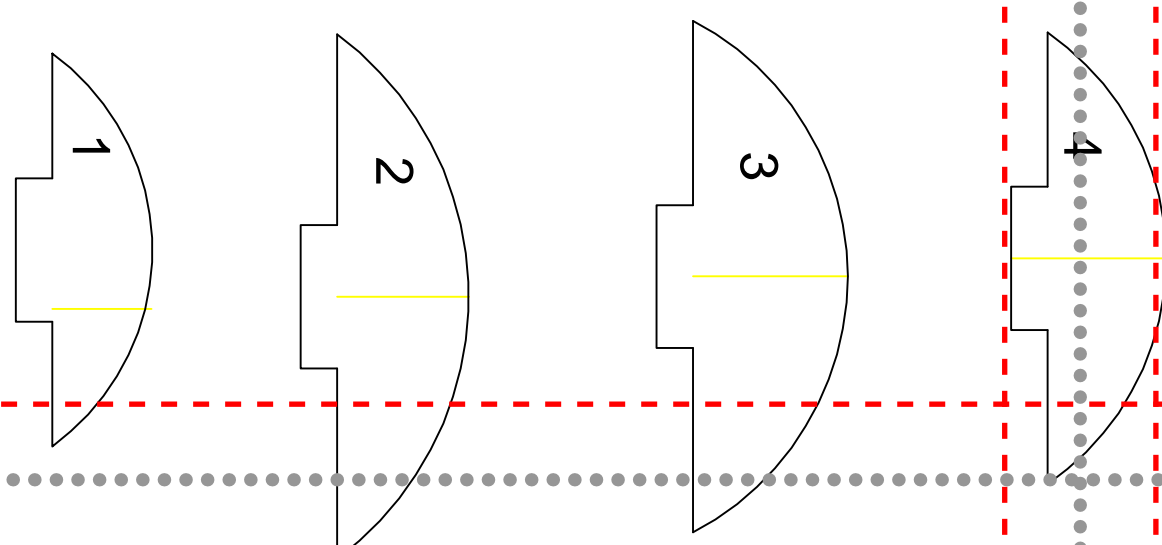
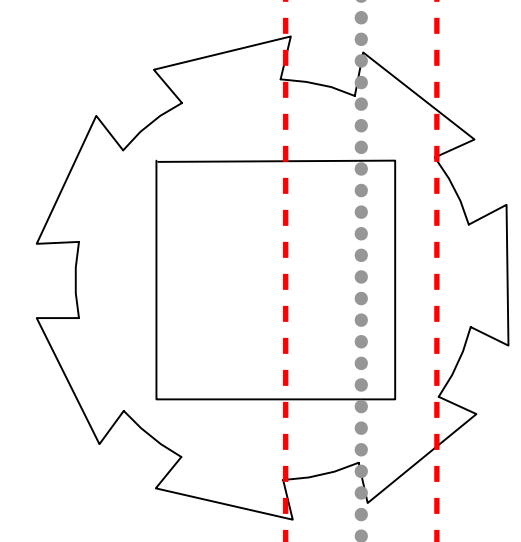

1

2

3

4

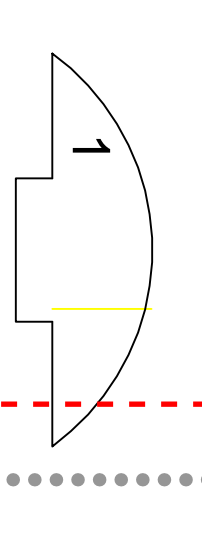

1

2

3

4

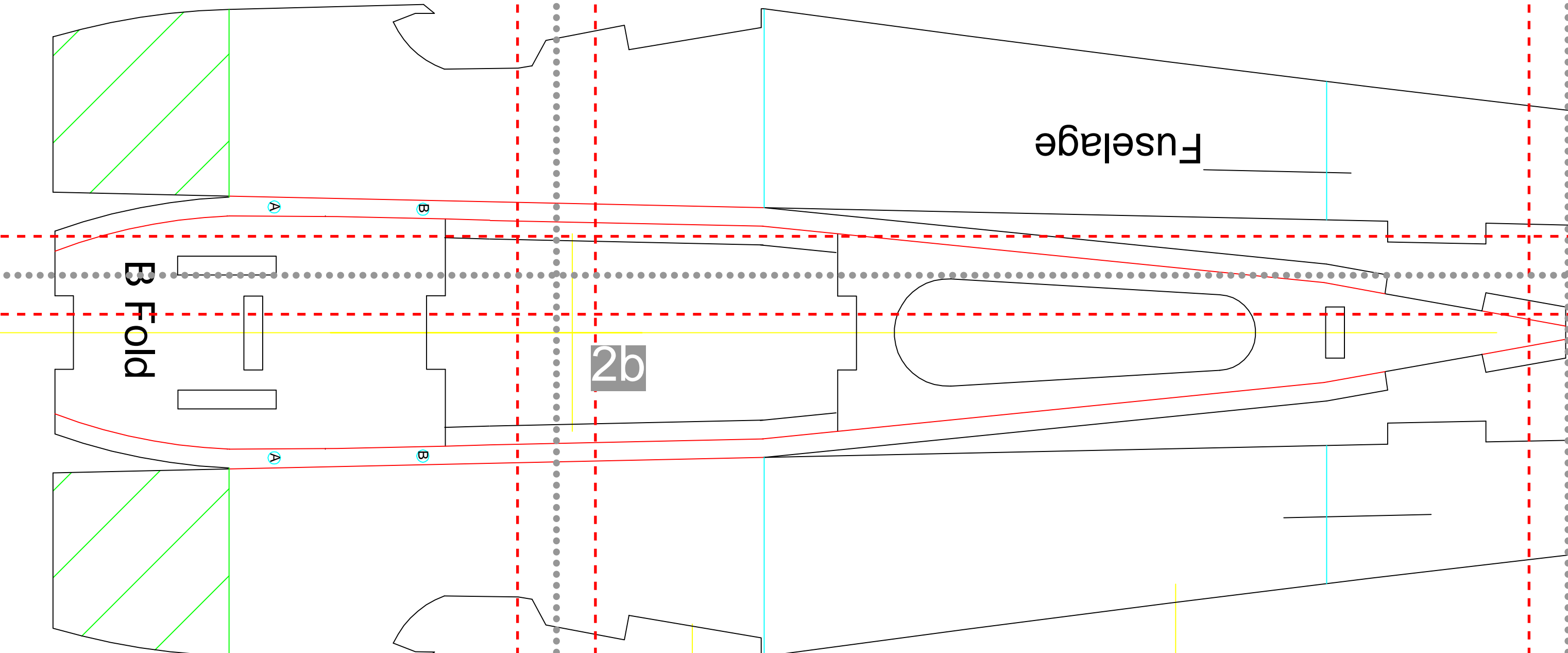

Fuselage

B Fold

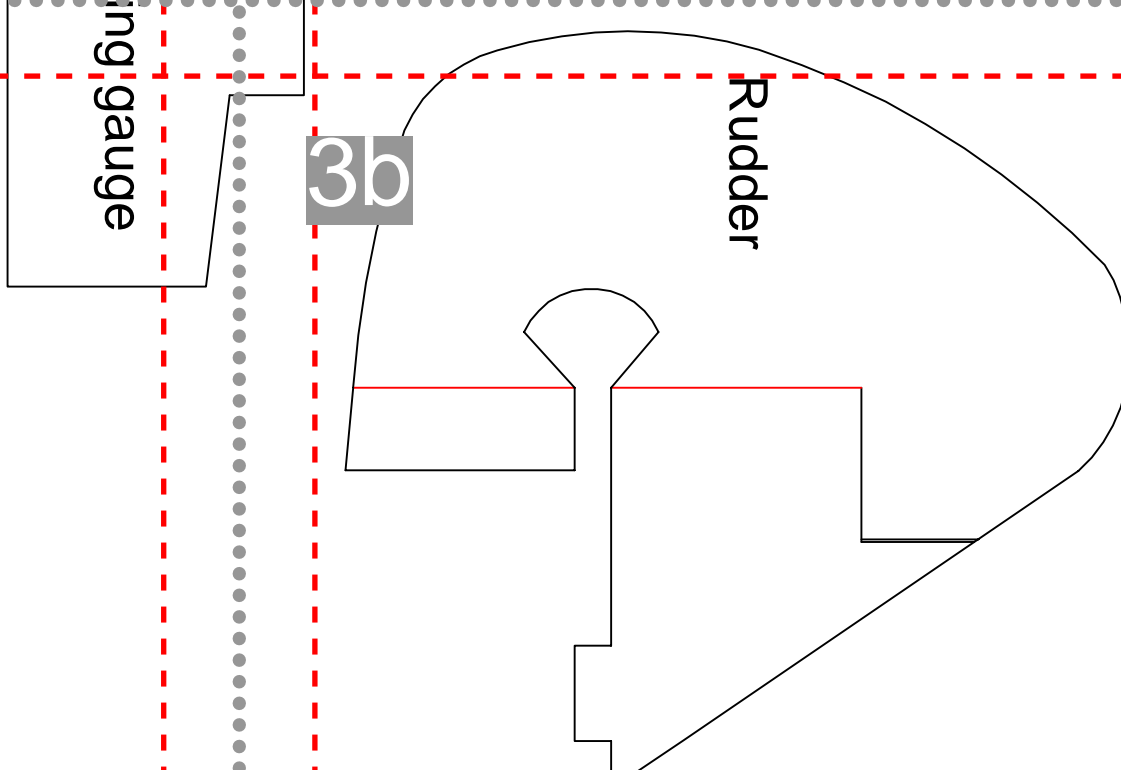

Rudder

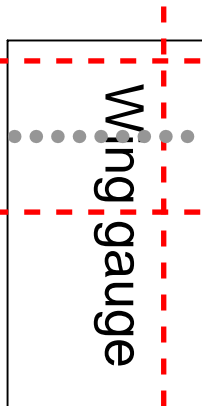

Wing gauge

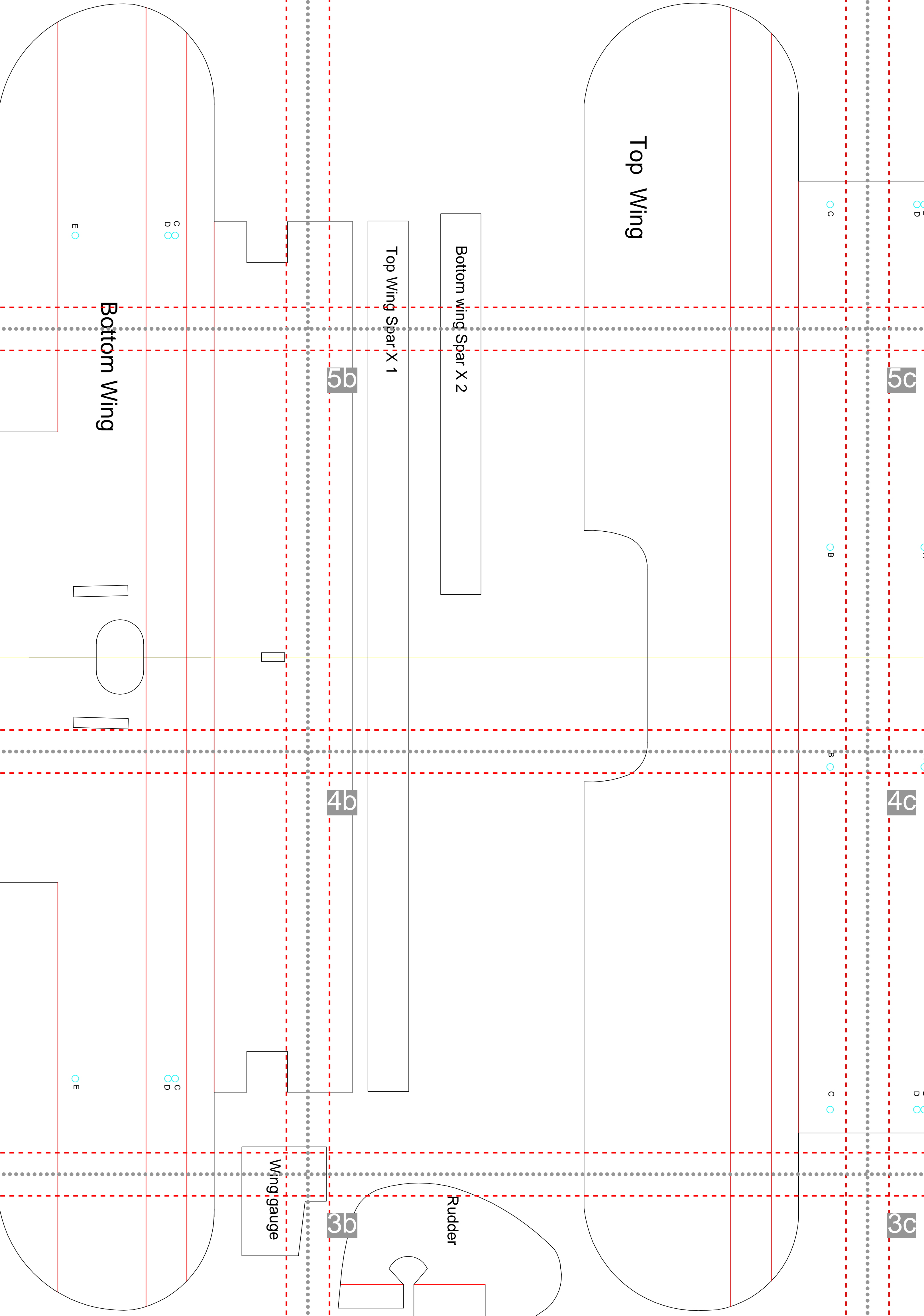

Top Wing

Bottom Wing

Bottom wing Spar X 2

Top Wing Spar X 1

Do not fold aileron hinges till after both wings are assembled on aircraft.

6a

6b

6c

6d

5a

5b

5c

5d

4a

4b

4c

4d

3a

3b

3c

3d

2a

2b

2c

2d

1a

1b

1c

1d