

Pricing and Reference Guide for Distributor



Distributor L600_2023_R111723
Issued January 1, 2023
Rev. 11.17.23
List Prices are in US Dollars
Prices Subject to Change Without Notice
Terms 30 Days
www.bascoshowerdoor.com



Table of Contents

Organized by configurations and showing premium products first, this product list can help you easily locate the door you need. RODA heavy glass models are purple, while Basco Core products are in blue.



**3/8" & 1/2" glass
Frameless**



**1/4" & 3/16" glass
Semi-frameless & Framed**

ORDERING ASSISTANCE

Contact Us, Ordering Examples 4 - 5

INLINE CONFIGURATIONS

Bypass Rolling and Sliding Doors

RODA	Rotolo Lux (RTXH-905), Rotolo "Zero Threshold" Lux (RZXH-905) - 3/8" glass Frameless 6 - 7
	Rotolo (RTLH-905), Rotolo w/ GridGlass (RTGA-905) - 3/8" glass Frameless 8 - 9
BASCO	Celesta (CELH-905) - 3/8" glass Frameless 10 - 11
	Rotolo Lux (5450/5550) - 1/4" glass Frameless 12 - 13
	Rotolo (5400/5500) - 1/4" glass Semi-frameless 12 - 13
	Infinity (4400/4500) - 1/4" glass Semi-frameless 14 - 15
	Classic (3400/3500) - 3/16" glass Semi-frameless 14 - 15
	Deluxe (6150/7150) - Framed 16 - 17

Swing Door with Fixed Panel

RODA	Celesta (CELNH-935), Dresden (DRENH-935) - 3/8" glass Frameless 18 - 19
	Geolux (GEONH-935), Tresor (TRENH-935), Vonse (VONNH-935), Lux (LUXNH-935) - 3/8" glass Frameless 20 - 21
BASCO	Fusion (1435) - 3/8" & 1/4" glass Semi-frameless 22 - 23
	Infinity (1413/1413NP) - 1/4" glass Semi-frameless 22 - 23
	Deluxe (135) - Framed 24 - 25

Rolling Door with Fixed Panel/Bypass with Inline Panel

RODA	Rolaire (ROLH-935) & Rolaire w/ GridGlass (ROGA-935) - 3/8" glass Frameless 26 - 27
BASCO	Infinity Bypass with Inline Panel (4403/4503) - 1/4" glass Semi-frameless 28 - 29

Single Swing Models

RODA	Celesta (CELN-900) & Dresden (DREN-900) - 3/8" glass Frameless 30 - 31
	Geolux (GEON-900), Tresor (TREN-900), Vonse (VONN-900), Lux (LUXN-900) - 3/8" glass Frmless 32 - 33
BASCO	Infinity (1400) - 1/4" glass Semi-frameless 34 - 35
	Deluxe (100) - Framed 34 - 35
	Infinity Bifold (1433) - 1/4" glass Semi-frameless 36 - 37
	Steam Door (18CS) & Top Panels (400S, 400H) - Framed 38 - 39

Stationary Shower Screens

RODA	Celesta (CELN-910) - 3/8" glass Frameless 40 - 41
BASCO	Deluxe (410) - Framed 40 - 41

INLINE CONFIGURATIONS CONT.

French Doors

RODA | Celesta (*CELN/H-922*) & Dresden (*DREN/H-922*) - 3/8" glass Frameless 42 - 43

Geolux (*GEON/H-922*), Tresor (*TREN/H-922*), Vonse (*VONN/H-922*), Lux (*LUXN/H-922*) - 3/8" glass..... 44 - 45

BASCO | Infinity (*1022/1422*) - 1/4" glass Semi-frameless 46 - 47

Panel/Swing Door/Panel

RODA | Celesta (*CELN/H-925*) & Dresden (*DREN/H-925*) - 3/8" glass Frameless 48 - 49

Geolux (*GEON/H-925*), Tresor (*TREN/H-925*), Vonse (*VONN/H-925*), Lux (*LUXN/H-925*) - 3/8" glass..... 50 - 51

BASCO | Infinity (*1412*) - 1/4" glass Semi-frameless 52 - 53

Deluxe (*125*) - Framed..... 52 - 53

Panel/Rolling Door/Panel

RODA | Rolaire (*ROLH-925*) - 3/8" glass Frameless..... 54 - 55

RETURN CONFIGURATIONS

Swing Door with a Return Panel

RODA | Celesta (*CELN/H-945*) & Dresden (*DREN/H-945*) - 3/8" glass Frameless 56 - 57

Geolux (*GEON/H-945*), Tresor (*TREN/H-945*), Vonse (*VONN/H-945*), Lux (*LUXN/H-945*) - 3/8" glass..... 58 - 59

BASCO | Infinity (*1414*) - 1/4" glass Semi-frameless 60 - 61

Deluxe (*145*) - Framed..... 60 - 61

Swing Door with Inline & Return Panels

RODA | Celesta (*CELN/H-950*) & Dresden (*DREN/H-950*) - 3/8" glass Frameless 62 - 63

Geolux (*GEON/H-950*), Tresor (*TREN/H-950*), Vonse (*VONN/H-950*), Lux (*LUXN/H-950*) - 3/8" glass..... 64 - 65

BASCO | Fusion (*1450*) - 3/8" & 1/4" glass Semi-frameless..... 66 - 67

Infinity (*1415/1415NP*) - 1/4" glass Semi-frameless..... 66 - 67

Deluxe (*150*) - Framed..... 68 - 69

Rolling Door with Panel & Return/Bypass with Return Panel

RODA | Rolaire Rolling Door with Inline & Return Panels (*ROLH-950*) - 3/8" glass Frameless..... 70 - 71

BASCO | Infinity Bypass with Return Panel (*4401/4501*) - 1/4" glass Semi-frameless 70 - 71

NEO ANGLE CONFIGURATIONS

RODA | Celesta (*CELN/H-960*) & Dresden (*DREN/H-960*) - 3/8" glass Frameless 72 - 73

Geolux (*GEON/H-960*), Tresor (*TREN/H-960*), Vonse (*VONN/H-960*), Lux (*LUXN/H-960*) - 3/8" glass..... 74 - 75

BASCO | Infinity (*1416*) - 1/4" glass Semi-frameless 76 - 77

Deluxe (*160*) - Framed..... 76 - 77

Infinity (*1416*), Deluxe (*160*) - Fiberglass Specific Neo Angles 78 - 79

STANDARD SIZE MODELS

RODA | Rotolo (*RTLA-905*) & Celesta (*CELA-905*) 3/8" glass, Semi-frameless Bypass 80 - 81

Rolaire (*ROLA-935*) 3/8" glass Frameless Rolling Door/Fixed Panel 80 - 81

Celesta (*CELA-935*) & Coppia (*COPA-935*) 3/8" glass Frameless Swing Door & Panel 82 - 83

Coppia (*COPA-900*) 3/8" glass Frameless Swing Door 82 - 83

ADDITIONAL RESOURCES

Heavy Glass Requirements, Glossary of Terms..... 84 - 85

Protect Your Investment, Cleaning Products..... 86 - 87

Fillers 88 - 89

Quick Ship Program 90 - 91

Our goal is to simplify the ordering process and provide the ultimate customer buying experience at every opportunity. Below are just a few tools available to make your job easier.

Have a question? *We're here to help.*

Email, call or fax for immediate service.

Customer Service & Technical Support

Plumbing Wholesale Customers.....	(800) 543-5451
Retail Customers.....	(800) 543-4538
Order Entry Fax Line.....	(800) 989-1919

EMAIL:

Questions or Inquiries.....	inquiry@basco showerdoor.com
To Receive a Quote	quotes@basco showerdoor.com
To Place an Order.....	orders@basco showerdoor.com

Check Order Status? *Visit ebiz.mybasco.com.*

Get order details anytime including dates, product details, shipping information, and carrier tracking numbers. Contact customer service today by email or phone for registration.

Online Shower Door Configurator



Mystro – Mystro is Basco's online configurator designed to simplify the Basco shower door buying experience for professionals within our network.

- **Assisted Selling by Model** - Web based quoting and product selection with a "find my model number" functionality enables showroom professionals to answer customer questions immediately.
- **Visual Door Drawing** - Access to Basco's production configurator provides your customer with a unique rendering of their specific selections.
- **Dynamic Pricing** - Confidently quote based on model and your customer's configuration selections.
- **Save and Store** - Retain quotes, customer information and showroom part numbers for recurring or ad hoc use. Open text fields enable customization and quote specifics.
- **Faster, More Accurate** - "One-click" quote submission to Basco orders and receive supplemental door drawings and more professional quotes for your customers.

Warranty

Basco offers a Limited Lifetime Warranty. For additional information and specifications, please visit www.basco showerdoor.com.

Model Numbers and Ordering Examples

Different model numbers create clarity between our RODA and Basco Core lines. RODA model numbers always start with letters that represent the collection name (e.g. CEL for Celesta, DRE for Dresden, RTL for Rotolo). Basco Core model numbers always start with a number (e.g. 4500, 135, 6150). **Logos on each page also help you identify if the model is from the RODA line or the Basco Core line.**

Build the RODA Model Number

When placing an order for a RODA (3/8" or 1/2") shower enclosure, the following items are required:

- RODA collection code, Header code, and configuration number (eg. CELN-935)
- Width desired
 - ◊ Range based units designated as "Fits Openings Between"
 - ◊ Exact width units labeled as "Specify Width Between"
- Finished height
- Glass type
- Finish option
- Any additional optional features/detailed drawing*

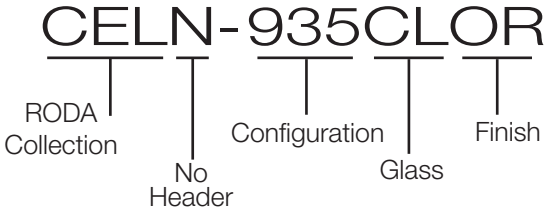

Build the Basco Core Model Number

When placing an order for a Basco Core shower enclosure, the following items are required:

- Numerical model number (e.g. 5500 or 1413)
- Width desired
 - ◊ Add width for range based units designated as "Fits Openings Between"
 - ◊ Specify exact width for units labeled as "Specify Width Between"
- Finished height
 - ◊ If standard & range based unit, add height without fraction.
 - ◊ If standard and not range based, specify height
- Glass type - add code
- Finish option - add code
- Any additional optional features/detailed drawing*

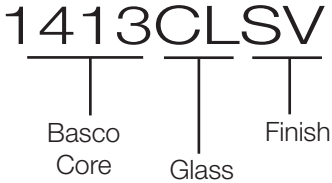
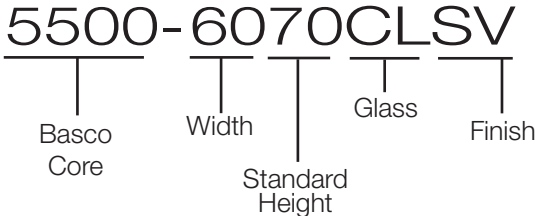

***Each custom order must include a detailed drawing**

that shows unit height, width (A, A+B, or A+B+C) and any out of square conditions, notched panels and/or buttresses. Shower head location may be required, depending on the enclosure. Please refer to configurations and Notes/Options for specific restrictions, requirements and recommendations for each RODA/Basco collection. Due to certain wall conditions, some hinge options may not be available. Note that not all available options are shown in this price list and special design requests can be accommodated at an additional charge. Contact Customer Service for additional information (inquiry@basco showerdoor.com).

Rotolo Lux - Model RTXH-905



No wall jambs
 for a more frameless look.

Features:

- Modern header rail with top rollers
- No wall jambs
- Exterior through-the-glass towel bar
- Interior pull knob
- Left or right configurations



Rotolo Lux Towel Bar features a rounded bar with mitered corners.

Rotolo "Zero Threshold" Lux - Model RZXH-905



All the features of the above PLUS:

- Includes center guide, drip vinyls and an optional half-moon dam instead of the usual curb

Unique to the Rotolo Lux Series, the "Zero-Threshold" Lux offers all the stylish features of the Rotolo Lux, with a no-barrier entry solution.

Rotolo Lux Optional Features

- **Additional towel bar - add \$132.** A single-sided towel bar can be added to the interior door panel in place of the knob.
- **Optional vertical pulls (with rounded corners) add \$165** - two 12" single-sided vertical pulls may be requested in place of the towel bar and knob.
- **Glass panel out-of-square - add \$87 each.**

Rotolo Lux Notes

- **Minimum of 2 3/4" curb width/threshold is required.**

Fillers - For best performance, Basco recommends the opening be square and plumb. Unit will accommodate up to 1/4" out-of-level before a curb filler is required. Out-of-plumb fillers are not available, so glass out-of-plumb beyond 5/16" will be cut to fit. Please refer to page 88 for part numbers and pricing.

Rotolo Zero Threshold Lux Optional Features

- **Additional towel bar - add \$132.** A single-sided towel bar can be added to the interior door panel in place of the knob.
- **Out-of-square glass panel - add \$87 each.** Maximum out-of-level is 3/16" for this model. Out-of-plumb fillers are not available, so glass will be cut to fit for out-of-plumb beyond 5/16". **Please note any out-of-square conditions.**

Rotolo Zero Threshold Lux Notes

- **Minimum of 3 3/8" curb width/threshold is required.**
- The drip vinyls and optional half-moon dam assist with water retention, but some water may escape the enclosure.



Easy quoting and ordering
 Assisted selling by model • Visual door drawing
 Dynamic pricing • Save and store

mystro.mybasco.com

To obtain a log-in, email
mystro@basco showerdoor.com

3/8" Frameless Bypass Tub/Shower - Clear (CL) Glass/Chrome (SV) Finish

Rotolo Lux Model	Fits Openings Between	Standard Height Options						Custom Size
		56"	57"	65 1/2"	70"	76"	80"	
RTXH-905-48	44" - 48"	\$2141	\$2181	\$2221	\$2261	\$2301	\$2344	For a custom width and/or height (max. 60"w x 80"h) \$2459
RTXH-905-52	48 1/16" - 52"	\$2163	\$2203	\$2243	\$2283	\$2321	\$2366	
RTXH-905-56	52 1/16" - 56"	\$2184	\$2224	\$2264	\$2304	\$2344	\$2387	
RTXH-905-60	56 1/16" - 60"	\$2207	\$2247	\$2287	\$2327	\$2366	\$2409	

*Specific finished height is required when ordering.
 A minimum curb width/threshold of 2 3/4" is required. Specify shower head side when ordering.*

3/8" Frameless Bypass Tub/Shower - Clear (CL) Glass/Chrome (SV) Finish

Rotolo ZeroThreshold Lux Model	Fits Openings Between	Standard Height Options						Custom Size
		56"	57"	65 1/2"	70"	76"	80"	
RZXH-905-48	44" - 48"	\$2141	\$2181	\$2221	\$2261	\$2301	\$2344	For a custom width and/or height (max. 60"w x 80"h) \$2459
RZXH-905-52	48 1/16" - 52"	\$2163	\$2203	\$2243	\$2283	\$2321	\$2366	
RZXH-905-56	52 1/16" - 56"	\$2184	\$2224	\$2264	\$2304	\$2344	\$2387	
RZXH-905-60	56 1/16" - 60"	\$2207	\$2247	\$2287	\$2327	\$2366	\$2409	

*Specific finished height is required when ordering.
 A minimum curb width/threshold of 3 3/8" is required. Specify shower head side when ordering.*



CLEAN THAT LASTS

Protect Your Investment.

Factory-applied AquaGlideXP is an ultra-protective coating that bonds to the glass, repelling moisture and soap film and is available with any glass option- **add \$200.**

3/8" Glass Options (Code)

Add \$0 Clear (CL)	Add \$200 AquaGlideXP Clear (XP)	Add \$301 Rain (RN), Silk (LK)	Add \$426 Pure Clear (PC)	Add \$426 ShowerGuard Clear (CG)	Add \$748 Pure Clear ShowerGuard (PG), Pure Silk (PS), Tempest (TM)
-----------------------	--	-----------------------------------	------------------------------	--	---

Rotolo Lux Finish Selections (Code)

Add \$0 Chrome (SV)	Add \$146 Brushed Nickel (BN), Oil Rubbed Bronze (OR), Matte Black (WI)
------------------------	--

Inline Configurations

3/8" Glass Semi-Frameless Bypass Tub/Shower ROTOLO

Rotolo - Model RTLH-905



Features:

- Modern header rail with top rollers
- Exterior through-the-glass towel bar
- Interior pull knob
- Left or right configurations



Rotolo towel bar features a rounded bar with rounded corners.

Rotolo with GridGlass - Model RTGA-905

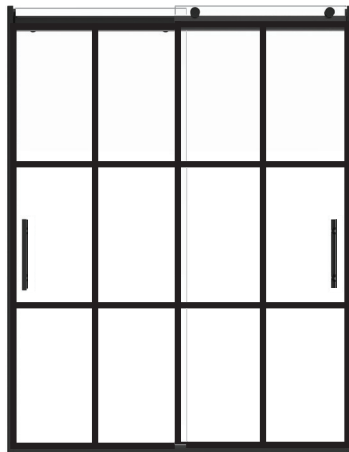

Through-the-Glass
12" Ladder Style
Pull Handle

Features:

- Modern header rail with top rollers
- Interior & exterior ladder pull (Dresden) handle

Optional Features

- **Additional towel bar** - add \$132. A single-sided towel bar can be added to the interior door panel in place of the knob. *(Not available with GridGlass unit).*
- **Optional vertical pulls** - add \$165. Two 12" single-sided vertical pulls may be requested in place of the towel bar and knob. *(Not available with GridGlass unit).*

Note

- Minimum of 2³/₄" curb width/threshold is required.

Fillers - For best performance, Basco recommends the opening be square and plumb. If the opening curb is out of level beyond 1/4" or walls are out of plumb beyond 3/8", purchase tapered fillers for proper fit. Please refer to page 88 for part numbers and pricing.

Rotolo with GridGlass Additional Notes

- **Custom grid is not available.** Available sizes are listed.
- **All sales are final** - non-returnable.
- **Extended lead times are required.** Contact Customer Service for details.



Easy quoting and ordering
 Assisted selling by model • Visual door drawing
 Dynamic pricing • Save and store
mystro.mybasco.com
 To obtain a log-in, email
 mystro@basco showerdoor.com

3/8" Semi-Frameless Bypass Tub/Shower - Clear (CL) Glass/Chrome (SV) Finish

Rotolo Model	Fits Openings Between	Standard Height Options						Custom Size
		56"	57"	65 1/2"	70"	76"	80"	
RTLH-905-48	44" - 48"	\$1703	\$1743	\$1783	\$1823	\$1856	\$1892	For a custom width and/or height (max. 60"w x 80"h) \$1996
RTLH-905-52	48 1/16" - 52"	\$1722	\$1762	\$1802	\$1842	\$1874	\$1910	
RTLH-905-56	52 1/16" - 56"	\$1739	\$1779	\$1819	\$1859	\$1892	\$1929	
RTLH-905-60	56 1/16" - 60"	\$1758	\$1798	\$1838	\$1878	\$1910	\$1946	

*Specific finished height is required when ordering.
 A minimum curb width/threshold of 2 3/4" is required. Specify shower head side when ordering.*

For RTLA-905 Standard Size Models, see pages 80 -81.

Glass Options (Code)

Add \$0 Clear (CL)	Add \$200 AquaGlideXP Clear (XP)	Add \$301 Rain (RN), Silk (LK)	Add \$426 Pure Clear (PC)	Add \$426 ShowerGuard Clear (CG)	Add \$748 Pure Clear ShowerGuard (PG), Pure Silk (PS), Tempest (TM)
-----------------------	-------------------------------------	-----------------------------------	------------------------------	-------------------------------------	---

Rotolo Finish Selections (Code)

Add \$0 Chrome (SV)	Add \$146 Brushed Nickel (BN), Oil Rubbed Bronze (OR), Matte Black (WI)	Add \$301 Brushed Gold (BG)
------------------------	--	--------------------------------

3/8" Semi-Frameless Bypass Shower with GridGlass - Clear (CL) Glass/Matte Black (WI) Finish

GridGlass Rotolo Model	Fits Openings Between	76" Height	GridGlass Rotolo Model	Fits Openings Between	76" Height
RTGA-905-4876	44" - 48"	\$2569	RTGA-905-6076	56" - 60"	\$2623
<ul style="list-style-type: none"> Available in Clear or AquaGlideXP Clear glass (XP adder applies) Available in Matte Black only 			<ul style="list-style-type: none"> Available in Clear or AquaGlideXP Clear glass (XP adder applies) Available in Matte Black only 		

A minimum curb width/threshold of 2 3/4" is required. Specify shower head side when ordering.

Glass Options (Code)

Add \$0 Clear (CL)	Add \$200 AquaGlideXP Clear (XP)
-----------------------	-------------------------------------



CLEAN THAT LASTS Protect Your Investment.
 Factory-applied AquaGlideXP is an ultra-protective coating that bonds to the glass, repelling moisture and soap film and is available with any glass option- **add \$200.**

Celesta - Model CELH-905

Formerly known as
2850/3850



Features:

- Euro style, curved, modern header
- Interior & exterior through-the-glass towel bars
- Through-the-glass roller brackets



Celesta towel bars features a rounded bar with rounded corners.

Optional Features

- Glass Panel Out-of-Square - add \$87 per panel.
- You may substitute single sided Celesta Handles or Celesta Knobs at no charge (shower head side is required).

Fillers - For best performance, Basco recommends the opening be square and plumb. If the opening curb if out of level beyond 1/4" or walls are out of level beyond 3/8", purchase tapered fillers for proper fit. Please refer to page 88 for part numbers and pricing.



Easy quoting and ordering
 Assisted selling by model • Visual door drawing
 Dynamic pricing • Save and store

mystro.mybasco.com

To obtain a log-in, email
 mystro@basco showerdoor.com

3/8" Semi-Frameless Bypass Tub/Shower - Clear (CL) Glass/Chrome (SV) Finish

Celesta Model	Fits Openings Between	Standard Height Options				Custom Size
		58 ¹ / ₄ "	64 ³ / ₄ "	71 ¹ / ₄ "	76"	
CELH-905-48	44" - 48"		\$1569	\$1679	\$1809	For a custom width and/or height (max. 72"w x 80"h)
CELH-905-56	52" - 56"	\$1563	\$1628	\$1737	\$1868	
CELH-905-60	56 ¹ / ₁₆ " - 60"	\$1577	\$1685	\$1794	\$1925	

Specific finished standard or custom height is required when ordering.

For CELA-905 Standard Size Models,
 (formerly known as 2850A/3850A)
 see pages 80 -81.



Protect Your Investment.

Factory-applied AquaGlideXP is an ultra-protective coating that bonds to the glass, repelling moisture and soap film and is available with any glass option- **add \$200.**

Glass Options (Code)

Add \$0 Clear (CL)	Add \$200 AquaGlideXP Clear (XP)	Add \$301 Rain (RN), Silk (LK)	Add \$426 Pure Clear (PC)	Add \$426 ShowerGuard Clear (CG)	Add \$748 Pure Clear ShowerGuard (PG), Pure Silk (PS), Tempest (TM)
------------------------------	---	--	-------------------------------------	---	--

Finish Selections (Code)

Add \$0 Chrome (SV)	Add \$146 Brushed Nickel (BN), Matte Black (WI) Oil Rubbed Bronze (OR)	Add \$301 Bronze (BR), Brushed Bronze (BB), Brushed Gold (BG), Satin Nickel (SN), White (WP)
-------------------------------	---	---

Inline Configurations

1/4" Glass Frameless & Semi-Frameless Bypass Tub/Shower

ROTOLO LUX, ROTOLO



Rotolo Lux - Model 5450 (Tub) / 5550 (Shower)



No wall jambs
for a more frameless look.

Features:

- Modern header rail with top rollers
- No wall jambs
- Exterior through-the-glass towel bar
- Interior pull knob
- Left or right configurations



Rotolo Lux towel bar features a rounded bar with mitered corners.

Rotolo - Model 5400 (Tub) / 5500 (Shower)



Features:

- Modern header rail with top rollers
- Exterior through-the-glass towel bar
- Interior pull knob
- Left or right configurations



Rotolo towel bar features a rounded bar with rounded corners.

Optional Features

- Additional towel bar - add \$132 (replaces pull knob)
- Glass Panel Out-of-Square - add \$87 per panel (Rotolo Lux model only)
- Optional vertical pulls (rounded corners) add \$165. Two 12" single-sided vertical pulls may be requested in place of the towel bar and knob.

Notes

- Minimum of 2³/₄" curb width/threshold is required.

Fillers - For best performance, Basco recommends the opening be square and plumb. Please refer to page 88 for part numbers and pricing. **Rotolo Lux** unit - if the opening curb is out of level beyond 1/4" purchase tapered filler for proper fit. Out-of-plumb fillers are not available, so glass out-of-plumb beyond 5/16" will be cut to fit. **Rotolo** unit - If the opening curb is out of level beyond 1/4" or walls are out of plumb beyond 3/8", purchase tapered fillers for proper fit.



Easy quoting and ordering
 Assisted selling by model • Visual door drawing
 Dynamic pricing • Save and store
mystro.mybasco.com
 To obtain a log-in, email
 mystro@bascohowerdoor.com

1/4" Frameless/Semi-Frameless Bypass Doors

1/4" Frameless Bypass Tub/Shower - Clear (CL) Glass/Chrome (SV) Finish

Rotolo Lux Model	Fits Openings Between	Standard Height Options			Custom Size
		56"	57"	65 1/2"	
5450-48	44" - 48"	\$1090	\$1104	\$1148	Custom width and/or height (max. 60"w x 80"h) Model 5550-00 \$1515
5450-52	48 1/16" - 52"	\$1104	\$1118	\$1301	
5450-56	52 1/16" - 56"	\$1118	\$1131	\$1315	
5450-60	56 1/16" - 60"	\$1148	\$1161	\$1343	
Rotolo Lux Model	Fits Openings Between	Standard Height Options			Custom Size
		65 1/2"	70"	76"	
5550-48	44" - 48"	\$1148	\$1161	\$1302	Model 5550-00 \$1515
5550-52	48 1/16" - 52"	\$1301	\$1315	\$1457	
5550-56	52 1/16" - 56"	\$1315	\$1329	\$1471	
5550-60	56 1/16" - 60"	\$1343	\$1356	\$1498	

*Specific finished height is required when ordering.
 A minimum curb width/threshold of 2 3/4" is required. Specify shower head side when ordering.*

1/4" Semi-Frameless Bypass Tub/Shower - Clear (CL) Glass/Chrome (SV) Finish

Rotolo Model	Fits Openings Between	Standard Height Options			Custom Size
		56"	57"	65 1/2"	
5400-48	44" - 48"	\$1023	\$1036	\$1080	Custom width and/or height (max. 60"w x 80"h) Model 5500-00 \$1447
5400-52	48 1/16" - 52"	\$1036	\$1050	\$1233	
5400-56	52 1/16" - 56"	\$1050	\$1065	\$1248	
5400-60	56 1/16" - 60"	\$1080	\$1094	\$1277	
Rotolo Model	Fits Openings Between	Standard Height Options			Custom Size
		65 1/2"	70"	76"	
5500-48	44" - 48"	\$1080	\$1094	\$1234	Model 5500-00 \$1447
5500-52	48 1/16" - 52"	\$1233	\$1248	\$1390	
5500-56	52 1/16" - 56"	\$1248	\$1261	\$1403	
5500-60	56 1/16" - 60"	\$1277	\$1290	\$1432	

*Specific finished height is required when ordering.
 A minimum curb width/threshold of 2 3/4" is required. Specify shower head side when ordering.*



Protect Your Investment.
 Factory-applied AquaGlideXP is an ultra-protective coating that bonds to the glass, repelling moisture and soap film and is available with any glass option- **add \$200.**

Glass Options (Code)

Add \$0 Clear (CL)	Add \$200 AquaGlideXP Clear (XP)	Add \$88 Obscure (OB), Rain (RN), Eclipse (EP)	Add \$182 Clear Etched (EE), Vessence (VS)	Add \$435 Silk (LK)	Add \$577 Tempest (TM), Fluted (FG), ShowerGuard Clear (CG)
------------------------------	---	---	---	-------------------------------	--

Finish Selections (Code)

Add \$0 Chrome (SV)	Add \$270 Brushed Nickel (BN), Oil Rubbed Bronze (OR), Matte Black (WI)	Add \$423 Brushed Gold* (BG)	<i>*Brushed Gold is limited to the Rotolo 5400/5500 model only.</i>
-------------------------------	---	--	---

Inline Configurations

Semi-Frameless Bypass Tub/Shower

INFINITY - 1/4" Glass

CLASSIC - 3/16" Glass



Infinity - Model 4400 (Tub) / 4500 (Shower)



Features:

- Euro style header
- Interior & exterior through-the-glass towel bars
- Through-the-glass roller bracket
- Available with an inline panel (pg. 28 - 29) or a return panel (pg. 70 - 71)

Classic - Model 3400 (Tub) / 3500 (Shower)



Features:

- Traditional style header
- Single exterior towel bar
- Reversible for left or right installation

Infinity Optional Features

- **Glass Panel Out-of-Square (Infinity only)** - add \$87 per panel
- **Pull handles** - add \$153. To replace Infinity towel bars with single-sided pull handles that match frame color (SC4570), specify at time of order. Showerhead side is required for pull handle option.
- **Knobs** - add \$57. To replace Infinity towel bars with knobs, specify at time of order.

Fillers - For best performance, Basco recommends the opening be square and plumb. If the opening curb is out of level beyond 1/4" or walls are out of level beyond 3/8", purchase tapered fillers for proper fit. Please refer to page 88 for part numbers and pricing.

1/4" Semi-Frameless Bypass Tub/Shower - Clear (CL) Glass/Chrome (SV) Finish

Infinity Model	Fits Openings Between	Standard Height Options			Custom Size
		56"	57"	65 1/2"	
4400-48	44" - 48"	\$902	\$915	-	For a custom width and/or height (max. 72"w x 80"h) Model 4500-OO \$1334
4400-52	48 1/16" - 52"	\$915	\$931	\$1115	
4400-56	52 1/16" - 56"	\$931	\$944	\$1132	
4400-60	54 1/2" - 58 1/2"	\$944	\$959	\$1145	
Infinity Model	Fits Openings Between	Standard Height Options			Custom Size
		65 1/2"	70"	76"	
4500-40	36" - 40"	\$931	\$944	\$1088	
4500-44	40 1/16" - 44"	\$944	\$959	\$1104	
4500-48	43" - 47"	\$959	\$973	\$1118	
4500-52	48" - 52"	\$1115	\$1132	\$1276	
4500-56	52 1/16" - 56"	\$1132	\$1145	\$1289	
4500-60	54 1/2" - 58 1/2"	\$1145	\$1161	\$1305	

Specific finished height is required when ordering.



Protect Your Investment.

Factory-applied AquaGlideXP is an ultra-protective coating that bonds to the glass, repelling moisture and soap film and is available with any glass option - add \$200.

Infinity Glass Options (Code)

Add \$0 Clear (CL)	Add \$200 AquaGlideXP Clear (XP)	Add \$88 Obscure (OB), Rain (RN), Eclipse (EP)	Add \$182 Clear Etched (EE), Vessence (VS)	Add \$435 Silk (LK)	Add \$577 Tempest (TM), Fluted (FG), ShowerGuard Clear (CG)
------------------------------	---	---	---	-------------------------------	--

Infinity Finish Selections (Code)

Add \$0 Chrome (SV)	Add \$270 Brushed Nickel (BN), Matte Black (WI) Oil Rubbed Bronze (OR)	Add \$423 Bronze (BR), Brushed Bronze (BB), Brushed Gold (BG), Satin Nickel (SN), White (WP)
-------------------------------	---	---

3/16" Semi-Frameless Bypass Tub/Shower - Clear (CL) Glass/Chrome (SV) Finish

Classic Model	Fits Openings Between	Standard Height Options			
		56"	57"	65 1/2"	70"
3400-56	52" - 56"	\$609	\$624	-	-
3400-60	56 1/16" - 60"	\$624	\$638	-	-
3500-40	36" - 40"	-	-	-	\$615
3500-44	40 1/16" - 44"	-	-	\$600	\$629
3500-48	43" - 47"	-	-	-	\$644
3500-56	52" - 56"	-	-	-	\$799
3500-60	56 1/16" - 60"	-	-	-	\$816

Customization not available. All available width and heights are shown. Please select from other collections for openings or heights other than those offered, or if AquaGlideXP protection is desired.

Specific standard height requested is required when ordering.

This model is not available for commercial applications and is for residential use only.

Classic Glass Options (Code)

Add \$0 Clear (CL)	Add \$44 Obscure (OB)
------------------------------	---------------------------------

Classic Finish Selections (Code)

Add \$0 Chrome (SV)	Add \$165 Brushed Nickel (BN) Oil Rubbed Bronze (OR)
-------------------------------	---

Inline Configurations

Framed Bypass Tub/Shower

DELUXE



Deluxe - Model 6150 (Tub) / 7150 (Shower)



Features:

- *Traditional style header*
- *Exterior & interior through-the-rail towel bars*

Optional Feature

- **Perfect Overlap** - add \$115 for the optimization of panel sizes to minimize panel overlap and maximize the walk through opening for any standard size bypass model.

Fillers - For best performance, Basco recommends the opening be square and plumb. If the opening curb is out of level beyond 1/4" or walls are out of level beyond 3/8", purchase tapered fillers for proper fit. Please refer to page 88 for part numbers and pricing.

Framed Bypass Tub/Shower, Clear (CL) Glass/Chrome (SV) Finish

Deluxe Model	Fits Openings Between	Standard Height Options			Custom Size
		56"	58 1/2"	64 1/2"	
6150-42	40" - 42"	\$580	\$594	\$680	For a custom width and/or height (max. 72" w x 80" h) Model 7150-00
6150-48	45" - 47"	\$594	\$609	\$737	
6150-50	48" - 50"	\$609	\$622	\$751	
6150-52	50 1/16" - 52"	\$622	\$637	\$764	
6150-54	52 1/16" - 54"	\$637	\$651	\$780	
6150-56	54 1/16" - 56"	\$651	\$666	\$793	
6150-60	57" - 59"	\$666	\$679	\$808	
6150-64	62" - 64"	\$735	\$750	\$906	
6150-66	64 1/16" - 66"	\$806	\$820	\$977	

Deluxe Model	Fits Openings Between	Standard Height Options			
		64 1/2"	68"	71 1/2"	76"
7150-40	38" - 40"	\$667	\$680	\$695	\$835
7150-42	40 1/16" - 42"	\$680	\$695	\$709	\$849
7150-44	42 1/16" - 44"	\$695	\$709	\$723	\$865
7150-46	43 3/4" - 45 3/4"	\$709	\$723	\$737	\$879
7150-48	45" - 47"	\$737	\$751	\$764	\$906
7150-52	50" - 52"	\$764	\$780	\$793	\$935
7150-54	52 1/16" - 54"	\$780	\$793	\$808	\$949
7150-56	54 1/16" - 56"	\$793	\$808	\$821	\$963
7150-60	57" - 59"	\$808	\$821	\$835	\$977

For a custom width and/or height (max. 72" w x 80" h)
Model 7150-00
\$1063
(Includes perfect overlap)

Specific height desired is required when ordering.



Factory-applied AquaGlideXP is an ultra-protective coating that bonds to the glass, repelling moisture and soap film and is available with any glass option- add \$200.

Glass Options (Code)

Add \$0 Clear (CL)	Add \$200 AquaGlideXP Clear (XP)	Add \$44 Obscure (OB)	Add \$88 Rain (RN) Eclipse (EP)	Add \$182 Clear Etched (EE), Vessence (VS)	Add \$435 Silk (LK)	Add \$577 Tempest (TM), Fluted (FG)
-----------------------	--	--------------------------	---------------------------------------	--	------------------------	---

Finish Selections (Code)

Add \$0 Chrome (SV)	Add \$248 Brushed Nickel (BN), Matte Black (WI) Oil Rubbed Bronze (OR)	Add \$358 Bronze (BR), Brushed Bronze (BB), Brushed Gold (BG), Satin Nickel (SN), White (WP)
------------------------	--	--

Inline Configurations

3/8" Glass Frameless Door & Fixed Panel CELESTA & DRESDEN

Celesta - Model CELN-935 (no header) / CELH-935 (header)

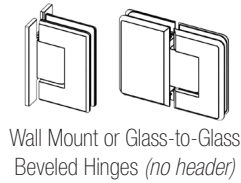

Optional
Back-to-Back
Knob
(May replace
pull handle at
no charge.)



Optional
Robe Hook
Add - \$61



Dresden - Model DREN-935 (no header) / DREH-935 (header)

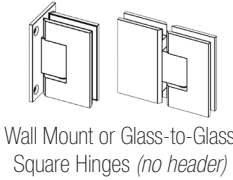
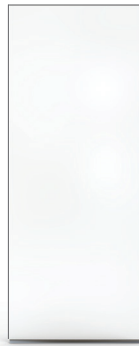

Optional
Back-to-Back
Knob
(May replace
pull handle at
no charge.)



Optional Features

- **Custom Height and/or Custom Door Width** - For any non-standard height, add \$250 to the next taller standard height. (For example, for a custom height of 74", add \$250 to the 76" height.) Use 84" height as base for anything greater than 84" tall up to 96" (max. 96"). Add \$250 for any exception to the standard 28" swing door width, either greater or smaller (maximum 36"). **Only one \$250 adder will be applied for a unit with both a custom door width and a custom height.**
- **Angled Ceiling or Floor to Ceiling** - add \$123, **Extra Panel or Transom** - add \$282 (ea), **Swing Out Only** (created by vinyl) or **1/2 Moon Dam** (SC889) - add \$43.
- **Upgrade to 1/2" glass** - add \$425/model. Limited to Clear, AquaGlideXP Clear, Silk, Pure Clear, Pure Silk, ShowerGuard Clear, or Pure Clear ShowerGuard glass
- **Heavy hinges, offset hinge plate on wall mount hinge, or offset closure angle on any hinge** - add \$80. **Adjustable hinges** - add \$120. **Additional standard hinge** (not required) - add \$244/ea. **Additional/non-standard clamp** (not required) - add \$173/unit. *Specify option when ordering.*

Notes

- Please note any **out-of-square conditions or notched panel** on drawing. *No additional charges apply.*
- Minimum stationary panel is 6" wide.
- **These models may require additional structural support.** When using wall mount hinges, 36" is the maximum panel width before a support bar is needed. Glass-to-glass hinges always require use of a support bar and minimum hinge panel size is 12". The number of hinges provided will be determined by the application. Adequate wall support (see pg. 86) is required.

Headerless Pivot Hinge Option

- Wall mount or glass-to-glass headerless pivot hinges require no header and position the hinges at the top and bottom of the glass (instead of vertically down the glass) providing the most frameless look possible.
- **Wall Mount pivot hinges** - add \$213 and note option when ordering
- **Glass-to-Glass pivot hinges** - add \$425 and note option when ordering. *Price includes 1/2" glass hinge panel upgrade and/or support pole if required.*
- Pivot hinge extends 5/8" above unit height.
- Units with glass-to-glass pivot hinges feature 3/8" glass door with 1/2" glass panel, and are only available in Clear, AquaGlideXP Clear, Silk, Pure Clear, Pure Silk, ShowerGuard Clear, or Pure Clear ShowerGuard glass options.





Easy quoting and ordering
Assisted selling by model • Visual door drawing
Dynamic pricing • Save and store

mystro.mybasco.com

To obtain a log-in, email
mystro@basco showerdoor.com

Features:

- 28" door with hinge cut-outs
- No Header (...**N**-935) or with Header (...**H**-935)
- Through-the-glass pull handle
- Wall mount or glass-to-glass hinges
- Left or right configurations

3/8" Frameless Swing Door & Single Panel

3/8" Frameless Door & Fixed Panel, Clear (CL) Glass/Chrome (SV) Finish

Celesta Model	Specify Width Between	Standard Door Width	Standard Height Options				Custom Size
			72"	76"	80"	84"	
CELN-935 (No Header)	Up to 44"	28"	\$1632	\$1655	\$1682	\$1706	For a custom height add \$250 to the next taller Standard Height price. For a custom door width , add \$250. <i>See notes for additional information & example.</i>
	44 ¹ / ₁₆ " - 52"	28"	\$1784	\$1808	\$1837	\$1865	
	52 ¹ / ₁₆ " - 60"	28"	\$1930	\$1961	\$1991	\$2022	
CELH-935 (Header)	60 ¹ / ₁₆ " - 68"	28"	\$2083	\$2115	\$2146	\$2179	
	68 ¹ / ₁₆ " - 76"	28"	\$2254	\$2289	\$2321	\$2358	
	76 ¹ / ₁₆ " - 84"	28"	\$2425	\$2464	\$2501	\$2537	
<i>Specific finished dimensions required when ordering.</i>	84 ¹ / ₁₆ " - 96"	28"	\$2732	\$2770	\$2806	\$2844	

Upgrade to 1/2" Glass - add \$425

For **CELA-935**
Standard Size Models,
see pages 82 -83.

3/8" Frameless Door & Fixed Panel, Clear (CL) Glass/Chrome (SV) Finish

Dresden Model	Specify Width Between	Standard Door Width	Standard Height Options				Custom Size
			72"	76"	80"	84"	
DREN-935 (No Header)	Up to 44"	28"	\$1757	\$1780	\$1807	\$1831	For a custom height add \$250 to the next taller Standard Height price. For a custom door width , add \$250. <i>See notes for additional information & example.</i>
	44 ¹ / ₁₆ " - 52"	28"	\$1909	\$1933	\$1962	\$1990	
	52 ¹ / ₁₆ " - 60"	28"	\$2055	\$2086	\$2116	\$2147	
DREH-935 (Header)	60 ¹ / ₁₆ " - 68"	28"	\$2208	\$2240	\$2271	\$2304	
	68 ¹ / ₁₆ " - 76"	28"	\$2379	\$2414	\$2446	\$2483	
	76 ¹ / ₁₆ " - 84"	28"	\$2550	\$2589	\$2626	\$2662	
<i>Specific finished dimensions required when ordering.</i>	84 ¹ / ₁₆ " - 96"	28"	\$2857	\$2895	\$2931	\$2969	

Upgrade to 1/2" Glass - add \$425



CLEAN THAT LASTS Protect Your Investment.

Factory-applied AquaGlideXP is an ultra-protective coating that bonds to the glass, repelling moisture and soap film and is available with any glass option- **add \$200.**

Glass Options (Code)

Add \$0 Clear (CL)	Add \$200 AquaGlideXP Clear (XP)	Add \$301 Rain* (RN), Silk (LK)	Add \$426 Pure Clear (PC)	Add \$426 ShowerGuard Clear (CG)	Add \$748 Pure Clear ShowerGuard (PG), Pure Silk (PS), Tempest* (TM)
-----------------------	--	------------------------------------	------------------------------	--	--

Please specify preferred panel position with all patterned glass options. *Rain & Tempest have a maximum unit height of 80".

Finish Selections (Code)

Add \$0 Chrome (SV)	Add \$146 Brushed Nickel (BN), Matte Black (WI), Oil Rubbed Bronze (OR)	Add \$301 Bronze (BR), Brushed Bronze (BB), Brushed Gold (BG), Satin Nickel (SN), White (WP), Polished Nickel (PN)
------------------------	---	--

*Polished Nickel is limited to select Celesta hardware only. Please contact Customer Service before ordering.

Inline Configurations

3/8" Glass Frameless Swing Door & Panel GEOLUX, TRESOR, VONSE & LUX

Geolux - Model GEON-935 (no header) / GEOH-935 (header)

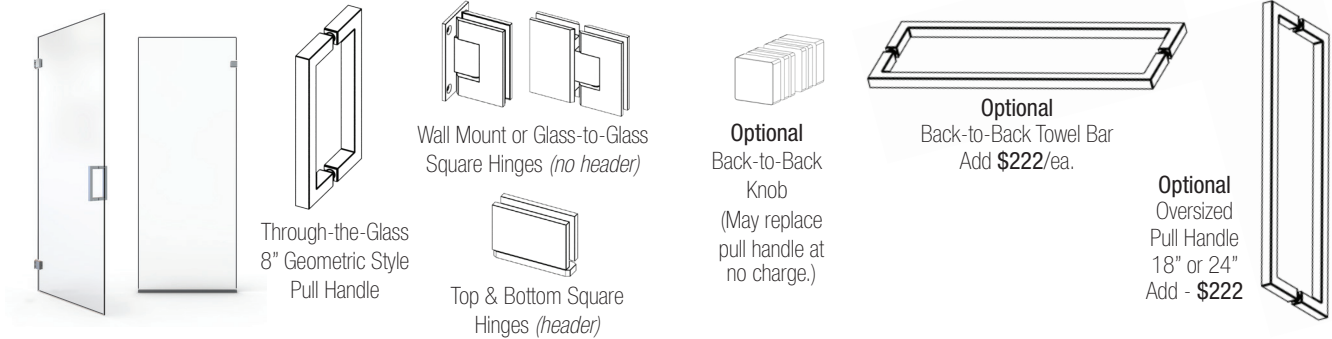

Tresor - Model TREN-935 (no header) / TREH-935 (header)

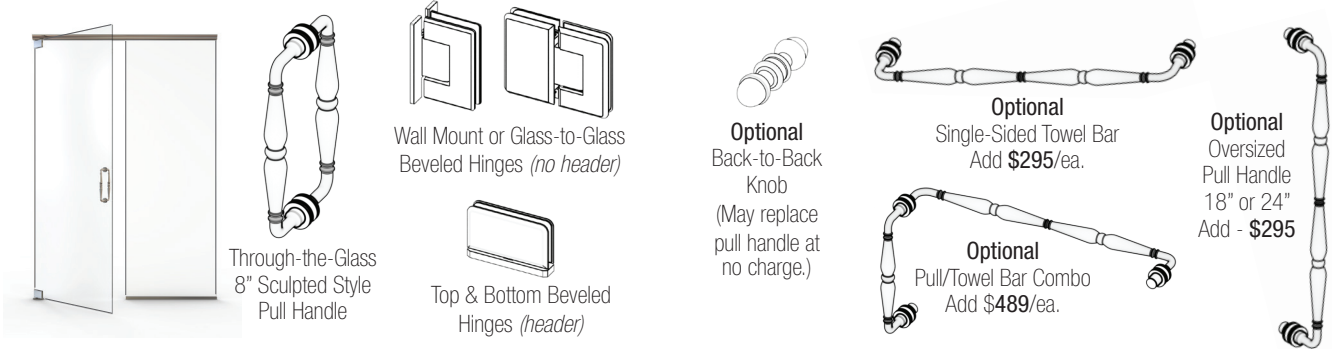

Vonse - Model VONN-935 (no header) / VONH-935 (header)

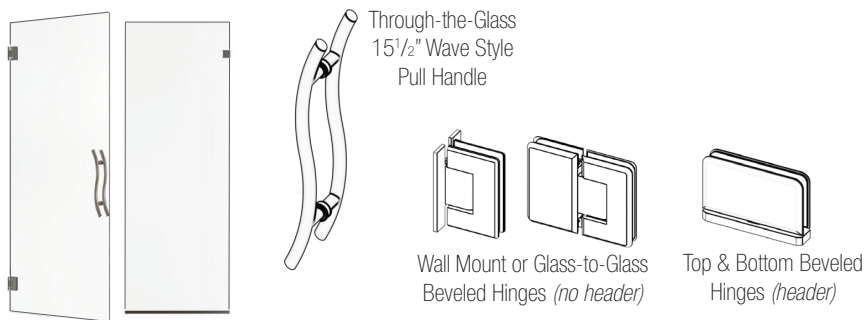

Lux - Model LUXN-935 (no header) / LUXH-935 (header)

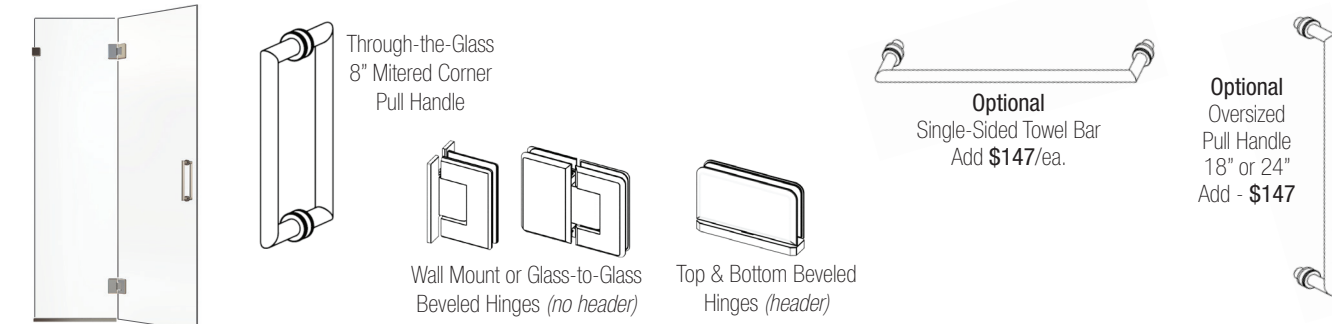



Easy quoting and ordering
Assisted selling by model • Visual door drawing
Dynamic pricing • Save and store

mystro.mybasco.com

To obtain a log-in, email
mystro@bascohowerdoor.com

Features:

- 28" door with hinge cut-outs
- No Header (...N-935) or with Header (...H-935)
- Through-the-glass pull handle
- Wall mount or glass-to-glass hinges
- Left or right configurations

3/8" Frameless Swing Door & Single Panel

3/8" Frameless Door & Fixed Panel, Clear (CL) Glass/Chrome (SV) Finish

Model Numbers	Specify Width Between	Standard Door Width	Standard Height Options				Custom Size
			72"	76"	80"	84"	
Geolux:	Up to 44"	28"	\$1832	\$1855	\$1882	\$1906	For a custom height add \$250 to the next taller Standard Height price. For a custom door width , add \$250. <i>See notes for additional information & example.</i>
GEON-935/GEOH-935	44 ¹ / ₁₆ " - 52"	28"	\$1984	\$2008	\$2037	\$2065	
Tresor:	52 ¹ / ₁₆ " - 60"	28"	\$2130	\$2161	\$2191	\$2222	
TREN-935/TREH-935	60 ¹ / ₁₆ " - 68"	28"	\$2283	\$2315	\$2346	\$2379	
Vonse:	68 ¹ / ₁₆ " - 76"	28"	\$2454	\$2489	\$2521	\$2558	
VONN-935/VONH-935	76 ¹ / ₁₆ " - 84"	28"	\$2625	\$2664	\$2701	\$2737	
Lux:	84 ¹ / ₁₆ " - 96"	28"	\$2932	\$2970	\$3006	\$3044	

Specific finished dimensions required when ordering.
Upgrade to 1/2" Glass - add \$425



Protect Your Investment.
Factory-applied AquaGlideXP is an ultra-protective coating that bonds to the glass, repelling moisture and soap film and is available with any glass option - **add \$200.**

Glass Options (Code)

Add \$0 Clear (CL)	Add \$200 AquaGlideXP Clear (XP)	Add \$301 Rain* (RN), Silk (LK)	Add \$426 Pure Clear (PC)	Add \$426 ShowerGuard Clear (CG)	Add \$748 Pure Clear ShowerGuard (PG), Pure Silk (PS), Tempest* (TM)
------------------------------	--	---	-------------------------------------	--	---

Please specify preferred panel position with all patterned glass options. *Rain & Tempest have a maximum unit height of 80".

Finish Selections (Code)

Add \$0 Chrome (SV)	Add \$146 Brushed Nickel (BN), Matte Black (WI) Oil Rubbed Bronze (OR)	Add \$301 Bronze (BR), Brushed Bronze (BB), Brushed Gold (BG), Satin Nickel (SN), White (WP)
-------------------------------	---	---

Optional Features

- **Custom Height and/or Custom Door Width** - For any non-standard height, add \$250 to the next taller standard height. (For example, for a custom height of 74", add \$250 to the 76" height.) Use 84" height as base for anything greater than 84" tall up to 96" (max. 96"). Add \$250 for any exception to the standard 28" swing door width, either greater or smaller (maximum 36"). **Only one \$250 adder will be applied for a unit with both a custom door width and a custom height.**
- **Angled Ceiling or Floor to Ceiling** - add \$123, **Extra Panel or Transom** - add \$282 (ea), **Swing Out Only** (created by vinyl) or **1/2 Moon Dam** (SC889) - add \$43.
- **Upgrade to 1/2" glass** - add \$425/model. Limited to Clear, AquaGlideXP Clear, Silk, Pure Clear, Pure Silk, ShowerGuard Clear, or Pure Clear ShowerGuard glass
- **Heavy hinges, offset hinge plate on wall mount hinge, or offset closure angle on any hinge** - add \$80. **Adjustable hinges** - add \$120. **Additional standard hinge** (not required) - add \$244/ea. **Additional/non-standard clamp** (not required) - add \$173/unit. Any of these options must be specified when ordering.

Notes

- Please note any **out-of-square conditions or notched panel** on drawing. *No additional charges apply.*
- Minimum stationary panel is 6" wide.
- **These models may require additional structural support.** When using wall mount hinges, 36" is the maximum panel width before a support bar is needed. Glass-to-glass hinges always require use of a support bar and minimum hinge panel size is 12". The number of hinges provided will be determined by the application. Adequate wall support (see pg. 86) is required.

Headerless Pivot Hinge Option

- Wall mount or glass-to-glass headerless pivot hinges require no header and position the hinges at the top and bottom of the glass (instead of vertically down the glass) providing the most frameless look possible.



- **Wall Mount pivot hinges** - add \$213 and note option when ordering
- **Glass-to-Glass pivot hinges** - add \$425 and note option when ordering. *Price includes 1/2" glass hinge panel upgrade and/or support pole if required.*
- Pivot hinge extends 5/8" above unit height.
- Units with glass-to-glass pivot hinges feature 3/8" glass door with 1/2" glass panel, and are only available in Clear, AquaGlideXP Clear, Silk, Pure Clear, Pure Silk, ShowerGuard Clear, or Pure Clear ShowerGuard glass options.

Inline Configurations

1/4" Glass Semi-Frameless Swing Door & Panel FUSION, INFINITY



Fusion - Model 1435



Features:

- Headerless
- 1/4" glass door & 3/8" glass panel
- Through-the-glass 6" pull handle
- Full length continuous hinge provides stability
- Left or right configuration

Infinity - Model 1413/1413NP



1413 Model - Includes center post. May hinge from either the wall or the center post.



1413NP Model - No center post. Wall hinge only.

Features:

- Euro style header
- Available with (1413) or without (1413NP) a center post.
- Through-the-glass 6" pull handle
- Full length continuous hinge provides stability
- Left or right configurations

Infinity Optional Features

- **Infinity C Pull/Towel Bar Combination - add \$82.** To substitute a C Pull/Towel Bar combination option, prefix the unit number with the letter (C). For example - C1415FGOR. Specify hinge side, left or right.
- **Single-Sided Towel Bar - add \$62.** Specify when ordering.
- **Buttress - add \$116 ea; Notched Panel - add \$174 ea.**
- **Quick 'N Stall - add \$82.** Limited to Clear, Obscure, Rain, Eclipse & Clear Etched glass options. Not available with no-post 1413NP model.
- **Glass Panel Out-of-Square - add \$87 per panel**

Fillers - For best performance, Basco recommends the opening be square and plumb. If the opening curb is out of level beyond 1/4" or walls are out of level beyond 3/8", purchase tapered fillers for proper fit. Please refer to page 89 for part numbers and pricing.

Fusion Optional Feature

- **Infinity C Pull/Towel Bar Combination - add \$82.** To substitute a C Pull/Towel Bar combination option, prefix the unit number with the letter (C). For example - C1415FGOR. Specify hinge side, left or right.
- **Single-Sided Towel Bar - add \$62.** Specify when ordering.
- **Notched Panel - add \$174 ea.**
- **Glass Panel Out-of-Square - add \$87 per panel**

Fusion Note

- No center post - wall hinge only.

1/4" Semi-Frameless Door & 3/8" Inline Panel, Clear (CL) Glass/Chrome (SV) Finish

Fusion Model	Specify Width Between	Standard Door Width	Standard Height Options				Custom Size
			63 ³ / ₈ "	66 ⁷ / ₈ "	70 ³ / ₈ "	74 ³ / ₈ "	
1435 <i>Specific finished dimensions required when ordering.</i>	36" - 40"	28 ⁷ / ₈ "	\$1185	\$1278	\$1389	\$1505	For a custom door size (max. 36") and/or custom width or height (max. 66" x 76") \$2044
	40 ¹ / ₁₆ " - 44"	28 ⁷ / ₈ "	\$1237	\$1330	\$1439	\$1557	
	44 ¹ / ₁₆ " - 48"	28 ⁷ / ₈ "	\$1289	\$1382	\$1491	\$1609	
	48 ¹ / ₁₆ " - 52"	28 ⁷ / ₈ "	\$1341	\$1435	\$1543	\$1661	
	52 ¹ / ₁₆ " - 56"	28 ⁷ / ₈ "	\$1393	\$1487	\$1596	\$1713	
	56 ¹ / ₁₆ " - 60"	28 ⁷ / ₈ "	\$1446	\$1539	\$1648	\$1765	

Fusion Glass Options (Code)

Add \$0 Clear (CL)	Add \$200 AquaGlideXP Clear (XP)	Add \$88 Rain (RN)	Add \$435 Silk (LK)	Add \$577 ShowerGuardClear (CG) Tempest (TM)
------------------------------	--	------------------------------	-------------------------------	---

Finish Selections (Code)

Add \$0 Chrome (SV)	Add \$270 Brushed Nickel (BN), Matte Black (Wl) Oil Rubbed Bronze (OR)	Add \$423 Bronze (BR), Brushed Bronze (BB), Brushed Gold (BG), Satin Nickel (SN), White (WP)
-------------------------------	---	---

1/4" Semi-Frameless Door & Inline Panel, Clear (CL) Glass/Chrome (SV) Finish

Infinity Model	Specify Width Between	Standard Door Width	Standard Height Options				Custom Size
			65 ¹ / ₈ "	68 ⁵ / ₈ "	72 ¹ / ₈ "	76 ¹ / ₈ "	
1413NP (No Center Post)	32" - 36"	24"	\$978	\$1109	\$1276	\$1417	For a custom door size (max. 36") and/or custom width or height (max. 72" x 84") \$1770
	36 ¹ / ₁₆ " - 40"	24"	\$993	\$1124	\$1290	\$1431	
1413 (Includes Center Post) <i>Specific finished dimensions required when ordering.</i>	40 ¹ / ₁₆ " - 44"	28 ⁷ / ₈ "	\$1006	\$1137	\$1304	\$1445	
	44 ¹ / ₁₆ " - 48"	28 ⁷ / ₈ "	\$1021	\$1151	\$1318	\$1459	
	48 ¹ / ₁₆ " - 52"	28 ⁷ / ₈ "	\$1034	\$1165	\$1331	\$1472	
	52 ¹ / ₁₆ " - 56"	28 ⁷ / ₈ "	\$1048	\$1179	\$1346	\$1487	
56 ¹ / ₁₆ " - 60"	28 ⁷ / ₈ "	\$1062	\$1193	\$1359	\$1500		

Infinity Glass Options (Code)

Add \$0 Clear (CL)	Add \$200 AquaGlideXP Clear (XP)	Add \$88 Obscure* (OB), Rain (RN)*, Eclipse (EP)	Add \$182 Clear Etched (EE), Vessence* (VS)	Add \$435 Silk (LK)	Add \$577 Tempest* (TM), Fluted* (FG), ShowerGuard Clear (CG)
------------------------------	--	---	--	-------------------------------	--

**Obscure, Rain, Vessence, Fluted & Tempest have a maximum unit height of 80".*

Finish Selections (Code)

Add \$0 Chrome (SV)	Add \$270 Brushed Nickel (BN), Matte Black (Wl) Oil Rubbed Bronze (OR)	Add \$423 Bronze (BR), Brushed Bronze (BB), Brushed Gold (BG), Satin Nickel (SN), White (WP)
-------------------------------	---	---



Protect Your Investment.

Factory-applied AquaGlideXP is an ultra-protective coating that bonds to the glass, repelling moisture and soap film and is available with any glass option - **add \$200.**

Inline Configurations

Framed Swing Door & Panel DELUXE



Deluxe - Model 135



Features:

- *Traditional style header*
- *Through-the-rail handle*
- *Full length continuous hinge provides stability*
- *Left or right configurations*

Optional Features

- **Deluxe Curved Towel Bar - add \$137.** To add a curved towel bar to any Deluxe Framed hinge door, prefix the unit number with the letter (T). For example - T135CLBR. Specify hinge side, left or right.
- **Buttress - add \$116 ea. Notched Panel - add \$174 ea.**
- **Quick 'N Stall - add \$82.** *Limited to Clear, Obscure, Rain, Eclipse & Clear Etched glass options.*
- **Modified for Steam -add \$44.**

Fillers - For best performance, Basco recommends the opening be square and plumb. If the opening curb is out of level beyond 1/4" or walls are out of level beyond 3/8", purchase tapered fillers for proper fit. Please refer to page 89 for part numbers and pricing.

Framed Door & Inline Panel, Clear (CL) Glass/Chrome (SV) Finish

Deluxe Model	Specify Width Between	Standard Door Width	Standard Height Options				Custom Height
			65 ¹ / ₈ "	68 ⁵ / ₈ "	72 ¹ / ₈ "	76 ¹ / ₈ "	
135 <i>Specific finished dimensions required when ordering.</i>	32" - 36"	24"	\$878	\$961	\$1279	\$1439	For a custom door size (max. 36") and/or custom width or height (max. 72" x 84") \$1600
	36 ¹ / ₁₆ " - 40"	24"	\$893	\$978	\$1297	\$1454	
	40 ¹ / ₁₆ " - 44"	28 ⁷ / ₈ "	\$911	\$994	\$1312	\$1472	
	44 ¹ / ₁₆ " - 48"	28 ⁷ / ₈ "	\$926	\$1010	\$1328	\$1487	
	48 ¹ / ₁₆ " - 52"	28 ⁷ / ₈ "	\$943	\$1025	\$1344	\$1503	
	52 ¹ / ₁₆ " - 56"	28 ⁷ / ₈ "	\$959	\$1042	\$1361	\$1519	
	56 ¹ / ₁₆ " - 60"	28 ⁷ / ₈ "	\$975	\$1057	\$1377	\$1535	

AQUAGLIDE^{XP}
CLEAN THAT LASTS

Protect Your Investment.

Factory-applied AquaGlideXP is an ultra-protective coating that bonds to the glass, repelling moisture and soap film and is available with any glass option- **add \$200.**

Glass Options (Code)

Add \$0 Clear (CL)	Add \$200 AquaGlideXP Clear (XP)	Add \$88 Obscure* (OB), Rain (RN)*, Eclipse (EP)	Add \$182 Clear Etched (EE), Vessence* (VS)	Add \$435 Silk (LK)	Add \$577 Tempest* (TM), Fluted* (FG)
------------------------------	--	---	--	-------------------------------	---

*Obscure, Rain, Vessence, Fluted & Tempest have a maximum unit height of 80".

Finish Selections (Code)

Add \$0 Chrome (SV)	Add \$270 Brushed Nickel (BN), Matte Black (WI) Oil Rubbed Bronze (OR)	Add \$423 Bronze (BR), Brushed Bronze (BB), Brushed Gold (BG), Satin Nickel (SN), White (WP)
-------------------------------	---	---

Inline Configurations

3/8" Glass Frameless Rolling door with Fixed Panel

ROLAIRE

Rolaire - Model ROLH-935



Features:

- Barn-door style, elevated header
- Exterior through-the-glass pull handle
- Interior pull knob
- Left or right configurations

Rolaire with GridGlass - Model ROGA-935



Features:

- Barn-door style, elevated header
- Exterior through-the-glass pull handle
- Interior pull knob
- Left or right configuration

Optional Feature

- **Optional towel bar** - add \$352/ea. An 18" towel bar can be added to the inside of the door panel or the outside stationary panel. You may substitute a knob instead of the handle for no additional cost. (Not available with GridGlass unit).

Notes

- Heights shown are to the top of the header. Add 3" for roller clearance.
- Minimum suggested width is 45". At this width, walk-through opening will be roughly 18¹⁵/₁₆".
- Please specify shower head side, as well as any out-of-plumb and/or out-of-level conditions to the 1/16 of an inch on drawing. Glass will be cut out of square to accommodate for any out-of-plumb/level condition. Maximum of 1/8" curb out-of-level conditions.

Rolaire with GridGlass Additional Notes

- Custom grid is not available. Available sizes are listed.
- All sales are final - non-returnable.
- Extended lead times are required. Contact Customer Service for details.



Easy quoting and ordering
 Assisted selling by model • Visual door drawing
 Dynamic pricing • Save and store

mystro.mybasco.com

To obtain a log-in, email
mystro@bascohowerdoor.com

3/8" Frameless Rolling Door/Fixed Panel - Clear (CL) Glass/Brushed Stainless Steel (BS) Finish

Rolaire Model	Specify Width Between	Standard Height Options			Custom Size
		72"	76"	80"	
ROLH-935 <i>Specific finished height is required when ordering.</i>	Up to 45"	\$2391	\$2421	\$2452	For a custom width and/or height (max.96" w x 80" h) \$3414
	45 ¹ / ₁₆ " - 52"	\$2497	\$2526	\$2556	
	52 ¹ / ₁₆ " - 60"	\$2601	\$2631	\$2662	
	60 ¹ / ₁₆ " - 68"	\$2707	\$2737	\$2766	
	68 ¹ / ₁₆ " - 73"	\$3062	\$3093	\$3123	
	73 ¹ / ₁₆ " - 84"	\$3183	\$3213	\$3242	
	84 ¹ / ₁₆ " - 96"	\$3303	\$3332	\$3364	

A minimum curb width/threshold & wall jamb width of 2³/₁₆" is required. Specify shower head side when ordering.

For ROLA-935 Standard Size Models, see pages 80 -81.

Glass Options (Code)

Add \$0 Clear (CL)	Add \$200 AquaGlideXP Clear (XP)	Add \$301 Rain (RN), Silk (LK)	Add \$426 Pure Clear (PC)	Add \$426 ShowerGuard Clear (CG)	Add \$748 Pure Clear ShowerGuard (PG), Pure Silk (PS), Tempest (TM)
------------------------------	--	--	-------------------------------------	--	--

Finish Selections (Code)

Add \$0 Brushed Stainless Steel (BS)	Add \$105 Polished Chrome (PM)	Add \$146 Matte Black (WI)
--	--	--------------------------------------

3/8" Frameless Rolling Door/Fixed Panel with GridGlass- Clear (CL) Glass/Matte Black (WI) Finish

GridGlass Rolaire Model	Fits Openings	76" Height	GridGlass Rolaire Model	Fits Openings	76" Height
ROGA-935-4776	45" - 47"	\$3026	ROGA-935-5976	57" - 59"	\$3130
<ul style="list-style-type: none"> • Door width is 26", Inline panel width is 22¹/₄" • Walk-through opening is 19" - 21" • Available in Clear or AquaGlideXP Clear glass • Available in Matte Black only 			<ul style="list-style-type: none"> • Door width is 32", Inline panel width is 28¹/₄" • Walk-through opening is 25" - 27" • Available in Clear or AquaGlideXP Clear glass • Available in Matte Black only 		

Glass Options (Code)

Add \$0 Clear (CL)	Add \$200 AquaGlideXP Clear (XP)
------------------------------	--



Protect Your Investment.

Factory-applied AquaGlideXP is an ultra-protective coating that bonds to the glass, repelling moisture and soap film and is available with any glass option- **add \$200.**

3/8" Frameless Rolling Door/Fixed Panel

Inline Configurations

1/4" Glass Semi-Frameless Bypass with Panel Tub/Shower INFINITY



Infinity - Model 4403 (Tub), 4503 (Shower)



Features:

- Euro style header
- Exterior & interior through-the-glass towel bars
- Through-the-glass roller brackets
- Custom inline panel - 24" maximum width

Optional Features

- **Glass Panel Out-of-Square** - add \$87 per panel
- **To substitute towel bars with single-sided pull handles**, add \$153 for aluminum pulls that matches frame color (SC4570) and specify at time of order. Showerhead side is required for pull handle option.
- **Knobs** - add \$57. To replace Infinity towel bars with knobs, specify at time of order.
- **Buttress** - add \$116 ea. **Notched Panel** - add \$174 ea.

Fillers - For best performance, Basco recommends the opening be square and plumb. If the opening curb is out of level beyond 1/4" or walls are out of level beyond 3/8", purchase tapered fillers for proper fit. Please refer to page 88 for part numbers and pricing.



Easy quoting and ordering
 Assisted selling by model • Visual door drawing
 Dynamic pricing • Save and store

mystro.mybasco.com

To obtain a log-in, email
mystro@basco showerdoor.com

**1/4" Semi-Frameless Bypass Tub/Shower with Inline Panel,
 Clear (CL) Glass/Chrome (SV) Finish**

Infinity Model	Fits Openings Up To	Sliding Door Width Range	Maximum Inline Panel Centerline	Standard Height Options		Custom Size
				57"	65 1/2"	
4403-48	72"	44" - 48"	24"	\$1767	\$1820	For a custom width and/or height (max. 96"w x 80"h) Model 4503-00 \$2143
4403-52	76"	48 1/16" - 52"	24"	\$1785	\$1841	
4403-56	80"	52 1/16" - 56"	24"	\$1805	\$1859	
4403-60	82 1/2"	54 1/2" - 58 1/2"	24"	\$1815	\$1869	

Infinity Model	Fits Openings Up To	Sliding Door Width Range	Maximum Inline Panel Centerline	Standard Height Options		
				65 1/2"	70"	76"
4503-40	64"	36" - 40"	24"	\$1781	\$1801	\$1930
4503-44	68"	40 1/16" - 44"	24"	\$1801	\$1820	\$1950
4503-48	71"	43" - 47"	24"	\$1820	\$1841	\$1969
4503-52	76"	48" - 52"	24"	\$1841	\$1859	\$1988
4503-56	80"	52 1/16" - 56"	24"	\$1859	\$1879	\$2008
4503-60	82 1/2"	54 1/2" - 58 1/2"	24"	\$1866	\$1884	\$2014

Desired bypass width, total finished width & height is required when ordering.

1/4" Semi-Frameless Bypass Doors with Panel



CLEAN THAT LASTS

Protect

Your Investment.

Factory-applied AquaGlideXP is an ultra-protective coating that bonds to the glass, repelling moisture and soap film and is available with any glass option - add \$300.

Glass Options (Code)

Add \$0 Clear (CL)	Add \$300 AquaGlideXP Clear (XP)	Add \$132 Obscure (OB), Rain (RN), Eclipse (EP)	Add \$258 Clear Etched (EE), Vessence (VS)	Add \$653 Silk (LK)	Add \$865 Tempest (TM), Fluted (FG), ShowerGuard Clear (CG)
------------------------------	--	--	---	-------------------------------	--

Finish Selections (Code)

Add \$0 Chrome (SV)	Add \$405 Brushed Nickel (BN), Matte Black (WI) Oil Rubbed Bronze (OR)	Add \$634 Bronze (BR), Brushed Bronze (BB), Brushed Gold (BG), Satin Nickel (SN), White (WP)
-------------------------------	---	---

Inline Configurations

3/8" Glass Frameless Single Swing Door CELESTA & DRESDEN

Celesta - Model CELN-900



Dresden - Model DREN-900

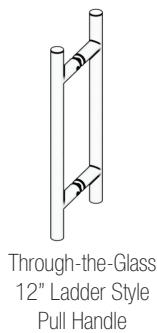

Optional Features

- **Custom Height** - For any non-standard height, add \$250 to the next taller standard height. (For example, for a custom height of 74", add \$250 to the 76" height.) Use 84" height as base for anything greater than 84" tall up to 96" (max. 96").
- **Angled Ceiling or Floor to Ceiling** - add \$123, **Transom** - add \$282 (ea), **Swing Out Only** (created by vinyl) or **1/2 Moon Dam** (SC889) - add \$43.
- **Upgrade to 1/2" glass** - add \$213/model. Limited to Clear, AquaGlideXP Clear, Silk, Pure Clear, Pure Silk, ShowerGuard Clear, or Pure Clear ShowerGuard glass
- **Heavy hinges, offset hinge plate on wall mount hinge, or offset closure angle on any hinge** - add \$80. **Adjustable hinges** - add \$120. **Additional standard hinge** (not required) - add \$244/ea. Any of these options must be specified when ordering.

Notes

- Please note any **out-of-square conditions** on drawing. *No additional charges apply.*
- Maximum door width is 36".

Headerless Wall Mount Pivot Hinge Option - add \$213

- Wall mount headerless pivot hinges require no header and position the hinges at the top and bottom of the glass (instead of vertically down the glass) providing the most frameless look possible. Note option when ordering.
- Pivot hinge extends 5/8" above unit height.





Easy quoting and ordering
 Assisted selling by model • Visual door drawing
 Dynamic pricing • Save and store

mystro.mybasco.com

To obtain a log-in, email
mystro@basco showerdoor.com

Features:

- Through-the-glass pull handle
- Wall mount hinges
- Left or right configurations

3/8" Frameless Swing Door, Clear (CL) Glass/Chrome (SV) Finish

Celesta Model	Specify Width Between	Standard Height Options							Custom Height
		60"	64"	68"	72"	76"	80"	84"	
CELN-900 <i>Specific finished dimensions required when ordering.</i>	Up to 20"	\$1081	\$1098	\$1121	\$1139	\$1156	\$1176	\$1193	For a custom height , add \$250 to the next taller Standard Height price. <i>See notes for additional information & example.</i>
	20 ¹ / ₁₆ " - 24"	\$1168	\$1186	\$1207	\$1224	\$1245	\$1264	\$1284	
	24 ¹ / ₁₆ " - 28"	\$1252	\$1272	\$1291	\$1311	\$1332	\$1351	\$1371	
	28 ¹ / ₁₆ " - 32"	\$1336	\$1356	\$1375	\$1398	\$1417	\$1439	\$1461	
	32 ¹ / ₁₆ " - 36"	\$1417	\$1439	\$1461	\$1483	\$1506	\$1528	\$1548	

Upgrade to 1/2" Glass - add \$213

3/8" Frameless Swing Door, Clear (CL) Glass/Chrome (SV) Finish

Dresden Model	Specify Width Between	Standard Height Options							Custom Height
		60"	64"	68"	72"	76"	80"	84"	
DREN-900 <i>Specific finished dimensions required when ordering.</i>	Up to 20"	\$1206	\$1223	\$1246	\$1264	\$1281	\$1301	\$1318	For a custom height , add \$250 to the next taller Standard Height price. <i>See notes for additional information & example.</i>
	20 ¹ / ₁₆ " - 24"	\$1293	\$1311	\$1332	\$1349	\$1370	\$1389	\$1409	
	24 ¹ / ₁₆ " - 28"	\$1377	\$1397	\$1416	\$1436	\$1457	\$1476	\$1496	
	28 ¹ / ₁₆ " - 32"	\$1461	\$1481	\$1500	\$1523	\$1542	\$1564	\$1586	
	32 ¹ / ₁₆ " - 36"	\$1542	\$1564	\$1586	\$1608	\$1631	\$1653	\$1673	

Upgrade to 1/2" Glass - add \$213



Protect Your Investment.

Factory-applied AquaGlideXP is an ultra-protective coating that bonds to the glass, repelling moisture and soap film and is available with any glass option- **add \$100.**

Glass Options (Code)

Add \$0 Clear (CL)	Add \$100 AquaGlideXP Clear (XP)	Add \$153 Rain* (RN), Silk (LK)	Add \$214 Pure Clear (PC)	Add \$214 ShowerGuard Clear (CG)	Add \$301 Pure Clear ShowerGuard (PG), Pure Silk (PS), Tempest* (TM)
------------------------------	--	---	-------------------------------------	--	---

**Rain & Tempest have a maximum unit height of 80".*

Finish Selections (Code)

Add \$0 Chrome (SV)	Add \$146 Brushed Nickel (BN), Matte Black (WL) Oil Rubbed Bronze (OR)	Add \$301 Bronze (BR), Brushed Bronze (BB), Brushed Gold (BG), Polished Nickel (PN), Satin Nickel (SN), White (WP)
-------------------------------	---	---

**Polished Nickel is limited to select Celesta hardware only. Please contact Customer Service before ordering.*

3/8" Frameless Single Swing Door

Inline Configurations

3/8" Glass Frameless Single Swing Door GEOLUX, TRESOR, VONSE & LUX

Geolux - Model GEON-900

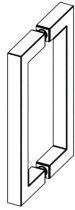

Through-the-Glass
8" Geometric Style
Pull Handle

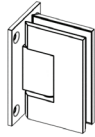

Wall Mount
Square Hinges



Optional
Back-to-Back
Knob
(May replace
pull handle at
no charge.)

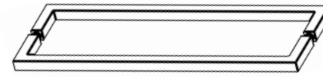

Optional
Back-to-Back Towel Bar
Add \$222/ea.

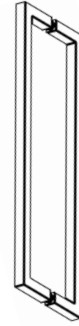

Optional
Oversized
Pull Handle
18" or 24"
Add - \$222

Tresor - Model TREN-900

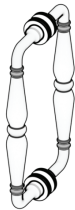

Through-the-Glass
8" Sculpted Style
Pull Handle



Wall Mount
Beveled Hinges



Optional
Back-to-Back
Knob
(May replace
pull handle at
no charge.)



Optional
Single-Sided Towel Bar
Add \$295/ea.



Optional
Oversized
Pull Handle
18" or 24"
Add - \$295



Optional
Pull/Towel Bar Combo
Add \$489/ea.

Vonse - Model VONN-900



Through-the-Glass
15 1/2" Wave Style
Pull Handle

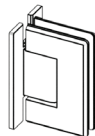

Wall Mount
Beveled Hinges

Lux - Model LUXN-900



Through-the-Glass
8" Mitered Corner
Pull Handle

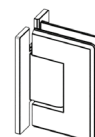

Wall Mount
Beveled Hinges



Optional
Single-Sided Towel Bar
Add \$147/ea.



Optional
Oversized
Pull Handle
18" or 24"
Add - \$147

Features:

- Through-the-glass pull handle
- Wall mount hinges
- Left or right configuration

Model	Specify Width Between	Standard Height Options							Custom Height
		60"	64"	68"	72"	76"	80"	84"	
Geolux:	Up to 20"	\$1281	\$1298	\$1321	\$1339	\$1356	\$1376	\$1393	For a custom height, add \$250 to the next taller Standard Height price. See notes for additional information & example.
GEON-900	20 ¹ / ₁₆ " - 24"	\$1368	\$1386	\$1407	\$1424	\$1445	\$1464	\$1484	
Tresor:	24 ¹ / ₁₆ " - 28"	\$1452	\$1472	\$1491	\$1511	\$1532	\$1551	\$1571	
TREN-900	28 ¹ / ₁₆ " - 32"	\$1536	\$1556	\$1575	\$1598	\$1617	\$1639	\$1661	
Vonse:	32 ¹ / ₁₆ " - 36"	\$1617	\$1639	\$1661	\$1683	\$1706	\$1728	\$1748	
VONN-900									
Lux:									
LUXN-900									

Specific finished dimensions required when ordering. **Upgrade to 1/2" Glass - add \$213**



Protect Your Investment.

Factory-applied AquaGlideXP is an ultra-protective coating that bonds to the glass, repelling moisture and soap film and is available with any glass option - **add \$100.**

Glass Options (Code)

Add \$0 Clear (CL)	Add \$100 AquaGlideXP Clear (XP)	Add \$153 Rain* (RN), Silk (LK)	Add \$214 Pure Clear (PC)	Add \$214 ShowerGuard Clear (CG)	Add \$301 Pure Clear ShowerGuard (PG), Pure Silk (PS), Tempest* (TM)
------------------------------	--	---	-------------------------------------	--	---

*Rain & Tempest have a maximum unit height of 80".

Finish Selections (Code)

Add \$0 Chrome (SV)	Add \$146 Brushed Nickel (BN), Matte Black (WI) Oil Rubbed Bronze (OR)	Add \$301 Bronze (BR), Brushed Bronze (BB), Brushed Gold (BG), Satin Nickel (SN), White (WP)
-------------------------------	---	---

Optional Features

- **Custom Height** - For any non-standard height, add \$250 to the next taller standard height. (For example, for a custom height of 74", add \$250 to the 76" height.) Use 84" height as base for anything greater than 84" tall up to 96" (max. 96").
- **Angled Ceiling or Floor to Ceiling** - add \$123, **Transom** - add \$282 (ea), **Swing Out Only** (created by vinyl) or **1/2 Moon Dam** (SC889) - add \$43.
- **Upgrade to 1/2" glass** - add \$213/model. Limited to Clear, AquaGlideXP Clear, Silk, Pure Clear, Pure Silk, ShowerGuard Clear, or Pure Clear ShowerGuard glass
- **Heavy hinges, offset hinge plate on wall mount hinge, or offset closure angle on any hinge** - add \$80. **Adjustable hinges** - add \$120. **Additional standard hinge** (not required) - add \$244/ea. Any of these options must be specified when ordering.

Notes

- Please note any **out-of-square conditions** on drawing. *No additional charges apply.*
- Maximum door width is 36".



Headerless Wall Mount Pivot Hinge Option - add \$213

- Wall mount headerless pivot hinges require no header and position the hinges at the top and bottom of the glass (instead of vertically down the glass) providing the most frameless look possible. Note option when ordering.
- Pivot hinge extends 5/8" above unit height.

Inline Configurations

Single Swing Door

INFINITY - 1/4" Glass Semi-Frameless

DELUXE - Framed



Infinity - Model 1400



Features:

- Contemporary style
- 6" Through-the-glass C-pull handle
- Magnetic latch secures the door
- Full length continuous hinge provides stability
- Reversible for left or right installation

Deluxe - Model 100



Features:

- Traditional style
- Full length magnetic closure
- Full length continuous hinge provides stability
- Reversible for left or right installation

Optional Features

- **Infinity C Pull/Towel Bar Combination - add \$82.** To substitute a C Pull/Towel Bar combination option, prefix the unit number with the letter (C). For example - C1400-28FGOR. Specify hinge side, left or right.
- **Infinity Single-Sided Towel Bar - add \$62.** Specify when ordering.
- **Deluxe Curved Towel Bar - add \$137** to add a curved towel bar to Deluxe doors. Prefix the unit number with the letter "T" (eg. T100-32CLSV).

Fillers - For best performance, Basco recommends the opening be square and plumb. If the opening curb is out of level beyond 1/4" or walls are out of level beyond 3/8", purchase tapered fillers for proper fit. Please refer to page 89 for part numbers and pricing.

1/4" Semi-Frameless Single Swing, Clear (CL) Glass/Chrome (SV) Finish

Infinity Model	Fits Openings Between	Standard Height Options				Infinity Model	Fits Openings Between	Standard Height Options			
		63 ¹ / ₂ "	67"	70 ¹ / ₂ "	74 ¹ / ₂ "			63 ¹ / ₂ "	67"	70 ¹ / ₂ "	74 ¹ / ₂ "
1400-21	20" - 21"	\$651	\$685	\$719	\$823	1400-29	28 ¹ / ₁₆ " - 29"	\$707	\$741	\$775	\$878
1400-22	21 ¹ / ₁₆ " - 22"	\$658	\$692	\$726	\$828	1400-30	29 ¹ / ₁₆ " - 30"	\$714	\$749	\$783	\$886
1400-23	22 ¹ / ₁₆ " - 23"	\$664	\$699	\$734	\$836	1400-31	30 ¹ / ₁₆ " - 31"	\$721	\$755	\$789	\$891
1400-24	23 ¹ / ₁₆ " - 24"	\$672	\$707	\$741	\$842	1400-32	31 ¹ / ₁₆ " - 32"	\$727	\$762	\$797	\$899
1400-25	24 ¹ / ₁₆ " - 25"	\$678	\$713	\$747	\$850	1400-33	32 ¹ / ₁₆ " - 33"	\$735	\$769	\$803	\$906
1400-26	25 ¹ / ₁₆ " - 26"	\$686	\$720	\$754	\$856	1400-34	33 ¹ / ₁₆ " - 34"	\$742	\$776	\$810	\$914
1400-27	26 ¹ / ₁₆ " - 27"	\$693	\$728	\$762	\$864	1400-35	34 ¹ / ₁₆ " - 35"	\$748	\$783	\$818	\$919
1400-28	27 ¹ / ₁₆ " - 28"	\$699	\$734	\$768	\$869	1400-36	35 ¹ / ₁₆ " - 36"	\$755	\$790	\$825	\$927

Custom Height For a custom height (max. 84") Model 1400-OO \$1037 *Specific finished height is required when ordering.*

Semi-Frameless/Framed Single Swing Door

Framed Single Swing, Clear (CL) Glass/Chrome (SV) Finish

Deluxe Model	Fits Openings Between	Standard Height Options				Custom Size	<i>Specific finished height is required when ordering.</i>
		63 ¹ / ₂ "	67"	70 ¹ / ₂ "	74 ¹ / ₂ "		
100-23	22 ³ / ₈ " - 23 ³ / ₈ "	\$528	\$613	\$683	\$770	For a custom width and/or height (max. 36 ³ / ₄ "w x 84"h) Model 100-OO \$897	
100-24	23 ³ / ₈ " - 24 ³ / ₈ "	\$539	\$619	\$693	\$781		
100-25	24 ¹ / ₂ " - 25 ¹ / ₂ "	\$547	\$630	\$702	\$790		
100-26	25 ⁷ / ₈ " - 26 ⁷ / ₈ "	\$556	\$640	\$712	\$797		
100-28	27 ³ / ₈ " - 28 ³ / ₈ "	\$575	\$656	\$728	\$816		
100-29	28 ⁷ / ₈ " - 29 ⁷ / ₈ "	\$581	\$664	\$735	\$826		
100-31	30 ³ / ₈ " - 31 ³ / ₈ "	\$599	\$682	\$754	\$842		
100-32	31 ¹ / ₈ " - 32 ¹ / ₈ "	\$608	\$691	\$763	\$851		
100-33	32 ³ / ₄ " - 33 ³ / ₄ "	\$626	\$699	\$770	\$859		
100-34	33 ³ / ₄ " - 34 ³ / ₄ "	\$636	\$709	\$781	\$868		
100-35	34 ³ / ₄ " - 35 ³ / ₄ "	\$644	\$717	\$790	\$877		
100-36	35 ³ / ₄ " - 36 ³ / ₄ "	\$652	\$726	\$797	\$885		

AQUAGLIDE^{XP}
CLEAN THAT LASTS

Protect Your Investment.

Factory-applied AquaGlideXP is an ultra-protective coating that bonds to the glass, repelling moisture and soap film and is available with any glass option- add \$100.

Glass Options (Code)

Add \$0 Clear (CL)	Add \$100 AquaGlideXP Clear (XP)	Add \$44 Obscure* (OB), Rain (RN)*, Eclipse (EP)	Add \$86 Clear Etched (EE), Vessence* (VS)	Add \$218 Silk (LK)	Add \$289 Tempest* (TM), Fluted* (FG), ShowerGuard Clear (CG)
------------------------------	--	---	---	-------------------------------	--

**Obscure, Rain, Vessence, Fluted & Tempest have a maximum unit height of 80". **ShowerGuard is only available for Infinity 1400 model.*

Finish Selections (Code)

Add \$0 Chrome (SV)	Add \$136 Brushed Nickel (BN), Matte Black (WI) Oil Rubbed Bronze (OR)	Add \$212 Bronze (BR), Brushed Bronze (BB), Brushed Gold (BG), Satin Nickel (SN), White (WP)
-------------------------------	---	---

Inline Configurations

1/4" Glass Semi-Frameless Bifold Door INFINITY



Infinity - Model 1433



Features:

- *Through-the-glass pull knob*
- *Full length continuous hinge provides stability*
- *Left or right configurations*

Fillers - For best performance, Basco recommends the opening be square and plumb. If the opening curb is out of level beyond 1/4" or walls are out of level beyond 3/8", purchase tapered fillers for proper fit. Please refer to page 89 for part numbers and pricing.



Easy quoting and ordering
 Assisted selling by model • Visual door drawing
 Dynamic pricing • Save and store

mystro.mybasco.com

To obtain a log-in, email
mystro@basco showerdoor.com

1/4" Semi-Frameless Bifold, Clear (CL) Glass/Chrome (SV) Finish

Bifold Model	Fits Openings Between	Standard Height Options			Custom Size
		68 ⁵ / ₈ "	72 ¹ / ₈ "	76 ¹ / ₈ "	
1433-29	28" - 29"	\$795	\$834	\$872	For a custom width and/or height (max. 36" w x 84" h) Model 1433-00 \$1178
1433-30	29 ¹ / ₁₆ " - 30"	\$803	\$842	\$880	
1433-31	30 ¹ / ₁₆ " - 31"	\$811	\$849	\$887	
1433-32	31 ¹ / ₁₆ " - 32"	\$818	\$857	\$896	
1433-33	32 ¹ / ₁₆ " - 33"	\$826	\$865	\$903	
1433-34	33 ¹ / ₁₆ " - 34"	\$835	\$873	\$911	
1433-35	34 ¹ / ₁₆ " - 35"	\$841	\$881	\$920	
1433-36	35 ¹ / ₁₆ " - 36"	\$850	\$889	\$928	

Specific finished height is required when ordering.

1/4" Semi-Frameless Bifold



CLEAN THAT LASTS

Protect

Your Investment.

Factory-applied AquaGlideXP is an ultra-protective coating that bonds to the glass, repelling moisture and soap film and is available with any glass option- **add \$200.**

Glass Options (Code)

Add \$0 Clear (CL)	Add \$200 AquaGlideXP Clear (XP)	Add \$88 Obscure* (OB), Rain (RN)*, Eclipse (EP)	Add \$182 Clear Etched (EE), Vessence* (VS)	Add \$435 Silk (LK)	Add \$577 Tempest* (TM), Fluted* (FG), ShowerGuard Clear (CG)
------------------------------	--	---	--	-------------------------------	--

**Obscure, Rain, Vessence, Fluted & Tempest have a maximum unit height of 80".*

Finish Selections (Code)

Add \$0 Chrome (SV)	Add \$136 Brushed Nickel (BN)
-------------------------------	---

Inline Configurations

Framed Steam Door & Top Panels DELUXE



Deluxe Steam - Model 18CS



Features:

- *Designed to keep the steam inside the shower*
- *Traditional style*
- *Full length magnetic closure*
- *Full length continuous hinge provides stability*



Optional Feature

- **Curved Towel Bar** - add \$137 to add a curved towel bar to Steam doors. Prefix the unit number with the letter "T" (eg. T18CS-32CLSV).

Fillers - For best performance, Basco recommends the opening be square and plumb. If the opening curb is out of level beyond 1/4" or walls are out of level beyond 3/8", purchase tapered fillers for proper fit. Please refer to page 89 for part numbers and pricing.



Easy quoting and ordering
 Assisted selling by model • Visual door drawing
 Dynamic pricing • Save and store

mystro.mybasco.com

To obtain a log-in, email
mystro@basco showerdoor.com

Framed Steam Single Swing, Clear (CL) Glass/Chrome (SV) Finish

Steam Model	Specify Width Between	Standard Height Options				Custom Size
		67"	70 ¹ / ₂ "	76"	80 ¹ / ₂ "	
18CS <i>Specific finished dimensions are required when ordering.</i>	20" - 24"	\$1025	\$1031	\$1039	\$1044	For a custom height (max. 36" w x 84" h) \$1253
	24 ¹ / ₁₆ " - 28"	\$1031	\$1039	\$1044	\$1051	
	28 ¹ / ₁₆ " - 32"	\$1039	\$1044	\$1051	\$1057	
	32 ¹ / ₁₆ " - 36"	\$1044	\$1051	\$1057	\$1064	

Framed Steam Swing Door & Transome Panels

Top Panel, Stationary/Fixed, Clear (CL) Glass/Chrome (SV) Finish

Stationary Model	Specify Width Between	Specify Height Between				
		4 ¹ / ₂ "-18"	18 ¹ / ₁₆ " - 36"	36 ¹ / ₁₆ " - 54"	54 ¹ / ₁₆ " - 72"	
400S	18" - 36"	\$463	\$470	\$476	\$490	<i>Specific finished dimensions are required when ordering. Minimum size 18" w x 4¹/₂" h.</i>
	36 ¹ / ₁₆ " - 54"	\$560	\$569	\$576	\$590	
	54 ¹ / ₁₆ " - 72"	\$661	\$666	\$675	\$689	

Top Panel, Hinged/Operable, Clear (CL) Glass/Chrome (SV) Finish

Hinged Model	Specify Width Between	Specify Height Between
400H	18" - 36"	5 ³ / ₄ " - 12"
		\$610

*Specific finished dimensions are required when ordering.
 Minimum size 18" W x 5³/₄" H. Maximum size 36" W x 12" H.
 Only available in Chrome & Brushed Nickel finish options.*



Protect Your Investment.

Factory-applied AquaGlideXP is an ultra-protective coating that bonds to the glass, repelling moisture and soap film and is available with any glass option- **add \$100.**

Glass Options (Code)

Add \$0 Clear (CL)	Add \$100 AquaGlideXP Clear (XP)	Add \$44 Obscure* (OB), Rain (RN)*, Eclipse (EP)	Add \$86 Clear Etched (EE), Vessence* (VS)	Add \$218 Silk (LK)	Add \$289 Tempest* (TM), Fluted* (FG)
------------------------------	--	---	---	-------------------------------	---

**Obscure, Rain, Vessence, Fluted & Tempest have a maximum unit height of 80".*

Finish Selections (Code)

Add \$0 Chrome (SV)	Add \$136 Brushed Nickel (BN), Matte Black (WI) Oil Rubbed Bronze (OR)	Add \$212 Bronze (BR), Brushed Bronze (BB), Brushed Gold (BG), Satin Nickel (SN), White (WP)
-------------------------------	---	---

Inline Configurations

Stationary Screens

CELESTA - 3/8" Glass Frameless

DELUXE - Framed

Celesta - Model CELN-910



Optional
Single-Sided Towel Bar
Add - \$74/ea.

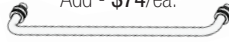

Optional
Back-to-Back Towel Bar
Add - \$191/ea

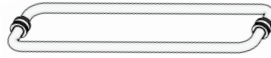

Optional
Robe Hook
Add - \$61



Features:

- Beveled top clamp with bottom U-channel



Deluxe - Model 410



Features:

- Framing on all four sides

Celesta Optional Features

- **Custom Height and/or Custom Width** - For any non-standard height, add \$250 to the next taller standard height. (For example, for a custom height of 74", add \$250 to the 76" height.) Add \$250 to the 36" width for a custom width greater than 36". *Only one \$250 adder will be applied for a unit with both a custom width and a custom height.*
- **Upgrade to 1/2" glass** - add \$213/model. Limited to Clear, AquaGlideXP Clear, Silk, Pure Clear, Pure Silk, ShowerGuard Clear, or Pure Clear ShowerGuard glass
- **Angled Ceiling or Floor to Ceiling** - add \$123, **14" Radius Corner** - add \$116 (ea)
- **Additional or non-standard clamps** (requested but not required) add \$173 per model.

Celesta Notes

- Please note any **out-of-square conditions** on drawing. *No additional charges apply.*

Deluxe Notes

- **Support bars** are included with all units and required to be used.



Easy quoting and ordering
Assisted selling by model • Visual door drawing
Dynamic pricing • Save and store

mystro.mybasco.com

To obtain a log-in, email
mystro@basco showerdoor.com

3/8" Frameless Stationary Screen, Clear (CL) Glass/Chrome (SV) Finish

Celesta Model	Specify Width Between	Standard Height Options				Custom Size
		68"	72"	76"	80"	
CELN-910 <i>Specific finished dimensions required when ordering.</i>	Up to 20"	\$870	\$891	\$910	\$926	For a custom width and/or custom height (max. 72" W x 96" H) \$1330
	20 ¹ / ₁₆ " - 24"	\$957	\$978	\$994	\$1015	
	24 ¹ / ₁₆ " - 28"	\$1042	\$1063	\$1083	\$1103	
	28 ¹ / ₁₆ " - 32"	\$1126	\$1148	\$1170	\$1190	
	32 ¹ / ₁₆ " - 36"	\$1211	\$1236	\$1256	\$1278	

Upgrade to 1/2" Glass - add \$213

Glass Options (Code)

Add \$0 Clear (CL)	Add \$100 AquaGlideXP Clear (XP)	Add \$153 Rain* (RN), Silk (LK)	Add \$214 Pure Clear (PC)	Add \$214 ShowerGuard Clear (CG)	Add \$301 Pure Clear ShowerGuard (PG), Pure Silk (PS), Tempest* (TM)
------------------------------	--	---	-------------------------------------	--	---

Finish Selections (Code)

Please specify preferred panel position with all patterned glass options. *Rain & Tempest have a maximum unit height of 80".

Add \$0 Chrome (SV)	Add \$146 Brushed Nickel (BN), Matte Black (WI) Oil Rubbed Bronze (OR)	Add \$301 Bronze (BR), Brushed Bronze (BB), Brushed Gold (BG), Satin Nickel (SN), White (WP)
-------------------------------	---	---

*Polished Nickel is limited to select Celesta hardware only. Please contact Customer Service before ordering.

Framed Stationary Panel, Clear (CL) Glass/Chrome (SV) Finish

Deluxe Model	Width	Standard Height Options		Custom Size	
		60"	76"		
410-24	24"	\$664	\$758	For a custom width and/or height (max. 36" W x 80" H) Model 410-00 \$828	<i>Specific finished height is required when ordering.</i>
410-30	30"	\$674	\$768		
410-36	36"	\$684	\$778		

Glass Options (Code)

Add \$0 Clear (CL)	Add \$100 AquaGlideXP Clear (XP)	Add \$44 Obscure* (OB), Rain (RN)*, Eclipse (EP)	Add \$86 Clear Etched (EE), Vessence* (VS)	Add \$218 Silk (LK)	Add \$289 Tempest* (TM), Fluted* (FG)
------------------------------	--	---	---	-------------------------------	---

Finish Selections (Code)

Add \$0 Chrome (SV)	Add \$136 Brushed Nickel (BN), Matte Black (WI) Oil Rubbed Bronze (OR)	Add \$212 Bronze (BR), Brushed Bronze (BB), Brushed Gold (BG), Satin Nickel (SN), White (WP)
-------------------------------	---	---



Protect
Your Investment.

Factory-applied AquaGlideXP is an ultra-protective coating that bonds to the glass, repelling moisture and soap film and is available with any glass option- **add \$100.**

Frameless & Framed
Fixed Screen Panel

Inline Configurations

3/8" Glass Frameless French Doors CELESTA & DRESDEN

Celesta - Model CELN-922 (no header) / CELH-922 (header)

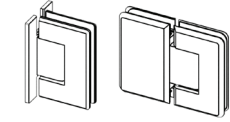

Wall Mount or Glass-to-Glass
Beveled Hinges (no header)



Top & Bottom Beveled
Hinges (header)



Optional
Back-to-Back
Knob
(May replace
pull handle at
no charge.)



Optional
Single-Sided Towel Bar
Add - \$74/ea.



Optional
Back-to-Back Towel Bar
Add - \$191/ea

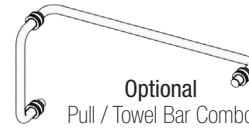

Optional
Pull / Towel Bar Combo
Add - \$108



Optional
Oversized
Pull Handle
12", 18" or 24"
Add - \$191



Optional
Robe Hook
Add - \$61

Dresden - Model DREN-922 (no header) / DREH-922 (header)

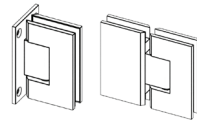
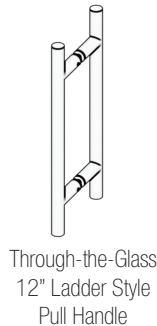

Wall Mount or Glass-to-Glass
Square Hinges (no header)



Top & Bottom Square
Hinges (header)



Optional
Back-to-Back
Knob
(May replace
pull handle at
no charge.)



Optional
Back-to-Back Towel Bar
Add - \$367/ea



Optional
Oversized
Pull Handle
18" or 24"
Add - \$367

Optional Features

- **Custom Height** - For any non-standard height, add \$250 to the next taller standard height. (For example, for a custom height of 74", add \$250 to the 76" height.) Use 84" height as base for anything greater than 84" tall up to 96" (max. 96").
- **Angled Ceiling or Floor to Ceiling** - add \$123, **Extra Panel or Transom** - add \$282 (ea), **Swing Out Only** (created by vinyl) or **1/2 Moon Dam** (SC889) - add \$43. To add **AquaGlideXP** to any additional panel - add \$100 ea.
- **Upgrade to 1/2" glass** - add \$425/model. Limited to Clear, AquaGlideXP Clear, Silk, Pure Clear, Pure Silk, ShowerGuard Clear, or Pure Clear ShowerGuard glass
- **Heavy hinges, offset hinge plate on wall mount hinge, or offset closure angle on any hinge** - add \$80. Specify when ordering.
- **Adjustable hinges** - add \$120. Specify when ordering.

Notes

- Please note any **out-of-square conditions**. *No additional charges apply.*
- The number of hinges provided will be determined by the application. Adequate wall support (see pg. 86) is required.



Easy quoting and ordering
Assisted selling by model • Visual door drawing
Dynamic pricing • Save and store

mystro.mybasco.com

To obtain a log-in, email
mystro@basco showerdoor.com

Features:

- No Header (...N-935) or with Header (...H-935)
- Two through-the-glass pull handles
- Wall mount hinges

3/8" Frameless French Doors, Clear (CL) Glass/Chrome (SV) Finish

Celesta Model	Specify Width Between	Standard Height Options				Custom Height
		72"	76"	80"	84"	
CELN-922 (No Header)	Up to 44"	\$1958	\$1987	\$2018	\$2046	For a custom height , add \$250 to the next taller Standard Height price. <i>See notes for additional information & example.</i> Maximum width for each door is 36".
	44 ¹ / ₁₆ " - 52"	\$2138	\$2172	\$2204	\$2236	
	52 ¹ / ₁₆ " - 60"	\$2319	\$2352	\$2389	\$2422	
CELH-922 (Header)	60 ¹ / ₁₆ " - 68"	\$2499	\$2536	\$2573	\$2613	
	68 ¹ / ₁₆ " - 72"	\$2703	\$2746	\$2788	\$2829	

Specific finished dimensions required when ordering. **Upgrade to 1/2" Glass - add \$425**

3/8" Frameless French Doors, Clear (CL) Glass/Chrome (SV) Finish

Dresden Model	Specify Width (A) Between	Standard Height Options				Custom Height
		72"	76"	80"	84"	
DREN-922 (No Header)	Up to 44"	\$2208	\$2237	\$2268	\$2296	For a custom height , add \$250 to the next taller Standard Height price. <i>See notes for additional information & example.</i> Maximum width for each door is 36".
	44 ¹ / ₁₆ " - 52"	\$2388	\$2422	\$2454	\$2486	
	52 ¹ / ₁₆ " - 60"	\$2569	\$2602	\$2639	\$2672	
DREH-922 (Header)	60 ¹ / ₁₆ " - 68"	\$2749	\$2786	\$2823	\$2863	
	68 ¹ / ₁₆ " - 72"	\$2953	\$2996	\$3038	\$3079	

Specific finished dimensions required when ordering. **Upgrade to 1/2" Glass - add \$425**



CLEAN THAT LASTS

Protect Your Investment.

Factory-applied AquaGlideXP is an ultra-protective coating that bonds to the glass, repelling moisture and soap film and is available with any glass option- **add \$200.**

Glass Options (Code)

Add \$0 Clear (CL)	Add \$200 AquaGlideXP Clear (XP)	Add \$301 Rain* (RN), Silk (LK)	Add \$426 Pure Clear (PC)	Add \$426 ShowerGuard Clear (CG)	Add \$748 Pure Clear ShowerGuard (PG), Pure Silk (PS), Tempest* (TM)
------------------------------	---	---	-------------------------------------	---	---

*Rain & Tempest have a maximum unit height of 80".

Finish Selections (Code)

Add \$0 Chrome (SV)	Add \$146 Brushed Nickel (BN), Matte Black (WI), Oil Rubbed Bronze (OR)	Add \$301 Bronze (BR), Brushed Bronze (BB), Brushed Gold (BG), Satin Nickel (SN), White (WP), Polished Nickel (PN)
-------------------------------	--	---

*Polished Nickel is limited to select Celesta hardware only. Please contact Customer Service before ordering.

3/8" Frameless
French Doors

Inline Configurations

3/8" Glass Frameless French Doors GEOLUX, TRESOR, VONSE & LUX

Geolux - Model GEON-922 (no header) / GEOH-922 (header)

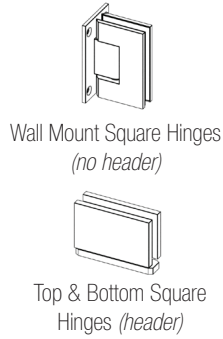
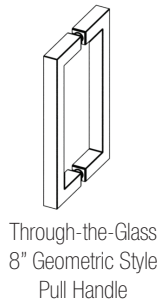

Optional
Back-to-Back
Knob
(May replace
pull handle at
no charge.)

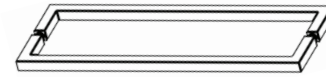

Optional
Back-to-Back Towel Bar
Add \$222/ea.

Optional
Oversized
Pull Handle
18" or 24"
Add - \$222

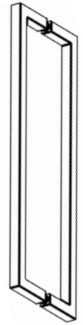

Tresor - Model TREN-922 (no header) / TREH-922 (header)

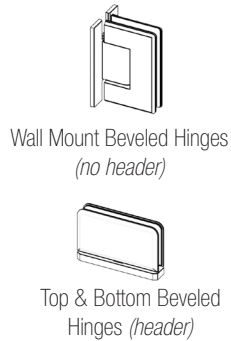
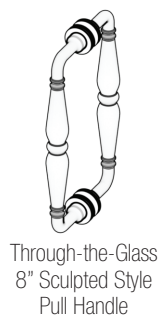

Optional
Back-to-Back
Knob
(May replace
pull handle at
no charge.)



Optional
Single-Sided Towel Bar
Add \$295/ea.



Optional
Pull/Towel Bar Combo
Add \$489/ea.



Optional
Oversized
Pull Handle
18" or 24"
Add - \$295

Vonse - Model VONN-922 (no header) / VONH-922 (header)

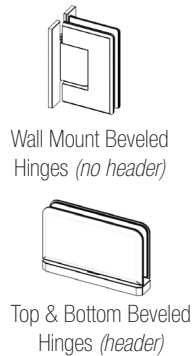
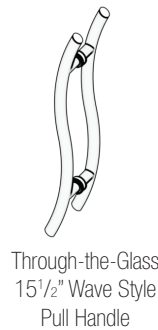

Lux - Model LUXN-922 (no header) / LUXH-922 (header)

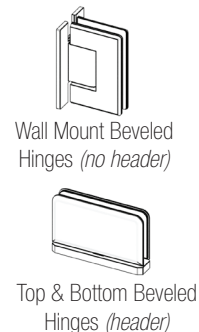

Optional
Single-Sided Towel Bar
Add \$147/ea.

Optional
Oversized
Pull Handle
18" or 24"
Add - \$147

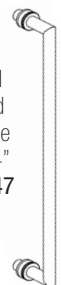



Easy quoting and ordering
 Assisted selling by model • Visual door drawing
 Dynamic pricing • Save and store

mystro.mybasco.com

To obtain a log-in, email
mystro@basco showerdoor.com

Features:

- No Header (...N-935) or with Header (...H-935)
- Two through-the-glass pull handles
- Wall mount hinges

Model Numbers	Specify Width Between	Standard Height Options				Custom Height
		72"	76"	80"	84"	
Geolux: GEON-922/GEOH-922	Up to 44"	\$2358	\$2387	\$2418	\$2446	For a custom height , add \$250 to the next taller Standard Height price. <i>See notes for additional information & example.</i> Maximum width for each door is 36".
Tresor: TREN-922/TREH-922	44 ¹ / ₁₆ " - 52"	\$2538	\$2572	\$2604	\$2636	
Vonse: VONN-922/VONH-922	52 ¹ / ₁₆ " - 60"	\$2719	\$2752	\$2789	\$2822	
Lux: LUXN-922/LUXH-922	60 ¹ / ₁₆ " - 68"	\$2899	\$2936	\$2973	\$3013	
	68 ¹ / ₁₆ " - 72"	\$3103	\$3146	\$3188	\$3229	

Specific finished dimensions required when ordering. **Upgrade to 1/2" Glass - add \$425**



Protect Your Investment.

Factory-applied AquaGlideXP is an ultra-protective coating that bonds to the glass, repelling moisture and soap film and is available with any glass option - **add \$200.**

Glass Options (Code)

Add \$0 Clear (CL)	Add \$200 AquaGlideXP Clear (XP)	Add \$301 Rain* (RN), Silk (LK)	Add \$426 Pure Clear (PC)	Add \$426 ShowerGuard Clear (CG)	Add \$748 Pure Clear ShowerGuard (PG), Pure Silk (PS), Tempest* (TM)
------------------------------	--	---	-------------------------------------	--	---

*Rain & Tempest have a maximum unit height of 80".

Finish Selections (Code)

Add \$0 Chrome (SV)	Add \$146 Brushed Nickel (BN), Matte Black (WI) Oil Rubbed Bronze (OR)	Add \$301 Bronze (BR), Brushed Bronze (BB), Brushed Gold (BG), Satin Nickel (SN), White (WP)
-------------------------------	---	---

Optional Features

- **Custom Height** - For any non-standard height, add \$250 to the next taller standard height. (For example, for a custom height of 74", add \$250 to the 76" height.) Use 84" height as base for anything greater than 84" tall up to 96" (max. 96").
- **Angled Ceiling or Floor to Ceiling** - add \$123, **Extra Panel or Transom** - add \$282 (ea), **Swing Out Only** (created by vinyl) or **1/2 Moon Dam** (SC889) - add \$43. To add AquaGlideXP to any additional panel - add \$100 ea.
- **Upgrade to 1/2" glass** - add \$425/model. Limited to Clear, AquaGlideXP Clear, Silk, Pure Clear, Pure Silk, ShowerGuard Clear, or Pure Clear ShowerGuard glass
- **Heavy hinges, offset hinge plate on wall mount hinge, or offset closure angle on any hinge** - add \$80. Specify when ordering.
- **Adjustable hinges** - add \$120. Specify when ordering.

Notes

- Please note any **out-of-square conditions**. No additional charges apply.
- The number of hinges provided will be determined by the application. Adequate wall support is required (see pg. 86).

Inline Configurations

1/4" Glass Semi-Frameless French Doors Tub/Shower INFINITY



Infinity - Model 1022 (Tub), 1422 (Shower)



Features:

- Contemporary rounded header
- Two through-the-glass 6" pull handles
- Full length continuous hinge provides stability
- 1022 tub includes higher threshold curb (SC915)

Optional Features

- **Infinity C Pull/Towel Bar Combination - add \$82 ea.** To substitute a C Pull/Towel Bar combination option, prefix the unit number with the letter (C). For example - C1422FGOR. Specify hinge side, left or right.
- **Single-Sided Towel Bar - add \$ 62.** To substitute, specify when ordering.
- **Extra Panel - add \$116 ea.** To add AquaGlideXP to any additional panel - add \$100 ea.
- **Glass Panel Out-of-Square - add \$87 per panel**
- **Optional Curb (SCX915) - add \$79 ea.** (adds 7/16" to the height). For applications requiring a higher threshold to accommodate fiberglass or acrylic modulares with radius corners or for out of level conditions, prefix the unit number with the letter (R). For example - R1422FGOR.

Fillers - For best performance, Basco recommends the opening be square and plumb. If the opening curb is out of level beyond 1/4" or walls are out of level beyond 3/8", purchase tapered fillers for proper fit. Please refer to page 89 for part numbers and pricing.



Easy quoting and ordering
 Assisted selling by model • Visual door drawing
 Dynamic pricing • Save and store

mystro.mybasco.com

To obtain a log-in, email
mystro@basco showerdoor.com

1/4" Semi-Frameless French Doors Tub/Shower, Clear (CL) Glass/Chrome (SV) Finish

Infinity Model	Specify Width Between	Standard Height Options				Custom Size
		57"	65"			
1022	48" - 60"	\$1325	\$1338			For custom height (Maximum 84") Model 1422-00 \$1916 Maximum width for each door is 36".
Infinity Model	Specify Width Between	65"	Standard Height Options			
1422	24" - 36"	\$1310	\$1325	\$1654	\$1811	
	36 ¹ / ₁₆ " - 48"	\$1325	\$1338	\$1668	\$1825	
	48 ¹ / ₁₆ " - 60"	\$1338	\$1352	\$1683	\$1839	
	60 ¹ / ₁₆ " - 72"	\$1352	\$1366	\$1696	\$1854	

Specific finished dimensions required when ordering.

1/4" Semi-Frameless French Doors



CLEAN THAT LASTS

Protect

Your Investment.

Factory-applied AquaGlideXP is an ultra-protective coating that bonds to the glass, repelling moisture and soap film and is available with any glass option- **add \$200.**

Glass Options (Code)

Add \$0 Clear (CL)	Add \$200 AquaGlideXP Clear (XP)	Add \$88 Obscure* (OB), Rain (RN)*, Eclipse (EP)	Add \$182 Clear Etched (EE), Vessence* (VS)	Add \$435 Silk (LK)	Add \$577 Tempest* (TM), Fluted* (FG), ShowerGuard Clear (CG)
------------------------------	--	---	--	-------------------------------	--

**Obscure, Rain, Vessence, Fluted & Tempest have a maximum unit height of 80".*

Finish Selections (Code)

Add \$0 Chrome (SV)	Add \$270 Brushed Nickel (BN), Matte Black (WI) Oil Rubbed Bronze (OR)	Add \$423 Bronze (BR), Brushed Bronze (BB), Brushed Gold (BG), Satin Nickel (SN), White (WP)
-------------------------------	---	---

Inline Configurations

3/8" Glass Frameless Panel/Door/Panel CELESTA & DRESDEN

Celesta - Model CELN-925 (no header) / CELH-925 (header)

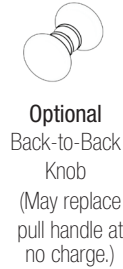
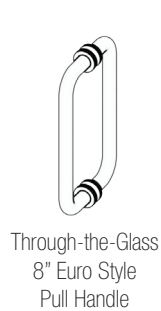

Dresden - Model DREN-925 (no header) / DREH-925 (header)

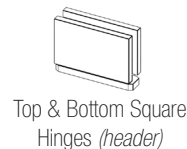
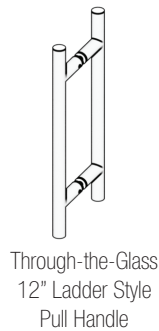
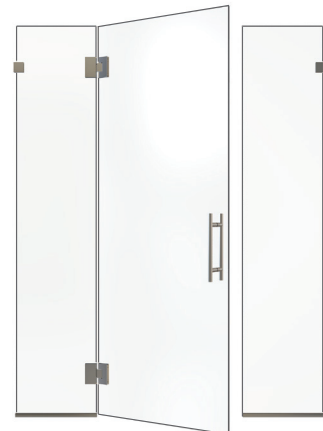

Optional Features

- **Custom Height and/or Custom Door Width** - For any non-standard height, add \$250 to the next taller standard height. (For example, for a custom height of 74", add \$250 to the 76" height.) Use 84" height as base for anything greater than 84" tall up to 96" (max. 96"). Add \$250 for any exception to the standard 28" swing door width, either greater or smaller (maximum 36"). *Only one \$250 adder will be applied for a unit with both a custom door width and a custom height.*
- **Angled Ceiling or Floor to Ceiling** - add \$123, **Extra Panel or Transom** - add \$282 (ea), **Swing Out Only** (created by vinyl) or **1/2 Moon Dam** (SC889) - add \$43, **AquaGlideXP to any additional panel** - add \$100 ea.
- **Upgrade to 1/2" glass** - add \$637/model. Limited to Clear, AquaGlideXP Clear, Silk, Pure Clear, Pure Silk, ShowerGuard Clear, or Pure Clear ShowerGuard glass
- **Heavy hinges, offset hinge plate on wall mount hinge, or offset closure angle on any hinge** - add \$80. Specify when ordering. **Adjustable hinges** - add \$120. **Additional standard hinge** (not required) - add \$244/ea. **Additional/non-standard clamp** (not required) - add \$345/unit. Any of these options must be specified when ordering.

Notes

- Please note any **out-of-square conditions** or **notched panel** on drawing. *No additional charges apply.*
- Minimum stationary panel is 6" wide.
- **Headerless models may require additional structural support.** When using wall mount hinges, 36" is the maximum panel width before a support bar is needed. Glass-to-glass hinges always require use of a support bar and minimum hinge panel size is 12". The number of hinges provided will be determined by the application. Adequate wall support is required (see pg. 86).

Headerless Pivot Hinge Option

- Wall mount or glass-to-glass headerless pivot hinges require no header and position the hinges at the top and bottom of the glass (instead of vertically down the glass) providing the most frameless look possible.
- **Wall Mount pivot hinges** - add \$213 and note option when ordering
- **Glass-to-Glass pivot hinges** - add \$425 and note option when ordering. *Price includes 1/2" glass hinge panel upgrade and/or support pole if required.*
- Pivot hinge extends 5/8" above unit height.
- Units with glass-to-glass pivot hinges feature 3/8" glass door with 1/2" glass panel, and are only available in Clear, AquaGlideXP Clear, Silk, Pure Clear, Pure Silk, ShowerGuard Clear, or Pure Clear ShowerGuard glass options.





Easy quoting and ordering
Assisted selling by model • Visual door drawing
Dynamic pricing • Save and store

mystro.mybasco.com

To obtain a log-in, email
mystro@basco showerdoor.com

Features:

- No Header (...N-925) or with Header (...H-925)
- Through-the-glass pull handle
- Glass-to-glass hinges
- Left or right configurations

3/8" Frameless Panel/Door/Panel, Clear (CL) Glass/Chrome (SV) Finish

Celesta Model	Specify Width Between	Standard Door Width	Standard Height Options				Custom Size
			72"	76"	80"	84"	
CELN-925 (No Header)	Up to 44"	28"	\$1958	\$1987	\$2018	\$2046	For a custom height add \$250 to the next taller Standard Height price. For a custom door width add \$250. <i>See notes for additional information & example.</i>
	44 ¹ / ₁₆ " - 52"	28"	\$2138	\$2172	\$2204	\$2236	
	52 ¹ / ₁₆ " - 60"	28"	\$2319	\$2352	\$2389	\$2422	
CE LH-925 (Header)	60 ¹ / ₁₆ " - 68"	28"	\$2499	\$2536	\$2573	\$2613	
	68 ¹ / ₁₆ " - 76"	28"	\$2703	\$2746	\$2788	\$2829	
	76 ¹ / ₁₆ " - 84"	28"	\$2909	\$2956	\$2999	\$3045	
	84 ¹ / ₁₆ " - 96"	28"	\$3255	\$3299	\$3345	\$3388	
<i>Specific finished dimensions required when ordering.</i>	*96 ¹ / ₁₆ " - 120"	28"	\$3601	\$3642	\$3691	\$3731	

Upgrade to 1/2" Glass - add \$637

*At this width, a header (model CELH-925) is required.

3/8" Frameless Panel/Door/Panel, Clear (CL) Glass/Chrome (SV) Finish

Dresden Model	Specify Width Between	Standard Door Width	Standard Height Options				Custom Size
			72"	76"	80"	84"	
DREN-925 (No Header)	Up to 44"	28"	\$2083	\$2112	\$2143	\$2171	For a custom height add \$250 to the next taller Standard Height price. For a custom door width add \$250. <i>See notes for additional information & example.</i>
	44 ¹ / ₁₆ " - 52"	28"	\$2263	\$2297	\$2329	\$2361	
	52 ¹ / ₁₆ " - 60"	28"	\$2444	\$2477	\$2514	\$2547	
DREH-925 (Header)	60 ¹ / ₁₆ " - 68"	28"	\$2624	\$2661	\$2698	\$2738	
	68 ¹ / ₁₆ " - 76"	28"	\$2828	\$2871	\$2913	\$2954	
	76 ¹ / ₁₆ " - 84"	28"	\$3034	\$3081	\$3124	\$3170	
	84 ¹ / ₁₆ " - 96"	28"	\$3380	\$3424	\$3470	\$3513	
<i>Specific finished dimensions required when ordering.</i>	*96 ¹ / ₁₆ " - 120"	28"	\$3726	\$3767	\$3816	\$3856	

Upgrade to 1/2" Glass - add \$637

*At this width, a header (model DREH-925) is required.



CLEAN THAT LASTS

Protect Your Investment.

Factory-applied AquaGlideXP is an ultra-protective coating that bonds to the glass, repelling moisture and soap film and is available with any glass option- **add \$300.**

Glass Options (Code)

Add \$0 Clear (CL)	Add \$300 AquaGlideXP Clear (XP)	Add \$450 Rain* (RN), Silk (LK)	Add \$577 Pure Clear (PC)	Add \$577 ShowerGuard Clear (CG)	Add \$1048 Pure Clear ShowerGuard (PG), Pure Silk (PS), Tempest* (TM)
-----------------------	--	------------------------------------	------------------------------	--	---

Please specify preferred panel positions with all patterned glass options. *Rain & Tempest have a maximum unit height of 80".

Finish Selections (Code)

Add \$0 Chrome (SV)	Add \$146 Brushed Nickel (BN), Matte Black (WI) Oil Rubbed Bronze (OR)	Add \$301 Bronze (BR), Brushed Bronze (BB), Brushed Gold (BG), Polished Nickel (PN), Satin Nickel (SN), White (WP)
------------------------	--	--

*Polished Nickel is limited to select Celesta hardware only. Please contact Customer Service before ordering.

3/8" Frameless
Panel/Swing Door/Panel

Inline Configurations

3/8" Glass Frameless Panel/Door/Panel GEOLUX, TRESOR, VONSE & LUX

Geolux - Model GEON-925 (no header) / GEOH-925 (header)

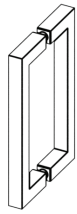

Through-the-Glass
8" Geometric Style
Pull Handle

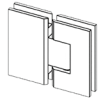

Glass-to-Glass Square
Hinges (no header)



Top & Bottom Square
Hinges (header)



Optional
Back-to-Back
Knob
(May replace
pull handle at
no charge.)

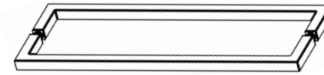

Optional
Back-to-Back Towel Bar
Add \$222/ea.

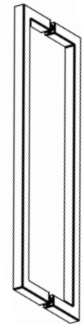

Optional
Oversized
Pull Handle
18" or 24"
Add - \$222

Tresor - Model TREN-925 (no header) / TREH-925 (header)

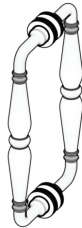

Through-the-Glass
8" Sculpted Style
Pull Handle

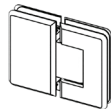

Glass-to-Glass Beveled
Hinges (no header)



Top & Bottom Beveled
Hinges (header)



Optional
Back-to-Back
Knob
(May replace
pull handle at
no charge.)



Optional
Single-Sided Towel Bar
Add \$295/ea.



Optional
Pull/Towel Bar Combo
Add \$489/ea.



Optional
Oversized
Pull Handle
18" or 24"
Add - \$295

Vonse - Model VONN-925 (no header) / VONH-925 (header)



Through-the-Glass
15 1/2" Wave Style
Pull Handle

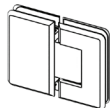

Glass-to-Glass Beveled
Hinges (no header)



Top & Bottom Beveled
Hinges (header)

Lux - Model LUXN-925 (no header) / LUXH-925 (header)



Through-the-Glass
8" Mitered Corner
Pull Handle

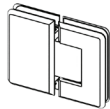

Glass-to-Glass Beveled
Hinges (no header)



Top & Bottom Beveled
Hinges (header)



Optional
Single-Sided Towel Bar
Add \$147/ea.

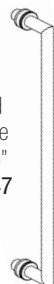

Optional
Oversized
Pull Handle
18" or 24"
Add - \$147

Features:

- No Header (...N-925) or with Header (...H-925)
- Through-the-glass pull handle
- Glass-to-glass hinges
- Left or right configurations

Model	Specify Width Between	Standard Door Width	Standard Height Options				Custom Size
			72"	76"	80"	84"	
Geolux:	Up to 44"	28"	\$2158	\$2187	\$2218	\$2246	For a custom height add \$250 to the next taller Standard Height price. For a custom door width add \$250. See notes for additional information & example.
GEON-925/GEOH-925	44 ¹ / ₁₆ " - 52"	28"	\$2338	\$2372	\$2404	\$2436	
Tresor:	52 ¹ / ₁₆ " - 60"	28"	\$2519	\$2552	\$2589	\$2622	
TREN-925/TREH-925	60 ¹ / ₁₆ " - 68"	28"	\$2699	\$2736	\$2773	\$2813	
Vonse:	68 ¹ / ₁₆ " - 76"	28"	\$2903	\$2946	\$2988	\$3029	
VONN-925/VONH-925	76 ¹ / ₁₆ " - 84"	28"	\$3109	\$3156	\$3199	\$3245	
Lux:	84 ¹ / ₁₆ " - 96"	28"	\$3455	\$3499	\$3545	\$3588	
LUXN-925/LUXH-925	*96 ¹ / ₁₆ " - 120"	28"	\$3801	\$3842	\$3891	\$3931	

Specific finished dimensions required when ordering.

Upgrade to 1/2" Glass - add \$637

*At this width, a header (model ___H-925) is required.



CLEAN THAT LASTS

Protect Your Investment.

Factory-applied AquaGlideXP is an ultra-protective coating that bonds to the glass, repelling moisture and soap film and is available with any glass option - add \$300.

Glass Options (Code)

Add \$0 Clear (CL)	Add \$300 AquaGlideXP Clear (XP)	Add \$450 Rain* (RN), Silk (LK)	Add \$577 Pure Clear (PC)	Add \$577 ShowerGuard Clear (CG)	Add \$1048 Pure Clear ShowerGuard (PG), Pure Silk (PS), Tempest* (TM)
-----------------------	--	------------------------------------	------------------------------	--	---

Please specify preferred panel positions with all patterned glass options. *Rain & Tempest have a maximum unit height of 80".

Finish Selections (Code)

Add \$0 Chrome (SV)	Add \$146 Brushed Nickel (BN), Matte Black (WI) Oil Rubbed Bronze (OR)	Add \$301 Bronze (BR), Brushed Bronze (BB), Brushed Gold (BG), Satin Nickel (SN), White (WP)
------------------------	--	--

Optional Features

- Custom Height and/or Custom Door Width - For any non-standard height, add \$250 to the next taller standard height. (For example, for a custom height of 74", add \$250 to the 76" height.) Use 84" height as base for anything greater than 84" tall up to 96" (max. 96"). Add \$250 for any exception to the standard 28" swing door width, either greater or smaller (maximum 36"). **Only one \$250 adder will be applied for a unit with both a custom door width and a custom height.**
- Angled Ceiling or Floor to Ceiling - add \$123, Extra Panel or Transom - add \$282 (ea), Swing Out Only (created by vinyl) or 1/2 Moon Dam (SC889) - add \$43, AquaGlideXP to any additional panel - add \$100 ea.
- Upgrade to 1/2" glass - add \$637/model. Limited to Clear, AquaGlideXP Clear, Silk, Pure Clear, Pure Silk, ShowerGuard Clear, or Pure Clear ShowerGuard glass
- Heavy hinges, offset hinge plate on wall mount hinge, or offset closure angle on any hinge - add \$80. Specify when ordering. Adjustable hinges - add \$120. Specify when ordering. Additional standard hinge (not required) - add \$244/ea. Additional/non-standard clamp (not required) - add \$345/unit. Any of these options must be specified when ordering.

Notes

- Please note any out-of-square conditions or notched panel on drawing. No additional charges apply.
- Minimum stationary panel is 6" wide.
- Headerless models may require additional structural support. When using wall mount hinges, 36" is the maximum panel width before a support bar is needed. Glass-to-glass hinges always require use of a support bar and minimum hinge panel size is 12". The number of hinges provided will be determined by the application. Adequate wall support is required (see pg. 86).

Headerless Pivot Hinge Option

- Wall mount or glass-to-glass headerless pivot hinges require no header and position the hinges at the top and bottom of the glass (instead of vertically down the glass) providing the most frameless look possible.
- Wall Mount pivot hinges - add \$213 and note option when ordering
- Glass-to-Glass pivot hinges - add \$425 and note option when ordering. Price includes 1/2" glass hinge panel upgrade and/or support pole if required.
- Pivot hinge extends 5/8" above unit height.
- Units with glass-to-glass pivot hinges feature 3/8" glass door with 1/2" glass panel, and are only available in Clear, AquaGlideXP Clear, Silk, Pure Clear, Pure Silk, ShowerGuard Clear, or Pure Clear ShowerGuard glass options.



3/8" Frameless Panel/Swing Door/Panel

Inline Configurations

Panel/Door/Panel

INFINITY - 1/4" Glass Semi-Frameless

DELUXE - Framed



Infinity - Model 1412



Features:

- Euro style header
- Through-the-glass 6" pull handle
- Full length continuous hinge provides stability
- Left or right configurations

Deluxe - Model 125



Features:

- Traditional style header
- Full length continuous hinge provides stability
- Left or right configurations

Optional Features

- **Infinity C Pull/Towel Bar Combination** - add \$82. To substitute a C Pull/Towel Bar combination option, prefix the unit number with the letter (C). For example - C1412FGOR. Specify hinge side, left or right. To substitute a
- **Infinity Single-Sided Towel Bar** - add \$62. To substitute, specify when ordering.
- **Deluxe Curved Towel Bar** - add \$137 To add a curved towel bar to any Deluxe Framed hinge door, prefix the unit number with the letter (T). For example - T125CLBR. Specify hinge side, left or right.
- **Buttress** - add \$116 ea; **Notched Panel** - add \$174 ea; **Modified for Steam (Deluxe only)** - add \$44.
- **Glass Panel Out-of-Square (Infinity only)** - add \$87 per panel
- **Quick 'N Stall** - add \$82. Limited to Clear, Obscure, Rain, Eclipse, Clear Etched glass options.

Fillers - For best performance, Basco recommends the opening be square and plumb. If the opening curb is out of level beyond 1/4" or walls are out of level beyond 3/8", purchase tapered fillers for proper fit. Please refer to page 89 for part numbers and pricing.



Easy quoting and ordering
Assisted selling by model • Visual door drawing
Dynamic pricing • Save and store

mystro.mybasco.com

To obtain a log-in, email
mystro@bascohowerdoor.com

1/4" Semi-Frameless Panel/Door/Panel, Clear Glass/Chrome Finish

Infinity Model	Specify Width Between	Standard Door Width	Standard Height Options				Custom Height
			65 ¹ / ₈ "	68 ⁵ / ₈ "	72 ¹ / ₈ "	76 ¹ / ₈ "	
1412 <i>Specific finished dimensions required when ordering.</i>	36" - 40"	24"	\$1259	\$1768	\$1825	\$1884	For a custom door size (max. 36") and/or custom width or height (max. 72" x 84") \$1987
	40 ¹ / ₁₆ " - 48"	28 ⁷ / ₈ "	\$1379	\$1788	\$1846	\$1903	
	48 ¹ / ₁₆ " - 56"	28 ⁷ / ₈ "	\$1398	\$1809	\$1868	\$1925	
	56 ¹ / ₁₆ " - 60"	28 ⁷ / ₈ "	\$1420	\$1831	\$1889	\$1945	

Framed Panel/Door/Panel, Clear Glass/Chrome Finish

Deluxe Model	Specify Width Between	Standard Door Width	Standard Height Options				Custom Height
			65 ¹ / ₈ "	68 ⁵ / ₈ "	72 ¹ / ₈ "	76 ¹ / ₈ "	
125 <i>Specific finished dimensions required when ordering.</i>	36" - 40"	24"	\$1241	\$1529	\$1552	\$1712	For a custom door size (max. 36") and/or custom width or height (max. 72" x 84") \$1835
	40 ¹ / ₁₆ " - 48"	28 ⁷ / ₈ "	\$1256	\$1552	\$1576	\$1737	
	48 ¹ / ₁₆ " - 56"	28 ⁷ / ₈ "	\$1273	\$1576	\$1600	\$1762	
	56 ¹ / ₁₆ " - 60"	28 ⁷ / ₈ "	\$1288	\$1600	\$1625	\$1787	

Semi-Frameless/Framed Panel/Swing Door/Panel



Protect Your Investment.
Factory-applied AquaGlideXP is an ultra-protective coating that bonds to the glass, repelling moisture and soap film and is available with any glass option- **add \$300.**

Glass Options (Code)

Add \$0 Clear (CL)	Add \$300 AquaGlideXP Clear (XP)	Add \$132 Obscure* (OB), Rain* (RN), Eclipse (EP)	Add \$258 Clear Etched (EE), Vessence* (VS)	Add \$653 Silk (LK)	Add \$865 Tempest* (TM), Fluted* (FG), ShowerGuard Clear** (CG)
------------------------------	--	--	--	-------------------------------	--

*Obscure, Rain, Vessence, Fluted & Tempest have a maximum unit height of 80". **ShowerGuard Clear is only available with Infinity models.

Finish Selections (Code)

Add \$0 Chrome (SV)	Add \$405 Brushed Nickel (BN), Matte Black (WI) Oil Rubbed Bronze (OR)	Add \$634 Bronze (BR), Brushed Bronze (BB), Brushed Gold (BG), Satin Nickel (SN), White (WP)
-------------------------------	---	---

Inline Configurations

3/8" Glass Frameless Panel/Rolling door/Panel

ROLAIRE

Rolaire - Model ROLH-925



Features:

- *Barn-door style, elevated header*
- *Exterior through-the-glass pull handle*
- *Interior pull knob*
- *Left or right configurations*

Optional Feature

- **Optional towel bar - add \$352/bar.** An 18" towel bar can be added to the inside of the door panel or the outside stationary panels. You may substitute a knob instead of the handle for no additional cost.

Notes

- **Heights shown are to the top of the header. Add 3" for roller clearance.**
- **Minimum suggested width is 53".** At this width, walk-through opening will be roughly 19³/₁₆", with offset panels.
- **Please specify shower head side,** as well as any **out-of-plumb** and/or **out-of-level** conditions to the 1/16 of an inch on drawing. Glass will be cut out of square to accommodate for any out-of-plumb/level condition. Maximum of 1/8" curb out-of-level conditions.



Easy quoting and ordering
 Assisted selling by model • Visual door drawing
 Dynamic pricing • Save and store

mystro.mybasco.com

To obtain a log-in, email
mystro@basco showerdoor.com

3/8" Frameless Panel/Rolling Door/Panel - Clear (CL) Glass/Brushed Stainless Steel Finish

Rolaire Model	Specify Width Between	Standard Height Options			Custom Height
		72"	76"	80"	
ROLH-925	Up to 62"	\$3195	\$3229	\$3262	For a custom height (max. 80")
	62 ¹ / ₁₆ " - 70"	\$3285	\$3319	\$3352	
	70 ¹ / ₁₆ " - 78"	\$3376	\$3409	\$3444	
	78 ¹ / ₁₆ " - 86"	\$3465	\$3500	\$3533	
	86 ¹ / ₁₆ " - 94"	\$3557	\$3590	\$3624	\$3944
	94 ¹ / ₁₆ " - 102"	\$3647	\$3680	\$3714	
	102 ¹ / ₁₆ " - 110"	\$3738	\$3770	\$3805	
	110 ¹ / ₁₆ " - 120"	\$3828	\$3862	\$3894	

Specific finished height is required when ordering.

A minimum curb width/threshold & wall jamb width of 2³/₁₆" is required. Specify shower head side when ordering.

3/8" Frameless Panel/Rolling Door/Panel



CLEAN THAT LASTS

Protect Your Investment.

Factory-applied AquaGlideXP is an ultra-protective coating that bonds to the glass, repelling moisture and soap film and is available with any glass option - **add \$300.**

Glass Options (Code)

Add \$0 Clear (CL)	Add \$300 AquaGlideXP Clear (XP)	Add \$450 Rain* (RN), Silk (LK)	Add \$577 Pure Clear (PC)	Add \$577 ShowerGuard Clear (CG)	Add \$1048 Pure Clear ShowerGuard (PG), Pure Silk (PS), Tempest* (TM)
------------------------------	---	---	-------------------------------------	---	--

Rolaire Finish Selections (Code)

Add \$0 Brushed Stainless Steel (BS)	Add \$105 Polished Chrome (PM)	Add \$146 Matte Black (WI)
--	--	--------------------------------------

Return Configurations

3/8" Glass Frameless Door & Return Panel CELESTA & DRESDEN

Celesta - Model CELN-945 (no header) / CELH-945 (header)

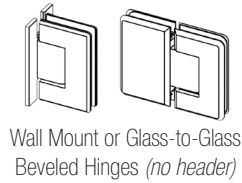

Optional
Back-to-Back
Knob
(May replace
pull handle at
no charge.)



Dresden - Model DREN-945 (no header) / DREH-945 (header)

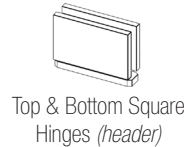
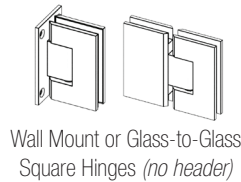
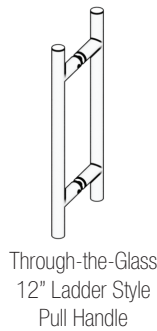
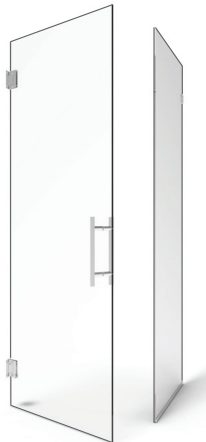

Optional
Back-to-Back
Knob
(May replace
pull handle at
no charge.)



Optional Features

- **Custom Height** - For any non-standard height, add \$250 to the next taller standard height. (For example, for a custom height of 74", add \$250 to the 76" height.) Use 84" height as base for anything greater than 84" tall up to 96" (max. 96").
- **Angled Ceiling or Floor to Ceiling** - add \$123, **Extra Panel or Transom** - add \$282 (ea), **Swing Out Only** (created by vinyl) or **1/2 Moon Dam** (SC889) - add \$43. **AquaGlideXP on any additional panel** - add \$100 ea.
- **Upgrade to 1/2" glass** - add \$425/model. Limited to Clear, AquaGlideXP Clear, Silk, Pure Clear, Pure Silk, ShowerGuard Clear, or Pure Clear ShowerGuard glass
- **Heavy hinges, offset hinge plate on wall mount hinge, or offset closure angle on any hinge** - add \$80. **Adjustable hinges** - add \$120. **Additional standard hinge** (not required) - add \$244/ea. **Additional/non-standard clamp** (not required) - add \$173/unit. *Specify option when ordering.*
- **French Door option** - add \$597 for an additional swing door.

Notes

- Please note any **out-of-square conditions** or **notched panel** on drawing. *No additional charges apply.*
- Minimum stationary panel is 6" wide.
- **These models may require additional structural support.** When using wall mount hinges, 36" is the maximum panel width before a support bar is needed. Glass-to-glass hinges always require use of a support bar and minimum hinge panel size is 12". The number of hinges provided will be determined by the application. Adequate wall support (see pg. 86) is required.

Headerless Wall Mount Pivot Hinge Option - add \$213

- Wall mount headerless pivot hinges require no header and position the hinges at the top and bottom of the glass (instead of vertically down the glass) providing the most frameless look possible. Note option when ordering. *Price includes support pole if required.*
- Pivot hinge extends 5/8" above unit height.



Features:

- No Header (...N-935) or with Header (...H-935)
- Through-the-glass pull handle
- Wall mount or glass-to-glass hinges
- Left or right configurations

Return
Opening
Configuration

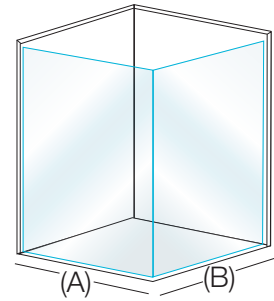

3/8" Frameless Door & Return Panel, Clear (CL) Glass/Chrome (SV) Finish

Celesta Model	Specify Width (A+B) Between	Standard Height Options				Custom Height
		72"	76"	80"	84"	
CELN-945 (No Header)	Up to 46"	\$2210	\$2245	\$2280	\$2314	For a custom height add \$250 to the next taller Standard Height price. <i>See notes for additional information & example.</i> Maximum width for the swing door is 36".
	46 ¹ / ₁₆ " - 54"	\$2395	\$2433	\$2470	\$2504	
CELH-945 (Header)	54 ¹ / ₁₆ " - 62"	\$2579	\$2621	\$2657	\$2698	
	62 ¹ / ₁₆ " - 70"	\$2763	\$2805	\$2849	\$2892	
<i>Specific finished dimensions (centerline A & B and height) required when ordering.</i>	70 ¹ / ₁₆ " - 78"	\$2947	\$2993	\$3036	\$3082	
	78 ¹ / ₁₆ " - 86"	\$3135	\$3180	\$3230	\$3277	
	86 ¹ / ₁₆ " - 94"	\$3317	\$3368	\$3416	\$3465	
	94 ¹ / ₁₆ " - 102"	\$3540	\$3591	\$3647	\$3701	
	102 ¹ / ₁₆ " - 108"	\$3687	\$3739	\$3795	\$3853	

Upgrade to 1/2" Glass - add \$425

3/8" Frameless Door & Return Panel, Clear (CL) Glass/Chrome (SV) Finish

Dresden Model	Specify Width (A+B) Between	Standard Height Options				Custom Height
		72"	76"	80"	84"	
DREN-945 (No Header)	Up to 46"	\$2335	\$2370	\$2405	\$2439	For a custom height add \$250 to the next taller Standard Height price. <i>See notes for additional information & example.</i> Maximum width for the swing door is 36".
	46 ¹ / ₁₆ " - 54"	\$2520	\$2558	\$2595	\$2629	
DREH-945 (Header)	54 ¹ / ₁₆ " - 62"	\$2704	\$2746	\$2782	\$2823	
	62 ¹ / ₁₆ " - 70"	\$2888	\$2930	\$2974	\$3017	
<i>Specific finished dimensions (centerline A & B and height) required when ordering.</i>	70 ¹ / ₁₆ " - 78"	\$3072	\$3118	\$3161	\$3207	
	78 ¹ / ₁₆ " - 86"	\$3260	\$3305	\$3355	\$3402	
	86 ¹ / ₁₆ " - 94"	\$3442	\$3493	\$3541	\$3590	
	94 ¹ / ₁₆ " - 102"	\$3665	\$3716	\$3772	\$3826	
	102 ¹ / ₁₆ " - 108"	\$3812	\$3864	\$3920	\$3978	

Upgrade to 1/2" Glass - add \$425

3/8" Frameless Swing Door & Return Panel

AQUAGLIDE^{XP}
CLEAN THAT LASTS **Protect Your Investment.**

Factory-applied AquaGlideXP is an ultra-protective coating that bonds to the glass, repelling moisture and soap film and is available with any glass option- **add \$200.**

Glass Options (Code)

Add \$0 Clear (CL)	Add \$200 AquaGlideXP Clear (XP)	Add \$301 Rain* (RN), Silk (LK)	Add \$426 Pure Clear (PC)	Add \$426 ShowerGuard Clear (CG)	Add \$748 Pure Clear ShowerGuard (PG), Pure Silk (PS), Tempest* (TM)
------------------------------	---	---	-------------------------------------	---	---

Please specify preferred panel position with all patterned glass options. *Rain & Tempest have a maximum unit height of 80".

Finish Selections (Code)

Add \$0 Chrome (SV)	Add \$146 Brushed Nickel (BN), Matte Black (WI) Oil Rubbed Bronze (OR)	Add \$301 Bronze (BR), Brushed Bronze (BB), Brushed Gold (BG), Polished Nickel (PN), Satin Nickel (SN), White (WP)
-------------------------------	---	---

*Polished Nickel is limited to select Celesta hardware only. Please contact Customer Service before ordering.

Return Configurations

3/8" Glass Frameless Swing Door & Return Panel GEOLUX, TRESOR, VONSE & LUX

Geolux - Model GEON-945 (no header) / GEOH-945 (header)

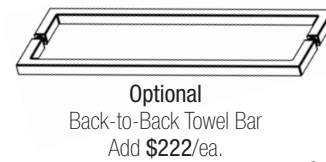
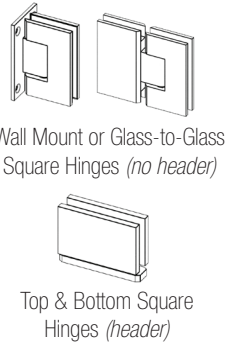
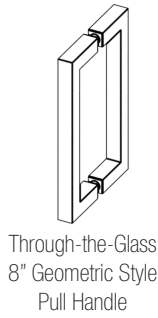

Tresor - Model TREN-945 (no header) / TREH-945 (header)

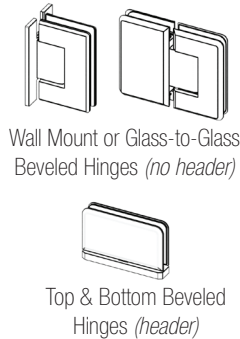
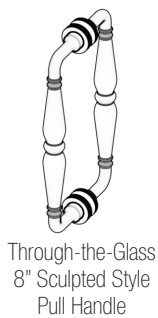

Vonse - Model VONN-945 (no header) / VONH-945 (header)

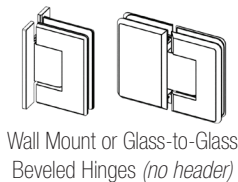
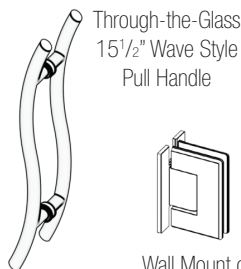

Lux - Model LUXN-945 (no header) / LUXH-945 (header)

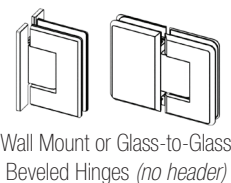
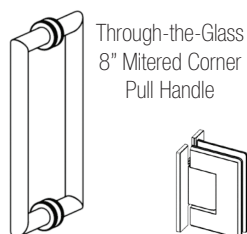

Features:

- No Header (...N-935) or with Header (...H-935)
- Through-the-glass pull handle
- Wall mount or glass-to-glass hinges
- Left or right configurations

Return
Opening
Configuration

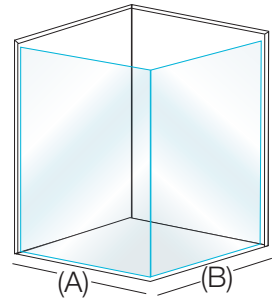

Model Numbers		Standard Height Options				Custom Height
		72"	76"	80"	84"	
Geolux:	Up to 46"	\$2410	\$2445	\$2480	\$2514	For a custom height add \$250 to the next taller Standard Height price. See notes for additional information & example. Maximum width for swing door is 36".
GEON-945/GEOH-945	46 ¹ / ₁₆ " - 54"	\$2595	\$2633	\$2670	\$2704	
Tresor:	54 ¹ / ₁₆ " - 62"	\$2779	\$2821	\$2857	\$2898	
TREN-945/TREH-945	62 ¹ / ₁₆ " - 70"	\$2963	\$3005	\$3049	\$3092	
Vonse:	70 ¹ / ₁₆ " - 78"	\$3147	\$3193	\$3236	\$3282	
VONN-945/VONH-945	78 ¹ / ₁₆ " - 86"	\$3335	\$3380	\$3430	\$3477	
Lux:	86 ¹ / ₁₆ " - 94"	\$3517	\$3568	\$3616	\$3665	
LUXN-945/LUXH-945	94 ¹ / ₁₆ " - 102"	\$3740	\$3791	\$3847	\$3901	
	102 ¹ / ₁₆ " - 108"	\$3887	\$3939	\$3995	\$4053	

Specific finished dimensions (centerline A & B and height) required when ordering.
 Upgrade to 1/2" Glass - add \$425



Protect Your Investment.

Factory-applied AquaGlideXP is an ultra-protective coating that bonds to the glass, repelling moisture and soap film and is available with any glass option- add \$200.

Glass Options (Code)

Add \$0 Clear (CL)	Add \$200 AquaGlideXP Clear (XP)	Add \$301 Rain* (RN), Silk (LK)	Add \$426 Pure Clear (PC)	Add \$426 ShowerGuard Clear (CG)	Add \$748 Pure Clear ShowerGuard (PG), Pure Silk (PS), Tempest* (TM)
-----------------------	--	------------------------------------	------------------------------	--	--

Please specify preferred panel position with all patterned glass options. *Rain & Tempest have a maximum unit height of 80".

Finish Selections (Code)

Add \$0 Chrome (SV)	Add \$146 Brushed Nickel (BN), Matte Black (Wl) Oil Rubbed Bronze (OR)	Add \$301 Bronze (BR), Brushed Bronze (BB), Brushed Gold (BG), Satin Nickel (SN), White (WP)
------------------------	--	--

Optional Features

- **Custom Height** - For any non-standard height, add \$250 to the next taller standard height. (For example, for a custom height of 74", add \$250 to the 76" height.) Use 84" height as base for anything greater than 84" tall up to 96" (max. 96").
- **Angled Ceiling or Floor to Ceiling** - add \$123, **Extra Panel or Transom** - add \$282 (ea), **Swing Out Only** (created by vinyl) or **1/2 Moon Dam (SC889)** - add \$43. AquaGlideXP on any additional panel - add \$100 ea.
- **Upgrade to 1/2" glass** - add \$425/model. Limited to Clear, AquaGlideXP Clear, Silk, Pure Clear, Pure Silk, ShowerGuard Clear, or Pure Clear ShowerGuard glass
- **Heavy hinges, offset hinge plate on wall mount hinge, or offset closure angle on any hinge** - add \$80. **Adjustable hinges** - add \$120. **Additional standard hinge** (not required) - add \$244/ea. **Additional/non-standard clamp** (not required) - add \$173/unit. Specify option when ordering.
- **French Door option** - add \$597 for an additional swing door.

Notes

- Please note any **out-of-square conditions or notched panel** on drawing. No additional charges apply.
- Minimum stationary panel is 6" wide.
- **These models may require additional structural support.** When using wall mount hinges, 36" is the maximum panel width before a support bar is needed. Glass-to-glass hinges always require use of a support bar and minimum hinge panel size is 12". The number of hinges provided will be determined by the application. Adequate wall support (see pg. 86) is required.

Headerless Wall Mount Pivot Hinge Option - add \$213

- Wall mount headerless pivot hinges require no header and position the hinges at the top and bottom of the glass (instead of vertically down the glass) providing the most frameless look possible. Note option when ordering. Price includes support pole if required.
- Pivot hinge extends 5/8" above unit height.



3/8" Frameless
Swing Door & Return Panel

Return Configurations

Door & Return Panel

INFINITY - 1/4" Glass Semi-frameless

DELUXE - Framed



Infinity - Model 1414



Features:

- Euro style header
- Through-the-glass 6" pull handle
- Full length continuous hinge provides stability
- Reversible for left or right entry

Deluxe - Model 145

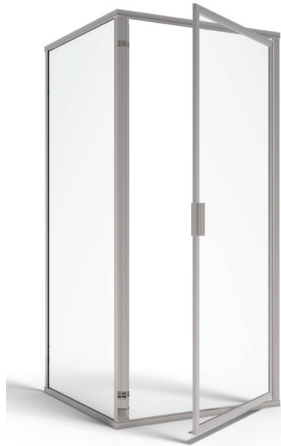

Features:

- Traditional style header
- Full length continuous hinge provides stability
- Reversible for left or right entry

Optional Features

- **Infinity C Pull/Towel Bar Combination - add \$82.** To substitute a C Pull/Towel Bar combination option, prefix the unit number with the letter (C). For example - C1414FGOR. Specify hinge side, left or right.
- **Single-Sided Towel Bar - add \$62.** To substitute, specify when ordering.
- **Deluxe Curved Towel Bar - add \$137.** To add a curved towel bar to any Deluxe Framed door, prefix the unit number with the letter (T). For example - T145CLBR. Specify hinge side, left or right.
- **Buttress - add \$116 ea.; Notched Panel - add \$174 ea.; Special Angle (not 90°) - add \$116 ea.**

- **Glass Panel Out-of-Square (Infinity only) - add \$87** per panel.
- **Quick 'N Stall - add \$82.** Limited to Clear, Obscure, Rain, Eclipse, Clear Etched glass options.
- **Modified for Steam (Deluxe only) - add \$44.**

Fillers - For best performance, Basco recommends the opening be square and plumb. If the opening curb is out of level beyond 1/4" or walls are out of level beyond 3/8", purchase tapered fillers for proper fit. Please refer to page 89 for part numbers and pricing.



Easy quoting and ordering
 Assisted selling by model • Visual door drawing
 Dynamic pricing • Save and store
mystro.mybasco.com
 To obtain a log-in, email
 mystro@basco showerdoor.com

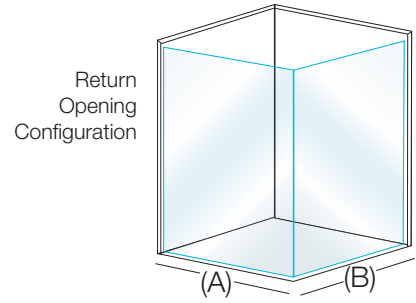

1/4" Semi-Frameless Door & Return Panel, Clear (CL) Glass/Chrome (SV) Finish

Infinity Model	Return Panel (A) Specify Centerline Width Up To	Door (B) Specify Centerline Width Up To	Standard Height Options				Custom Size
			65 ¹ / ₈ "	68 ⁵ / ₈ "	72 ¹ / ₈ "	76 ¹ / ₈ "	
1414	36"	36"	\$1571	\$1584	\$2035	\$2138	For a custom height (max. 84") \$2244
	48"	36"	\$1584	\$1599	\$2050	\$2152	
	60"	36"	\$1599	\$1612	\$2063	\$2166	

Specific finished dimensions (centerline A & B and height) required when ordering.

Framed Door & Return Panel, Clear (CL) Glass/Chrome (SV) Finish

Deluxe Model	Return Panel (A) Specify Centerline Width Up To	Door (B) Specify Centerline Width Up To	Standard Height Options				Custom Size
			65 ¹ / ₈ "	68 ⁵ / ₈ "	72 ¹ / ₈ "	76 ¹ / ₈ "	
145	36"	36"	\$1398	\$1413	\$1735	\$1876	For a custom height (max. 84") \$1982
	48"	36"	\$1413	\$1426	\$1750	\$1891	
	60"	36"	\$1426	\$1441	\$1763	\$1904	

Specific finished dimensions (centerline A & B and height) required when ordering.

AQUAGLIDE^{XP}
 CLEAN THAT LASTS
 Protect Your Investment.
 Factory-applied AquaGlideXP is an ultra-protective coating that bonds to the glass, repelling moisture and soap film and is available with any glass option- **add \$200.**

Glass Options (Code)

Add \$0 Clear (CL)	Add \$200 AquaGlideXP Clear (XP)	Add \$88 Obscure* (OB), Rain (RN)*, Eclipse (EP)	Add \$182 Clear Etched (EE), Vessence* (VS)	Add \$435 Silk (LK)	Add \$577 Tempest* (TM), Fluted* (FG), ShowerGuard Clear** (CG)
------------------------------	--	---	--	-------------------------------	--

**Obscure, Rain, Vessence, Fluted & Tempest have a maximum unit height of 80". **ShowerGuard Clear is only available with Infinity models.*

Finish Selections (Code)

Add \$0 Chrome (SV)	Add \$270 Brushed Nickel (BN), Matte Black (WI) Oil Rubbed Bronze (OR)	Add \$423 Bronze (BR), Brushed Bronze (BB), Brushed Gold (BG), Satin Nickel (SN), White (WP)
-------------------------------	---	---

Semi-Frameless/Framed Swing Door & Return Panel

Return Configurations

3/8" Glass Frameless Door, Inline Panel & Return Panel CELESTA & DRESDEN

Celesta - Model CELN-950 (no header) / CELH-950 (header)

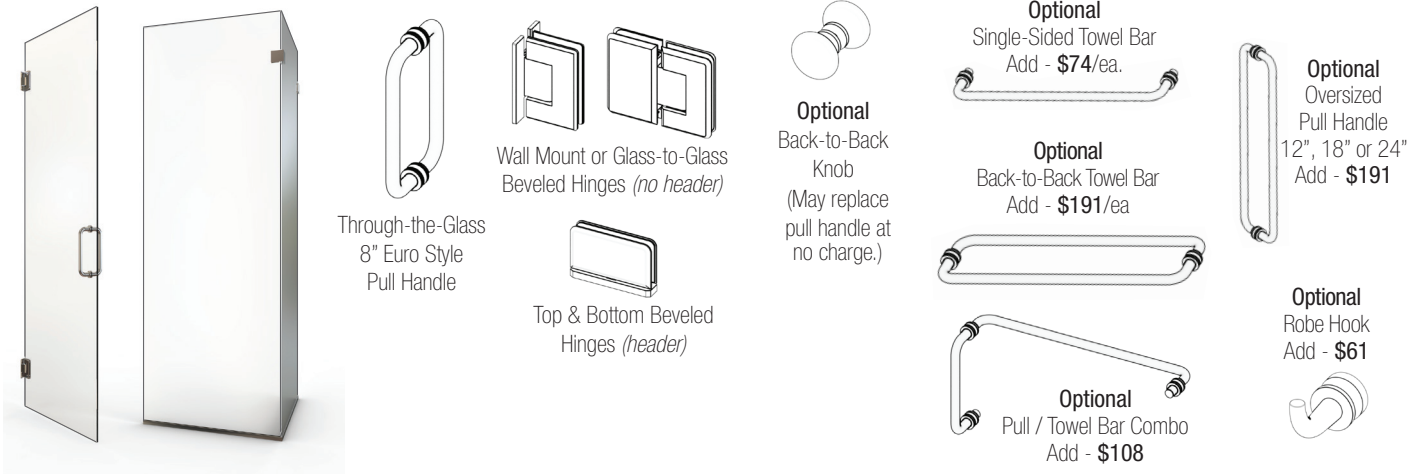

Dresden - Model DREN-950 (no header) / DREH-950 (header)

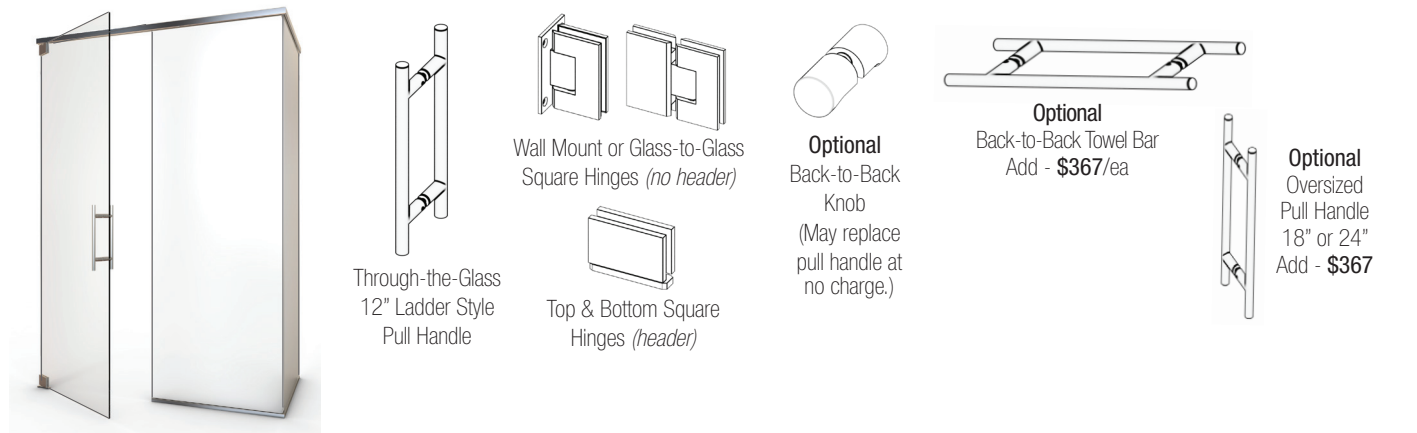

Optional Features

- **Custom Height and/or Custom Door Width** - For any non-standard height, add \$250 to the next taller standard height. (For example, for a custom height of 74", add \$250 to the 76" height.) Use 84" height as base for anything greater than 84" tall up to 96" (max. 96"). Add \$250 for any exception to the standard 28" swing door width, either greater or smaller (maximum 36"). **Only one \$250 adder will be applied for a unit with both a custom door width and a custom height.**
- **Angled Ceiling or Floor to Ceiling** - add \$123, **Extra Panel or Transom** - add \$282 (ea), **Swing Out Only** (created by vinyl) or **1/2 Moon Dam (SC889)** - add \$43. **AquaGlideXP on any additional panel** - add \$100 ea.
- **Upgrade to 1/2" glass** - add \$637/model. Limited to Clear, AquaGlideXP Clear, Silk, Pure Clear, Pure Silk, ShowerGuard Clear, or Pure Clear ShowerGuard glass
- **Heavy hinges, offset hinge plate on wall mount hinge, or offset closure angle on any hinge** - add \$80. **Adjustable hinges** - add \$120. **Additional standard hinge (not required)** - add \$244/ea. **Additional/non-standard clamp (not required)** - add \$173/unit. *Specify option when ordering.*
- **French Door option** - add \$597 for an additional swing door.
- **Mitering for Glass-to-Glass Corner** - add \$471

Notes

- Please note any **out-of-square conditions or notched panel** on drawing. *No additional charges apply.*
- Minimum stationary panel is 6" wide.
- **These models may require additional structural support.** When using wall mount hinges, 36" is the maximum panel width before a support bar is needed. Glass-to-glass hinges always require use of a support bar and minimum hinge panel size is 12". The number of hinges provided will be determined by the application. Adequate wall support (see pg. 86) is required.

Headerless Pivot Hinge Option

- Wall mount or glass-to-glass headerless pivot hinges require no header and position the hinges at the top and bottom of the glass (instead of vertically down the glass) providing the most frameless look possible.
- **Wall Mount pivot hinges** - add \$213 and note option when ordering
- **Glass-to-Glass pivot hinges** - add \$425 and note option when ordering. *Price includes 1/2" glass hinge panel upgrade and/or support pole if required.*
- Pivot hinge extends 5/8" above unit height.
- Units with glass-to-glass pivot hinges feature 3/8" glass door with 1/2" glass hinge panel, and are only available in Clear, AquaGlideXP Clear, Silk, Pure Clear, Pure Silk, ShowerGuard Clear, or Pure Clear ShowerGuard glass options.



Features:

- No Header (...**N**-950) or with Header (...**H**-950)
- Through-the-glass pull handle
- Wall mount or glass-to-glass hinges
- Left or right configurations

Return
Opening
Configuration

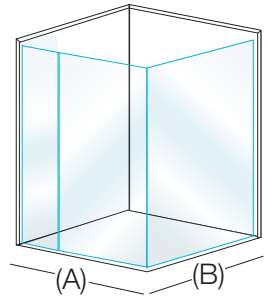

3/8" Frameless Door & Inline Panel, Clear (CL) Glass/Chrome (SV) Finish

Celesta Model	Specify Width (A+B) Between	Standard Door Width	Standard Height Options				Custom Size
			72"	76"	80"	84"	
CELN-950 (No Header)	Up to 46"	28"	\$2210	\$2245	\$2280	\$2314	For a custom height add \$250 to the next taller Standard Height price. For a custom door width add \$250. <i>See notes for additional information & example.</i>
	46 ¹ / ₁₆ " - 54"	28"	\$2395	\$2433	\$2470	\$2504	
	54 ¹ / ₁₆ " - 62"	28"	\$2579	\$2621	\$2657	\$2698	
CELH-950 (Header)	62 ¹ / ₁₆ " - 70"	28"	\$2763	\$2805	\$2849	\$2892	
	70 ¹ / ₁₆ " - 78"	28"	\$2947	\$2993	\$3036	\$3082	
	78 ¹ / ₁₆ " - 86"	28"	\$3135	\$3180	\$3230	\$3277	
	86 ¹ / ₁₆ " - 94"	28"	\$3317	\$3368	\$3416	\$3465	
	94 ¹ / ₁₆ " - 102"	28"	\$3540	\$3591	\$3647	\$3701	
	102 ¹ / ₁₆ " - 110"	28"	\$3687	\$3739	\$3795	\$3853	
	110 ¹ / ₁₆ " - 120"	28"	\$3868	\$3928	\$3989	\$4047	
120 ¹ / ₁₆ " - 166"	28"	\$4253	\$4311	\$4373	\$4433		

*Specific finished dimensions (centerline A & B and height) required when ordering.
Upgrade to 1/2" Glass - add \$637*

3/8" Frameless Door & Inline Panel, Clear (CL) Glass/Chrome (SV) Finish

Dresden Model	Specify Width (A+B) Between	Standard Door Width	Standard Height Options				Custom Size
			72"	76"	80"	84"	
DREN-950 (No Header)	Up to 46"	28"	\$2335	\$2370	\$2405	\$2439	For a custom height add \$250 to the next taller Standard Height price. For a custom door width add \$250. <i>See notes for additional information & example.</i>
	46 ¹ / ₁₆ " - 54"	28"	\$2520	\$2558	\$2595	\$2629	
	54 ¹ / ₁₆ " - 62"	28"	\$2704	\$2746	\$2782	\$2823	
DREH-950 (Header)	62 ¹ / ₁₆ " - 70"	28"	\$2888	\$2930	\$2974	\$3017	
	70 ¹ / ₁₆ " - 78"	28"	\$3072	\$3118	\$3161	\$3207	
	78 ¹ / ₁₆ " - 86"	28"	\$3260	\$3305	\$3355	\$3402	
	86 ¹ / ₁₆ " - 94"	28"	\$3442	\$3493	\$3541	\$3590	
	94 ¹ / ₁₆ " - 102"	28"	\$3665	\$3716	\$3772	\$3826	
	102 ¹ / ₁₆ " - 110"	28"	\$3812	\$3864	\$3920	\$3978	
	110 ¹ / ₁₆ " - 120"	28"	\$3993	\$4053	\$4114	\$4172	
120 ¹ / ₁₆ " - 166"	28"	\$4378	\$4436	\$4498	\$4558		

*Specific finished dimensions (centerline A & B and height) required when ordering.
Upgrade to 1/2" Glass - add \$637*



Protect Your Investment.

Factory-applied AquaGlideXP is an ultra-protective coating that bonds to the glass, repelling moisture and soap film and is available with any glass option- **add \$300.**

Glass Options (Code)

Add \$0 Clear (CL)	Add \$300 AquaGlideXP Clear (XP)	Add \$450 Rain* (RN), Silk (LK)	Add \$577 Pure Clear (PC)	Add \$577 ShowerGuard Clear (CG)	Add \$1048 Pure Clear ShowerGuard (PG), Pure Silk (PS), Tempest* (TM)
-----------------------	--	------------------------------------	------------------------------	--	---

Please specify preferred panel positions with all patterned glass options. *Rain & Tempest have a maximum unit height of 80".

Finish Selections (Code)

Add \$0 Chrome (SV)	Add \$146 Brushed Nickel (BN), Matte Black (WI) Oil Rubbed Bronze (OR)	Add \$301 Bronze (BR), Brushed Bronze (BB), Brushed Gold (BG), Polished Nickel (PN), Satin Nickel (SN), White (WP)
------------------------	--	--

*Polished Nickel is limited to select Celesta hardware only. Please contact Customer Service before ordering.

3/8" Frameless Swing Door & Panel with Return

Return Configurations

3/8" Glass Frameless Door, Inline Panel & Return Panel GEOLUX, TRESOR, VONSE & LUX

Geolux - Model GEON-950 (no header) / GEOH-950 (header)

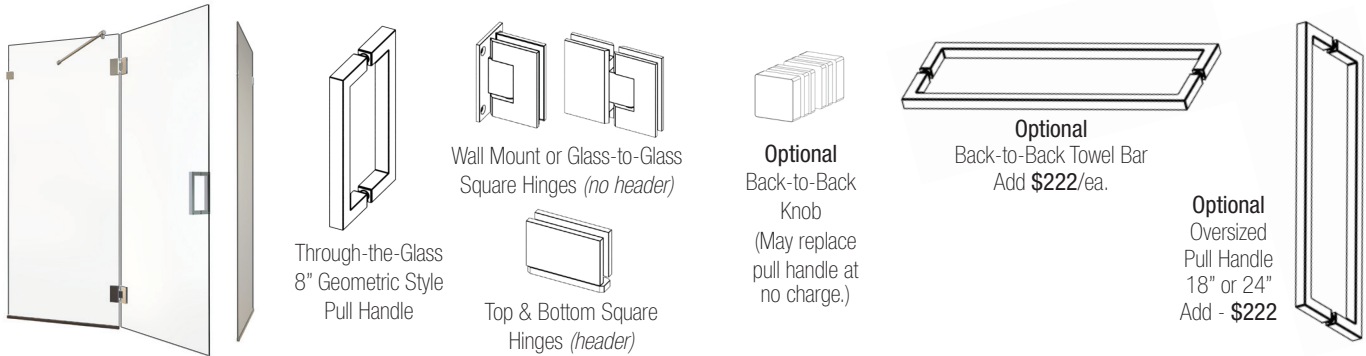

Tresor - Model TREN-950 (no header) / TREH-950 (header)

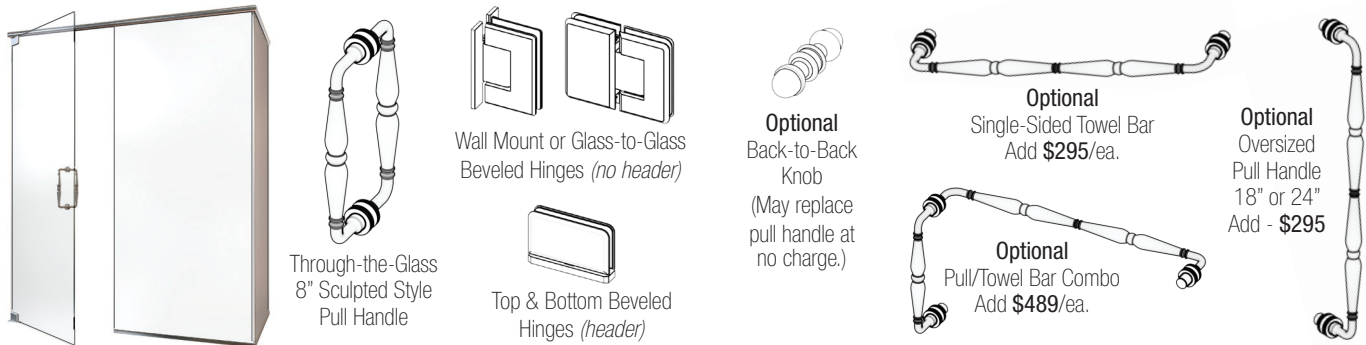

Vonse - Model VONN-950 (no header) / VONH-950 (header)

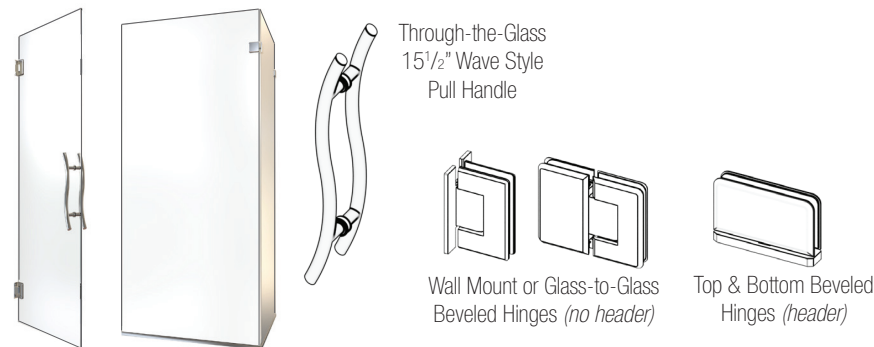

Lux - Model LUXN-950 (no header) / LUXH-950 (header)

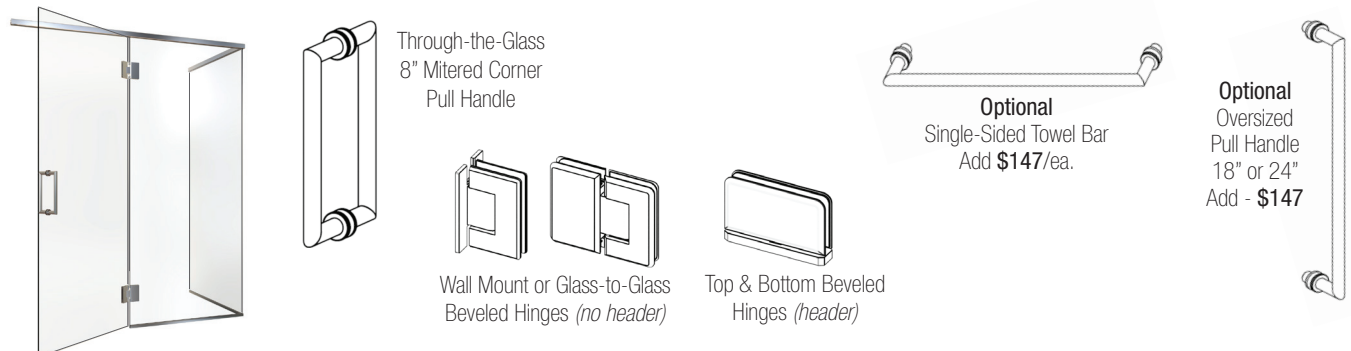

Features:

- No Header (...N-950) or with Header (...H-950)
- Through-the-glass pull handle
- Wall mount or glass-to-glass hinges
- Left or right configurations

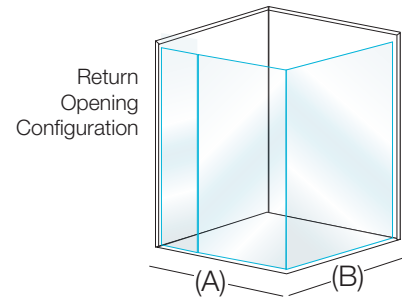

Frameless Door & Inline Panel, Clear (CL) Glass/Chrome (SV) Finish

Model Numbers	Specify Width (A+B) Between	Standard Door Width	Standard Height Options				Custom Size
			72"	76"	80"	84"	
Geolux:	Up to 46"	28"	\$2410	\$2445	\$2480	\$2514	For a custom height add \$250 to the next taller Standard Height price. For a custom door width add \$250. See notes for additional information & example.
GEON-950/GEOH-950	46 ¹ / ₁₆ " - 54"	28"	\$2595	\$2633	\$2670	\$2704	
Tresor:	54 ¹ / ₁₆ " - 62"	28"	\$2779	\$2821	\$2857	\$2898	
TREN-950/TREH-950	62 ¹ / ₁₆ " - 70"	28"	\$2963	\$3005	\$3049	\$3092	
Vonse:	70 ¹ / ₁₆ " - 78"	28"	\$3147	\$3193	\$3236	\$3282	
VONN-950/VONH-950	78 ¹ / ₁₆ " - 86"	28"	\$3335	\$3380	\$3430	\$3477	
Lux:	86 ¹ / ₁₆ " - 94"	28"	\$3517	\$3568	\$3616	\$3665	
LUXN-950/LUXH-950	94 ¹ / ₁₆ " - 102"	28"	\$3740	\$3791	\$3847	\$3901	
<i>Specific finished dimensions (centerline A & B and height) required when ordering.</i>	102 ¹ / ₁₆ " - 110"	28"	\$3887	\$3939	\$3995	\$4053	
	110 ¹ / ₁₆ " - 120"	28"	\$4068	\$4128	\$4189	\$4247	
	120 ¹ / ₁₆ " - 166"	28"	\$4453	\$4511	\$4573	\$4633	

Upgrade to 1/2" Glass - add \$637

AQUAGLIDE^{XP}
CLEAN THAT LASTS **Protect Your Investment.**

Factory-applied AquaGlideXP is an ultra-protective coating that bonds to the glass, repelling moisture and soap film and is available with any glass option- **add \$300.**

Glass Options (Code)

Add \$0 Clear (CL)	Add \$300 AquaGlideXP Clear (XP)	Add \$450 Rain* (RN), Silk (LK)	Add \$577 Pure Clear (PC)	Add \$577 ShowerGuard Clear (CG)	Add \$1048 Pure Clear ShowerGuard (PG), Pure Silk (PS), Tempest* (TM)
------------------------------	--	---	-------------------------------------	--	--

Please specify preferred panel positions with all patterned glass options. *Rain & Tempest have a maximum unit height of 80".

Finish Selections (Code)

Add \$0 Chrome (SV)	Add \$146 Brushed Nickel (BN), Matte Black (WI) Oil Rubbed Bronze (OR)	Add \$301 Bronze (BR), Brushed Bronze (BB), Brushed Gold (BG), Satin Nickel (SN), White (WP)
-------------------------------	---	---

Optional Features

- **Custom Height and/or Custom Door Width** - For any non-standard height, add \$250 to the next taller standard height. (For example, for a custom height of 74", add \$250 to the 76" height.) Use 84" height as base for anything greater than 84" tall up to 96" (max. 96"). Add \$250 for any exception to the standard 28" swing door width, either greater or smaller (maximum 36"). **Only one \$250 adder will be applied for a unit with both a custom door width and a custom height.**
- **Angled Ceiling or Floor to Ceiling** - add \$123, **Extra Panel or Transom** - add \$282 (ea), **Swing Out Only** (created by vinyl) or **1/2 Moon Dam (SC889)** - add \$43. **AquaGlideXP on any additional panel** - add \$100 ea.
- **Upgrade to 1/2" glass** - add \$637/model. Limited to Clear, AquaGlideXP Clear, Silk, Pure Clear, Pure Silk, ShowerGuard Clear, or Pure Clear ShowerGuard glass
- **Heavy hinges, offset hinge plate on wall mount hinge, or offset closure angle on any hinge** - add \$80. **Adjustable hinges** - add \$120. **Additional standard hinge** (not required) - add \$244/ea. **Additional/non-standard clamp** (not required) - add \$173/unit. *Specify option when ordering.*
- **French Door option** - add \$597 for an additional swing door.
- **Mitering for Glass-to-Glass Corner** - add \$471

Notes:

- Please note any **out-of-square conditions or notched panel** on drawing. *No additional charges apply.*
- Minimum stationary panel is 6" wide.
- **These models may require additional structural support.** When using wall mount hinges, 36" is the maximum panel width before a support bar is needed. Glass-to-glass hinges always require use of a support bar and minimum hinge panel size is 12". The number of hinges provided will be determined by the application. Adequate wall support (see pg. 86) is required.

Headerless Pivot Hinge Option

- Wall mount or glass-to-glass headerless pivot hinges require no header and position the hinges at the top and bottom of the glass (instead of vertically down the glass) providing the most frameless look possible.
- **Wall Mount pivot hinges** - add \$213 and note option when ordering
- **Glass-to-Glass pivot hinges** - add \$425 and note option when ordering. *Price includes 1/2" glass hinge panel upgrade and/or support pole if required.*
- Pivot hinge extends 5/8" above unit height.
- Units with glass-to-glass pivot hinges feature 3/8" glass door with 1/2" glass hinge panel, and are only available in Clear, AquaGlideXP Clear, Silk, Pure Clear, Pure Silk, ShowerGuard Clear, or Pure Clear ShowerGuard glass options.



3/8" Frameless Swing Door & Panel with Return

Return Configurations

1/4" Glass Semi-Frameless Door, Inline Panel & Return Panel FUSION, INFINITY



Fusion - Model 1450



Features:

- Headerless
- 1/4" Door & 3/8" Panels
- Through-the-glass 6" pull handle
- Full length continuous hinge provides stability
- Glass-to-glass corner
- Left or right configurations

Infinity - Model 1415/1415NP



1415 Model - Includes center post. May hinge from the wall, the center post or the corner post.



1415NP Model - No center post. May hinge from the wall or the corner post.

Features:

- Euro style header
- Through-the-glass 6" pull handle
- Full length continuous hinge provides stability
- With (1415) or without (1415NP) a center post
- Left or right configurations

Infinity Optional Features

- **Infinity C Pull/Towel Bar Combination** - add \$82. To substitute a C Pull/Towel Bar combination option, prefix the unit number with the letter (C). For example - C1415FGOR. Specify hinge side, left or right.
- **Single-Sided Towel Bar** - add \$62. To substitute, specify when ordering.
- **Buttress** - add \$116 ea.; **Notched panel** - add \$174 ea.
- **Special Angle (not 90°) or Glass-to-Glass Corner** - add \$116 ea.
- **Extra Panel** - add \$174. **AquaGlideXP on any additional panel** - add \$100 ea.
- **Glass Panel Out-of-Square** - add \$87 per panel
- **Quick 'N Stall** - add \$82. *Limited to Clear, Obscure, Rain, Eclipse, Clear Etched glass options.*

Fusion Optional Feature

- **Notched panel** - add \$174 ea.

Fusion Notes

- **Fusion Custom Size Door Panel** - Maximum inline opening size is 66". Maximum return panel width is 36".
- No center post - wall hinge only.

Fillers - For best performance, Basco recommends the opening be square and plumb. If the opening curb is out of level beyond 1/4" or walls are out of level beyond 3/8", purchase tapered fillers for proper fit. Please refer to page 89 for part numbers and pricing.



Easy quoting and ordering
Assisted selling by model • Visual door drawing
Dynamic pricing • Save and store

mystro.mybasco.com

To obtain a log-in, email
mystro@basco showerdoor.com

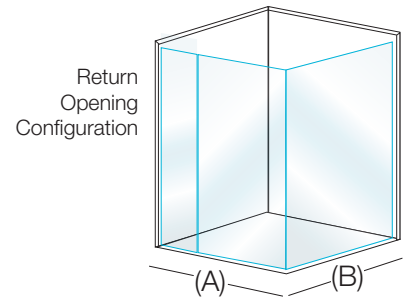

1/4" Semi-Frameless Door, 3/8" Panel & Return Panel, Clear (CL) Glass/Chrome (SV) Finish,

Fusion Model	Inline (A)	Return Panel (B)	Standard Door Width	Standard Height Options				Custom Size
	Specify Centerline Width Between	Specify Centerline Width Up To		63 ³ / ₈ "	66 ⁷ / ₈ "	70 ³ / ₈ "	74 ³ / ₈ "	
1450	36" - 48"	36"	28 ⁷ / ₈ "	\$1703	\$1815	\$1935	\$2061	For a custom door size (max. 36") and/or custom inline width or height (max. 66" x 76")
	48 ¹ / ₁₆ " - 60"	36"	28 ⁷ / ₈ "	\$1992	\$2103	\$2223	\$2348	
<i>Specific finished dimensions (centerline A & B and height) required when ordering.</i>								\$2891

Glass Options (Code)

Add \$0 Clear (CL)	Add \$300 AquaGlideXP Clear (XP)	Add \$132 Rain (RN)	Add \$653 Silk (LK)	Add \$865 ShowerGuardClear (CG) Tempest (TM)
------------------------------	--	-------------------------------	-------------------------------	---

Finish Selections (Code)

Add \$0 Chrome (SV)	Add \$405 Brushed Nickel (BN), Matte Black (WI) Oil Rubbed Bronze (OR)	Add \$634 Bronze (BR), Brushed Bronze (BB), Brushed Gold (BG), Satin Nickel (SN), White (WP)
-------------------------------	---	---

1/4" Semi-Frameless Door, Panel & Return Panel, Clear (CL) Glass/Chrome (SV) Finish,

Infinity Model	Inline (A)	Return Panel (B)	Standard Door Width	Standard Height Options				Custom Size
	Specify Centerline Width Up To	Specify Centerline Width Up To		65 ¹ / ₈ "	68 ⁵ / ₈ "	72 ¹ / ₈ "	76 ¹ / ₈ "	
1415 or 1415NP	38"	38"	24"	\$1677	\$1699	\$2077	\$2194	For a custom door size (max. 36") and/or custom height (max. 84")
	48"	38"	24"	\$1699	\$1719	\$2098	\$2215	
	48"	48"	28 ⁷ / ₈ "	\$1719	\$1741	\$2118	\$2235	
	60"	48"	28 ⁷ / ₈ "	\$1741	\$1761	\$2141	\$2257	
	60"	60"	28 ⁷ / ₈ "	\$1761	\$1782	\$2162	\$2277	

Specific finished dimensions (centerline A & B and height) required when ordering.

Glass Options (Code)

Add \$0 Clear (CL)	Add \$300 AquaGlideXP Clear (XP)	Add \$132 Obscure* (OB), Rain* (RN), Eclipse (EP)	Add \$258 Clear Etched (EE), Vessence* (VS)	Add \$653 Silk (LK)	Add \$865 Tempest* (TM), Fluted* (FG), ShowerGuard Clear** (CG)
------------------------------	--	--	--	-------------------------------	--

**Obscure, Rain, Vessence, Fluted & Tempest have a maximum unit height of 80".*

Finish Selections (Code)

Add \$0 Chrome (SV)	Add \$405 Brushed Nickel (BN), Matte Black (WI) Oil Rubbed Bronze (OR)	Add \$634 Bronze (BR), Brushed Bronze (BB), Brushed Gold (BG), Satin Nickel (SN), White (WP)
-------------------------------	---	---

1/4" Semi-Frameless Swing Door & Panel with Return



Protect Your Investment.

Factory-applied AquaGlideXP is an ultra-protective coating that bonds to the glass, repelling moisture and soap film and is available with any glass option - **add \$300.**

Return Configurations

Framed Door, Inline Panel & Return Panel DELUXE



Deluxe - Model 150



Features:

- Traditional style header
- Full length continuous hinge provides stability
- Left or right configurations

Optional Features

- **Deluxe Curved Towel Bar** - add \$137. To add a curved towel bar to any Deluxe framed hinge door, prefix the unit number with the letter (T). For example - T150CLBR. Specify hinge side, left or right.
- **Buttress** - add \$116 ea.; **Notched Panel** or **Extra Panel** - add \$174 ea. **AquaGlideXP** on any additional panel - add \$100 ea.
- **Special Angle** (*not 90°*) or **Glass-to-Glass Corner**- add \$116 ea.
- **Quick 'N Stall** - add \$82. *Limited to Clear, Obscure, Rain, Eclipse, Clear Etched glass options.*
- **Modified for Steam** - add \$44.

Fillers - For best performance, Basco recommends the opening be square and plumb. If the opening curb is out of level beyond 1/4" or walls are out of level beyond 3/8", purchase tapered fillers for proper fit. Please refer to page 89 for part numbers and pricing.



Easy quoting and ordering
 Assisted selling by model • Visual door drawing
 Dynamic pricing • Save and store
mystro.mybasco.com
 To obtain a log-in, email
 mystro@basco showerdoor.com

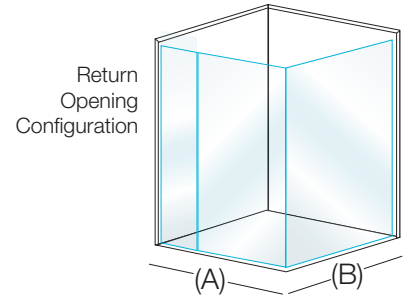

Framed Door, Panel & Return Panel, Clear (CL) Glass/Chrome (SV) Finish,

Deluxe Model	Inline (A) Specify Centerline Width Up To	Return Panel (B) Specify Centerline Width Up To	Standard Door Width	Standard Height Options				Custom Size
				65 ¹ / ₈ "	68 ⁵ / ₈ "	72 ¹ / ₈ "	76 ¹ / ₈ "	
150	38"	38"	24"	\$1478	\$1506	\$1721	\$1862	For a custom door size (max. 36") and/or custom height (max. 84") \$1967
	48"	38"	24"	\$1501	\$1522	\$1742	\$1882	
	48"	48"	28 ⁷ / ₈ "	\$1522	\$1542	\$1763	\$1904	
	60"	48"	28 ⁷ / ₈ "	\$1542	\$1563	\$1785	\$1924	
	60"	60"	28 ⁷ / ₈ "	\$1563	\$1585	\$1806	\$1947	

Specific finished dimensions (centerline A & B and height) required when ordering.

AQUAGLIDE^{XP}
 CLEAN THAT LASTS **Protect Your Investment.**

Factory-applied AquaGlideXP is an ultra-protective coating that bonds to the glass, repelling moisture and soap film and is available with any glass option- **add \$300.**

Glass Options (Code)

Add \$0 Clear (CL)	Add \$300 AquaGlideXP Clear (XP)	Add \$132 Obscure* (OB), Rain* (RN), Eclipse (EP)	Add \$258 Clear Etched (EE), Vessence* (VS)	Add \$653 Silk (LK)	Add \$865 Tempest* (TM), Fluted* (FG)
------------------------------	--	--	--	-------------------------------	---

**Obscure, Rain, Vessence, Fluted & Tempest have a maximum unit height of 80".*

Finish Selections (Code)

Add \$0 Chrome (SV)	Add \$405 Brushed Nickel (BN), Matte Black (WI) Oil Rubbed Bronze (OR)	Add \$634 Bronze (BR), Brushed Bronze (BB), Brushed Gold (BG), Satin Nickel (SN), White (WP)
-------------------------------	---	---

Framed Swing Door & Panel with Return

Return Configurations

3/8" Glass Frameless Rolling door, Inline Panel and Return Panel - **ROLAIRE**

1/4" Glass Semi-Frameless Bypass with Return Panel **Tub/Shower** - INFINITY

Rolaire - Model ROLH-950



Features:

- Barn-door style, elevated header
- Exterior through-the-glass pull handle
- Interior pull knob
- Return Panel must be at a 90° angle
- Left or right configurations (door cannot close into 90° angle)



Infinity - Model 4401 (Tub), 4501 (Shower)



Features:

- Euro style header
- Exterior & interior through-the-glass towel bars
- Through-the-glass roller brackets
- Custom inline panel (24" maximum width)

Rolaire Optional Features

- **Optional towel bar** - add \$352 ea. An 18" towel bar can be added to the inside of the door panel or the outside stationary panels. You may substitute a knob instead of the handle for no additional cost.
- **Extra Panel** - add \$282 each. **AquaGlideXP on an additional panel** - add \$100 ea.
- **Mitering for glass-to-glass corner** is available - add \$471.

Notes

- Heights shown are to the top of the header. Add 3" for roller clearance.
- Please specify shower head side, as well as any out-of-plumb and/or out-of-level conditions to the 1/16 of an inch on drawing. Glass will be cut out of square to accommodate for any out-of-plumb/level condition. Maximum of 1/8" curb out-of-level conditions.
- **Minimum suggested inline width is 45"**. At this width, walk-through opening will be roughly 18³/₁₆", with offset panels. Maximum inline width is 73". Door cannot close into the return panel, and the return panel must be at 90° angle.
- Minimum of a 2³/₁₆" curb and wall jamb width threshold is required. Maximum width and heights are shown above and model cannot be customization beyond these dimensions.

Infinity Optional Features

- **Glass Panel Out-of-Square** - add \$87 per panel
- **Substitute towel bars with single-sided pull handles** - add \$153. Aluminum pulls match frame color (SC4570). Specify at time of order. Showerhead side is required for pull handle option.
- **Buttress** - add \$116 ea. **Notched Panel** - add \$174 ea. **Extra Panel** - add \$174 ea.; **Additional Panel with AquaGlideXP** - add \$125 ea.
- **Knobs** - add \$57. To replace Infinity towel bars with knobs, specify at time of order.

Infinity Fillers - For best performance, Basco recommends the opening be square and plumb. If the opening curb is out of level beyond 1/4" or walls are out of level beyond 3/8", purchase tapered fillers for proper fit. Please refer to page 88 for part numbers and pricing.

Factory-applied AquaGlideXP is an ultra-protective coating that bonds to the glass, repelling moisture and soap film and is available with any glass option- **add \$300.**

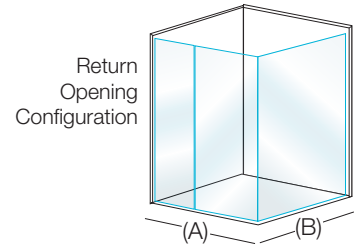

3/8" Frameless Panel/Rolling Door/Return Panel - Clear (CL) Glass/Brushed Stainless Steel Finish

Rolaire Model	Specify Width (A+B) Between	Standard Height Options			Custom Height
		72"	76"	80"	
ROLH-950 <i>Specific finished height is required when ordering.</i>	Up to 62"	\$3195	\$3229	\$3262	For a custom height (max. 80")
	62 ¹ / ₁₆ " - 70"	\$3285	\$3319	\$3352	
	70 ¹ / ₁₆ " - 78"	\$3376	\$3409	\$3444	
	78 ¹ / ₁₆ " - 86"	\$3465	\$3500	\$3533	
	86 ¹ / ₁₆ " - 94"	\$3557	\$3590	\$3624	
	94 ¹ / ₁₆ " - 102"	\$3647	\$3680	\$3714	
	102 ¹ / ₁₆ " - 110"	\$3738	\$3770	\$3805	
	110 ¹ / ₁₆ " - 120"	\$3828	\$3862	\$3894	\$3944

A minimum curb width/threshold & wall jamb width of 2³/₁₆" is required. Specify shower head side when ordering.

Glass Options (Code)

Add \$0 Clear (CL)	Add \$300 AquaGlideXP Clear (XP)	Add \$450 Rain* (RN), Silk (LK)	Add \$577 Pure Clear (PC)	Add \$577 ShowerGuard Clear (CG)	Add \$1048 Pure Clear ShowerGuard (PG), Pure Silk (PS), Tempest* (TM)
-----------------------	-------------------------------------	------------------------------------	------------------------------	-------------------------------------	---

Finish Selections (Code)

Add \$0 Brushed Stainless Steel (BS)	Add \$105 Polished Chrome (PM)	Add \$146 Matte Black (WI)
---	-----------------------------------	-------------------------------

1/4" Semi-Frameless Bypass Tub/Shower with Inline Panel, Clear (CL) Glass/Chrome (SV) Finish

Infinity Model	Sliding Door (A) Width Range	Return Panel (B) Centerline Up To	Standard Height Options		Custom Size	
			57"	65 ¹ / ₂ "		
4401-48	44" - 48"	60"	\$1957	\$2030	For a custom width and/or height (max. 96"w x 80"h) Model 4501-00 \$2501	
4401-52	48 ¹ / ₁₆ " - 52"	60"	\$1977	\$2050		
4401-56	52 ¹ / ₁₆ " - 56"	60"	\$1996	\$2068		
4401-60	54 ¹ / ₂ " - 58 ¹ / ₂ "	60"	\$2003	\$2088		
Infinity Model	Sliding Door (A) Width Range	Return Panel (B) Centerline Up To	Standard Height Options			<i>Specific finished width & height is required when ordering.</i>
			65 ¹ / ₂ "	70"	76"	
4501-40	36" - 40"	60"	\$1991	\$2011	\$2140	
4501-44	40 ¹ / ₁₆ " - 44"	60"	\$2011	\$2030	\$2160	
4501-48	43" - 47"	60"	\$2030	\$2050	\$2179	
4501-52	48" - 52"	60"	\$2050	\$2068	\$2198	
4501-56	52 ¹ / ₁₆ " - 56"	60"	\$2068	\$2088	\$2217	
4501-60	54 ¹ / ₂ " - 58 ¹ / ₂ "	60"	\$2088	\$2107	\$2237	

Glass Options (Code)

Add \$0 Clear (CL)	Add \$300 AquaGlideXP Clear (XP)	Add \$132 Obscure* (OB), Rain* (RN), Eclipse (EP)	Add \$258 Clear Etched (EE), Vessence* (VS)	Add \$653 Silk (LK)	Add \$865 Tempest* (TM), Fluted* (FG), ShowerGuard Clear** (CG)
-----------------------	-------------------------------------	---	---	------------------------	---

Finish Selections (Code)

Add \$0 Chrome (SV)	Add \$405 Brushed Nickel (BN), Matte Black (WI) Oil Rubbed Bronze (OR)	Add \$634 Bronze (BR), Brushed Bronze (BB), Brushed Gold (BG), Satin Nickel (SN), White (WP)
------------------------	--	--

Rolling Door/Fixed Panel & Bypass with Return Panel

Neo Angle Configurations

3/8" Glass Frameless Door with 135° Angled Panels CELESTA & DRESDEN

Celesta - Model CELN-960 (no header) / CELH-960 (header)

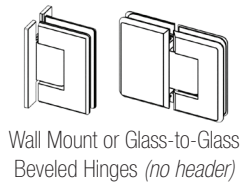

Dresden - Model DREN-960 (no header) / DREH-960 (header)

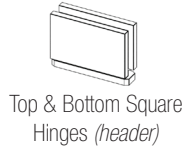
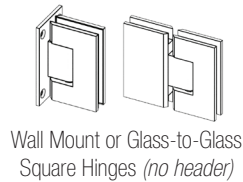
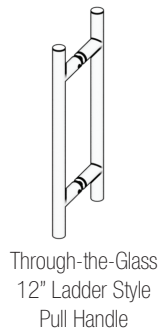

Optional Features

- **Custom Height** - For any non-standard height, add \$250 to the next taller standard height. (For example, for a custom height of 74", add \$250 to the 76" height.) Use 84" height as base for anything greater than 84" tall up to 96" (max. 96").
- **Angled Ceiling or Floor to Ceiling** - add \$123, **Extra Panel or Transom** - add \$282 (ea), **Swing Out Only** (created by vinyl) or **1/2 Moon Dam** (SC889) - add \$43. **AquaGlideXP** to any additional panel - add \$100 ea.
- **Upgrade to 1/2" glass** - add \$637/model. Limited to Clear, AquaGlideXP Clear, Silk, Pure Clear, Pure Silk, ShowerGuard Clear, or Pure Clear ShowerGuard glass
- **Heavy hinges, offset hinge plate on wall mount hinge, or offset closure angle on any hinge** - add \$80. **Adjustable hinges** - add \$120. **Additional standard hinge** (not required) - add \$244/ea. **Additional/non-standard clamp** (not required) - add \$173/unit. *Specify when ordering.*

- **French Door option** - add \$597 for an additional swing door.

Notes

- Please note any **out-of-square conditions or notched panel** on drawing. *No additional charges apply.*
- Minimum stationary panel is 6" wide.
- **These models may require additional structural support.** When using wall mount hinges, 36" is the maximum panel width before a support bar is needed. Glass-to-glass hinges always require use of a support bar and minimum hinge panel size is 12". The number of hinges provided will be determined by the application. Adequate wall support (see pg. 86) is required.

Features:

- No Header (...**N**-960) or with Header (...**H**-960)
- Through-the-glass pull handle
- Wall mount or glass-to-glass hinges
- Left or right configurations

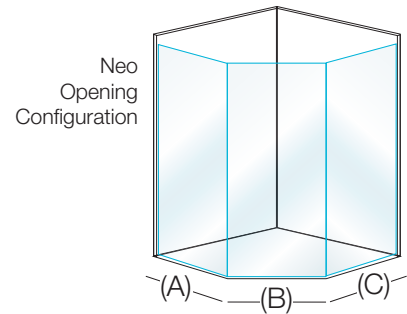

3/8" Frameless Door & Neo Angle Return Panels, Clear (CL) Glass/Chrome (SV) Finish

Celesta Model	Specify Width (A+B+C) Between	Standard Height Options				Custom Height	
		72"	76"	80"	84"		
CELN-960 (No Header)	Up to 62"	\$2897	\$2942	\$2986	\$3030	For a custom height add \$250 to the next taller Standard Height price. <i>See notes for additional information & example.</i>	
	62 ¹ / ₁₆ " - 70"	\$3069	\$3116	\$3163	\$3208		
CELH-960 (Header)	70 ¹ / ₁₆ " - 78"	\$3239	\$3289	\$3338	\$3388		
	78 ¹ / ₁₆ " - 86"	\$3410	\$3463	\$3515	\$3570		
	86 ¹ / ₁₆ " - 94"	\$3584	\$3638	\$3692	\$3747		
	94 ¹ / ₁₆ " - 102"	\$3754	\$3812	\$3867	\$3925		
<i>Specific finished dimensions (centerlines A, B & C and height) required when ordering.</i>	102 ¹ / ₁₆ " - 110"	\$3924	\$3984	\$4045	\$4105		<ul style="list-style-type: none"> • Maximum width for the swing door is 36". • Maximum width for each panel is 70".
	110 ¹ / ₁₆ " - 120"	\$4099	\$4159	\$4222	\$4284		
	120 ¹ / ₁₆ " - 176"	\$4482	\$4542	\$4604	\$4668		

Upgrade to 1/2" Glass - add \$637

3/8" Frameless Door & Neo Angle Return Panels, Clear (CL) Glass/Chrome (SV) Finish

Dresden Model	Specify Width (A+B+C) Between	Standard Height Options				Custom Height	
		72"	76"	80"	84"		
DREN-960 (No Header)	Up to 62"	\$3022	\$3067	\$3111	\$3155	For a custom height add \$250 to the next taller Standard Height price. <i>See notes for additional information & example.</i>	
	62 ¹ / ₁₆ " - 70"	\$3194	\$3241	\$3288	\$3333		
DREH-960 (Header)	70 ¹ / ₁₆ " - 78"	\$3364	\$3414	\$3463	\$3513		
	78 ¹ / ₁₆ " - 86"	\$3535	\$3588	\$3640	\$3695		
	86 ¹ / ₁₆ " - 94"	\$3709	\$3763	\$3817	\$3872		
	94 ¹ / ₁₆ " - 102"	\$3879	\$3937	\$3992	\$4050		
<i>Specific finished dimensions (centerlines A, B & C and height) required when ordering.</i>	102 ¹ / ₁₆ " - 110"	\$4049	\$4109	\$4170	\$4230		<ul style="list-style-type: none"> • Maximum width for the swing door is 36". • Maximum width for each panel is 70".
	110 ¹ / ₁₆ " - 120"	\$4224	\$4284	\$4347	\$4409		
	120 ¹ / ₁₆ " - 176"	\$4607	\$4667	\$4729	\$4793		

Upgrade to 1/2" Glass - add \$637



Protect Your Investment.

Factory-applied AquaGlideXP is an ultra-protective coating that bonds to the glass, repelling moisture and soap film and is available with any glass option- **add \$300.**

Glass Options (Code)

Add \$0 Clear (CL)	Add \$300 AquaGlideXP Clear (XP)	Add \$450 Rain* (RN), Silk (LK)	Add \$577 Pure Clear (PC)	Add \$577 ShowerGuard Clear (CG)	Add \$1048 Pure Clear ShowerGuard (PG), Pure Silk (PS), Tempest* (TM)
------------------------------	---	---	-------------------------------------	---	--

Finish Selections (Code)

Add \$0 Chrome (SV)	Add \$146 Brushed Nickel (BN), Matte Black (WI) Oil Rubbed Bronze (OR)	Add \$301 Bronze (BR), Brushed Bronze (BB), Brushed Gold (BG), Polished Nickel (PN), Satin Nickel (SN), White (WP)
-------------------------------	---	---

**Polished Nickel is limited to select Celesta hardware only. Please contact Customer Service before ordering.*

3/8" Frameless Neo Angle

Neo Angle Configurations

3/8" Glass Frameless Door with 135° Angled Panels

GEOLUX, TRESOR, VONSE & LUX

Geolux - Model GEON-960 (no header) / GEOH-960 (header)

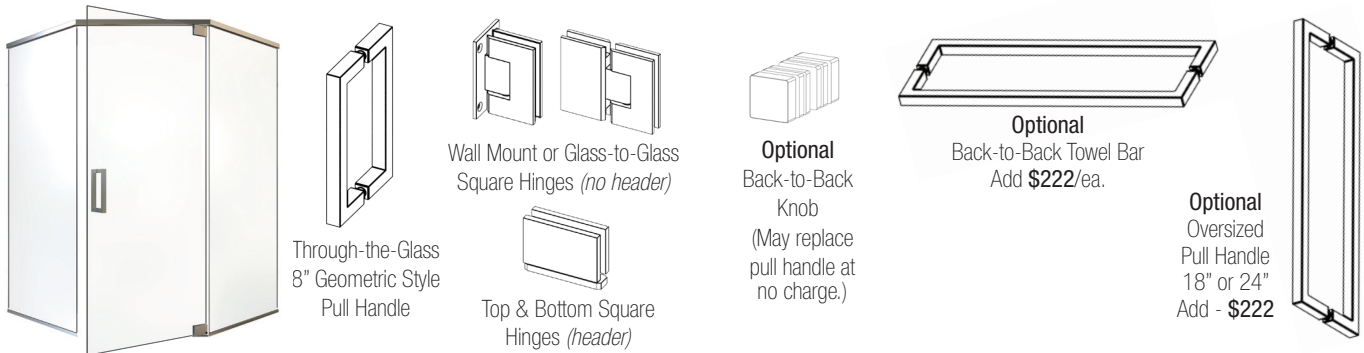

Tresor - Model TREN-960 (no header) / TREH-960 (header)

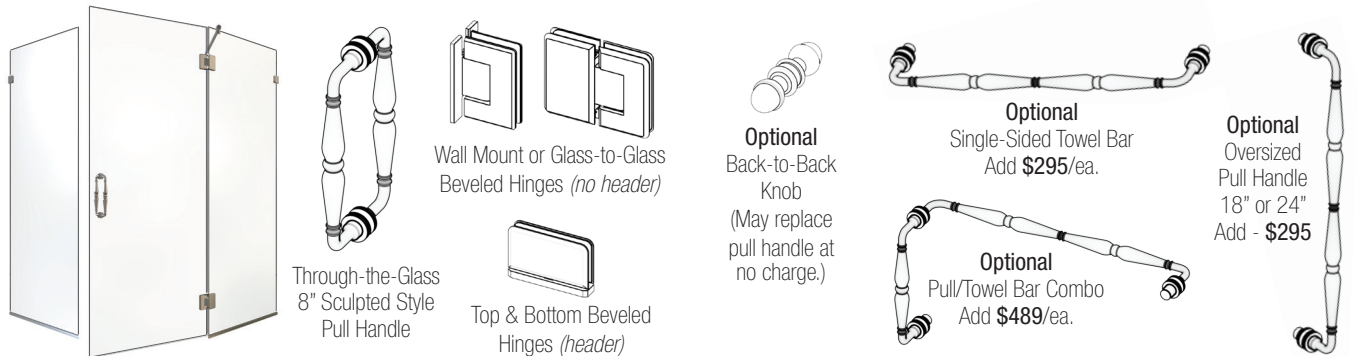

Vonse - Model VONN-960 (no header) / VONH-960 (header)

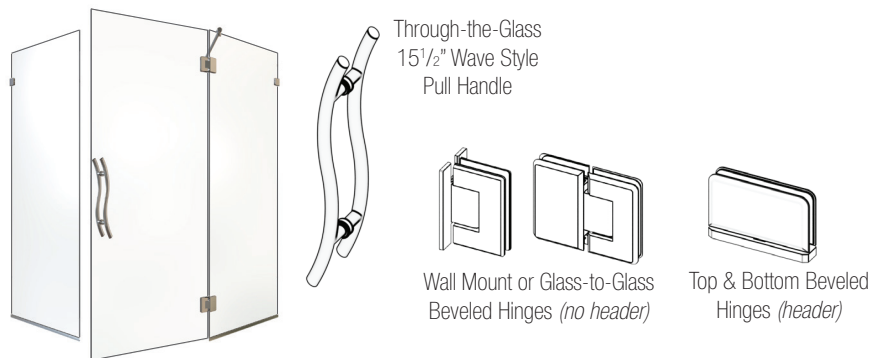

Lux - Model LUXN-960 (no header) / LUXH-960 (header)

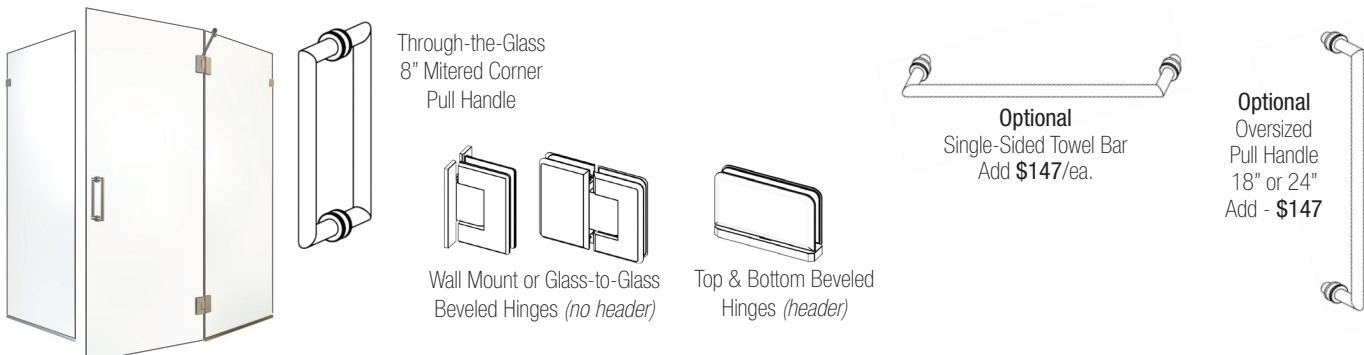

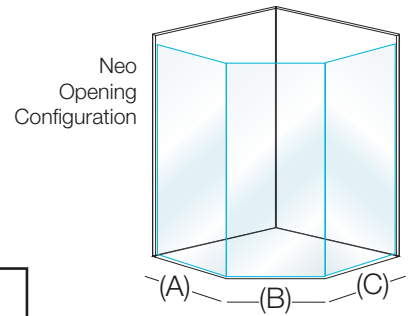

Features:

- No Header (...**N**-960) or with Header (...**H**-960)
- Through-the-glass pull handle
- Wall mount or glass-to-glass hinges
- Left or right configurations

3/8" Frameless Door & Neo Angle Return Panels, Clear (CL) Glass/Chrome (SV) Finish

Model Numbers	Specify Width (A+B+C) Between	Standard Height Options				Custom Height
		72"	76"	80"	84"	
Geolux:	Up to 62"	\$3097	\$3142	\$3186	\$3230	For a custom height add \$250 to the next taller Standard Height price. See notes for additional information & example. • Maximum width for the swing door is 36". • Maximum width for each panel is 70".
GEON-960/GEOH-960	62 ¹ / ₁₆ " - 70"	\$3269	\$3316	\$3363	\$3408	
Tresor:	70 ¹ / ₁₆ " - 78"	\$3439	\$3489	\$3538	\$3588	
TREN-960/TREH-960	78 ¹ / ₁₆ " - 86"	\$3610	\$3663	\$3715	\$3770	
Vonse:	86 ¹ / ₁₆ " - 94"	\$3784	\$3838	\$3892	\$3947	
VONN-960/VONH-960	94 ¹ / ₁₆ " - 102"	\$3954	\$4012	\$4067	\$4125	
Lux:	102 ¹ / ₁₆ " - 110"	\$4124	\$4184	\$4245	\$4305	
LUXN-960/LUXH-960	110 ¹ / ₁₆ " - 120"	\$4299	\$4359	\$4422	\$4484	
	120 ¹ / ₁₆ " - 176"	\$4682	\$4742	\$4804	\$4868	

Specific finished dimensions (centerlines A, B & C and height) required when ordering. **Upgrade to 1/2" Glass - add \$637**

AQUAGLIDE^{XP}
CLEAN THAT LASTS **Protect Your Investment.**
 Factory-applied AquaGlideXP is an ultra-protective coating that bonds to the glass, repelling moisture and soap film and is available with any glass option - **add \$300.**

Glass Options (Code)

Add \$0 Clear (CL)	Add \$300 AquaGlideXP Clear (XP)	Add \$450 Rain* (RN), Silk (LK)	Add \$577 Pure Clear (PC)	Add \$577 ShowerGuard Clear (CG)	Add \$1048 Pure Clear ShowerGuard (PG), Pure Silk (PS), Tempest* (TM)
------------------------------	--	---	-------------------------------------	--	--

Please specify preferred panel positions with all patterned glass options. *Rain & Tempest have a maximum unit height of 80".

Finish Selections (Code)

Add \$0 Chrome (SV)	Add \$146 Brushed Nickel (BN), Matte Black (Wl) Oil Rubbed Bronze (OR)	Add \$301 Bronze (BR), Brushed Bronze (BB), Brushed Gold (BG), Satin Nickel (SN), White (WP)
-------------------------------	---	---

Optional Features

- **Custom Height** - For any non-standard height, add \$250 to the next taller standard height. (For example, for a custom height of 74", add \$250 to the 76" height.) Use 84" height as base for anything greater than 84" tall up to 96" (max. 96").
- **Angled Ceiling or Floor to Ceiling** - add \$123, **Extra Panel** or **Transom** - add \$282 (ea), **Swing Out Only** (created by vinyl) or **1/2 Moon Dam** (SC889) - add \$43. **AquaGlideXP** to any additional panel - add \$100 ea.
- **Upgrade to 1/2" glass** - add \$637/model. Limited to Clear, AquaGlideXP Clear, Silk, Pure Clear, Pure Silk, ShowerGuard Clear, or Pure Clear ShowerGuard glass
- **Heavy hinges, offset hinge plate on wall mount hinge, or offset closure angle on any hinge** - add \$80. **Adjustable hinges** - add \$120. **Additional standard hinge** (not required) - add \$244/ea. **Additional/non-standard clamp** (not required) - add \$173/unit. *Specify when ordering.*
- **French Door option** - add \$597 for an additional swing door.

Notes

- Please note any **out-of-square conditions** or **notched panel** on drawing. *No additional charges apply.*
- Minimum stationary panel is 6" wide.
- **These models may require additional structural support.** When using wall mount hinges, 36" is the maximum panel width before a support bar is needed. Glass-to-glass hinges always require use of a support bar and minimum hinge panel size is 12". The number of hinges provided will be determined by the application. Adequate wall support (see pg. 86) is required.

Neo Angle Configurations

Door with 135° Angled Panels

INFINITY - 1/4" Glass Semi-frameless

DELUXE - Framed



Infinity - Model 1416



Features:

- Euro style header
- Through-the-glass 6" pull handle
- Full length hinge provides stability
- Left or right configurations

Deluxe - Model 160



Features:

- Traditional style header
- Full length hinge provides stability
- Left or right configurations

Optional Features

- **Infinity C Pull/Towel Bar Combination - add \$82.** To substitute a C Pull/Towel Bar combination option, prefix the unit number with the letter (C). For example - C1416FGOR. Specify hinge side, left or right.
- **Deluxe Curved Towel Bar - add \$137.** To add a curved towel bar to any Deluxe Framed hinge door, prefix the unit number with the letter (T). For example - T160CLBR. Specify hinge side, left or right.
- **Buttress - add \$116/ea; Notched Panel or Extra Panel - add \$174/ea; Special Angle (not 135°) - add \$116/ea; AquaGlideXP on any additional panel - add \$100 ea.**
- **Quick 'N Stall - add \$82.** Limited to Clear, Obscure, Rain, Eclipse, Clear Etched glass options.
- **Modified for Steam (Deluxe only) - add \$44.**

Fillers - For best performance, Basco recommends the opening be square and plumb. If the opening curb is out of level beyond 1/4" or walls are out of level beyond 3/8", purchase tapered fillers for proper fit. Please refer to page 89 for part numbers and pricing.



Easy quoting and ordering
 Assisted selling by model • Visual door drawing
 Dynamic pricing • Save and store
mystro.mybasco.com
 To obtain a log-in, email
 mystro@basco showerdoor.com

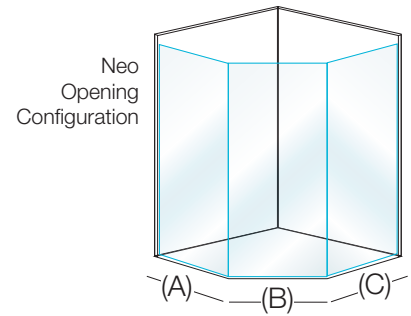

1/4" Semi-frameless Neo Angle, Clear (CL) Glass/Chrome (SV) Finish

Infinity Model	Specify Centerlines Between (A + B + C)	Standard Height Options				Custom Size
		65 ¹ / ₈ "	68 ⁵ / ₈ "	72 ¹ / ₈ "	76 ¹ / ₈ "	
1416	Up to 72"	\$1889	\$1911	\$2384	\$2515	For custom height (Maximum 84") \$2620 Maximum width for swing door is 36".
	72 ¹ / ₁₆ " - 84"	\$1911	\$1930	\$2405	\$2537	
	84 ¹ / ₁₆ " - 96"	\$1930	\$1952	\$2425	\$2557	
	96 ¹ / ₁₆ " - 108"	\$1952	\$1972	\$2447	\$2579	

Specific finished dimensions (centerlines A, B & C and height) required when ordering.

Framed Neo Angle, Clear (CL) Glass/Chrome (SV) Finish

Deluxe Model	Specify Centerlines Between (A + B + C)	Standard Height Options				Custom Size
		65 ¹ / ₈ "	68 ⁵ / ₈ "	72 ¹ / ₈ "	76 ¹ / ₈ "	
160	Up to 72"	\$1469	\$1489	\$1766	\$1907	For custom height (Maximum 84") \$2012 Maximum width for swing door is 36".
	72 ¹ / ₁₆ " - 84"	\$1489	\$1511	\$1787	\$1929	
	84 ¹ / ₁₆ " - 96"	\$1511	\$1533	\$1809	\$1949	
	96 ¹ / ₁₆ " - 108"	\$1533	\$1554	\$1830	\$1971	

Specific finished dimensions (centerlines A, B & C and height) required when ordering.

AQUAGLIDE^{XP}
 CLEAN THAT LASTS
Protect Your Investment.
 Factory-applied AquaGlideXP is an ultra-protective coating that bonds to the glass, repelling moisture and soap film and is available with any glass option- **add \$300.**

Glass Options (Code)

Add \$0 Clear (CL)	Add \$300 AquaGlideXP Clear (XP)	Add \$132 Obscure* (OB), Rain* (RN), Eclipse (EP)	Add \$258 Clear Etched (EE), Vessence* (VS)	Add \$653 Silk (LK)	Add \$865 Tempest* (TM), Fluted* (FG), ShowerGuard** Clear (CG)
------------------------------	--	--	--	-------------------------------	--

*Obscure, Rain, Vessence, Fluted & Tempest have a maximum unit height of 80". **ShowerGuard Clear is only available with Infinity models.

Finish Selections (Code)

Add \$0 Chrome (SV)	Add \$405 Brushed Nickel (BN), Matte Black (WI) Oil Rubbed Bronze (OR)	Add \$634 Bronze (BR), Brushed Bronze (BB), Brushed Gold (BG), Satin Nickel (SN), White (WP)
-------------------------------	---	---

Semi-Frameless/Framed
Neo Angle

Neo Angle Configurations

Door with 135° Angled Panels

INFINITY - 1/4" Glass Semi-frameless

DELUXE - Framed



Infinity - Fiberglass Specific Model 1416



Features:

- Quick-'N-Stall
- Pre-assembled header & curb
- Euro style header
- Through-the-glass 6" pull handle
- Full length hinge provides stability
- Reversible for left or right installation

Deluxe - Fiberglass Specific Model 160



Features:

- Quick-'N-Stall
- Pre-assembled header & curb
- Traditional style header
- Full length hinge provides stability
- Reversible for left or right installation

Optional Features

- **Infinity C Pull/Towel Bar Combination - add \$82.** To substitute a C Pull/Towel Bar combination option, prefix the unit number with the letter (C). For example - C1416AKFGOR. Specify hinge side, left or right.
- **Deluxe Curved Towel Bar - add \$137.** To add a curved towel bar to any Deluxe Framed hinge door, prefix the unit number with the letter (T). For example - T160CLBR. Specify hinge side, left or right.

Notes

- **Quick 'N Stall details-** basco showerdoor.com/installation/quickn-stall. (*Limited to Clear, Obscure, Rain, Eclipse, & Clear Etched glass options.*)

Fillers - For best performance, Basco recommends the opening be square and plumb. If the opening curb is out of level beyond 1/4" or walls are out of level beyond 3/8", purchase tapered fillers for proper fit. Please refer to page 89 for part numbers and pricing.

Please verify all Modular centerline dimensions prior to ordering. Proper dimensions for installation are the sole responsibility of the purchaser.

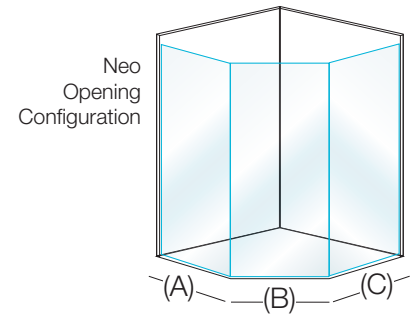

1/4" Semi-Frameless Neo Angle, Clear (CL) Glass/Chrome (SV) Finish

Infinity Model	Fiberglass Manufacturer Model Number	Centerline Dimensions & Height	List	Infinity Model	Fiberglass Manufacturer Model Number	Centerline Dimensions & Height	List
1416AK	Aker KDNAS	15 ⁷ / ₈ " x 26 ³ / ₈ " x 15 ¹ / ₈ " x 68 ⁵ / ₈ "	\$1759	1416LSB	Aquatic 1382NA2P	17 ⁵ / ₈ " x 23 ⁷ / ₈ " x 17 ⁵ / ₈ " x 65 ¹ / ₈ "	\$1759
1416AKA	Aker SH-NA	17 ¹ / ₂ " x 24 ³ / ₈ " x 17 ¹ / ₂ " x 68 ⁵ / ₈ "		1416LSC	Aquatic 1382NAT	17 ¹ / ₂ " x 22 ⁵ / ₈ " x 17 ¹ / ₂ " x 68 ⁵ / ₈ "	
1416AU	Aquarius G3892NA	18 ¹⁵ / ₁₆ " x 23 ⁷ / ₈ " x 18 ¹⁵ / ₁₆ " x 68 ⁵ / ₈ "		1416MTA	Mustee 3838C	18 ¹⁵ / ₁₆ " x 23 ³ / ₈ " x 18 ¹⁵ / ₁₆ " x 68 ⁵ / ₈ "	
1416CN	Clarion SP3838 Neo	16 ⁷ / ₈ " x 24 ¹ / ₄ " x 16 ⁷ / ₈ " x 68 ⁵ / ₈ "		1416MTB	Mustee 3636C	16 ⁷ / ₈ " x 24 ¹ / ₄ " x 16 ⁷ / ₈ " x 68 ⁵ / ₈ "	
1416FL	Floestone Neo 38"	17 ¹ / ₂ " x 24 ⁷ / ₈ " x 17 ¹ / ₂ " x 68 ⁵ / ₈ "		1416RL	Royal Bath N3838	16 ³ / ₄ " x 25" x 16 ³ / ₄ " x 68 ⁵ / ₈ "	
1416FZ	Fiberez #12	16 ⁷ / ₈ " x 24 ¹ / ₄ " x 16 ⁷ / ₈ " x 68 ⁵ / ₈ "		1416SO	Salo 138/238	16 ¹ / ₂ " x 24 ¹ / ₄ " x 16 ¹ / ₂ " x 68 ⁵ / ₈ "	
1416HM	Hamilton 4080	18" x 23 ⁷ / ₈ " x 18" x 68 ⁵ / ₈ "		1416ST	Sterling V38NHG	15 ⁷ / ₈ " x 27 ⁷ / ₈ " x 15 ⁷ / ₈ " x 67 ⁵ / ₈ "	
1416KH	Kohler K1517	15 ¹ / ₂ " x 28 ¹ / ₈ " x 15 ¹ / ₂ " x 68 ⁵ / ₈ "		1416SWA	Swan R38NEO	18 ¹⁵ / ₁₆ " x 23 ³ / ₈ " x 18 ¹⁵ / ₁₆ " x 68 ⁵ / ₈ "	
1416LSA	Aquatic 1382NAC & /1382NACK	17 ¹ / ₂ " x 22 ⁵ / ₈ " x 17 ¹ / ₂ " x 65 ¹ / ₈ "		1416SWB	Swan R36NEO	16 ⁷ / ₈ " x 24 ¹ / ₄ " x 16 ⁷ / ₈ " x 68 ⁵ / ₈ "	
				1416WR	Warm Rain 490	16 ³ / ₄ " x 25" x 16 ³ / ₄ " x 68 ⁵ / ₈ "	

Framed Neo Angle, Clear (CL) Glass/Chrome (SV) Finish

Deluxe Model	Fiberglass Manufacturer Model Number	Centerline Dimensions & Height	List	Deluxe Model	Fiberglass Manufacturer Model Number	Centerline Dimensions & Height	List
160AK	Aker KDNAS	15 ⁷ / ₈ " x 26 ³ / ₈ " x 15 ¹ / ₈ " x 68 ⁵ / ₈ "	\$1047	160LSB	Aquatic 1382NA2P	17 ⁵ / ₈ " x 23 ⁷ / ₈ " x 17 ⁵ / ₈ " x 65 ¹ / ₈ "	\$1047
160AKA	Aker SH-NA	17 ¹ / ₂ " x 24 ³ / ₈ " x 17 ¹ / ₂ " x 68 ⁵ / ₈ "		160LSC	Aquatic 1382NAT	17 ¹ / ₂ " x 22 ⁵ / ₈ " x 17 ¹ / ₂ " x 68 ⁵ / ₈ "	
160AU	Aquarius G3892NA	18 ¹⁵ / ₁₆ " x 23 ⁷ / ₈ " x 18 ¹⁵ / ₁₆ " x 68 ⁵ / ₈ "		160MTA	Mustee 3838C	18 ¹⁵ / ₁₆ " x 23 ³ / ₈ " x 18 ¹⁵ / ₁₆ " x 68 ⁵ / ₈ "	
160CN	Clarion SP3838 Neo	16 ⁷ / ₈ " x 24 ¹ / ₄ " x 16 ⁷ / ₈ " x 68 ⁵ / ₈ "		160MTB	Mustee 3636C	16 ⁷ / ₈ " x 24 ¹ / ₄ " x 16 ⁷ / ₈ " x 68 ⁵ / ₈ "	
160FL	Floestone Neo 38"	17 ¹ / ₂ " x 24 ⁷ / ₈ " x 17 ¹ / ₂ " x 68 ⁵ / ₈ "		160RL	Royal Bath N3838	16 ³ / ₄ " x 25" x 16 ³ / ₄ " x 68 ⁵ / ₈ "	
160FZ	Fiberez #12	16 ⁷ / ₈ " x 24 ¹ / ₄ " x 16 ⁷ / ₈ " x 68 ⁵ / ₈ "		160SO	Salo 138/238	16 ¹ / ₂ " x 24 ¹ / ₄ " x 16 ¹ / ₂ " x 68 ⁵ / ₈ "	
160HM	Hamilton 4080	18" x 23 ⁷ / ₈ " x 18" x 68 ⁵ / ₈ "		160ST	Sterling V38NHG	15 ⁷ / ₈ " x 27 ⁷ / ₈ " x 15 ⁷ / ₈ " x 67 ⁵ / ₈ "	
160KH	Kohler K1517	15 ¹ / ₂ " x 28 ¹ / ₈ " x 15 ¹ / ₂ " x 68 ⁵ / ₈ "		160SWA	Swan R38NEO	18 ¹⁵ / ₁₆ " x 23 ³ / ₈ " x 18 ¹⁵ / ₁₆ " x 68 ⁵ / ₈ "	
160LSA	Aquatic 1382NAC & /1382NACK	17 ¹ / ₂ " x 22 ⁵ / ₈ " x 17 ¹ / ₂ " x 65 ¹ / ₈ "		160SWB	Swan R36NEO	16 ⁷ / ₈ " x 24 ¹ / ₄ " x 16 ⁷ / ₈ " x 68 ⁵ / ₈ "	
				160WR	Warm Rain 490	16 ³ / ₄ " x 25" x 16 ³ / ₄ " x 68 ⁵ / ₈ "	

AQUAGLIDE^{XP}
CLEAN THAT LASTS **Protect Your Investment.**
 Factory-applied AquaGlideXP is an ultra-protective coating that bonds to the glass, repelling moisture and soap film and is available with any glass option- **add \$300.**

Glass Options (Code)

Add \$0 Clear (CL)	Add \$300 AquaGlideXP Clear (XP)	Add \$132 Obscure (OB), Rain (RN), Eclipse (EP)	Add \$258 Clear Etched (EE), Vessence (VS)	Add \$653 Silk (LK)	Add \$865 Tempest (TM), Fluted (FG), ShowerGuard* Clear (CG)
------------------------------	--	--	---	-------------------------------	---

**ShowerGuard Clear is only available with Infinity models.*

Finish Selections (Code)

Add \$0 Chrome (SV)	Add \$405 Brushed Nickel (BN), Matte Black (WI) Oil Rubbed Bronze (OR)	Add \$634 Bronze (BR), Brushed Bronze (BB), Brushed Gold (BG), Satin Nickel (SN), White (WP)
-------------------------------	---	---

Semi-Frameless/Framed Neo Angle

Standard Size Models

3/8" Glass Semi-Frameless Bypass

ROTOLO & CELESTA

3/8" Glass Frameless Rolling Door/Fixed Panel

ROLAIRE

Rotolo - Model RTLA-905



Features:

- Modern header rail with top rollers
- Exterior through-the-glass towel bar
- Interior pull knob
- Left or right configurations

Celesta - Model CELA-905

Formerly known as 2850A/3850A



Features:

- Euro style, curved, modern header
- Interior & exterior through-the-glass towel bars
- Through-the-glass roller bracket

Rolaire - Model ROLA-935



Features:

- Barn-door style, elevated header
- Exterior through-the-glass pull handle
- Interior pull knob
- Left or right configurations

Rotolo Notes

- Minimum of 2³/₄" curb width/threshold is required.
- See pages 8 - 9 for custom options.

Celesta Notes

- See page 10 - 11 for custom options.

Rolaire Notes

- Heights shown are to the top of the header. Add 3" for roller clearance.
- See page 26 - 27 for custom options.
- Please specify shower head side, as well as any out-of-plumb and/or out-of-level conditions to the 1/16 of an inch on drawing. Glass will be cut out of square to accommodate for any out-of-plumb/level condition. Maximum of 1/8" curb out-of-level conditions.

Rotolo & Celesta Fillers - For best performance, Basco recommends the opening be square and plumb. If the opening curb is out of level beyond 1/4" or walls are out of plumb beyond 3/8", purchase tapered fillers for proper fit. Please refer to page 88 for part numbers and pricing.

3/8" Semi-Frameless Bypass Shower - Clear (CL) Glass/Chrome (SV) Finish

Rotolo Model	Fits Openings Between	76" Height	Rotolo Model	Fits Openings Between	76" Height
RTLA-905-4876	44" - 48"	\$1472	RTLA-905-6076	56" - 60"	\$1552

A minimum curb width/threshold of 2³/₄" is required. Specify shower head side when ordering.

3/8" Glass Options (Code)

Add \$0 Clear (CL)	Add \$200 AquaGlideXP Clear (XP)
-----------------------	-------------------------------------

Rotolo Finish Selections (Code)

Add \$0 Chrome (SV)	Add \$146 Brushed Nickel (BN), Oil Rubbed Bronze (OR)
------------------------	--

3/8" Semi-Frameless Bypass Tub/Shower - Clear (CL) Glass/Chrome (SV) Finish

Celesta Model	Fits Openings Between	58 ¹ / ₄ " Height	Celesta Model	Fits Openings Between	71 ¹ / ₄ " Height
CELA-905-6058	56" - 60"	\$1238	CELA-905-4871	44" - 48"	\$1175
			CELA-905-6071	56" - 60"	\$1343

3/8" Glass Options (Code)

Add \$0 Clear (CL)	Add \$200 AquaGlideXP Clear (XP)
-----------------------	-------------------------------------

Celesta Finish Selections (Code)

Add \$0 Chrome (SV)	Add \$146 Brushed Nickel (BN), Oil Rubbed Bronze (OR)
------------------------	--

3/8" Frameless Rolling Door/Fixed Panel - Clear (CL) Glass/Brushed Stainless Steel (BS) Finish

Rolaire Model	Fits Openings Between	76" Height	Rolaire Model	Fits Openings Between	76" Height
ROLA-935-4776	45" - 47"	\$1845	ROLA-935-5976	57" - 59"	\$2158
<ul style="list-style-type: none"> Door width is 26", Inline panel width is 22¹/₄" Walk-through opening is 19" - 21" 			<ul style="list-style-type: none"> Door width is 32", Inline panel width is 28¹/₄" Walk-through opening is 25" - 27" 		

Specify shower head side when ordering.

3/8" Glass Options (Code)

Add \$0 Clear (CL)	Add \$200 AquaGlideXP Clear (XP)
-----------------------	-------------------------------------

Rolaire Finish Selections (Code)

Add \$0 Brushed Stainless Steel (BS)	Add \$105 Polished Chrome (PM)
---	-----------------------------------



Protect Your Investment.

Factory-applied AquaGlideXP is an ultra-protective coating that bonds to the glass, repelling moisture and soap film - **add \$200.**

Standard Size Models

3/8" Glass Frameless **Adjustable** Swing Door & Panels CELESTA & COPPIA

3/8" Glass Frameless **Adjustable** Single Swing Door COPPIA

Celesta - Model CELA-935



Features:

- 28" standard door
- 8" through-the-glass pull handle
- Adjustability up to $15/16$ " or 1" for increased plumb and level tolerance on the panel side
- Standard Celesta wall mount hinges

Coppia - Model COPA-935



Features:

- 28" standard door
- 8" through-the-glass pull handle
- Adjustability up to $1\frac{1}{2}$ " for increased plumb and level tolerance
 - 1" adjustment on the panel side
 - $\frac{1}{2}$ " adjustment on the hinge side

Coppia - Model COPA-900



Features:

- 8" through-the-glass pull handle
- Adjustability up to 1" for increased plumb and level tolerance
 - $\frac{1}{2}$ " adjustment on the hinge side
 - $\frac{1}{2}$ " adjustment on the handle side

Notes

- See page 18 - 19 for custom 3/8" glass door & panel options.
- See page 30 - 31 for custom 3/8" glass single swing door options.
- Easy, reversible installation for left or right entry.
- Please note shower head side when ordering.
- Coppia models are applicable for fiberglass installation.

Factory-applied AquaGlideXP is an ultra-protective coating that bonds to the glass, repelling moisture and soap film. *Refer to Glass Options for adder.*

3/8" Frameless Door & Inline Panel, Clear (CL) Glass/Chrome (SV) Finish

Celesta Model	Fits Openings Between	Standard Door Width	72" Height	Celesta Model	Fits Openings Between	Standard Door Width	76" Height
CELA-935-4672	45" - 46"	28"	\$1332	CELA-935-4676	45" - 46"	28"	\$1354
CELA-935-4772	46 ¹ / ₁₆ " - 47"	28"	\$1332	CELA-935-4776	46 ¹ / ₁₆ " - 47"	28"	\$1354
CELA-935-5872	57" - 58"	28"	\$1389	CELA-935-5876	57" - 58"	28"	\$1412
CELA-935-5972	58 ¹ / ₁₆ " - 59"	28"	\$1389	CELA-935-5976	58 ¹ / ₁₆ " - 59"	28"	\$1412

3/8" Frameless Door & Inline Panel, Clear (CL) Glass/Chrome (SV) Finish

Coppia Model	Fits Openings Between	Standard Door Width	72" Height	Coppia Model	Fits Openings Between	Standard Door Width	76" Height
COPA-935-4772	46 ¹ / ₁₆ " - 47 ⁹ / ₁₆ "	28"	\$1345	COPA-935-4776	46 ¹ / ₁₆ " - 47 ⁹ / ₁₆ "	28"	\$1367
COPA-935-4872	47 ¹ / ₁₆ " - 48 ⁹ / ₁₆ "	28"	\$1364	COPA-935-4876	47 ¹ / ₁₆ " - 48 ⁹ / ₁₆ "	28"	\$1387
COPA-935-5972	58 ¹ / ₁₆ " - 59 ⁹ / ₁₆ "	28"	\$1386	COPA-935-5976	58 ¹ / ₁₆ " - 59 ⁹ / ₁₆ "	28"	\$1409
COPA-935-6072	59 ¹ / ₁₆ " - 60 ⁹ / ₁₆ "	28"	\$1407	COPA-935-6076	59 ¹ / ₁₆ " - 60 ⁹ / ₁₆ "	28"	\$1429

3/8" Door & Panel Glass Options (Code)

Add \$0 Clear (CL)	Add \$200 AquaGlideXP Clear (XP)
-----------------------	-------------------------------------

Finish Selections (Code)

Add \$0 Chrome (SV)	Add \$146 Brushed Nickel (BN), Oil Rubbed Bronze (OR)
------------------------	--

3/8" Frameless Single Swing, Clear (CL) Glass/Chrome (SV) Finish

Coppia Model	Fits Opening Between	72" Height	Coppia Model	Fits Opening Between	76" Height
COPA-900-2472	23 ⁹ / ₁₆ " - 24 ⁹ / ₁₆ "	\$1070	COPA-900-2476	23 ⁹ / ₁₆ " - 24 ⁹ / ₁₆ "	\$1085
COPA-900-2572	24 ⁹ / ₁₆ " - 25 ⁹ / ₁₆ "	\$1079	COPA-900-2576	24 ⁹ / ₁₆ " - 25 ⁹ / ₁₆ "	\$1094
COPA-900-2672	25 ⁹ / ₁₆ " - 26 ⁹ / ₁₆ "	\$1086	COPA-900-2676	25 ⁹ / ₁₆ " - 26 ⁹ / ₁₆ "	\$1103
COPA-900-2772	26 ⁹ / ₁₆ " - 27 ⁹ / ₁₆ "	\$1095	COPA-900-2776	26 ⁹ / ₁₆ " - 27 ⁹ / ₁₆ "	\$1110
COPA-900-2872	27 ⁹ / ₁₆ " - 28 ⁹ / ₁₆ "	\$1104	COPA-900-2876	27 ⁹ / ₁₆ " - 28 ⁹ / ₁₆ "	\$1119
COPA-900-2972	28 ⁹ / ₁₆ " - 29 ⁹ / ₁₆ "	\$1111	COPA-900-2976	28 ⁹ / ₁₆ " - 29 ⁹ / ₁₆ "	\$1126
COPA-900-3072	29 ⁹ / ₁₆ " - 30 ⁹ / ₁₆ "	\$1121	COPA-900-3076	29 ⁹ / ₁₆ " - 30 ⁹ / ₁₆ "	\$1136
COPA-900-3172	30 ⁹ / ₁₆ " - 31 ⁹ / ₁₆ "	\$1129	COPA-900-3176	30 ⁹ / ₁₆ " - 31 ⁹ / ₁₆ "	\$1145
COPA-900-3272	31 ⁹ / ₁₆ " - 32 ⁹ / ₁₆ "	\$1137	COPA-900-3276	31 ⁹ / ₁₆ " - 32 ⁹ / ₁₆ "	\$1152
COPA-900-3372	32 ⁹ / ₁₆ " - 33 ⁹ / ₁₆ "	\$1146	COPA-900-3376	32 ⁹ / ₁₆ " - 33 ⁹ / ₁₆ "	\$1161
COPA-900-3472	33 ⁹ / ₁₆ " - 34 ⁹ / ₁₆ "	\$1154	COPA-900-3476	33 ⁹ / ₁₆ " - 34 ⁹ / ₁₆ "	\$1169
COPA-900-3572	34 ⁹ / ₁₆ " - 35 ⁹ / ₁₆ "	\$1162	COPA-900-3576	34 ⁹ / ₁₆ " - 35 ⁹ / ₁₆ "	\$1177

3/8" Single Swing Glass Options (Code)

Add \$0 Clear (CL)	Add \$100 AquaGlideXP Clear (XP)
-----------------------	-------------------------------------

Finish Selections (Code)

Add \$0 Chrome (SV)	Add \$146 Brushed Nickel (BN), Oil Rubbed Bronze (OR)
------------------------	--

Behind the Walls for Heavy Glass

Our intent at Basco is to ensure that our customers have access to the products they desire based on their style and preferences. As such, please refer to these guidelines for installing heavy glass doors on fiberglass and acrylic substrates.

Structural Support Guidelines

- A Celesta/Roda door on acrylic or fiberglass requires proper blocking to ensure stability.
- A single 2 X 4 stud is needed behind the wall where the header meets the wall on top and bottom pivot units.
- A double 2 X 4 stud is needed behind the wall on the hinge side for wall mount hinges.
- A double 2 X 4 stud is needed at the threshold for hinge mounting and support of the weight.

Precautionary Guidelines

- When the U-Channel or glass clamp is screwed into the threshold, the weight of the glass sits on top of the screws, necessitating the structural support.
- Without proper structural support, when the panel or door is moved this could cause the screws to move slightly. Over time, this slight movement enlarges the hole the screw is in and eventually cracks (spider webs) the gelcoat or acrylic and begins to break down the fiberglass backing.
- Acrylic or fiberglass walls have blocking installed by the manufacturer. However, the location of that backing may not match the location of where holes need to be drilled for vertical u-channel, wall mount hinges, and headers.
- Without proper backing behind the walls the door or panel(s) will eventually slip out of the thin walls.

RODA Product Notes

- Products will be produced using industry best practices and techniques for all hardware, gaps and spacing deductions, horizontal and vertical securing, etc.
- The base and walls for any RODA unit(s) must be constructed with proper wood blocking prior to installation to ensure the weight of the enclosure is properly supported as it may result in product failure. At minimum, 2 x 4 blocking is required at the location of any structural member of the unit including, but not limited to: hinges, clamps, and header brackets. All fasteners at these locations are required to be installed into the blocking. Basco is not liable for cracks on the fiberglass or acrylic modules or product failure of any kind that results from inadequate blocking.
- Depending of the panel size and or door hinge layout, a support bar or header may be required for proper stability.
- Floor to Ceiling panel(s) will be manufactured to be lift and drop when using U-Channel as the horizontal securing method unless noted otherwise.
- Safety tempered glass cannot be cut and is resistant to breakage, but it is susceptible to breakage if improperly handled through unequal pressure or if an unprotected edge comes in contact with any solid surface. Basco is not liable for breakage after installation is completed.

Selling & Ordering Glossary of Terms

Accurate Measurement - Measure your shower door opening width at the bottom, middle, and top.

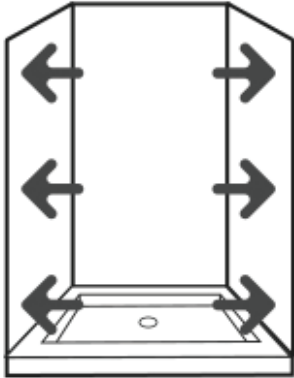

Buttress - A panel that is elevated off of the curb, sometimes called Knee Wall.

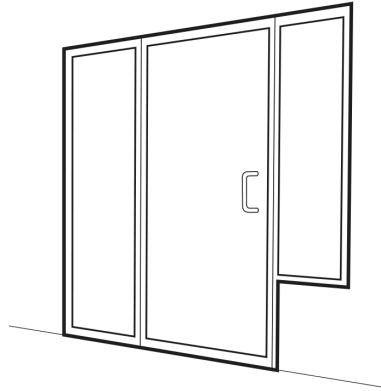

Centerline - An imaginary line used as the center point of the shower enclosure. Often times the center of the curb.

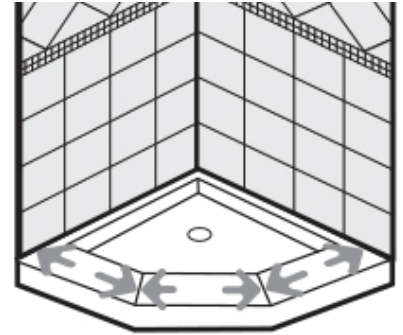

Filler - Additional material which matches enclosure lineals that is used to fill gaps or uneven openings. Fillers may be tapered if required to fill out-of-square or out-of-plumb conditions.

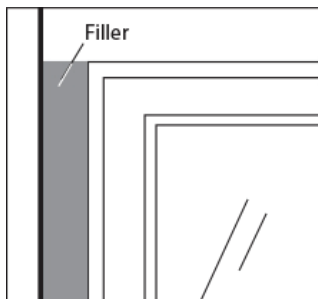

Notch - Cutout(s) or section(s) removed from a panel.

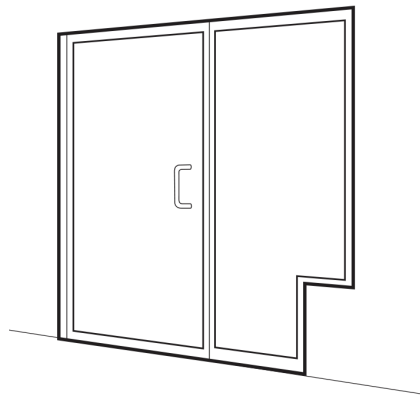

Out-of-Level - Non-level, horizontal curb, ceiling and or buttress wall condition.

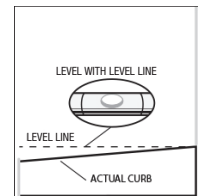

Out-of-Plumb - Non-level, vertical wall condition.

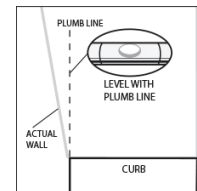

Perfect Overlap - The condition in which a Bypass Slider is sized to have ideal panel sizes to minimize panel overlap and maximize the walk through opening.

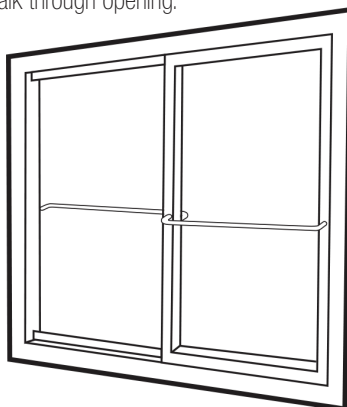

Quick 'N Stall - Features pre-assembled headers and curbs so that the panel(s) snap into place for a quick and easy installation. Learn more: basco showerdoor.com/installation/quickn-stall

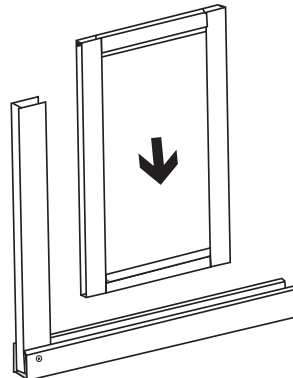

Showerhead Position - Determine showerhead position as if looking at the shower from the outside.



Clean That Lasts

Protect Your Investment Before it Leave the Factory

Basco offers two excellent choices to keep your glass in pristine condition, both backed by warranties.



Guardian ShowerGuard is an engineered glass that permanently protects from etching of the glass, preventing permanent water stains.

- Insures long-lasting beauty of the glass surface, which can always be returned to its original factory sheen.
- Available in 1/4", 3/8" & 1/2" thick Clear glass as well as 3/8" & 1/2" thick Pure Clear (clear low iron) options.
- Clean the glass on your schedule - it can perpetually be restored to like-new conditions.
- **Wiping down the glass after each use is recommended.**
- When registered, installed, regularly maintained according to Guardian's recommendations by water type, Guardian ShowerGuard glass is **backed by a lifetime warranty.**



AquaGlideXP is an ultra-protective coating that bonds to the glass, repelling moisture and soap film. For units treated with AquaGlideXP at the factory, this glass protection carries a 10 year warranty.*

- Low maintenance - requires less cleaning than untreated glass
- Effective water repellent at an affordable price point
- Minimizes mildew, soap scum and hard water build up
- Can be applied to any glass thickness or style
- **Wiping down the glass after each use is recommended**
- Once or twice a week, wipe down your shower door to remove body oils, soaps and shampoos from the surfaces
- **Maintain Spray Cleaner** is the recommended maintenance cleaner, which can be ordered online at: <https://basco showerdoor.com/support/care-cleaning>

*Warranty voided if rough, gritty, highly acidic or abrasive cleaners are used that may damage the AquaGlideXP coating.

Maintenance Tips and Products

Additional Resources
Clean That Lasts



AquaGlide^{XP} Home Protection Kit is an easy three-step process that will provide added protection to any shower enclosure after installation. This innovative coating increases the sheen and luster of the glass while reducing spotting, soap scum and mineral deposits. *Please note that our AquaGlide^{XP} ten year warranty applies only to units with a factory applied coating.*

If AquaGlide^{XP} was applied at the factory, the home kit may be used to revitalize the original coating, extending its protective qualities indefinitely.

Part # AGXPKIT, \$49.00 list.



Basco's **Maintain Spray Cleaner** will enhance the durability and performance of the AquaGlideXP protection when used for deeper cleaning . Most homeowners find that in addition to spraying their doors with water and towel drying daily, using Maintain spray cleaner every one to two weeks keeps their treated doors looking spot free and like new.

- Safe & environmentally friendly water-based cleaner
- Dissolves and lifts oily grime & dirt for a quick wash without water
- Refreshes the protective coating, building on the original application
- Part # RWR16, \$12.99 list.

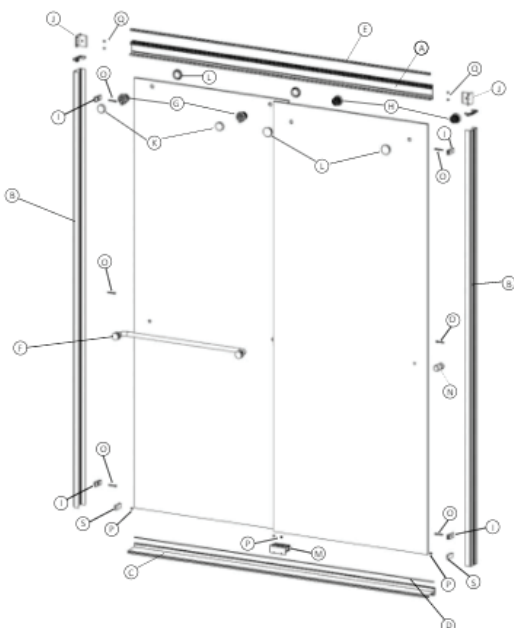

Basco's **Online Parts Store** is a great place to send customers for cleaning products and replacement parts. An easy to use "find your model" search tool will direct the customer to their door and the all the parts available for direct purchase.

- Search tool - bascoshowerdoor.com/shower-door-parts
- Cleaning products - bascoshowerdoor.com/support/care-cleaning
- Popular parts - bascoshowerdoor.com/shower-door-parts/popular-parts

Accessories

Tapered Stock Fillers

For best performance, Basco recommends the opening be square and plumb. If the opening curb or walls are out of level beyond 3/8", purchase tapered fillers for proper fit. Fillers are designed to work with the adjustability of each model.

Fillers are designed to match the metal of each enclosure and are practically invisible once installed. **Each taper starts 1/16" and goes to the length designated below.** When ordering, please use the model number provided and add the desired color code at the end (e.g. SCT891-1461SV for Chrome).

Additional Filler Options:

- **Straight fillers with no taper:** To order a filler of a specific width with no taper, please replace SCT with SC in the model number (e.g. SC891-1461SV). The pricing below still applies.
- **Custom cut-to-size tapered fillers:** To order a filler of a taper or length different from that listed below, please replace SCT with SCX, and include the desired measurements in a note (e.g. SCX891SV, tapered from 3/8" to 5/8", 60" length). Add \$45 to the SCX pricing as shown in the Parts Price list.

Tub/Shower Bypass Fillers:

Model	Filler Type	Taper	Length & Tapered Model Number	Length & Tapered Model Number	Length & Tapered Model Number	SV	BN, WI, OR	All Others
Rotolo Lux & Rotolo	Tub/ Curb	1/4" 1/2" 3/4" 1"	61" SCT891-1461 SCT891-1261 SCT891-3461 SCT891-1061			\$95	\$104	\$122
Rotolo	Wall	1/4" 1/2" 3/4" 1"	57" SCT891-1457 SCT891-1257 SCT891-3457 SCT891-1057	70" SCT891-1470 70" SCT891-1270 70" SCT891-3470 70" SCT891-1070	76" SCT891-1476 76" SCT891-1276 76" SCT891-3476 76" SCT891-1076	\$95	\$104	\$122
Celesta	Tub/ Curb	1/4" 1/2" 3/4" 1"	61" SCT629-1461 SCT629-1261 SCT629-3461 SCT629-1061			\$118	\$135	\$171
Celesta	Wall	1/4" 1/2" 3/4" 1"	58" SCT647-1458 SCT647-1258 SCT647-3458 SCT647-1058	71" SCT647-1471 SCT647-1271 SCT647-3471 SCT647-1071	76" SCT647-1476 SCT647-1276 SCT647-3476 SCT647-1076	\$116	\$133	\$169
Infinity, Classic, & Deluxe	Tub/ Curb	1/4" 1/2" 3/4"	61" SCT907-1461 SCT907-1261 SCT907-3461			\$95	\$104	\$122
Infinity, Classic, & Deluxe	Wall	1/4" 1/2" 3/4" 1"	57" SCT850-1457 SCT850-1257 SCT850-3457 SCT850-1057	71" SCT850-1471 SCT850-1271 SCT850-3471 SCT850-1071	76" SCT850-1476 SCT850-1276 SCT850-3476 SCT850-1076	\$94	\$103	\$121

Finish Selections (Code)

Chrome (SV)	Brushed Nickel (BN), Matte Black (WI) Oil Rubbed Bronze (OR)	Bronze (BR), Brushed Bronze (BB), Brushed Gold (BG), Satin Nickel (SN), White (WP)
-------------	---	---

Out-of-Level
Non-level, horizontal curb, ceiling and or buttress wall condition.

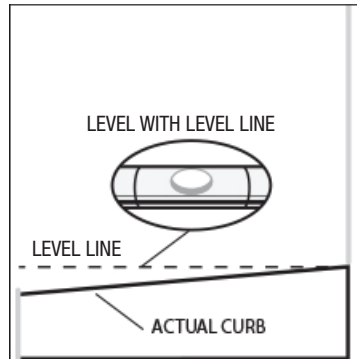

Out-of-Plumb
Non-level, vertical wall condition.

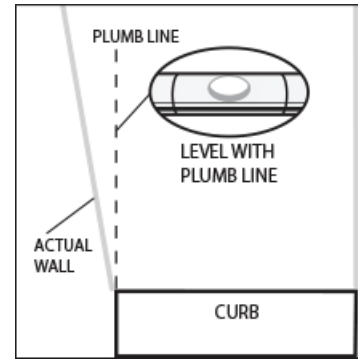

Single Swing Fillers:

Model	Filler Type	Taper	Length & Tapered Model Number	Length & Tapered Model Number	SV	BN, WI OR	All Others					
Infinity & Deluxe	Curb	1/4"	36"	SCT878-1436		\$100	\$109	\$126				
		1/2"		SCT878-1236								
		3/4"		SCT878-3436								
		1"		SCT878-1036								
Infinity & Deluxe	Wall	1/4"	72"	SCT553-1472	76"	SCT553-1476	\$69	\$78	\$95			
		1/2"		SCT553-1272		SCT553-1276						
		3/4"		SCT590-3472		SCT590-3476	\$91	\$100	\$117			
		1"		SCT590-1072		SCT590-1076						
Steam	Curb	1/4"	36"	SCT543-1436		\$83	\$92	\$110				
		1/2"		SCT543-1236								
		3/4"		SCT543-3436								
Steam	Wall	1/4"	80"	SCT553-1480		\$69	\$78	\$95				
		1/2"		SCT553-1280								
		3/4"	80"	SCT590-3480						\$91	\$100	\$117
		1"		SCT590-1080								

French Doors/Door & Panels/Bifold Fillers:

Model	Filler Type	Taper	Length & Model Number	Length & Model Number	SV	BN, WI OR	All Others		
French Doors	Curb	1/4"	61"	SCT878-1461		\$100	\$109	\$126	
		1/2"		SCT878-1261					
		3/4"		SCT878-3461					
		1"		SCT878-1061					
Fusion, Infinity, & Deluxe	Curb	1/4"	61"	SCT543-1461		\$83	\$92	\$110	
		1/2"		SCT543-1261					
		3/4"		SCT543-3461					
Fusion, Infinity, & Deluxe	Wall	1/4"	72"	SCT553-1472	76"	SCT553-1476	\$69	\$78	\$95
		1/2"		SCT553-1272		SCT553-1276			
		3/4"	72"	SCT590-3472	76"	SCT590-3476	\$91	\$100	\$117
		1"		SCT590-1072		SCT590-1076			

Quick Ship Program

Order Today - Shipped Tomorrow



Need a quick turn around on a shower door?

Try our Quick Ship Program -

www.bascoshowerdoor.com/quickship



Speed

Order today and we can ship it tomorrow.

Convenience

Visit our website for our always up-to-date list of Quick Ship doors.

www.bascoshowerdoor.com/quickship

Service

Order by 3:00 PM and the door will ship LTL the next business day with free shipping*.

Quality

Expect the same high quality product from Basco - only faster.

Options

Use the Quick Ship ordering form or your preferred ordering method using Quick Ship model numbers.

Experience

Benefit from more than 65 years of innovation in the industry.

Simple

Put Quick Ship doors on their own purchase order.

Go to bascoshowerdoor.com/quickship to see the current list of available models. To order, please use the Quick Ship model number as shown on the web page for correct lead time and free freight*, & email to orders@bascoshowerdoor.com

*Free Freight limited to states East of the Rockies. Excludes AZ, CA, CO, ID, MT, NV, NM, OR, UT, WA, & WY.

Quick Ship Program

Optional Order Form

Quick Ship Ordering Program Details & Requirements:

- Quick Ship model numbers are required when ordering to receive the correct lead time and free freight*.
- When ordered by 3:00 PM, Quick Ship doors will ship the next business day via LTL with free shipping*.
- Pricing shown below matches current distributor price books. Use Quick Ship model numbers to receive free freight.
- Quick Ship doors require their own PO# and cannot be added to other orders.
- All Quick Ship doors ship directly to the distributor - no address overrides are permitted.
- *Due to supply chain issues, some models listed may not be available. Please refer to the website for current availability.*



Step 1 - Customer Information:

Ship To Customer #: _____

Date: _____

Company Name: _____

PO#: _____

City, State, Zip: _____

Email: _____

Step 2 - Quick Ship Doors - Enter quantity next to the model number:

For product details including model number, size, glass and finish options, please go to: www.bascoshowerdoor.com/quickship

**Free Freight limited to states East of the Rockies. Excludes AZ, CA, CO, ID, MT, NV, NM, OR, UT, WA, & WY.*

Qty	Rotolo Tub Doors	List/Ea.	Qty	Infinity Tub Doors	List/Ea.	Qty	Classic Tub Doors	List/Ea.	Qty	Deluxe Tub Doors	List/Ea.
___	QS5400-6057CLBN	\$1364	___	QS4400-6057CLBN	\$1229	___	QS3400-6057CLBN	\$803	___	QS6150-6058CLBN	\$927
___	QS5400-6057XPBN	\$1564	___	QS4400-6057CLOR	\$1229	___	QS3400-6057CLOR	\$803	___	QS6150-6058CLOR	\$927
___			___	QS4400-6057CLSV	\$959	___	QS3400-6057CLSV	\$638	___	QS6150-6058CLSV	\$679
___	Rotolo Shower Doors		___			___	QS3400-6057OBBN	\$847	___	QS6150-6058OBBN	\$971
___	QS5500-4870CLBN	\$1364	___	Infinity Shower Doors		___	QS3400-6057OBOR	\$847	___	QS6150-6058OBOR	\$971
___	QS5500-4870CLOR	\$1364	___	QS4500-4870CLBN	\$1243	___	QS3400-6057OBSV	\$682	___	QS6150-6058OBSV	\$723
___	QS5500-4870CLSV	\$1094	___	QS4500-4870CLOR	\$1243	___			___		
___	QS5500-4870XPBN	\$1564	___	QS4500-4870CLSV	\$973	___	Classic Shower Doors		___	Deluxe Shower Doors	
___	QS5500-4870XPOR	\$1564	___	QS4500-6070CLBN	\$1431	___	QS3500-4465CLBN	\$765	___	QS7150-4068OBBN	\$972
___	QS5500-4870XPSV	\$1294	___	QS4500-6070CLOR	\$1431	___	QS3500-4465CLOR	\$765	___	QS7150-4068OBOR	\$972
___	QS5500-5670CLBN	\$1531	___	QS4500-6070CLSV	\$1161	___	QS3500-4465CLSV	\$600	___	QS7150-4068OBSV	\$724
___	QS5500-6070CLBN	\$1560				___	QS3500-4465OBBN	\$809	___	QS7150-4068CLBN	\$928
___	QS5500-6070CLOR	\$1560				___	QS3500-4465OBOR	\$809	___	QS7150-4068CLOR	\$928
___	QS5500-6070CLSV	\$1290				___	QS3500-4465OBSV	\$644	___	QS7150-4068CLSV	\$680
___	QS5500-6070CLWI	\$1560				___	QS3500-4470CLSV	\$629	___	QS7150-4468OBSV	\$753
___	QS5500-6070XPBN	\$1760				___	QS3500-4470OBBN	\$838	___	QS7150-4668OBSV	\$767
___	QS5500-6070XPOR	\$1760				___	QS3500-4470OBOR	\$838	___	QS7150-4671OBSV	\$781
___	QS5500-6070XPSV	\$1490				___	QS3500-4870OBSV	\$688	___	QS7150-4871CLSV	\$764
						___	QS3500-4870CLBN	\$809	___	QS7150-4871OBBN	\$1056
						___	QS3500-4870CLOR	\$809	___	QS7150-4871OBOR	\$1056
						___	QS3500-4870CLSV	\$644	___	QS7150-4871OBSV	\$808
						___	QS3500-6070CLBN	\$981	___	QS7150-5268OBSV	\$824
						___	QS3500-6070CLOR	\$981	___	QS7150-5664OBSV	\$837
						___	QS3500-6070CLSV	\$816	___	QS7150-6071OBBN	\$1122
						___	QS3500-6070OBBN	\$1025	___	QS7150-6071OBOR	\$1122
						___	QS3500-6070OBOR	\$1025	___	QS7150-6071OBSV	\$879
						___	QS3500-6070OBSV	\$860	___	QS7150-6071CLBN	\$1083
									___	QS7150-6071CLOR	\$1083
									___	QS7150-6071CLSV	\$835

Step 3 - Email your Quick Ship order to orders@bascoshowerdoor.com

The use of this form is optional - please use Quick Ship model numbers with your preferred ordering method.



7201 Snider Road
Mason, OH 45040
800.45.BASCO
(800.452.2726)
800.989.1919
www.bascoshowerdoor.com