



Owner's Manual with Installation Instructions

Banks High-Ram[®] Assembly

**2003-2007 Ford Power Stroke 6.0L Turbo-Diesel
F250/F350/F450/F550 Trucks**

THIS MANUAL IS FOR USE WITH SYSTEMS 42750 & 42751

Gale Banks Engineering
546 Duggan Avenue • Azusa, CA 91702
(626) 969-9600 • Fax (626) 334-1743

Product Information & Sales: (888) 635-4565
Customer Support: (888) 839-5600
Installation Support: (888) 839-2700

bankspower.com



Also Available from Banks Power



Banks iQ System (P/N 61151-61152)

- 5" touchscreen interface that can control the Banks Diesel Tuner and/or SpeedBrake on the fly.
- Interchangeable gauge display, read and clear codes, monitor engine diagnostics, log data, time your vehicles runs and much more.

Banks Monster® Exhaust System Sport (P/N 48790-48793) Single and Dual (P/N 47285-47292, 47606-47609, 48783-48788)

- Increases exhaust flow, cuts backpressure, lowers exhaust gas temperatures (EGTs) and increases power.

Banks Ram-Air Intake System (P/N 42155)

- Increases your airflow over stock.
- Adds power, improves fuel economy, lowers EGTs and reduces smoke.

Banks Techni-Cooler® System (P/N 25974-25975)

- Provides increased air flow to the engine by increasing air density for more increased power, lower EGTs and improved fuel economy.

Banks Brake (P/N 55467-55468)

- Increases the stopping power of your truck and extends the service life of your brakes

Banks Billet Torque Converter (P/N 72522)

- Higher torque capacity over stock
- Lockup clutch is slip-resistant so transmission fluids stay cooler and transmission life is prolonged.

Banks SpeedBrake iQ Compatible (P/N 55455-55456) PDA Compatible (P/N 55457-55458)

- Allows for controlled hill decent at a user defined vehicle speed.

Boost and Pyro Gauges (P/N 64507)

- Keep your engine safe by monitoring vital engine parameters

**Banks Bullet
(P/N 66524-66525)**

- Adds power safely to your vehicle
- Displays critical engine functions
- Engine safeguards
- Change power levels on-the-fly

**Banks Diesel Tuner
Six-Gun w/ switch (P/N 61023)**

**Six-Gun w/ iQ (P/N 63749)
EconoMind w/ switch (P/N
63743-63745)**

**EconoMind w/ iQ (P/N 63747-
63748)**

- Adds power safely to your vehicle
- Engine and transmission safe guards
- Change power levels on-the-fly

**Banks Speed-Loader
(P/N 62988)**

- Furthers the power output of the Banks Six-Gun and provides EGT limiting safety.

Thermocouple

- Add a temperature limiting function to your Diesel Tuner

**OttoMind Programmer
(P/N 66064)**

- Contains Banks tunes that boost your vehicles HP, Torque and MPG.
- Displays a host of critical engine functions
- Provides "service technician" diagnostic capabilities
- Has upgradeable functionality, so it will never be out of date

**Banks Stinger Systems
(P/N 46465-46486)**

Contains:

- Ram-Air Intake system
- Monster Exhaust (single or dual)
- EconoMind Tuner w/ Banks iQ

**Banks PowerPack Systems
(P/N 46497-46519)**

Contains:

- Ram-Air Intake system
- Monster Exhaust (single or dual)
- EconoMind Tuner w/ Banks iQ
- High-Ram
- Techni-Cooler System

**Banks Six-Gun Bundle
(P/N 46594-46613)**

Contains:

- Ram-Air Intake system
- Monster Exhaust (single or dual)
- Six-Gun Tuner w/ Banks iQ

**Banks Big Hoss Bundle
(P/N 46623-46643)**

Contains:

- Ram-Air Intake system
- Monster Exhaust (single or dual)
- Six-Gun Tuner w/ Banks iQ
- Big Head Wastegate Actuator
- High-Ram
- Techni-Cooler System

**For More Information please call (800) 438-7693
or Visit us online @ www.bankspower.com**

Dear Customer,

If you have any questions concerning the installation of your Banks Techni-Cooler, please call our Technical Service Hotline at (888) 839-2700 between 7:00 am and 5:00 pm (PT). If you have any questions relating to shipping or billing, please contact our Customer Service Department at (888) 839-5600.

Thank you.

Tools Required:

- Drive ratchet
- Ratchet extension
- Inch and metric deep sockets
- Pliers
- Phillips and flat blade screwdrivers
- Inch and metric open end wrenches

Recommended tools:

- Foot-pound torque wrench
- Inch-pound torque wrench

General Installation Practices

- 1.** Before starting work, familiarize yourself with the installation procedure by reading all of the instructions.
- 2.** Throughout this manual, the left side of the vehicle refers to the driver's side, and the right side to the passenger's side.
- 3.** Disconnect the negative (ground) cable from the battery (or batteries, if there are two) before beginning work.
- 4.** Route and tie wires and hoses a minimum of 6" away from exhaust heat, moving parts and sharp edges. Clearance of 8" or more is recommended where possible.
- 5.** When raising the vehicle, support it on properly weight-rated safety stands, ramps or a commercial hoist. Follow the manufacturer's safety

precautions. Take care to balance the vehicle to prevent it from slipping or falling. When using ramps, be sure the front wheels are centered squarely on the topsides. When raising the front of the vehicle, put the transmission in park (automatic) or reverse (manual), set the parking brake, and block the rear wheels. When raising the back of the vehicle, be sure the vehicle is on level ground and the front wheels are blocked securely. **Caution! Do not use floor jacks to support the vehicle while working under it. Do not raise the vehicle onto concrete blocks, masonry or any other item not intended specifically for this use.**

- 6.** During installation, keep the work area clean. Do not allow anything to be dropped into intake, exhaust, or lubrication system components while performing the installation, as foreign objects will cause immediate engine damage upon start-up.

Figure 1. Electronic module near the driver side battery on 2005-07 4-wheel drive equipped vehicles

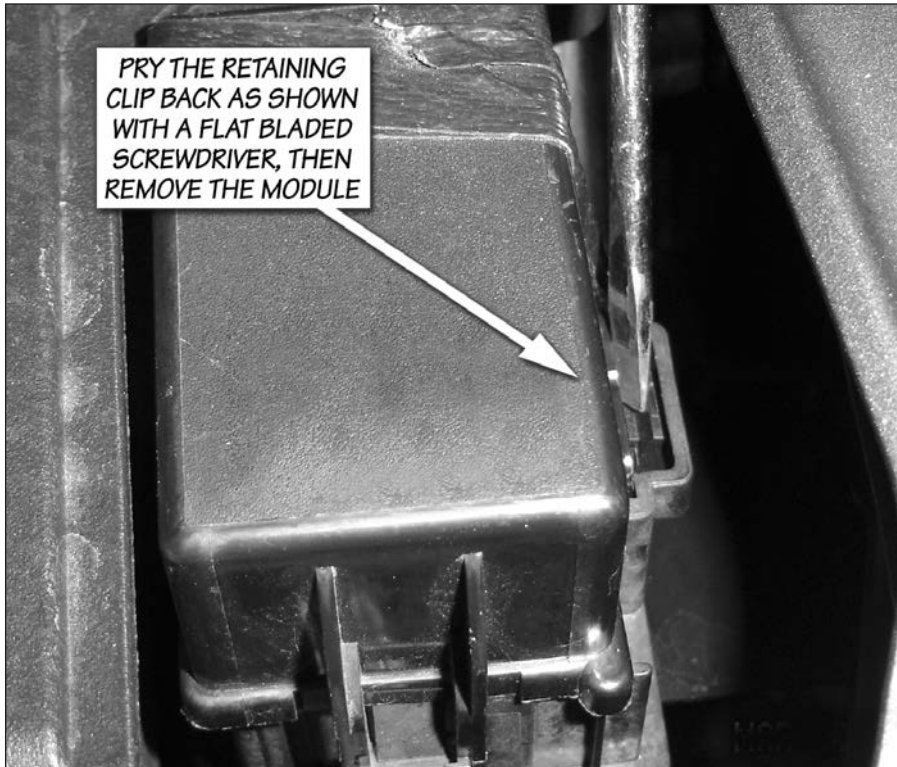

Remove Stock Components

1. Remove the (+) and (-) battery cables from both the drivers and passenger side batteries.
2. Undo the two toggle clamps at the rear of the air box assembly.
3. Disengage the two tabs on the lower backside of the air box assembly from the slots on the rear cover.
4. Remove the air box assembly and air box front cover from the vehicle.
5. For 2005-07 4-wheel drive equipped vehicles only: Remove the electronics module near the driver side batter. The retaining tab for the module can be pried back with a flat blade screwdriver as shown in **Figure 1**. After the tab is depressed, the module can easily be pulled away from it's mounting bracket.
6. Remove driver's side plastic battery cover. There are tabs at the front and back of the cover that need to be depressed to remove the cover, as shown in **Figure 2**.

Note: Be careful not to break the plastic box, as it will be re-installed later.

Figure 2

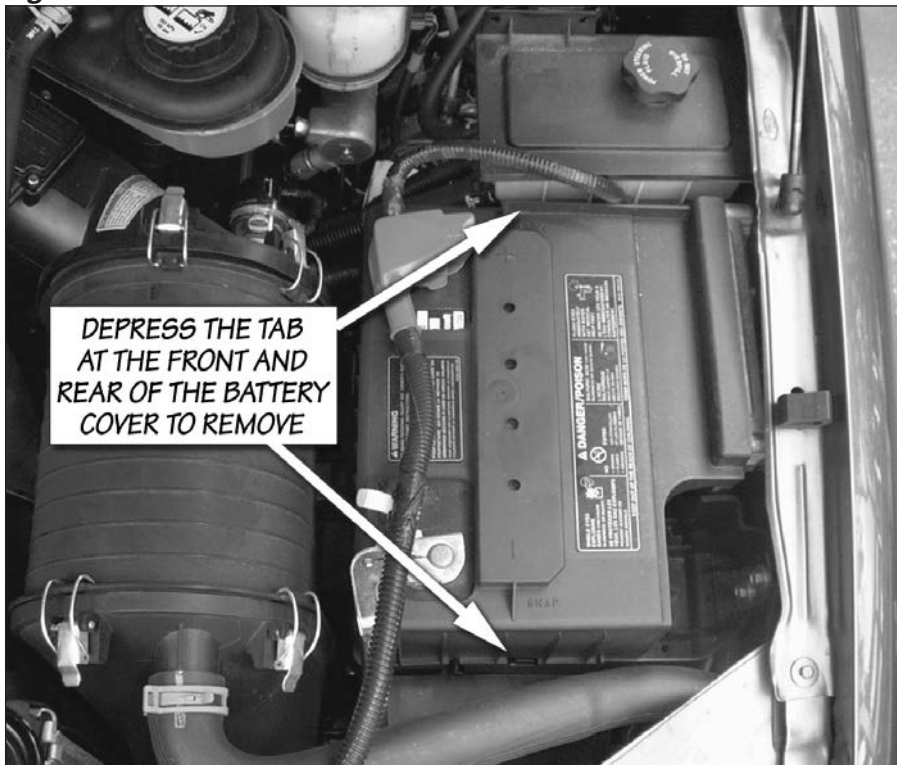

7. Remove the driver's side battery hold down clamp (8mm socket).
 8. Remove the driver's side battery.
- WARNING: When lifting a battery, excessive pressure on the end walls could cause acid to spew through the vent caps, resulting in personal injury. Lift with a battery carrier or with hands on opposite corners. Failure to follow these instructions may result in personal injury.**
9. Remove the wire harness plastic retaining clip on the back of the plastic battery box.
 10. Remove the plastic battery box [(4x) 13mm socket]. For 2005-07 4-wheel drive equipped vehicles only: A small bracket used to mount an electronic module will also be removed with the plastic battery tray.

11. Locate the driver side boost tube. Loosen the hose clamps and remove the boost tube, hose clamps and hose (if applicable) from engine compartment and set aside. These parts will not be reused.

12. Remove the four allen head bolts that attach the stock intake elbow. The intake elbow is the 90 degree transition from the driver side boost tube to the intake manifold.

13. Remove the stock intake elbow and gasket.

14. Cover the inlet to the intake manifold to prevent debris from getting into this area.

Modifications to make room for the Banks Techni-Cooler System

15. For 2005-07 4-wheel drive equipped vehicles only: Remove the two retaining clips that attach the wire harness to the metal battery tray.

16. Remove the driver's side metal battery tray [(3x) 13mm socket].

17. Drill a $\frac{3}{8}$ inch hole as shown in **Figure 3**.

18. Reinstall the battery tray as shown in **Figure 4** with the supplied $\frac{1}{2}$ " spacer and longer supplied 8mm bolts. Torque the bolts to 12 ft-lbs

Figure 3

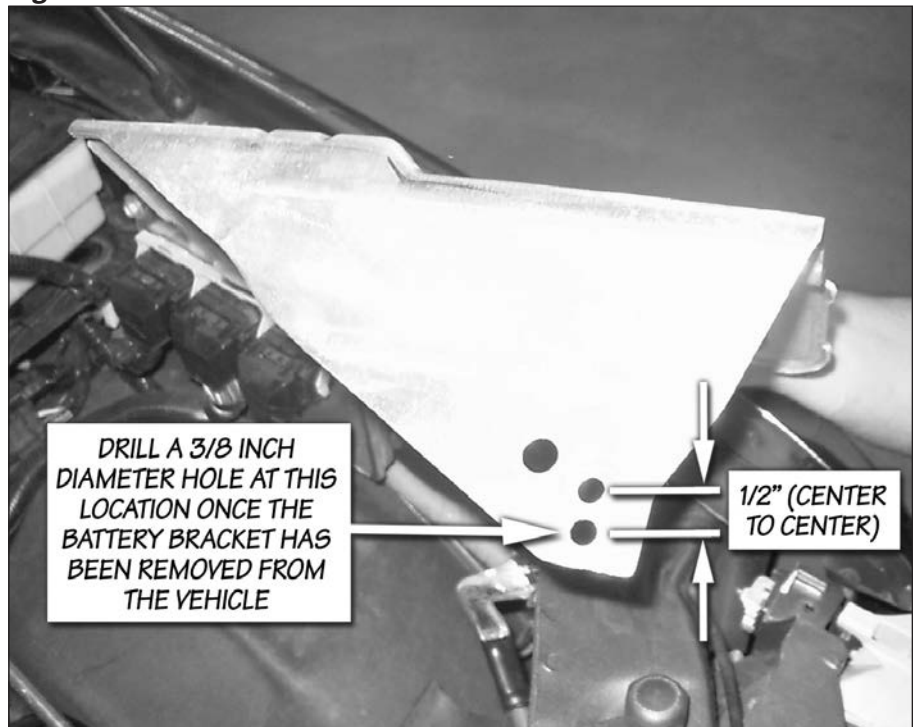

Figure 4

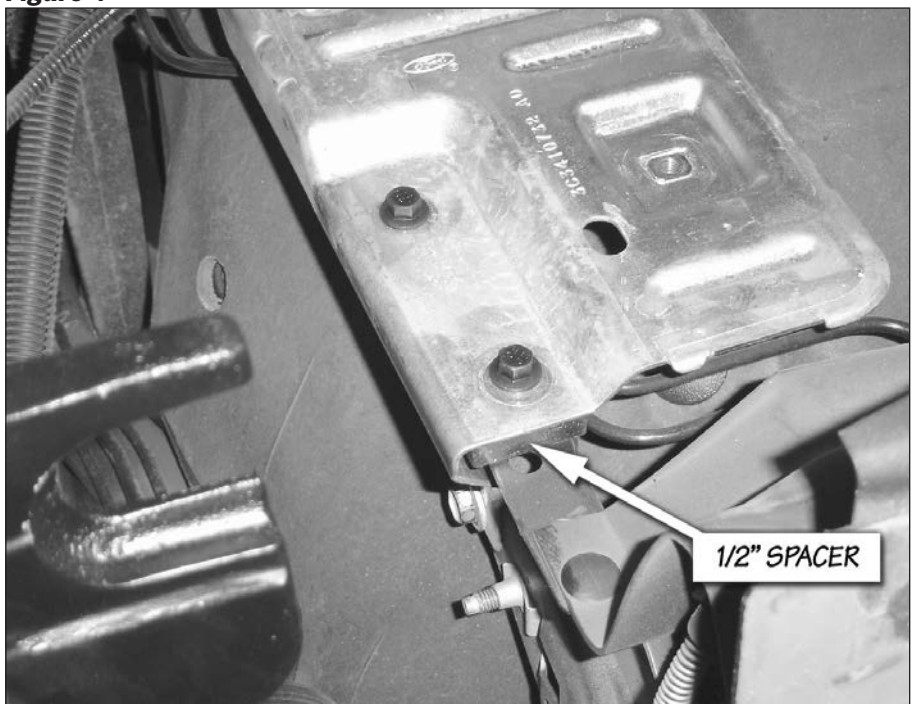

Figure 5



19. Trim the fan shroud as shown in **Figure 5** using **Template 1** on page **11**, to clear the Banks High Ram.

Note: 2005-07 vehicles require a different trim to fan shroud, use appropriate template. See **Template 1**.

Figure 6 General Assembly Banks Techni-Cooler

Item	Description	P/N	Qty
1	High-Ram Intake Manifold		
	2003-04	42745	1
	2005-07	42746	1
2	Boost tube, left	41326	1
3	Hose, 3.5" x 3.25", Black	94215	1
4	Hump Hose, 3" x 3", Blue	94510	1
5	Gasket, High-Ram Intake	93038	1
6	Stud, High-Ram Air Intake M6-1.0 x 1/4-20 x 4.365 (03-04)	91534	3
6	Stud, High-Ram Air Intake M6-1.0 x 1/4-20 x 6.185 (05-07)	91536	2
7	Stud, High-Ram Air Intake M6-1.0 x 1/4-20 x 6.725 (03-04)	91535	1
7	Stud, High-Ram Air Intake M6-1.0 x 1/4-20 x 6.595 (05-07)	91537	2
8	Nut, Nylock 1/4"-20	91110	4
9	Washer, SAE Flat, Zinc 1/4"	91102	4
10	Washer, Thread Sealing 1/4"-20	91106	2
11	O-Ring, High-Ram	93606	2
12	Hose Clamp, 3.5" Spring Loaded	92897	2
13	Hose Clamp, 3.0" Spring Loaded	92860	2
14	Spacer, Battery Box	91890	1
15	Hex-Bolt, Washer Head, Black 8mm-1.25 x 30mm	91810	2

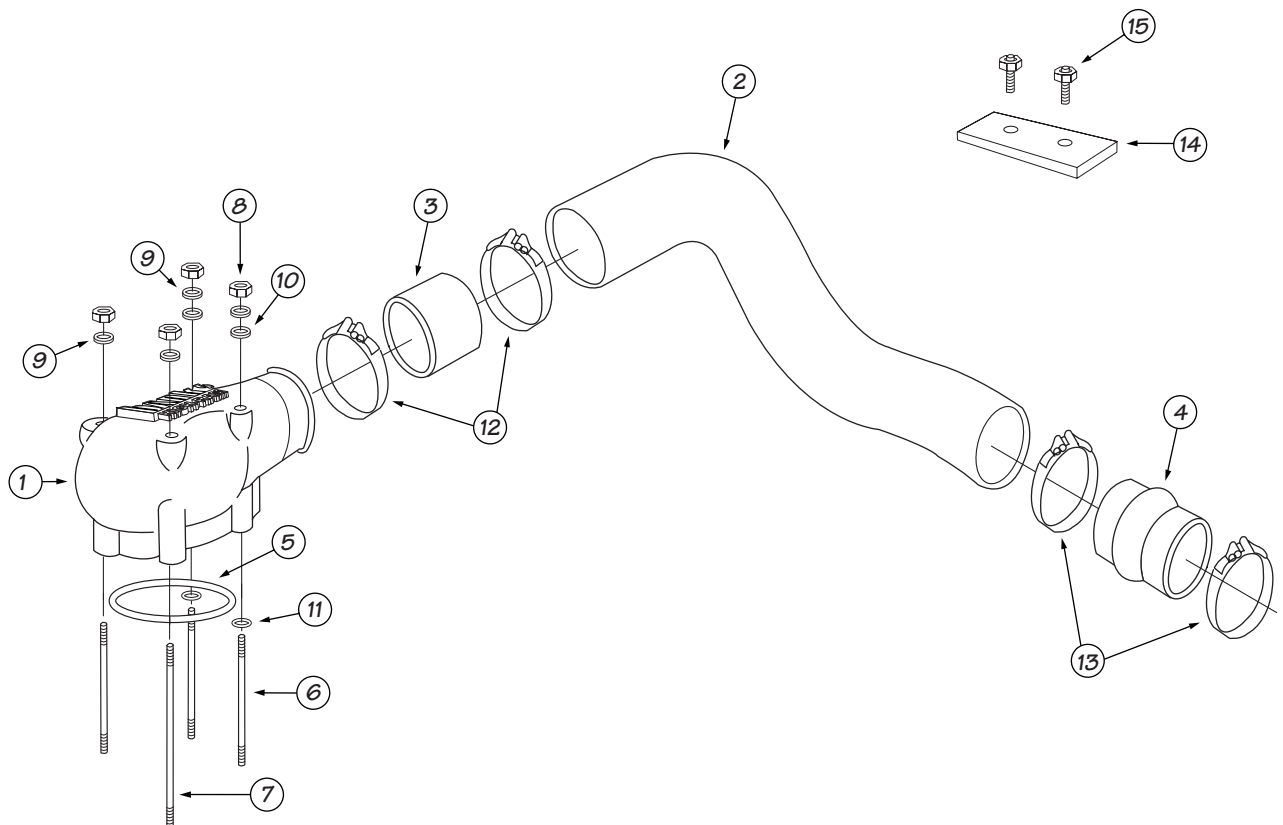
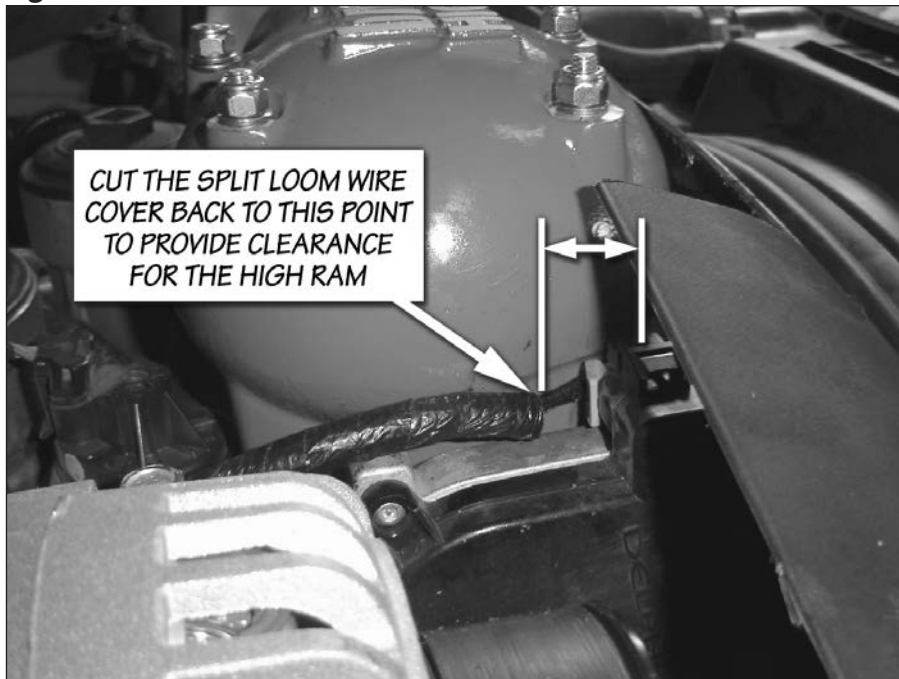

Figure 7



High-Ram Installation

20. Apply the supplied thread locker to the M6 threaded side of the High Ram studs. The M6 thread length is shorter than the 1/4"-20 threads on the opposite ends of the studs.

21. Using the two 1/4"-20 nuts provided, tighten the High Ram studs into the intake manifold by threading both nuts onto the stud. Tighten the nuts against each other using two open end wrenches, then tighten the stud by turning the wrench on the top nut. The stud should be torqued to 2-3 ft-lbs. Reverse the process to remove the nut and repeat for each stud.

22. 2003 to 2004 vehicles only: Remove 0.75" of the split loom near the connector shown in **Figure 7** to provide additional clearance for the High-Ram.

23. Install the supplied o-rings on the two driver side studs as shown in the exploded view in **Figure 8**. Slide

Figure 8

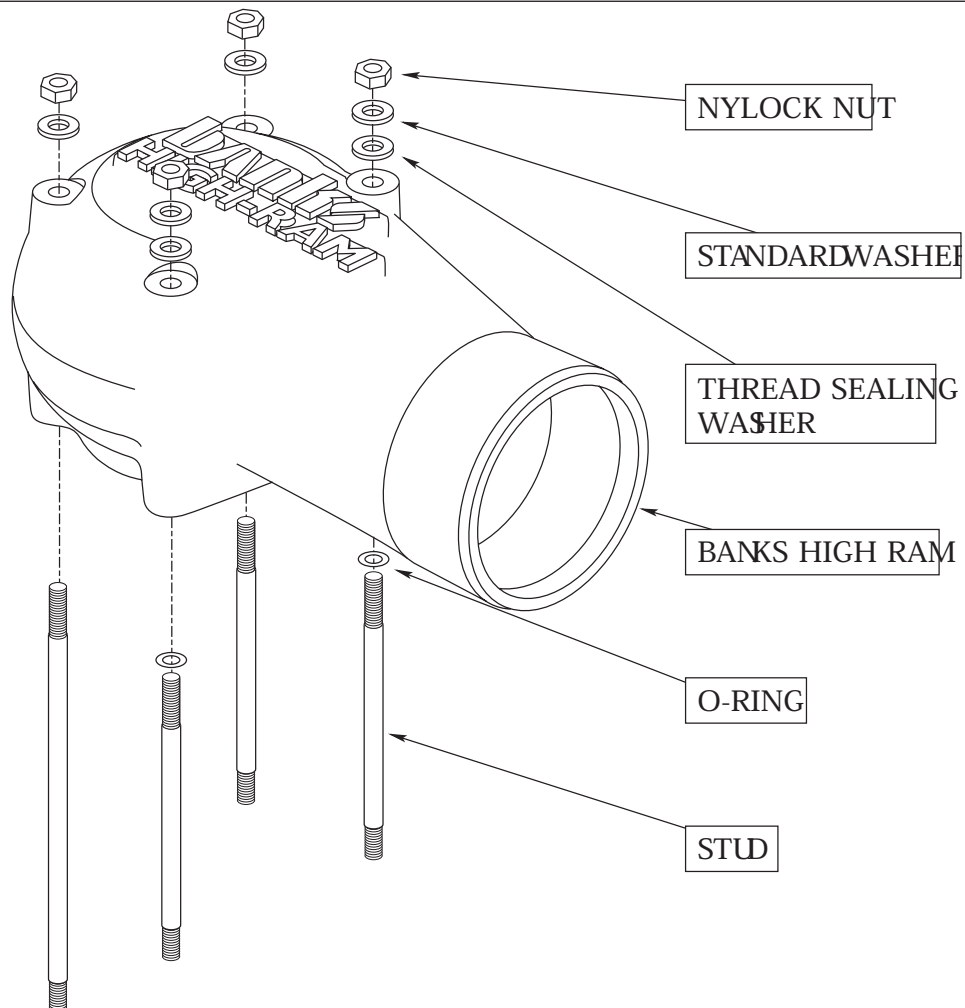

the o-rings down to the base of the intake manifold.

24. For 2003 to 2004 vehicles, install the factory replacement intake manifold gasket in the groove on the intake manifold. **For 2005-07 vehicles,** install the factory replacement intake manifold gasket on the High Ram.

25. Slide the High-Ram over the installed studs.

26. Place the thread sealing washers on the two driver side studs. Use a twisting motion to thread the sealing washers over the threaded portion of the studs to avoid tearing the seals. Install standard flat washers on the passenger side studs and on top of the thread sealing washers, as shown in **Figure 8**.

27. Secure the High Ram with (4x) 1/4"-20 Nylon locking nuts. Torque to 9 ft-lbs.

*NOTE: Before slipping the boost tube and the corresponding hose, into position, ensure that all connection ends are clean and free of any oil residue and contaminates. Clean all connection points with a **non-oil based solvent** such as Acetone, Mineral Spirits, Denatured Alcohol or Lacquer Thinner. Read and follow the manufactures operation instruction for non-oil based solvent cleaner.*

28. Locate the Banks boost tube, connection hose, hump hose and supplied hose clamps. Install hoses, hose clamps and Banks boost tube as shown in **Figure 6**.

Note: The connection hose should be slid firmly against the hose stops provided on the High Ram. Allow a minimum 1/8" air gap between CAC, High Ram and boost tubes.

Figure 9

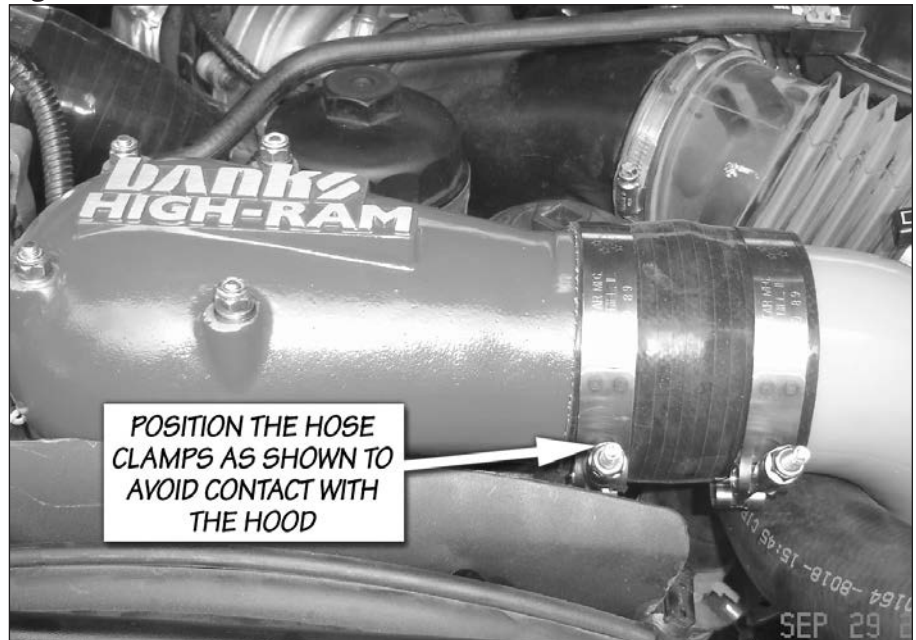

On 2003 to 2004 vehicles: The brake line on the driver side may need to be slightly bent to provide additional clearance for the boost tube.

On 2005-07 vehicles: One of the power steering fluid lines may need to be bent to provide clearance for the driver side boost tube.

29. The hose clamps on the High Ram must be positioned as shown in **Figure 9** to avoid contact with the hood.

30. Tighten the hose clamps to 75 inch-lbs (**not ft-lbs!**).

31. Re-install the plastic driver side battery box. Torque the attachment bolts to 12 ft-lbs.

On 2005-07 4-wheel drive vehicles only: Reinstall the electronic module mounting bracket that was removed with the plastic battery tray.

32. Re-install the driver's side battery, battery hold down clamp, and plastic battery cover. Torque the hold down clamp retaining bolt to 89 in-lbs. **WARNING: When lifting a battery, excessive pressure on the end walls could cause acid to spew through the vent caps, resulting in personal injury. Lift with a battery carrier or with hands on opposite corners. Failure to follow these instructions may result in personal injury.**

33. For 2005-07 4-wheel drive equipped vehicles only: Re-install the electronic module near the driver side battery. The module is shown in **Figure 1**.

34. Re-install the air filter assembly box and air box front cover.

35. Re-install the driver and passenger (+) and (-) battery cables.

Template 1
(fan shroud, step 19)

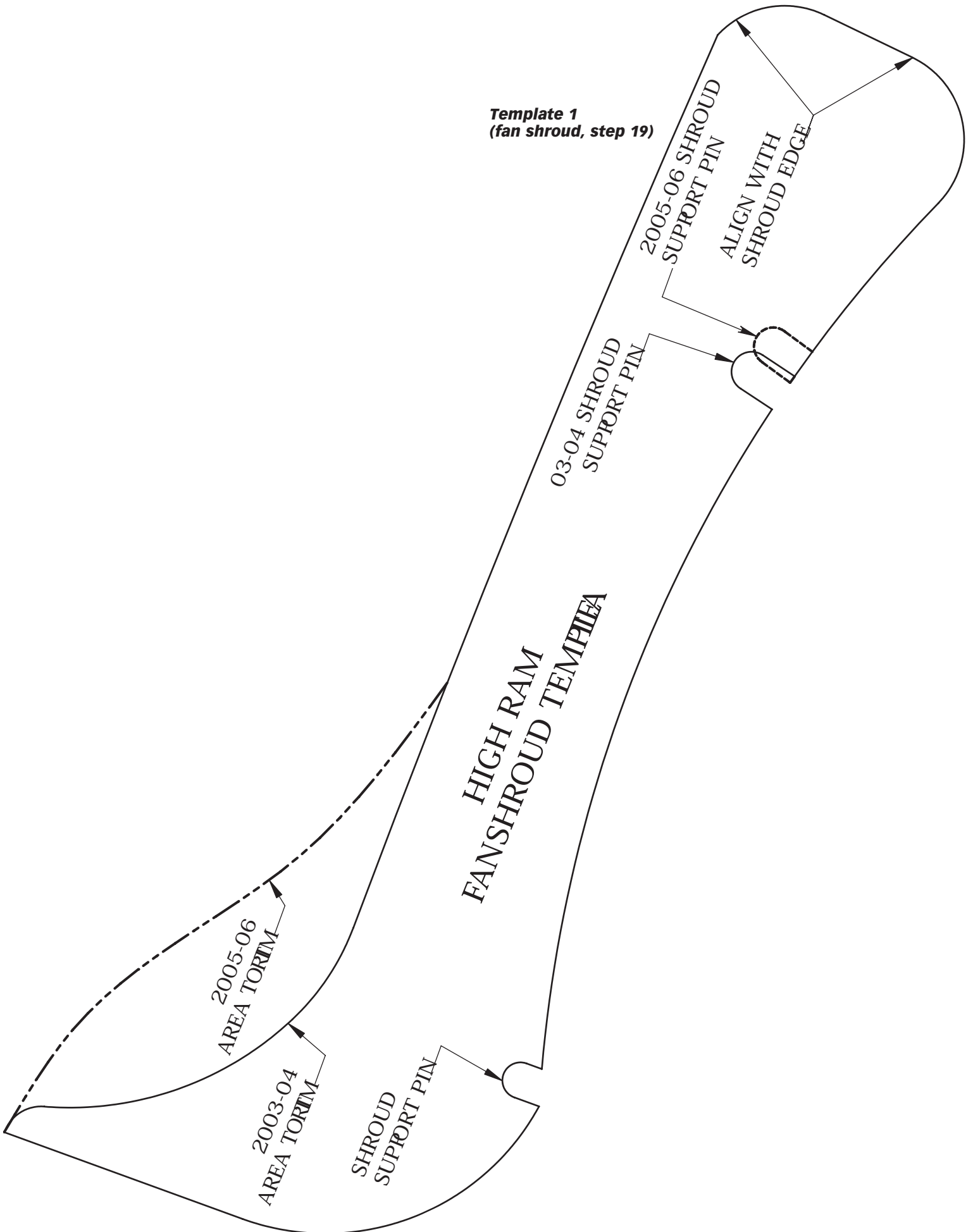

Gale Banks Engineering
546 Duggan Avenue • Azusa, CA 91702
(626) 969-9600 • Fax (626) 334-1743

Product Information & Sales: (800) 438-7693
Customer Support: (888) 839-5600
Installation Support: (888) 839-2700

bankspower.com