



bonsai

Paper Shredder C237-B

Instruction Manual

6-sheet Cross Cut Shredder

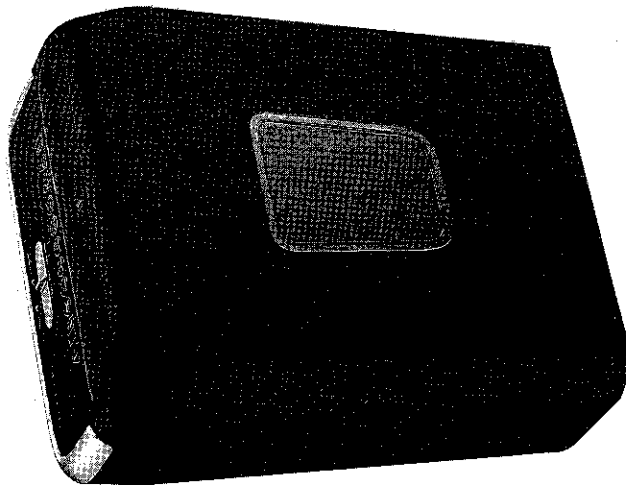

**THIS INSTRUCTION BOOKLET CONTAINS IMPORTANT SAFETY INFORMATION.
PLEASE READ AND KEEP IT FOR FUTURE REFERENCE.**

Please give us a chance to make it right and do better!
Contact our friendly customer service department for help first.
Replacements for missing or damaged parts will be shipped.

Customer Service:

 : customer-care@bonsai.com

 : 1-844-728-6917

TIPS:

Thanks for your believing and choosing!

In order to ensure the machine without any quality issues, We have inspected the machines by 100%. Maybe we have remained some shred papers in the basket or on blades during machine test. If it makes you feel uncomfortable or inconvenience, Please kindly contact with our customer service. We will provide further and better service for you. Thanks!







IMPORTANT!



1. Please read all instructions carefully and retain instructions for future reference.
2. Read through each step carefully and follow the proper order.
3. Please place this machine on a flat and stable surface place, please be careful and don't tip the machine over.
 - * In case the machine is broken and cannot be used as normal.
4. The device should be set up as close as possible to an easily accessible wall socket.
5. Dangerous, please do not disassemble, modify or repair the machine in any way on your own.
 - * To avoid electric shock, hurting or accidental injury.
6. When you empty the basket, or move the machine, or no need to use the machine for a certain period of time, Please kindly make the machine under OFF status and unplug.
 - * To avoid fire accident or electric shock.
7. Please don't use inflammable liquids, gases, water and cleaner to clean the machine.
 - * To avoid fire accident or electric shock.
8. Please don't use the machine in a very high temperature, very humidity and very heavy dust environment.
 - * To avoid fire accident, electric shock or machine malfunction
9. Please do not put adhesive tape, carbon paper, fabric, plastic film, etc. into the machine for shredding.
 - * To avoid damaging the machine
10. Please do not damage or process the power cables, or do not place heavy objects on the cables.
 - * To avoid fire accident or, hurting or electric shock
11. If abnormal conditions such as smoke or odor occurred, please disconnect the power and stop using it immediately.
 - * To avoid fire accident or electric shock
12. Please do not use if the shredder or the power cable is damaged or defective
 - * To avoid fire accident or electric shock
13. Do not shred greeting cards with sound chips or batteries.
 - * To avoid fire accident or electric shock.

IMPORTANT SAFETY INTRODUCTIONS BEFORE FIRST USE

 User information / safety instructions.

WARNING

-  Please kindly let children and pets keep away from the machine.
-  * There are sharp blades inside the machine so as to avoid injury.
-  Please kindly let your hands keep away from the sharp blades and feeding opening of paper shredder.
-  * There are sharp blades inside the machine so as to avoid injury.
-  Please kindly let your hair keeps away from the feeding opening of paper shredder.

-  * If your hair is accidentally sucked in, Please kindly use the "Reverse function" and get rid of the danger.
-  Please kindly let your clothing or some small items keep away from the feeding opening of paper shredder like tie, necklace, sleeves, jewelry, etc..
-  Please don't use inflammable liquids, gases water and cleaner to clean the machine.

* To avoid fire accident.

 Please kindly don't touch the sharp edges to avoid injury .

 This equipment is not intended for use by children. Avoid touching the media feed opening with the hands, clothing or hair. Unplug this equipment when not in use for an extended period of time, Hazardous moving part is in this equipment, keep body parts away from moving parts.

 It cannot be over 6 sheets in one time for the quantity of shredding.

One folded sheet of paper equates to 2 sheets of paper.
Heavier paper, humidity or other than rated voltage may reduce capacity.
85% Maximum sheets per pass to avoid jams.

KNOW YOUR SHREDDER

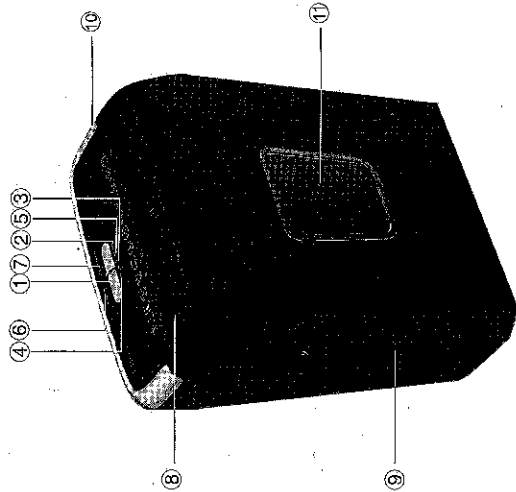

- ① Control panel (Control shredder's four status "REV", "OFF", "FWD", "AUTO")
- ② Reverse Position ("Release the paper")
- ③ Auto Position (Turn on)
- ④ Forward (compulsorily work)
- ⑤ OFF (Turn off)
- ⑥ Power light (work status in green)
- ⑦ Indicator light (Overheating in red)
- ⑧ Paper feed opening
- ⑨ Basket
- ⑩ Shredder's handle
- ⑪ Transparent Window

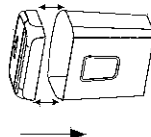

For safety reasons, shredder will operate only if the shredder head is in correct position and used with supplied basket.

TECHNICAL SPECIFICATIONS

Voltage	120VAC, 60Hz		
Feeding Opening Capacity	6 sheets/time(A4 20LB) One sheet of credit card/time	Feed Opening (L*W)	220 x 4.0mm 8.66 x 0.16 Inches
Shred Type	Cross Cut	Basket Type	Lift off
Basket Capacity	13L	Shred Paper Size	13/64" x 1-18/32" Inches 5x40mm
Product Size (L*W*H)	300x180x362mm 11.81x7.09x14.25Inches		
		Shred Functions	Paper, credit card, staple, clips

Will not shred : Unopened junk mail , adhesive labels, continuous from paper, transparencies, newspaper, cardboard, large paper clips, laminates, file folders, X-rays or plastic other than noted above.
 Maximum recommended daily usage rates : 20 sheets , 2 credit cards.

OPERATING INSTRUCTIONS

1. Plug in and move "control panel" from OFF to AUTO position, "Power Light" in green. (feed papers, clips, staple or credit card to feed opening).

 Continuous operation around 3 minutes.

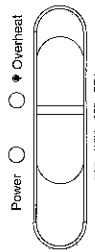
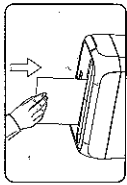
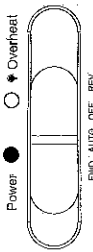

2. When finished shredding or no need to use it, please set to OFF.

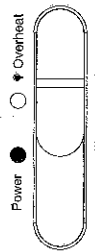

Jam: Please move "control panel" from "Auto" to "REV" position and pull out the jammed paper.

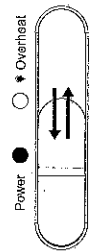
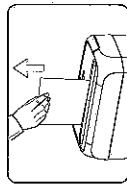

* Move "control panel" from "REV" to FWD position for 3-5 seconds staying (repeat the operation around 2-3 times if get a very serious jam)

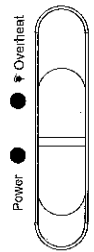

Overheat (power light is in green and indicator light in red, need to wait for cooling down).  Cool down around 40 minutes

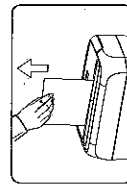

Max.6 sheets: If it is over the capacities, please take out the excess papers.

PRODUCT MAINTENANCE

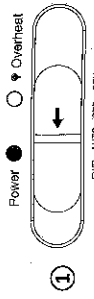

1. Plug in and move "control panel" from OFF to AUTO position, "Power Light" shows green light. (Feed one shredder Lubricant pack to shred)

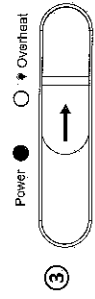
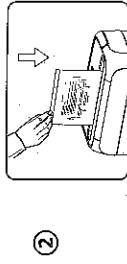

2. Move "control panel" from Auto to "REV" position for 2-3 seconds staying and don't pull out the shredder lubricant pack.

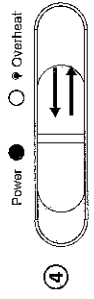
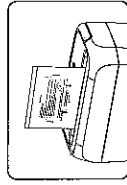

3. Move "control panel" from REV to AUTO position to shred the shredder lubricant pack for 3-5 seconds staying and repeat the operation for 2-3 times till the shredder lubricant pack is fully shredded.

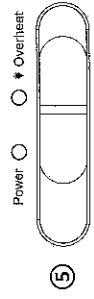

4. When finished shredding or no need to use it, please set to OFF.



* Only use the professional shredder Lubricant pack to maintain the shredder such as Bonsall shredder Lubricant 24-Pack (LS24)/12-Pack (LS12), (no cleaner, inflammable liquids, gases oil etc... )

TROUBLESHOOTING

Malfuction	Reason	Solution
The shredder does not work	The power plug doesn't connect to the power supply.	Make sure the unit is plugged in and that the outlet is in good working order.
	The shredder switch is not set to the "AUTO/ON" position.	Make sure the plug is inserted into the correct power outlet, and flip the switch to the "AUTO/ON" position, the power indicator lights up.
	Overheating with extended use.	In the event that the shredder has shred continuously beyond the maximum running time and overheated, the unit will automatically shut off. If this happens, switch the shredder off for 40 minutes or longer before resuming normal operation.
	Safety interlock switch not to operate properly.	Make sure the shredder head is correctly seated onto the included wastebasket, with all the words and icons facing towards you. The head unit is particularly designed to work only with the integrated wastebasket. The shredder is equipped with a safety interlocking mechanism, which prevents the shredder from working when the head unit is lifted, removed, or accidentally knocked over. The shredder will not function until the head unit is properly assembled as pictured.
	Using plastic bag to line the wastebasket.	Please remove it. This may cause the shredder not to operate properly.
	The basket is full.	Empty the basket.
	The activation sensor of the shredder is located near the center of the feed slot.	Be sure to feed directly into the center area to activate the machine (especially applies to smaller pieces of paper or credit cards)
Damage of power cable.	Please replace the power cable with the same parameters by professional person or contact with our customer service.	
Defective of machine.	Please kindly contact with our customer service.	
Won't shred MAX sheets	Paper jam.	NEVER SHRED THE FOLLOWING ITEMS: Large paper clips (remove small clips whenever possible) Envelopes (especially windowed or glued flaps) Adhesive materials such as labels, stickers, or glued paper Newsprint, tissue, or any similar thin paper stock, transparencies, film, or laminated documents Continuous forms or paper rolls Cardboard / Corrugated board or fabric Plastic or hard items (except Credit Cards & CDs if applicable)

Malfuction	Reason	Solution
Won't shred MAX sheets	Paper jam.	1) Lift up the shredder and check whether the outlet is blocked by paper. If there is a lot of paper attached to the outlet, please disconnect the power supply, manually remove the paper at the outlet, and then place the shredder on the basket correctly. Move "control panel" from "REV" to FWD position for 3-5 seconds staying (repeat the operation around 2-3 times if get a very serious jam) 2) Switch the shredder to Reverse (REV) mode. While in Reverse, the shredder will back up and loosen the jammed paper. If required, you may need to tug and remove several sheets to effectively clear the machine. When jammed paper is loosened or removed, switch back to the Auto-On mode to continue shredding. Repeat steps if needed. 3) With stubborn situations where the reverse function does not help, you may need to clean the jammed paper with shredder oil (cooking oil is acceptable, but don't use aerosol). Start by drizzling oil into the feed slot where the paper is jammed. Let it soak for about 30 minutes to completely saturate. Turn the shredder to Auto-On (or FWD) mode. If required, an index card or a rigid sheet of cardstock (old greeting card or folded file folder) can be fed into the shredder to help push the jammed paper through. 4) With the shredder unplugged, you may use a set needle-nose pliers or tweezers to remove the blockage.
The shredder is constantly running while in "Auto (On)" mode.	Paper dust and other foreign objects cover the mechanical sensor. The location of mechanical sensor is in the middle of shredder's feeding opening look like a small plastic divider.	It is possible that the activation sensor, which starts the shredder, is blocked with paper. Insert an index card or any rigid sheet of cardstock (old greeting card or folded file folder), directly in the center of the feed slot, while applying force to help push the jammed paper through. This will usually clear any paper blocking the activation sensor and feed slot.
The shredder runs in "Rev (Reverse)" mode but not in "Auto (On)" mode.	It is also possible that the feed slot has become blocked with paper.	Insert an index card or any rigid sheet of cardstock (old greeting card or folded file folder), directly in the center of the feed slot, while applying force to push the jammed paper through. This will usually clear any paper blockage.

LIMITED WARRANTY

We stand by our product and offer a 30-day money-back guarantee. During this time, you could return the item without paying any extra fee if there is a manufacturing defect in it. Please rest assured that the returns are free and easy if there is a manufacturing defect. Otherwise, it would be the customer's responsibility to cover the shipping fee. Products on sale are also returnable.

If the product isn't meeting your expectations, please email within 30-days of receipt. We will help you to either return or exchange your product. Your original form of payment will be refunded in full once the full return is complete. After 30-days orders may be subject to a 20% restocking fee and all shipping and handling charges will be the responsibility of the customer. Additional return details are listed below. After 60-days the purchase from Bonsaii is non-refundable.

If you receive a damaged product, you must notify Bonsaii within 48 hours of delivery. Bonsaii will investigate the claim and notify the freight company about the damage. Please retain all packaging in the event that Bonsaii or the freight company needs to inspect it. These investigations may take several days but merchandise replacements will be processed as soon as possible.

For product arrived defective or damage, We're sorry to hear that your Bonsaii product arrived in less than perfect condition. We'd like to resolve this issue right away with the help of our Customer Support Team and Quality Assurance team. They'll need to know a bit of information on your order as well as the issue you're experiencing with your Bonsaii product. To report your issue, please reach out to our Customer Support team by emailing customer-care@bonsaii.com with your order number. We may need you to make a short video, or take some pictures of the defects of the product and send them to customer-care@bonsaii.com. After a preliminary analysis on the video or pictures, we will send you a brand new replacement right away if it is confirm to be defective on its arrival. If we determine that you have misrepresented Bonsaii product's condition and that product is not defective, we will send you the right instructions and help you to use the product correctly.

If you have any questions or any confusions, Please kindly contact with us:
customer-care@bonsaii.com.