

Package Contents

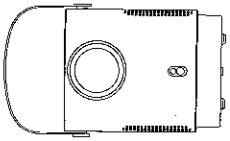

TOPTRO TR23
Projector

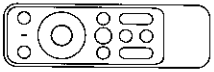

Remote Control

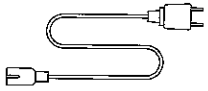

Power Cord

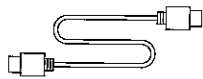

HDMI Cable

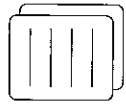

Quick Start Guide

Product Overview

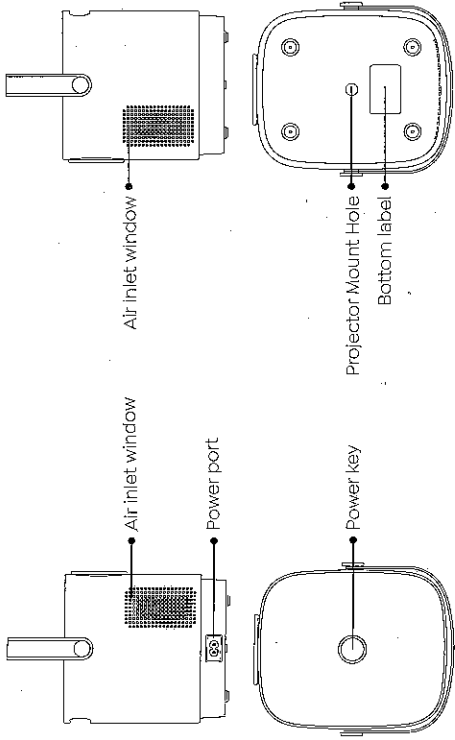
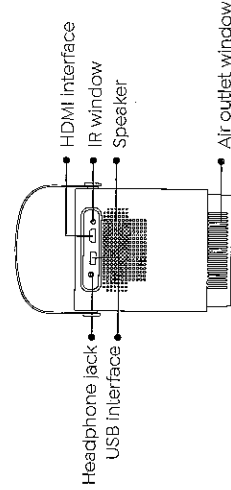
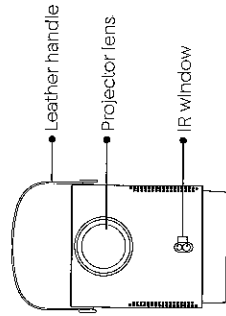

Remote Control

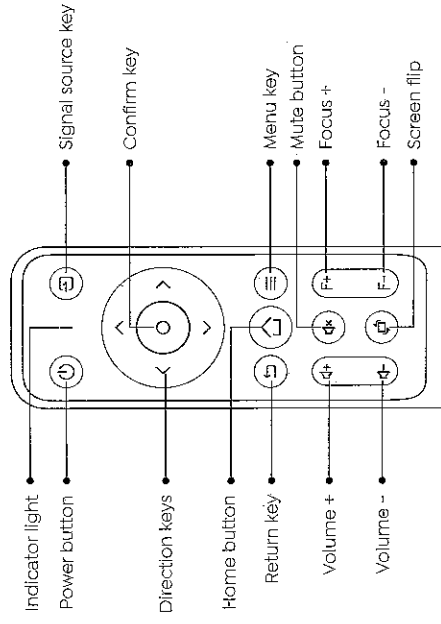

Note: There is no battery installed in the remote control, please install the battery before use.

How to install batteries in the remote control?

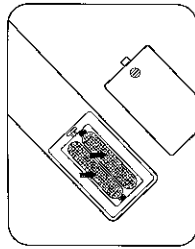
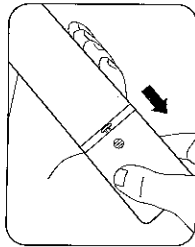

Tips: Remove the battery cover, install two AAA batteries, during the installation process, please observe the battery's polarities as indicated.

Operation Guide

1. Turn on TR23 projector

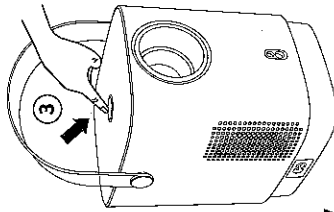
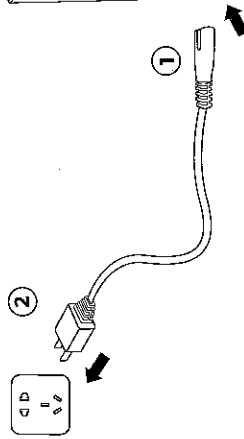

2. Projection Adjustment

1) Focus Adjustment

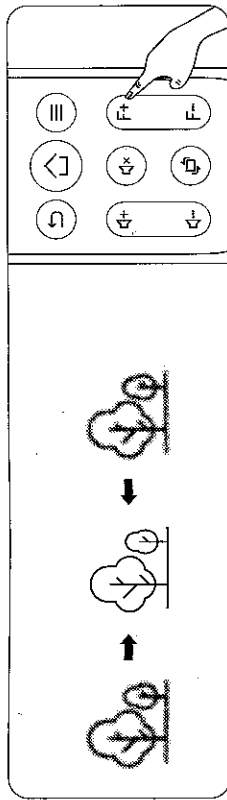

2) Keystone Correction

- Go to home page—Select the **Button**—Select the [**Projection setting**].
- Select the [**Advanced keystone correction**], use the left and right keys of the remote control to select 4-side keystone-correction or 4-point keystone correction, then click [**OK**] to set the keystone correction.

3. Connect device, choose the right signal source

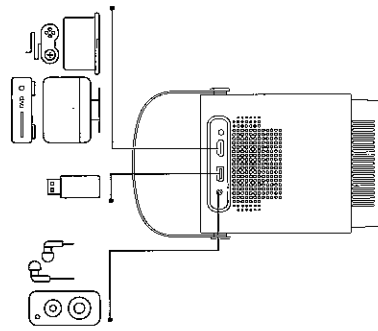

TOPTRO TR23 projector has 3 ports, HDMI port*1, USB port*1, 3.5mm headphone output port*1.

Note: The projector only has HDMI signal source. If you connect an external device via USB port, the projector will automatically recognize it. If you connect an external device via HDMI port (such as TV box, Fire TV Stick, DVD Player, PC, etc.), please select the HDMI signal source.

Wifi Connection

1. iOS Cast

1) iPhone or iPad

- Go to home page—Select the  button— [**Select Network**] -Select the home WiFi—Connect TR23 projector to your home WiFi.
- Back to the home page—select [**iOS Cast**] —Scan the QR code to download the MHShare. (Keep this page unchanged)

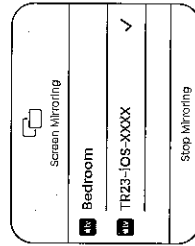
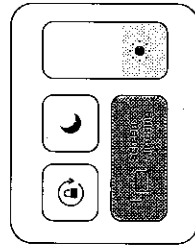
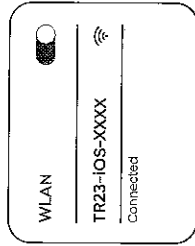

- Connect your iOS device to the same home WiFi as the projector.

- Open the [**Control Center**] on your iOS device—Select the [**Screen Mirroring**] —Connect the iOS cast receiver named [**TR23-IOS-XXXX**] and done.

2) Mac

- Make sure your Mac support Wi-Fi connectivity.
- Connect the projector to the same Wi-Fi network as your Mac.
- Mac Projector Settings: On your Mac, go to [**System Preferences**], then select [

Displays] Click the [**Arrangement**] tab and ensure the [**Mirror Displays**] option is checked to enable screen mirroring.

- Open the iOS cast on the projector, your Mac should automatically detect the projector. The projected display should appear on the projector screen.
- Adjust Display Preferences: in the [**Displays**] settings, you can adjust the resolution and other display preferences to optimize the projection for the best visual experience.

2. Miracast

1) Android device

- Go to home page—Select [**Miracast**] —Press [**OK**] to enter the Miracast setting menu. (Keep this page unchanged)

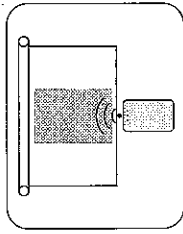
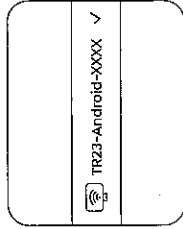
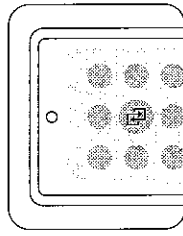

- Select the [**Setting**] on your Android device—Select the [**Screen Mirroring**] function—Select the Miracast receiver named [**TR23-Android-XXXX**] and done.

2) Windows laptop

- Make sure your laptop support Wi-Fi connectivity, connect the projector to the same Wi-Fi network as your laptop.
- Turn on [**Miracast**] on the projector.
- Use the laptop keyboard keys to press [**Win+K**] to search for the projector, and connect. After the connection is successful, press [**Win+P**] to select the copy function.

Bluetooth Connection

Go to home page—Select the  button—Select the [Bluetooth] —Open the Bluetooth function and your Bluetooth device—Find your Bluetooth device name and connect it.

Attentions:

1. If the projector cannot search for Bluetooth devices, or there is a Bluetooth delay problem, please do not hesitate to contact us via service@toptro.com.
2. Since the projector's Bluetooth only transmits audio signals, the projector can only connect to Bluetooth headsets and Bluetooth speakers, please don't connect to mobile phones and Bluetooth keyboards via Bluetooth.

HOW TO UPDATE FIRMWARE

>> Online update

1. Connect device to the network.
2. Go to home page—Select the button—Select the [System Update] —Select the [Online Upgrade] .
3. Please refer to the hint of update.

>> Local update

1. Ask the new firmware from local seller.
2. Copy the firmware file "update.zip" to TF card/U disk.
3. Projector will searching the firmware automatically.
4. Click update button according to the hint.

CONTACT US

For any inquires, issue or comments concerning our products, please send E-mail to the address below, and we will respond you within 24 hours.

✉ service@toptro.com