

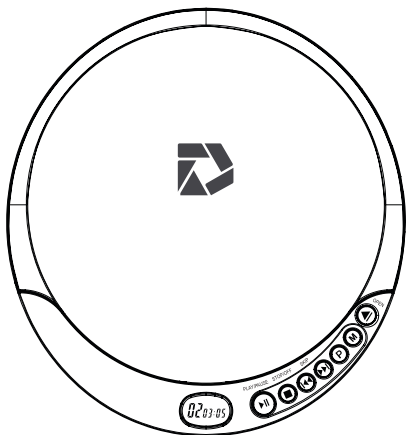

DELUXE PRODUCTS

60 SEC ANTI SKIP PORTABLE CD PLAYER



DP-PCD-001 - USER MANUAL (V8)

PLEASE READ THIS USER MANUAL COMPLETELY BEFORE OPERATING THIS UNIT AND RETAIN THIS BOOKLET FOR FUTURE REFERENCE.

CONTACT: SERVICE@DELUXEPRODUCTS.INFO

DEAR DELUXE PRODUCTS CUSTOMER

Selecting new audio equipment such as the unit you've just purchased is only the start of your musical enjoyment. Now it's time to consider how you can maximize the fun and excitement your equipment offers. This manufacturer and the Electronic Industries Association's Consumer Electronics Group want you to get the most out of your equipment by playing it at a safe level. One that lets the sound come through loud and clear without annoying blaring or distortion and, most importantly, without affecting your sensitive hearing. Sound can be deceiving. Over time your hearing "comfort level" adapts to higher volumes of sound. So what sounds "normal" can actually be loud and harmful to your hearing. Guard against this by setting your equipment at a safe level BEFORE your hearing adapts.

To establish a safe level:

- Start your volume control at a low setting.
- Slowly increase the sound until you can hear it comfortably and clearly, and without distortion.

Once you have established a comfortable sound level:

- Set the dial and leave it there.

Taking a minute to do this now will help to prevent hearing damage or loss in the future. After all, we want you listening for a lifetime.

We Want You Listening for a Lifetime

Used wisely, your new sound equipment will provide a lifetime of fun and enjoyment. Since hearing damage from loud noise is often undetectable until it is too late, this manufacturer and the Electronic Industries Association's Consumer Electronics Group recommend you avoid prolonged exposure to excessive noise.



Customer's Record:

The serial number of this product is found on its back cover. You should note the serial number of this unit in the space provided as a permanent record of your purchase to aid in identification in the event of theft or loss.

Serial Number: _____

Model# DP-PCD-001

WARNING

CLASS 1 LASER PRODUCT

CLASS 1 LASER PRODUCT
APPAREIL LASER DE CLASSE 1
PRODUCTO LASER DE CLASE 1

CAUTION
INVISIBLE LASER RADIATION
WHEN OPEN AND INTERLOCKS
DEFEATED
AVOID EXPOSURE TO BEAM.



This product contains a low power laser device.

Note: This product complies with DHHS rule 21 CFR, subchapter J, Part 1040 at the date of manufacture.

SAFETY PRECAUTIONS

1. As the laser beam used in this compact disc player is harmful to the eyes, do not attempt to disassemble the casing.
2. Stop operation immediately if any liquid or solid object should fall into the cabinet. Unplug the unit and have it checked by qualified personnel.
3. Do not touch the lens or poke at it. If you do, you may damage the lens and the player may not operate properly.
4. Do not put anything in the safety slot. If you do, the laser diode will be ON when the lid is still opened.
5. If the unit is not to be used for a long period of time, make sure that all power sources are disconnected from the unit. Remove all batteries from the battery compartment and unplug the adaptor from the wall outlet. Make it a practice to remove the adaptor by grasping the main body and not by pulling the cord. (Not Included)
6. This unit employs a laser. The use of controls or adjustment or performance of procedures other than those specified herein may result in exposure to hazardous radiation

COMPLIANCE WITH FCC REGULATIONS

This device complies with Part 15 of the FCC Rules. Operation is subject to the following two conditions:

- (1) this device may not cause harmful interference, and
- (2) this device must accept any interference received, including interference that may cause undesired operation.

NOTE: This equipment has been tested and found to comply with the limits for a Class B digital device, pursuant to Part 15 of the FCC Rules. These limits are designed to provide reasonable protection against harmful interference in a residential installation. This equipment generates, uses and can radiate radio frequency energy and, if not installed and used in accordance with the instructions, may cause harmful interference to radio communications. However, there is no guarantee that interference will not occur in a particular installation. If this equipment does cause harmful interference to radio or

television reception, which can be determined by turning the equipment off and on, the user is encouraged to try to correct the interference by one or more of the following measures:

- Reorient or relocate the receiving antenna.
- Increase the separation between the equipment and receiver.
- Connect the equipment into an outlet on a circuit different from that to which the receiver is connected.
- Consult the dealer or an experienced radio/TV technician for help.

CAUTION: Changes or modifications not expressly approved by the party responsible for compliance could void the user's authority to operate the equipment.

PROTECT YOUR FURNITURE

This model is equipped with non-skid rubber 'feet' to prevent the product from moving when you operate the controls. These 'feet' are made from non-migrating rubber material specially formulated to avoid leaving any marks or stains on your furniture. However certain types of oil based furniture polishes, wood preservatives, or cleaning sprays may cause the rubber 'feet' to soften, and leave marks or a rubber residue on the furniture. To prevent any damage to your furniture we strongly recommend that you purchase small self-adhesive felt pads, available at hardware stores and home improvement centers everywhere, and apply these pads to the bottom of the rubber 'feet' before you place the product on ne wooden furniture.

IMPORTANT NOTES

1. This product does not contain a separate Power On/O switch. After inserting a disc and installing batteries/ AC adaptor, simply press the Play button to switch on and play a disc. (Micro USB Cable Included - USB adaptor not included)
2. In order to maximize battery life and provide optimum playing time this product incorporates an Auto Power off function. The power to the player will automatically switch o approximately 30 seconds after a disc has finished playing or when the CD lid is opened.

PREPARATION FOR USE

Unpack the unit carefully to remove all the accessories from the packing. Verify that the following accessories are present before setting up the unit.

Accessories:

Main Unit x 1

Earbuds x 1

User Manual x 1

Aux / Line In Cable x 1

Micro USB Cable x 1

LOCATION OF CONTROLS

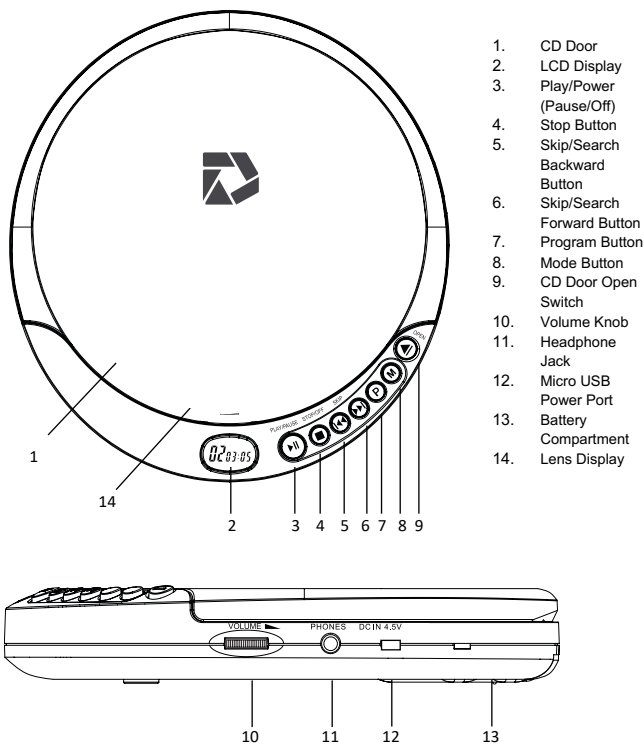

POWER SOURCE

This CD player operates on two 1.5V DC "AA" size (UM-3) alkaline batteries (Not Included) or AC adaptor with an output of 5V DC (Not Included).

Install Batteries

1. Open the battery compartment cover located on bottom of cabinet.
2. Insert two 1.5V DC "AA" size (UM-3) alkaline batteries (Not included) into the Battery compartment following the polarity markings as indicated in the compartment.
3. Close the battery door.

IMPORTANT:

Be sure that the batteries are installed correctly. Wrong polarity may damage the unit and void the warranty.

Requires 2 AA batteries (not included).

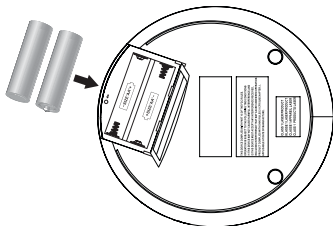

BATTERY NOTE AND CARE

1. Danger of explosion if the battery is replaced incorrectly. Replace only with the same or equivalent type
2. Do not mix old and new batteries.
3. Do not mix alkaline, standard (carbon-zinc) or rechargeable (nickel-cadmium) batteries.
4. If the unit is not to be used for an extended period of time, remove the batteries. Old or leaking batteries can cause damage to the unit and may void the warranty.
5. Do not try to recharge batteries not intended to be recharged; they can overheat and rupture. (Follow battery manufacturer's directions).
6. Do not dispose of batteries in fire, batteries may leak or explode.

Using an USB Wall adaptor (not included) to power the unit

1. Connect Deluxe Portable CD Player to Micro USB Cable (Included)
2. Connect Micro USB Cable to USB Wall Adapter (Not Included). Please make sure it is at least DC 4.5V
3. Connect USB Wall Adapter (Not Included) to Wall Outlet.

NOTE: Before connecting the USB Wall adaptor (Not included) to the wall outlet, make sure that the AC voltage of the adaptor corresponds to you local AC outlet voltage. The polarity of the adaptor must match to the polarity markings next to the DC jack on the player

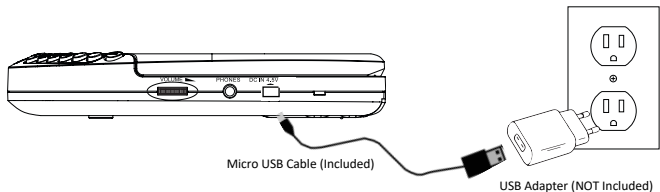

NOTE: When AC adaptor is connected, the batteries will be automatically disconnected and the player will now operate on the adaptors power. Once the adaptor is unplugged the player will automatically switch to back to battery power.

EARBUDS CONNECTION

Connect the plug of the stereo earbuds (included) into the PHONES socket. Compatible with any stereo earbuds or headphones with 1/8 Headphone Jack.

CAUTION

- **AVOID EXCESSIVE VOLUME LEVELS FOR LONG PERIODS OF TIME WHEN USING THE HEADPHONES. PROLONGED USE AT HIGH LEVELS MAY IMPAIR YOUR HEARING.**
- **Do not use earbuds while operating a motorized vehicle, as it may create a traffic hazard and is illegal in many areas**

CD OPERATION

PLEASE READ THIS IMPORTANT INFORMATION:

CD mechanisms used in devices like this are designed to fully read all commercial CDs. They will also read self-compiled CD- but it may take up to 10 seconds for playback to start. If playback does not start, it is likely due to the quality of the CD-R/RW disc and/or the compatibility of the CD compilation software. Manufacturer is not responsible for the playback quality of CD-R/RW discs. Do not attach a label or seal to either side of the CD-R/RW disc. It may cause a malfunction. **This player does not read MP3 file CDs**

Turning Unit Power On and Off

To Turn ON the unit, press the PLAY/PAUSE ►|| button, LCD display will be on and then read the inserted disc after display "60 SEC" anti-skip message. If no disc is inserted or the inserted disc has an error, the display will show "disc".

- To Turn OFF, in CD stop mode, press STOP button once, display will go off. In CD playing mode, press STOP button twice will also turn off the power.

NOTE: When the unit is stopped for approximately 30 seconds, the power will be automatically turned off.

Play Mode

1. In power off mode, press the CD door OPEN switch to open the CD door.
2. Insert a CD with the label side facing upward and then close the CD door.
3. Press the PLAY/PAUSE ►|| button to turn on the unit. The display will show "60 SEC", total number of tracks and playing time in sequence and then start to play first track automatically.
4. While playing, press the PLAY/PAUSE ►|| BUTTON to pause, the elapsed time will flash. Press PLAY/PAUSE ►|| BUTTON again to resume playing
5. Rotate the VOLUME CONTROL KNOB to adjust volume level.
6. Press the ■ STOP BUTTON to stop playing.
7. Press the ■ STOP BUTTON again to turn the unit off. **NOTE:** Do not

open the CD DOOR when a CD is playing.

PLAY MODE

NORMAL PLAYBACK

The whole disc is played and the player will stop after the last track is finished.

SKIP AND SEARCH MODE

1. During Play or Pause mode, tap the SKIP Forward "▶▶" or SKIP BACKWARD "◀◀" BUTTON to go to the next track or go back to the beginning of the current track.
2. During play mode or Pause mode, press and hold the SEARCH Forward "▶▶" or SEARCH BACKWARD "◀◀" BUTTON to search within the current track with audible high speed playback.

Every time the MODE button is pressed, the corresponding mode appears in the display window, in the following sequence:

REPEAT 1:

When shown on the LCD display, the current track on the disc will be repeated.



REPEAT ALL:

When shown on the LCD display, all tracks on the disc will be repeated.



To cancel the Repeat function, press the MODE button repeatedly until the icon disappears.

INTRO:

To play the first 10 seconds of each track on the disc.





RANDOM:

Enables all the tracks on the disc to be played in a random sequence.



To cancel INTRO & RANDOM function, press the MODE button repeatedly until the icon disappears.

PROGRAMMED PLAY

1. In CD stop mode, press the PROG button once, PROG appears. PROG icon and Track number "00" start flashing in the display.
2. Press SEARCH/SKIP   button to select the desired track.
3. When the desired track is displayed, press the PROG button to register. The PROG number changes to 02. Track number returns to 00 and flashes together with PROG.
4. Repeat above steps 2 and 3 to program more tracks. Up to 20 tracks can be programmed into the memory.
5. Press PLAY/PAUSE  button to start the programmed play.
6. To erase the program, in STOP mode simply press the STOP button.



ANTI-SKIP PROTECTION

This player incorporates an electronic anti-skip circuit to prevent interruption of the sound output when the unit is subjected to shock, vibration or rolling during disc playback. The anti-shock system will automatically activate when a disc is playing, the ESP indicator will appear in the display and flashing.

Once anti-skip buffer is full, it will give you approximately 60 seconds of protection against interruption of sound output. If the player is subjected to shock or rolling for longer than the buffer memory, some interruption of sound output will occur. This is normal and to be expected and the sound will resume once the player has stabilized from the shock or rolling disturbance.

Note: The anti-skip function provides for continuous sound output when the unit is subjected to shock or vibration. It will not compensate for errors arising from the use of defective, scratched or dirty discs.

LCD DISPLAY INFORMATION

At initial start u p

- The display will show "60 SEC" then "- -" and then the total number of tracks and total playing time. The disc will start playing and the display will show the first track number & instant playing time.
- To review the total number of tracks and total playing time of the disc, press the STOP ■ button once.

During PLAY mode

- The track number and the elapsed time are displayed.

During PAUSE mode

- When the track playback is paused, the elapsed time flashes.

CARE AND MAINTENANCE

1. Never wrap the earbuds cord around any animal or person. Special care should be taken with long wires.
2. Clean the unit with a soft, damp (never wet) cloth. Solvent or detergent should never be used.
3. Avoid operating your unit under direct sunlight or in hot, humid or dusty places to reduce the risk of fire or electric shock.
4. Keep your unit away from heating appliances and sources of electrical noise such as fluorescent lamps or motors.
5. For better Display clarity, avoid operating the unit under direct sunlight or in strong room illumination.
6. Unplug the unit from the electrical power outlet immediately in case of malfunction.
7. If drop-outs or interruptions occur in the music during CD play, or if the CD fails to play at all, its bottom surface may require cleaning. Before playing, wipe the disc from the center outwards with a lint-free soft cleaning cloth.



CAUTION: Never allow any water or other liquids to get inside the unit while cleaning.

CONNECTING TO EXTERNAL SPEAKER OR CAR

Connect one end of the 3.5 Aux in Cable (Included) to the "Phones" Jack. Ensure to Connect the other end of the 3.5mm Aux in Cable to the Aux in or Line in Jack of your External Speaker or Car.

If your Car has a USB port, then you may also power your Deluxe Portable CD Player with the supplied Micro USB Cable.

Helpful Tips:

- Ensure to adjust the VOLUME on BOTH the Portable CD Player and External Speaker/Car
- On the External Speaker or Car ensure to set the SOURCE to AUX in or LINE in
- Refer to the instruction manual of your External Speaker or Car

NOTE: EXTERNAL SPEAKER / CAR MUST HAVE AUX IN / LINE IN JACK

insert completely into the "Phones" Jack.

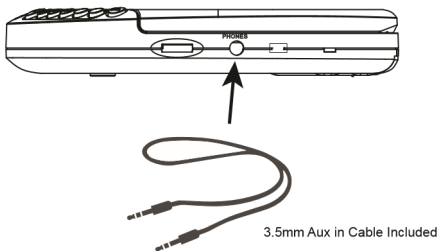

OR



IMPORTANT: CAR MUST
HAVE **AUX IN / LINE IN JACK**



TROUBLESHOOTING GUIDE

If you experience problems in the use of this player, please check the following

PROBLEM	POINTS TO CHECK
Player fails to function	Disc may be inserted upside down Disc not mounted correctly Dirty or defective disc Dirty lens Player lid not closed Moisture/Condensation, allow player to warm up to room temperature for 60 minutes AC power to adaptor switched off Weak batteries Auto switch off has occurred
No sound from earbuds	Earbuds plug is not firmly inserted into the Phones socket.
Intermittent sound	Dirty or defective disc Dirty pick up lens Player is subject to excessive vibration or shock Low battery power Poor headphone connection
CD Skipping	Disc is dirty or defective. Allow CD player to play for at least 60 seconds to buffer for the Anti Skip protection to work correctly

SPECIFICATIONS

Power Requirement: 2 x "AA" (UM-3) batteries (not included) or
AC Adaptor 4.5V (not included)