

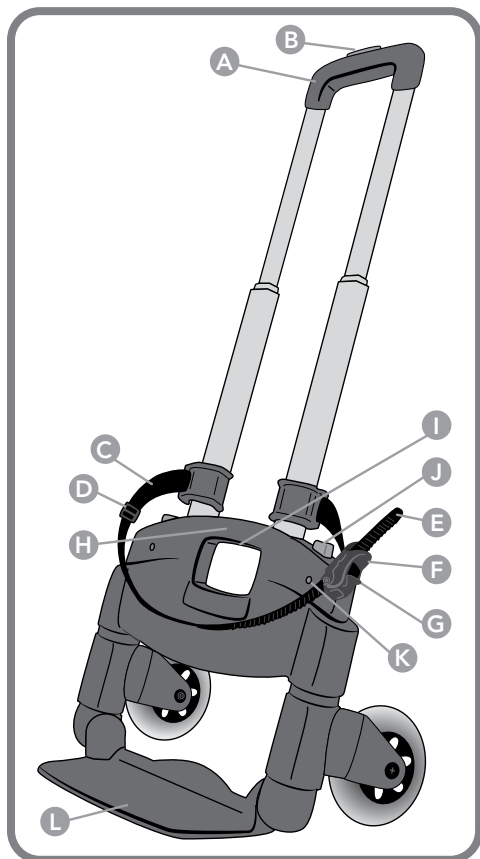

**brica**

# roll 'n go™ car seat transporter

65005



- A. Handle
- B. Push release button
- C. Attachment strap
- D. Slider adjustment
- E. Ratchet ladder strap
- F. Ratchet buckle
- G. Ratchet release tab
- H. Carry handle
- I. Tether attachment point
- J. Wheel safety lock button
- K. Wheel lock safety indicator
- L. Base platform

## To Use

1. With transporter in upright position, unfold wheels by depressing and then sliding each blue wheel lock button toward outside of unit. The wheel will self deploy and lock into place. Check that the wheel lock safety indicator has turned completely green.

**IMPORTANT:** In addition to the wheel lock indicator turning green, an audible "click" should be heard when each wheel has reached its fully open and locked position. You may need to manually open wheel until the click is heard to ensure wheel is locked in open position. **DO NOT** operate if wheels are not in the fully open and locked position.

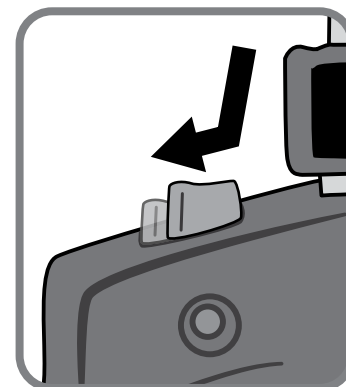

2. Unfold base platform until it is fully open.

**NOTE:** Your transporter can stand in this open position



Questions?  
1.866.869.8257  
brica.com

©2012 BRICA, Inc. 500 West 5th Street,  
Suite 220, Charlotte, NC 28202  
Retain this address for future reference.



**brica**

# roll 'n go™ car seat transporter

65005

**3.** Unbuckle attachment strap by pinching the ratchet release tab while simultaneously sliding ratchet ladder strap from ratchet buckle.

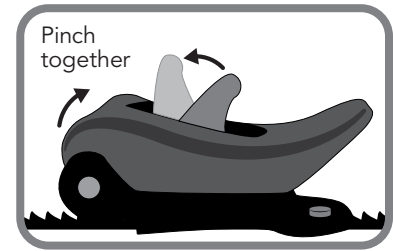
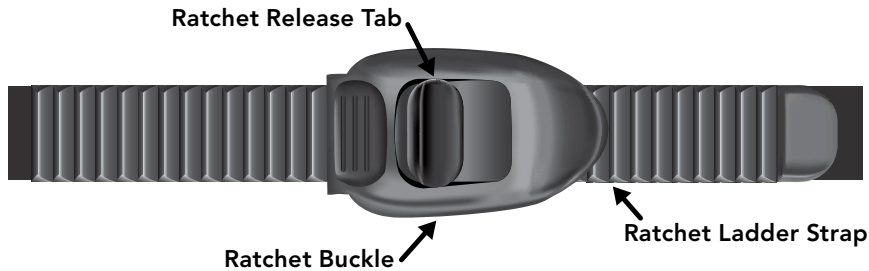

To Release

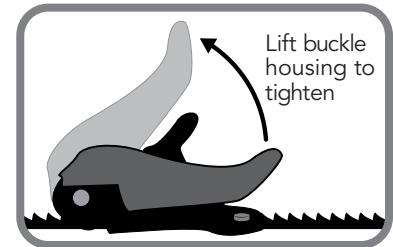

To Tighten

**4.** Place forward-facing child safety seat on platform such that seat sits flat on the ground with the back of the seat base against the transporter.

**IMPORTANT:** You must position the child safety seat in its most upright (forward facing position). Some child safety seats may require the removal of a recline block. Refer to child safety seat user guide for details.



**5.** Route the attachment ladder strap through the forward-facing belt path route. Refer to child safety seat user guide for belt path routing details.

**6.** Insert the ratchet ladder strap into the ratchet buckle approximately 5 clicks. Remove all slack from the attachment strap by adjusting strap length with slider.

**7.** Continue to tighten the attachment strap with the ratchet buckle by lifting and releasing the buckle tab until seat is secure. **DO NOT** over tighten.



Questions?  
1.866.869.8257  
brica.com

©2012 BRICA, Inc. 500 West 5th Street,  
Suite 220, Charlotte, NC 28202  
Retain this address for future reference.



**brica**

# roll 'n go™ car seat transporter

65005

**8.** It is recommended that you also attach the child safety seat's tether strap to the tether attachment point recessed in the transporter carry handle, removing all slack in the tether strap. Store excess tether strap webbing. Test seat and transporter attachment prior to boarding child.

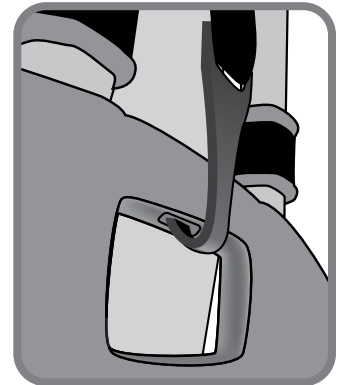
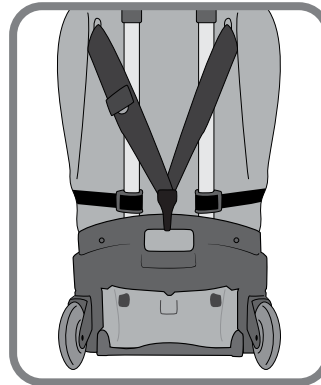

**9.** Board child and properly buckle as per the child safety seat user guide.

**10.** Raise telescoping handle to desired position by depressing push release button located on handle. The handle will lock into one of two raised positions.

**11.** Pull back on handle to raise front of child safety seat for transport. Pull (or push) through the airport with ease!

**NOTE:** In some circumstances it may be helpful to place your foot behind transporter wheel to "block" the wheel while pulling back on handle. This will make it easier to raise front of seat.

## To Store

**1.** With child and child safety seat removed from transporter, lower telescoping handle by depressing push release button on handle and pushing handle down.

**2.** Raise base platform to closed position.

**3.** Depress each wheel lock button and slide to outside of transporter. With button held in this position, begin to fold wheel into closed position. Release button and continue folding wheel to closed position. An audible click will be heard and the wheel lock safety indicator will turn green when wheel locks into closed position.

**4.** When folded, you may store your BRICA Roll 'n Go™ Car Seat Transporter in the overhead bin of an aircraft.



Questions?  
1.866.869.8257  
brica.com

©2012 BRICA, Inc. 500 West 5th Street,  
Suite 220, Charlotte, NC 28202  
Retain this address for future reference.



**brica**

# roll 'n go™ car seat transporter

65005

## **WHILE IN USE:**

While using the BRICA Roll 'n Go™ Car Seat Transporter, it may be useful to fold the wheels and lower the handle while riding on an airport shuttle bus. This will minimize the seat size and protect the wheels. Lower the handle and close the wheels as described in "To Store." The transporter's carry handle can be used to lift the transporter and [vacant] child safety seat combination.

**IMPORTANT:** DO NOT fold wheels while child is sitting in child safety seat while attached to transporter. DO NOT lift occupied transporter by carry handle on transporter alone.

### **WARNING**

- Do not leave child unattended
- Child must always be properly buckled in child safety seat
- Always remove child safety seat from transporter prior to installation of child safety seat in vehicles and aircraft
- Do not exceed weight capacity of child safety seat
- Use transporter to transport children in child safety seat or unoccupied child safety seat only
- For use by adults only
- Do not use on stairways, escalators or moving sidewalks
- Do not hang items on handle – doing so may cause the transporter to become unstable and tip over
- Do not run or walk in excessive speeds. Avoid abrupt, sharp turns
- Do not abruptly let go of handle when transporter is in use
- Refer to handle for maximum recommended weight capacity



Questions?  
1.866.869.8257  
brica.com

©2012 BRICA, Inc. 500 West 5th Street,  
Suite 220, Charlotte, NC 28202  
Retain this address for future reference.