

AMERISPAN

BY EVENTEC

AS200 25m (82') Width, 3.4m Leg Standard Structure

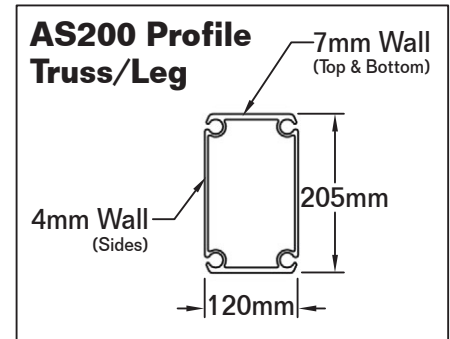
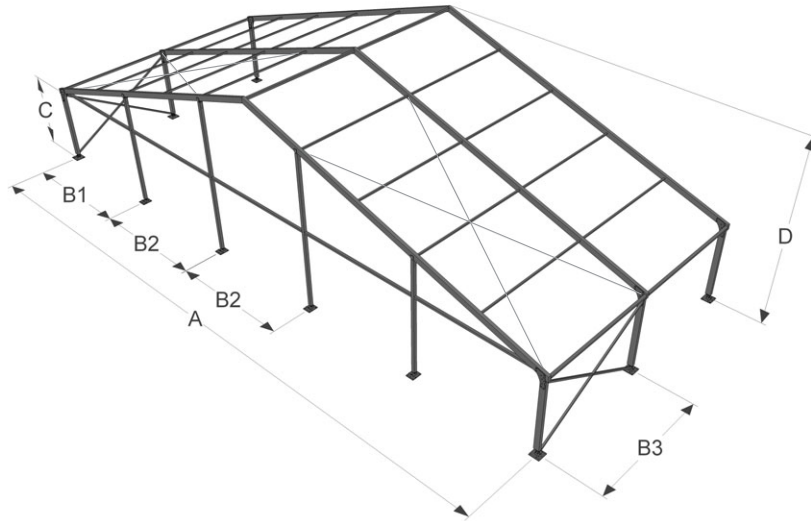

Dimensions and Technical Specifications

All Dimensions On Center

(A) Width	25.08m	82.26ft
(B1) Gable Leg Distance	5.04m	16.53ft
(B2) Gable Leg Distance	5.00m	16.40ft
(B3) Truss/Leg Distance	5.00m	16.40ft
(C) Eave Height	3.25m	10.65ft
(D) Ridge Height	7.29m	23.92ft

Compatible with Glasswall or Hardwall Systems

Roof Slope	18 degrees
------------	------------

Extruded Aluminum Parts

Hollow, Tracked Profile Shown Above
6061 T-6 Aluminum
Clear Anodized 204-R1 Finish

Steel Parts

A36 Structural Steel
A572 Grade 50 for Leg Reinforcement Plates
Hot-Dip Galvanized for Corrosion Resistance

AS200 X-Bracing

One 5m Bay Containing X-Bracing and Rafter
Cables Can be Followed with Up To Five
Open 5m Bays Without X-Braces or Cables

*Technical specifications may change at any time
without notice. ©2012 Eventec

Available Exclusively From:

