

# Pfaff 939 Subclass

# PFAFF

## 939

Unterklassen-Ausstattung

Subclass parts

Composition des sous-classes

Composición de las subclases

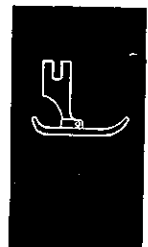

**Table of subclasses**  
**Table des sous-classes**  
**Tabla de subclases**

**PFAFF 939**





Unterklasse Subclass Sous-classe Subclase	-6/01 (-900/..)	-32/23 (-900/..)
Arbeitsgang Operation Opération Operación	<p>Für allgemeine Näharbeiten. Standardform des Teilesatzes. For ordinary sewing operations. Standard parts set. Travaux d'utilité courante. Jeu de pièces standard. Para trabajos de costura en general. Juego de piezas estándar.</p> 	
Ausführung Model Version Tipo de máquina	AB	BN 24
Überstichbreite in mm Stitch width in mm Jetée de l'aiguille en mm Anchura del zigzag en mm	6,0	6,0
Nadelstange Needle bar Barre à aiguille Barra de aguja	91-168 019-91	91-168 019-91
Nähfuß <sup>4</sup> Presser foot Pied presseur Pie prensatelas	91-054 695-23	91-157 299-93
Stichplatte <sup>4</sup> Needle plate Plaque à aiguille Placa de aguja	91-058 034-24	91-058 113-24
Stoffschieber <sup>4</sup> Feed dog Griffe Transportador inferior	91-047 381 03	91-047 746-03
Apparat <sup>5</sup> Attachment Appareil Aparato		91-050 946-23
Träger Bracket Support Soporte		91-753 936-90

Table des sous-classes  
 Tabla de subclases

PFAFF 939

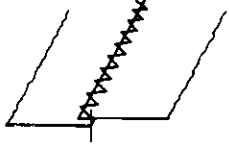
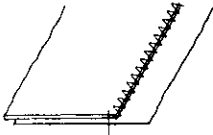
Unterklasse Subclass Sous-classe Subclase	-65/23 (-900/..)	-771/04-6/27 (-900/..)	-771/04-280/06 (-900/..)
Arbeitsgang Operation Opération Operación			
Ausführung Model Version Tipo de máquina	BN 24	AN 13	AN 13
Überstichbreite in mm Stitch width in mm Jetée de l'aiguille en mm Anchura del zigzag en mm	6.0	3.0	3.0
Nadelstange Needle bar Barre à aiguille Barra de aguja	91-168 019-91	91-168 019-91	91-168 019-91
Nähfuß [4] Presser foot Pied presseur Pie prensatelas	91-155 047-91	91-155 954-03	91-154 195-91
Stichplatte [4] Needle plate Plaque à aiguille Placa de aguja	91-058 113-24	91-150 168-93	91-150 168-93
Stoffschieber [4] Feed dog Griffe Transportador inferior	91-047 746-03	91-059 787-03	91-059 787-03
Lineal Edge guide Guide-droit Guía recta	91-053 620-70/895		
Träger Bracket Support Soporte			91-187 247-70/893 91-167 298-71/895

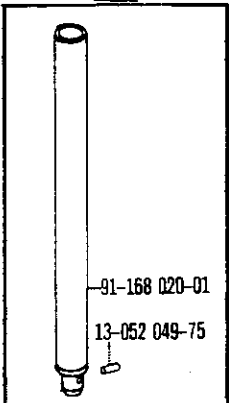
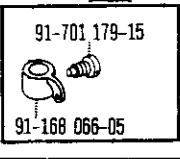
<p>91-168 019-91</p>  <p>91-168 020-01 13-052 049-75</p> <p>91-168 066-92</p>  <p>91-701 179-15 91-168 066-05</p> <p>-6/01 (-900/..) -32/23 (-900/..) -65/23 (-900/..) -771/04-6/27 (-900/..) -771/04-280/06 (-900/..)</p>	<p>91-054 695-23 <span style="border: 1px solid black; padding: 0 2px;">4</span></p>  <p>-6/01 (-900/..)</p>	<p>91-154 195-91 <span style="border: 1px solid black; padding: 0 2px;">4</span></p>  <p>91-155 943-05 <span style="border: 1px solid black; padding: 0 2px;">3/1</span></p> <p>-771/04-280/06 (-900/..)</p>	<p>91-155 047-91 <span style="border: 1px solid black; padding: 0 2px;">4</span></p>  <p>91-157 303-05 <span style="border: 1px solid black; padding: 0 2px;">3/1</span></p> <p>-65/23 (-900/..)</p>
<p>91-168 066-92</p>  <p>91-701 179-15 91-168 066-05</p> <p>-6/01 (-900/..) -32/23 (-900/..) -65/23 (-900/..) -771/04-6/27 (-900/..) -771/04-280/06 (-900/..)</p>	<p>91-155 954-03 <span style="border: 1px solid black; padding: 0 2px;">4</span></p>  <p>91-057 124-04 <span style="border: 1px solid black; padding: 0 2px;">3/1</span></p> <p>-771/04-6/27 (-900/..)</p>	<p>91-157 299-93 <span style="border: 1px solid black; padding: 0 2px;">4</span></p>  <p>11-210 041-15 91-057 441-05 11-210 041-15 91-157 303-05 <span style="border: 1px solid black; padding: 0 2px;">3/1</span></p> <p>-32/23 (-900/..)</p>	<p>91-058 034-24 <span style="border: 1px solid black; padding: 0 2px;">4</span></p>  <p>-6/01 (-900/..)</p>
<p>91-058 113-24 <span style="border: 1px solid black; padding: 0 2px;">4</span></p>  <p>-32/23 (-900/..) -65/23 (-900/..)</p>	<p>91-150 168-93 <span style="border: 1px solid black; padding: 0 2px;">4</span></p>  <p>91-150 166-05 11-108 849-25 91-150 167-04 <span style="border: 1px solid black; padding: 0 2px;">4</span> 11-108 849-25</p> <p>-771/04-6/27 (-900/..) -771/04-280/06 (-900/..)</p>	<p>91-047 381-03 <span style="border: 1px solid black; padding: 0 2px;">4</span></p>  <p>91-047 383-04 <span style="border: 1px solid black; padding: 0 2px;">4</span> 91-047 382-04 <span style="border: 1px solid black; padding: 0 2px;">4</span></p> <p>-6/01 (-900/..)</p>	
<p>91-047 746-03 <span style="border: 1px solid black; padding: 0 2px;">4</span></p>  <p>91-047 748-04 <span style="border: 1px solid black; padding: 0 2px;">4</span> 91-047 747-04 <span style="border: 1px solid black; padding: 0 2px;">4</span></p> <p>-32/23 (-900/..) -65/23 (-900/..)</p>	<p>91-059 787-03 <span style="border: 1px solid black; padding: 0 2px;">4</span></p>  <p>91-059 788-04 <span style="border: 1px solid black; padding: 0 2px;">4</span> 91-059 789-04 <span style="border: 1px solid black; padding: 0 2px;">4</span></p> <p>-771/04-6/27 (-900/..) -771/04-280/06 (-900/..)</p>	<p>11-108 168-25 12-305 114-25</p>  <p>91-050 946-23 <span style="border: 1px solid black; padding: 0 2px;">3</span></p> <p>-32/23 (-900/..)</p>	

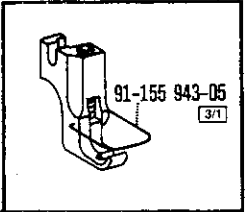
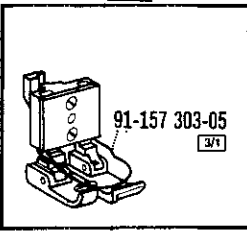
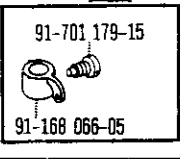
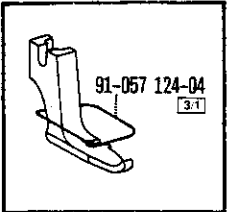
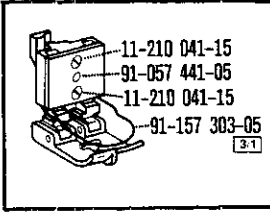
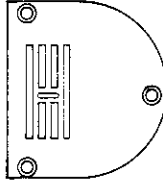
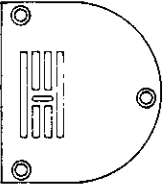
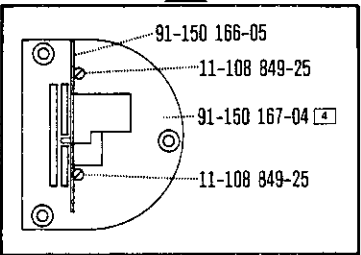
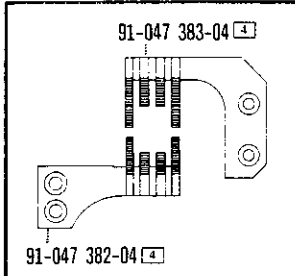
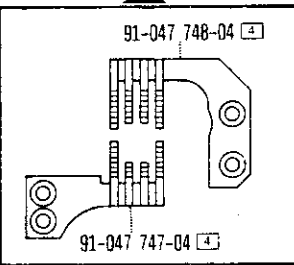
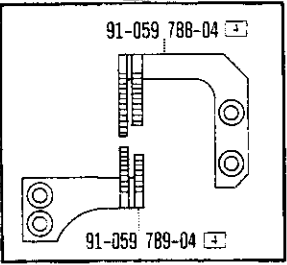
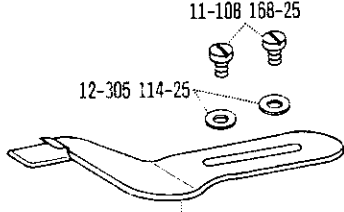
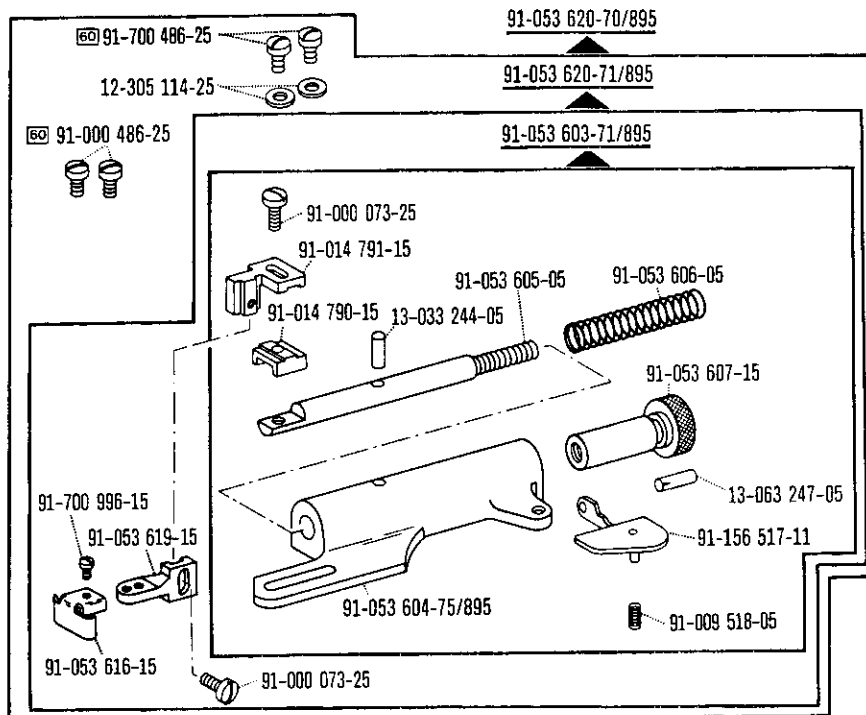

-65/23 (-900/..)

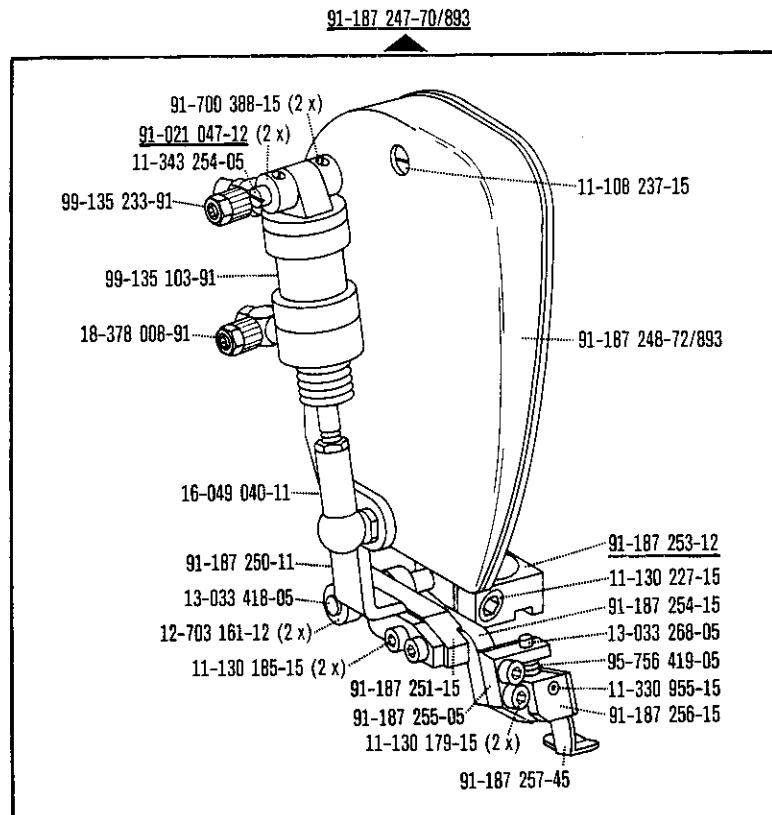

-771/04-280/06 (-900/..)

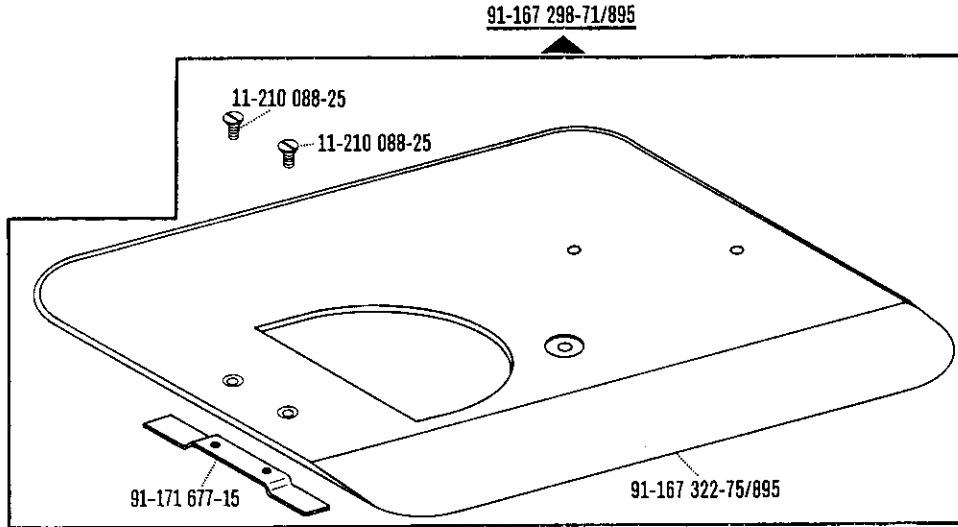

-771/04-280/06 (-900/..)

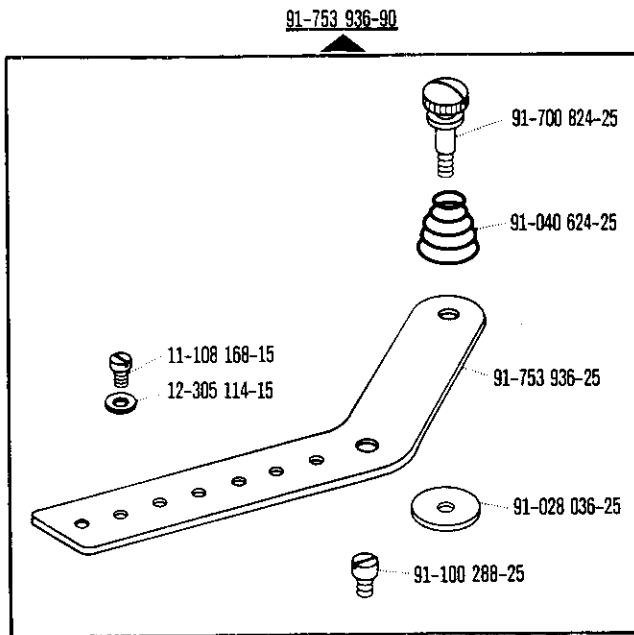

-32/23 (-900/..)