

Pfaff 292
Subclass
April 1983



292

Unterklassen-Ausstattung
Subclass parts
Composition des sous-classes
Composición de las subclases

Unterklassen-Ausstattung¹⁾

Subclass organization¹⁾

Equipement des sous-classes¹⁾

Dotación de las subclases¹⁾

Unterklasse Subclass Sous-classe Subclase	Ausführung Model Version Tipo de máquina	Nadelabstand in mm Needle gauge in mm Ecartement des aiguilles en mm Distancias entre agujas en mm	Nadelhalter ^[102] Needle holder Pince-aiguille Portaagujas	Stoffschieber ^[4] ^[101] ^[102] Feed dog Griffe Transportador interior	Sichplatte ^[4] ^[101] ^[102] Needle plate Plaque à aiguille Placa de aguja	Nähfuß ^[4] ^[102] Presser foot Pied presseur Pie prensatelas
-6/01	BN CN	2,4 – 20,0 4,0 – 20,0	91-710 004-93	91-040 365-04	91-048 064-04	91-040 811-03
-6/01-900/56	BN CN	2,4 – 12,0 4,0 – 12,0	91-710 004-93	91-059 262-04	91-158 388-04	91-040 811-03
-57/01	BN	4,0 – 20,0	91-710 004-93	91-040 365-04	91-048 064-04	91-040 811-03
-57/01-900/56	BN	4,0 – 12,0	91-710 004-93	91-059 262-04	91-158 388-04	91-040 811-03
-58/01	BN	4,0 – 20,0	91-710 004-93	91-040 365-04	91-048 064-04	91-040 811-03
-58/01-900/56	BN	4,0 – 12,0	91-710 004-93	91-059 262-04	91-158 388-04	91-040 811-03
-61/01	BN	3,2 – 20,0	91-710 004-93	91-040 365-04	91-048 064-04	91-026 578-03 ^[15/1]
-61/01-900/56	BN	3,2 – 12,0	91-710 004-93	91-059 262-04	91-158 388-04	91-026 578-03 ^[15/1]
61/09	BN	3,2 – 20,0	91-710 004-93	91-040 365-04	91-048 064-04	91-040 584-03 ^[15/1]
-61/09-900/56	BN	3,2 – 12,0	91-710 004-93	91-059 262-04	91-158 388-04	91-040 584-03 ^[15/1]
-63/03	BN	2,4 – 20,0	91-710 004-93	91-040 866-04	91-048 065-04	91-040 845-03
-63/03	CN	4,0 – 20,0	91-710 004-93	91-040 866-04	91-058 577-04	91-040 845-03
-69/01	BN	3,2 – 20,0	91-710 004-93	91-040 365-04	91-048 064-04	91-026 758-23 ^[5]
-69/01-900/56	BN	3,2 – 12,0	91-710 004-93	91-059 262-04	91-158 388-04	91-026 758-23 ^[5]
-232/01	B	3,2 – 20,0	91-710 004-93	91-490 640-04	91-490 528-04 ^[15/1]	91-491 839-03 ^[5]

¹⁾ Die Liste enthält nur Nähwerkzeuge und Apparate. Beim Umbau in eine andere Unterklasse oder Ausführung sind auch noch Maschinenteile erforderlich. Geben Sie also bei Bestellungen die genaue Bezeichnung der vorhandenen und der gewünschten Ausführung bekannt.

¹⁾ This list contains sewing parts and attachments only. When converting to another subclass or version, machine parts are also necessary. When ordering please therefore indicate exactly the existing version and the one required.

¹⁾ Cette liste ne contient que les organes de couture et les guides. En cas de transformation en une sous-classe ou variante différente, il faut utiliser aussi certaines pièces de machine supplémentaires. En cas de commande, prière de toujours indiquer par conséquent les variantes disponibles et souhaitées.

¹⁾ Esta lista sólo contiene elementos de costura y aparatos. Siempre que haya que transformar la máquina en otro tipo o subclase, se necesitarán también piezas de máquina, por lo que deberá indicarse en los pedidos el tipo exacto de que se dispone y el deseado.

Unterklassen-Ausstattung¹⁾

Subclass organization¹⁾

Unterklasse Subclass Sous-classe Subclase	Ausführung Model Version Tipo de máquina	Apparat ⁴⁾ Attachement Appareil Aparato	Träger Bracket Support Soporte	Bandführung Tape guide Guide-ruban Guiacintas	Bandtrömmel Tape reel Tambour-dérouleur Tambour portacintas	Fingerschutz ^{10/2)} Finger guard Protège-digts Salvadedos
-6/01	BN CN					
-6/01-900/56	BN CN					
-57/01	BN	91-040 275-93 ¹⁰⁾ = 4 - 10 mm 91-040 844-24 ¹⁰⁾ = 10,4 - 20 mm	91-040 166-21			
-57/01-900/56	BN	91-040 275-93 ¹⁰⁾ = 4 - 10 mm 91-040 844-24 ¹⁰⁾ = 10,4 - 12 mm	91-040 166-21			
-58/01	BN	91-040 273-93 ¹⁰⁾ = 4 - 10 mm 91-042 070-24 ¹⁰⁾ = 10,4 - 20 mm	91-040 166-21			
-58/01-900/56	BN	91-040 273-93 ¹⁰⁾ = 4 - 10 mm 91-042 070-24 ¹⁰⁾ = 10,4 - 12 mm	91-040 166-21			
-61/01	BN				91-040 207-91	91-057 741-91 ¹⁰⁾ = 3,2 - 4,4 mm 91-057 806-91 ¹⁰⁾ = 4,8 - 15,2 m 91-057 809-91 ¹⁰⁾ = 16,0 - 20,0 r
-61/01-900/56	BN				91-040 207-91	91-057 741-91 ¹⁰⁾ = 3,2 - 4,4 mm 91-057 806-91 ¹⁰⁾ = 4,8 - 12,0 m
61/09	BN					91-057 741-91 ¹⁰⁾ = 3,2 - 4,4 mm 91-057 806-91 ¹⁰⁾ = 4,8 - 15,2 m 91-057 809-91 ¹⁰⁾ = 16,0 - 20,0 r
-61/09-900/56	BN					91-057 741-91 ¹⁰⁾ = 3,2 - 4,4 mm 91-057 806-91 ¹⁰⁾ = 4,8 - 12,0 m
-63/03	BN	91-041 182-91		91-053 228-21 ¹⁰⁾ = 2,4 - 6 mm 91-042 211-21 ¹⁰⁾ = 6,4 - 20,0 mm		
-63/03	CN	91-041 182-91		91-053 228-21 ¹⁰⁾ = 4,0 - 6 mm 91-042 211-21 ¹⁰⁾ = 6,4 - 20,0 mm		
-69/01	BN				91-041 644-91	91-055 261-91 ¹⁰⁾ = 3,2 - 8,0 mm 91-055 259-91 ¹⁰⁾ = 9,2 - 20,0 m
-69/01-900/56	BN				91-041 644-91	91-055 261-91 ¹⁰⁾ = 3,2 - 8,0 mm 91-055 259-91 ¹⁰⁾ = 9,2 - 12,0 m
-232/01	B					91-057 741-91 ¹⁰⁾ = 3,2 - 4,4 mm 91-057 806-91 ¹⁰⁾ = 4,8 - 15,2 m 91-057 809-91 ¹⁰⁾ = 16,0 - 20,0 r

⁴⁾ = Ausführung angeben
= Indicate model
= Préciser la version
= Indiquez el tipo de máquina

⁸⁾ = Nähmuster einsenden
= Submit sewing sample
= Joindre échantillons de couture
= Envíese muestra de costura







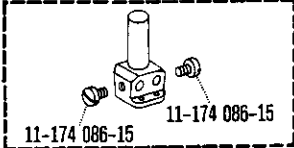

¹⁰⁾ = Nadelabstand
= Needle gauge
= Écartement des aiguilles
= Distancia entre agujas

^{10/1)} = je nach Nadelabstand ändert sich die Form (z.B. beim Stoffschieber die Anzahl der Zahnreihen)
= Certain design features change according to the needle gauge (e.g. the number of tooth rows on the feed dog)
= La forme est fonction de l'écartement des aiguilles (par ex. le nombre des rangées de dents de la griffe).
= La forma varia de acuerdo con la distancia entre agujas (p.e. el número de hileras de dientes en el transportador)



^{10/2)} = Nadelabstand bei Bestellung angeben
= State needle gauge on order
= Indiquer écartement des aiguilles à la commande
= Indiquez la distancia entre agujas

^{15/1)} = Bandbreite bei Bestellung angeben
= Tape width to be stated on order
= Largeur de bande, à préciser à la commande
= Indiquez el ancho de la cinta en los pedidos

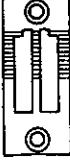
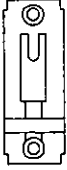
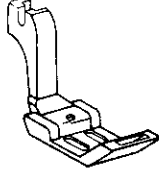
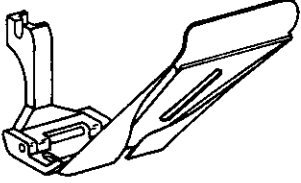
Unterklassen-Übersicht/ Table of subclasses/ Table des sous-classes/ Tabla de subclases



<p>91-710 004-93 4 10/1 10/2</p> 	<p>91-040 365-04 4 10/1 10/2</p> 	<p>91-040 866-04 4 10/1 10/2</p> 	
<p>-6/01 -57/01 -58/01 -61/01 -61/09 -63/03 -69/01 -232/01</p>	<p>91-059 262-04 4 10/1 10/2</p>  <p>-6/01-900/56 -57/01-900/56 -58/01-900/56 -61/01-900/56 -61/09-900/56 -69/01-900/56</p>	<p>91-490 640-04 4 10/1 10/2</p>  <p>-63/03</p> <p>-232/01</p>	
<p>91-048 064-04 4 10/1 10/2</p>  <p>-6/01 -57/01 -58/01 -61/01 -61/09 -69/01</p>	<p>91-048 065-04 4 10/1 10/2</p>  <p>-63/03 BN</p>	<p>91-058 577-04 4 10/1 10/2</p>  <p>-63/03 CN</p>	<p>91-158 388-04 4 10/1 10/2</p>  <p>-6/01-900/56 -57/01-900/56 -58/01-900/56 -61/01-900/56 -61/09-900/56 -69/01-900/56</p>
<p>91-490 528-03 4 10/1 10/2 15/1</p>  <p>-232/01</p>		<p>91-026 578-03 4 10/2 15/1</p>  <p>-61/01 (-900/56)</p>	<p>91-026 758-03 4 5 10/2</p>  <p>-69/01 (-900/56)</p>

Unterklassen-Übersicht/Table of subclasses/Table des sous-classes/Tabla de subclasses

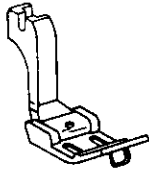
91-040 584-03   



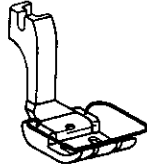

-61/09 (-900/56)

91-040 811-03  



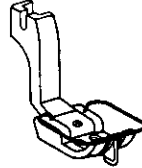

-6/01 (-900/56)
-57/01 (-900/56)
-58/01 (-900/56)

91-040 845-03  



-63/03 (-900/56)

91-491 839-03   



-232/01

91-040 273-93 

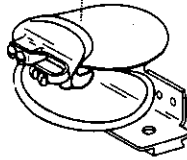

91-000 646-25



-58/01 (-900/56)

91-040 275-93 

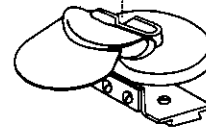

91-000 646-25



-57/01 (-900/56)

91-040 844-24 

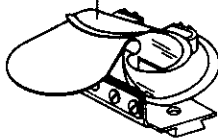

91-000 646-25



-57/01 (-900/56)

91-041 182-91 

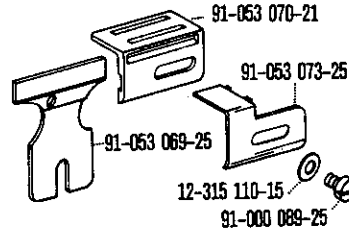

91-053 070-21
91-053 073-25
91-053 069-25
12-315 110-15
91-000 089-25

-63/03

91-042 070-24 

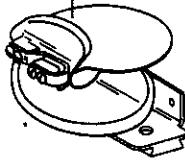

91-000 646-25



-58/01 (-900/56)

91-040 166-21

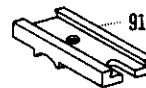

91-040 180-25

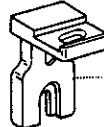

91-040 466-25

91-000 646-25



91-000 412-25

-57/01 (-900/56)

-58/01 (-900/56)

Unterklassen-Übersicht/Table of subclasses/Table des sous-classes/Tabla de subclases

91-042 211-21  = 6,4 - 20,0 mm

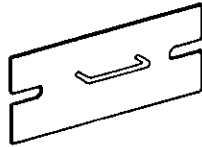

-63/03

91-053 228-21  = 2,4 - 6,0 mm

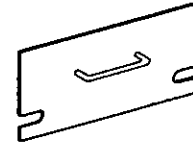

-63/03

91-040 207-91

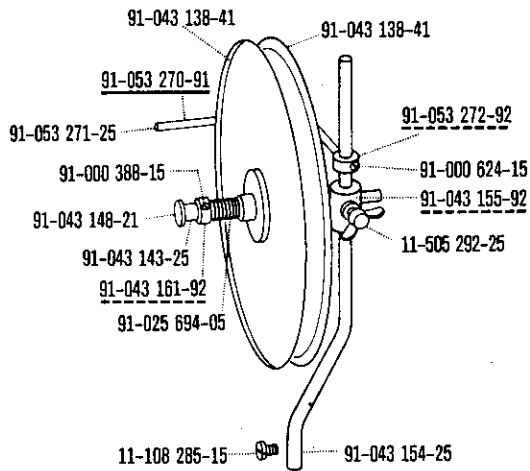

-61/01 (-900/56)

91-041 644-91

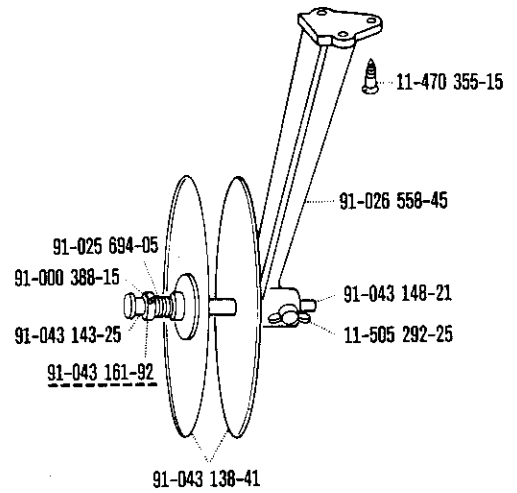

-69/01 (-900/56)

91-055 261-91  = 3,2 - 8,0 mm

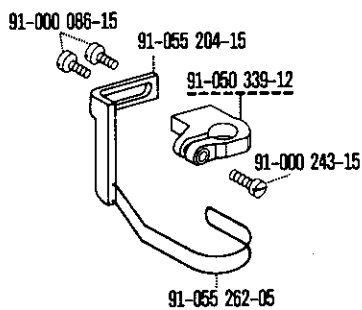

-69/01 (-900/56)

91-056 259-91  = 9,2 - 20,0 mm

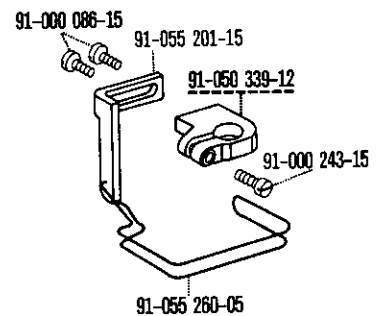

-69/01 (-900/56)

Unterklassen-Übersicht/ Table of subclasses/ Table des sous-classes/ Tabla de subclasses

