

Pfaff 244 Subclass

Unterklassen-Ausstattung

Subclass parts

Composition des sous-classes

Composición de las subclases

17.01

Unterklassen-Ubersicht ▲
 Table of subclasses
 Table de sous-classes
 Tabla de subclases PFAFF 244

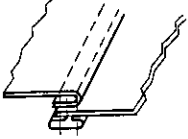
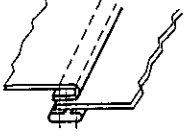
Unterklasse Subclass Sous-classe Subclase	-70/13	-70/13	-750/04-4/01
Arbeitsgang Operation Opération Operación			Für Stepparbeiten an Schuhschläften und sonstigen Lederwaren mittels angetriebenen Rollfuß. For stitching shoe uppers and other leather articles with driven roller presser. Travaux de piquage sur tiges ou autres articles en cuir, par pied à roulette entraînée. Para trabajos de pespunteado en cortes de calzado y en artículos de cuero mediante pie rodante accionado.
Ausführung Model Version Tipo de máquina	AN 2,5	BN 2,5	
Nadelabstand in mm Needle gauge in mm Ecartement des aiguilles en mm Distancia entre agujas en mm	3,2	4,8	1,2; 1,6; 2,4
Teilesatz vollst. Part set assy. Jeu de pièces complète Juego de piezas compl.	91-201 720-93/003	91-201 720-93/004	91-202 283-93/003 $\overline{10}$ = 1,2 mm 91-202 283-93/001 $\overline{10}$ = 1,6 mm 91-202 283-93/002 $\overline{10}$ = 2,4 mm
Nadelhalter $\overline{10/2}$ * Needle holder Pince-aiguille Portaagujas	91-710 004-93/003	91-710 004-93/006	91-118 195-93/001 $\overline{10}$ = 1,2; 1,6 mm 91-119 309-93/001 $\overline{10}$ = 2,4 mm
Nähfuß $\overline{4}$ $\overline{10/2}$ * Presser foot Pied presseur Pie prensatelas	91-155 030-03/001	91-155 030-03/002	
Rollfuß $\overline{4}$ * Roller presser Pied à roulette Pie rodante			91-141 772-93/001 $\overline{70/1}$
Drückerfuß $\overline{4}$ $\overline{10/2}$ * Presser foot Pied presseur Pie prensatelas			91-010 805-04/007 $\overline{10}$ = 1,2 mm 91-010 880-04/008 $\overline{10}$ = 1,6 mm 91-010 882-04/005 $\overline{10}$ = 2,4 mm
Nadelführungsbügel $\overline{4}$ $\overline{10/2}$ * Needle guide Etrier Guiahilos			91-012 656-04/003 $\overline{10}$ = 1,2 mm 91-012 656-04/005 $\overline{10}$ = 1,6 mm
Fingerschutz* Finger guard Protege-doigts Salvadedos			91-012 658-91
Stichplatte $\overline{4}$ $\overline{10/1}$ $\overline{10/2}$ * Needle plate Plaque à aiguille Placa de aguja	91-158 525-04/001	91-158 525-04/006	91-158 774-04/004 $\overline{10}$ = 1,2 mm 91-158 774-04/008 $\overline{10}$ = 1,6 mm 91-150 416-04/001 $\overline{10}$ = 2,4 mm
Stoffschieber $\overline{4}$ $\overline{10/1}$ $\overline{10/2}$ * Feed dog Griffe Transportador inferior	91-059 300-04/001	91-059 300-04/006	91-026 531-04/011 $\overline{10}$ = 1,2 mm 91-026 531-04/013 $\overline{10}$ = 1,6 mm 91-059 862-04/001 $\overline{10}$ = 2,4 mm
Schieber, links $\overline{10/2}$ Slide, left Glissière, gauche Corredera, izquierda	91-018 889-24/060	91-018 889-24/060	91-018 889-24/060
Schieber, rechts $\overline{10/2}$ Slide, right Glissière, droite Corredera, derecha	91-010 061-24/060	91-010 061-24/060	91-010 061-24/060
Apparat $\overline{5}$ Attachment Appareil Aparato	91-156 074-73/002	91-156 074-73/005	
Bandrollenträger Tape reel bracket Plateau dérouleur Portarrollos	91-156 005-71/895	91-156 005-71/895	
Bandführung Tape guide Guide-ruban Guiacintas	91-044 419-25	91-044 419-25	

Unterklasse Subclass Sous-classe Subclase	-750/04-4/01-900/56	-944/01
Arbeitsgang Operation Opération Operación	Für Stepparbeiten an Schuhschäften und sonstigen Lederwaren mittels angetriebenem Rollfuß. For stitching shoe uppers and other leather articles with driven roller presser. Travaux de piquage sur tiges ou autres articles en cuir, par pied à roulette entraînée. Para trabajos de pespunteado en cortes de calzado y en artículos de cuero mediante pie rodante accionado.	Für Stepparbeiten an Schuhschäften und sonstigen Lederwaren mittels angetriebenem Rollfuß. For stitching shoe uppers and other leather articles with driven roller presser. Travaux de piquage sur tiges ou autres articles en cuir, par pied à roulette entraînée. Para trabajos de pespunteado en cortes de calzado y en artículos de cuero mediante pie rodante accionado.
Ausführung Model Version Tipo de máquina	B	B
Nadelabstand in mm Needle gauge in mm Ecartement des aiguilles en mm Distancia entre agujas en mm	1,6; 2,4	1,6; 2,2; 2,4
Teilesatz vollst. Part set assy. Jeu de pièces complète Juego de piezas compl.	91-202 284-93/001 $\overline{10}$ = 1,6 mm 91-202 284-93/002 $\overline{10}$ = 2,4 mm	91-201 718-93/001 $\overline{10}$ = 1,6 mm 91-201 718-93/003 $\overline{10}$ = 2,2 mm 91-201 718-93/002 $\overline{10}$ = 2,4 mm
Nadelhalter $\overline{10/2}$ * Needle holder Pince-aiguille Portaagujas	91-118 195-93/001 $\overline{10}$ = 1,6 mm 91-119 309-93/001 $\overline{10}$ = 2,4 mm	91-118 195-93/001 $\overline{10}$ = 1,6; 2,2 mm 91-119 309-93/001 $\overline{10}$ = 2,4 mm
Rollfuß $\overline{4}$ * Roller presser Pied à roulette Pie rodante	91-141 772-93/001 $\overline{70/1}$	91-051 159-93/001
Drückerfuß $\overline{4}$ $\overline{10/2}$ * Presser foot Pied presseur Pie prensatelas	91-010 880-04/008 $\overline{10}$ = 1,6 mm 91-010 882-04/005 $\overline{10}$ = 2,4 mm	91-010 880-04/008 $\overline{10}$ = 1,6 mm 91-010 880-04/011 $\overline{10}$ = 2,2 mm 91-010 882-04/005 $\overline{10}$ = 2,4 mm
Fingerschutz * Finger guard Protège-doigts Salvadedos	91-012 658-91	91-157 813-91
Stichplatte $\overline{4}$ $\overline{10/2}$ * Needle plate Plaque à aiguille Placa de aguja	91-058 874-04/007 $\overline{10}$ = 1,6 mm 91-058 839-04/002 $\overline{10}$ = 2,4 mm	91-158 774-04/008 $\overline{10}$ = 1,6 mm 91-158 774-04/013 $\overline{10}$ = 2,2 mm 91-150 416-04/001 $\overline{10}$ = 2,4 mm
Stoffschieber $\overline{4}$ $\overline{10/2}$ * Feed dog Griffe Transportador inferior	91-047 301-04/010 $\overline{10}$ = 1,6 mm 91-047 300-04/007 $\overline{10}$ = 2,4 mm	91-026 531-04/013 $\overline{10}$ = 1,6 mm 91-026 531-04/016 $\overline{10}$ = 2,2 mm 91-059 862-04/001 $\overline{10}$ = 2,4 mm
Schieber, links $\overline{10/2}$ Slide, left Glissière, gauche Corredera, izquierda	91-018 889-24/060	91-018 889-24/060
Schieber, rechts $\overline{10/2}$ Slide, right Glissière, droite Corredera, derecha	91-018 888-24/030	91-010 061-24/060



17.01

Unterklassen-Übersicht ▲

Table of subclasses
Table de sous-classes
Tabla de subclases

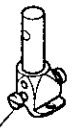

PFAFF 244

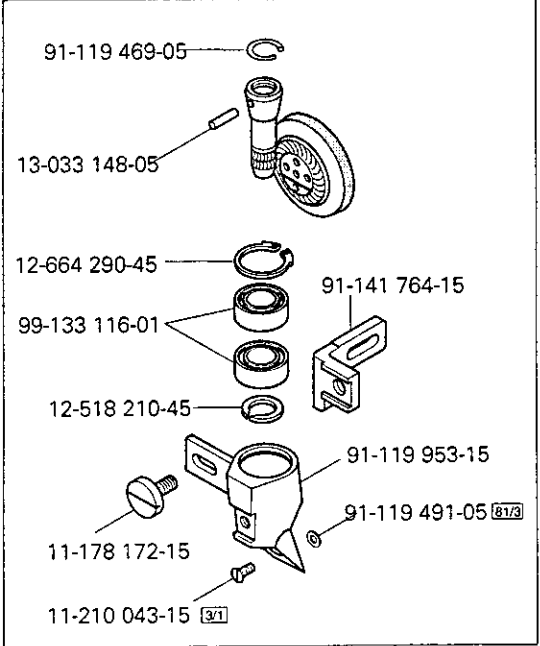
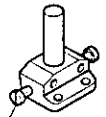
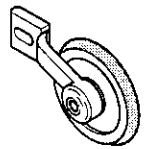
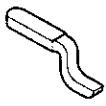
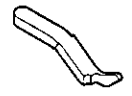
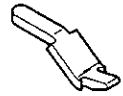
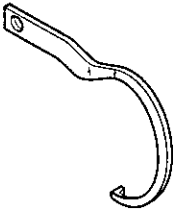
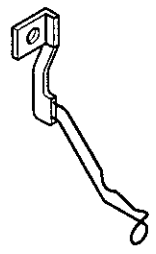
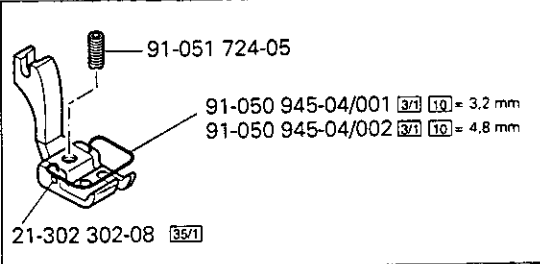
Unterklasse Subclass Sous-classe Subclase	-944/01-900/56	
Arbeitsgang Operation Opération Opéración	Für Stepparbeiten an Schuhschäften und sonstigen Lederwaren mittels angetriebenem Rollfuß. For stitching shoe uppers and other leather articles with driven roller presser. Travaux de piquage sur tiges ou autres articles en cuir, par pied à roulette entraînée. Para trabajos de pespunteado en cortes de calzado y en artículos de cuero mediante pie rodante accionado.	
Ausführung Model Version Tipo de máquina	B	
Nadelabstand in mm Needle gauge in mm Ecartement des aiguilles en mm Distancia entre agujas en mm	1,6; 2,2	
Teilesatz vollst. Part set assy. Jeu de pièces complète Juego de piezas compl.	91-201 719-93/002	$\overline{10}$ = 1,6 mm
	91-201 719-93/001	$\overline{10}$ = 2,2 mm
Nadelhalter $\overline{10/2}$ * Needle holder Pince-aiguille Portaagujas	91-118 195-93/001	
Rollfuß $\overline{4}$ * Roller presser Pied à roulette Pie rodante	91-051 159-93/001	
Drückerfuß $\overline{4}$ $\overline{10/2}$ * Presser foot Pied presseur Pie prensatelas	91-010 880-04/008	$\overline{10}$ = 1,6 mm
	91-010 880-04/011	$\overline{10}$ = 2,2 mm
Fingerschutz * Finger guard Protège-doigts Salvadedos	91-157 813-91	
Stichplatte $\overline{4}$ $\overline{10/1}$ $\overline{10/2}$ * Needle plate Plaque à aiguille Placa de aguja	91-058 874-04/007	$\overline{10}$ = 1,6 mm
	91-058 874-04/013	$\overline{10}$ = 2,2 mm
Stoffschieber $\overline{4}$ $\overline{10/1}$ $\overline{10/2}$ * Feed dog Griffe Transportador inferior	91-047 301-04/010	$\overline{10}$ = 1,6 mm
	91-047 301-04/013	$\overline{10}$ = 2,2 mm
Schieber, links $\overline{10/2}$ Slide, left Glissière, gauche Corredera, izquierda	91-018 889-24/060	
Schieber, rechts $\overline{10/2}$ Slide, right Glissière, droite Corredera, derecha	91-018 888-24/030	
Apparat $\overline{5}$ Attachment Appareil Aparato		
Bandrollenträger Tape reel bracket Plateau dérouleur Portarollos		
Bandführung Tape guide Guide-ruban Guiacintas		

<p>91-118 195-93/001 10 = 1,2 mm; 10 = 1,6 mm; 10 = 2,2 mm</p>  <p>91-700 868-15 (2x) -750/04-4/01 -750/04-4/01-900/56 -944/01 -944/01-900/56</p>	<p>91-119 309-93/001 10 = 2,4 mm</p>  <p>11-317 083-15 (2x) -750/04-4/01 -750/04-4/01-900/56 -944/01</p>	<p>91-141 772-93/001 4 70/1</p>  <p>91-119 469-05 13-033 148-05 12-664 290-45 99-133 116-01 12-518 210-45 11-178 172-15 11-210 043-15 3/1 91-141 764-15 91-119 953-15 91-119 491-05 8/3</p> <p>-750/04-4/01 -750/04-4/01-900/56</p>	
<p>91-710 004-93/003 4 10 = 3,2 mm 91-710 004-93/006 4 10 = 4,8 mm</p>  <p>91-173 664-15 (2x) -70/13</p>	<p>91-051 159-93/001 4</p>  <p>-944/01 -944/01-900/56</p>	<p>-750/04-4/01 -750/04-4/01-900/56</p>	
<p>91-010 805-04/007 4 10 = 1,2 mm</p>  <p>-750/04-4/01</p>	<p>91-010 880-04/008 4 10 = 1,6 mm 91-010 880-04/011 4 10 = 2,2 mm</p>  <p>-750/04-4/01 -750/04-4/01-900/56 -944/01 -944/01-900/56</p>	<p>91-010 882-04/005 4 10 = 2,4 mm</p>  <p>-750/04-4/01 -750/04-4/01-900/56 -944/01-900/56</p>	
<p>91-012 656-04/003 4 10 = 1,2 mm 91-012 656-04/005 4 10 = 1,6 mm</p>  <p>-750/04-4/01</p>	<p>91-012 658-91</p>  <p>-750/04-4/01 -750/04-4/01-900/56</p>	<p>91-155 030-03/001 4 10 = 3,2 mm 91-155 030-03/002 4 10 = 4,8 mm</p>  <p>91-051 724-05 91-050 945-04/001 3/1 10 = 3,2 mm 91-050 945-04/002 3/1 10 = 4,8 mm 21-302 302-08 35/1</p> <p>-70/13</p>	

17.02

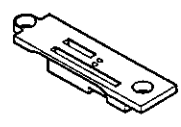
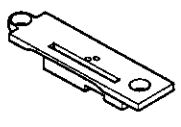
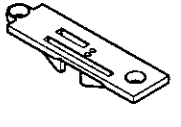
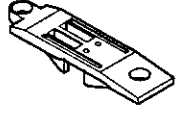
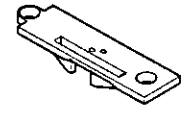
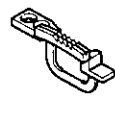
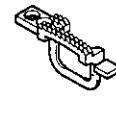
Nähwerkzeuge
 Gauge parts
 Organes de couture
 Organos de costura PFAFF 244

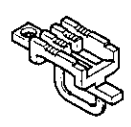
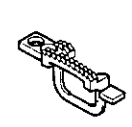
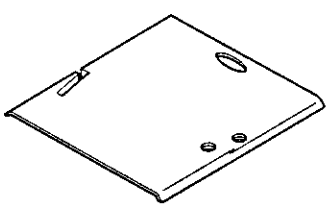
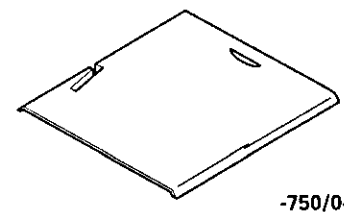
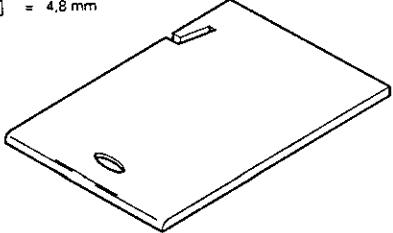
<p>91-058 839-04/002 $\boxed{4} \boxed{10}$ = 2.4 mm</p>  <p>-750/04-4/01-900/56</p>	<p>91-058 874-04/007 $\boxed{4} \boxed{10}$ = 1.6 mm 91-058 874-04/013 $\boxed{4} \boxed{10}$ = 2.2 mm</p>  <p>-750/04-4/01-900/56 -944/01-900/56</p>	<p>91-150 416-04/001 $\boxed{4} \boxed{10}$ = 2.4 mm</p>  <p>-750/04-4/01-944/01</p>	<p>91-158 525-04/001 $\boxed{4} \boxed{10}$ = 3.2 mm 91-158 525-04/006 $\boxed{4} \boxed{10}$ = 4.8 mm</p>  <p>-70/13</p>
<p>91-158 774-04/004 $\boxed{4} \boxed{10}$ = 1.2 mm 91-158 774-04/008 $\boxed{4} \boxed{10}$ = 1.6 mm 91-158 774-04/013 $\boxed{4} \boxed{10}$ = 2.2 mm</p>  <p>-750/04-4/01-944/01</p>	<p>91-026 531-04/011 $\boxed{4} \boxed{10}$ = 1.2 mm 91-026 531-04/013 $\boxed{4} \boxed{10}$ = 1.6 mm 91-026 531-04/016 $\boxed{4} \boxed{10}$ = 2.2 mm</p>  <p>-750/04-4/01-944/01</p>	<p>91-047 300-04/007 $\boxed{4} \boxed{10}$ = 2.4 mm</p>  <p>-750/04-4/01-900/56</p>	<p>91-047 301*04/010 $\boxed{4} \boxed{10}$ = 1.6 mm 91-047 301-04/013 $\boxed{4} \boxed{10}$ = 2.2 mm</p>  <p>-750/04-4/01-900/56 -944/01-900/56</p>
<p>91-059 300-04/001 $\boxed{4} \boxed{10}$ = 3.2 mm 91-059 300-04/006 $\boxed{4} \boxed{10}$ = 4.8 mm</p>  <p>-70/13</p>	<p>91-059 862-04/001 $\boxed{4} \boxed{10}$ = 2.4 mm</p>  <p>-750/04-4/01-944/01</p>	<p>91-010 061-24/060</p> <ul style="list-style-type: none"> $\boxed{10}$ = 1.2 mm $\boxed{10}$ = 1.6 mm $\boxed{10}$ = 2.2 mm $\boxed{10}$ = 2.4 mm $\boxed{10}$ = 3.2 mm $\boxed{10}$ = 4.8 mm  <p>-70/13 -750/04-4/01-944/01</p>	
<p>91-018 888-24/030</p> <ul style="list-style-type: none"> $\boxed{10}$ = 1.6 mm $\boxed{10}$ = 2.2 mm $\boxed{10}$ = 2.4 mm  <p>-750/04-4/01-900/56 -944/01-900/56</p>		<p>91-018 889-24/060</p> <ul style="list-style-type: none"> $\boxed{10}$ = 1.2 mm $\boxed{10}$ = 1.6 mm $\boxed{10}$ = 2.2 mm $\boxed{10}$ = 2.4 mm $\boxed{10}$ = 3.2 mm $\boxed{10}$ = 4.8 mm  <p>-70/13 -750/04-4/01-944/01</p>	

 siehe Kapitel 2 Erläuterung der Schlüsselzeichen
 see chapter 2 Explanation of key markings
 voir le chap. 2 Explication des symboles

PFAFF

91-156 074-73/002 = 3.2 mm
91-156 074-73/005 = 4.8 mm

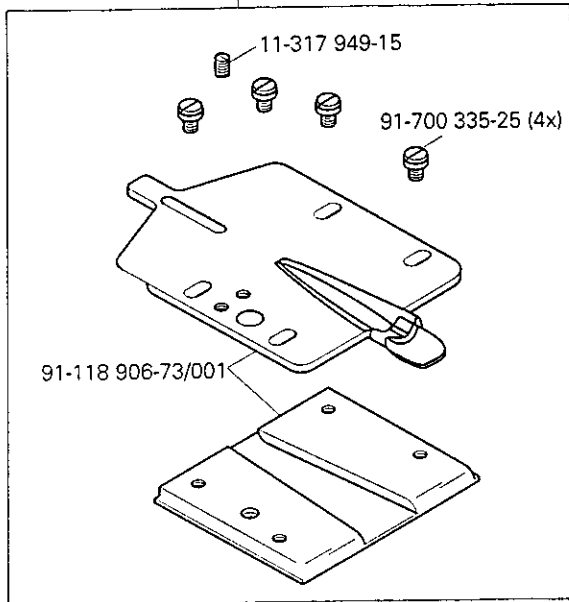

-70/13

91-044 419-25

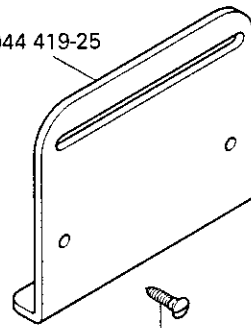

-70/13

11-108 222-15 (2x)

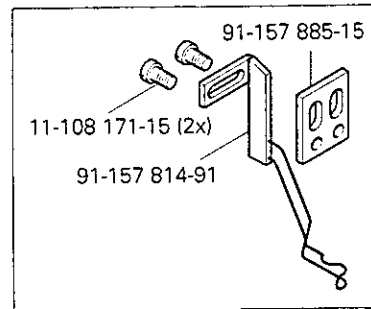

-944/01
-944/01-900/56

91-156 005-71/895

11-130 903-15

91-001 283-15 (2x)

91-156 002-75/895

17-019 025-91

12-335 231-15

91-031 409-12

91-156 003-75/893

91-156 004-05

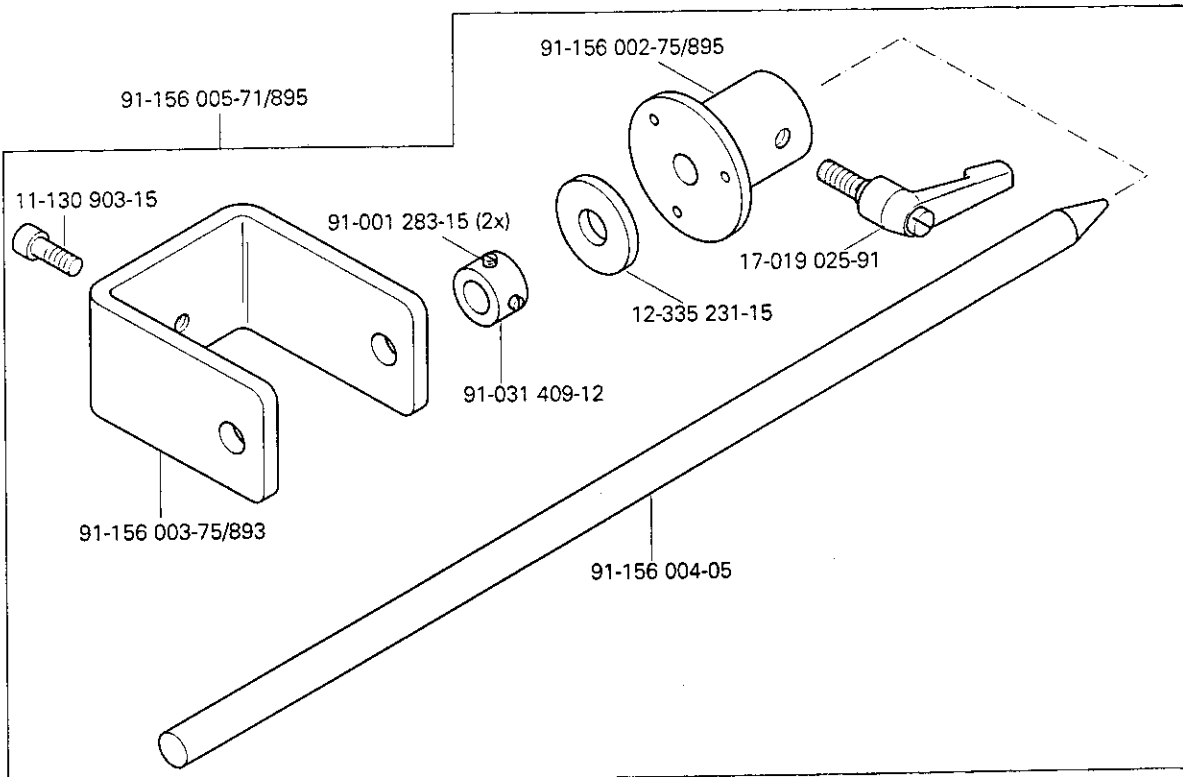

-70/13