

Pfaff 1422 Subclass

PFAFF

1422

Unterklassen-Ausstattung

Subclass parts

Composition des sous-classes

Composición de las subclases

Erläuterungen Explanations

Légende Explicaciones

Die Liste enthält nur Nähwerkzeuge sowie unterklassenabhängige Teile. Beim Umbau in eine andere Unterklasse bzw. Ausführung können auch noch Maschinenteile erforderlich sein. Geben Sie also bei Bestellungen die genaue Bezeichnung der vorhandenen bzw. der gewünschten Ausführung an.

The list contains only gauge parts and subclass-dependent parts. For a conversion into another subclass or version machine parts may be required as well. Please state the exact classification of the existing or required version on your order.

La liste comprend uniquement des organes de couture et des pièces dépendant des sous-classes. En cas de transformation en une autre sous-classe ou une autre version, il se peut que d'autres pièces de machine soient nécessaires. C'est pourquoi nous vous prions d'indiquer, à la commande, la désignation exacte de la version existante ou souhaitée.

La lista contiene solamente órganos de costura y piezas dependientes de la subclase. En el caso de transformación en otra subclase o en otro tipo, es posible que sean necesarias piezas de la máquina. Al hacer los pedidos, indíquese la denominación exacta del tipo existente o del deseado.

- 3/1** Gesichert mit Loctite.
Secured with Loctite.
Bloqué par Loctite.
Asegurado con Loctite.
- 4** Ausführungsart bei Bestellung angeben.
Model to be stated on order.
Préciser le modèle à la commande.
Indíquese el tipo en los pedidos.
- 5** Nähmuster bzw. Material einsenden.
Submit sewing sample or material.
Joindre échantillons de couture ou matières.
Enviense muestras de costura.
- 10** Nadelabstand
Needle gauge
Ecartement des aiguilles
Distancia entre agujas
- 10/1** Je nach Nadelabstand ändert sich die Form (z.B. beim Stoffschieber die Anzahl der Zahnreihen).
Certain design features change according to the needle gauge (e.g. the number of tooth rows on the feed dog).
La forme est fonction de l'écartement des aiguilles (par ex. le nombre des rangées de dents de la griffe).
La forma varia de acuerdo con la distancia entre agujas (p.e. el número de hileras de dientes en el transportador).
- 10/2** Nadelabstand bei Bestellung angeben.
Needle gauge to be stated on order.
Ecartement des aiguilles; à préciser à la commande.
Indíquese en los pedidos la distancia entre agujas.

Erläuterungen
Explanations

Légende
Explicaciones

12 Absteppbreite
Stitching margin
Relarge de couture
Margen de costura

12/2 Absteppbreite bei Bestellung angeben.
Stitching margin to be stated on order.
Indiquer le relarge de couture à la commande.
Indíquese el margen de costura en los pedidos.

41/2 Nadeldiagonalabstand bei Bestellung angeben.
Please state diagonal needle distance on order.
Prière d'indiquer l'espacement diagonal des aiguilles à la commande.
Indíquese en los pedidos la distancia diagonal entre agujas.

Unterklassen-Übersicht
Table of subclasses

Table des sous-classes
Tabla de subclasses

Unterklasse Subclass Sous-classe Subclase	-6/01 (-900/..)	-6/01 (-900/..)	-6/01 (-900/..)
Arbeitsgang Operation Opération Operación	Für allgemeine Näharbeiten. Standardform des Teilesatzes. For ordinary sewing operations. Standard parts set. Travaux d'utilité courante. Jeu de pièces standard. Para trabajos de costura en general. Juego de piezas estándar.	Für allgemeine Näharbeiten. Standardform des Teilesatzes. For ordinary sewing operations. Standard parts set. Travaux d'utilité courante. Jeu de pièces standard. Para trabajos de costura en general. Juego de piezas estándar.	Für allgemeine Näharbeiten. Standardform des Teilesatzes. For ordinary sewing operations. Standard parts set. Travaux d'utilité courante. Jeu de pièces standard. Para trabajos de costura en general. Juego de piezas estándar.
Ausführung Model Version Tipo de máquina	AN 2,5	BN	CN
Nadelabstand in mm Needle gauge in mm Ecartement des aiguilles en mm Distancia entre agujas en mm	0,8 - 40,0	0,8 - 40,0	0,8 - 40,0
Nadelhalter $\frac{10}{2}$ Needle holder Pince-aiguille Portaagujas	91-176 343-93 x 2,4 $\frac{41}{2}$ $\frac{10}{10}$ = 0,8 - 2,2 mm 91-176 068-93 $\frac{10}{10}$ = 2,4 - 4,0 mm 91-172 590-93 $\frac{10}{10}$ = 4,8 - 7,2 mm 91-172 840-93 $\frac{10}{10}$ = 8,0 - 14,0 mm 91-710 004-93 $\frac{10}{10}$ = 16,0 - 34,0 mm 91-710 234-93 $\frac{10}{10}$ = 36,0 - 40,0 mm	91-176 343-93 x 2,4 $\frac{41}{2}$ $\frac{10}{10}$ = 0,8 - 2,2 mm 91-176 068-93 $\frac{10}{10}$ = 2,4 - 4,0 mm 91-172 590-93 $\frac{10}{10}$ = 4,8 - 7,2 mm 91-172 840-93 $\frac{10}{10}$ = 8,0 - 14,0 mm 91-710 004-93 $\frac{10}{10}$ = 16,0 - 34,0 mm 91-710 234-93 $\frac{10}{10}$ = 36,0 - 40,0 mm	91-118 195-93 x 3,2 $\frac{41}{2}$ $\frac{10}{10}$ = 0,8 - 2,8 mm 91-710 004-93 $\frac{10}{10}$ = 3,2 - 34,0 mm 91-710 234-93 $\frac{10}{10}$ = 36,0 - 40,0 mm
Stoffschieber $\frac{4}{10/1}$ $\frac{10/2}$ Feed dog Griffe Transportador inferior	91-059 661-04 x 2,4 $\frac{41}{2}$ $\frac{10}{10}$ = 0,8 - 2,2 mm 91-059 313-04 $\frac{10}{10}$ = 2,4 - 40,0 mm	91-059 661-04 x 2,4 $\frac{41}{2}$ $\frac{10}{10}$ = 0,8 - 2,2 mm 91-059 313-04 $\frac{10}{10}$ = 2,4 - 40,0 mm	91-059 312-04 x 3,2 $\frac{41}{2}$ $\frac{10}{10}$ = 0,8 - 2,8 mm 91-059 313-04 $\frac{10}{10}$ = 3,2 - 40,0 mm
Stichplatte $\frac{4}{10/1}$ $\frac{10/2}$ Needle plate Plaque à aiguille Placa de aguja	91-150 124-05 $\frac{10}{10}$ = 0,8 - 2,2 mm 91-150 126-04 $\frac{10}{10}$ = 2,4 - 40,0 mm	91-150 118-05 $\frac{10}{10}$ = 0,8 - 2,2 mm 91-150 120-04 $\frac{10}{10}$ = 2,4 - 40,0 mm	91-150 119-05 $\frac{10}{10}$ = 0,8 - 2,8 mm 91-150 120-04 $\frac{10}{10}$ = 3,2 - 40,0 mm
Nähfuß $\frac{4}{10/2}$ Presser foot Pied presseur Pie prensateelas	91-054 922-03 $\frac{10}{10}$ = 0,8 - 4,0 mm 91-155 752-03 $\frac{10}{10}$ = 4,8 - 14,0 mm 91-155 753-03 $\frac{10}{10}$ = 15,2 - 40,0 mm	91-054 922-03 $\frac{10}{10}$ = 0,8 - 4,0 mm 91-054 926-03 $\frac{10}{10}$ = 4,8 - 14,0 mm 91-054 927-03 $\frac{10}{10}$ = 15,2 - 40,0 mm	91-054 922-03 $\frac{10}{10}$ = 0,8 - 4,0 mm 91-054 926-03 $\frac{10}{10}$ = 4,8 - 14,0 mm 91-054 927-03 $\frac{10}{10}$ = 15,2 - 40,0 mm





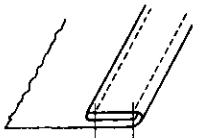
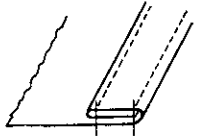





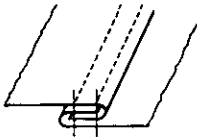
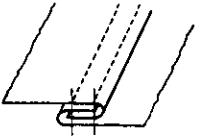
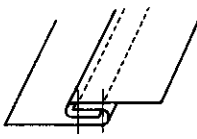
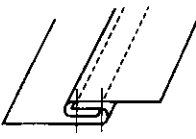





Unterklassen-Übersicht
Table of subclasses

Table des sous-classes
Tabla de subclasses

Unterklasse Subclass Sous-classe Subclase	-6/03 (-900/..)	-6/03 (-900/..)	-19/01 (-900/..)	-19/01 (-900/..)
Arbeitsgang Operation Opération Operación	Wie -6/01, jedoch mit Ausgleichfuß. Same as -6/01, but with compensating presser foot. Comme la -6/01, mais avec pied compensateur. Como la -6/01, pero con pie compensador.	Wie -6/01, jedoch mit Ausgleichfuß. Same as -6/01, but with compensating presser foot. Comme la -6/01, mais avec pied compensateur. Como la -6/01, pero con pie compensador.		
Ausführung Model Version Tipo de máquina	BN	CN	BN	CN
Nadelabstand in mm Needle gauge in mm Ecartement des aiguilles en mm Distancia entre agujas en mm	4,0 - 40,0	4,0 - 40,0	4,8 - 12,0	4,8 - 12,0
Nadelhalter $\frac{10}{2}$ Needle holder Pince-aiguille Portaagujas	91-176 068-93 $\frac{10}{1}$ = 4,0 mm 91-172 590-93 $\frac{10}{1}$ = 4,8 - 7,2 mm 91-172 840-93 $\frac{10}{1}$ = 8,0 - 14,0 mm 91-710 004-93 $\frac{10}{1}$ = 16,0 - 34,0 mm 91-710 234-93 $\frac{10}{1}$ = 36,0 - 40,0 mm	91-710 004-93 $\frac{10}{1}$ = 4,0 - 34,0 mm 91-710 234-93 $\frac{10}{1}$ = 36,0 - 40,0 mm	91-172 590-93 $\frac{10}{1}$ = 4,8 - 7,2 mm 91-172 840-93 $\frac{10}{1}$ = 8,0 - 12,0 mm	91-710 004-93
Stoffschieber $\frac{4}{10/1}$ Feed dog Griffe Transportador inferior	$\frac{10}{2}$ 91-059 313-04	91-059 313-04	91-059 313-04	91-059 313-04
Stichplatte $\frac{4}{10/1}$ Needle plate Plaque à aiguille Placa de aguja	$\frac{10}{2}$ 91-150 120-04	91-150 120-04	91-150 120-04	91-150 120-04
Nähfuß $\frac{4}{10/2}$ Presser foot Pied presseur Pie prensatelas	91-055 499-93 $\frac{10}{1}$ = 4,0 - 11,2 mm 91-055 506-93 $\frac{10}{1}$ = 12,0 - 22,0 mm 91-055 507-93 $\frac{10}{1}$ = 24,0 - 40,0 mm	91-055 499-93 $\frac{10}{1}$ = 4,0 - 11,2 mm 91-055 506-93 $\frac{10}{1}$ = 12,0 - 22,0 mm 91-055 507-93 $\frac{10}{1}$ = 24,0 - 40,0 mm	91-055 609-03	91-055 609-03
Apparat $\frac{5}{10/2}$ Attachment Appareil Aparato			91-041 006-23	91-041 006-23
Träger Bracket Support Soporte			91-753 936-90	91-753 936-90

Unterklassen-Übersicht
Table of subclasses

Table des sous-classes
Tabla de subclasses

Unterklasse Subclass Sous-classe Subclase	-57/01 (-900/..)	-57/01 (-900/..)	-58/01 (-900/..)	-58/01 (900/..)
Arbeitsgang Operation Opération Operación				
Ausführung Model Version Tipo de máquina	BN	CN	BN	CN
Nadelabstand in mm Needle gauge in mm Ecartement des aiguilles en mm Distancia entre agujas en mm	4,8 - 10,0	4,8 - 10,0	4,8 - 10,0	4,8 - 10,0
Nadelhalter  Needle holder Pince-aiguille Portaagujas	91-172 590-93  = 4,8 - 7,2 mm 91-172 840-93  = 8,0 - 10,0 mm	91-710 004-93	91-172 590-93  = 4,8 - 7,2 mm 91-172 840-93  = 8,0 - 10,0 mm	91-710 004-93
Stoffschieber   Feed dog  Griffe Transportador inferior	91-059 313-04	91-059 313-04	91-059 313-04	91-059 313-04
Stichplatte   Needle plate  Plaque à aiguille Placa de aguja	91-150 120-04	91-150 120-04	91-150 120-04	91-150 120-04
Nähfuß   Presser foot Pied presseur Pie prensatelas	91-054 926-03	91-054 926-03	91-054 926-03	91-054 926-03
Apparat   Attachment Appareil Aparato	91-040 317-93	91-040 317-93	91-040 316-93	91-040 316-93

Unterklassen-Übersicht
Table of subclasses

Table des sous-classes
Tabla de subclasses

Unterklasse Subclass Sous-classe Subclass	-61/01 (-900/..)	-61/01 (-900/..)	-113/02 (-900/..)	-113/02 (-900/..)
Arbeitsgang Operation Opération Operación				
Ausführung Model Version Tipo de máquina	BN	CN	BN	CN
Nadelabstand in mm Needle gauge in mm Ecartement des aiguilles en mm Distancia entre agujas en mm	2,4 - 20,0	2,4 - 20,0	2,4 - 13,2	2,4 - 13,2
Nadelhalter $\overline{10/2}$ Needle holder Pince-aiguille Portaagujas	91-176 068-93 $\overline{10}$ = 2,4 - 4,0 mm 91-172 590-93 $\overline{10}$ = 4,8 - 7,2 mm 91-172 840-93 $\overline{10}$ = 8,0 - 14,0 mm 91-710 004-93 $\overline{10}$ = 16,0 - 20,0 mm	91-710 004-93	91-176 068-93 $\overline{10}$ = 2,4 - 4,0 mm 91-172 590-93 $\overline{10}$ = 4,8 - 7,2 mm 91-172 840-93 $\overline{10}$ = 8,0 - 13,2 mm	91-710 004-93
Stoffschieber $\overline{4}$ $\overline{10/1}$ Feed dog $\overline{10/2}$ Griffe Transportador inferior	91-059 313-04	91-059 313-04	91-059 785-04	91-059 785-04
Stichplatte $\overline{4}$ $\overline{10/1}$ $\overline{10/2}$ Needle plate $\overline{12/2}$ Plaque à aiguille Placa de aguja	91-150 120-04	91-150 120-04	91-150 219-04 $\overline{12}$ = 1,5 - 3,5 mm	91-150 219-04 $\overline{12}$ = 1,5 - 3,5 mm
Nähfuß $\overline{4}$ $\overline{10/2}$ $\overline{12/2}$ Presser foot Pied presseur Pie prensateelas	91-157 658-03 $\overline{5}$ $\overline{10}$ = 2,4 - 14,0 mm 91-157 730-03 $\overline{5}$ $\overline{10}$ = 15,2 - 20,0 mm	91-157 658-03 $\overline{5}$ $\overline{10}$ = 2,4 - 14,0 mm 91-157 730-03 $\overline{5}$ $\overline{10}$ = 15,2 - 20,0 mm	91-154 003-03 $\overline{10}$ = 2,4 - 2,8 mm $\overline{12}$ = 1,5 mm; 2,0 mm $\overline{10}$ = 3,2 - 13,2 mm $\overline{12}$ = 1,5 mm 91-154 005-03 $\overline{10}$ = 3,2 - 13,2 mm $\overline{12}$ = 2,0 - 3,5 mm	91-154 003-03 $\overline{10}$ = 2,4 - 2,8 mm $\overline{12}$ = 1,5 mm; 2,0 mm $\overline{10}$ = 3,2 - 13,2 mm $\overline{12}$ = 1,5 mm 91-154 005-03 $\overline{10}$ = 3,2 - 13,2 mm $\overline{12}$ = 2,0 - 3,5 mm
Bandtrommel Tape reel Tambour-dérouleur Tambor portacintas	91-040 207-70/995	91-040 207-70/995		

Unterklassen-Übersicht
Table of subclasses

Table des sous-classes
Tabla de subclasses

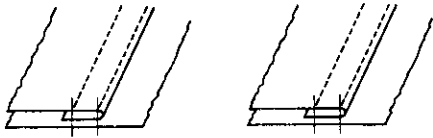
Unterklasse Subclass Sous-classe Subclase	-748/26-6/01 (-900/..)	-748/26-6/01 (-900/..)	-748/26-113/02 (-900/..)	-748/26-113/02 (-900/..)
Arbeitsgang Operation Opération Operación	<p>Für allgemeine Näharbeiten mittels Standardteilsatz. Die Maschine ist mit Walzentransport-Einrichtung ausgestattet. For general sewing operations with standard part set. The machine is equipped with puller feed. Pour les coutures d'utilité courante par jeu de pièces standard. La machine est équipée d'un puller. Para trabajos de costura en general mediante juego de piezas estándar. La máquina va equipada con un puller.</p>		<p>Für allgemeine Näharbeiten mittels Standardteilsatz. Die Maschine ist mit Walzentransport-Einrichtung ausgestattet. For general sewing operations with standard part set. The machine is equipped with puller feed. Pour les coutures d'utilité courante par jeu de pièces standard. La machine est équipée d'un puller. Para trabajos de costura en general mediante juego de piezas estándar. La máquina va equipada con un puller.</p>	
				
Ausführung Model Version Tipo de máquina	BN	CN	BN	CN
Nadelabstand in mm Needle gauge in mm Ecartement des aiguilles en mm Distancia entre agujas en mm	4,0 - 14,0	4,0 - 14,0	2,4 - 13,2	2,4 - 13,2
Nadelhalter $\frac{10}{2}$ Needle holder Pince-aiguille Portaagujas	91-176 068-93 $\frac{10}{1}$ = 4,0 mm 91-172 590-93 $\frac{10}{1}$ = 4,8 - 7,2 mm 91-172 840-93 $\frac{10}{1}$ = 8,0 - 14,0 mm	91-710 004-93	91-176 068-93 $\frac{10}{1}$ = 2,4 - 4,0 mm 91-172 590-93 $\frac{10}{1}$ = 4,8 - 7,2 mm 91-172 840-93 $\frac{10}{1}$ = 8,0 - 13,2 mm	91-710 004-93
Stoffschieber $\frac{4}{1}$ $\frac{10}{1}$ Feed dog $\frac{10}{2}$ Griffe Transportador inferior	91-059 313-04	91-059 313-04	91-059 785-04	91-059 785-04
Stichplatte $\frac{4}{1}$ $\frac{10}{1}$ $\frac{10}{2}$ Needle plate $\frac{12}{2}$ Plaque à aiguille Placa de aguja	91-150 120-04	91-150 120-04	91-150 219-04 $\frac{12}{2}$ = 1,5 - 3,5 mm	91-150 219-04 $\frac{12}{2}$ = 1,5 - 3,5 mm
Nähfuß $\frac{4}{1}$ $\frac{10}{2}$ $\frac{12}{2}$ Presser foot Pied presseur Pie prensatelas	91-460 804-03	91-460 804-03	91-154 387-03 $\frac{10}{1}$ = 2,4 - 2,8 mm $\frac{12}{2}$ = 1,5 mm; 2,0 mm $\frac{10}{1}$ = 3,2 - 13,2 mm $\frac{12}{2}$ = 1,5 mm 91-154 389-03 $\frac{10}{1}$ = 3,2 - 13,2 mm $\frac{12}{2}$ = 2,0 - 3,5 mm	91-154 387-03 $\frac{10}{1}$ = 2,4 - 2,8 mm $\frac{12}{2}$ = 1,5 mm; 2,0 mm $\frac{10}{1}$ = 3,2 - 13,2 mm $\frac{12}{2}$ = 1,5 mm 91-154 389-03 $\frac{10}{1}$ = 3,2 - 13,2 mm $\frac{12}{2}$ = 2,0 - 3,5 mm

Nähwerkzeuge
Gauge parts

Organes de couture
Organos de costura

91-118 195-93 x 3,2 $\frac{10}{2}$ $\frac{41}{2}$
 $\frac{10}{2}$ = 0,8 - 2,8 mm

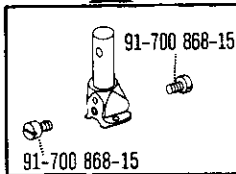

-6/01 (-900/..)

91-172 590-93 $\frac{10}{2}$
 $\frac{10}{2}$ = 4,8 - 7,2 mm

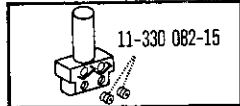

-6/01 (-900/..)
-6/03 (-900/..)
-19/01 (-900/..)
-57/01 (-900/..)
-58/01 (-900/..)
-61/01 (-900/..)
-113/02 (-900/..)
-748/26-6/01 (-900/..)
-748/26-113/02 (-900/..)

91-172 840-93 $\frac{10}{2}$
 $\frac{10}{2}$ = 8,0 - 14,0 mm

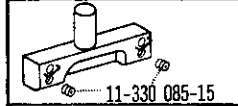

-6/01 (-900/..)
-6/03 (-900/..)
-19/01 (-900/..)
-57/01 (-900/..)
-58/01 (-900/..)
-61/01 (-900/..)
-113/02 (-900/..)
-748/26-6/01 (-900/..)
-748/26-113/02 (-900/..)

91-176 068-93 $\frac{10}{2}$
 $\frac{10}{2}$ = 2,4 - 4,0 mm

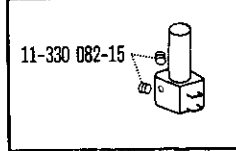

-6/01 (-900/..)
-6/03 (-900/..)
-61/01 (-900/..)
-113/02 (-900/..)
-748/26-6/01 (-900/..)
-748/26-113/02 (-900/..)

91-176 343-93 x 2,4 $\frac{10}{2}$ $\frac{41}{2}$
 $\frac{10}{2}$ = 0,8 - 2,2 mm

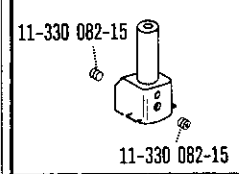

-6/01 (-900/..)

91-710 004-93 $\frac{10}{2}$
 $\frac{10}{2}$ = 2,4 - 34,0 mm

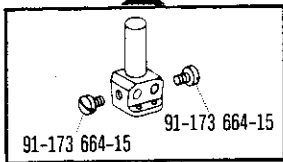

-6/01 (-900/..)
-6/03 (-900/..)
-19/01 (-900/..)
-57/01 (-900/..)
-58/01 (-900/..)
-61/01 (-900/..)
-113/02 (-900/..)
-748/26-6/01 (-900/..)
-748/26-113/02 (-900/..)

91-710 234-93 $\frac{10}{2}$
 $\frac{10}{2}$ = 36,0 - 40,0 mm

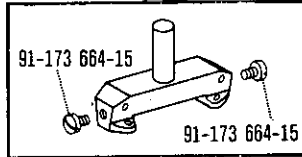

-6/01 (-900/..)
-6/03 (-900/..)

91-059 312-04 x 3,2 $\frac{4}{1}$ $\frac{10}{2}$ $\frac{41}{2}$
 $\frac{10}{2}$ = 0,8 - 2,8 mm

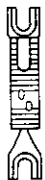

-6/01 (-900/..)

91-059 313-04 $\frac{4}{1}$ $\frac{10}{2}$
 $\frac{10}{2}$ = 2,4 - 4,0 mm

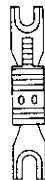

-6/01 (-900/..)
-6/03 (-900/..)
-61/01 (-900/..)
-748/26-6/01 (-900/..)

91-059 313-04 $\frac{4}{1}$ $\frac{10}{2}$ $\frac{10}{2}$
 $\frac{10}{2}$ = 4,8 - 40,0 mm



-6/01 (-900/..)
-6/03 (-900/..)
-19/01 (-900/..)
-57/01 (-900/..)
-58/01 (-900/..)
-61/01 (-900/..)
-748/26-6/01 (-900/..)

91-059 661-04 x 2,4 $\frac{4}{1}$ $\frac{10}{2}$ $\frac{41}{2}$
 $\frac{10}{2}$ = 0,8 - 2,2 mm



-6/01 (-900/..)

91-059 785-04 $\frac{4}{1}$ $\frac{10}{2}$
 $\frac{10}{2}$ = 2,4 - 4,0 mm



-113/02 (-900/..)
-748/26-113/02 (-900/..)



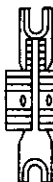



91-059 785-04 $\frac{4}{1}$ $\frac{10}{2}$ $\frac{10}{2}$
 $\frac{10}{2}$ = 4,8 - 13,2 mm

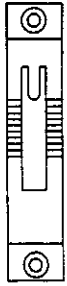
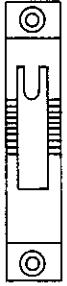

-113/02 (-900/..)
-748/26-113/02 (-900/..)

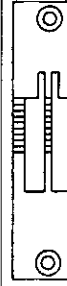
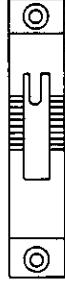
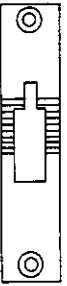
Nähwerkzeuge
Gauge parts

Organes de couture
Organos de costura

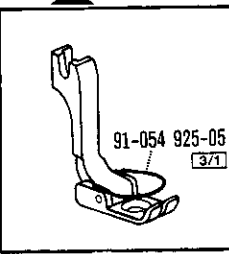
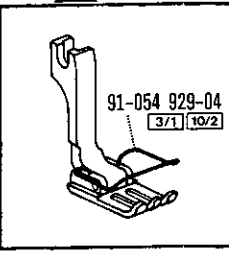
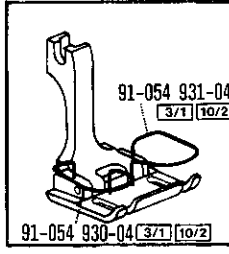
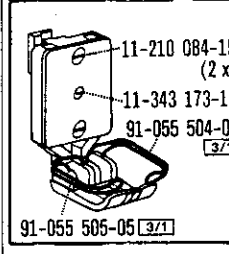
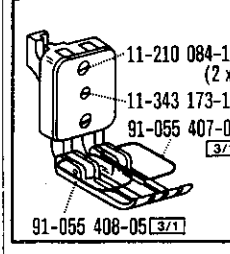
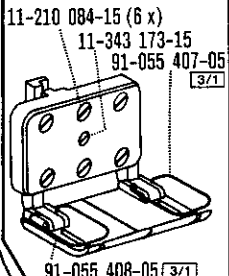
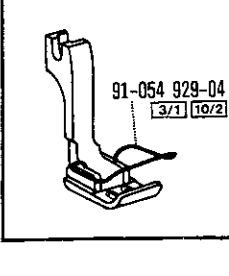
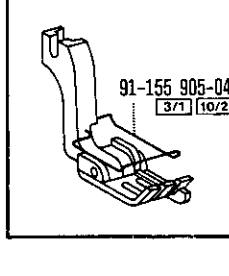
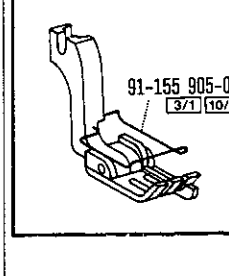
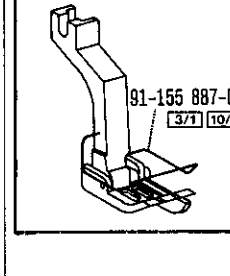
<p>91-150 118-05 [4] [10/2] [10] = 0,8 - 2,2 mm</p>  <p>-6/01 (-900/..)</p>	<p>91-150 119-05 [4] [10/2] [10] = 0,8 - 2,8 mm</p>  <p>-6/01 (-900/..)</p>	<p>91-150 120-04 [4] [10/2] [10] = 2,4 - 4,0 mm</p>  <p>-6/01 (-900/..) -6/03 (-900/..) -61/01 (-900/..) -748/26-6/01 (-900/..)</p>	<p>91-150 120-04 [4] [10/1] [10/2] [10] = 4,8 - 40,0 mm</p>  <p>-6/01 (-900/..) -6/03 (-900/..) -19/01 (-900/..) -57/01 (-900/..) -58/01 (-900/..) -61/01 (-900/..) -748/26-6/01 (-900/..)</p>	<p>91-150 124-05 [4] [10/2] [10] = 0,8 - 2,2 mm</p>  <p>-6/01 (-900/..)</p>
<p>91-150 126-04 [4] [10/2] [10] = 2,4 - 4,0 mm</p>  <p>-6/01 (-900/..)</p>	<p>91-150 126-04 [4] [10/1] [10/2] [10] = 4,8 - 40,0 mm</p>  <p>-6/01 (-900/..)</p>	<p>91-150 219-04 [4] [10/2] [12/2] [10] = 2,4 - 4,0 mm [12] = 1,5 - 3,5 mm</p>  <p>-113/02 (-900/..) -748/26-113/02 (-900/..)</p>	<p>91-150 219-04 [4] [10/1] [10/2] [12/2] [10] = 4,8 - 13,2 mm [12] = 1,5 - 3,5 mm</p>  <p>-113/02 (-900/..) -748/26-113/02 (-900/..)</p>	
<p>91-054 922-03 [4] [10/2]</p>  <p>91-054 925-05 [3/1]</p> <p>-6/01 (-900/..)</p>	<p>91-054 926-03 [4] [10/2]</p>  <p>91-054 929-04 [3/1] [10/2]</p> <p>-6/01 (-900/..) -57/01 (-900/..) -58/01 (-900/..)</p>	<p>91-054 927-03 [4] [10/2]</p>  <p>91-054 931-04 [3/1] [10/2]</p> <p>91-054 930-04 [3/1] [10/2]</p> <p>-6/01 (-900/..)</p>	<p>91-055 499-93 [4] [10/2]</p>  <p>11-210 084-15 (2 x) 11-343 173-15 91-055 504-05 [3/1]</p> <p>91-055 505-05 [3/1]</p> <p>-6/03 (-900/..)</p>	<p>91-055 506-93 [4] [10/2]</p>  <p>11-210 084-15 (2 x) 11-343 173-15 91-055 407-05 [3/1]</p> <p>91-055 408-05 [3/1]</p> <p>-6/03 (-900/..)</p>
<p>91-055 507-93 [4] [10/2]</p>  <p>11-210 084-15 (6 x) 11-343 173-15 91-055 407-05 [3/1]</p> <p>91-055 408-05 [3/1]</p> <p>-6/03 (-900/..)</p>	<p>91-055 609-03 [4] [10/2]</p>  <p>91-054 929-04 [3/1] [10/2]</p> <p>-19/01 (-900/..)</p>	<p>91-154 003-03 [4] [10/2] [12/2]</p>  <p>91-155 905-04 [3/1] [10/2]</p> <p>-113/02 (-900/..)</p>	<p>91-154 005-03 [4] [10/2] [12/2]</p>  <p>91-155 905-04 [3/1] [10/2]</p> <p>-113/02 (-900/..)</p>	<p>91-154 387-03 [4] [10/2] [12/2]</p>  <p>91-155 887-04 [3/1] [10/2]</p> <p>-748/26-113/02 (-900/..)</p>

Nähwerkzeuge
Gauge parts

Organes de couture
Organos de costura

91-154 389-03 [4] [10/2] [12/2]

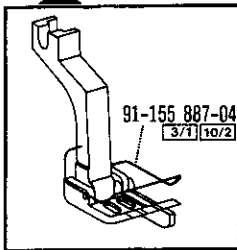

-748/26-113/02 (-900/..)

91-155 752-03 [4] [10/2]

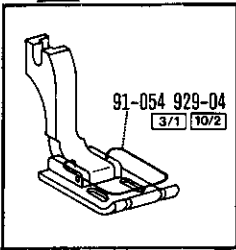

-6/01 (-900/..)

91-155 753-03 [4] [10/2]

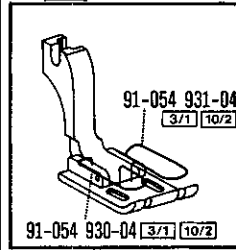

-6/01 (-900/..)

91-157 658-03 [4] [5] [10/2]

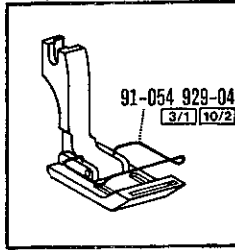

-6/01 (-900/..)

91-157 730-03 [4] [5] [10/2]

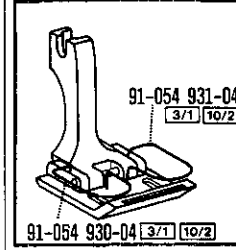

-6/01 (-900/..)

91-460 804-03 [4] [10/2]

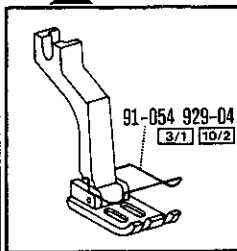

-748/26-6/01 (-900/..)

91-100 355-15

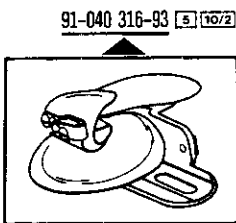

-58/01 (-900/..)

91-100 355-15

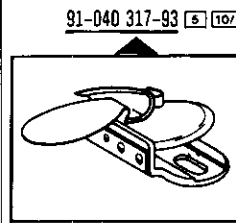

-57/01 (-900/..)

91-041 006-23 [5] [10/2]

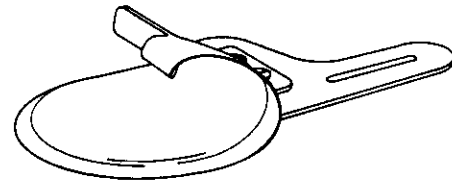

-19/01 (-900/..)

91-753 936-90

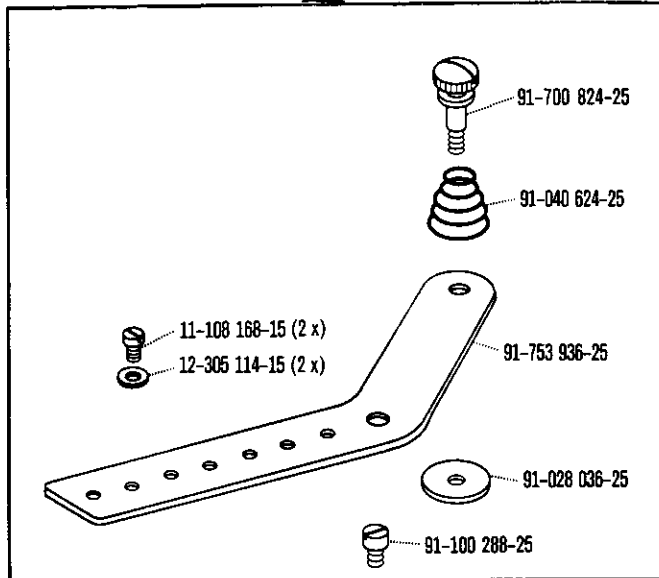

-19/01 (-900/..)

91-040 207-70/995

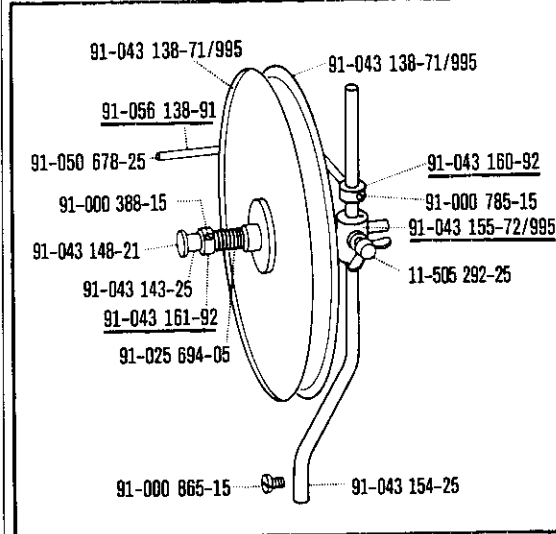

-61/01 (-900/..)