

Pfaff 1242
Subclass
Subsequent Jan. 1990

PFAFF

1242

Unterklassen-Ausstattung

Subclass parts

Composition des sous-classes

Composición de las subclases

Erläuterungen Explanations

Légende Explicaciones

Die Liste enthält nur Nähwerkzeuge sowie unterklassenabhängige Teile. Beim Umbau in eine andere Unterklasse bzw. Ausführung können auch noch Maschinenteile erforderlich sein. Geben Sie also bei Bestellungen die genaue Bezeichnung der vorhandenen bzw. der gewünschten Ausführung an.

The list contains only gauge parts and subclass-dependent parts. For a conversion into another subclass or version machine parts may be required as well. Please state the exact classification of the existing or required version on your order.

La liste comprend uniquement des organes de couture et des pièces dépendant des sous-classes. En cas de transformation en une autre sous-classe ou une autre version, il se peut que d'autres pièces de machine soient nécessaires. C'est pourquoi nous vous prions d'indiquer, à la commande, la désignation exacte de la version existante ou souhaitée.

La lista contiene solamente órganos de costura y piezas dependientes de la subclase. En el caso de transformación en otra subclase o en otro tipo, es posible que sean necesarias piezas de la máquina. Al hacer los pedidos, indíquese la denominación exacta del tipo existente o del deseado.

3/1 Gesichert mit Loctite.
Secured with Loctite.
Bloqué par Loctite.
Asegurado con Loctite.

4 Ausführungsart bei Bestellung angeben.
Model to be stated on order.
Préciser le modèle à la commande.
Indíquese el tipo en los pedidos.

5 Nähmuster bzw. Material einsenden.
Submit sewing sample or material.
Joindre échantillons de couture ou matières.
Enviense muestras de costura.

10 Nadelabstand
Needle gauge
Ecartement des aiguilles
Distancia entre agujas

10/1 Je nach Nadelabstand ändert sich die Form (z.B. beim Stoffschieber die Anzahl der Zahnreihen).
Certain design features change according to the needle gauge (e.g. the number of tooth rows on the feed dog).
La forme est fonction de l'écartement des aiguilles (par ex. le nombre des rangées de dents de la griffe).
La forma varía de acuerdo con la distancia entre agujas (p.e. el número de hileras de dientes en el transportador).

10/2 Nadelabstand bei Bestellung angeben.
Needle gauge to be stated on order.
Ecartement des aiguilles; à préciser à la commande.
Indíquese en los pedidos la distancia entre agujas.

Erläuterungen
Explanations

Légende
Explicaciones

- Mit -900/.. lieferbar.
Can be supplied with -900/..
Livvable avec -900/..
Se puede suministrar con -900/..

- ▲ Stichplatte bei -900/...: 91-058 872-93.
Needle plate for -900/...: 91-058 872-93.
Plaque à aiguille pour -900/...: 91-058 872-93.
Placa de aguja para -900/...: 91-058 872-93.

- Zum gleichzeitigen Befestigen von 2 Apparaten kann auf Wunsch der Träger
Nr. 91-053 908-91 geliefert werden.
To fit two brackets simultaneously, bracket No. 91-053 908-91 can be supplied on request.
Pour pouvoir monter simultanément deux appareils, on peut sur demande recevoir le
support n° 91-053 908-91.
Para poder montar simultáneamente dos aparatos, se suministra, sobre demanda, el
soporte N° 91-053 908-91.

Unterklassen-Übersicht
Table of subclasses

Table des sous-classes
Tabla de subclasses

Unterklasse Subclass Sous-classe Subclass	-6/01	-6/01-900/..	-6/01	-6/01-900/..
Arbeitsgang Operation Opération Opèracion	Für allgemeine Näharbeiten. Standardform des Teilesatzes. For ordinary sewing operations. Standard part set. Travaux d'utilité courante. Jeu de pièces standard. Para trabajos de costura en general. Juego de piezas estándar.	Für allgemeine Näharbeiten. Standardform des Teilesatzes. For ordinary sewing operations. Standard part set. Travaux d'utilité courante. Jeu de pièces standard. Para trabajos de costura en general. Juego de piezas estándar.	Für allgemeine Näharbeiten. Standardform des Teilesatzes. For ordinary sewing operations. Standard part set. Travaux d'utilité courante. Jeu de pièces standard. Para trabajos de costura en general. Juego de piezas estándar.	Für allgemeine Näharbeiten. Standardform des Teilesatzes. For ordinary sewing operations. Standard part set. Travaux d'utilité courante. Jeu de pièces standard. Para trabajos de costura en general. Juego de piezas estándar.
Ausführung Model Version Tipo de máquina	BN	BN	CN	CN
Nadelabstand in mm Needle gauge in mm Ecartement des aiguilles en mm Distancia entre agujas en mm	3,2 - 72,0	3,2 - 32,0	3,2 - 72,0	3,2 - 32,0
Nadelhalter $\frac{10}{2}$ Needle holder Pince-aiguille Portaagujas	91-710 004-93 $\frac{10}{1}$ = 3,2 - 34,0 mm 91-710 234-93 $\frac{10}{1}$ = 36,0 - 72,0 mm	91-710 004-93	91-710 004-93 $\frac{10}{1}$ = 3,2 - 34,0 mm 91-710 234-93 $\frac{10}{1}$ = 36,0 - 72,0 mm	91-710 004-93
Stoffschieber $\frac{4}{10/1}$ Feed dog $\frac{10/2}$ Griffe Transportador inferior	91-046 714-04 $\frac{10}{1}$ = 3,2 mm; 6,0 - 36,0 mm 91-046 734-04 $\frac{10}{1}$ = 4,0 - 5,6 mm 91-047 261-93 $\frac{10}{1}$ = 38,0 - 72,0 mm	91-046 714-04 $\frac{10}{1}$ = 3,2 mm; 6,0 - 32,0 mm 91-046 734-04 $\frac{10}{1}$ = 4,0 - 5,6 mm	91-046 714-04 $\frac{10}{1}$ = 3,2 - 36,0 mm 91-047 261-93 $\frac{10}{1}$ = 38,0 - 72,0 mm	91-047 151-04
Stichplatte $\frac{4}{10/1}$ Needle plate $\frac{10/2}$ Plaque à aiguille Placa de aguja	91-046 715-04 $\frac{10}{1}$ = 3,2 mm; 6,0 - 72,0 mm 91-046 735-04 $\frac{10}{1}$ = 4,0 - 5,6 mm	91-058 871-04	91-046 715-04	91-058 867-04
Nähfuß $\frac{4}{10/2}$ Presser foot Pied presseur Pie prensatelas	91-040 811-03	91-040 811-03	91-040 811-03	91-040 811-03





Unterklassen-Übersicht
Table of subclasses

Table des sous-classes
Tabla de subclasses

Unterklasse Subclass Sous-classe Subclase	-61/02	-61/02-900/..	-61/09	-61/09-900/..
Arbeitsgang Operation Opération Operación				
Ausführung Model Version Tipo de máquina	CN	CN	CN	CN
Nadelabstand in mm Needle gauge in mm Ecartement des aiguilles en mm Distancia entre agujas en mm	4,8 - 72,0	4,8 - 32,0	4,8 - 24,0	4,8 - 24,0
Nadelhalter ^{10/2} Needle holder Pince-aiguille Portaagujas	91-710 004-93 ¹⁰ = 4,8 - 34,0 mm 91-710 234-93 ¹⁰ = 36,0 - 72,0 mm	91-710 004-93	91-710 004-93	91-710 004-93
Stoffschieber ⁴ ^{10/1} Feed dog Griffe Transportador inferior	91-046 714-04 ¹⁰ = 4,8 - 36,0 mm 91-047 261-93 ¹⁰ = 38,0 - 72,0 mm	91-047 151-04	91-046 714-04	91-047 151-04
Stichplatte ⁴ ^{10/1} Needle plate Plaque à aiguille Placa de aguja	91-046 715-04	91-058 867-04	91-046 715-04	91-058 867-04
Nähfuß ⁴ ^{10/2} Presser foot Pied presseur Pie prensateijas	91-040 811-03	91-040 811-03	91-040 584-03 ⁵	91-040 584-03 ⁵
Träger Bracket Support Soporte	91-040 862-90	91-040 862-90		
Kopfplatte Face plate Plaque frontale Placa frontal	91-140 383-71/993	91-140 383-71/993		
Bandtrommel Tape reel Tambour-dérouleur Tambor portacintas	91-040 207-70/995	91-040 207-70/995		
Bandführung ⁵ ^{10/2} Tape guide Guide-ruban Guiacintas	91-043 408-23	91-043 408-23		
Fingerschutz ^{10/2} Finger guard Protège-digts Salvadedos			91-046 864-25 ¹⁰ = 4,8 - 6,8 mm 91-046 866-25 ¹⁰ = 7,2 - 12,2 mm 91-046 868-25 ¹⁰ = 13,2 - 20,0 mm 91-046 870-24 ¹⁰ = 22,0 - 24,0 mm	91-046 864-25 ¹⁰ = 4,8 - 6,8 mm 91-046 866-25 ¹⁰ = 7,2 - 12,2 mm 91-046 868-25 ¹⁰ = 13,2 - 20,0 mm 91-046 870-24 ¹⁰ = 22,0 - 24,0 mm

Unterklassen-Übersicht
Table of subclasses

Table des sous-classes
Tabla de subclasses

Unterklasse Subclass Sous-classe Subclase	-720/02-6/01	-720/02-6/01-900/..	-720/02-6/01	-720/02-6/01-900/..	-720/02-6/01
Arbeitsgang Operation Opération Operación					
Ausführung Model Version Tipo de máquina	BN	BN	B/CN	B/CN	BN 8 B/CN 8
Nadelabstand in mm Needle gauge in mm Ecartement des aiguilles en mm Distancia entre agujas en mm	3,2 - 30,0	3,2 - 8,0	3,2 - 30,0	3,2 - 8,0	3,2 - 20,0
Nadelhalter ^{10/2} Needle holder Pince-aiguille Portaagujas	91-019 930-13	91-019 930-13	91-019 930-13	91-019 930-13	91-019 930-13
Stoffschieber ⁴ ^{10/1} Feed dog ^{10/2} Griffe Transportador inferior	91-046 714-04 ¹⁰ = 3,2 mm; 6,0 - 30,0 mm	91-046 714-04 ¹⁰ = 3,2 mm; 6,0 - 8,0 mm	91-046 714-04	91-047 151-04	91-047 859-04
Stichplatte ⁴ ^{10/1} Needle plate ^{10/2} Plaque à aiguille Placa de aguja	91-046 715-04 ¹⁰ = 3,2 mm; 6,0 - 30,0 mm	91-058 871-04	91-046 715-04	91-058 867-04	91-058 535-04
Nähfuß ⁴ ^{10/2} Presser foot Pied presseur Pie prensateelas	91-040 811-03	91-040 811-03	91-040 811-03	91-040 811-03	91-055 915-03
Zwischenstück Extension piece Pièce intermédiaire Pieza intermedia					91-055 918-91

Unterklassen-Übersicht
Table of subclasses

Table des sous-classes
Tabla de subclasses

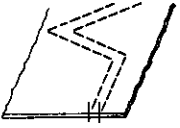
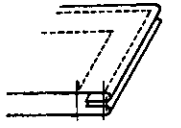
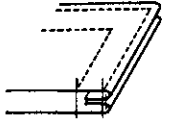
Unterklasse Subclass Sous-classe Subclase	-720/02-6/01-900/..	-720/02-113/13	-720/02-113/13-900/..	-720/02-113/33
Arbeitsgang Operation Opération Operación				Wie -720/02-113/13; jedoch mit gefedertem Anschlag in der rechten Sohle. Same as -720/02-113/13, but fitted with spring-loaded edge guide in right shoe. Comme la -720/02-113/13, mais avec butée faisant ressort dans la semelle droite du pied. Como la -720/02-113/13, pero con tope elástico en la planta derecha.
Ausführung Model Version Tipo de máquina	BN 8 B/CN 8	BN 8 B/CN 8	BN 8 B/CN 8	BN 8 B/CN 8
Nadelabstand in mm Needle gauge in mm Ecartement des aiguilles en mm Distancia entre agujas en mm	3,2 - 8,0	4,0 - 12,0	4,0 - 8,0	4,8 - 10,0
Nadelhalter ^{10/2} Needle holder Pince-aiguille Portaagujas	91-019 930-13	91-019 930-13	91-019 930-13	91-019 930-13
Stoffschieber ⁴ ^{10/1} Feed dog ^{10/2} Griffe Transportador inferior	91-047 994-04	91-047 859-04	91-047 994-04	91-047 859-04
Stichplatte ⁴ ^{10/1} Needle plate ^{10/2} Plaque à aiguille Placa de aguja	91-058 869-04	91-058 535-04	91-058 869-04	91-058 535-04
Nähfuß ⁴ ^{10/2} Presser foot Pied presseur Pie prensateelas	91-055 915-03	91-157 778-93	91-157 778-93	91-057 490-93
Lineal Edge guide Guide-bord Guia recta		99-117 873-91	99-117 873-91	
Zwischenstück Extension piece Pièce intermédiaire Pieza intermedia	91-055 918-91	91-055 918-91	91-055 918-91	91-055 918-91

Unterklassen-Übersicht
Table of subclasses

Table des sous-classes
Tabla de subclasses

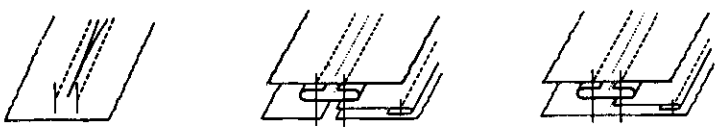
Unterklasse Subclass Sous-classe Subclase	-720/02-113/33-900/..	-732/09-6/03*	-732/09-263/02*	-732/09-263/50*
Arbeitsgang Operation Opération Operación	<p>Wie -720/02-113/13; jedoch mit gefedertem Anschlag in der rechten Sohle. Same as -720/02-113/13, but fitted with spring-loaded edge guide in right shoe. Comme la -720/02-113/13, mais avec butée faisant ressort dans la semelle droite du pied. Como la -720/02-113/13, pero con tope elástico en la planta derecha.</p> 			
Ausführung Model Version Tipo de máquina	BN 8 B/CN 8	B	B	B
Nadelabstand in mm Needle gauge in mm Ecartement des aiguilles en mm Distancia entre agujas en mm	4,8 - 8,0	8,0 - 20,0	8,0 - 20,0	8,0 - 20,0
Nadelstange ^{10/2} Needle bar Barre à aiguille Barra de aguja		91-113 458-93	91-113 458-93	91-113 458-93
Nadelhalter ^{10/2} Needle holder Pince-aiguille Portaagujas	91-019 930-13			
Stoffschieber ⁴ ^{10/2} Feed dog Griffe Transportador inferior	91-047 994-04	91-047 314-04	91-047 314-04	91-047 314-04
Stichplatte ⁴ ^{10/2} Needle plate Plaque à aiguille Placa de aguja	91-058 869-04	91-048 910-93 ▲	91-048 910-93 ▲	91-048 910-93 ▲
Nähfuß ⁴ ^{10/2} Presser foot Pied presseur Pie prensatelas	91-057 490-93	91-054 590-93	91-054 590-93	91-054 590-93
Apparat ⁵ ^{10/2} Attachment Appareil Aparato			91-053 732-93	91-056 489-93
Träger Bracket Support Soporte				91-056 179-91 ■
Zwischenstück Extension piece Pièce intermédiaire Pieza intermedia	91-055 918-91			
Messer Knife Couteau Cuchilla		91-113 460-01	91-113 460-01	91-113 460-01

Unterklassen-Übersicht
Table of subclasses

Table des sous-classes
Tabla de subclasses

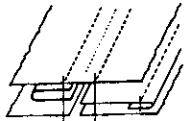
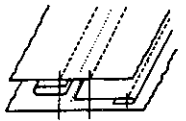
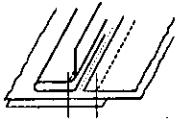
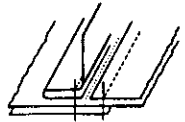
Unterklasse Subclass Sous-classe Subclase	-732/09-273/01*	-732/09-273/50*	-732/09-274/11*	-732/09-274/12*
Arbeitsgang Operation Opération Operación				
Ausführung Model Version Tipo de máquina	B	B	B	B
Nadelabstand in mm Needle gauge in mm Ecartement des aiguilles en mm Distancia entre agujas en mm	8,0 - 20,0	8,0 - 20,0	8,0 - 20,0	8,0 - 20,0
Nadelstange ^{10/2} Needle bar Barre à aiguille Barra de aguja	91-113 458-93	91-113 458-93	91-113 458-93	91-113 458-93
Stoffschieber ⁴ ^{10/2} Feed dog Griffe Transportador inferior	91-047 314-04	91-047 314-04	91-047 314-04	91-047 314-04
Stichplatte ⁴ ^{10/2} Needle plate Plaque à aiguille Placa de aguja	91-048 910-93 ▲	91-048 910-93 ▲	91-048 910-93 ▲	91-048 910-93 ▲
Nähfuß ⁴ ^{10/2} Presser foot Pied presseur Pie prensateelas	91-054 590-93	91-054 590-93	91-055 400-93	91-055 400-93
Apparat ⁵ ^{10/2} Attachment Appareil Aparato	91-053 414-23	91-056 481-93	91-053 859-93	* 91-053 859-93
Träger Bracket Support Soporte		91-056 179-91 ■	91-056 278-90	91-056 278-90
Kopfplatte Face plate Plaque frontale Placa frontal			91-140 212-71/993	91-140 212-71/993
Klammer Clamp Pince Pinza			91-113 451-25	91-113 451-25
Messer Knife Couteau Cuchilla	91-113 460-01	91-113 460-01	91-113 460-01	91-113 460-01
Klemmfeder Clamp spring Ressort de maintien Muelle de sujeción		91-129 661-15	91-129 661-15	91-129 661-15

Unterklassen-Übersicht
Table of subclasses

Table des sous-classes
Tabla de subclasses

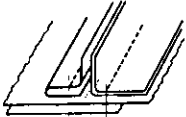
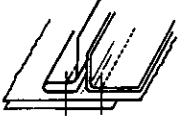
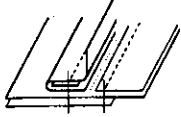
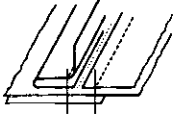
Unterklasse Subclass Sous-classe Subclase	-732/09-274/14°	-732/09-274/15°	-732/09-274/16°	-732/09-274/51°
Arbeitsgang Operation Opération Operación				
Ausführung Model Version Tipo de máquina	B	B	B	B
Nadelabstand in mm Needle gauge in mm Ecartement des aiguilles en mm Distancia entre agujas en mm	10,0 - 20,0	10,0 - 20,0	8,0 - 20,0	8,0 - 20,0
Nadelstange ^{10/2} Needle bar Barre à aiguille Barra de aguja	91-113 458-93	91-113 458-93	91-113 458-93	91-113 458-93
Stoffschieber ⁴ ^{10/2} Feed dog Griffe Transportador inferior	91-047 314-04	91-047 314-04	91-047 314-04	91-047 314-04
Stichplatte ⁴ ^{10/2} Needle plate Plaque à aiguille Placa de aguja	91-048 910-93 ▲	91-048 910-93 ▲	91-048 910-93 ▲	91-048 910-93 ▲
Nähfuß ⁴ ^{10/2} Presser foot Pied presseur Pie prensatelas	91-055 400-93 ▼	91-055 400-93	91-055 400-93	91-055 400-93
Apparat ⁵ ^{10/2} Attachment Appareil Aparato	91-053 859-93	91-053 859-93	91-056 505-93	91-056 480-93
Träger Bracket Support Soporte	91-056 278-90	91-056 278-90	91-056 278-90	91-056 179-91 ■
Kopfplatte Face plate Plaque frontale Placa frontal	91-140 212-71/993	91-140 212-71/993	91-140 212-71/993	
Klammer Clamp Pince Pinza	91-113 451-25	91-113 451-25	91-113 451-25	
Pattenführung Flap guide Guide-rabat Guía para carteras	91-053 869-91	91-053 869-91		
Messer Knife Couteau Cuchilla	91-113 460-01	91-113 460-01	91-113 460-01	91-113 460-01
Klemmfeder Clamp spring Ressort de maintien Muella de sujeción	91-129 661-15	91-129 661-15	91-129 661-15	91-129 661-15

Unterklassen-Übersicht
Table of subclasses

Table des sous-classes
Tabla de subclasses

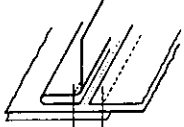
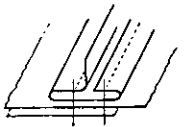
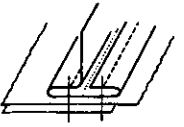
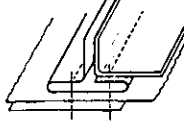
Unterklasse Subclass Sous-classe Subclase	-732/09-274/52*	-732/09-293/11*	-732/09-293/12*	-732/09-293/14*
Arbeitsgang Operation Opération Operación				
Ausführung Model Version Tipo de máquina	B	B	B	B
Nadelabstand in mm Needle gauge in mm Ecartement des aiguilles en mm Distancia entre agujas en mm	8,0 - 20,0	8,0 - 20,0	8,0 - 20,0	10,0 - 20,0
Nadelstange ^{10/2} Needle bar Barre à aiguille Barra de aguja	91-113 458-93	91-113 458-93	91-113 458-93	91-113 458-93
Stoffschieber ⁴ ^{10/2} Feed dog Griffe Transportador inferior	91-047 314-04	91-047 314-04	91-047 314-04	91-047 314-04
Stichplatte ⁴ ^{10/2} Needle plate Plaque à aiguille Placa de aguja	91-048 910-93 ▲	91-048 910-93 ▲	91-048 910-93 ▲	91-048 910-93 ▲
Nähfuß ⁴ ^{10/2} Presser foot Pied presseur Pie prensatelas	91-055 400-93	91-055 400-93	91-055 400-93	91-055 400-93
Apparat ⁵ ^{10/2} Attachment Appareil Aparato	91-056 480-93	91-053 874-93	91-053 874-93	91-053 874-93
Träger Bracket Support Soporte	91-056 179-91 ■	91-056 278-90	91-056 278-90	91-056 278-90
Kopfplatte Face plate Plaque frontale Placa frontal		91-140 212-71/993	91-140 212-71/993	91-140 212-71/993
Klammer Clamp Pince Pinza		91-113 451-25	91-113 451-25	91-113 451-25
Pattenführung Flap guide Guide-rabat Guía para carteras				91-053 869-91
Messer Knife Couteau Cuchilla	91-113 460-01	91-113 460-01	91-113 460-01	91-113 460-01
Klemmfeder Clamp spring Ressort de maintien Muelle de sujeción	91-129 661-15	91-129 661-15	91-129 661-15	

**Unterklassen-Übersicht
Table of subclasses**

**Table des sous-classes
Tabla de subclasses**

Unterklasse Subclass Sous-classe Subclase	-732/09-293/15*	-732/09-293/51*	-732/09-293/52*	-732/09-299/10*
Arbeitsgang Operation Opération Operación				
Ausführung Model Version Tipo de máquina	B	B	B	B
Nadelabstand in mm Needle gauge in mm Ecartement des aiguilles en mm Distancia entre agujas en mm	10,0 - 20,0	8,0 - 20,0	8,0 - 20,0	10,0 - 20,0
Nadelstange ^{10/2} Needle bar Barre à aiguille Barra de aguja	91-113 458-93	91-113 458-93	91-113 458-93	91-113 458-93
Stoffschieber ⁴ ^{10/2} Feed dog Griffe Transportador inferior	91-047 314-04	91-047 314-04	91-047 314-04	91-047 314-04
Stichplatte ⁴ ^{10/2} Needle plate Plaque à aiguille Placa de aguja	91-048 910-93 ▲	91-048 910-93 ▲	91-048 910-93 ▲	91-048 910-93 ▲
Nähfuß ⁴ ^{10/2} Presser foot Pied presseur Pie prensatelas	91-055 400-93	91-055 400-93	91-055 400-93	91-054 626-93
Apparat ⁵ ^{10/2} Attachment Appareil Aparato	91-053 874-93	91-056 488-93	91-056 488-93	91-053 880-23
Träger Bracket Support Soporte	91-056 278-90	91-056 179-91 ■	91-056 179-91 ■	91-056 278-90
Kopfplatte Face plate Plaque frontale Placa frontal	91-140 212-71/993			91-140 212-71/993
Klammer Clamp Pince Pinza	91-113 451-25			91-113 451-25
Pattenführung Flap guide Guide-rabat Guía para carteras	91-053 869-91			
Messer Knife Couteau Cuchilla	91-113 460-01	91-113 460-01	91-113 460-01	91-113 460-01
Klemmfeder Clamp spring Ressort de maintien Muelle de sujeción	91-129 661-15	91-129 661-15	91-129 661-15	

Unterklassen-Übersicht
Table of subclasses

Table des sous-classes
Tabla de subclasses

Unterklasse Subclass Sous-classe Subclase	-732/09-363/02*	-732/09-363/50*	-732/09-364/50*	-732/09-393/11*
Arbeitsgang Operation Opération Operación				
Ausführung Model Version Tipo de máquina	B	B	B	B
Nadelabstand in mm Needle gauge in mm Ecartement des aiguilles en mm Distancia entre agujas en mm	12,0 - 20,0	12,0 - 20,0	12,0 - 20,0	12,0 - 20,0
Nadelstange ^[10/2] Needle bar Barre à aiguille Barra de aguja	91-113 458-93	91-113 458-93	91-113 458-93	91-113 458-93
Stoffschieber ^[4] ^[10/2] Feed dog Griffe Transportador inferior	91-047 314-04	91-047 314-04	91-047 314-04	91-047 314-04
Stichplatte ^[4] ^[10/2] Needle plate Plaque à aiguille Placa de aguja	91-048 910-93 ▲	91-048 910-93 ▲	91-048 910-93 ▲	91-048 910-93 ▲
Nähfuß ^[4] ^[10/2] Presser foot Pied presseur Pie prensatejas	91-054 778-93	91-054 778-93	91-054 778-93	91-054 778-93
Apparat ^[5] ^[10/2] Attachment Appareil Aparato	91-053 736-23	91-056 494-23	91-461 314-23	91-156 118-23 ▲
Träger Bracket Support Soporte		91-056 179-91 ■	91-056 179-91 ■	91-056 278-90
Kopfplatte Face plate Plaque frontale Placa frontal				91-140 212-71/993
Klammer Clamp Pince Pinza				91-113 451-25
Reißverschlussführung Zipper guide Guide-fermeture à glissière Guía para cremalleras	91-053 758-21	91-053 758-21	91-053 758-21	91-156 119-21
Reißverschluss- Trennvorrichtung Zipper separator Coupe-fermeture à glissière Cortador de cremalleras	91-053 738-21	91-053 738-21	91-053 738-21	
Messer Knife Couteau Cuchilla	91-113 460-01	91-113 460-01	91-113 460-01	91-113 460-01

Unterklassen-Übersicht
Table of subclasses

Table des sous-classes
Tabla de subclasses

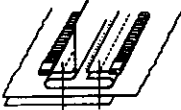
Unterklasse Subclass Sous-classe Subclase	-732/09-393/12*	-748/01-6/01	-748/01-6/01	-748/01-6/03
Arbeitsgang Operation Opération Operación		Für allgemeine Näharbeiten. Machine ist mit Walzentransport- Einrichtung ausgestattet (untere Walze angetrieben). For ordinary sewing operations; machine equipped with puller feed (driven bottom roller). Travaux de couture d'utilité courante. Entrainement supplémentaire par pulier (rouleau inférieur entraîné). Para trabajos de costura en general. Máquina equipada con transportador auxiliar de rodillos (rodillo inferior accionado).	Für allgemeine Näharbeiten. Machine ist mit Walzentransport- Einrichtung ausgestattet (untere Walze angetrieben). For ordinary sewing operations; machine equipped with puller feed (driven bottom roller). Travaux de couture d'utilité courante. Entrainement supplémentaire par pulier (rouleau inférieur entraîné). Para trabajos de costura en general. Máquina equipada con transportador auxiliar de rodillos (rodillo inferior accionado).	Wie -748/01-6/01, jedoch mit zweitteiligem Fuß. Same as -748/01-6/01, but with two-part foot. Comme la -748/01-6/01, mais avec pied en deux parties. Como la -748/01-6/01, pero con pie bipartido.
Ausführung Model Version Tipo de máquina	B	BN	CN	BN
Nadelabstand in mm Needle gauge in mm Ecartement des aiguilles en mm Distancia entre agujas en mm	12,0 - 20,0	3,2 - 72,0	3,2 - 72,0	4,0 - 72,0
Nadelstange ^{10/2} Needle bar Barre à aiguille Barra de aguja	91-113 458-93			
Nadelhalter ^{10/2} Needle holder Pince-aiguille Portaagujas		91-710 004-93 ¹⁰ = 3,2 - 34,0 mm 91-710 234-93 ¹⁰ = 36,0 - 72,0 mm	91-710 004-93 ¹⁰ = 3,2 - 34,0 mm 91-710 234-93 ¹⁰ = 36,0 - 72,0 mm	91-710 004-93 ¹⁰ = 4,0 - 34,0 mm 91-710 234-93 ¹⁰ = 36,0 - 72,0 mm
Stoffschieber ⁴ ^{10/1} ^{10/2} Feed dog Griffe Transportador inferior	91-047 314-04	91-046 714-04 ¹⁰ = 3,2 mm; 6,0 - 36,0 mm 91-046 734-04 ¹⁰ = 4,0 - 5,6 mm 91-047 261-93 ¹⁰ = 38,0 - 72,0 mm	91-046 714-04 ¹⁰ = 3,2 - 36,0 mm 91-047 261-93 ¹⁰ = 38,0 - 72,0 mm	91-046 734-04 ¹⁰ = 4,0 - 5,6 mm 91-046 714-04 ¹⁰ = 6,0 - 36,0 mm 91-047 261-93 ¹⁰ = 38,0 - 72,0 mm
Stichplatte ⁴ ^{10/1} ^{10/2} Needle plate Plaque à aiguille Placa de aguja	91-048 910-93 ▲	91-046 715-04 ¹⁰ = 3,2 mm; 6,0 - 72,0 mm 91-046 735-04 ¹⁰ = 4,0 - 5,6 mm	91-046 715-04	91-046 735-04 ¹⁰ = 4,0 - 5,6 mm 91-046 715-04 ¹⁰ = 6,0 - 72,0 mm
Nähfuß ⁴ ^{10/2} Presser foot Pied presseur Pie prensatelas	91-054 778-93	91-040 811-03	91-040 811-03	91-046 895-93 ¹⁰ = 4,0 - 11,6 mm 91-046 900-93 ¹⁰ = 12,0 - 22,0 mm 91-046 905-93 ¹⁰ = 24,0 - 66,8 mm 91-046 875-93 ¹⁰ = 68,0 - 72,0 mm
Apparat ⁵ ^{10/2} Attachment Appareil Aparato	91-156 118-23			
Träger Bracket Support Soporte	91-056 278-90			
Kopfplatte Face plate Plaque frontale Placa frontal	91-140 212-71/993			
Klammer Clamp Pince Pinza	91-113 451-25			
Reißverschlussführung Zipper guide Guide-fermeture à glissière Guía para cremalleras	91-156 119-21			
Messer Knife Couteau Cuchilla	91-113 460-01			

Unterklassen-Übersicht
Table of subclasses

Table des sous-classes
Tabla de subclases

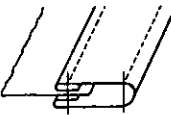
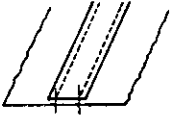
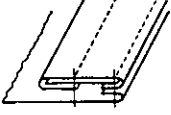
Unterklasse Subclass Sous-classe Subclase	-748/01-6/03	-748/01-6/04	-748/01-39/61	-748/01-61/02	-748/01-67/02
Arbeitsgang Operation Opération Operación	Wie -748/01-6/01, jedoch mit zweiteiligem Fuß. Same as -748/01-6/01, but with two-part foot. Comme la -748/01-6/01, mais avec pied en deux parties. Como la -748/01-6/01, pero con pie bipartido.	Wie -748/01-6/01, jedoch mit dreiteiligem Fuß. Same as -748/01-6/01, but with three-part foot. Comme la -748/01-6/01, mais avec pied presseur en trois parties. Como la -748/01-6/01, pero con pie tripartido.			
Ausführung Model Version Tipo de máquina	CN	BN; CN	BN; CN	BN; CN	BN; CN
Nadelabstand in mm Needle gauge in mm Ecartement des aiguilles en mm Distancia entre agujas en mm	4,0 - 72,0	14,0 - 72,0	12,0 - 50,0	6,0 - 72,0	14,0 - 72,0
Nadelhalter $\boxed{10/2}$ Needle holder Pince-aiguille Portaagujas	91-710 004-93 $\boxed{10}$ = 4,0 - 34,0 mm 91-710 234-93 $\boxed{10}$ = 36,0 - 72,0 mm	91-710 004-93 $\boxed{10}$ = 14,0 - 34,0 mm 91-710 234-93 $\boxed{10}$ = 36,0 - 72,0 mm	91-710 004-93 $\boxed{10}$ = 12,0 - 34,0 mm 91-710 234-93 $\boxed{10}$ = 36,0 - 72,0 mm	91-710 004-93 $\boxed{10}$ = 6,0 - 34,0 mm 91-710 234-93 $\boxed{10}$ = 36,0 - 72,0 mm	91-710 004-93 $\boxed{10}$ = 14,0 - 34,0 mm 91-710 234-93 $\boxed{10}$ = 36,0 - 72,0 mm
Stoffschieber $\boxed{4}$ $\boxed{10/1}$ Feed dog $\boxed{10/2}$ Griffe Transportador inferior	91-046 714-04 $\boxed{10}$ = 4,0 - 36,0 mm 91-047 261-93 $\boxed{10}$ = 38,0 - 72,0 mm	91-046 714-04 $\boxed{10}$ = 14,0 - 36,0 mm 91-047 261-93 $\boxed{10}$ = 38,0 - 72,0 mm	91-046 714-04 $\boxed{10}$ = 12,0 - 36,0 mm 91-047 261-93 $\boxed{10}$ = 38,0 - 50,0 mm	91-046 714-04 $\boxed{10}$ = 6,0 - 36,0 mm 91-047 261-93 $\boxed{10}$ = 38,0 - 72,0 mm	91-046 714-04 $\boxed{10}$ = 14,0 - 36,0 mm 91-047 261-93 $\boxed{10}$ = 38,0 - 72,0 mm
Stichplatte $\boxed{4}$ $\boxed{10/1}$ Needle plate $\boxed{10/2}$ Plaque à aiguille Placa de aguja	91-046 715-04	91-046 715-04	91-046 715-04	91-046 715-04	91-046 715-04
Nähfuß $\boxed{4}$ $\boxed{10/2}$ Presser foot Pied presseur Pie prensatelas	91-046 895-93 $\boxed{10}$ = 4,0 - 11,6 mm 91-046 900-93 $\boxed{10}$ = 12,0 - 22,0 mm 91-046 905-93 $\boxed{10}$ = 24,0 - 66,8 mm 91-046 875-93 $\boxed{10}$ = 68,0 - 72,0 mm	91-046 875-93	91-046 900-93 $\boxed{10}$ = 12,0 - 22,0 mm 91-046 905-93 $\boxed{10}$ = 24,0 - 50,0 mm	91-040 811-03	91-046 875-93
Apparat $\boxed{5}$ $\boxed{10/2}$ Attachment Appareil Aparato			91-056 913-93		91-045 776-23 91-040 857-21
Träger Bracket Support Soporte			91-040 528-90	91-040 862-90	91-040 862-90 91-040 528-90
Kopfplatte Face plate Plaque frontale Placa frontal				91-140 383-71/993	91-140 383-71/993
Bandtrommel Tape reel Tambour-dérouleur Tambor-portacintas			91-043 943-70/995	91-040 207-70/995	91-045 775-70
Bandführung $\boxed{5}$ $\boxed{10/2}$ Tape guide Guide-ruban Guiacintas				91-043 408-23	

Unterklassen-Übersicht Table of subclasses

Table des sous-classes Tabla de subclasses

Unterklasse Subclass Sous-classe Subclase	-748/01-67/03	-748/01-67/04	-748/01-67/12	-748/01-68/02	-748/01-68/03
Arbeitsgang Operation Opération Operación					
Ausführung Model Version Tipo de máquina	BN; CN	BN; CN	BN	BN; CN	BN; CN
Nadelabstand in mm Needle gauge in mm Ecartement des aiguilles en mm Distancia entre agujas en mm	14,0 - 72,0	6,0 - 72,0	3,2 - 20,0	14,0 - 72,0	14,0 - 72,0
Nadehalter ^{10/2} Needle holder Pince-aiguille Portaagujas	91-710 004-93 ¹⁰ = 14,0 - 34,0 mm 91-710 234-93 ¹⁰ = 36,0 - 72,0 mm	91-710 004-93 ¹⁰ = 6,0 - 34,0 mm 91-710 234-93 ¹⁰ = 36,0 - 72,0 mm	91-710 004-93	91-710 004-93 ¹⁰ = 14,0 - 34,0 mm 91-710 234-93 ¹⁰ = 36,0 - 72,0 mm	91-710 004-93 ¹⁰ = 14,0 - 34,0 mm 91-710 234-93 ¹⁰ = 36,0 - 72,0 mm
Stoffschieber ⁴ ^{10/1} Feed dog Griffe Transportador inferior	91-046 714-04 ¹⁰ = 14,0 - 36,0 mm 91-047 261-93 ¹⁰ = 38,0 - 72,0 mm	91-046 714-04 ¹⁰ = 6,0 - 36,0 mm 91-047 261-93 ¹⁰ = 38,0 - 72,0 mm	91-046 714-04 ¹⁰ = 3,2 mm; 6,0 - 20,0 mm 91-046 734-04 ¹⁰ = 4,0 - 5,6 mm	91-046 714-04 ¹⁰ = 14,0 - 36,0 mm 91-047 261-93 ¹⁰ = 38,0 - 72,0 mm	91-046 714-04 ¹⁰ = 14,0 - 36,0 mm 91-047 261-93 ¹⁰ = 38,0 - 72,0 mm
Stichplatte ⁴ ^{10/1} Needle plate Plaque à aiguille Placa de aguja	91-046 715-04	91-046 715-04	91-046 715-04 ¹⁰ = 3,2 mm; 6,0 - 20,0 mm 91-046 735-04 ¹⁰ = 4,0 - 5,6 mm	91-046 715-04	91-046 715-04
Nähfuß ⁴ ^{10/2} Presser foot Pied presseur Pie prensateelas	91-046 875-93	91-046 895-93 ¹⁰ = 6,0 - 11,2 mm 91-046 900-93 ¹⁰ = 12,0 - 22,0 mm 91-046 905-93 ¹⁰ = 24,0 - 66,8 mm 91-046 875-93 ¹⁰ = 68,0 - 72,0 mm	91-026 758-03 ⁵	91-046 875-93	91-046 875-93
Apparat ⁵ ^{10/2} Attachment Appareil Aparato	91-041 216-23 91-040 857-21	91-040 769-23 91-041 906-23	91-041 906-23	91-045 776-23 91-040 797-23	91-041 216-23 91-040 797-23
Träger Bracket Support Soporte	91-040 862-90 91-040 528-90	91-040 862-90 91-040 528-90	91-040 528-90	91-040 862-90 91-040 528-90	91-040 862-90 91-040 528-90
Kopfplatte Face plate Plaque frontale Placa frontal	91-140 383-71/993	91-140 383-71/993		91-140 383-71/993	91-140 383-71/993
Bandtrommel Tape reel Tambour-dérouleur Tambor-portacintas	91-045 775-70	91-040 207-70/995	91-040 207-70/995	91-045 775-70	91-045 775-70
Fingerschutz ^{10/2} Finger guard Protège-doigts Salvadedos			91-055 261-91 ¹⁰ = 3,2 - 8,0 mm 91-055 259-91 ¹⁰ = 9,2 - 20,0 mm		

Unterklassen-Übersicht
Table of subclasses

Table des sous-classes
Tabla de subclasses

Unterklasse Subclass Sous-classe Subclass	-748/01-68/22	-748/01-82/02	-748/01-210/02	-748/01-211/02	-748/24-82/99 -918/04
Arbeitsgang Operation Opération Operación					
Ausführung Model Version Tipo de máquina	BN	BN; CN	BN; CN	BN	BN
Nadelabstand in mm Needle gauge in mm Ecartement des aiguilles en mm Distancia entre agujas en mm	16,0 - 32,0	12,0 - 72,0	14,0 - 72,0	20,0 - 40,0	14,0 - 72,0
Nadelhalter ^{10/2} Needle holder Pince-aiguille Portaagujas	91-710 004-93	91-710 004-93 ¹⁰ = 12,0 - 34,0 mm 91-710 234-93 ¹⁰ = 36,0 - 72,0 mm	91-710 004-93 ¹⁰ = 14,0 - 34,0 mm 91-710 234-93 ¹⁰ = 36,0 - 72,0 mm	91-710 004-93 ¹⁰ = 20,0 - 34,0 mm 91-710 234-93 ¹⁰ = 36,0 - 40,0 mm	91-710 004-93 ¹⁰ = 14,0 - 34,0 mm 91-710 234-93 ¹⁰ = 36,0 - 72,0 mm
Stoffschieber ⁴ ^{10/1} ^{10/2} Feed dog Griffe Transportador inferior	91-046 714-04	91-046 714-04 ¹⁰ = 12,0 - 36,0 mm 91-047 261-93 ¹⁰ = 38,0 - 72,0 mm	91-046 714-04 ¹⁰ = 14,0 - 36,0 mm 91-047 261-93 ¹⁰ = 38,0 - 72,0 mm	91-046 714-04 ¹⁰ = 20,0 - 36,0 mm 91-047 261-93 ¹⁰ = 38,0 - 40,0 mm	91-046 714-04 ¹⁰ = 14,0 - 36,0 mm 91-047 261-93 ¹⁰ = 38,0 - 72,0 mm
Stichplatte ⁴ ^{10/1} ^{10/2} Needle plate Plaque à aiguille Placa de aguja	91-046 715-04	91-046 715-04	91-046 715-04	91-046 715-04	91-046 715-04
Nähfuß ⁴ ^{10/2} Presser foot Pied presseur Pie prensateelas	91-155 173-93	91-046 900-93 ¹⁰ = 12,0 - 22,0 mm 91-046 905-93 ¹⁰ = 24,0 - 66,8 mm 91-046 875-93 ¹⁰ = 68,0 - 72,0 mm	91-046 875-93	91-046 875-93	91-026 462-03 ⁵ ¹⁰ = 14,0 - 26,0 mm 91-040 811-03 ¹⁰ = 28,0 - 72,0 mm
Apparat ⁵ ^{10/2} Attachment Appareil Aparato	91-156 120-93	91-041 906-23	91-040 797-23	91-156 121-93	99-177 636-23 x 25
Träger Bracket Support Soporte	91-053 936-90	91-040 862-90 91-040 528-90	91-040 862-90 91-040 528-90	91-053 936-90	91-053 936-90 91-040 862-90
Kopfplatte Face plate Plaque frontale Placa frontal			91-140 383-71/993		91-140 383-71/993
Bandtrommel Tape reel Tambour-dérouleur Tambor-portacintas		91-040 207-70/995	91-040 207-70/995 91-041 644-70/995	91-040 207-70/995 91-041 644-70/995	
Bandführung ⁵ ^{10/2} Tape guide Guide-ruban Guiacintas		91-043 408-23	91-043 408-23		91-043 408-23
Fingerschutz ^{10/2} Finger guard Protège-doigts Salvadedos					91-046 868-25 ¹⁰ = 14,0 - 26,0 mm

**Nähwerkzeuge
Gauge parts**

**Organes de couture
Organos de costura**

91-113 458-93 ^{10/2}

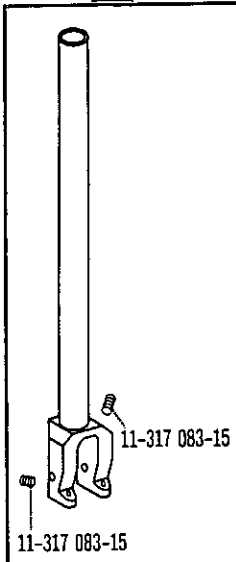

- 732/09-6/03 (-900/..)
- 732/09-263/02 (-900/..)
- 732/09-263/50 (-900/..)
- 732/09-273/01 (-900/..)
- 732/09-273/50 (-900/..)
- 732/09-274/11 (-900/..)
- 732/09-274/12 (-900/..)
- 732/09-274/14 (-900/..)
- 732/09-274/15 (-900/..)
- 732/09-274/16 (-900/..)
- 732/09-274/51 (-900/..)
- 732/09-274/52 (-900/..)
- 732/09-293/11 (-900/..)
- 732/09-293/12 (-900/..)
- 732/09-293/14 (-900/..)
- 732/09-293/15 (-900/..)
- 732/09-293/51 (-900/..)
- 732/09-293/52 (-900/..)
- 732/09-299/10 (-900/..)
- 732/09-363/02 (-900/..)
- 732/09-363/50 (-900/..)
- 732/09-364/50 (-900/..)
- 732/09-393/11 (-900/..)
- 732/09-393/12 (-900/..)

91-019 930-13 ^{10/2}

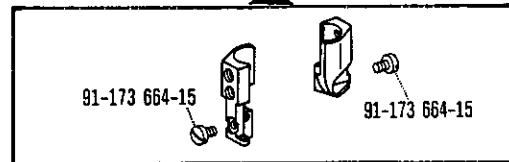

- 720/02-6/01
- 720/02-6/01-900/..
- 720/02-113/13
- 720/02-113/13-900/..
- 720/02-113/33
- 720/02-113/33-900/..

91-710 004-93 ^{10/2}

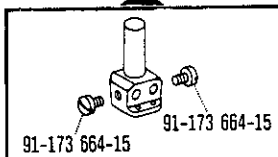

- 6/01
- 6/01-900/..
- 61/02
- 61/02-900/..
- 61/09
- 61/09-900/..

- 748/01-6/01
- 748/01-6/03
- 748/01-6/04
- 748/01-39/61
- 748/01-61/02
- 748/01-67/02
- 748/01-67/03
- 748/01-67/04
- 748/01-67/12
- 748/01-68/02
- 748/01-68/03
- 748/01-68/22
- 748/01-82/02
- 748/01-210/02
- 748/01-211/02
- 748/24-82/99-918/04

91-710 234-93 ^{10/2}

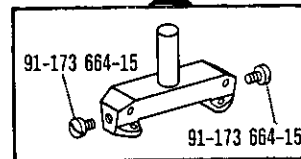

- 6/01
- 61/02
- 748/01-6/01
- 748/01-6/03
- 748/01-6/04
- 748/01-39/61
- 748/01-61/02
- 748/01-67/02
- 748/01-67/03
- 748/01-67/04
- 748/01-68/02
- 748/01-68/03
- 748/01-82/02
- 748/01-210/02
- 748/01-211/02
- 748/24-82/99-918/04

91-046 714-04 ⁴ ^{10/1} ^{10/2}
¹⁰ B = 3,2 mm
¹⁰ C = 3,2 - 5,6 mm



- 6/01
- 6/01-900/..
- 61/02
- 61/09
- 720/02-6/01
- 720/02-6/01-900/..
- 748/01-6/01
- 748/01-6/03
- 748/01-67/12

91-046 714-04 ⁴ ^{10/1} ^{10/2}
¹⁰ = 6,0 - 36,0 mm

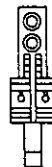

- 6/01
- 6/01-900/..
- 61/02
- 61/09
- 720/02-6/01
- 720/02-6/01-900/..
- 748/01-6/01
- 748/01-6/03
- 748/01-6/04
- 748/01-39/61
- 748/01-61/02
- 748/01-67/02
- 748/01-67/03
- 748/01-67/04
- 748/01-67/12
- 748/01-68/03
- 748/01-68/22
- 748/01-82/02
- 748/01-210/02
- 748/01-211/02
- 748/24-82/99-918/04

91-046 734-04 ⁴ ^{10/1} ^{10/2}



- 6/01
- 6/01-900/..
- 720/02-6/01
- 720/02-6/01-900/..
- 748/01-6/01
- 748/01-6/03
- 748/01-67/12

91-047 151-04 ⁴ ^{10/2}
¹⁰ = 3,2 - 5,6 mm



- 6/01-900/..
- 61/02-900/..
- 61/09-900/..
- 720/02-6/01-900/..

91-047 151-04 ⁴ ^{10/1} ^{10/2}
¹⁰ = 6,0 - 32,0 mm



- 6/01-900/..
- 61/02-900/..
- 61/09-900/..
- 720/02-6/01-900/..

Nähwerkzeuge
Gauge parts

Organes de couture
Organos de costura

91-047 261-93

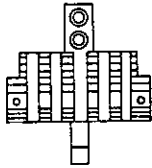

-6/01
-61/02
-748/01-6/01
-748/01-6/03
-748/01-6/04
-748/01-39/61
-748/01-61/02
-748/01-67/02
-748/01-67/03
-748/01-67/04
-748/01-68/02
-748/01-68/03
-748/01-82/02
-748/01-210/02
-748/01-211/02
-748/24-82/99-918/24

91-047 314-04

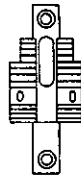

-732/09-6/03 (-900/..)
-732/09-263/02 (-900/..)
-732/09-263/50 (-900/..)
-732/09-273/01 (-900/..)
-732/09-273/50 (-900/..)
-732/09-274/11 (-900/..)
-732/09-274/12 (-900/..)
-732/09-274/14 (-900/..)
-732/09-274/15 (-900/..)
-732/09-274/16 (-900/..)
-732/09-274/51 (-900/..)
-732/09-274/52 (-900/..)
-732/09-293/11 (-900/..)
-732/09-293/12 (-900/..)
-732/09-293/14 (-900/..)
-732/09-293/15 (-900/..)
-732/09-293/51 (-900/..)
-732/09-293/52 (-900/..)
-732/09-299/10 (-900/..)
-732/09-363/02 (-900/..)
-732/09-363/50 (-900/..)
-732/09-364/50 (-900/..)
-732/09-393/11 (-900/..)
-732/09-393/12 (-900/..)

91-047 859-04

B = 3,2 - 4,0 mm
 C = 3,2 - 6,0 mm



-720/02-6/01
-720/02-113/13
-720/02-113/33

91-047 859-04

B = 4,8 - 20,0 mm
 C = 6,4 - 20,0 mm

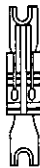

-720/02-6/01
-720/02-113/13
-720/02-113/33

91-047 994-04

B = 3,2 - 4,0 mm
 C = 3,2; 4,8; 6,0 mm

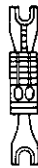

-720/02-6/01-900/..
-720/02-113/13-900/..
-720/02-113/33-900/..

91-047 994-04

B = 4,8 - 8,0 mm
 C = 6,4 - 8,0 mm



-720/02-6/01-900/..
-720/02-113/13-900/..
-720/02-113/33-900/..

91-046 715-04

B = 3,2 mm
 C = 3,2 - 5,6 mm

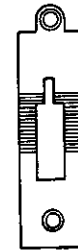

-6/01
-61/02
-61/09
-720/02-6/01
-748/01-6/01
-748/01-6/03
-748/01-67/12

91-046 715-04

B = 6,0 - 36,0 mm

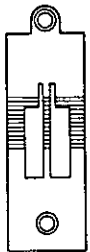

-6/01
-61/02
-61/09
-720/02-6/01

-748/01-6/01
-748/01-6/03
-748/01-6/04
-748/01-39/61
-748/01-61/02
-748/01-67/02
-748/01-67/03
-748/01-67/04
-748/01-67/12
-748/01-68/02
-748/01-68/03
-748/01-68/22
-748/01-82/02
-748/01-210/02
-748/01-211/02
-748/24-82/99-918/04

91-046 715-04

B = 38 - 72,0 mm

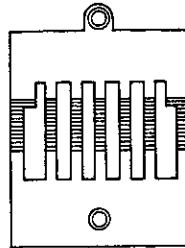

-6/01
-61/02
-748/01-6/01
-748/01-6/03
-748/01-6/04
-748/01-39/61
-748/01-61/02
-748/01-67/02
-748/01-67/03
-748/01-67/04
-748/01-68/02
-748/01-68/03
-748/01-82/02
-748/01-210/02
-748/01-211/02
-748/24-82/99-918/04

91-046 735-04



-6/01
-720/02-6/01
-748/01-6/01
-748/01-6/03
-748/01-67/12

91-048 910-93

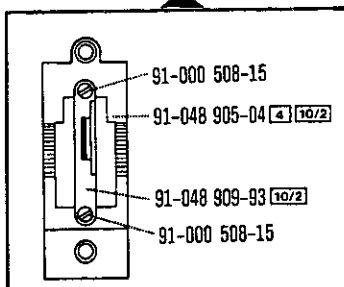

-732/09-6/03
-732/09-263/02
-732/09-263/50
-732/09-273/01
-732/09-273/50
-732/09-274/11
-732/09-274/12
-732/09-274/14
-732/09-274/15
-732/09-274/16
-732/09-274/51
-732/09-274/52
-732/09-293/11
-732/09-293/12
-732/09-293/14
-732/09-293/15
-732/09-293/51
-732/09-293/52
-732/09-299/10
-732/09-363/02
-732/09-363/50
-732/09-364/50
-732/09-393/11
-732/09-393/12

91-058 535-04

B = 3,2 - 4,0 mm
 C = 3,2 - 6,0 mm



-720/02-6/01
-720/02-113/13
-720/02-113/33

91-058 535-04



B = 4,8 - 20,0 mm
 C = 6,4 - 20,0 mm



-720/02-6/01
-720/02-113/13
-720/02-113/33

Nähwerkzeuge
Gauge parts

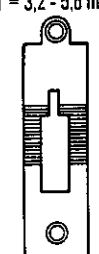
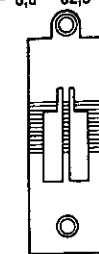
Organes de couture
Organos de costura

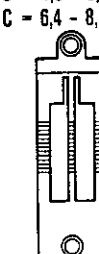
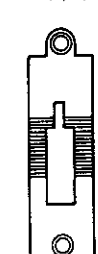
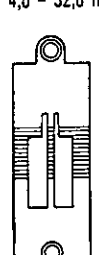
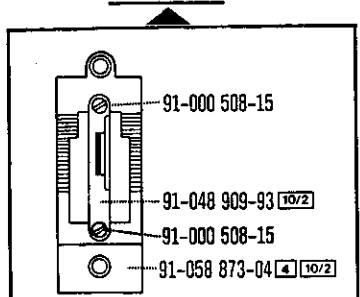
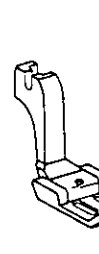
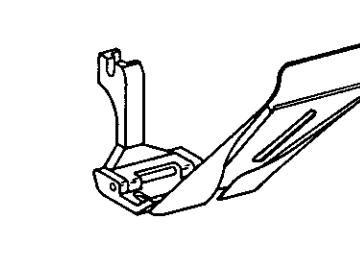
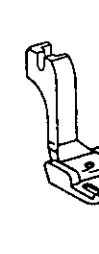
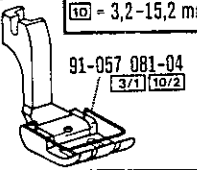
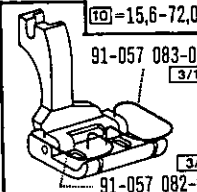
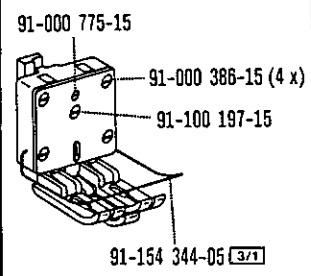
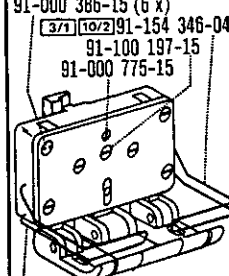
<p>91-058 867-04 10/2 10 = 3,2 - 5,6 mm</p>  <p>-6/01-900/.. -61/02-900/.. -61/09-900/.. -720/02-6/01-900/..</p>	<p>91-058 867-04 10/1 10/2 10 = 6,0 - 32,0 mm</p>  <p>-6/01-900/.. -61/02-900/.. -61/09-900/.. -720/02-6/01-900/..</p>	<p>91-058 869-04 10/2 10 B = 3,2; 4,0 mm 10 C = 3,2; 4,8; 6,0 mm</p>  <p>-720/02-6/01-900/.. -720/02-113/13-900/.. -720/02-113/33-900/..</p>	<p>91-058 869-04 10/1 10/2 10 B = 4,8 - 8,0 mm 10 C = 6,4 - 8,0 mm</p>  <p>-720/02-6/01-900/.. -720/02-113/13-900/.. -720/02-113/33-900/..</p>	<p>91-058 871-04 10/2 10 = 3,2; 3,6 mm</p>  <p>-6/01-900/.. -720/02-6/01-900/..</p>
<p>91-058 871-04 10/1 10/2 10 = 4,0 - 32,0 mm</p>  <p>-6/01-900/.. -720/02-6/01-900/..</p>	<p>91-058 872-93 10/2</p>  <p>91-000 508-15 91-048 909-93 10/2 91-000 508-15 91-058 873-04 10/2</p>		<p>-732/09-6/03-900/.. -732/09-263/02-900/.. -732/09-263/50-900/.. -732/09-273/01-900/.. -732/09-273/50-900/.. -732/09-274/11-900/.. -732/09-274/12-900/.. -732/09-274/14-900/.. -732/09-274/15-900/.. -732/09-274/16-900/.. -732/09-274/51-900/.. -732/09-274/52-900/..</p>	<p>-732/09-293/11-900/.. -732/09-293/12-900/.. -732/09-293/14-900/.. -732/09-293/15-900/.. -732/09-293/51-900/.. -732/09-293/52-900/.. -732/09-299/10-900/.. -732/09-363/02-900/.. -732/09-363/50-900/.. -732/09-364/50-900/.. -732/09-393/11-900/.. -732/09-393/12-900/..</p>
<p>91-026 462-03 5 10/2</p>  <p>-748/24-82/99-918/04</p>	<p>91-026 758-03 4 5 10/2</p>  <p>-748/01-67/12</p>	<p>91-040 584-03 5 10/2</p>  <p>-61/09 -61/09-900/..</p>	<p>91-040 811-03 10/2</p>  <p>10 = 3,2 - 15,2 mm 91-057 081-04 3/1 10/2</p> <p>-6/01 -6/01-900/.. -61/02 -61/02-900/.. -720/02-6/01 -720/02-6/01-900/.. -748/01-6/01 -748/01-61/02</p>	
<p>91-040 811-03 10/2</p>  <p>10 = 15,6 - 72,0 mm 91-057 083-05 3/1 91-057 082-05 3/1</p> <p>-6/01 -6/01-900/.. -61/02 -61/02-900/.. -720/02-6/01 -720/02-6/01-900/.. -748/01-6/01 -748/01-61/02 -748/24-82/99-918/04</p>	<p>91-046 875-93 10/2</p>  <p>91-000 775-15 91-000 386-15 (4 x) 91-100 197-15 91-154 344-05 3/1</p> <p>10 = 14,0 - 22,8 mm</p> <p>-748/01-6/04 -748/01-67/02 -748/01-67/03 -748/01-68/02 -748/01-68/03 -748/01-210/02 -748/01-211/02</p>	<p>91-046 875-93 10/2</p>  <p>91-000 386-15 (6 x) 3/1 10/2 91-154 346-04 91-100 197-15 91-000 775-15 91-154 345-04 3/1 10/2</p> <p>10 = 23,2 - 72,0 mm</p> <p>-748/01-6/03 -748/01-6/04 -748/01-67/02 -748/01-67/03 -748/01-67/04 -748/01-68/02 -748/01-68/03 -748/01-82/02 -748/01-210/02 -748/01-211/02</p>		

**Nähwerkzeuge
Gauge parts**

**Organes de couture
Organos de costura**

91-046 895-93 [4] [10/2]

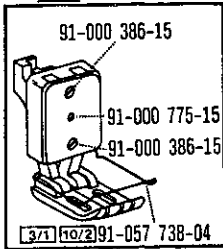

91-057 738-04 [3/1] [10/2]
-748/01-6/03
-748/01-39/61
-748/01-67/04
-748/01-82/02

91-046 900-93 [4] [10/2]

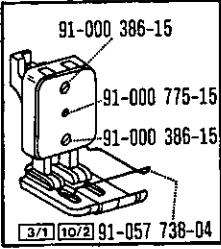

91-057 738-04 [3/1] [10/2]
-748/01-6/03
-748/01-39/61
-748/01-67/04
-748/01-82/02

91-046 905-93 [4] [10/2]

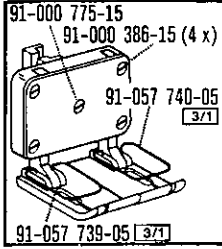

91-057 739-05 [3/1]
-748/01-6/03
-748/01-39/61
-748/01-67/04
-748/01-82/02

91-054 590-93 [4] [10/2]

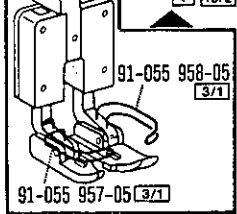

91-055 958-05 [3/1]
91-055 957-05 [3/1]
-732/09-6/03 (-900/..)
-732/09-263/02 (-900/..)
-732/09-263/50 (-900/..)
-732/09-273/01 (-900/..)
-732/09-273/50 (-900/..)

91-054 626-93 [4] [10/2]

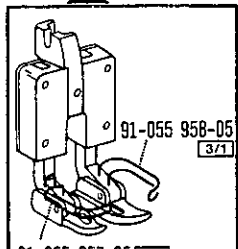

91-055 958-05 [3/1]
91-055 957-05 [3/1]
-732/09-299/10 (-900/..)

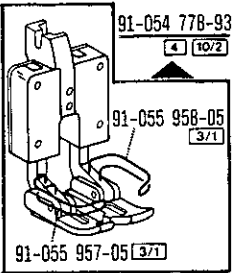

91-054 778-93 [4] [10/2]
91-055 958-05 [3/1]
91-055 957-05 [3/1]
-732/09-363/02 (-900/..)
-732/09-363/50 (-900/..)
-732/09-364/50 (-900/..)
-732/09-393/11 (-900/..)
-732/09-393/12 (-900/..)

91-055 400-93 [4] [10/2]

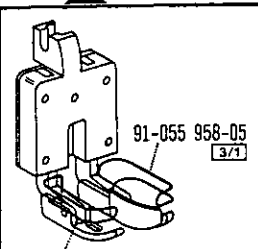

91-055 958-05 [3/1]
91-055 957-05 [3/1]

-732/09-274/11 (-900/..)
-732/09-274/12 (-900/..)
-732/09-274/14 (-900/..)
-732/09-274/15 (-900/..)
-732/09-274/16 (-900/..)
-732/09-274/51 (-900/..)
-732/09-274/52 (-900/..)
-732/09-293/11 (-900/..)
-732/09-293/12 (-900/..)
-732/09-293/14 (-900/..)
-732/09-293/15 (-900/..)
-732/09-293/51 (-900/..)
-732/09-293/52 (-900/..)

91-055 915-03 [4] [10/2]

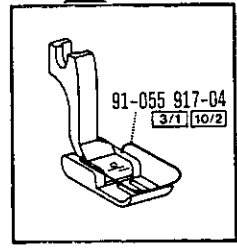

91-055 917-04 [3/1] [10/2]
-720/02-6/01
-720/02-6/01-900/..

91-057 490-93 [4] [10/2]

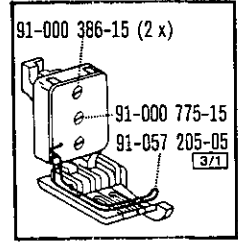

91-000 386-15 (2 x)
91-000 775-15
91-057 205-05 [3/1]
-720/02-113/33
-720/02-113/33-900/..

91-155 173-93 [4] [10/2]

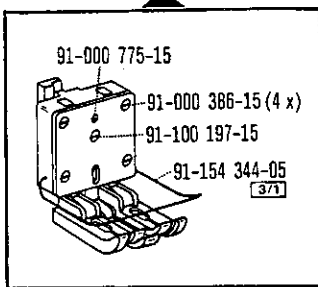

10 = 16,0 - 22,8 mm
-748/01-68/22

91-155 173-93 [4] [10/2]

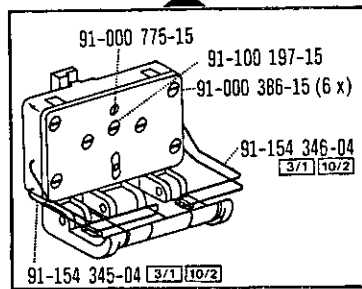

91-154 345-04 [3/1] [10/2]
10 = 23,2 - 32,0 mm
-748/01-68/22

91-157 778-93 [4] [10/2]

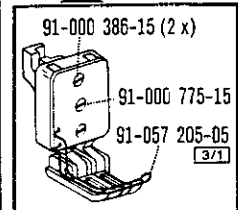

91-000 386-15 (2 x)
91-000 775-15
91-057 205-05 [3/1]
-720/02-113/13
-720/02-113/13-900/..

91-053 738-21

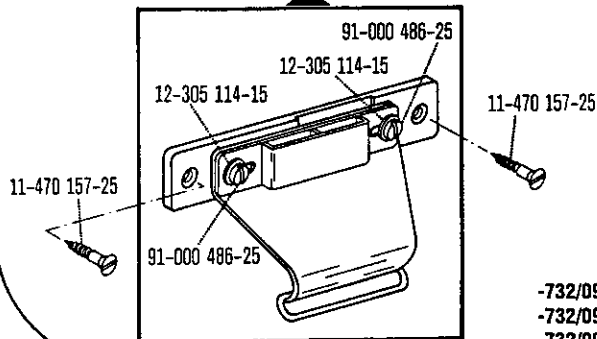

91-000 486-25
12-305 114-15
11-470 157-25
-732/09-363/02 (-900/..)
-732/09-363/50 (-900/..)
-732/09-364/50 (-900/..)

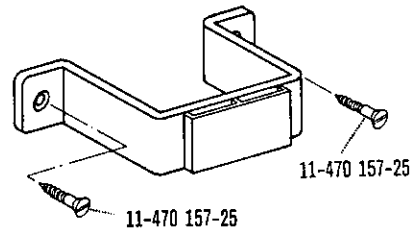

91-053 758-21



11-470 157-25
-732/09-363/02 (-900/..)
-732/09-363/50 (-900/..)
-732/09-364/50 (-900/..)



Nähwerkzeuge
Gauge parts

Organes de couture
Organos de costura

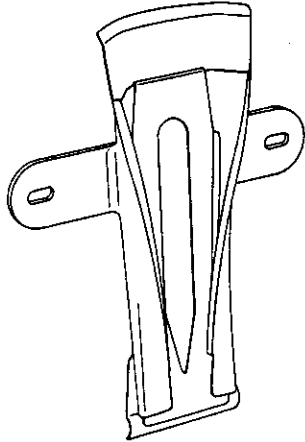
91-040 769-23  



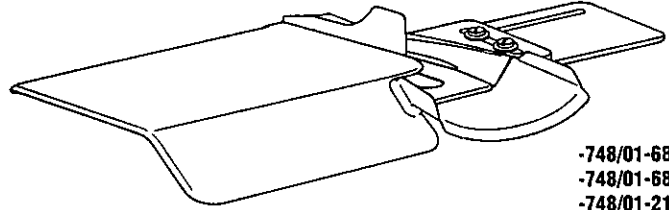

-748/01-67/04

91-040 797-23  



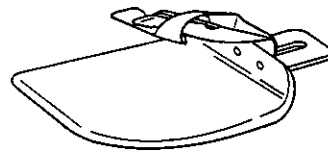

-748/01-68/02
-748/01-68/03
-748/01-210/02

91-040 857-21  



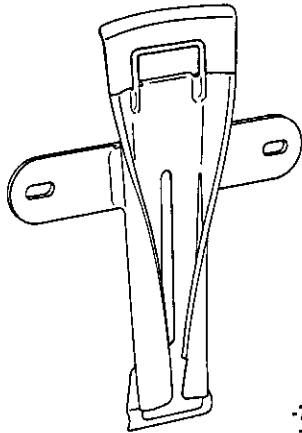

-748/01-67/02
-748/01-67/03

91-041 216-23  



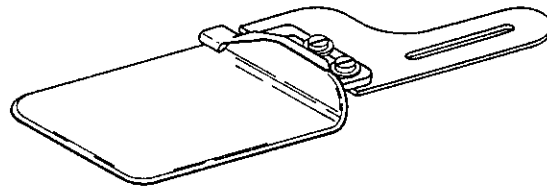

-748/01-67/03
-748/01-68/03

91-041 906-23  



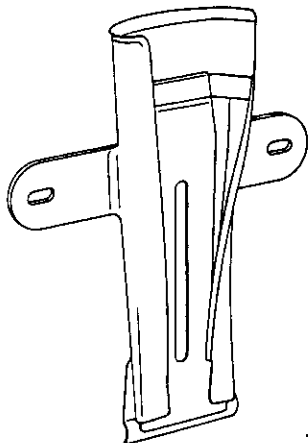

-748/01-67/04
-748/01-67/12
-748/01-82/02

91-045 776-23  





-748/01-67/02
-748/01-68/02

91-000 521-25 

91-028 036-25 

 91-000 521-25

 91-028 036-25

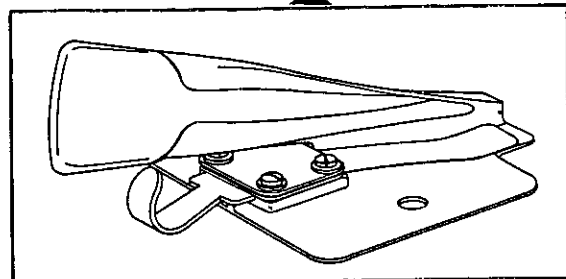

91-053 414-23  





-732/09-273/01 (-900/..)

**Nähwerkzeuge
Gauge parts**

**Organes de couture
Organos de costura**

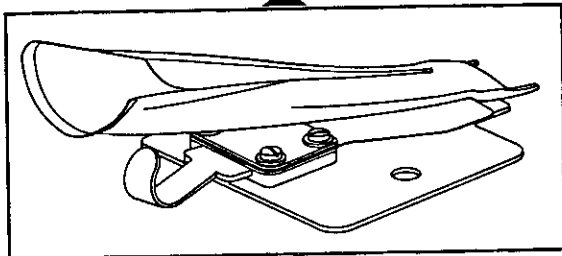

91-000 521-25  91-000 521-25
91-028 036-25  91-028 036-25

91-053 732-93  





-732/09-263/02 (-900/..)

91-000 521-25  91-000 521-25
91-028 036-25  91-028 036-25

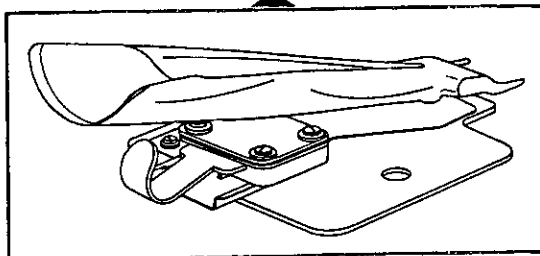
91-053 736-23  



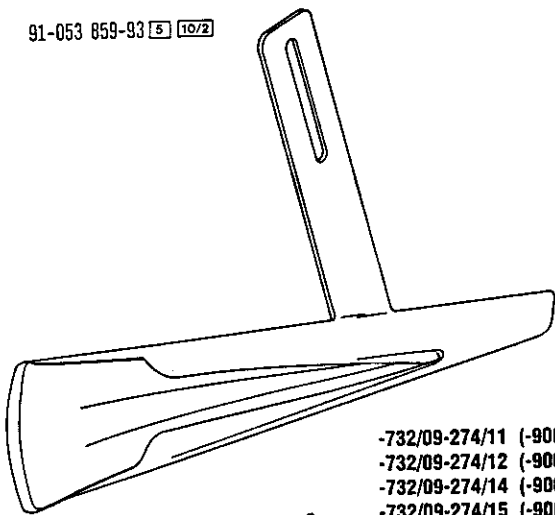

-732/09-363/02 (-900/..)

91-053 859-93  



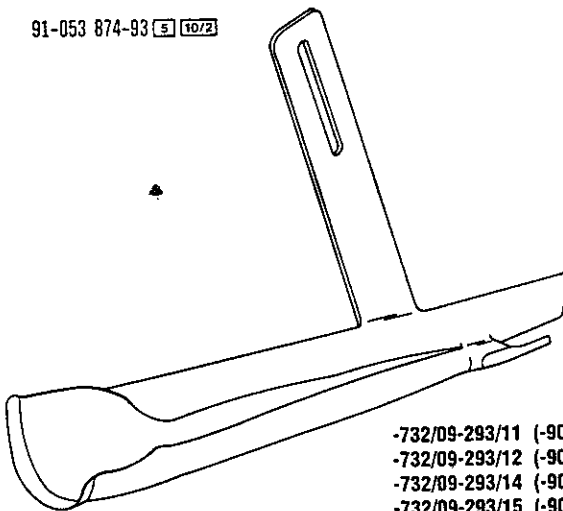

-732/09-274/11 (-900/..)
-732/09-274/12 (-900/..)
-732/09-274/14 (-900/..)
-732/09-274/15 (-900/..)

91-053 874-93  



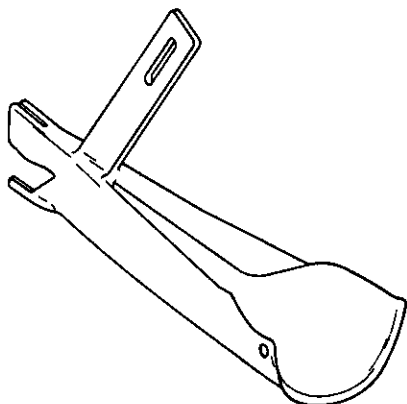

-732/09-293/11 (-900/..)
-732/09-293/12 (-900/..)
-732/09-293/14 (-900/..)
-732/09-293/15 (-900/..)

91-053 880-23  



-732/09-299/10 (-900/..)

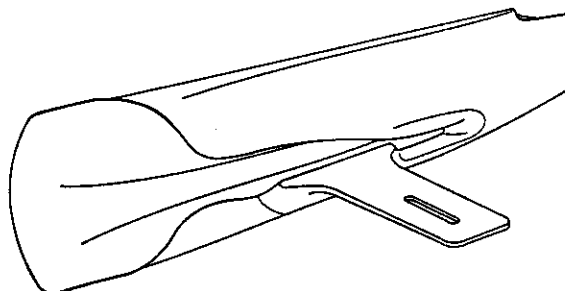

91-056 480-93  



-732/09-274/51 (-900/..)
-732/09-274/52 (-900/..)



Nähwerkzeuge
Gauge parts

Organes de couture
Organos de costura

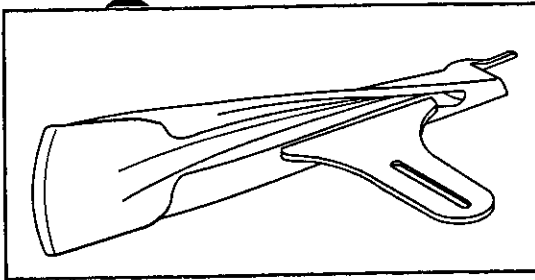
91-056 481-93  91-000 089-15 (2 x) 
12-315 110-15 (2 x) 



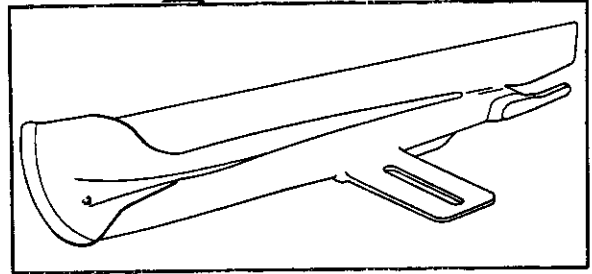

-732/09-273/50 (-900/..)

91-056 488-93  91-000 089-15 (2 x) 
12-315 110-15 (2 x) 





-732/09-293/51 (-900/..)
-732/09-293/52 (-900/..)

91-056 489-93 

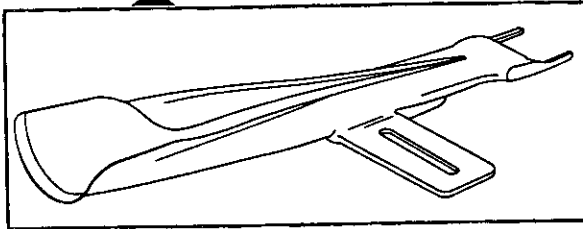
91-000 089-15 (2 x) 
12-315 110-15 (2 x) 



-732/09-263/50 (-900/..)

91-056 494-23  91-000 089-15 (2 x) 
12-315 110-15 (2 x) 

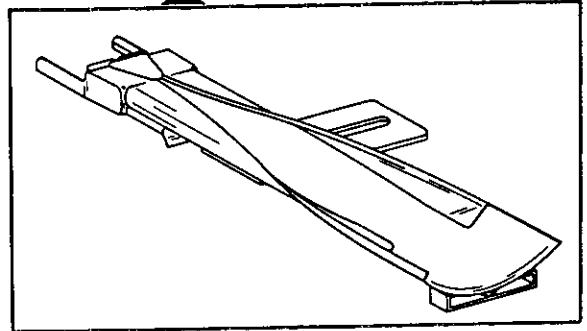

-732/09-363/50 (-900/..)

91-056 505-93 

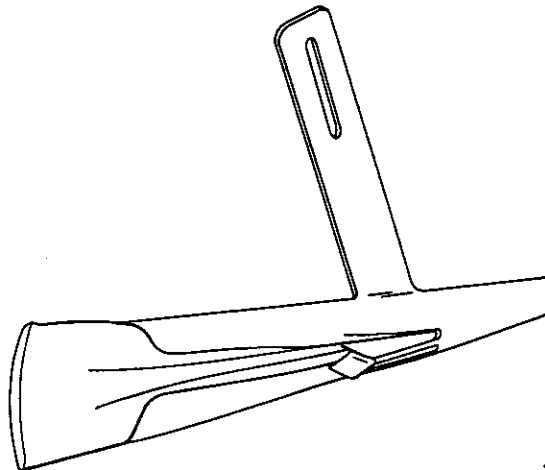

-732/09-274/16 (-900/..)

Nähwerkzeuge
Gauge parts

Organes de couture
Organos de costura

91-056 913-93 [S] [10/2]

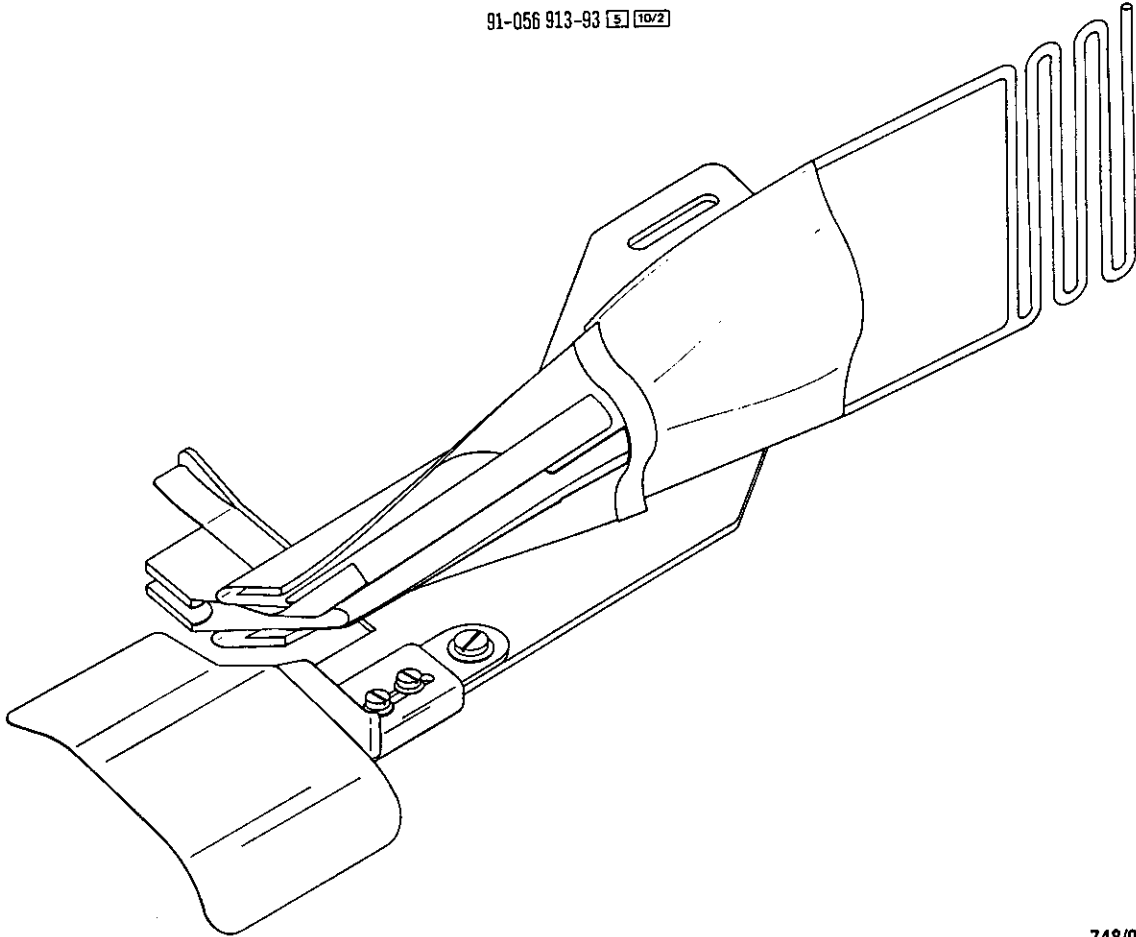

-748/01-39/61

91-156 118-23 [S] [10/2]

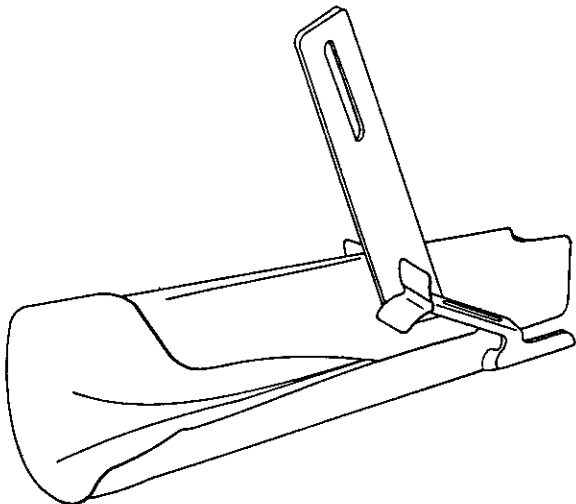

-732/09-393/11 (-900/..)
-732/09-393/12 (-900/..)

91-156 120-23 [S] [10/2]

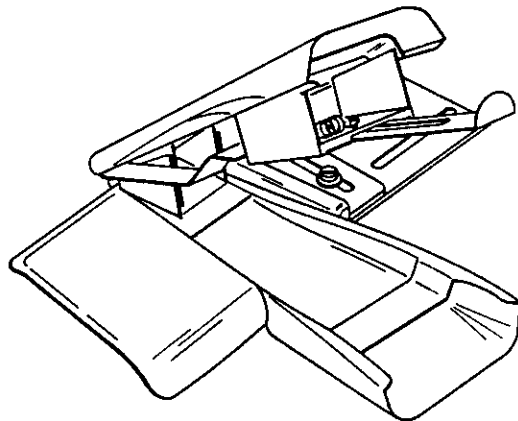

-748/01-68/22

Nähwerkzeuge
Gauge parts

Organes de couture
Organos de costura

91-156 121-93 [5] [10/2]

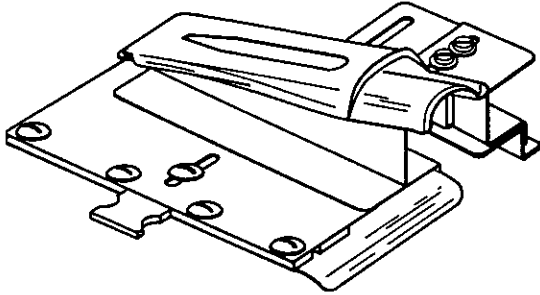

-748/01-211/02

91-461 314-23 [5] [10/2]

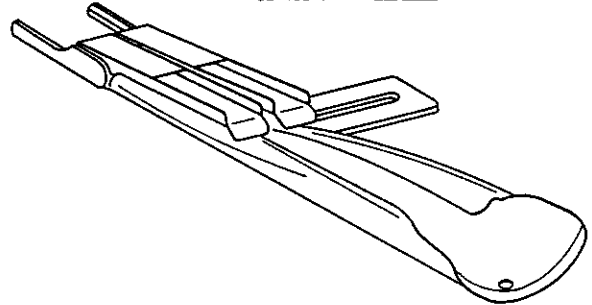

-732/09-364/50 (-900/..)

99-117 636-23 x 25 [5] [10/2]

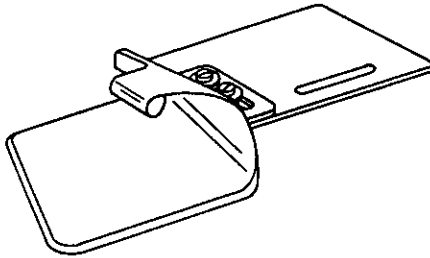

-748/24-82/99-918/04

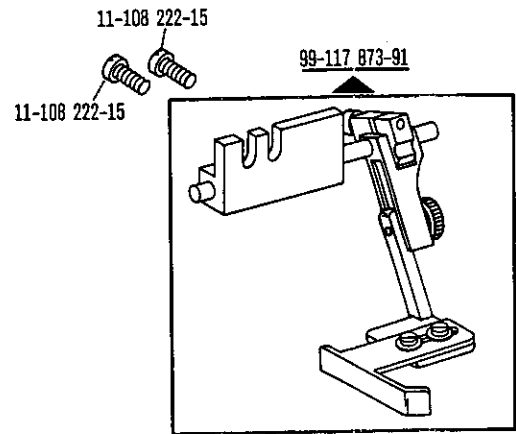

-720/02-113/13
-720/02-113/13-900/..

91-043 408-23 [5] [10/2]

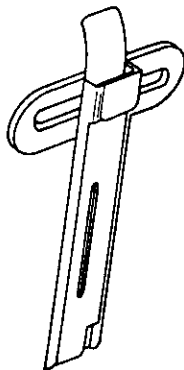

-61/02
-61/02-900/..
-748/01-61/02
-748/01-82/02
-748/01-210/02
-748/24-82/99-918/04

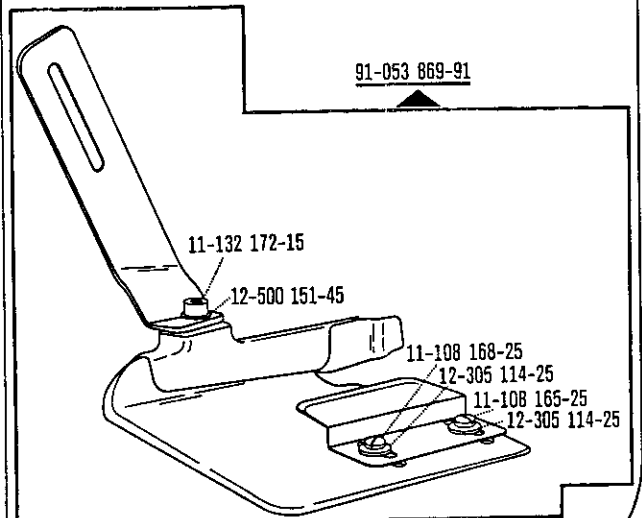

-732/09-274/14 (-900/..)
-732/09-274/15 (-900/..)
-732/09-293/14 (-900/..)
-732/09-293/15 (-900/..)

Nähwerkzeuge
Gauge parts

Organes de couture
Organos de costura

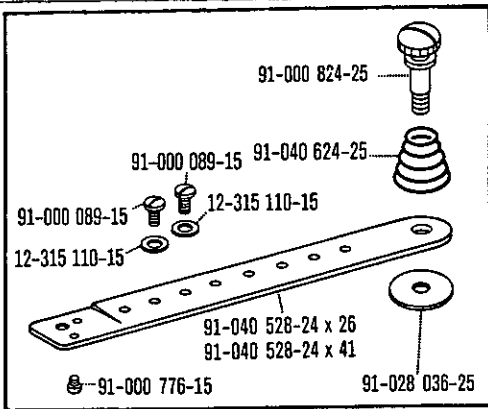

91-040 528-90

- 748/01-39/61
- 748/01-67/02
- 748/01-67/03
- 748/01-67/04
- 748/01-67/12
- 748/01-68/02
- 748/01-68/03
- 748/01-82/02
- 748/01-210/02

- 732/09-263/50 (-900/..)
- 732/09-273/50 (-900/..)
- 732/09-274/51 (-900/..)
- 732/09-274/52 (-900/..)
- 732/09-293/51 (-900/..)
- 732/09-293/52 (-900/..)
- 732/09-363/50 (-900/..)
- 732/09-364/50 (-900/..)

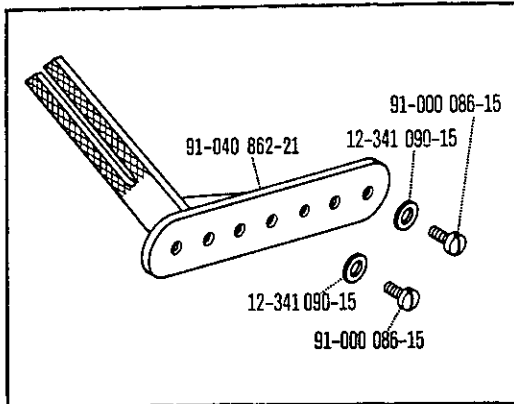

91-040 862-90

- 61/02
- 61/02-900/..
- 748/01-61/02
- 748/01-67/02
- 748/01-67/03
- 748/01-67/04
- 748/01-68/02
- 748/01-68/03
- 748/01-82/09
- 748/01-210/02
- 748/24-82/99-918/04

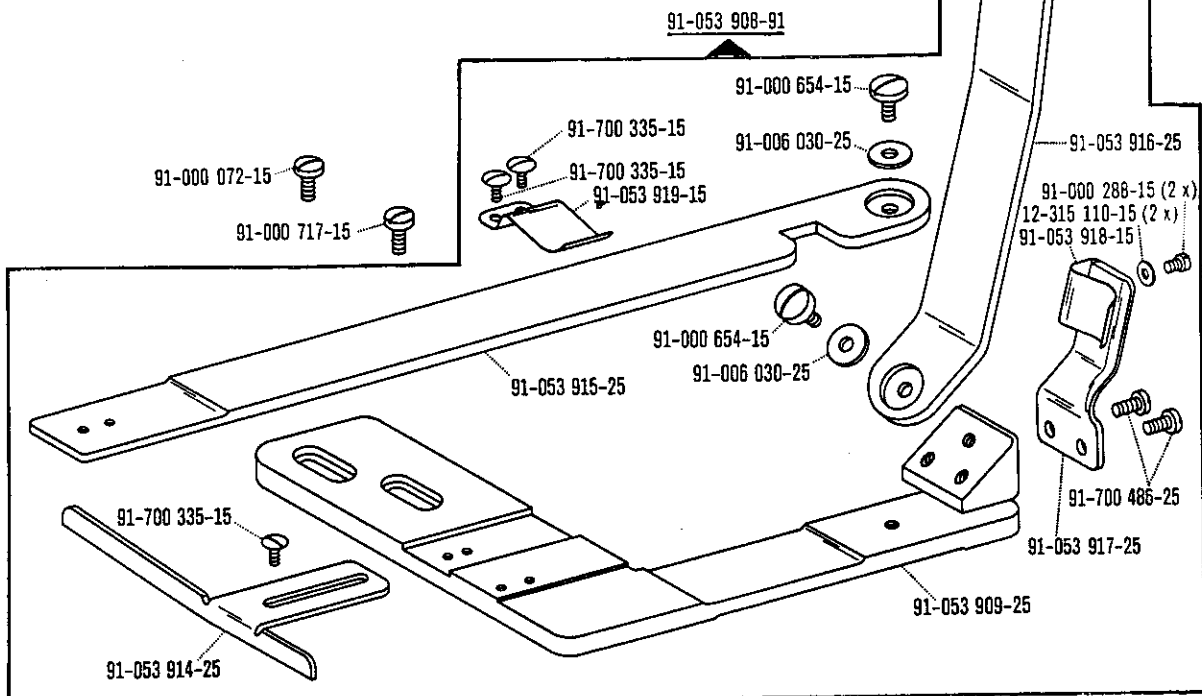

**Nähwerkzeuge
Gauge parts**

**Organes de couture
Organos de costura**

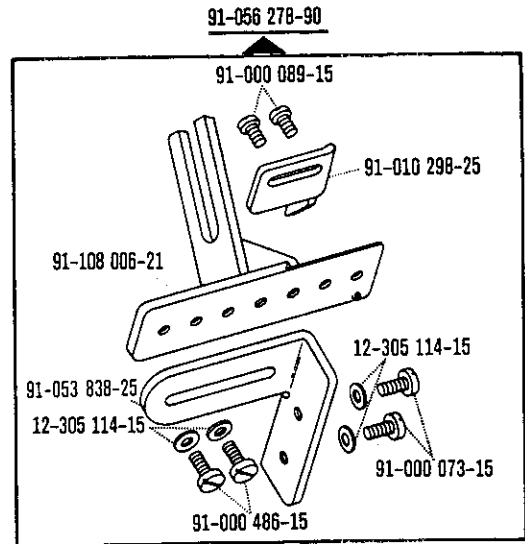
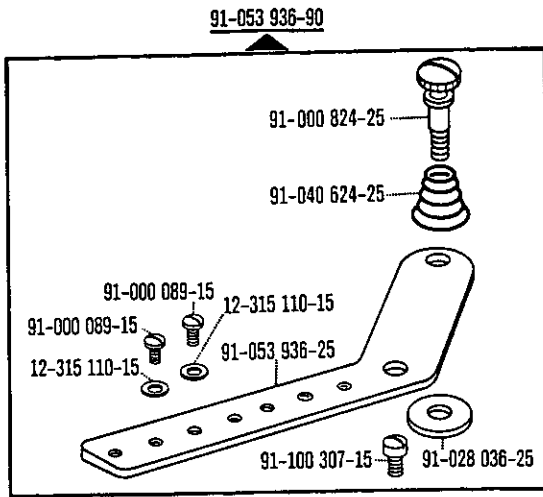

-748/01-68/22
-748/01-211/02
-748/24-82/99-918/04

-732/09-274/11 (-900/..)	-732/09-293/12 (-900/..)
-732/09-274/12 (-900/..)	-732/09-293/14 (-900/..)
-732/09-274/14 (-900/..)	-732/09-293/15 (-900/..)
-732/09-274/15 (-900/..)	-732/09-299/10 (-900/..)
-732/09-274/16 (-900/..)	-732/09-393/11 (-900/..)
-732/09-293/11 (-900/..)	-732/09-393/12 (-900/..)

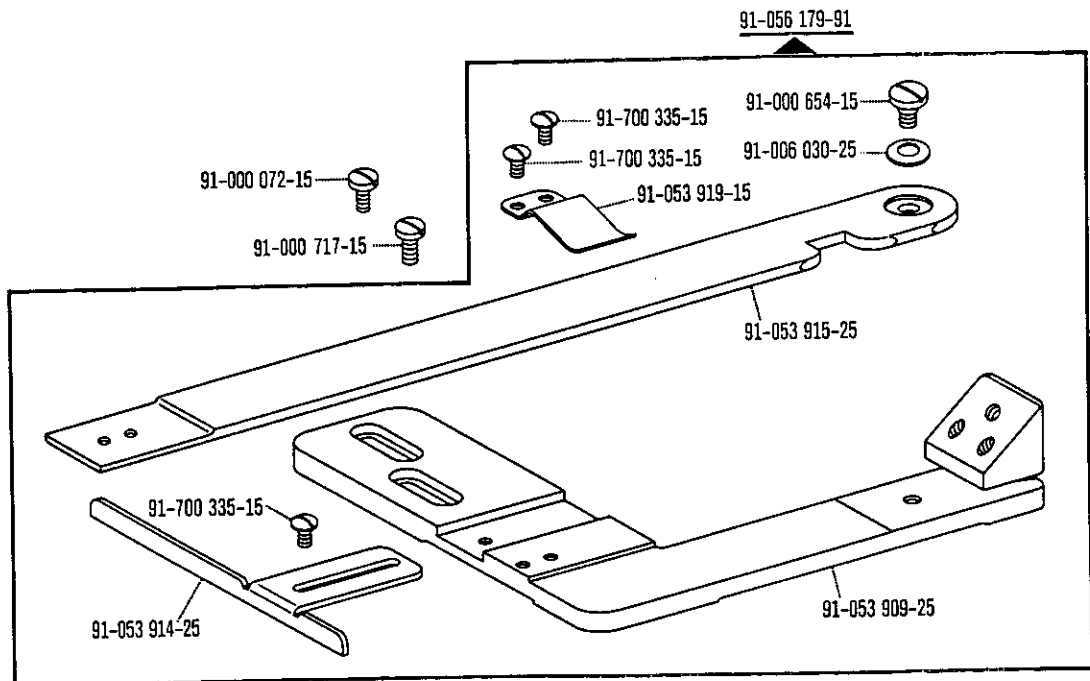

-732/09-263/50 (-900/..)	-732/09-293/51 (-900/..)
-732/09-273/50 (-900/..)	-732/09-293/52 (-900/..)
-732/09-274/51 (-900/..)	-732/09-363/50 (-900/..)
-732/09-274/52 (-900/..)	-732/09-364/50 (-900/..)

**Nähwerkzeuge
Gauge parts**

**Organes de couture
Organos de costura**

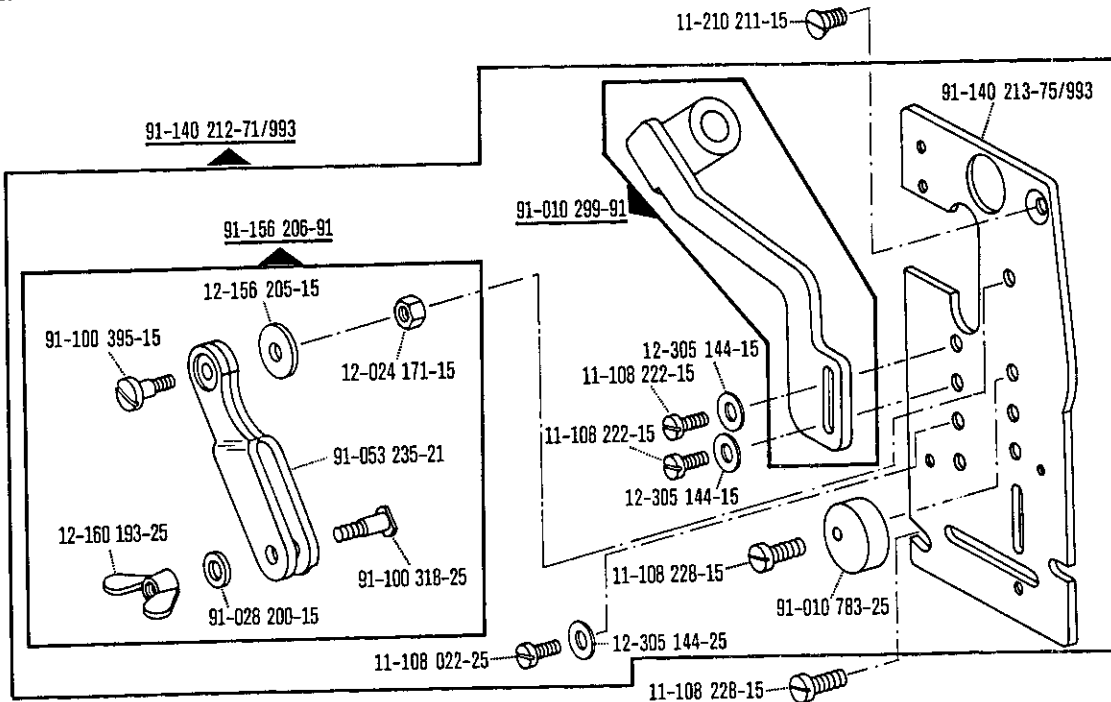

- | | | | |
|--------------------------|--------------------------|--------------------------|--------------------------|
| -732/09-274/11 (-900/..) | -732/09-274/15 (-900/..) | -732/09-293/12 (-900/..) | -732/09-299/10 (-900/..) |
| -732/09-274/12 (-900/..) | -732/09-274/16 (-900/..) | -732/09-293/14 (-900/..) | -732/09-393/11 (-900/..) |
| -732/09-274/14 (-900/..) | -732/09-293/11 (-900/..) | -732/09-293/15 (-900/..) | -732/09-393/12 (-900/..) |

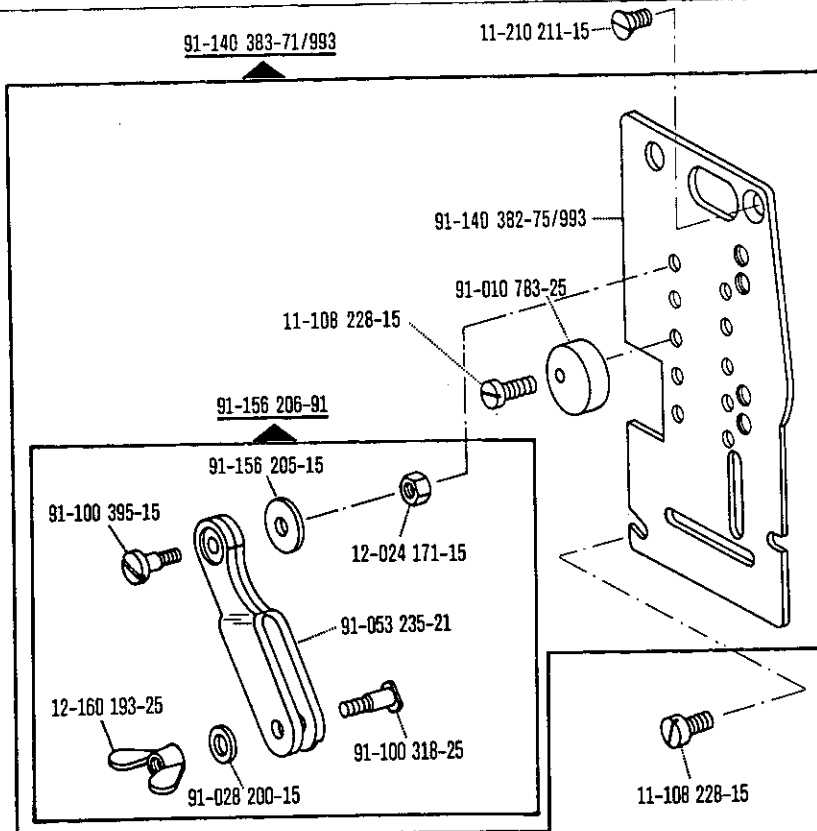

- 61/02
- 61/02-900/..
- 748/01-61/02
- 748/01-67/02
- 748/01-67/03
- 748/01-67/04
- 748/01-68/02
- 748/01-68/03
- 748/01-210/02
- 748/24-82/99-918/04

**Nähwerkzeuge
Gauge parts**

**Organes de couture
Organos de costura**

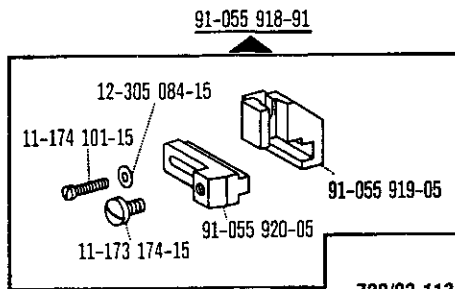
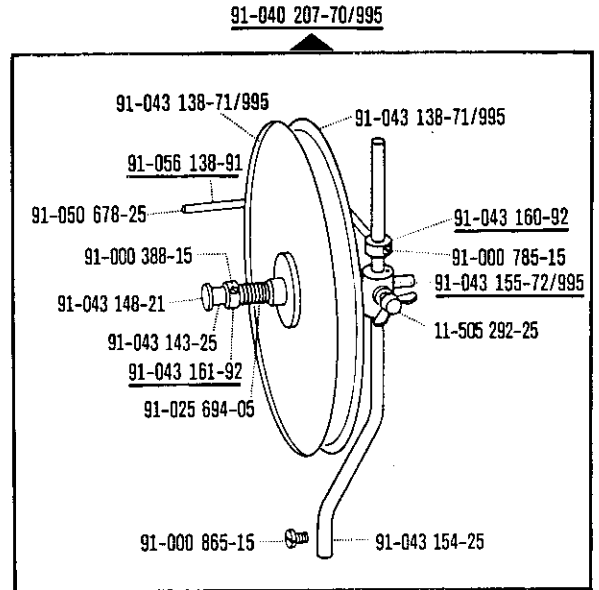
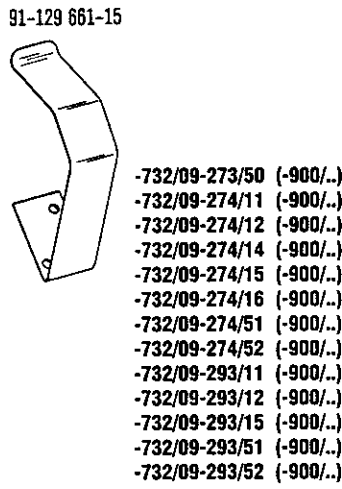
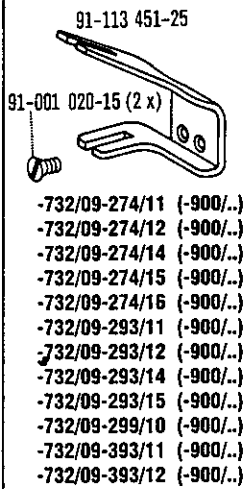

-720/02-113/13
-720/02-113/13-900/..
-720/02-113/33
-720/02-113/33-900/..

-720/02-6/01
-720/02-6/01-900/..

-748/01-61/02
-748/01-67/04
-748/01-67/12
-748/01-82/02
-748/01-210/02
-61/02
-61/02-900/..
-748/01-211/02

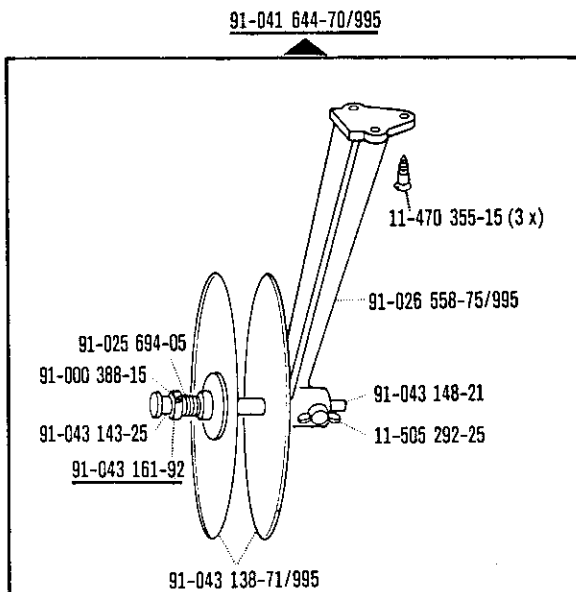

-748/01-210/02
-748/01-211/02

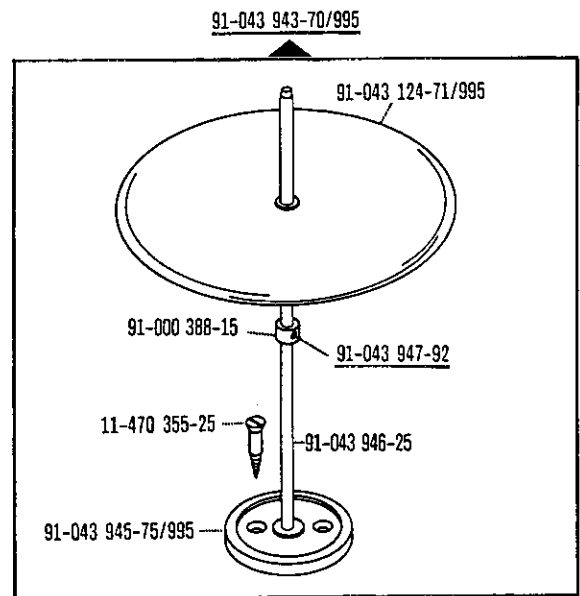

-748/01-39/61

Nähwerkzeuge
Gauge parts

Organes de couture
Organos de costura

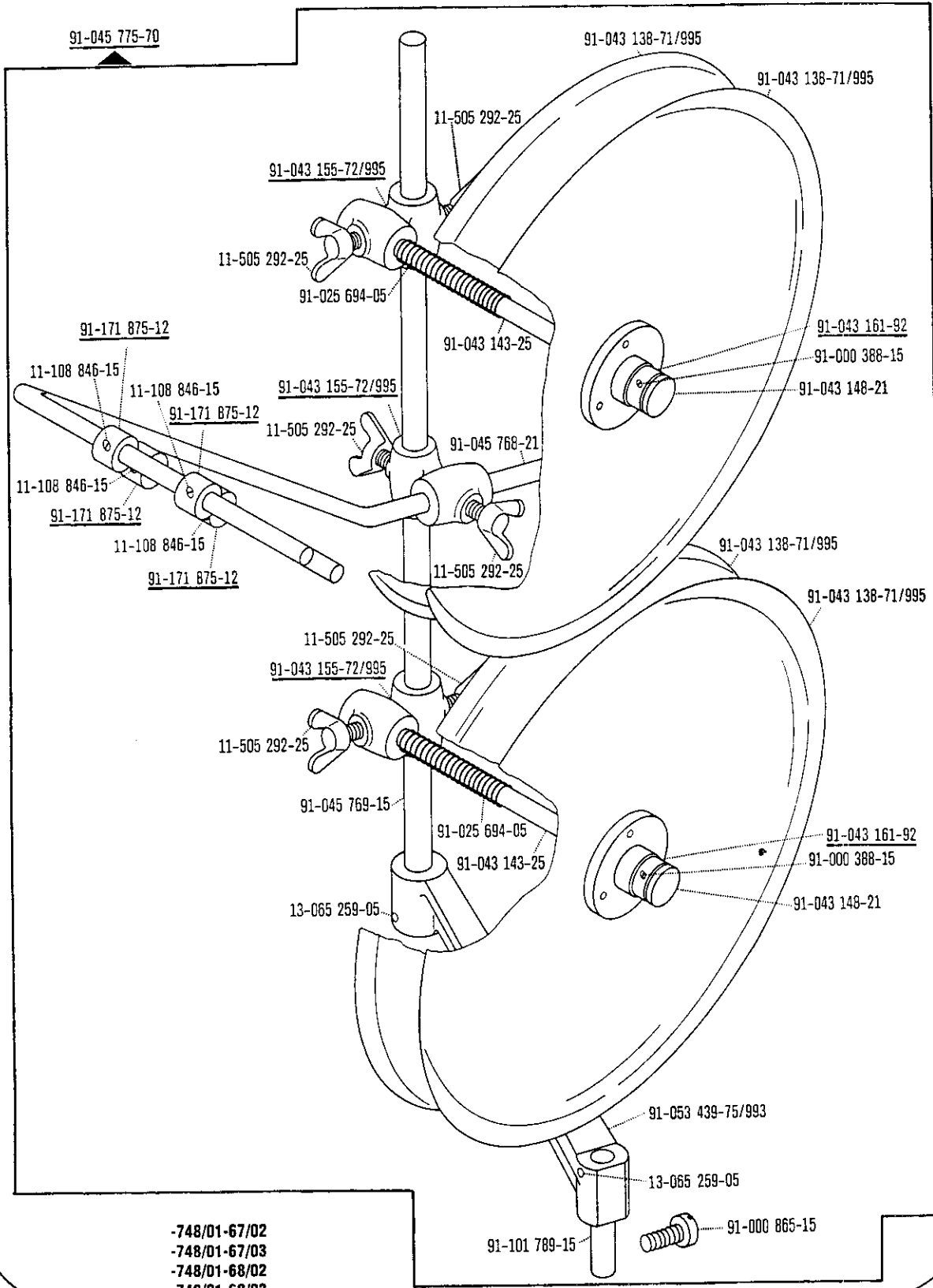

-748/D1-67/02
-748/D1-67/03
-748/D1-68/02
-748/D1-68/03

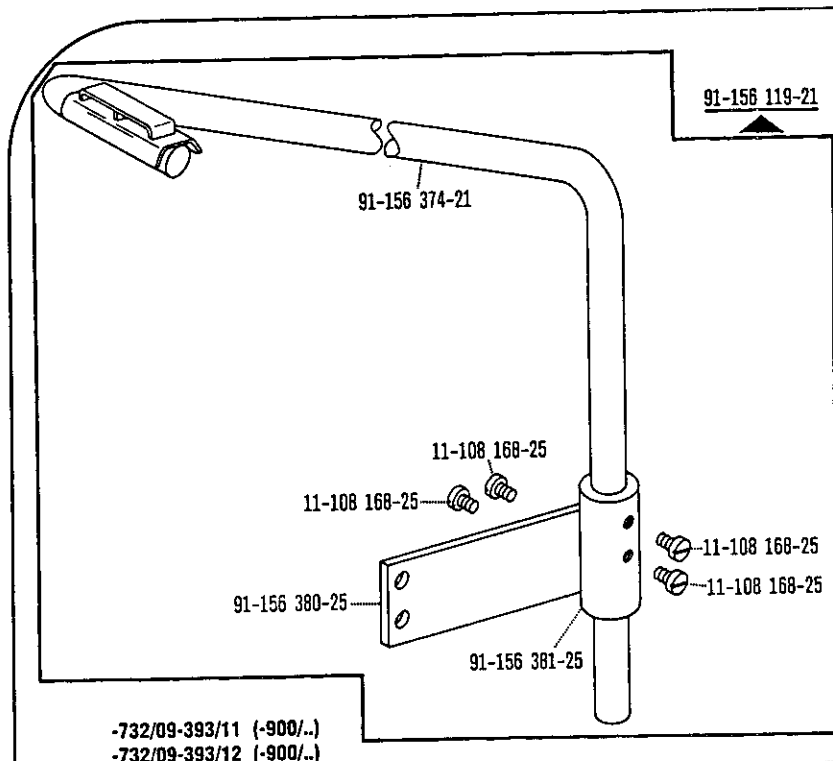

91-113 460-01

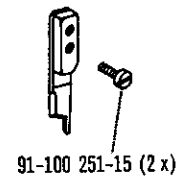

- 732/09-6/03 (-900/..)
- 732/09-263/02 (-900/..)
- 732/09-263/50 (-900/..)
- 732/09-273/01 (-900/..)
- 732/09-273/50 (-900/..)
- 732/09-274/11 (-900/..)
- 732/09-274/12 (-900/..)
- 732/09-274/14 (-900/..)
- 732/09-274/15 (-900/..)
- 732/09-274/16 (-900/..)
- 732/09-274/51 (-900/..)
- 732/09-274/52 (-900/..)
- 732/09-293/11 (-900/..)
- 732/09-293/12 (-900/..)
- 732/09-293/14 (-900/..)
- 732/09-293/15 (-900/..)
- 732/09-293/51 (-900/..)
- 732/09-293/52 (-900/..)
- 732/09-299/10 (-900/..)
- 732/09-363/02 (-900/..)
- 732/09-363/50 (-900/..)
- 732/09-364/50 (-900/..)
- 732/09-393/11 (-900/..)
- 732/09-393/12 (-900/..)

