

MODEL **LZ-271**

HIGH SPEED, SINGLE NEEDLE,
EMBROIDERING
INDUSTRIAL SEWING MACHINES

INSTRUCTION BOOK

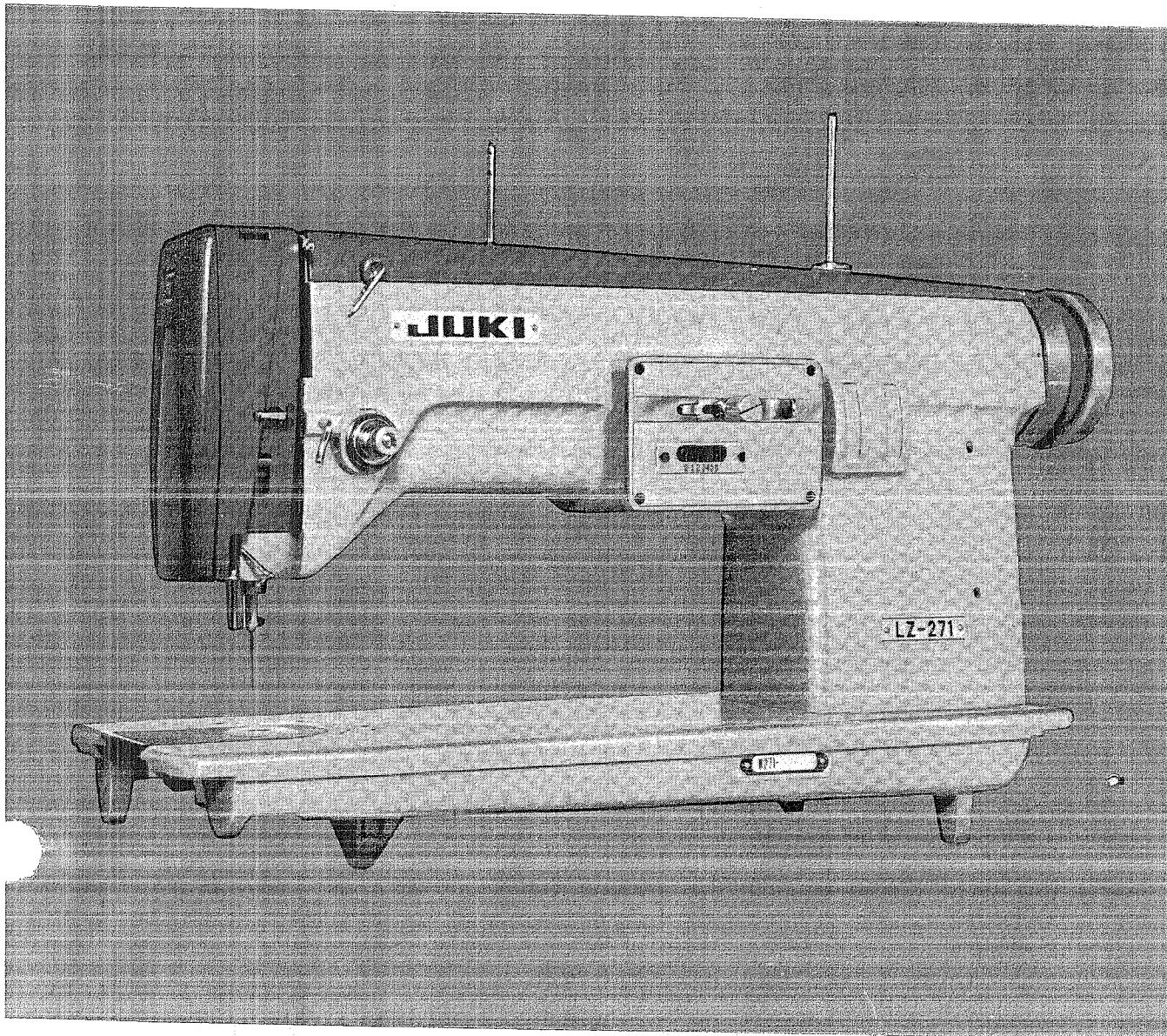

TOKYO JUKI INDUSTRIAL CO., LTD.

CONTENTS

I. GENERAL DESCRIPTION

1	Special features	1
2	Names of parts	2
3	Sewing speed	3
4	Installing the machine	3
5	Bobbin winder spool pin	4
6	Specifications	5

II HOW TO OPERATE THE MACHINE

1	Lubrication	6
2	Oiling the rotary hook	6
3	Needles	7
4	Threading the machine	8
5	Winding the bobbin thread	9
6	Inserting the bobbin into the bobbin case	10
7	Fixing the zigzag width of throw	10
8	Embroidering with a fixed zigzag width of throw	12
9	How to set up the embroidering hoop	12
10	How to embroider	13
11	The thread tension	13
12	When the thread breaks	14
13	How to use the attachments	15

III ADJUSTMENT OF STITCHING

1	Timing and adjustment of needle throw	17
2	Adjusting the correct position of the needle throw	17
3	Matching the rotary hook with the needle	19

I. GENERAL DESCRIPTION

1. Special features

This is a high speed industrial sewing machine for embroidering. With a speed of 1,700 stitches per minute, it can produce a width of throw of 12m/m (15/32") but if the machine is used at 10m/m (25/64") width of throw, it can embroider at a fast speed of 2,000 stitches per minute.

This machine can, not only embroider designs on light weight or heavy weight materials, but it can also embroider names and all kinds of marks to produce attractive and inviting embroidered work.

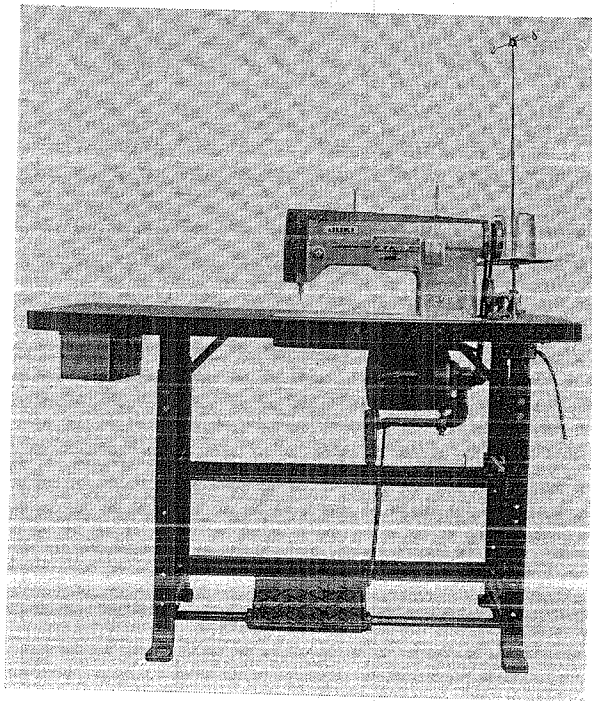

Fig. 1 Complete View

The design of this machine is of beautiful two-color tone and as the lubrication is of a centralized system, it is not necessary to oil the parts at each instance. Also, as the presser bar is of joint rod system, it is not to push the presser bar up or down when installing an attachment.

2. Names of parts

Refer to Fig. 2 for the names of parts of this machine

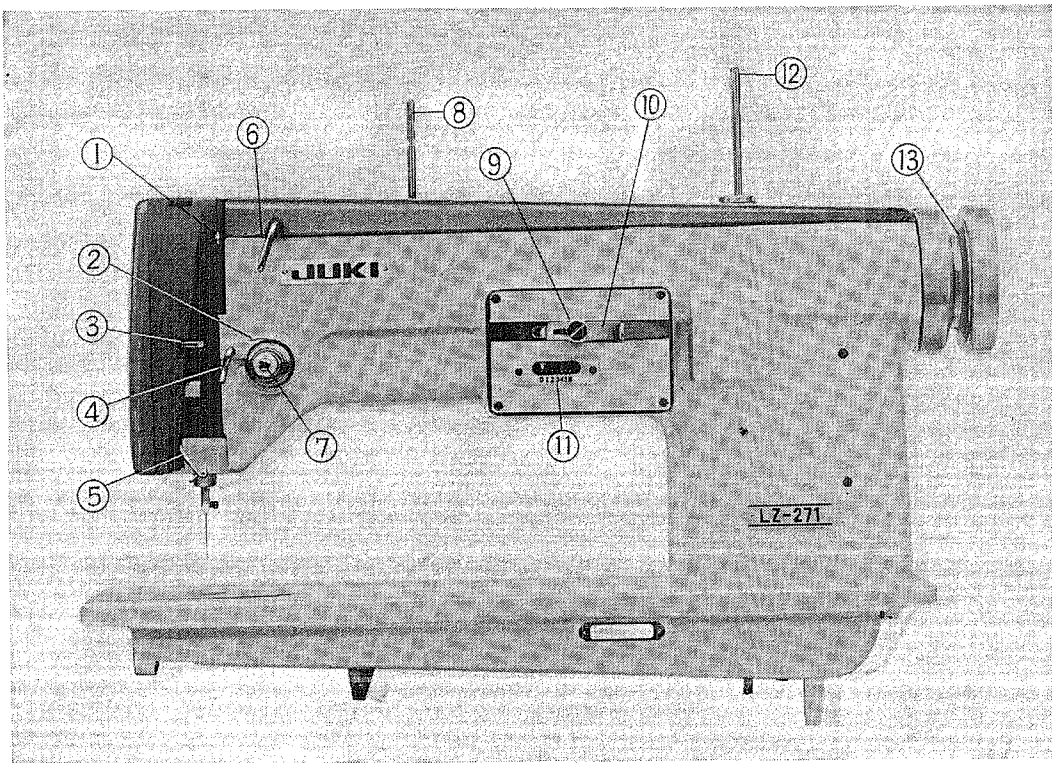

Fig. 2

- | | |
|--------------------------------|---------------------------------|
| ① Link take-up | ② Take-up spring |
| ③ Frame thread guide, upper | ④ Thread take-up guide |
| ⑤ Frame thread guide, lower | ⑥ Three-hole thread eyelet |
| ⑦ Tension disc | ⑧ Needle thread guide pin |
| ⑨ Zigzag width regulating knob | ⑩ Zigzag width regulating lever |
| ⑪ Zigzag width graduator | ⑫ Bobbin winder spool pin |
| ⑬ Hand wheel | |

3. Sewing speed

As previously mentioned, the speed of this machine at the maximum zigzag width of throw of 12m/m(15/32") is ,1700 stitches per minute and when the zigzag width is less than 10m/m(25/64"), it can embrioder at the speed of 2,000 stitches per minute.

The rotation of the machine determines the sewing speed. The number of rotation varies with the electric cycle (∞) and the diameter of the motor pulley. (Refer to Table)

Speed	Cycle	Motor pulley
1700	50∞	MTK-PO075000
	60∞	MTK-PO065000
2000	50∞	MTK-PO095000
	60∞	MTK-PV080000

Unless otherwise requested, this machine's motor pulley is of 1,700s.p.m. type but if a different speed is desired, please order our agents or exclusive dealers. The power of the clutch motor attached to this machine is a single phase 200 Watt (1/4HP), so to ensure a long life of this machine, it is highly recommended to use a motor pulley of 1,700s.p.m. speed.

4. Installing the machine

(A) Correct height

Install the machine on the table and shake the machine a little to see if it's uniformly even. When all the corners are even it should not move but if any one of the corners is uneven, it will rattle.

When it rattles, nail in a thin felt cushion pad B (B-8208-012-000) (four of which are in the accessories box together with nails), under the low corner and make the height even. Be sure to nail in the head of the nail deep inside the pad until it sinks into it.

Unless the height of the machine is installed evenly, it will not rotate

quietly.

(B) Leather belt

Normally, this machine uses a leather belt, but following should be observed:

(1) Should not be too tight. At first, the leather belt is very stiff, so often it is liable to be too tight. When it's too tight, the machine will vibrate.

(2) Joining of the belt. Normally, the belt is joined with a wire. When the joining is out of alignment or when the wire is sticking out, the machine cannot be run smoothly.

(3) Positions of hand wheel and pulley. Unless the hand wheel and pulley are in correct positions, the belt might be curved or twisted, hampering the quiet running of the machine. In such cases, move the motor position and correct them.

5. Bobbin winder spool pin

For the convenience of packing, the needle thread guide pin and the bobbin winder spool pin are removed from the machine and packed separately in a vinyl bag.

The needle thread guide pin can be lightly tapped in and inserted. To install the bobbin winder spool pin, remove the top cover of the machine. Just loosen the screw at the top of the cover and it will come off. Then insert the bobbin winder spool pin from front, plug in the nut from rear and tighten it with a wrench. (Fig 4)

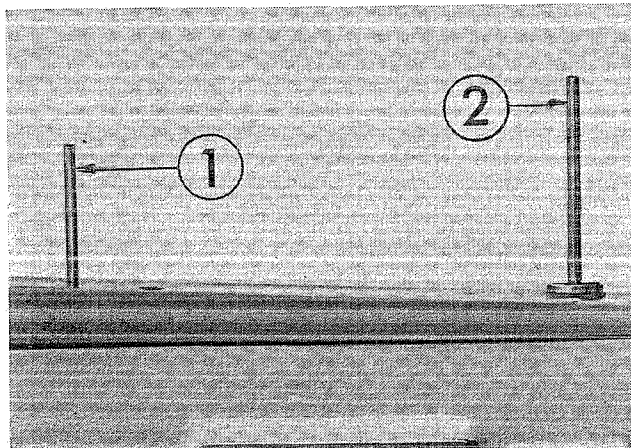

Fig. 3 ① Needle thread guide pin ② Bobbin winder spool pin

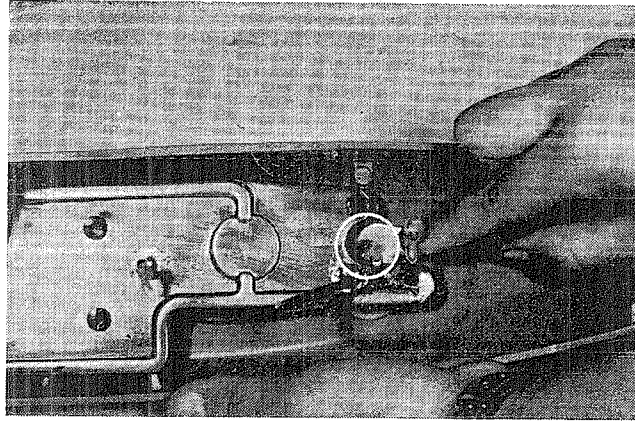

Fig. 4

6. SPECIFICATIONS

Model	Single needle, lockstitch, embroidering sewing machine
Sewing speed.....	Up to 2,000 s.p.m. (width of throw max. 10mm (25/64")) Standard 1,700 s.p.m.
Width of throw.....	0~12mm (15/32")
Needles	DB×1 #9~#18 (16×231, 1738) Standard #11
Lubrication	Centralized hand oiling type
Usage	Embroidering work on all light weight, medium heavy and heavy weight materials
Adjustment of width of throw	Adjusted by the knee lifter (without setting indicator of width graduation)
Attachments	Possible to install compass embroidering and cord embroidering attachments
Sewing space.....	270 mm (10—5/8") (From needle drop to the root of the arm)
Size of bed.....	178mm×477mm (7-1/64"×18-25/32")
Lubricating oil	New Defrix Oil No. 1

II. HOW TO OPERATE THE MACHINE

1. Lubrication

Lubricate the oil holes marked in red with New Defrix Oil No.1, 1 to 2 drops every day (Fig. 5). But to the holes ① ② ③ ④ ⑤ marked with heavy red mark, lubricate about 5 to 6 drops every day. There are oil reservoirs on these holes and from here all the essential parts are supplied with oil.

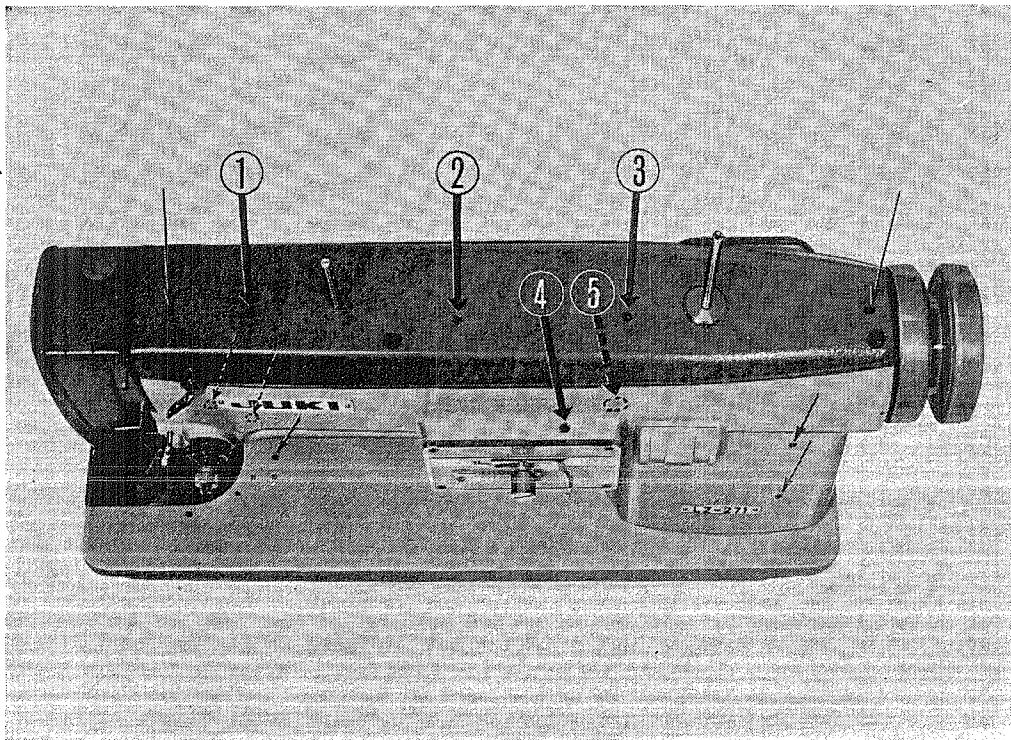

Fig. 5 Oiling holes

2 Oiling the rotary hook

Every day drop 1 or 2 drops of oil to the hook groove of the rotary hook shown by the arrow in Fig. 6. This oil soaks through the felt which is inside the hook and lubricates all the essential parts of the rotary hook.

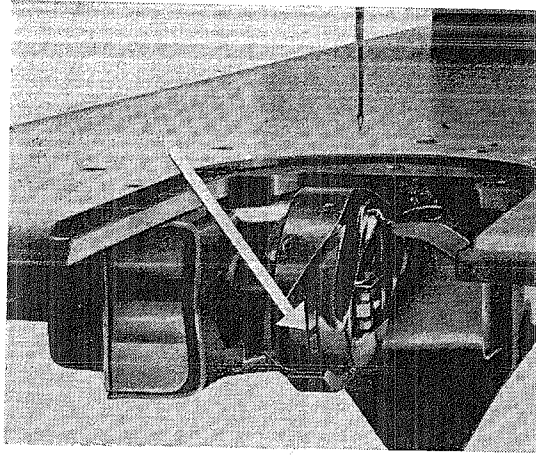

Fig. 6 Oiling spots of rotary hook

3. Needles

Select the needles according to the embroidering material and the needle thread. (Refer to Table).

In setting the needle, be sure that the carved part is on the other side and the grooved part of the needle is facing the operator. (Fig. 7)

Material		Needle	Needle thread
Light weight	Scarf Handkerchief Blouse	DB×1 (16×231) # 9—#11	Embroidering thread (Double-thread twist silk) #75—#120
Medium heavy	Velvet	DB×1 (16×231) #11—#14	Embroidering thread (Double-thread twist silk) #102
Heavy weight	Name mark	DB×1 (16—231) #11—#14	All color cotton thread #50
	Heavy weight	DB—1 (16×231) #14—#18	

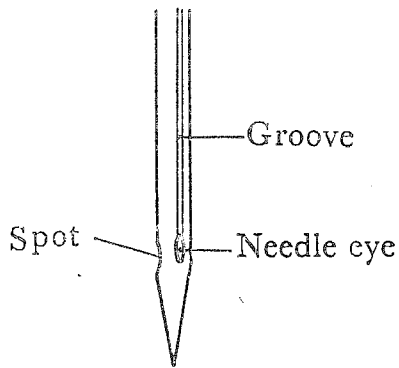
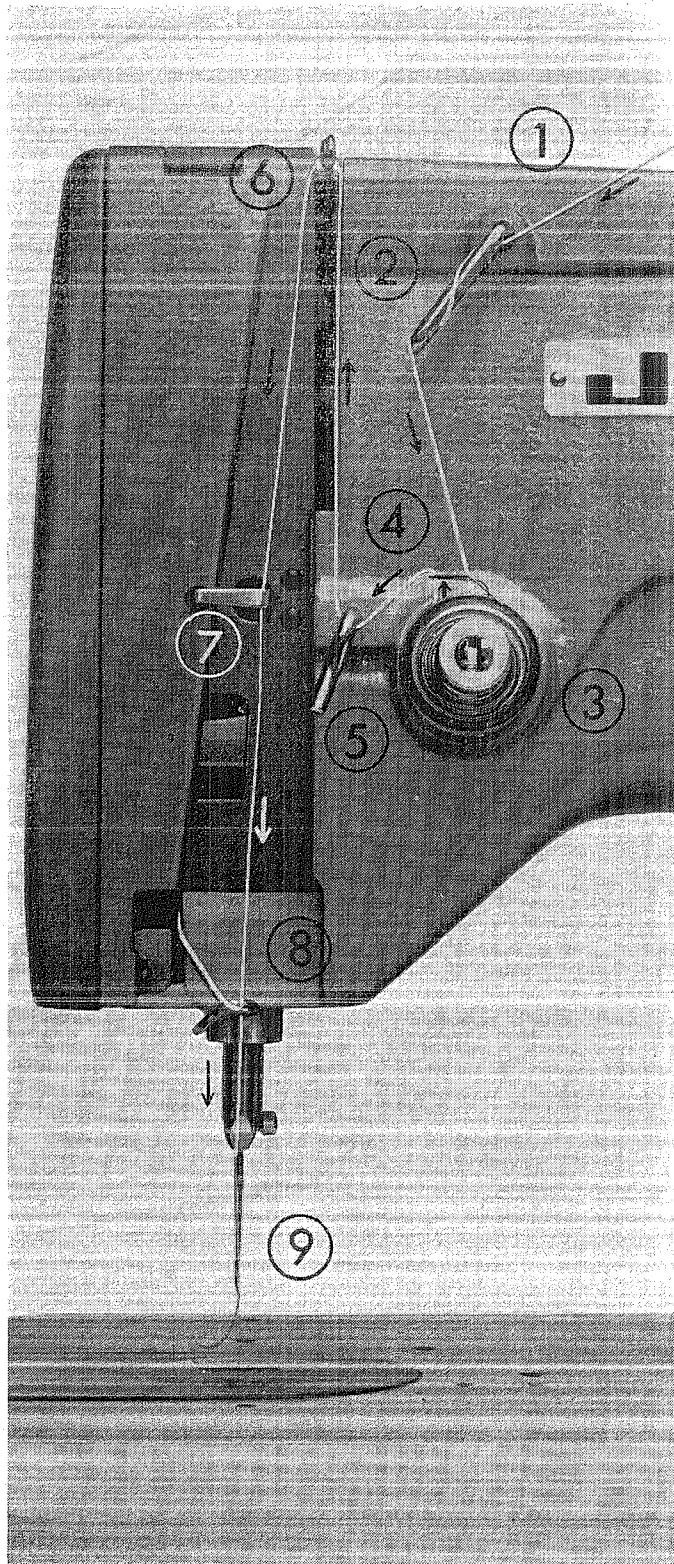

Fig. 7

4. Threading the machine

To pass the needle thread, follow the numerical order as shown in Fig. 8. Start from the needle thread guide pin ①, (not shown in Fig. 8), to the needle ⑨ in order. (Refer to Fig. 2 for complete view)



- ② Three-hole thread eyelet
- ③ Tension disc
- ④ Take-up spring
- ⑤ Thread take-up guide
- ⑥ Thread take-up
- ⑦ Frame thread guide, upper
- ⑧ Frame thread guide, lower
- ⑨ Needle

5. Winding the bobbin thread

As the wound condition of the bobbin thread greatly affects the sewing condition, be very careful on the amount wound, the method of winding and the tightness of the wound thread.

First, insert the bobbin deep into the bobbin winder shaft as far it goes (Fig. 9). Pull out the thread from the thread spool, pass it through the eyelet of the thread tension base, wind it from the opposite side of the 2 tension discs towards you (Fig. 10), and wind it 3~4 times around the bobbin from under (Fig. 11). If the trip latch is pressed down with your thumb, the bobbin winder will contact the belt (Fig. 12).

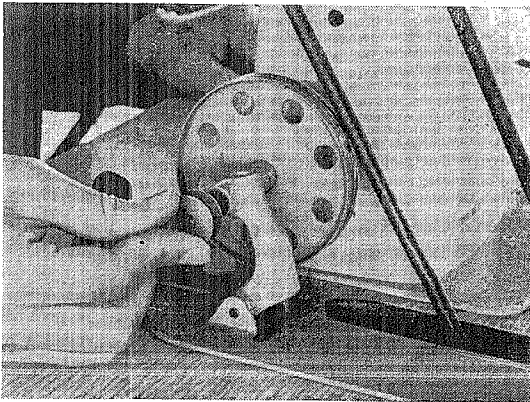

Fig. 9

Inserting bobbin to the winder shaft

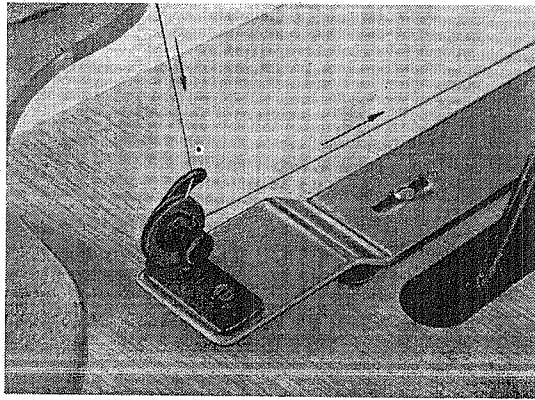

Fig. 10

Passing the bobbin thread

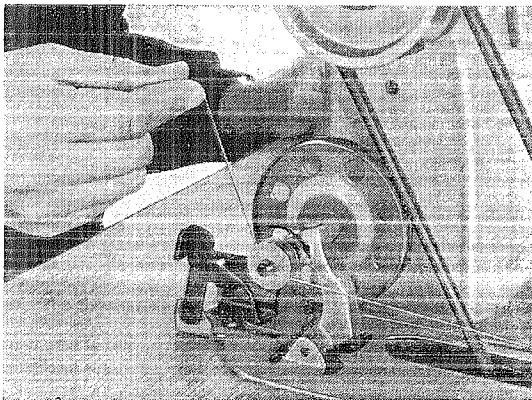

Fig. 11

Winding the bobbin

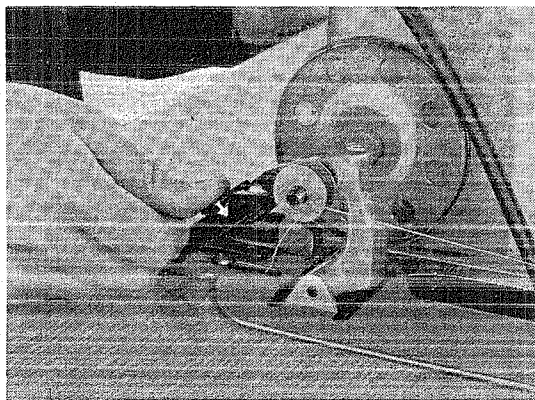

Fig. 12

Pressing down the trip latch

When the machine is rotated, and sufficient amount of thread is wound around the bobbin, the trip latch will be released and the winding is finished.

6. Inserting the bobbin into the bobbin case

Hold the wound bobbin between your thumb and forefinger of your right hand and, with the thread hanging down, insert it into the bobbin case. Next, pass the thread which is sticking out through the groove of the bobbin case, duck it under the thread tension spring of the bobbin case while pulling it, and finally pass it through the wire of the thread guide.

(Fig. 13)

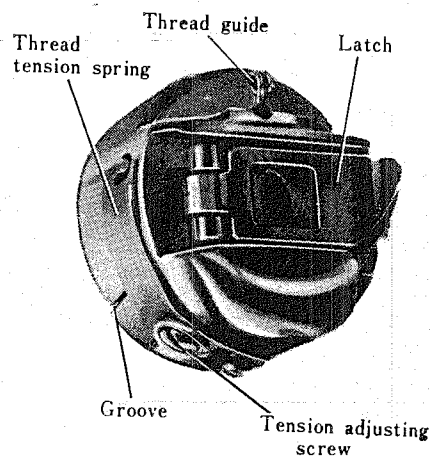

Fig. 13 Part names of the bobbin case

7. Fixing the zigzag width of throw

The zigzag width of throw of this embroidering machine can be regulated by the knee press as shown in Fig. 14. From your sitting position, make certain that the knee press smoothly contacts the tip of your right knee (Fig. 15).

If your knee is not correctly contacting the knee lifter, adjust it by loosening the screw ① Fig. 14.

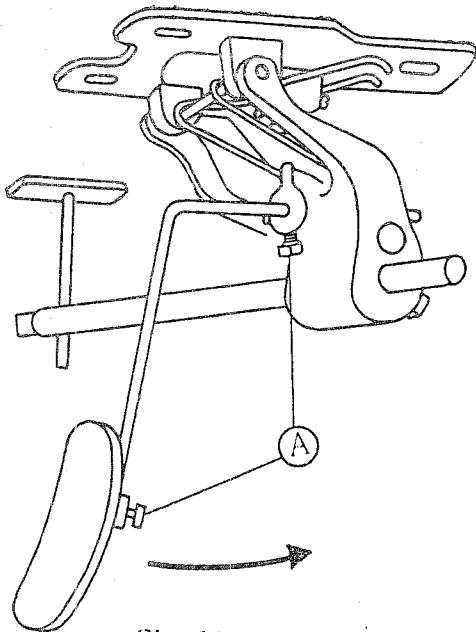

Fig. 14
Action of the knee press

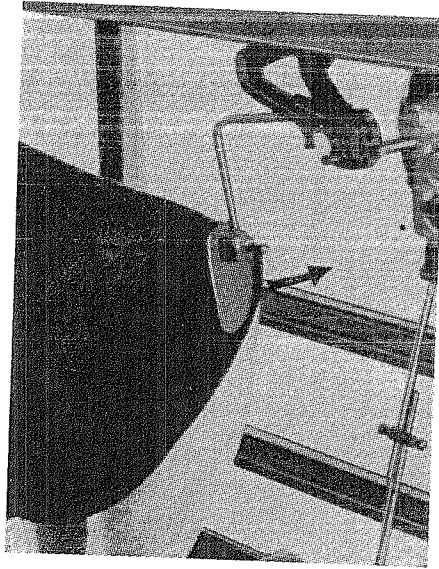

Fig. 15
Correct contacting position
of the knee press

Rotate the machine slowly and if the knee press is pressed with your knee, the needle will vibrate right to left and the embroidering can be proceeded. The more the knee press is pressed with your knee, the greater becomes the zigzag width of throw. (Fig. 16)

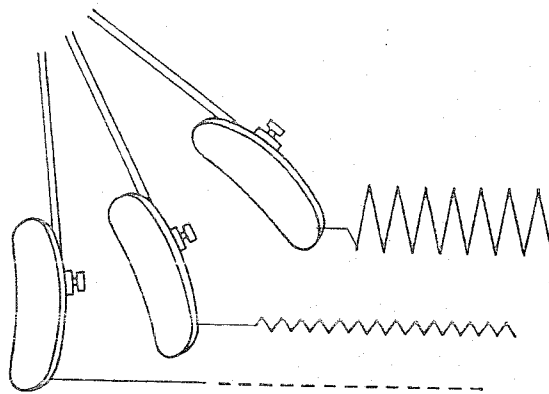

Fig. 16
Relation between the knee press and width of throw

8. Embroidering with a fixed zigzag width of throw

When you want to embroider with a definite, fixed zigzag width of throw, loosen the zigzag width regulating knob, pull the lever at the right of the knob, set the graduator at the width desired by moving the graduator with your knee and tighten the knob. This will set the graduator at the fixed width, so you can do a fixed width embroidering job without moving your knee. (Fig. 17)

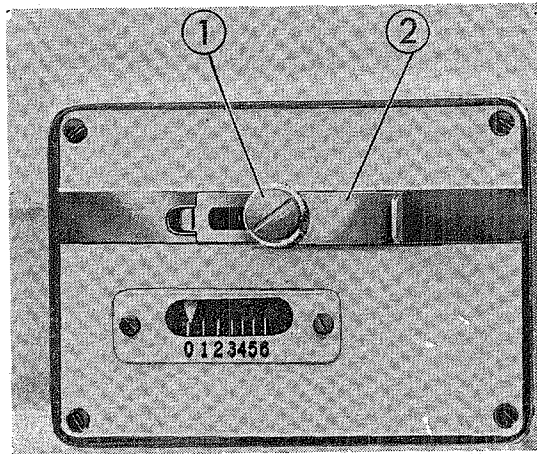

Fig. 17 ① Zigzag width regulating knob
② Zigzag width regulating lever

9. How to set up the embroidering hoop

It will be necessary to do all kinds of embroidering with various zigzag width of throw. So, in each instance, loosen the zigzag regulating knob and adjust the width to your liking.

Before starting the embroidering, the cloth must be stretched into the hoop. The stretched cloth inside the hoop should not be too loose or too tight but should be just right all around. If it's too loose, it might invite skip-stitching but if it's too taut on a light weight materials, the cloth might rip. So in such a case, attach a heavy cloth around the hoop together with the light weight material and pull this heavy weight material with the stretched light weight material.

10 How to embroider

Press down the cloth inside the hoop with your two hands and by setting the zigzag width with your knee, start embroidering. Be careful not to press down on the cloth too much but just enough to keep it down because if too much pressure is applied on your two hands, you cannot do a good embroidering job. Your knee action must harmonize with the movement of your hands to produce a flawless embroidering work.

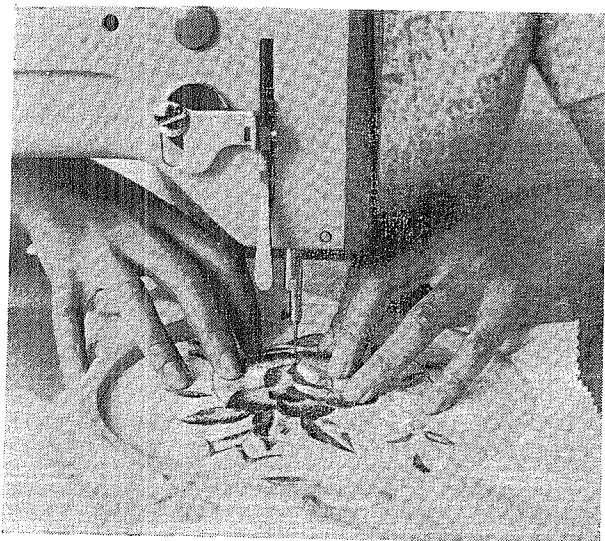

Fig. 18 How to embroider

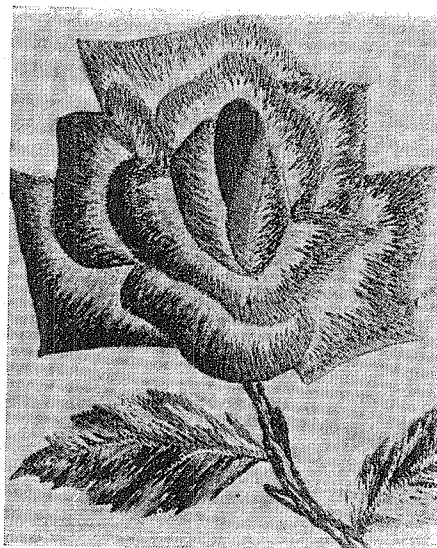

Fig. 19 Example of embroidering job

11 The thread tension

The upper thread tension and bobbin thread tension of this machine can be set independently of each other. The upper thread tension can be adjusted by the tension nut (Fig. 20) and the bobbin thread tension can be adjusted by the bobbin case thread tension screw (Fig. 13). Normally, the thread tension of the bobbin thread inside the bobbin case should be set and then the upper thread tension is fixed by the thread tension nut to obtain ideal tension. In an embroidering work, the thread tension should be adjusted so that the upper thread should come out on the back of the cloth, a

stitching process quite different than conventional stitching.

As shown in Fig. 21, it is considered to be ideal for the sewing width of the bobbin thread to be about 1/3 of the entire zigzag width. Try to leave the thread tension nut a little loose to obtain an ideal thread tension.

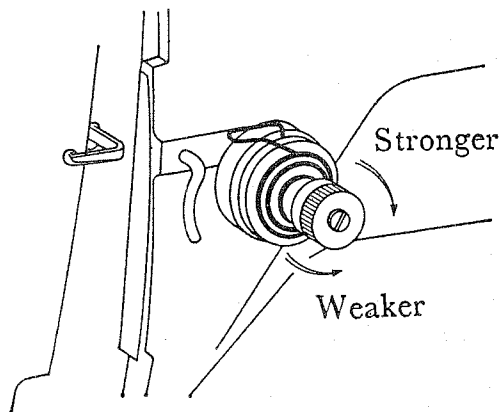

Fig. 20 Thread tension nut

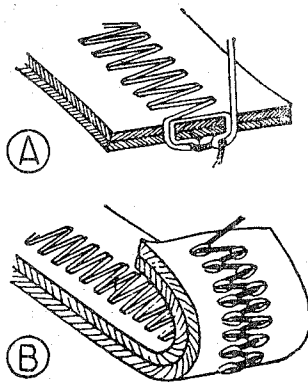

Fig. 21 Thread tension for embroidering

12 When the thread breaks

The embroidering thread is a fine thread, and even though it does not break on a fine, crisp day, on a rainy day or when the air is damp or when the humidity of the working compound is high, the breakage percentage is very high.

Besides these adverse conditions, when the machine is not handled right, the thread might break. Following are some of the mishandlings of the machine:

- A) When the passing of the needle thread is wrong or it's slipped out.
- B) The needle thread is not wound around the thread spindle.
- C) When the bobbin thread is all gone or when it's broken.
- D) When the rotary hook is installed wrong.

(When especially large size of needle is used, match the sewing hook to corresponding size.) (Refer to Chapter III-3 on "Timing the sewing hook with the needle")

- E) When the needle thread tension is too bad.
- F) When the needle is curved.
- G) When the deflector point of the sewing hook is bruised.
(Smooth out the bruise by some kind of paper)

13. How to use the attachments

(1) Compass

In embroidering a circular or semi-circular shape with a fixed zigzag width, use the compass (Fig. 23) and an accurate embroidering work can be made very easily. In this case, be sure to set the zigzag width with a definite width and then embroider. When this compass is used, due to the shortness of the presser bar, attach a presser bar joint rod B (B 1502-391-BAO Presser bar joint rod B) Fig. 22 (in the accessories box) to the presser bar and use it as shown in Fig. 23.

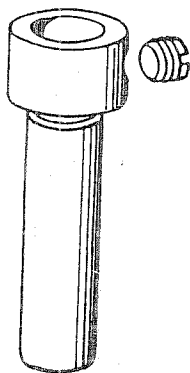

Fig. 22 Joint rod B

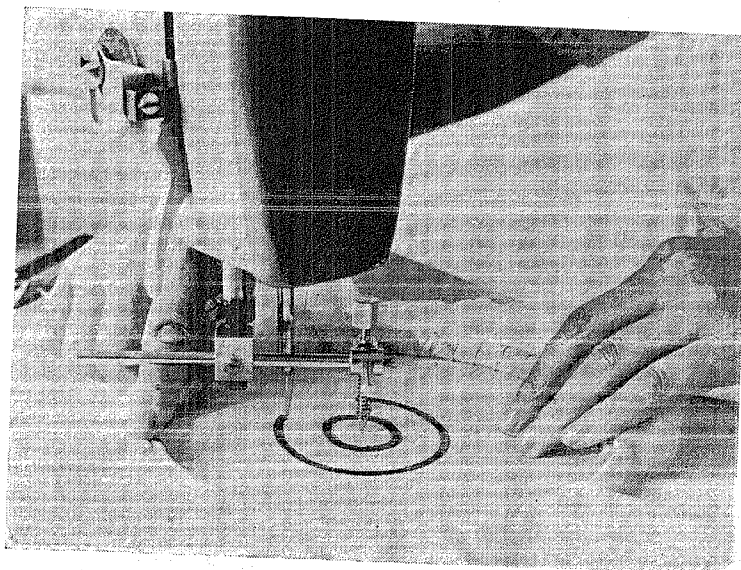

Fig. 23 How to use the compass

(2) Cord attachment

The embroidering type by which the drawn design is sewn by attaching the cord or yarn is called the cord attaching embroidering or embroidering with cord attachment. (Fig. 25, 26)

To do this type of embroidering, use the attachment shown in Fig. 24. In this case, too, attach the joint rod B to the presser bar and attach this attachment

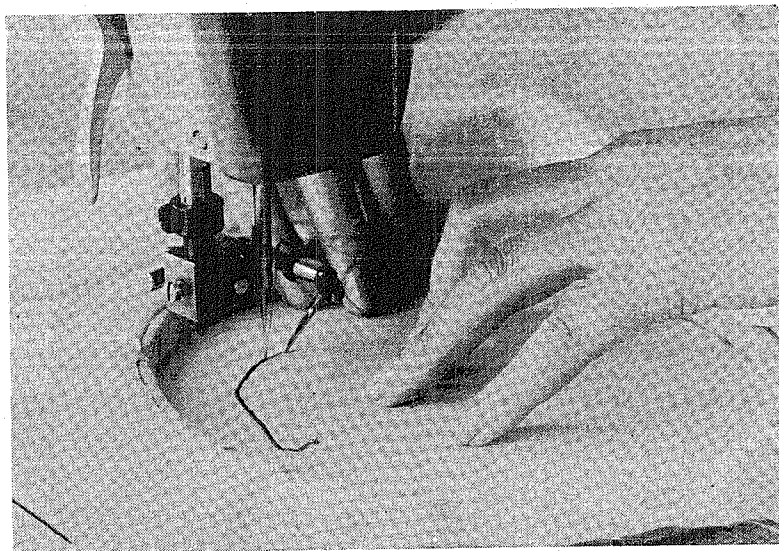
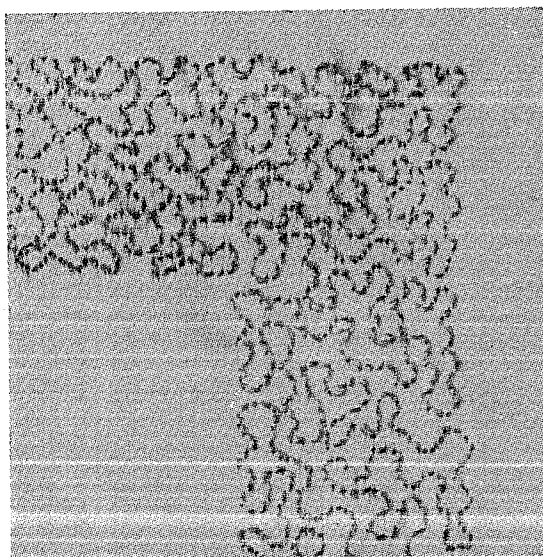

Fig. 24 How to use the cord attachment



Example of cord attachment embroidery work (A)

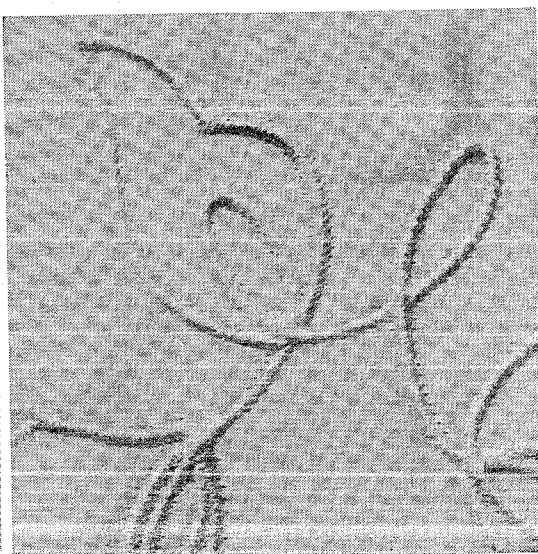

Fig. 26

Example of cord attachment embroidery work (B)

III. ADJUSTMENT OF STITCHING

1. Timing and adjustment of needle throw

As shown in Fig. 27, when the height of the right and left motion of the needle throw at the start of the throw and at the end of the throw is not same, the needle might "skip" because the needle throw movement is not ended even though the needle is piercing the cloth. Thus, the needle will tear the cloth and attractive sewn product cannot be obtained.

To obtain correct timing and adjustment of needle throwing, first remove the arm cover, loosen the set screw of the main shaft gear screw slightly, and as you watch the needle stitching, rotate the gear slightly and set the timing. After adjusting, be sure to tighten the set screw firmly.

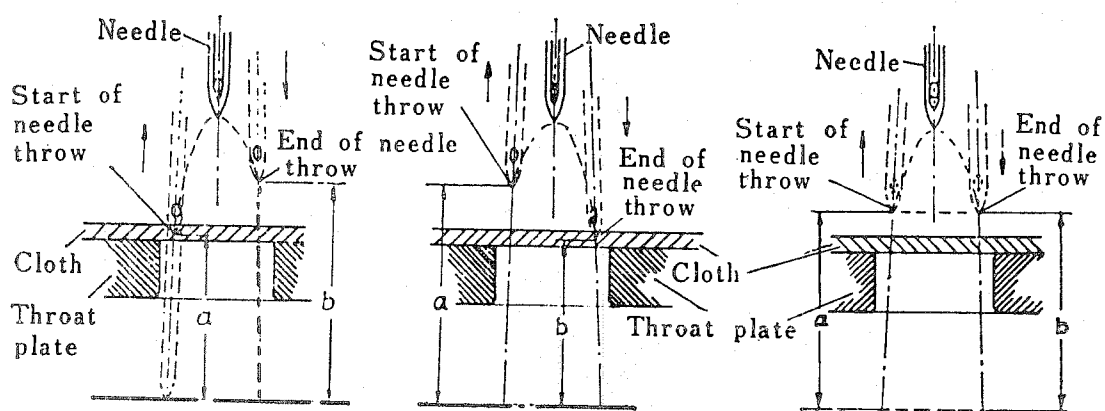

Fig. 27

2. Adjusting the correct position of the needle throw

The correct stitching of the needle throw is when the needle stitches evenly to the hole of the throat plate, not too much to the right or left, as it completes the throwing motion. (See © Fig. 28)

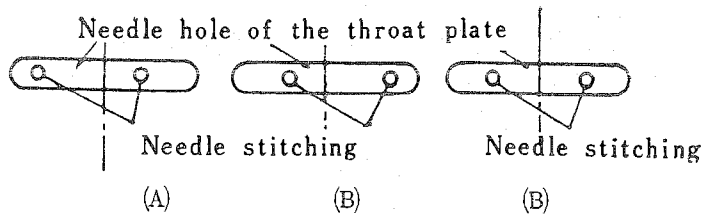

Fig. 25

To obtain this correct needle throwing position, remove the arm cover, loosen the set screw of the zigzag adjusting shaft bushing, and with a large spanner, rotate the flat part of the bushing which came outside and throw the needle to right or left as you rotate the hand wheel. Also, by setting it at 0 and by inserting a piece of paper and confirming the correct needle stitching position by watching the holes in the paper, adjust the needle throwing position. After the adjustment, firmly tighten the set screw and cover up the arm cover. The correct position of the needle throw is already set at the factory.

If the needle does not stitch into the center of the throat plate groove at the 0 position, remove the face plate, loosen the eccentric shaft set screw and as you rotate the eccentric shaft (Fig. 30 ①) with a screw driver, adjust the correct needle stitching position.

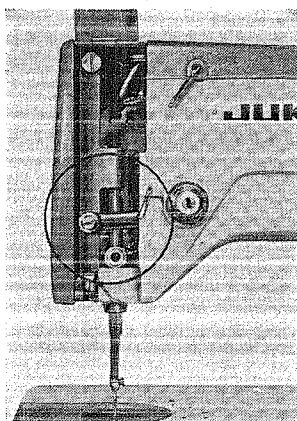

Fig. 29

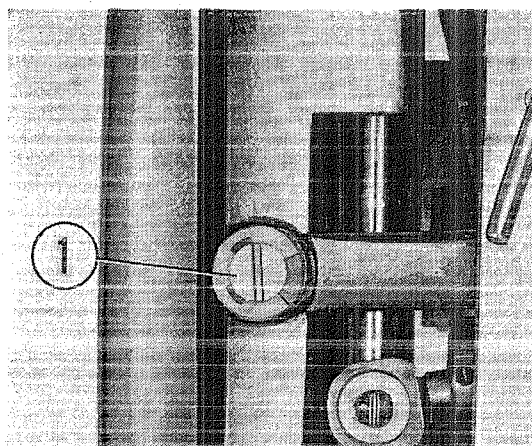

Fig. 30



3. Timing the sewing hook with the needle

If the timing of the sewing hook and the needle is not correct, skip-stitching or thread breakage may result.

To obtain this correct timing, first, rotate the hand wheel towards the operator, bring the red carved line of the hand wheel forward and match it with the red point of the machine head. (Fig. 31) (At this position, the needle will be at the raised position of 2.0mm (5/64") from the lowest position). Next, slightly loosen the 3 screws which are clamping the sewing hook and match the tip of the hook with the center of the needle.

The clearance between the needle and the tip of the sewing hook should be as close as possible as long as the hook does not contact the needle (0~0.05mm) and tighten the screws. (Fig. 32) To determine the height of the needle bar, push the knee lifter so that the width of throw becomes greatest. Rotate the hand wheel to make the needle drop to left side and rotate the hand wheel further until the left throwing needle and the tip of the sewing hook meet each other and stop the hand wheel.

At this position, set the height of the needle bar so that the tip of the sewing hook comes to the upper part of the needle eye of the left throwing needle. (Fig. 33)

If the needle bar moving shaft set screw is loosened, the needle bar will move up or down, so set the height of the needle bar by gently moving the needle bar up and down so that the tip of the sewing hook comes slightly above the needle eye. Then firmly tighten the screw. If the needle bar is lowered too much, it will hit the bobbin case and the needle might break and if it's raised too high, skip-stitching may result at the left side. Be extremely careful.

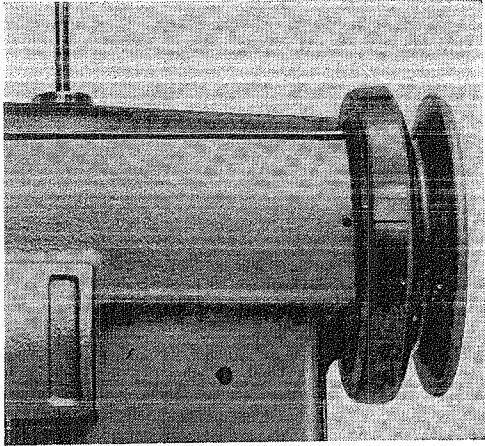

Fig. 31

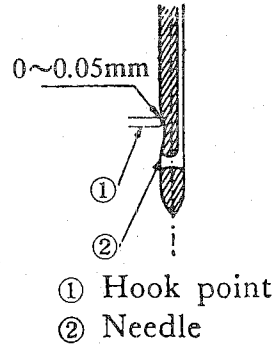

Fig. 32

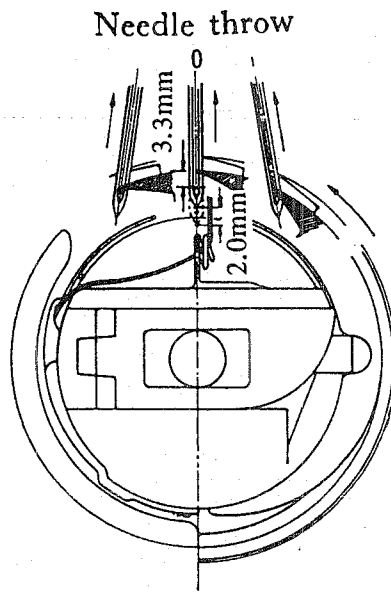
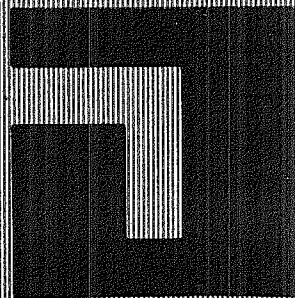

Fig. 33

CONVERSION TABLE

Milli Meter to Inch	Inch to Milli Meter
1 mm.....5/128"	1" 25.4 mm
1.5mm.....1/16" less 1/256"	1/2"..... 12.7 mm
2 mm.....1/16" plus 1/64"	1/4"..... 6.35 mm
2.5mm.....3/32" plus 1/256"	3/4"..... 19.05 mm
3 mm.....1/8" less 1/128"	1/8"..... 3.175 mm
3.5mm.....1/8" plus 3/256"	3/8"..... 9.525 mm
4 mm.....5/32"	5/8"..... 15.875mm
4.5mm.....5/32" plus 5/256"	7/8"..... 22.225mm
5 mm.....3/16" plus 1/128"	1/16" 1.5785mm
5.5mm.....7/32" less 1/256"	3/16" 4.7625mm
6 mm.....1/4" less 1/64"	5/16" 7.9375mm
6.5mm.....1/4" plus 1/256"	7/16" 11.125mm
7 mm.....1/4" plus 3/128"	9/16" 14.2875mm
7.5mm.....9/32" plus 3/256"	11/16"..... 17.4625mm
8 mm.....5/16"	13/16"..... 20.6375mm
8.5mm.....5/16" plus 5/256"	15/16"..... 23.8125mm
9 mm.....3/8" less 3/128"	1/32" 0.79375mm
9.5mm.....3/8" less 1/256"	1/64"..... 0.396875mm
10 mm.....3/8" plus 1/64"	1/128"..... 0.19844mm
11 mm.....7/16" less 1/128"	
12 mm... 15/32" plus 1/256"	
13 mm... 33/64" less 1/256"	
14 mm... 35/64" plus 3/640"	
15 mm... 9/16" plus 3/128"	
16 mm... 5/8" plus 3/640"	
17 mm... 43/64" less 1/256"	
18 mm... 11/16" plus 1/64"	
19 mm... 3/4" plus 3/128"	
20 mm... 25/32"	



TOKYO JUKI



TOKYO JUKI INDUSTRIAL CO., LTD.

Head Office & Plant: 2-1, 8-chome, Kokuryo-cho, Chofu-shi, Tokyo, Japan

Business Office: 23, Kabuki-cho, Shinjuku-ku, Tokyo, Japan

Cable Address: JUKI TOKYO Telex: 22957 JUKITK

DJ271BEB Printed in Japan (T)