

JUKI

AMS Series

Computer-controlled Cycle Machine

Input Functions of the Main Unit

INSTRUCTION MANUAL

*AMS 186 MS Dost
AMS 210B M F.12*

I. GENERAL

The main unit of the sewing machine has an input function by which pattern data can be input using the control box.

Using this function, pattern data can be easily created without the need for any other special input device.

1. Features

1) Capable of creating pattern data using only the main unit of the sewing machine

The main unit of the AMS Series of sewing machines comes equipped with an input function control box as standard.

It is therefore easy to create a pattern whenever you wish without the need for any special input device.

2) Interactive indication method

The state and result of inputting the pattern data are indicated by LEDs on the control box, thereby facilitating data input.

3) The various input features reduce the time required to input data

Since it is possible to input all kinds of data, including normal types of stitching such as linear stitching, spline stitching and arc stitching, as well as zigzag stitching and offset stitching, complicated pattern data can be input in a short period of time.

4) Patterns can be easily modified after input using the modification function

A number of modification functions are available including "delete a point," "move a point," "add a point" and "change point speed," which means that any pattern can be easily modified after creation.

5) The test sewing function facilitates pattern confirmation

The input mode can be switched to the test sewing mode when the main unit input function is used. The created pattern can therefore be sewn in the test sewing mode before the data are written onto the floppy disk. Furthermore, the data can be immediately modified by referring to the result of test sewing.

6) The machine uses the MS-DOS operating system which means that the pattern data on the floppy disks can be easily managed

The AMS Series of sewing machines uses **2DD floppy disks**, so when a pattern stored on a floppy disk under a certain pattern number is modified, it can be re-written on the floppy disk using the same pattern number. Furthermore, you can use a personal computer to copy or delete the pattern.

7) The pattern data created using the main unit input function is interchangeable with the pattern data created using the input function from another source and with data created using a conventional floppy disk system

The AMS Series of cycle machines with the main unit input function is capable of reading the patterns created using the PGM-1 or PGM-10 (1D floppy disk) in the normal sewing mode. As a result, a pattern created using another input device can be partially modified to make a new pattern.

(Note that any such new pattern should be written onto an MS-DOS type floppy disk.)

* MS-DOS is the registered trademark of Microsoft Inc. of the U.S.A.

CONTENTS

	Page
I. General	1
1. Features	1
2. Description of the control panel indicators	2
3. Preparations prior to data	4
4. Operation flow chart	5
5. Function list	6
II. Pattern input	7
1. Normal sewing	7
<Jump input >	7
<Linear input >	7
<Temporary change of speed >	8
<Spline sewing input >	9
<Arc sewing input >	10
<Circle sewing input >	10
<Point sewing input >	11
2. Zigzag stitching input	12
3. Offset sewing input	14
4. Sewing machine control command	16
<Thread trimming >	16
<Second origin >	16
<Temporary stop >	16
<Reference point for enlargement/reduction >	17
III. Test sewing	18
IV. Pattern modification	19
1. Modify a point	19
<Point deletion >	19
<Point movement >	21
<Point addition >	23
2. Element deletion	24
<Element deletion >	24
3. Point speed change	25
<Point speed changing >	25

If this key is pressed, the needle will move one stitch from its current position toward the sewing end along the created pattern.
(To use the main unit input function, turn ON the power switch by pressing this key.)

Press this key to check the created pattern shape, after inputting each element. When this key is pressed, the needle will move from the sewing start position of the element input together with the sewing shape until it reaches the sewing end of the element.

This is not used when inputting data using the main unit input function.

When inputting an element, input the point by pressing this key.

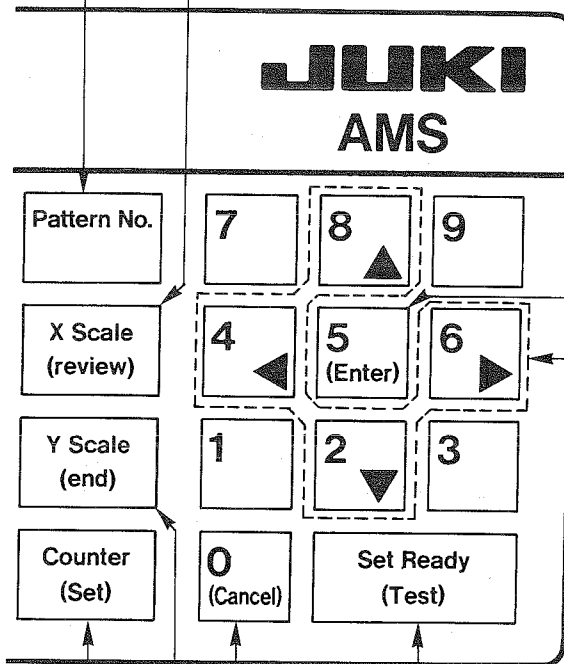

These keys can be operated according to three different methods.

- (1) In the case of setting a function :
Select the desired function code using the and keys.
- (2) In the case of setting the values for the stitch length etc. :
To specify the value required after the desired function has been selected, change the value indicated using the and keys until you obtain the desired value.
Then press the key.
- (3) In the case of inputting an element :
Using the , , and keys, move the needle until it reaches the position where you wish to input the element.

Press this key to interrupt an operation.
Also press this key to select No when is indicated by the LED.

Press this key to change the function to Test. Also press this key to restore the main unit input function.

In the case of specifying the value for the stitch length etc., press this key when the desired value is indicated by the LED.
Also press this key to select YES is indicated by the LED.

Press this key to terminate the input of an element. In this case, the data you have input will not be checked. If you wish to verify the created pattern shape, press the key.

2. Description of the control panel indicators

One of LEDs [1] through [9] lights up when an error occurs.
 (See page 38 for details or the error codes.)
 LED [d] flashes on and off when a pattern is input.
 (The keys [2]↓, [4]←, [6]→ and [8]▲ keys can be operated.)

When this key is pressed, the needle will move one stitch from its current position toward its origin along the created pattern. If this key is pressed while a pattern is being input, the point input immediately before the key is pressed will be deleted, and the needle will return to its previous position.

When the main unit input function is used, only the right-hand side end section of the LED lights up.

The specified operation mode and function code are indicated by this LED.
 (When the setting function is selected, [d] is indicated by this LED.)

E.b 1
 Function code (See page 6.)
 Operation mode ([E] : Input mode, [C] : Modification mode, [A] : Add)

The sewing type code and sewing speed are indicated by this LED.
 (When a pattern is input, the distance in direction x is displayed as H.10.)

b5-
 Sewing speed symbol (See page 8.)
 Sewing type code (See page 6.)

The stitch length is indicated by this LED in mm.
 02.0 : 2.0 mm
 (When a pattern is input, the distance in direction y is displayed as 4.10.)

The stitch width for zigzag or offset stitching is indicated by this LED in mm.
 04.0 : 4.0 mm
 (When a pattern is input, the number of input points is displayed. When moving a point, the distance moved is displayed.)

When this key is pressed, the needle will move from its current position to its origin.

To select this function, press this key when the desired function code is indicated by this LED.

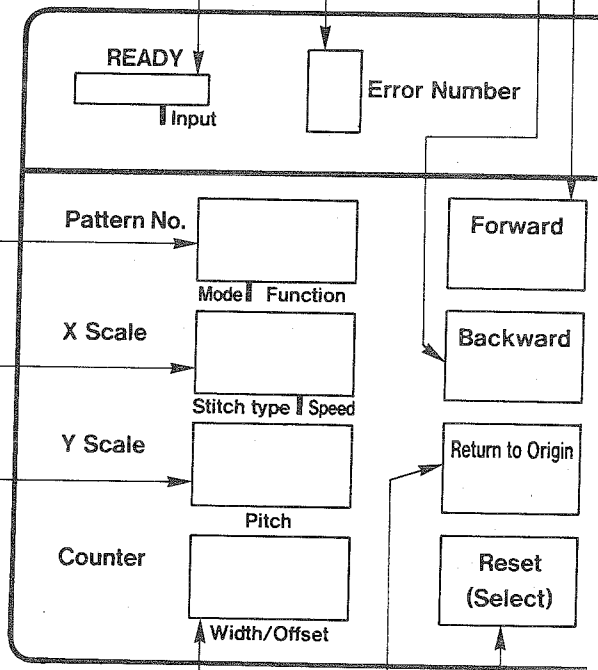

* The major indications of the LEDs are outlined above. Refer to the description of each function for details of what is indicated when each function is actuated.

3. Preparations prior to data

1) Make a full-scale drawing of the direction of the stitches on a sheet of graph paper.

(Caution) Make the drawing after referring to the Instruction Manual for the sewing machine, while making sure that the drawing is made to stay within the specified sewing area, maximum stitch length etc.

2) Use a piece of adhesive tape to stick drawing (①) of the direction of the stitches on origin reference lower plate (②) (optional) referring to the marker line on it. Then attach the lower plate to feed plate (③), and temporarily fix it in place.

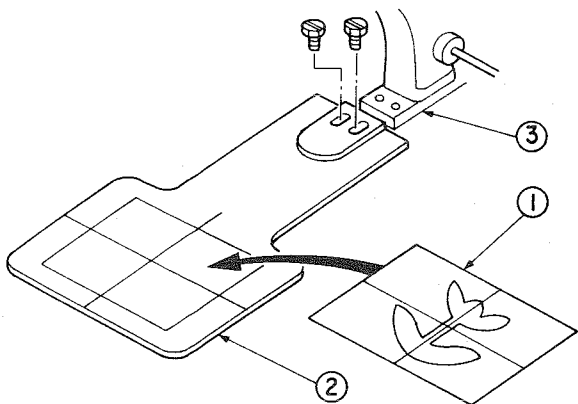

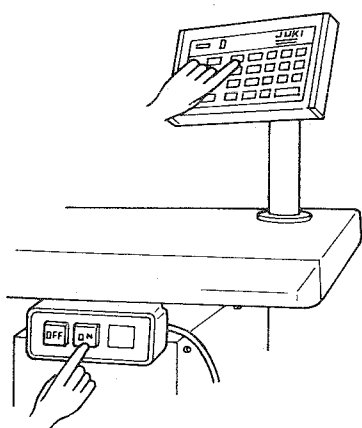

3) While pressing the  key, turn ON the power switch.



The main unit input function will be initialized, the feeding frame will automatically come down, and the needle will move from the desired position to the origin (center of the feeding frame).

(Caution) Since the feeding frame comes down automatically, do not allow your fingers to come near it.

Indication  will now flash on and off on the pattern No. indicator showing that the main unit input function is being executed. Hereinafter, the flashing on and off state of the LED will be indicated with netted as  in this Instruction Manual.

4) Press the feeding frame switch to raise the feeding frame, and positioning the origin reference lower plate.

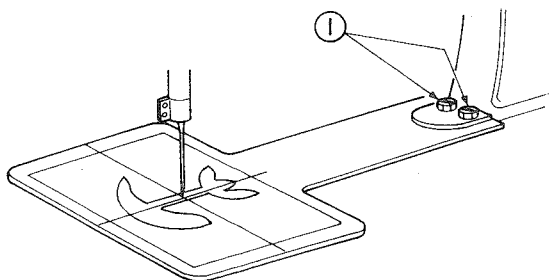

With the tip of the needle, turn the pulley as far as the hole in the origin reference lower plate. Then fix the lower plate using in place using setscrews ①. Now press the feeding frame switch again to lower the feeding frame. Then turn the pulley until the tip of the needle comes close to the drawing of the direction of the stitches. Now input the data.

(Caution) Format the floppy disk before inputting the data by referring to the Instruction Manual for the sewing machine.

4. Operation flow chart

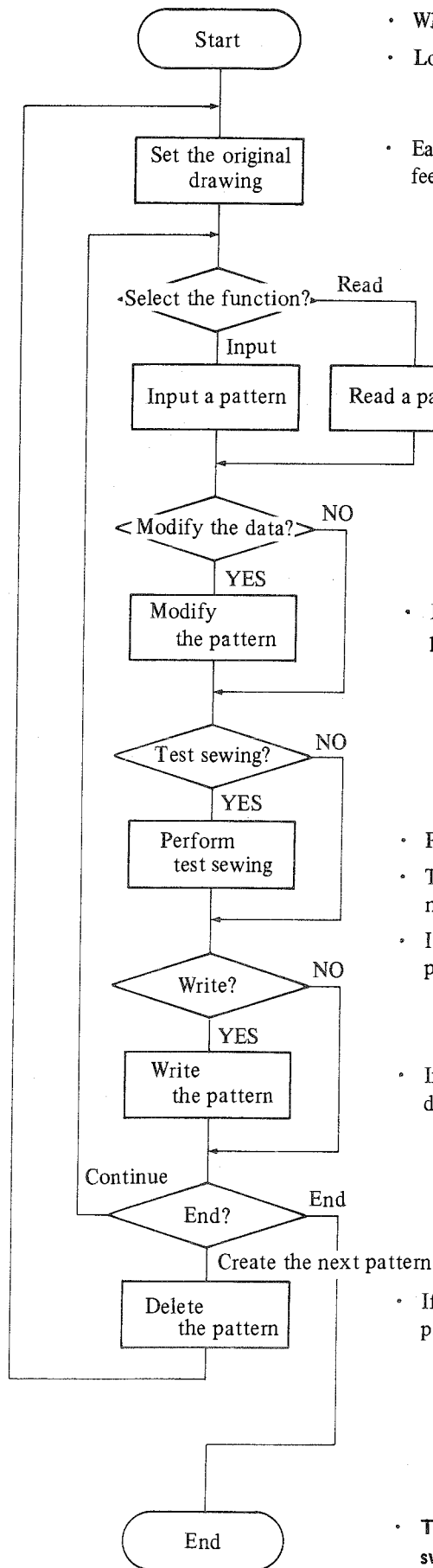

- While pressing the **Forward** key, turn ON the power switch.
- Load the floppy disk only after the power switch has been turned ON.
- Each time you press the feeding frame switch will raise or lower the feeding frame.
- If you create a pattern that needs to be inverted, set the switches concerned to allow pattern inversion before you start inputting the pattern data.
- Select the function code. Then execute the input functions as desired.
- All data stored in the floppy disk can be read.
- Modifications can be made including "Delete a point," "Move a point" etc.
- Press the **Set Ready (Test)** key.
- Test sewing is performed according to the same procedure as for normal sewing.
- If you wish to modify the data checking the results of test sewing, press the **Set Ready (Test)** key to return the machine to the input mode.
- If you are satisfied with the results of test sewing, write the pattern data onto the floppy disk.
- If you wish to create another pattern, be sure to delete the current pattern.
- To return the machine to normal sewing, turn OFF the power switch, and turn it back ON again.

5. Function list

	Sewing machine control A	Normal sewing b	Zigzag stitching C	Offset sewing d	 G	 H	 I	 J
1	Thread trimming A1	Linear normal sewing b1	Linear zigzag stitching C1	Linear Offset sewing d1	Pattern reading G1	Referring to the set value H1	Point deletion (relative) I1	Point deletion (absolute) J1
2	Second origin A2	Spline normal sewing b2	Spline zigzag stitching C2	Spline offset sewing d2	Pattern writing G2		Point movement (relative) I2	Point movement (absolute) J2
3	Temporary stop A3	Arc normal sewing b3	Arc zigzag stitching C3	Arc offset sewing d3	Reference point for enlargement/reduction G3		Element deletion (relative) I3	Point addition (absolute) J3
4		Circle normal sewing b4	Circle zigzag stitching C4	Circle offset sewing d4	Scale setting G4		Invert function setting I4	Inversion J4
5	Point speed changing A5	Point sewing b5						
6	Temporary change of the sewing speed A6	Jump b6						
7	Pattern deletion A7							

	Page
V. Pattern operation	26
1. Pattern deletion	26
<Pattern deletion >	26
2. Pattern reading/writing	27
<Pattern reading >	27
<Scale setting >	27
<Pattern writing >	28
VI. Pattern inversion	29
<Invert function setting >	29
<Inversion >	29
VII. Checking the set value	30
<Checking the set value >	30
VIII. Operating procedure	33
<Pattern reading >	33
<Test sewing >	33
<Pattern writing >	33
<Pattern input >	34
<Pattern modification >	35
IX. Error codes	38
X. Operation panel	41

II. PATTERN INPUT

1. Normal sewing

< Jump input >

Function code : **66**

Use this function to move the feeding frame to a specified position without actuating the sewing machine.

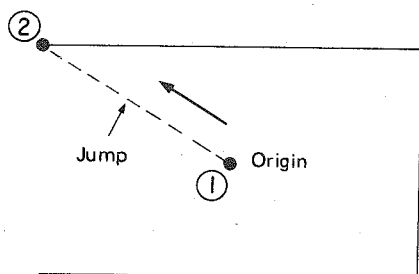

- 1) Press the **8** and **2** keys until **66** is shown on the **Function** LED.
- 2) Press the **Reset (Select)** key.
- 3) Press the **4** , **8** , **6** , and **2** keys until the needle reaches position ② shown in the figure.
- 4) Press the **5** key. (This step can be skipped.)
- 5) Press the **X Scale (review)** key or the **Y Scale (end)** key.

(Remarks) 1. Steps 3) and 4) can be repeated (as many as 128 points can be entered). Do not press the **5** key at the end of repeat input.

(Remarks) 2. Jump input is not only possible from the origin but also from any desired point on the pattern.

< Linear input >

Function code : **61**

A straight line from the needle position is entered in the specified stitch length by inputting a single point.

- 1) Press the **8** and **2** keys until **61** is shown on the **Function** LED.
- 2) Press the **Reset (Select)** key.
- 3) Press the **8** and **2** keys until the desired stitch length (unit : mm) is shown by the **Pitch** LED.

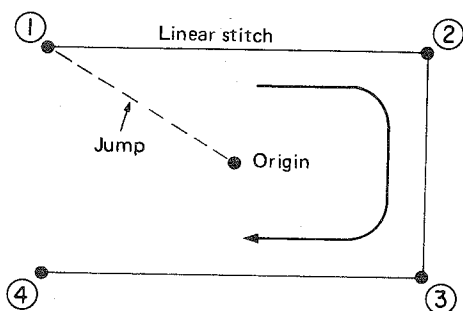

- 4) Press the **Counter (Set)** key.
 - 5) Press the **4** , **8** , **6** , and **2** keys until the needle reaches position ② shown in the figure.
 - 6) Press the **5** key.
 - 7) Repeat steps 5) and 6) to enter points ④.
- (Do not press the **5** key after point ④ has been entered.)
- 8) Press the **X Scale (review)** key or the **Y Scale (end)** key.

(Remarks) 1. As many as 128 points can be continuously entered.

(Remarks) 2. How to specify the stitch length

* The steps in the procedure to specify the stitch length for the linear input also apply to other types of stitching.

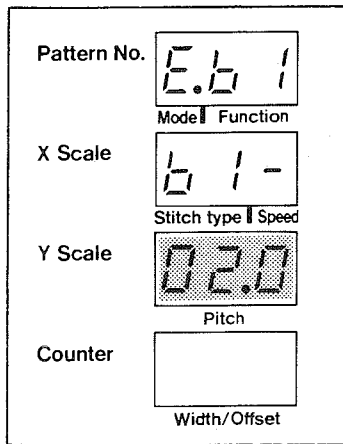

Function code : Select . The LED will now flash on and off.
Press the and keys until the desired stitch length (unit : mm) is shown by the LED.

← Stitch length (can be specified from 0.2 mm to 10.0 mm in increments of 0.2 mm)
(The stitch length is set to 2.0 mm in the example given.)

(Remarks) 3. Indication when a pattern is input

* The indication when a pattern is input for other types of stitching is the same as that for the linear input.

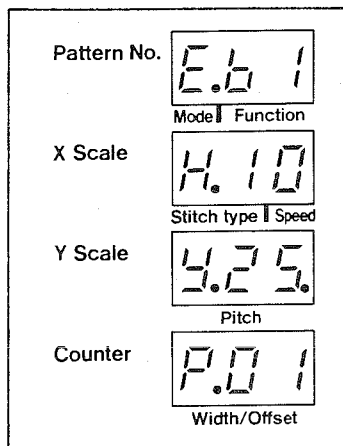

← Number of pulses in the x direction from the start point.
(Set to 10 pulses in the example given.)
← Number of pulses in the y direction from the start point.
(Set to - 25 pulses in the example given.)
← Number of input points
• For the number of two figures : 99 points
• For the number of three figures : 999 points
• For the number of four or more figures : 1001 pulses
The fourth figure is not displayed. The third figure flashes on and off and a period (.) is attached.
* For the AMS-210/220 Series of sewing machines, one pulse length is set to 0.16 mm.

(Remarks) 4. How to specify the sewing speed

* The steps in the procedure to specify the speed for the linear input also applies to other types of stitching.

The stitch length indicated by the LED automatically determines the speed indicated by the LED. However, it can be further controlled using the following functions.

< Temporary change of speed >

Function code :

1) Press the and keys until is shown by LED.

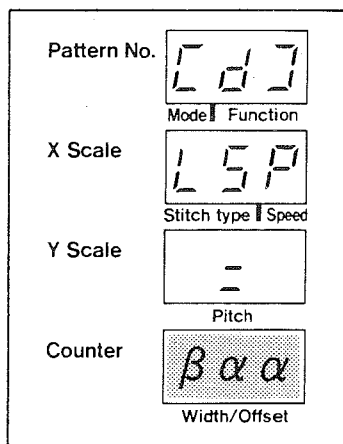

2) Press the key.

3) Press the and keys until the desired sewing speed is shown by the Width/Offset LED.

: 200spm	: 900spm	: 1300spm	: 1700spm
: 600	: 1000	: 1400	: 1800
: 700	: 1100	: 1500	: 1900
: 800	: 1200	: 1600	: 2000

← : The value determined by the stitch length
 : Speed symbol
 : The speed (x 100 s.p.m.) is indicated.

4) Press the key.

(Remarks) After the desired speed has been entered, the speed can be controlled for every single stitch using the point speed changing function.

(Caution) The speed specified using the temporary change of speed function is valid only when inputting the pattern data immediately after it has been specified.

< Spline sewing input >

Function code : b2

Use this function to enter a gently curving line.

- 1) Press the 8 ▲ and 2 ▼ keys until b2 is shown by the Function LED.
- 2) Press the Reset (Select) key.
- 3) Press the 8 ▲ and 2 ▼ keys until the desired stitch length (unit : mm) is shown by the Pitch LED.

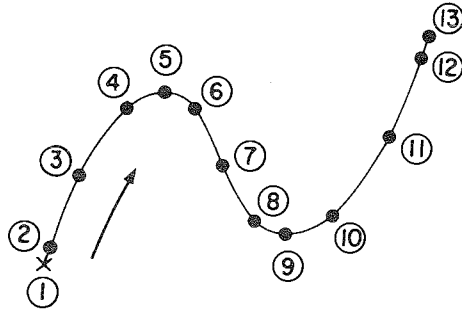

- 4) Press the Counter (Set) key.
- 5) Press the a B A 6 2 ▼ p keys until the needle reaches position ② shown in the figure.
- 6) Press the 5 (Enter) key.
- 7) Repeat steps 5) and 6) to enter points through to ⑬ .

(Do not press the 5 (Enter) key after point ⑬ has been entered.)

- 8) Press the X Scale (review) key or the Y Scale (end) key.

(Remarks) 1. As many as 128 points can be continuously entered.

(Remarks) 2. To enter a simple shaped spline sewing, select the input points following the procedure described below.

- 1) Select the apexes of the curve to be created as the input points.
- 2) Centering the points selected in step (1), select the points before and after the selected points as the following input points.
- 3) Then select the points positioned in the center of the gentle curves as the input points.
- 4) Select the points near both ends of the curve to be entered as the input points.

Enter the points following the procedure described above in the same order of steps. Pay special attention to the following items.

- Increase the number of input points for the sharp curves and decrease the number for the gentle curves.
- You should select at least three input points for one curve.

(Remarks) 3. The spline sewing input function is used to enter an oval shape.

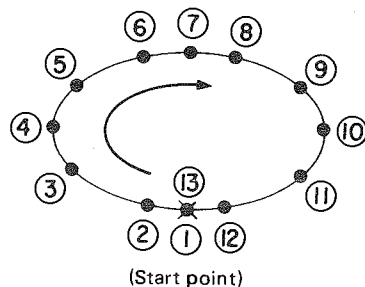

- 1) The joining points of the curved lines should be specified for the gentle curves.
- 2) Select the input points so that they are symmetrical-ly positioned.

(Remarks) 4. The stitch length and sewing speed are specified according to same procedure as that for the linear input. The indication when inputting a pattern using the spline sewing input function is also the same as that when using the linear input.

< Arc sewing input >

Function code : **b3**

By inputting two points, use this function to enter an arc starting from the needle position in the specified stitch length. The sewing will proceed in the direction of the points specified in the order of input. Both clockwise and counterclockwise seams can be entered.

- 1) Press the **8** and **2** keys until **b3** is shown by the **Function** LED.
- 2) Press the **Reset (Select)** key.
- 3) Press the **8** and **2** keys until the desired stitch length (unit : mm) is shown by the **Pitch** LED.

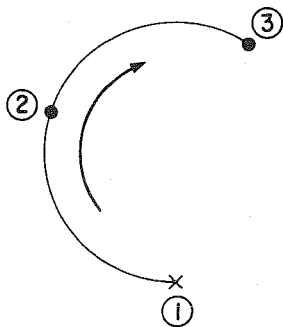

- 4) Press the **Counter (Set)** key.
- 5) Press the **4**, **8**, **6**, **2** keys until the needle reaches position ② shown in the figure.
- 6) Press the **5 (Enter)** key.
- 7) Repeat steps 5) and 6) until point ③ is reached.

(Do not press the **5 (Enter)** key after point ③ has been entered.)

- 8) Press the **X Scale (review)** key or the **Y Scale (end)** key.

(Remarks) The stitch length and sewing speed are specified according to the same procedure as that for the linear input. The indication when inputting a pattern using the arc sewing input function is also the same as that when using the linear input.

< Circle sewing input >

Function code : **b4**

By inputting two points, use this function to enter a circle starting from the needle position in the specified stitch length. The sewing will proceed in the direction of the points specified in the order of input. Both clockwise and counterclockwise seams can be entered.

- 1) Press the **8** and **2** keys until **b4** is shown by the **Function** LED.
- 2) Press the **Reset (Select)** key.
- 3) Press the **8** and **2** keys until the desired stitch length (unit : mm) is shown by the **Pitch** LED.

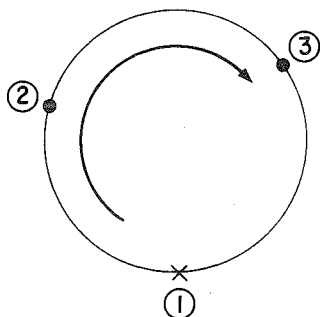

- 4) Press the **Counter (Set)** key.
- 5) Press the **4**, **8**, **6**, **2** keys until the needle reaches position ② shown in the figure.
- 6) Press the **5 (Enter)** key.
- 7) Repeat steps 5) and 6) until point ③ is reached.

(Do not press the **5 (Enter)** key after point ③ has been entered.)



- 8) Press the **X Scale (review)** key or the **Y Scale (end)** key.

(Remarks) The stitch length and sewing speed are specified according to the same procedure as that for the linear input. The indication when inputting a pattern using the circle sewing input function is also the same as that when using the linear input.





< Point sewing input >

Function code : **65**

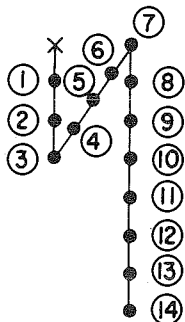
Use this function to directly enter the needle entry points for every single stitch.

- 1) Press the **8**  and **2**  keys until **65** is shown by the **Function** LED.
- 2) Press the **Reset (Select)** key.



- 3) Press the **4**  **8**  **6**  keys until the needle reaches position **2** shown in the figure.
- 4) Press the **5**  key.
- 5) Repeat steps 3) and 4) until point **14** is reached.
(Do not press the **5**  key after point **14** has been entered.)
- 6) Press the **X Scale (review)** key or the **Y Scale (end)** key.

(Remarks) 1. As many as 128 points can be continuously entered. If you wish to enter more than 128 points, temporarily terminate the input procedure and start again from the function setting.

(Remarks) 2. The stitch length and sewing speed are specified according to the same procedure as that for the linear input. The indication when inputting a pattern using the point sewing input function is also the same as that when using the linear input.

(Caution) Take care not to allow the interval between each point to exceed the largest stitch length (10.0 mm). If the data exceeds the largest stitch length, error **E** will occur at the start of test sewing or writing the data onto the floppy disk.

2. Zigzag stitching input

Function code

Linear zigzag : E1

Spline zigzag : E2

Arc zigzag : E3

Circle zigzag : E4

Use this function to create the zigzag needle entry points to the left and right while observing from the input reference line. This function is very convenient when inputting the data for zigzag stitching in emblems etc.

- 1) Press the 8 and 2 keys until E1 is shown by the Function LED.
- 2) Press the Reset (Select) key.
- 3) Press the 8 and 2 keys until the desired stitch length (unit : mm) is shown by the Pitch LED.
- 4) Press the Counter (Set) key.
- 5) Press the 8 and 2 keys until the desired stitch width (unit : mm) is shown by the Width Offset LED.
- 6) Press the Counter (Set) key.

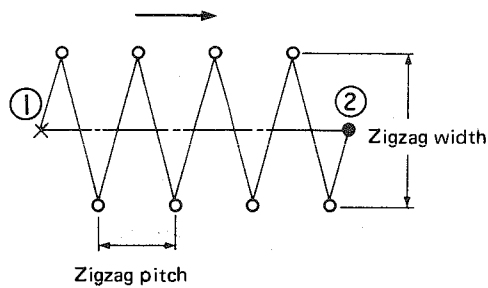

- 7) Press the 8 2 8 2 keys until the needle reaches position ② shown in the figure.

- 8) Press the 5 (Enter) key. (This step can be skipped.)

- 9) Press the X Scale (review) key or the Y Scale (end) key.

(Remarks) 1. Repeat steps 7) and 8) to continuously enter as many as 128 points.

Do not press the 5 (Enter) after the last point has been entered.

(Remarks) 2. How to specify the zigzag pitch and width

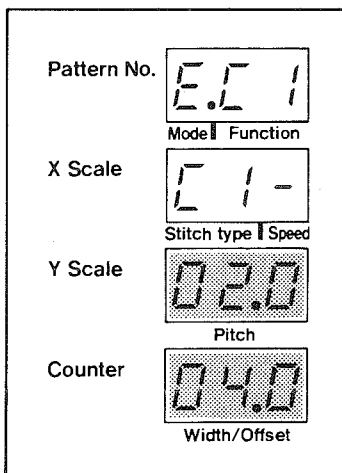

← Zigzag pitch (can be specified from 0.8 mm to 20.0 mm in increment of 0.2 mm)

The zigzag pitch is set to 2.0 mm in the example given.)

← Zigzag width (can be specified from 0.1 mm to 10.0 mm in increments of 0.1 mm)

If no period (.) is attached to the last figure, the zigzag stitching will start from the left-hand side of the input reference line.

If a period (.) is attached to the last figure, the zigzag stitching will start from the right-hand side of the input reference line.

(The zigzag stitching starts 4.0 mm from the left-hand side in the example given.)

(When the zigzag stitching starts from the right-hand side of the input reference line, the zigzag width is set to 0.4 mm.)

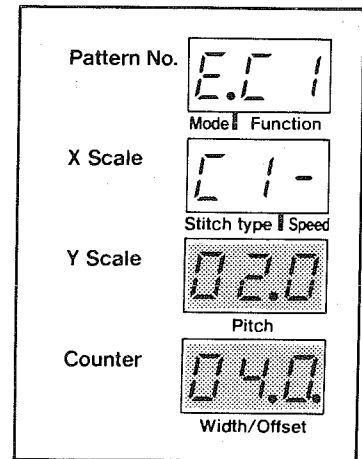
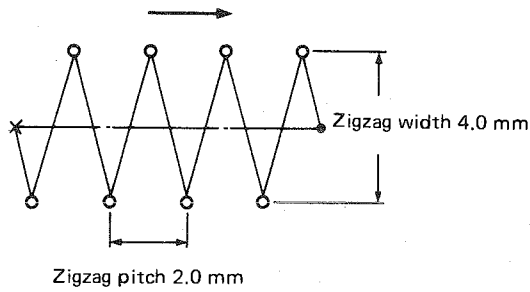

(Remarks) 3. Example of zigzag stitching input

(1) Linear and arc

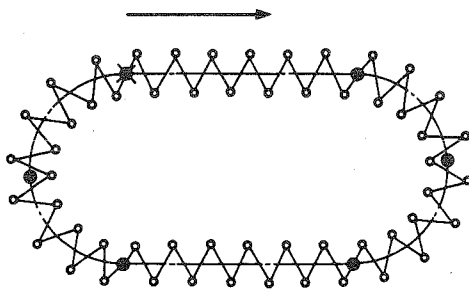

(2) Circle

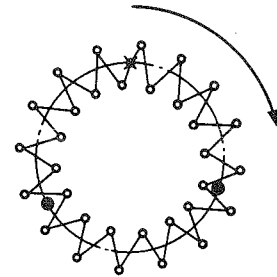

(3) Spline

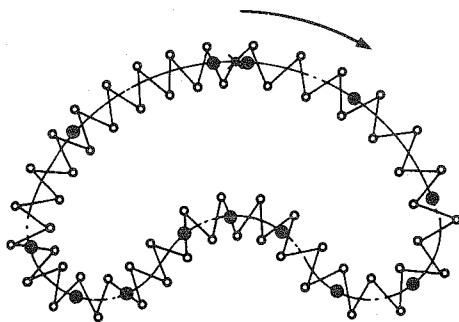

(Caution) If you have specified a large value which is near to the limit for the zigzag pitch or zigzag width, the distance between the needle entry points may exceed the max. stitch length permitted in accordance with the combination of the zigzag pitch and zigzag width. In this case, Error E may occur when you perform a test sewing or try to write the data in the floppy disk.

3. Offset sewing input

Function code

Linear offset : d1

Spline offset : d2

Arc offset : d3

Circle offset : d4

Use this function to create needle entry points with a predetermined distance between the input reference line in the directions to the left and right. This is very convenient when attaching small parts while inputting the data according to their peripheral measurements.

- 1) Press the 8▲ and 2▼ keys until d1 is shown by the Function LED.
- 2) Press the Reset (Select) key.
- 3) Press the 8▲ and 2▼ keys until the desired stitch length (unit : mm) is shown by the Pitch LED.
- 4) Press the Counter (SeU) key.
- 5) Press the 8▲ and 2▼ keys until the desired stitch width (unit : mm) is shown by the Width Offset LED.
- 6) Press the Counter (SeU) key.

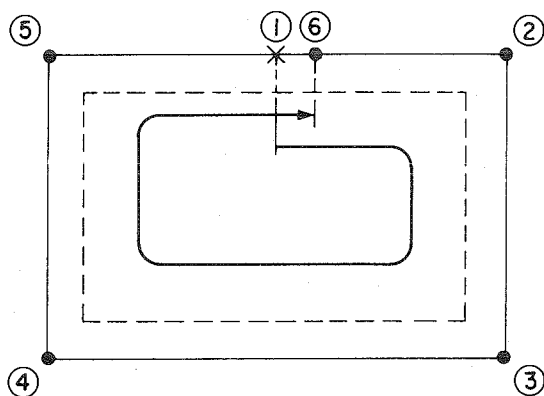

- 7) Press the 8▲ 4← 6→ keys until the needle reaches position ② shown in the figure.
- 8) Press the 5 (Enter) key.
- 9) Repeat steps 7) and 8) to enter point ⑥ .
(Do not press the 5 (Enter) after point ⑥ has been entered.)
- 10) Press the X Scale (review) key or the Y Scale (end) key.

(Remarks) 1. How to specify the stitch length and offset width

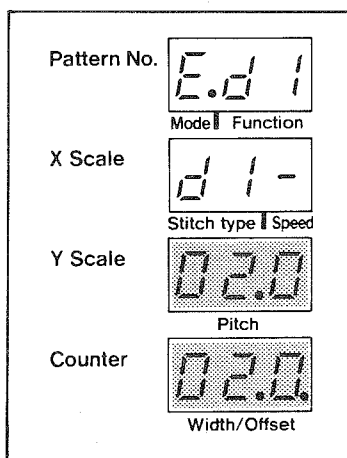



- ← Stitch length (can be specified from 0.2 mm to 10.0 mm in increments of 0.2 mm)
(The stitch length is set to 2.0 mm in the example given.)
- ← Offset width (can be specified from 0.1 mm to 99.9 mm in increments of 0.1 mm)
If no period (.) is attached to the last figure, the seam will be created on the left-hand side of the input reference line.
If a period (.) is attached to the last figure, the seam will be created on the right-hand side of the input reference line.
(The offset seam is created on the left-hand side with the offset distance at set 2.0 mm in the example given.)

4. Sewing machine control command

< Thread trimming >

Function code : **A1**

With this command, thread trimming is performed during the pattern data.



- 1) Press the **8**  and **2**  keys until **A1** is shown by the **Function** LED.
- 2) Press the **Reset (Select)** key.

< Second origin >

Function code : **A2**

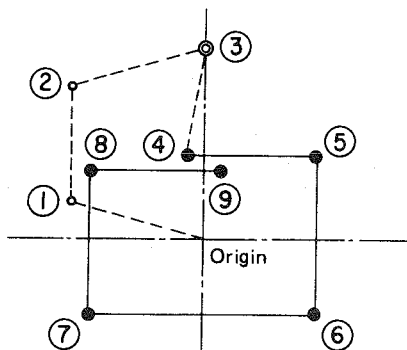
The second origin can be specified between the origin and the sewing start point, thereby allowing the workpiece to be easily set in place.



- 1) Press the **8**  and **2**  keys until **A2** is shown by the **Function** LED.
- 2) Press the **Reset (Select)** key.

If the second origin is set at point ③ in the section entered using the jump input function as in the figure illustrated, the sewing machine will perform a series of operation after the origin retrieval starting jumping from point ①, then to points ② and ③. The machine will then stop at point ③.



After that, the machine will perform a cycle sewing operation from point ③ through to point ⑨.

(Caution) When enlarging/reducing a pattern, the path from the origin to the second origin will be excluded.

< Temporary stop >

Function code : **A3**

This function is used to temporarily stop the sewing machine with its needle up during sewing. Press the Start switch to re-start the sewing machine which has been brought to a stop using the temporary stop function.

- 1) Press the **8**  and **2**  keys until **A3** is shown by the **Function** LED.
- 2) Press the **Reset (Select)** key.





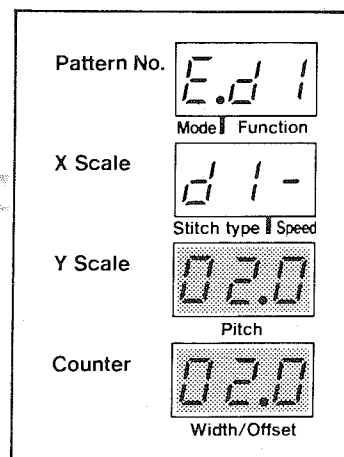
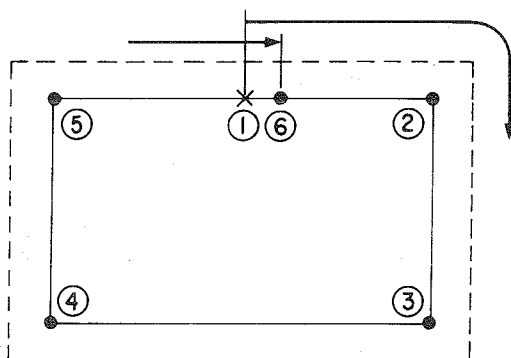

(Remarks) If you wish to temporarily stop the sewing machine after thread trimming, specify the thread trimming function and the temporary stop function.

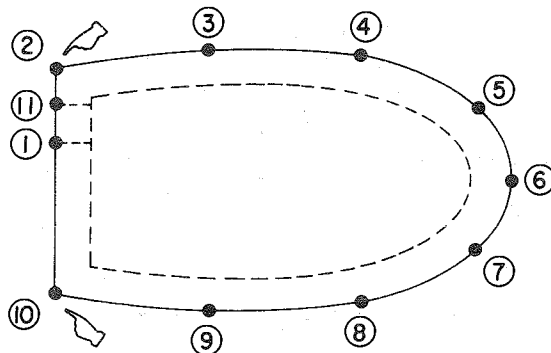
(When the offset sewing data are entered on the right-hand side of the input reference line with the offset distance set at 2.0 mm.)



(Remarks) 2. The shape illustrated below can be entered using the spline offset sewing input function.



- 1) Select  at point ①. Then specify the values for the  and .
- 2) Input point ②.
- 3) Press the  key to move the needle by the length of one pulse.
- 4) Press the  key.
- 5) Enter points ③ through ⑩.
- 6) Move the needle by the length of one pulse as in step 3).
- 7) Press the  key.
- 8) Input point ⑪.

(Caution) 1.

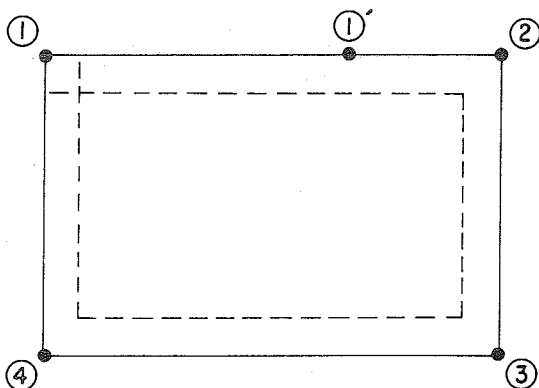

If you start inputting the data for the shape illustrated in the figure from point ①, then continue inputting points ②, ③, ④ and ① in the order stated, the pattern shown by the broken line will be created.

To create a correct polygon, start inputting the points not from the corners such as from point ① but from a point in the middle of the sides such as from point ①'.

(Caution) 2. The input points should be selected so that the shape is drawn in one stroke.

< Reference point for enlargement/reduction >

Function code :

This function is used to input a reference point for enlargement/reduction at any desired point in the created pattern data. If a reference point for enlargement/reduction is not specified, the pattern will be enlarged/reduced using the origin as reference.

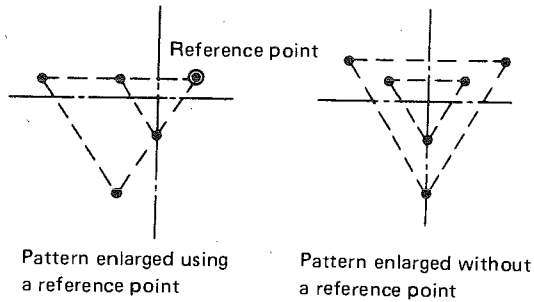

- 1) Press the and keys until is shown by the LED.
- 2) Press the key.

(Remarks) If you have specified two or more reference points for enlargement/reduction, only the last input point will be valid.

III. TEST SEWING

When the AMS is in the input mode, each time you press the  key, the machine will be switched alternately between the input mode and the test sewing mode.

Turn ON the power to the machine.

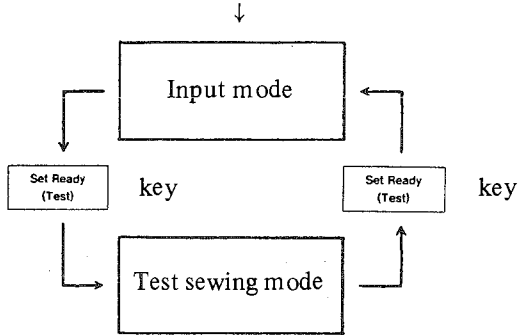

Input mode

- In this mode, the pattern data can be entered or modified using the keys on the control box.
- In this mode, the data created data are read from or written onto the floppy disk.

Test sewing mode

- In this mode, the entered or modified pattern can be test sewn using the main unit input function.
- The operation procedure of the sewing machine in the test sewing mode is the same as that in the normal sewing mode.

< Input mode to the test sewing mode >



The created pattern data can be checked by immediately performing test sewing.

- 1) Press the  key.
- 2) The READY lamp will light up, and the feeding frame will retrieve the origin and move to the sewing start point. The work clamp will then go up.
- 3) Test sewing can be performed during a normal sewing procedure. Be sure to check the shape of the created pattern by performing test sewing before you start actual sewing. (Refer to the relevant Instruction Manual for each model in the AMS Series for details on the operation procedure.)

< Test sewing mode to the input mode >

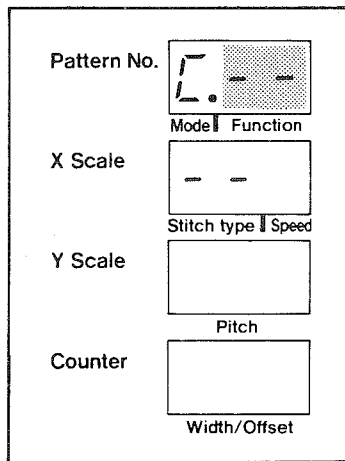
After test sewing, you can return the machine to the input mode.



- 1) Press the  key.
- 2) The "Input" section of the READY lamp will light up, the feeding frame will return to the origin, and the work clamp will come down.
- 3) The LEDs will be as illustrated, indicating that the machine is on standby waiting for a function to be set after the origin (before the created pattern data). If you modify the pattern data or add more data, press the  key to make the needle go forward.

IV. PATTERN MODIFICATION

To modify the created pattern, move the needle to the position of the data to be modified using the Forward or Backward keys.

1. Modify a point

< Point deletion >

Function code Relative deletion : 11

Absolute deletion : 11

The pattern data in the designated section can be cleared in the unit of needle entry point using this function. Two different types of point deletion (relative deletion and absolute deletion) can be used depending on whether the pattern data after the point to be erased moves after the point has been deleted. Point deletion is used to erase the pattern data created by means of the point sewing input function as well as data created using other types of input function.

- 1) If the needle is at point ①, press the 8 ▲ and 2 ▼ keys until 11 is shown by the Function LED.
- 2) Press the Reset (Select) key.
- 3) The LEDs will indicate Pch = 05, which means that the operation mode can be changed to the point sewing input function. If you wish to continue deleting, press the Counter (Set) key. If you wish to stop deleting, press the 0 (Cancel) key.

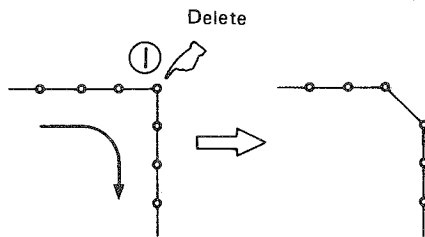

- 4) Move the needle to the section of the point to be deleted by pressing the Forward key.

This designates the section of the point to be erased. If the needle goes beyond the section, press the

Backward key to return it to the section of the point to be deleted.

- 5) Press the Counter (Set) key.

- 6) The point will then be deleted.

[Indication of the number of needle entry points]

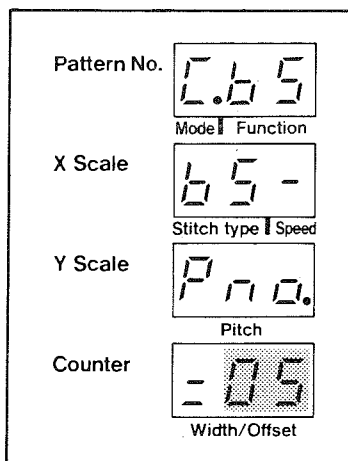

It means "POINT = 05", and shows the number of needle entry points to be deleted. (It is set to 5 in the example given.)

The figure illustrated on the previous page is an example of **absolute** deletion. In this case, the pattern data after the deleted point will not move.

On the other hand, if you erase the point shown in the figure using **relative** deletion, press the $\boxed{8 \blacktriangle}$ and $\boxed{2 \blacktriangledown}$

keys when the needle is positioned at point ① so that $\boxed{1.1}$ is shown by $\boxed{\text{Function}}$ LED. In this case, the

pattern data after the deleted point will move, while maintaining the relationship of the whole pattern data before the point was deleted.

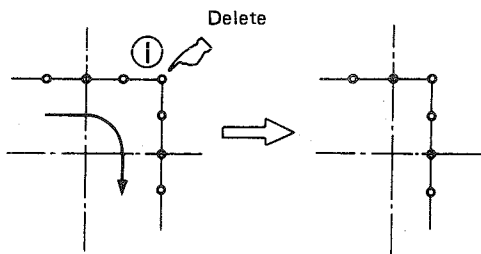

(Caution) 1. Take care not to allow the point interval to exceed the largest stitch length (10.0 mm) after the point has been deleted. If there are data exceeding the largest stitch length, error \boxed{E} will occur at the start time of test sewing or writing the data onto the floppy disk.

(Caution) 2. The created pattern data might exceed the sewing range after the point has been deleted. In this case, the feeding frame will stop in a position beyond the sewing range even if you try to confirm the pattern data by pressing the $\boxed{\text{Forward}}$ and $\boxed{\text{Backward}}$ keys. If this occurs, use the pattern modification function to correct the pattern data so that they stay within the sewing range.

< Point movement >

Function code Relative movement : 12

Absolute movement: 12

The designated needle entry point can be moved using this function.

Two different types of point movement (relative movement and absolute movement) can be used depending on whether the pattern data after the point to be moved.

Point movement is used to move the pattern data created by means of the point sewing input function as well as data created using other types of input function.

When this function is used for the pattern data created using the linear input function etc., the operation mode will change to the point sewing input mode when the point has moved.

1) If the needle is at point ①, press the 8 ▲ and 2 ▼ keys until 12 is shown by the Function LED.

2) Press the Reset (Select) key.

3) The LEDs will indicate PCH = 9.9, which

means that the operation mode can be changed to the point sewing input function. If you wish to

continue moving, press the Counter (Set) key. If you

wish to stop moving, press the 0 (Cancel) key.

4) By pressing the 4 ← 8 ▲ 6 → 2 ▼ keys, move the needle until

the destination of the point to be moved has been reached.

5) Press the 5 (Enter) key. (This step can be stepped.)

6) Press the Y Scale (end) key.

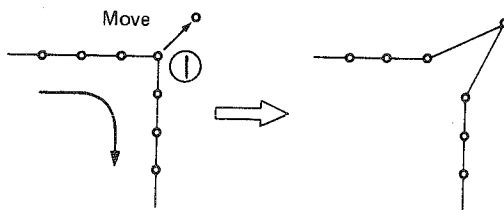

[Indication of the point to be moved]

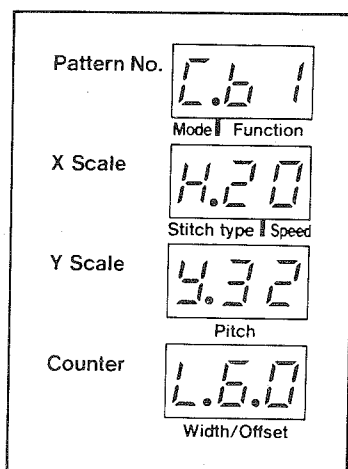

← Number of pulses in the x direction from the designated point to be moved to the current position of the needle.

(Set to 20 pulses in the example given.)

← Number of pulses in the y direction from the designated point to be moved to the current position of the needle.

(Set to 32 pulses in the example given.)

← Distance from the designated point to be moved to the current position of the needle.



• For the number of two figures :

1.9.9 9.9 mm

• For the number of three figures :

9.9.9 99.9 mm

The figure illustrated on the previous page is an example of **absolute** movement. In this case, the pattern data after the point has been moved will not move.

On the other hand, if you move the point shown in the figure using **relative** movement, press the  and 

keys when the needle is positioned at point ① so that  is shown by the  LED. In this case,

the pattern data after the moved point will move, while maintaining the relationship of the whole pattern data before the point was moved.

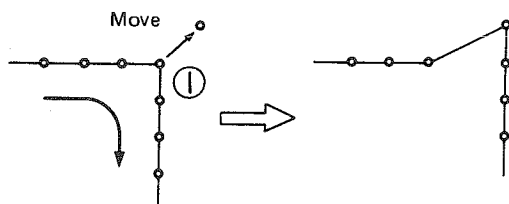

(Caution) 1. Take care not to allow the point interval to exceed the largest stitch length (10.0 mm) after the point has been moved.

If there are data exceeding the largest stitch length, error  will occur at the start of test sewing or writing the data onto the floppy disk.

(Caution) 2. The created pattern data might exceed the sewing range after the point has been moved. In this case, the feeding frame will stop in a position beyond the sewing range even if you try to confirm

the pattern data by pressing the  and  keys. If this occurs, use the pattern

modification function to correct the pattern data so that they stay within the sewing range.

< Point addition >

Function code : **U3**

This function is used to add a point after the needle entry point has been designated.

The pattern data after the point has been added will not move. The point add function is used to add a point in the pattern data created by means of the point sewing input function as well as data created using other types of input function. When this function is used for the pattern data created using the linear input function etc., the operation mode will change to the point sewing input mode when the point has been added.

1) If the needle is at point ①, press the **8** and **2** keys until **U3** is shown by the **Function** LED.

2) Press the **Reset (Select)** key.

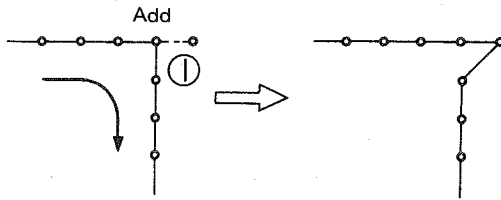

3) The LEDs will indicate **PCH** **= 4.0**, which

means that the operation mode can be changed to the point sewing input function. If you wish to

continue adding, press the **Counter (Set)** key. If you

wish to stop adding, press the **0 (Cancel)** key.

4) By pressing the **4** **8** **6** keys, move the needle

until the destination of the point to be added has been reached.

5) Press the **5 (Enter)** key. (This step may be omitted.)

6) Press the **Y Scale (end)** key.

(Caution) 1. Take care not to allow the point interval to exceed the largest stitch length (10.0 mm) after the point has been added.

If there are data exceeding the largest stitch length, error **E** will occur at the start of test sewing or writing the data onto the floppy disk.

(Caution) 2. The created pattern data might exceed the sewing range after the point has been added. In this case, the feeding frame will stop in a position beyond the sewing range even if you try to

confirm the pattern data by pressing the **Forward** and **Backward** keys. If this occurs, use the

pattern modification function of correct the pattern data so that they stay within the sewing range.

(Remarks) The machine is provided with a function that allows new data to be added to the created pattern data. The function is used to add an element to the desired position in the created pattern data.

2. Element deletion

< Element deletion >

Function code : 13

This function is used to erase a designated element.

The whole pattern data after the deleted element will move, accordingly while maintaining the relationship before the element was deleted.

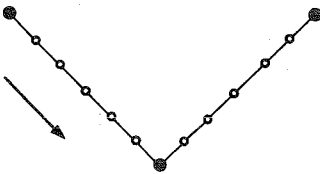
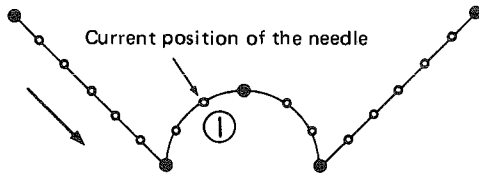

1) If the needle is positioned at point ①, press the

8 ▲ and 2 ▼ keys until 13 is shown by the Function LED.

2) Press the Reset (Select) key.

The element where the needle is currently positioned will be erased, and the whole pattern data after the erased element cleared will move up.

The needle will be brought to the end of the element immediately before the erased element.

(Caution) 1. The element data once erased can never be restored.

(Caution) 2. The created pattern data might exceed the sewing range after the element has been erased. In this case, the feeding frame will stop in a position beyond the sewing range even if you try to confirm

the pattern data by pressing the Forward and Backward keys. If this occurs, use the pattern

modification function to correct the pattern data so that they stay within the sewing range.

(Remarks) You can also cancel the sewing machine control command as well as the sewing elements including point sewing, linear sewing etc.

An element is the smallest unit of pattern data.

Normally, an element is created through a series of operations starting with the function setting, followed by the

coordinate input until the termination of data input by pressing the Y Scale (end) key or X Scale (review) key.

The sewing machine control commands including the thread trimming command are regarded as elements.

The created element may be divided into two or more elements by using the modification functions including the point delete function etc.

The element to which the needle currently belongs is indicated on the "Stitch type" LED using the relevant

function code (for example, arc zigzag stitching [Function code : C3] will be shown as b5 , since it is created as a point sewing element).

3. Point speed changing

< Point speed changing >

Function code : **RS**

This function is used to control the pattern sewing speed in the section designated in the unit of the needle entry point.

This function is used to change the point speed in the pattern data created by means of the point sewing input function as well as data created using other types of input function.

- 1) If the needle is at point ①, press the **8** and **2** keys until **RS** is shown by the **Function** LED.
- 2) Press the **Reset (Select)** key.

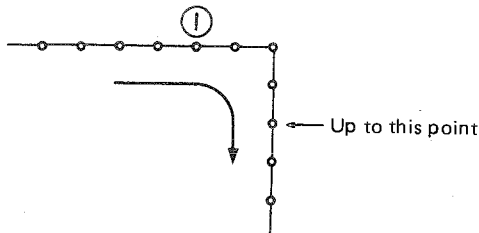

- 3) Press the **8** and **2** keys until the desired sewing speed is shown by the **Speed** LED.

0 : 200spm	8 : 1300spm	- : Value determined by the stitch length.
1 : 600spm	9 : 1400spm	
2 : 700spm	A : 1500spm	
3 : 800spm	b : 1600spm	
4 : 900spm	C : 1700spm	
5 : 1000spm	d : 1800spm	
6 : 1100spm	E : 1900spm	
7 : 1200spm	F : 2000spm	

- 4) Press the **Counter (Set)** key.
- 5) By pressing the **Forward** key, move the needle to specify the section of the points for which the sewing speed is to be changed. If you go beyond the desired section, press the **Backward** key to return the needle to the correct section.
- 6) Press the **Counter (Set)** key.

[Indication of the number of needle entry points]

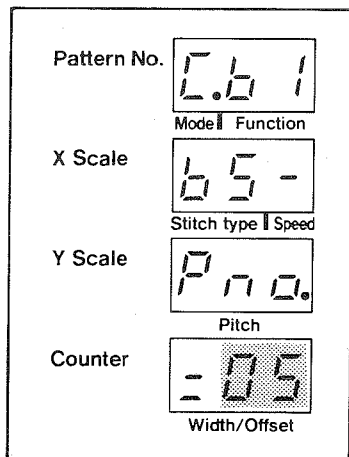

It means "POINT = 05", and shows the number of needle entry points for which the sewing speed is to be changed. (It is set to 5 in the example given.)

V. PATTERN OPERATION

1. Pattern deletion



<Pattern deletion >

Function code : 

This function is used to erase all the created pattern data.

1) Press the  and  keys until  is shown by the  LED.

2) Press the  key.

3) The confirmation message   will be displayed.

If you wish to delete the pattern, press the  key.

If you wish to cancel the command to delete the pattern, press the  key.

4) The pattern will be deleted.

All the entered pattern data will be deleted and the work clamp will move so that the needle is able to return to the origin.

[Indication of the confirmation message]

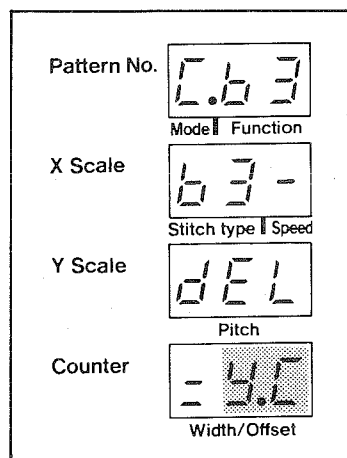

← Message requesting you to confirm the operation : "Are you sure you want to delete all the patterns?"

← If you really want to delete all the pattern data, press the  key.

Otherwise, press the  key.

(Caution) 1. The pattern data once deleted can never be restored.

Furthermore, not only the pattern data but also the various specified values will return to the original values indicated at the start of data input.

Turn OFF the power switch, and turn it back ON again while pressing the  switch. This will have the same result as executing the command to delete a pattern.

(Caution) 2. When you press the  switch, the intermediate presser will automatically move toward its origin.

(Caution) 3. If you wish to create a new pattern after the created pattern data have been written onto the floppy disk, or if other pattern data are to be read from the floppy disk after reading other pattern data, be sure to delete the current pattern data using this function. The pattern newly read from the floppy disk will be added to the pattern data already existing so that they will come after the current position of the needle.

[y-scale setting]

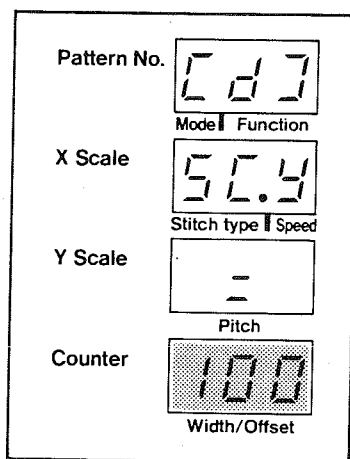

5) Press the and keys until the desired scale is shown by the Width/Offset LED.

← Y-scale when reading a pattern from the floppy disk.

6) Press the key. 001 to 400% (100 : original size)

(Remarks) There are two pattern enlargement/reduction methods to choose from i.e., the INC/DEC of the stitch length or the INC/DEC of the number of stitches as in the pattern reading mode for a normal sewing procedure.

< Pattern writing >

Function code :

This function is used to write the created pattern data onto the floppy disk.

- 1) Press the and keys until is shown by the LED.
- 2) Press the key.
- 3) Press the and keys until the pattern number (1 ~ 999) of the data to be written onto the floppy disk is indicated.
- 4) Press the key.
- 5) The machine checks whether the designated pattern data has already been stored on the floppy disk. If the pattern data has been stored under the designated number, the following indication will be shown on the LEDs.

If you wish to update, press the key.

If you wish to cancel writing the pattern data onto the floppy disk under the designated number, press the key.

(Caution) 1. Be sure to unlock the write-protect tab before writing the pattern data onto the floppy disk.

(Caution) 2. If it is the first time to write the pattern data onto the floppy disk, be sure to format the floppy disk beforehand.

Refer to the Instruction Manual for the sewing machine for details on how to format a floppy disk.

(Remarks) 1. Use the pattern reading/writing functions to edit the patterns stored on the floppy disk. At this time, you can also change the pattern number.









(Remarks) 2. If you wish to terminate the operation, press the key. However, please note that you are not allowed to cancel writing the pattern data onto the floppy disk on the way.

2. Pattern reading/writing



< Pattern reading >

Function code : 

This function is used to read the pattern data stored on the floppy disk.

- 1) Press the  and  keys until  is shown by the  LED.
- 2) Press the  key.
- 3) Press the  and  keys until the pattern number of the data to be read from the floppy disk is shown.
- 4) Press the  key.
- 5) Pattern reading starts.

(Remarks) 1. The newly read pattern newly read will be added to the pattern data already existing, while taking the current position of the needle as the start point.





(Remarks) 2. The newly read pattern will be added at the desired position in the current pattern data by changing the needle position using the  and  keys.

(Remarks) 3. As long as you have specified the scale using the scale setting function (Function code : ) before reading the pattern, it will be possible to read the pattern while enlarged/reduced according to the scale. You can now select either "INC or DEC of the stitch length" or "INC or DEC of the number of stitches" using the INC/DEC of the stitch length or the stitch number selector switch in the control box. Refer to the Instruction Manual for the sewing machine for details on the switch setting.

(Remarks) 4. To terminate this operation, press the  key. However, please note that you are not allowed to reading cancel the pattern data from the floppy disk on the way.



< Scale setting >

Function code : 

- 1) Press the  and  keys until  is shown by the  LED.
- 2) Press the  key.

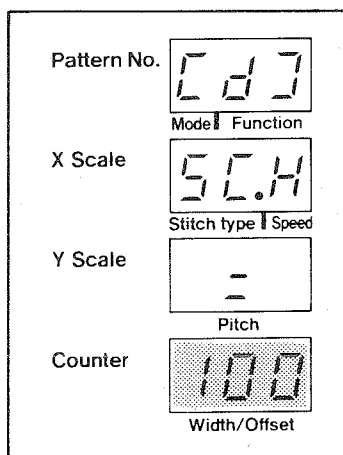
[x-scale setting]



- 3) Press the  and  keys until the desired scale is shown by the Width/Offset LED.

← X-scale when reading a pattern from the floppy disk.

- 4) Press the  key. 001 to 400% (100 : original size)

VI. PATTERN INVERSION

< Invert function setting >

Function code : 14

If you use the pattern invert function, you should set the function using this feature.

- 1) Press the 8▲ and 2▼ keys until 14 is shown by the Function LED.
- 2) Press the Reset (Select) key.

[Inverting function setting]

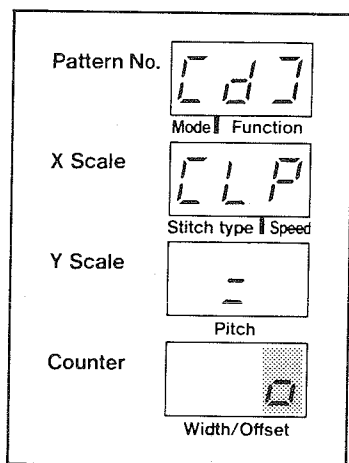

- 3) Press the 8▲ and 2▼ keys until the desired form of inversion is displayed on the Width/Offset LED.

□ : Without the invert function

A : Automatic inversion

h : Optional inversion

← The invert function is displayed here.

- 4) Press the Counter (Set) key.

< Inversion >

Function code : 14

Use this function to input the point of inversion when the optional inversion is selected in the invert function setting.

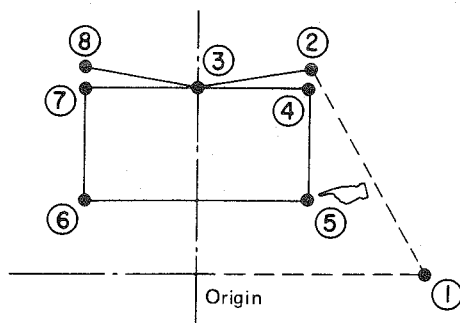

- 1) When the needle stays at point ⑤, press the 8▲ and 2▼ keys until 14 is shown by the Function LED.

- 2) Press the Reset (Select) key.

The example given shows the case where the machine jumps from the origin to point ②, inverts points ② through ⑤, and performs linear stitching for points ⑥, ⑦, ③ and ⑧ in the order given. (Although points ② and ④ are illustrated as separated, they are in fact one and the same point.

(Points ⑦ and ⑧ are also one and the same point.)

(Caution) 1. The point of inversion on the created pattern data can be specified as you wish. However, the inverting crank will face to the left at the sewing start and will then turn to the right at the first of inversion point. After that, it will turn in alternate directions at every point of inversion. Consequently, the specified number of points of inversion should be an odd number. If an even number is specified, the inverting clamp will face to the left . As a result, the crank may come in contact with the needle at the sewing end causing the needle to break.

(Caution) 2. You cannot specify a point of inversion in the following positions.

- Jumping section at the sewing start
- Immediately after the second origin
- Immediately after the thread trimming

VII. CHECKING THE SET VALUE

The number of stitches, scale etc. of the created pattern data can be visually checked on the LEDs whenever you wish.

< Checking the set value >

Function code : H1

- 1) Press the 8▲ and 2▼ keys until H1 is shown by the Function LED.
- 2) Press the Reset (Select) key.



[Indication of the total number of stitches]

Pattern No. C d J
Mode | Function

X Scale n d L
Stitch type | Speed

Y Scale -
Pitch

Counter 0 8 0
Width/Offset

(Hereafter, pressing the 8▲ and 2▼ keys will enable you to visually check each set value. Press the Counter (Set) key or 0 (Cancel) key to terminate the operation.)

← Total number of stitches (Unit : x 10)
The total number of stitches in the example given is 800.
(The smallest number of figures is rounded up to the nearest whole number.)

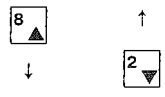

[Indication of the sewing speed]

Pattern No. C d J
Mode | Function

X Scale L 5 P
Stitch type | Speed

Y Scale -
Pitch

Counter β α α
Width/Offset

0.02 : 200spm	4.09 : 900spm	8.13 : 1300spm	C.17 : 1700spm
1.06 : 600	5.10 : 1000	9.14 : 1400	d.18 : 1800
2.07 : 700	6.11 : 1100	A.15 : 1500	E.19 : 1900
3.08 : 800	7.12 : 1200	b.16 : 1600	F.20 : 2000
-.- : Value determined by the stitch length.			

← β : Speed symbol
α α : Sewing speed (x 100 s.p.m.)





[Indication of the invert function]

Pattern No.

Mode | Function

X Scale

Stitch type | Speed

Y Scale

Pitch

Counter

Width/Offset

- : Without the invert function
- : Automatic inversion
- : Optional inversion

← Invert function
In the example, the invert function is set to “without the invert function.”

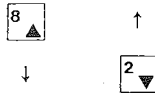

[Indication of the x-scale]

Pattern No.

Mode | Function

X Scale

Stitch type | Speed

Y Scale

Pitch

Counter

Width/Offset

← X-scale when reading a pattern from the floppy disk.
001 to 400% (100 : original size)
Set to 200% in the example given.



[y-scale setting]

Pattern No.

Mode | Function

X Scale

Stitch type | Speed

Y Scale

Pitch

Counter

Width/Offset

← Y-scale when reading a pattern from the floppy disk.
001 to 400% (100 : original size)
Set to 150% in the example given.





[Indication of the input pattern number]

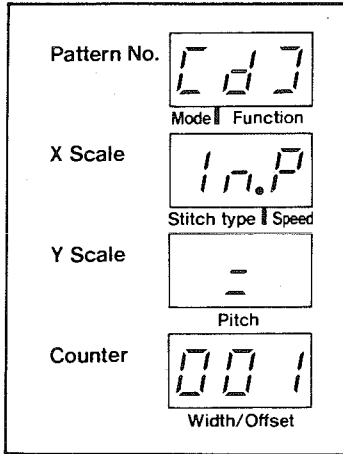

← Pattern number to be read from the floppy disk. (001 to 999)
Set to 001 in the example given.



[Indication of the output pattern number]

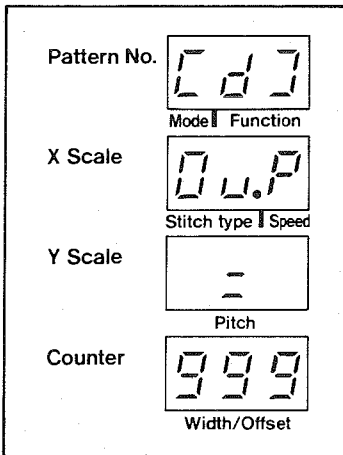

← Pattern number to be written onto the floppy disk. (001 to 999)
Set to 999 in the example given.

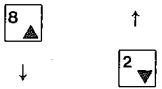



















[Indication of the total number of stitches]

[Described on page 30]

VIII. OPERATING PROCEDURE



< Pattern reading >

Read the pattern data stored on the floppy disk.

- Step 1 Press the  and  keys until  [Scale setting] is shown by the  LED.
- Then press the  key.
- Step 2 Press the  and  keys until the desired x-scale is shown by the LED. Then press the  key.
(Scale range : 001 to 400 with 100 taken as the original size of the pattern)
- Step 3 Press the  and  keys until the desired y-scale is shown by the LED. Then press the  key.
(Scale range : 001 to 400 with 100 taken as the original size of the pattern)
Note that steps 1 through 3 described above are unnecessary if the pattern is not enlarged/reduced.
- Step 4 Press the  and  keys until  [Pattern reading] is shown by the  LED.
- Then press the  key.
- Step 5 Press the  and  keys until the desired input pattern number is shown by the LED. Then press the  key.
- Now the pattern reading will start.





< Test sewing >

By performing test sewing, you should confirm the shape of the pattern read out from the floppy disk or created using the input functions.

- Step 1 Press the  key.
- Step 2 The READY lamp will light up. The feeding frame will retrieve the origin and move to the sewing start point. The work clamp will then go up.
- Step 3 Test sewing can be performed during a normal sewing procedure. By performing test sewing, check the shape of the created pattern data before you start actual sewing. (Refer to the sewing machine Instruction Manual for details on how to sewing machine.)
- Step 4 Press the  key again.
- The "Input" section of the READY lamp will light up, the feeding frame will return to the origin and the work clamp will come down.
- Now the machine will enter the standby mode, waiting for a function to be set after the origin (before the created pattern data). If you wish to modify the pattern data or add more data, press the  key to make the needle go forward.

< Pattern writing >

Write onto the floppy disk the pattern which has either been read from the floppy disk or created using the input functions.

- Step 1 Press the  and  keys until  is shown by the  LED [Pattern writing].
- Then press the  key.

Step 2 Press the and keys until the output pattern number of the data to be written onto the floppy disk is shown.

Then press the key.

The machine checks whether the designated pattern data have already been stored on the floppy disk. If the pattern data are stored on the floppy disk under the designated number, the following indication will be shown by the LEDs.

If the pattern data under the designated number are not stored on the floppy disk, the data will be written onto the floppy disk under that number.

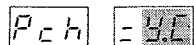

In this case, if you wish to update the data stored on the floppy disk under the designated number, press the key.

If you wish to cancel writing the pattern data onto the floppy disk under the designated number, press the key.

< Pattern input >

Now let's input the pattern illustrated below.

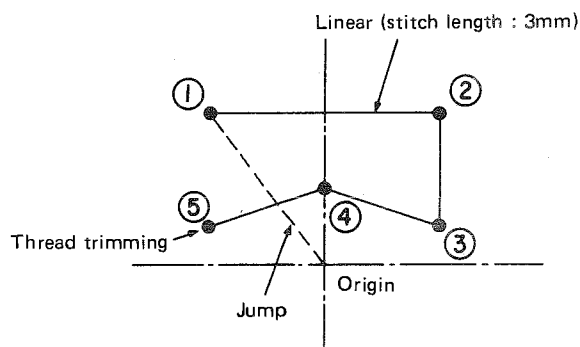

Create the pattern by jumping from the origin to point ① and Linear stitching from point ② through ⑤ with a stitch length of 3 mm. Then trim the thread at the sewing end.

Step 1 Set the original drawing on the machine.

Step 2 Press the and keys until [Jump input] is shown by the LED.
Then press the key.

Step 3 Press the , , keys until the needle reaches position ① shown in the figure.

Step 4 Press the key. (This step can be skipped.)

Step 5 Press the key or the key.

Step 6 Press the and keys until [Linear input] is shown by the LED.
Then press the key.

Step 7 Press the and keys until a stitch length of is shown by the LED.
Then press the key.

Step 8 Press the , , keys until the needle reaches position ② shown in the figure.

Step 9 Press the key.

Step 10 Repeat steps 8) and 9) until points through ⑤ have been entered. (Do not press the key after point ⑤ has been entered.)

Step 11 Press the key or the key.

Step 12 Press the and keys until [Thread trimming] is shown by the LED.
Then press the key.

< Pattern modification >

You can modify a pattern created using the input functions or read from the floppy disk, by using seven different kinds of modification functions.

To modify a pattern, move the needle to the position of the data to be modified using the or keys.

The following is an explanation of the pattern modification procedure using the pattern created in the section "Pattern input."

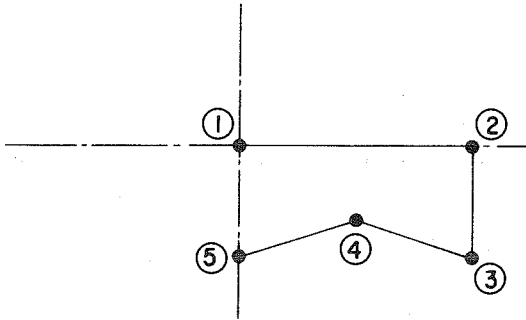

Fig. 1

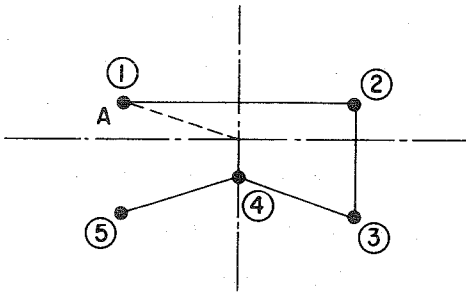

Fig. 2

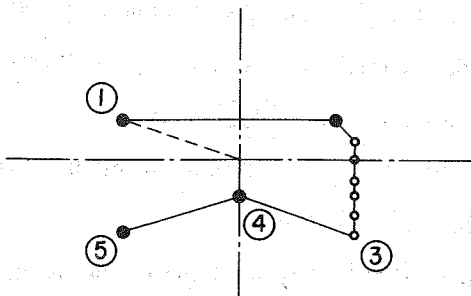

Fig. 3

Step 1 Press the or keys to make the needle move to the section of data up to point ① created using the jump input function. (The needle will be brought to its origin.)

Step 2 Press the and keys until [Element deletion] is shown by the LED. Then press the key.

This erases the data up to point ① created using the jump input function. The needle will then return to its origin. The pattern now has a Linear stitch between point ② and point ⑤ starting from the origin, as illustrated in Fig. 1.

Step 3 Press the and keys until [Jump input] is shown by the LED. Then press the key.

Step 4 Press the keys until the needle reaches position A shown in Fig. 2.

Step 5 Press the key. (This step can be skipped.)

Step 6 Press the key or the key.

Step 7 Using the and keys, move the needle to confirm that the position of the pattern has moved as illustrated in Fig. 2.

Step 8 Press the and keys until the needle reaches position ② shown in the figure.

Step 9 Press the and keys until [Point deletion] is shown by the LED. Then press the key.

Step 10 Now the LEDs will indicate , which means that the Linear stitching from point ② to point ③ will be changed to point stitching. Then press the key.

Step 11 If you wish to delete a certain number of entry points, designate the section containing the points to be deleted by pressing the **Forward** key to move the needle. Now press the **Counter (Set)** key only.

Step 12 Move the needle using the **Forward** and **Backward** keys, and confirm that the needle entry point has been erased as illustrated in Fig. 3.

Step 13 Move the needle to the position where a point is to be newly added. Then press the **8** and **2** keys until **03** [Point addition (absolute)] is shown by the **Function** LED. Then press the **Reset (Select)** key.

Step 14 **Pch = 4.0** will be shown by the LEDs. Press the **Counter (Set)** key.

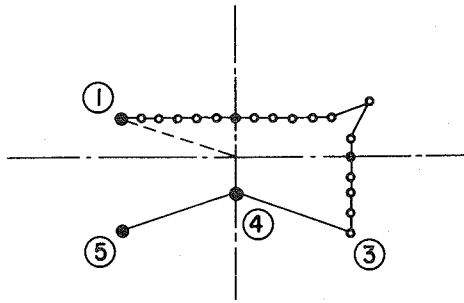

Fig. 4

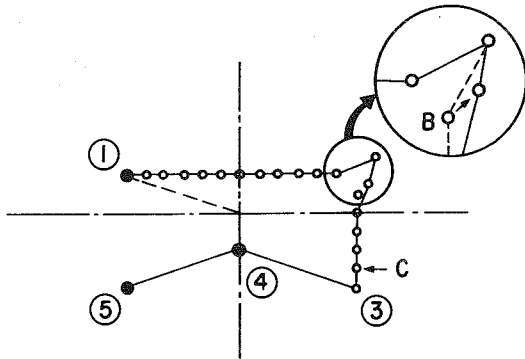

Fig. 5

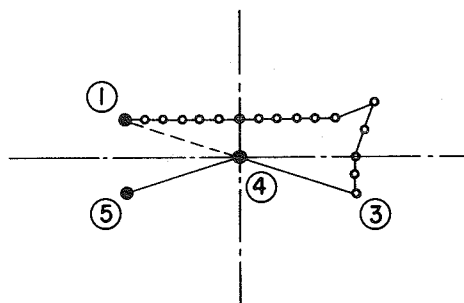

Fig. 6

Step 15 Press the **4** **8** **2** keys until the needle reaches the position where a point is to be added. Then press the **Y Scale (end)** key.

Step 16 Move the needle using the **Forward** and **Backward** keys, and confirm that the needle entry point has been added as illustrated in Fig. 4.

Step 17 Move the needle to position B show in Fig. 5. Then press the **8** and **2** keys until **02** [Point movement (absolute)] is shown by the **Function** LED. Then press the **Reset (Select)** key.

Step 18 **Pch = 4.0** will be shown by the LEDs. Press the **Counter (Set)** key.

Step 19 Press the **4** **8** **2** keys until the needle reaches the position to which the point is to be moved. Then press the **Y Scale (end)** key.

Step 20 Move the needle using the **Forward** and **Backward** keys, and confirm that the needle entry point has been moved as illustrated in Fig. 5.

Step 21 Move the needle to position C shown in Fig. 5. Then press the **8** and **2** keys until **11** [Point deletion (relative)] is shown by the **Function** LED. Then press the **Reset (Select)** key.

Step 22 **Pch = 4.0** will be shown by the LEDs. Press the **Counter (Set)** key.

Step 23 Press the **Forward** key until the needle reaches position ③. Then press the **Counter (Set)** key.

Step 24 Move the needle using the **Forward** and **Backward** keys, and confirm that the needle entry point has been erased and the pattern after the deleted point has moved as illustrated in Fig. 6.

Step 25 Move the needle to position ④ shown in Fig. 6. Then press the **8** and **2** keys until **12** [Point movement (relative)] is shown by the **Function** LED. Then press the **Reset (Select)** key.

Step 26 **PCH = 5.1** will be shown by the LEDs. Press the **Counter (Set)** key.

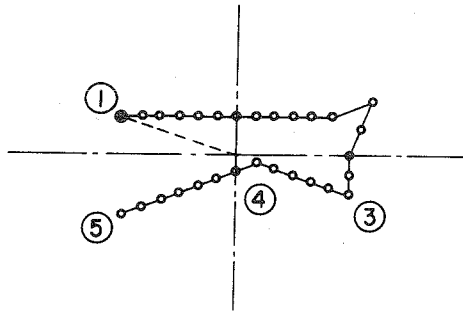

Fig. 7

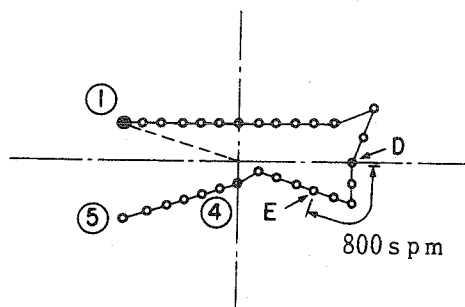

Fig. 8

Step 27 Press the **4**, **8**, **6** keys until the needle reaches the position to which the point is to be moved.

Then press the **Y Scale (end)** key.

Step 28 Move the needle using the **Forward** and **Backward** keys, and confirm that the needle entry point has been moved and the pattern after the moved point has shifted as illustrated in Fig. 7

Step 29 Move the needle to position D shown in Fig. 8.

Then press the **8** and **2** keys until **95** [Point speed changing] is shown by the **Function** LED.

Then press the **Reset (Select)** key.

Step 30 Press the **8** and **2** keys until the desired speed is shown by the **Speed** LED (set to **3** : 800 s.p.m. in the example given). Press the **Counter (Set)** key.

Step 31 Press the **Forward** key until the needle reaches point E. Then press the **Counter (Set)** key.

Step 32 Move the needle using the **Forward** and **Backward** keys, and confirm that the sewing speed for the section shown in Fig. 8 has been changed by checking the indication on LED.

IX. ERROR CODES



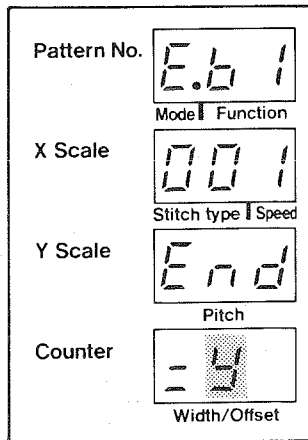





If an error occurs when the main unit input function is used, an error code (1 , 2 , 4 and 5) will be shown by the Error Number LED, followed by a buzzer sound. If error code 1 , 2 or 5 is shown detailed information on the error will also be displayed.



[Corrective measures]

- ① If error code 1 , 2 or 5 is shown, be sure to find the cause and eliminate the problem. Then press the Counter (Set) key. The needle will return to its origin. Then move the needle to the desired position by pressing the Forward and Backward keys, and continue with the input procedure.
- ② If error code 4 is shown, refer to the list of corrective measures below.

No.	Description	Cause	Corrective measure	Error during test sewing
1	Floppy disk error	<p>① Detailed code : 003 An attempt has been made to read a pattern number not stored on the floppy disk.</p> <p>② Detailed code : 004 The floppy disk has not been loaded.</p> <p>③ Detailed code : 005 An error has occurred when reading the data from the floppy disk.</p> <p>④ Detailed code : 006 An error has occurred when writing the data onto the floppy disk.</p> <p>⑤ Detailed code : 007 The write-protect tab is locked when writing the data onto the floppy disk.</p> <p>⑥ Detailed code : 008 The floppy disk is full.</p>	<p>① Use the correct pattern number.</p> <p>② Load the floppy disk.</p> <p>③ ④ Try again. If the error occurs, the floppy disk may be damaged.</p> <p>⑤ Unlock the write-protect tab and write the data onto the disk.</p> <p>⑥ Use another floppy disk.</p>	

No.	Description	Cause	Corrective measure	Error during test sewing
2	Enlargement error	① Detailed code :  The stitch length has exceeded the largest value, or the computable range has been exceeded in an attempt to make a pattern enlargement based on the number of stitches.	① Re-set the x/y scale and start again.	
3				Needle up error
4	Travel limit error	① When inputting a pattern, the maximum sewing area has been exceeded while operating keys  ,  ,  and  . ② The feeding frame is raised when inputting a pattern. ③ The maximum sewing area has been exceeded while moving the needle using the  and  keys. ④ After creating the data, the maximum sewing area was exceeded while moving the needle using the  key.	① Press any key other than the key of which direction has reached outside the sewing range. This allows the data to be input continuously. ② Press the  key. Then press the feeding frame switch so that the feeding frame comes down. ③ ④ Since the data have been created correctly, subsequent data can be entered continuously. However, the sewing range has been exceeded. Correct the data so that they do not exceed the maximum sewing area.	Travel limit error
5				Emergency stop error

No.	Description	Cause	Corrective measure	Error during test sewing
6	Main unit input error	<p>① Detailed code : 001 During data input, an error has occurred due to a misoperation.</p> <p>② Detailed code : 002 The number of stitches in the pattern has exceeded the maximum number of stitches.</p> <p>③ Detailed code : 010 A hardware error has occurred.</p> <p>④ Detailed code : 013 The data read from the floppy disk contain an error.</p> <p>⑤ Detailed code : 015 The data for point stitching in the pattern contain a stitch whose length exceeds the maximum stitch length.</p>	<p>① Perform the series of operations from the function setting again.</p> <p>② Check the number of stitches. (A pattern containing approximately 4,000 stitches can be created.)</p> <p>③ Perform the series of operations from the function setting again.</p> <p>④ Confirm the pattern data.</p> <p>⑤ Add a point to the pattern data so that stitch length does not exceed the maximum value.</p>	
7				Machine lock or needle position detector error
8				Solenoid connector error
9				Thread breakage error

* Refer to the Instruction Manual of the sewing machine for the detailed information on the errors in test sewing.

X. OPERATION PANEL

The panel sheets in seven different languages are supplied with the sewing machine. When you use the main unit input function, select one from among them and stick it on the panel face of the operation box.

READY Error Number **JUKI AMS**

Pattern No.	Forward	Pattern No.	7	8 ▲	9
X Scale	Backward	X Scale (review)	4 ◀	5 (Enter)	6 ▶
Y Scale	Return to Origin	Y Scale (end)	1	2 ▼	3
Counter	Reset (Select)	Counter (Set)	0 (Cancel)	Set Ready (Test)	

BEREIT Fehler numer **JUKI AMS**

Muster-Nr.	Vorwärts	Muster-Nr.	7	8 ▲	9
X-Skala	Rückwärts	X-Skala (Nachprüfen)	4 ◀	5 (Eingabe)	6 ▶
Y-Skala	Rückkehr auf Ursprung	Y-Skala (Ende)	1	2 ▼	3
Stückzahl	Zählwerk (Wählen)	Stückzahl (Einstellen)	0 (Löschen)	Bereitschaftsstellung (Test)	

PRET Numéro d'erreur **JUKI AMS**

N° de configuration	Avance	N° de configuration	7	8 ▲	9
Echelle X	Retour	Echelle X (Vérification)	4 ◀	5 (Entrée)	6 ▶
Echelle Y	Origine	Echelle Y (Fin)	1	2 ▼	3
Nb pièces	Remise à 0 (Sélection)	Nb pièces (Validation)	0 (Annuler)	Validation (Essai)	

Listo Número de error **JUKI AMS**

No. de patrón	Avance	No. de patrón	7	8 ▲	9
Escala X	Retroceso	Escala X (Revisar)	4 ◀	5 (Entrada)	6 ▶
Escala Y	Retorno a origen	Escala Y (Fin)	1	2 ▼	3
Contador	Reposicionar (Seleccionar)	Contador (Preparar)	0 (Cancelar)	Listo (Probar)	

Готово Сообщение об ошибке **JUKI AMS**

Номер образца строчки	Вперед	Номер образца строчки	7	8 ▲	9
Масштаб по координате X	Назад	Масштаб по координате X (Подтверждение)	4 ◀	5 (Ввод)	6 ▶
Масштаб по координате Y	Возврат к нулю	Масштаб по координате Y (Окончание)	1	2 ▼	3
Установка счетчика	Повторить установку счетчика (Выбор)	Установка счетчика (Назначение)	0 (Отмена)	Подготовка (Пробное шитье)	

縫製 差錯 显示 **JUKI AMS**

图案号码	向前送布	图案号码	7	8 ▲	9
X扩大缝小率	向后送布	X扩大缝小率 (确认)	4 ◀	5 (输入)	6 ▶
Y扩大缝小率	回至原点	Y扩大缝小率 (结束)	1	2 ▼	3
下线设定	交换下线 (选择)	下线设定 (指定)	0 (取消)	准备 (试缝)	

縫製 差錯 显示 **JUKI AMS**

圖案號碼	向前送布	圖案號碼	7	8 ▲	9
X擴大縫小率	向后送布	X擴大縫小率 (確認)	4 ◀	5 (輸入)	6 ▶
Y擴大縫小率	回至原點	Y擴大縫小率 (結束)	1	2 ▼	3
下線設定	交換下線 (選擇)	下線設定 (指定)	0 (取消)	準備 (試縫)	

