



Introduction

Your Proxima Lightbook Projector

The Proxima® Lightbook™ projector makes sharing data and presenting information as easy as connecting your computer to your monitor.

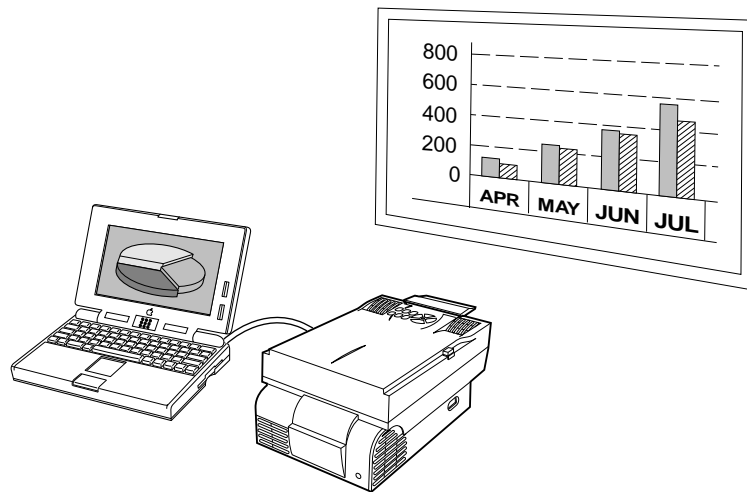

Figure i-1 The Proxima Lightbook projector in use

This manual covers the Proxima Lightbook family of light, portable projectors which provide images of unrivaled clarity and color accuracy.



WHAT'S IN THE BOX?

After you've opened the box and removed the projector and accessory packs, make sure you have all of the items shown in Figure i-2.

CAUTION! *The Proxima Lightbook projector should be treated like any other precision optical instrument. Handle it carefully.*

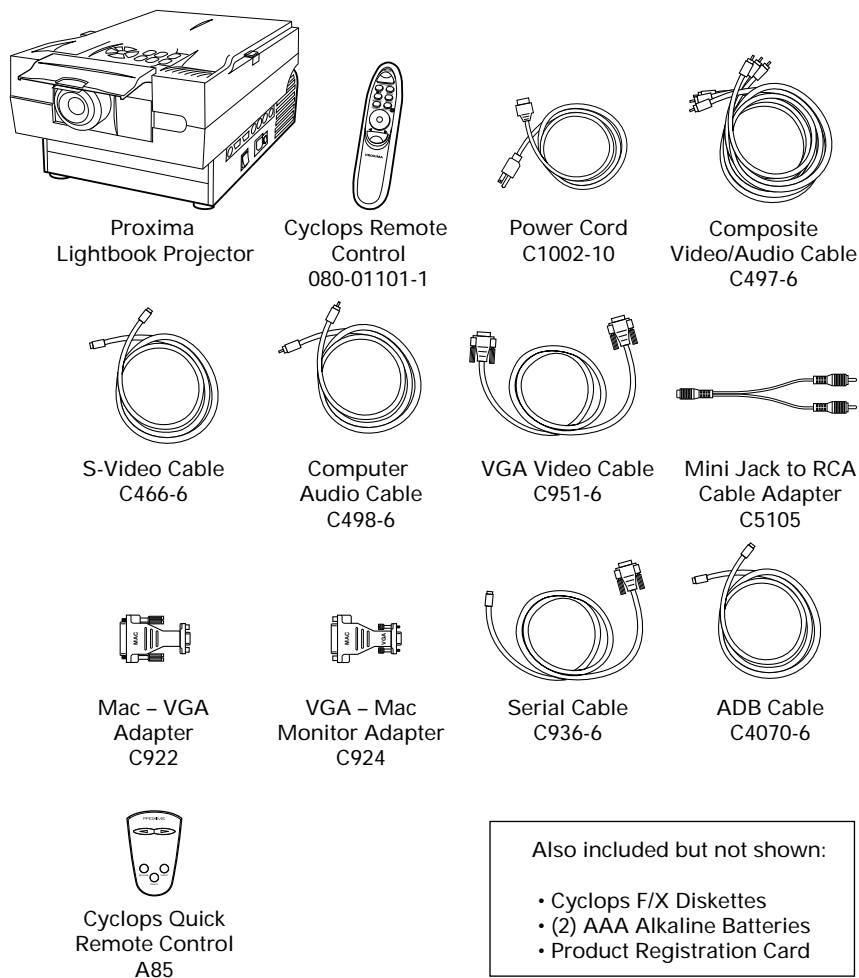

Figure i-2 Items included with the projector

Your projector also includes power cords for Europe, the United Kingdom, and Italy.



OPENING THE PROJECTOR

- 1 Press the gold buttons on both sides of the projector and pull the top assembly up. It will click into place.

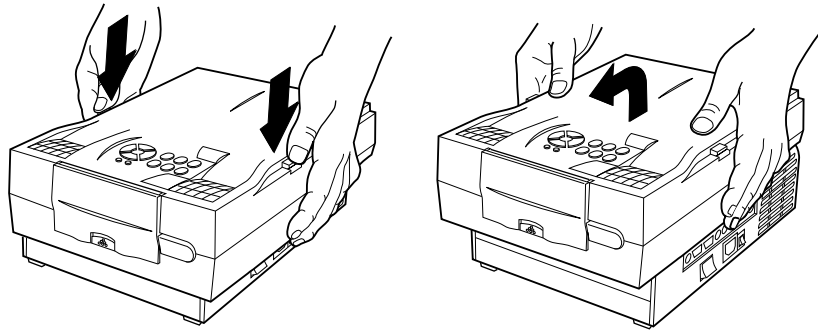



Figure i-3 Opening the projector

NOTE: The  and  indicators will both flash if the projector is not completely open.

- 2 Lift the gold front door latch to pop the lens open.

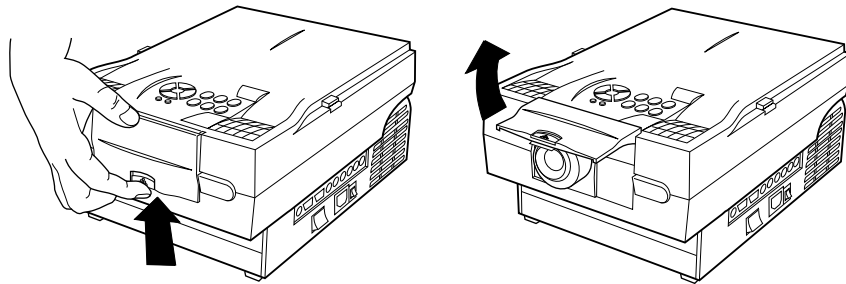

Figure i-4 Opening the lens



YOUR LIGHTBOOK PROJECTOR

Before you begin, locate the main parts of the Lightbook projector.

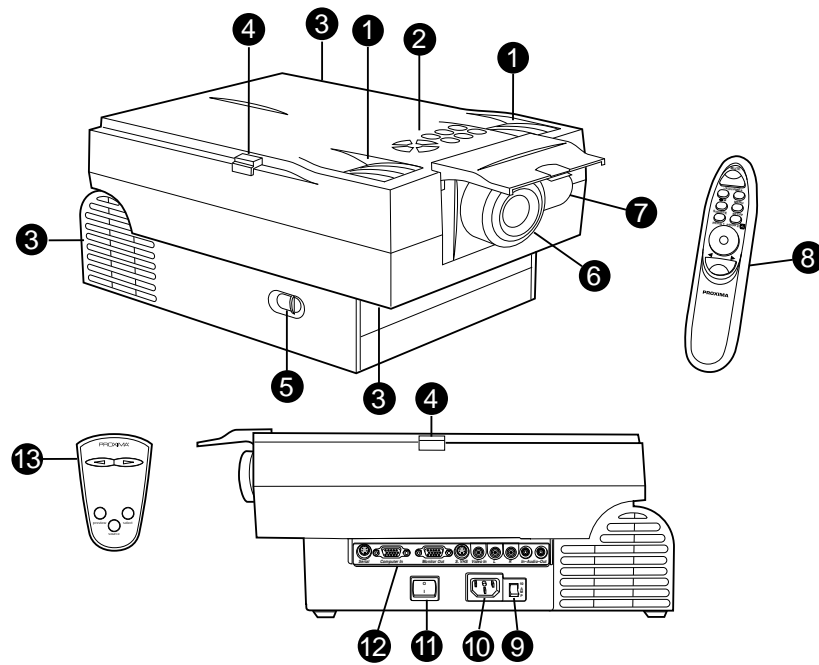

Figure i-5 The Lightbook projector and Cyclops Remote Control

- | | |
|--------------------------|--------------------------|
| 1 Internal Speakers | 8 Cyclops Remote Control |
| 2 Control Panel | 9 Circuit Breaker |
| 3 Cooling Fans | 10 Power Cord Receptacle |
| 4 Release Button | 11 Main AC Power Switch |
| 5 Keystone Adjustment | 12 Connector Panel |
| 6 Focus Ring | 13 Cyclops Quick Remote |
| 7 Remote Control IR Lens | |

CONNECTOR PANEL

All connections between the projector and computer or video source are made on the side connector panel.

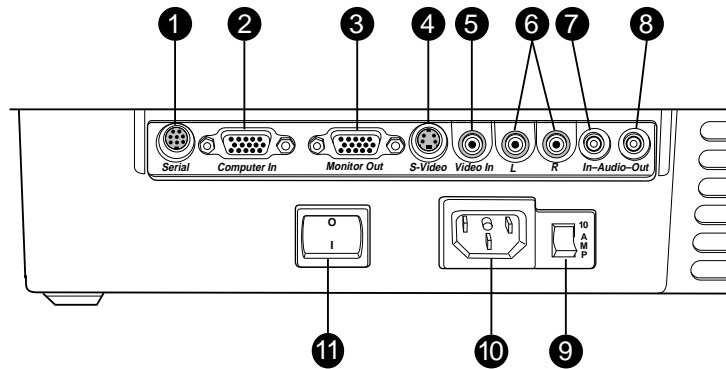



Figure i-6 The Connector Panel

	CONNECTOR	DESCRIPTION
1	SERIAL	Connects to your computer so you can use Cyclops F/X software.
2	COMPUTER IN	Connects computer video to the projector.
3	MONITOR OUT	Provides computer video output to a separate monitor.
4	S-VIDEO	Allows S-Video video input.
5	VIDEO IN	Allows video input from an NTSC, PAL, or SECAM source.
6	L-AUDIO-R	Allows stereo/mono audio input from an NTSC, PAL, or SECAM source.
7	AUDIO IN	Allows stereo/mono audio input.
8	AUDIO OUT	Provides audio output to an external stereo system.
9	AC CIRCUIT BREAKER	Restarts the system after a power failure.
10	AC PLUG	Connects AC power.
11	AC POWER	Turns the projector on or off.



CONTROL PANEL

Use the Lightbook projector's control panel keys to turn the projector on or off, adjust the projected image, and display and hide the menu. The  and  indicators provide status information about your projector.

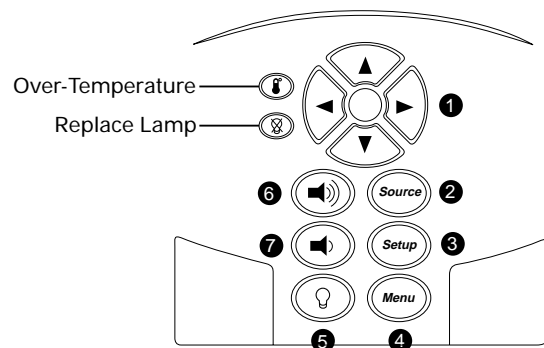
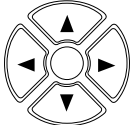







Figure i-7 The Control Panel

KEY	FUNCTION
1 	Controls the menu and adjusts screen position.
2 	Switches the video inputs.
3 	Activates the Setup menu.
4 	Displays or hides the menu.
5 	Turns the lamp on or off.
6 	Adjusts the volume.
7 	



LIGHT	FUNCTION
	Glows red to warn of an over-temperature condition. Flashes quickly if the projector is not fully opened.
	Flashes slowly if the spare lamp burns out. Glows red when the active lamp burns out. Flashes quickly if the projector is not fully opened.



QUICK START

Follow the appropriate section below for the type of system that you have. Be sure to observe the indicator lights when you power up the projector.

Connecting a Notebook

NOTE: If you are connecting to an Apple PowerBook, attach the Mac - VGA cable adapter to the computer's Video Out port (or video adapter cable).

- 1 Plug the **COMPUTER** end of the supplied VGA Video cable into the notebook's VGA Out port or into the Mac - VGA cable adapter (Macintosh only).

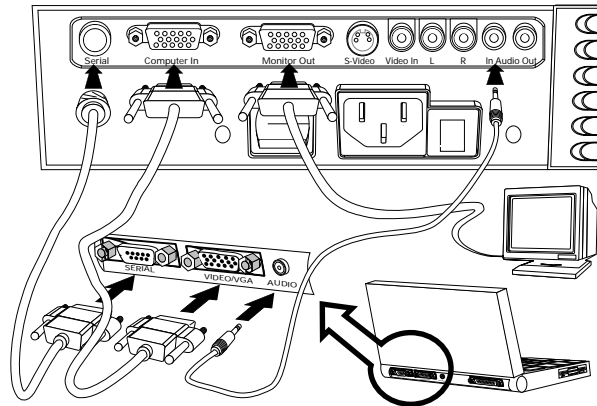

Figure i-8 Connecting a notebook

- 2 Plug the end of the VGA Video cable with the large round collar into the **COMPUTER IN** port on the projector.
- 3 Connect your audio source to the **AUDIO IN** port on the projector.
- 4 Turn the projector on.



Connecting Desktop PCs

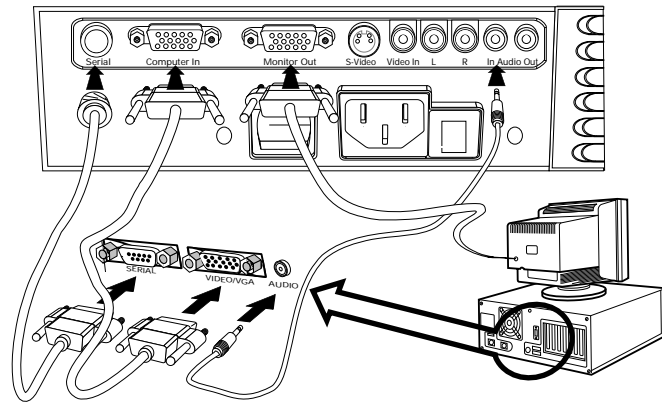

Figure i-9 Connecting a Desktop PC

- 1 Turn the PC power off. Unplug the monitor cable from the computer.
- 2 Plug the end of the supplied VGA cable with the large round collar into the COMPUTER IN port on the projector. Plug the other end into the computer's Monitor Out port.
- 3 Connect your audio source to the AUDIO IN port on the projector.
- 4 You can project without using the PC monitor. If you want to also use the monitor, plug the monitor cable into the MONITOR OUT port on the projector.
- 5 Turn the projector on.
- 6 Turn the computer on.



Connecting Macintosh Computers

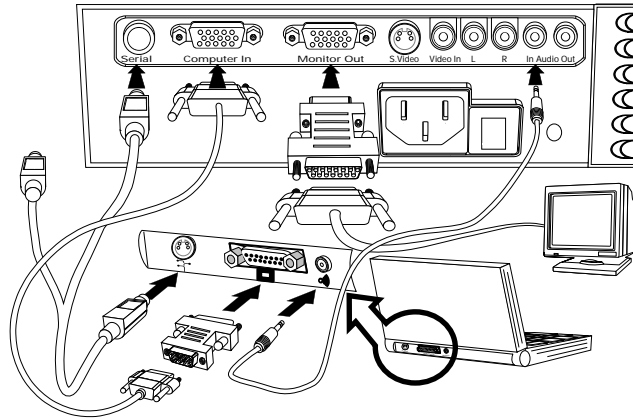

Figure i-10 Connecting a Macintosh

- 1 Unplug the existing monitor cable from your computer.
- 2 Plug the end of the supplied VGA video cable with the large round collar into the COMPUTER IN port on the projector. Attach the VGA end of the Mac - VGA cable adapter to the other end of the VGA video cable.
- 3 Plug the Mac end of the Mac - VGA cable adapter into your computer's video port.
- 4 Connect your audio source to the AUDIO IN port on the projector.
- 5 To project and view the monitor at the same time, plug the monitor cable into the Mac end of the VGA - Mac monitor adapter.

NOTE: The Lightbook projector only supports Multi-sync monitors for Macintosh computers.

- 6 Plug the VGA end of the VGA - Mac monitor adapter into the MONITOR OUT port on the projector.
- 7 Turn the projector on.

NOTE: If you turn the projector off while the computer is on, your external monitor will go blank. This is normal. Just turn the projector on again and the monitor display will return.



Connecting NTSC, PAL, SECAM, or S-Video

Use the supplied AV cable to connect an NTSC, PAL, or SECAM source to the projector. Use the supplied S-Video cable to connect an S-Video source.

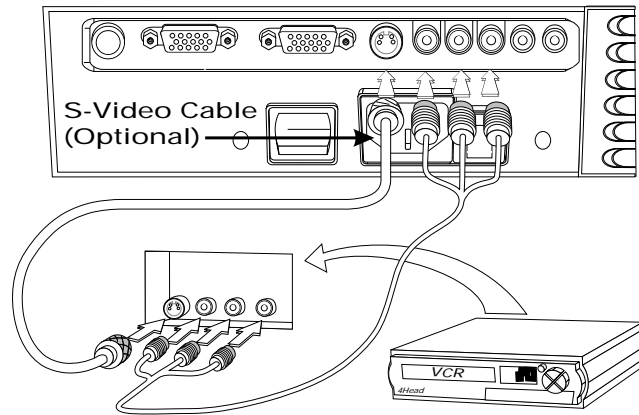

Figure i-11 Connecting video

Special Configurations

If your computer has an internal monitor but no external video capability (such as the Macintosh Performa 575, PowerMac 5200, and certain PowerBooks), you need a video adapter card to attach the Lightbook projector.

Setup for a third-party adapter is identical to the procedures outlined in the *Quick Start* section above. Contact your dealer, Proxima Customer Service, or a third-party supplier for more information about an appropriate video adapter.



CLOSING THE PROJECTOR

- 1 Close the lens door latch.

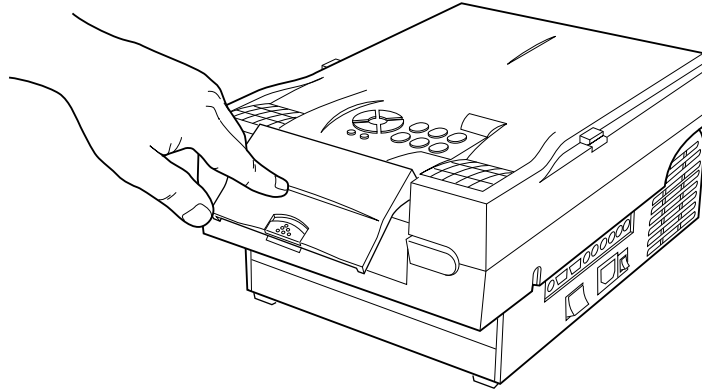

Figure i-12 Closing the lens

- 2 Press both gold buttons to release the top assembly

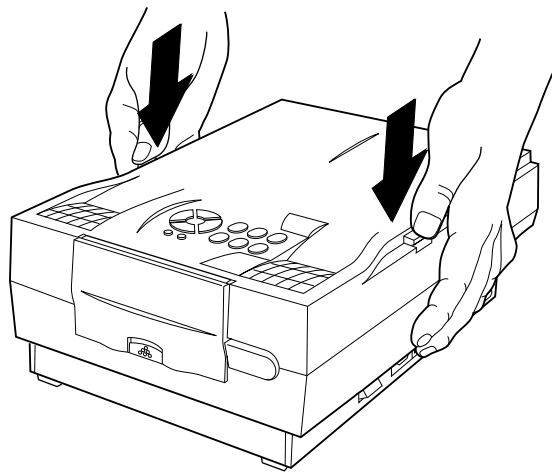

Figure i-13 Releasing the projector top

- 3 Gently press down and pull back on the assembly until it clicks into place.



Chapter 1

Setting Up the Lightbook Projector

POSITIONING THE PROJECTOR

Place the projector on a solid, flat surface at a right angle (perpendicular) to the projection screen and parallel to the floor. If you are using a media cart, make sure the wheels are locked to prevent it from moving.

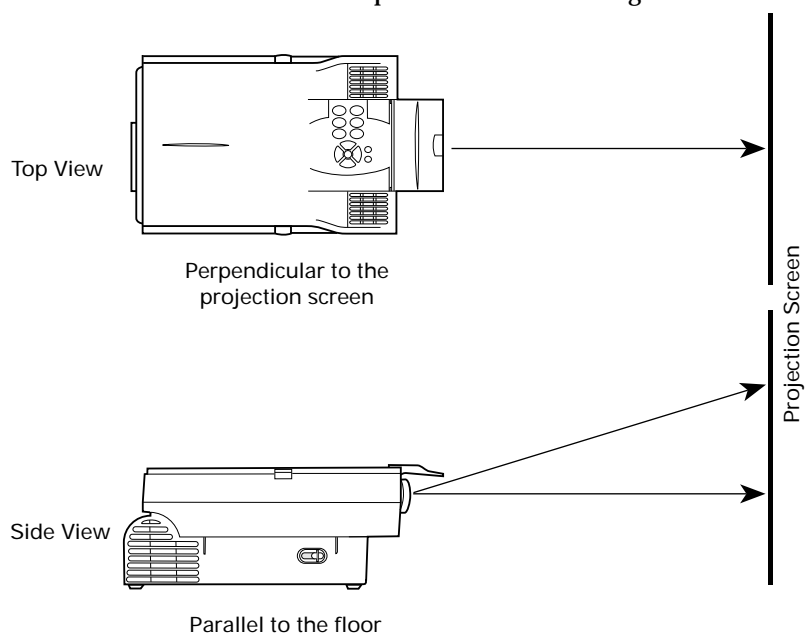

Figure 1-1 Positioning the projector



TRANSPORTING AND MOVING THE PROJECTOR

Always use the supplied carrying case to transport the projector. If you are moving the projector a short distance, grasp it securely at the sides by the lower parts of the housing to support the weight of the unit.

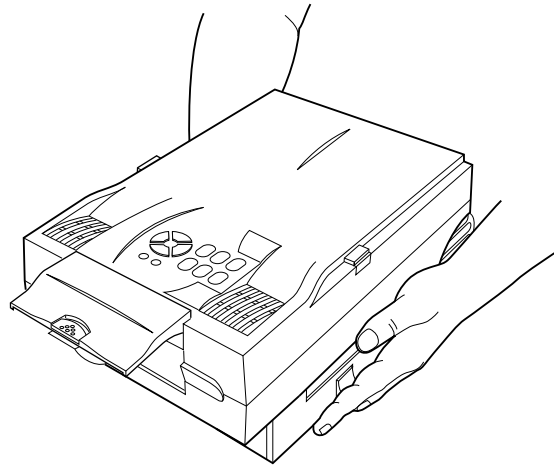

Figure 1-2 Moving the projector

Projector Cooling and Airflow

Locate the air intake grills under the front of the projector and in the left rear corner, and the air exhaust grill in the right rear corner.

⚠ CAUTION! Never operate the projector if these grills are clogged or obstructed, or if the electric fans are not running.

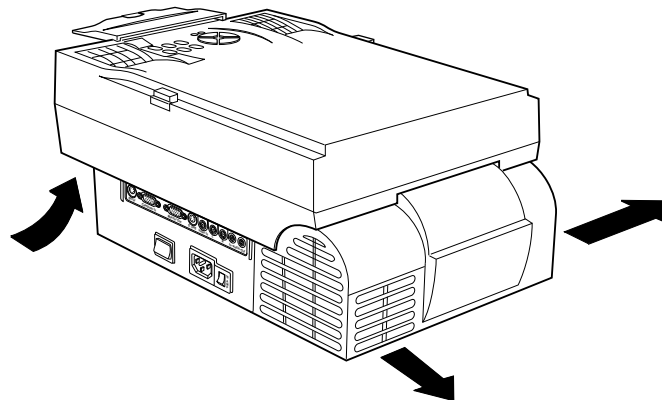

Figure 1-3 Allow for proper air flow

CONNECTOR PANEL

All connections between the projector and your computer or video source are made on the side connector panel.

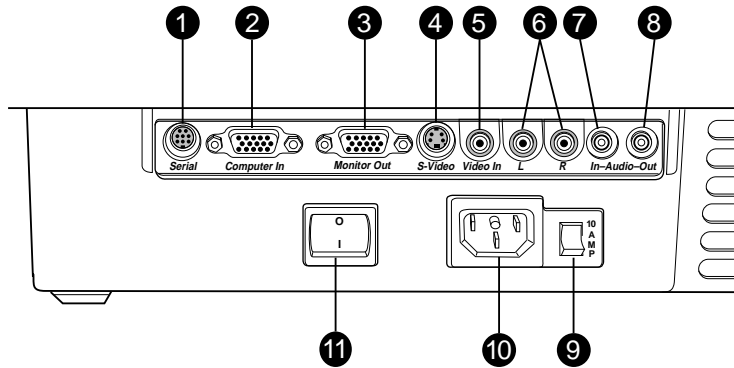

Figure 1-4 The Connector Panel

	CONNECTOR	DESCRIPTION
1	SERIAL	Connects to your computer so you can use Cyclops F/X software. Use a serial connector for a PC, ADB connector for a Macintosh.
2	COMPUTER IN	Connects computer video to the projector.
3	MONITOR OUT	Provides computer video output to a separate monitor.
4	S-VIDEO	Allows S-Video video input.
5	VIDEO IN	Allows video input from an NTSC, PAL, or SECAM source.
6	L-AUDIO-R	Allows stereo/mono audio input from an NTSC, PAL, or SECAM source.
7	AUDIO IN	Allows stereo/mono audio input.
8	AUDIO OUT	Provides audio output to an external stereo system.
9	AC CIRCUIT BREAKER	Restarts the system after a power failure.
10	AC PLUG	Connects AC power.
11	AC POWER	Turns the projector on or off.



CONNECTING POWER TO THE PROJECTOR

The power cord receptacle, AC POWER switch, and circuit breaker are located below the connector panel of the projector.

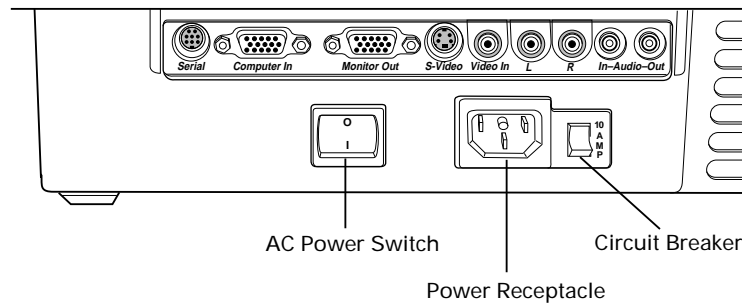

Figure 1-5 Power receptacle, AC Power switch, and circuit breaker reset switch

- 1 Plug the appropriate power cord into the power receptacle on the side of the projector.
- 2 Connect the other end of the power cord to a properly-grounded wall outlet.



CONNECTING YOUR COMPUTER

Connecting Notebook Computers

Use the appropriate cable and adapter to connect your notebook computer to the projector.

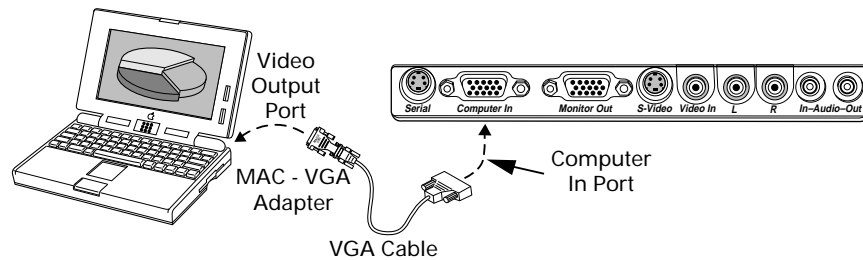

Figure 1-6 Notebook connections

NOTE: If you are using an Apple PowerBook, attach the Mac - VGA cable adapter to the computer's Video Output port (or video adapter cable).

- 1 Plug the end of the supplied VGA cable with the large round collar into the computer's VGA or Video Out port or into the Mac - VGA cable adapter (Macintosh only).
- 2 Plug the other end of the VGA cable into the COMPUTER IN port on the projector.
- 3 If you want audio, connect your audio source to the AUDIO IN port on the projector.
- 4 Turn the projector on.

NOTE: If your projector is unable to project an image at the same time your laptop monitor displays an image, refer to your laptop documentation for information on switching between the internal screen and the video port.



Connecting PCs

Use the included VGA video cable to connect your PC to the projector's COMPUTER IN port. If you want to use your monitor and Lightbook projector at the same time, use your existing monitor cable to connect the projector to the monitor.

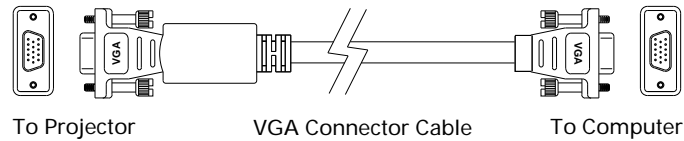

Figure 1-7 VGA Video cable

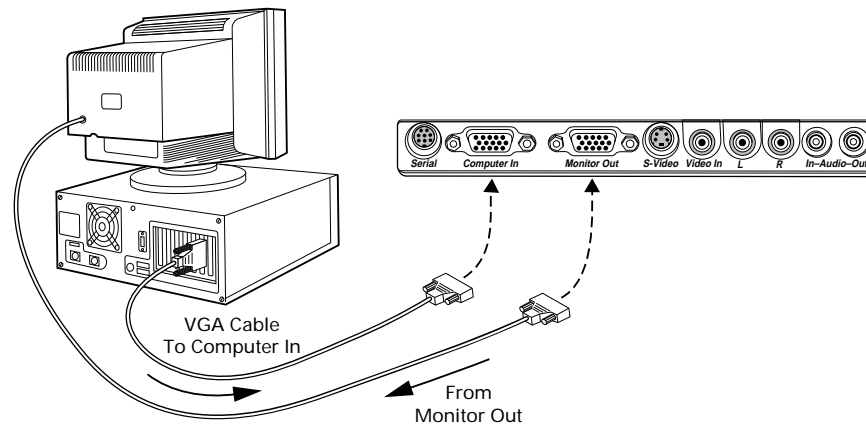

Figure 1-8 Connecting a PC

- 1 Unplug the monitor cable from the computer.
- 2 Plug the end of the supplied VGA cable with the large round collar into the projector's COMPUTER IN port. Plug the other end of the VGA cable into the computer's Video Out (VGA) port.
- 3 If you want audio, connect your audio source to the AUDIO IN port on the projector.
- 4 If you want to use an external monitor, connect the monitor cable to the projector's MONITOR OUT port.
- 5 Turn the projector on.

NOTE: An external monitor is not required to use the Lightbook projector.





Connecting Macintosh Computers

Use the video adapters shown below to connect a Macintosh computer and monitor to the Lightbook projector.

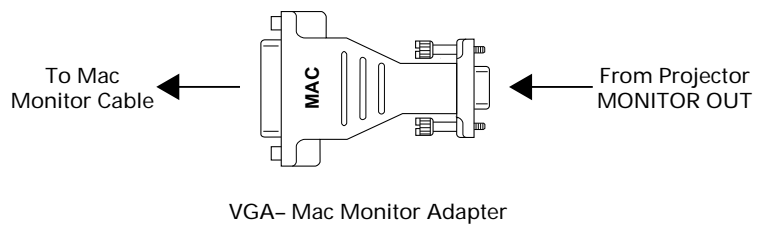
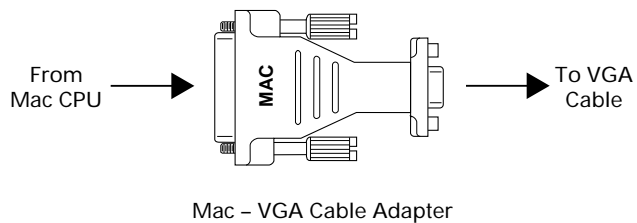

Figure 1-9 The Macintosh adapters

Use the cable adapters and supplied VGA video cable to connect the projector to your Macintosh computer.

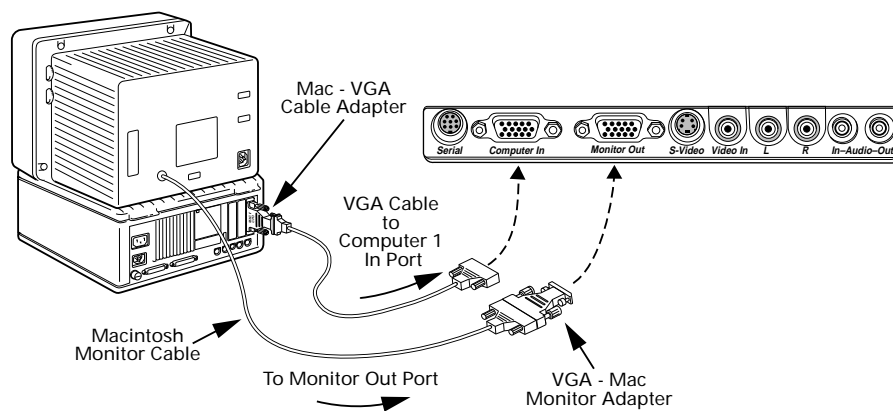

Figure 1-10 Connecting a Macintosh



- 1 Unplug the Macintosh monitor cable from the computer.
- 2 Plug the end of the supplied VGA video cable with the large, round collar into the COMPUTER IN port on the projector. Attach the VGA end of the Mac - VGA cable adapter to the other end of the VGA video cable.
- 3 Plug the Mac end of the Mac - VGA cable adapter into the Macintosh video port.
- 4 Connect the audio source to the AUDIO IN port.
Use the VGA - Mac monitor adapter and your existing monitor cable to connect the projector to a separate computer monitor, so you can view computer video on the projector screen and the monitor at the same time.
- 5 To project and view the monitor at the same time, plug the monitor cable into the Mac end of the VGA - Mac monitor adapter.
- 6 Plug the VGA end of the Mac - VGA monitor adapter into the MONITOR OUT port on the projector.
- 7 Turn the projector on.

NOTE: An external monitor is not required to use the Lightbook projector.

Special Configurations

If your computer has an internal monitor but no external video capability (Macintosh Performa 575, PowerMac 5200, and certain PowerBooks), you need a video adapter card in order to attach the projector.

Setup for a third-party adapter is identical to the procedures outlined in the *Quick Start* section in the introduction chapter. Contact your dealer, Proxima Customer Service, or a third-party supplier for more information about an appropriate video adapter.



CONNECTING COMPUTER AUDIO

Use the composite audio cable to connect your audio source to the AUDIO IN port on the projector.



Figure 1-11 Audio In port

- 1 Insert one end of the computer audio cable into the Audio Out port of a Macintosh or the sound card of a PC.
- 2 Insert the other end into the projector's AUDIO IN port.

NOTE: Although both AUDIO and AUDIO IN may be connected at the same time, only one can be active. If computer video is selected, AUDIO IN is active. If NTSC, PAL, SECAM, or S-Video is being viewed, AUDIO is active.

CONNECTING COMPOSITE VIDEO

You can display composite video (NTSC, PAL or SECAM) on the projector.

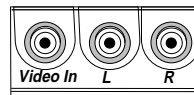

Figure 1-12 Video In port

Use the supplied composite Video/Audio cable (see page i-2) to connect an NTSC, PAL, or SECAM source to your projector.

- 1 Find the RCA connector on your video source marked Video Out or something similar. This connector is typically yellow. Insert one of the AV cable's yellow connectors into the Video Out jack of the video source.
- 2 Insert the other yellow connector into the projector's VIDEO IN port.



CONNECTING AN S-VIDEO SOURCE

To connect an S-Video source, use the supplied S-Video cable (see page i-2) instead of an RCA cable connection for the video source. The S-Video cable has identical, round, 4-pin mini-DIN connectors on both ends.



Figure 1-13 The S-Video port

To connect an S-Video source:

- 1 Insert one end of the S-Video cable into the mini-DIN Video Out port on the video source.
- 2 Insert the other end of the S-Video cable into the projector's S-Video port.

NOTE: The S-Video cable does not carry an audio signal. Use the red and white connectors on the AV cable (see *Connecting L-Audio-R Ports* below) to connect Audio Out from your video source to the L-AUDIO-R ports on the projector.

CONNECTING AUDIO FROM A COMPOSITE VIDEO SOURCE

Use the supplied AV cable to connect stereo or monaural audio inputs from an NTSC, PAL, SECAM or S-Video source.

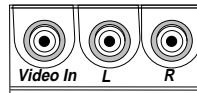

Figure 1-14 L-Audio-R ports

- 1 Insert one of the white connectors on the AV cable into the left Audio Out port of your video source. Insert the white connector on the other end into the L-AUDIO port on the projector.
- 2 Insert one of the red connectors on the AV cable into the right Audio Out port of your video source. Insert the red connector on the other end into the R-AUDIO port on the projector.



NOTE: Although both L-AUDIO-R and AUDIO IN may be connected at the same time, only one can be active. If computer video is selected, AUDIO IN is active. If NTSC/PAL/SECAM/S-Video is being viewed, the L-AUDIO-R ports are active.

If your TV audio source outputs only monaural audio, your projector will provide simulated stereo audio. Connect the audio source to the left AUDIO port and set the stereo mode to mono using the Audio menu.

PROJECTOR AUDIO OUT

Your projector contains an internal stereo system consisting of an amplifier and two speakers. Although this system provides high-quality stereo output, a multimedia presentation may require independently powered speakers or an external sound system.

NOTE: The projector's internal speakers can be turned on or off using the Audio menu (see page 2-21).



Figure 1-15 The Audio Out port

To connect your projector to an external stereo system or powered speakers:

- 1 Insert one end of the Computer Audio cable into the projector's AUDIO OUT port.
- 2 Insert the other end into the external amplifier or powered speaker system's Audio In port.
- 3 If you are using two powered speakers, connect speaker A to speaker B using the cables supplied with the powered speaker system.

NOTE: A mini-jack to RCA adapter is provided (see page i-2) in case your external speaker system has RCA input plugs.



CONNECTING TO THE SERIAL/ADB PORT

Use the SERIAL port to connect the projector and the computer in order to use the optional Cyclops F/X software.

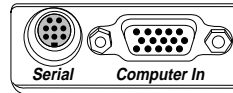

Figure 1-16 The Serial port

- 1 Connect one end of the serial cable to the projector's SERIAL port.
- 2 Connect the other end of the cable to the computer:
 - On a PC, connect the computer end to a serial port.
 - On a Macintosh, connect the computer end to an ADB connector.



Chapter 2

Using the Lightbook Projector

OPENING THE PROJECTOR

- 1 Press both gold buttons on the projector's sides.

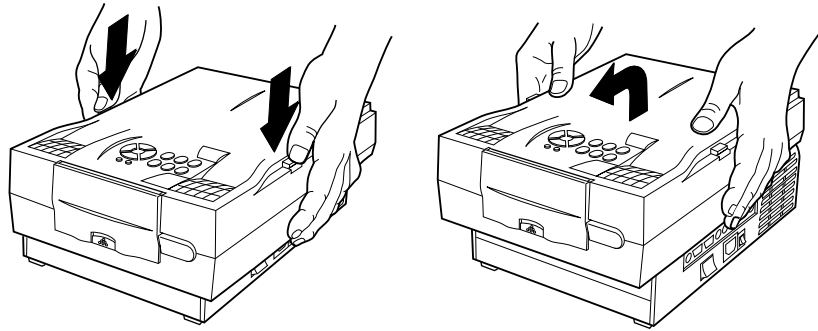



Figure 2-1 Opening the projector

- 2 Pull the top assembly up and forward. It will click into place.

NOTE: The  and  indicators will both flash if the projector is not completely open.

- 3 Lift the gold lens door latch. The lens door will pop open and the lens will extend.

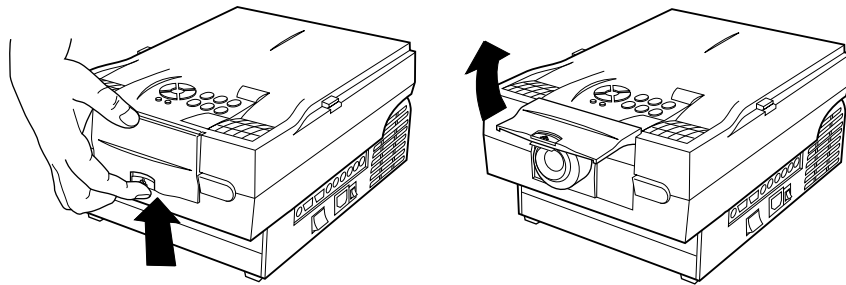

Figure 2-2 Opening the lens



TURNING ON THE PROJECTOR

- 1 Move the AC POWER switch to the ON position. The keypad lights up and the lamp turns on. The projector will beep once.

NOTE: Make sure to turn the projector on before you power up the computer. This allows the computer to sense the projector during its startup sequence.

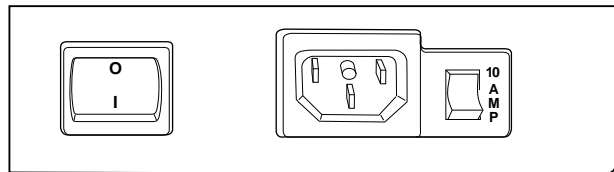

Figure 2-3 Projector power switch

- 2 Next, turn on your computer. If you turn the projector off while the rest of your computer system is running, your external monitor will go blank. This is normal. Just turn the projector on again and your monitor display will return.

CAUTION! Never operate the projector if the air intake or exhaust grills are clogged or obstructed, or if the electric fan is not running.

FOCUSING THE IMAGE

You can use the title screen that appears when you start the projector to make your focus adjustments. Rotate the focus ring to the right or left for the clearest image.

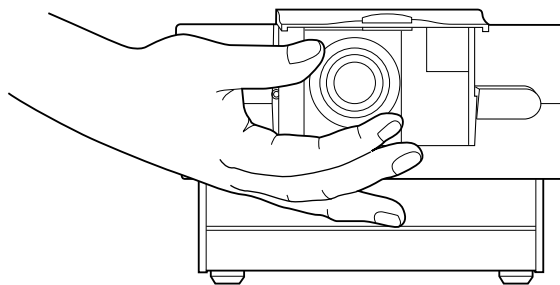

Figure 2-4 The Lightbook projector lens focus ring



CORRECTING A KEYSTONED IMAGE

The image may become distorted when you elevate the front of the projector.

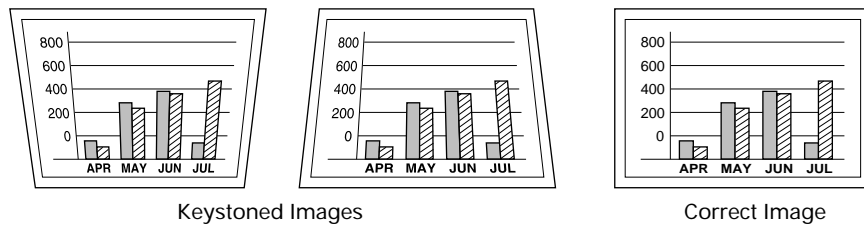

Figure 2-5 Keystone and square images

- 1 Move the keystone correction lever forward or back to adjust the shape of the image.

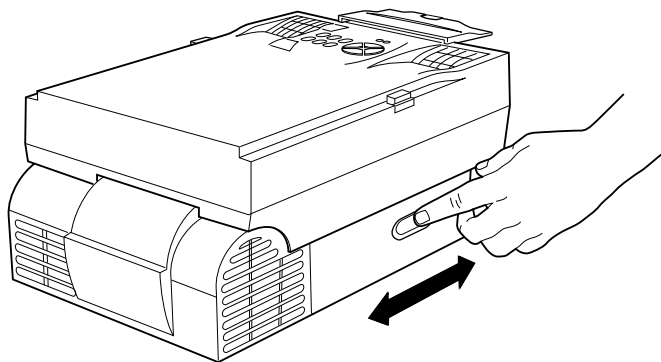



Figure 2-6 Correcting the keystone image

TURNING OFF THE PROJECTOR

- 1 Press the  key to turn the lamp off.
- 2 Let the projector cool until the fans turn off and then turn the AC POWER switch off.

⚠ CAUTION! Do not close the projector without allowing it to cool until the fans turn off.



CLOSING THE PROJECTOR

1 Close the lens door latch.

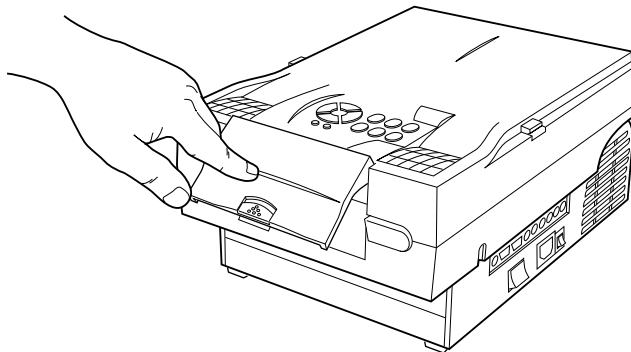

Figure 2-7 Closing the lens

2 Press both gold buttons to release the top assembly.

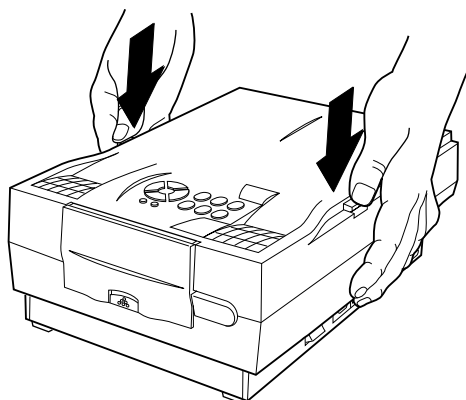

Figure 2-8 Releasing the projector top

3 Gently press down and pull back on the assembly until it clicks into place.



CONTROL PANEL KEYS

Use the control panel keys to turn the lamp on or off, adjust the projected image, and to display and hide the menu.

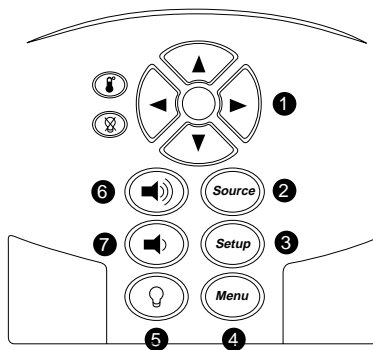
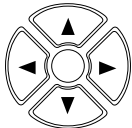











Figure 2-9 Control Panel keys

KEY(S)	FUNCTION
1 	Controls the menu and adjusts screen position.
2 	Switches through the video inputs.
3 	Activates the Setup menu.
4 	Displays or hides the menu.
5 	Turns the lamp on or off.
6 	Adjusts the volume up or down.
7 	



Lamp

The  key is used to turn the lamp on or off. Use this key when you want to present information without displaying the computer or video image, or to turn the lamp off to allow the projector to cool. When you turn the lamp on, the fans will run at a higher speed.

NOTE: If the lamp is off, you can still use the VOLUME   and MUTE keys to adjust the audio.

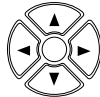

Arrows



The  keys allow you to:

- Make small adjustments in the position of the projected image. Press the arrow keys to shift the image in the direction indicated by the arrow, or
- Modify settings in the Menus.



Menu

Press the  key to display the menus in the upper portion of the projected image. Press the  key again to turn off the menus. Menu settings are automatically stored when you exit the menus or turn off the projector.

Source

The  key allows you to switch between active connected sources.

Volume

The volume keys display a slide bar to adjust the volume of the projector audio. Press the  key to increase or the  key to decrease the audio output levels. These keys control both internal and external audio levels.



Setup

Press the  key to display a series of Setup menus. The projector will display the slide bars in sequence to help you adjust the image. For example, if you are connected to a computer source, the SETUP key will cycle through slide bar adjusters for Contrast, Sync, and Image Position.

NOTE: If no video source is present, the Help screen will appear when you press Setup.

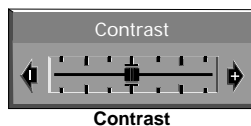





Figure 2-10 Sample Setup slide bar

Press  or  to adjust the selected item. Press  again to accept the new setting. The display disappears after five seconds if no actions are taken.

NOTE: The Setup options will be different for each type of input source.

SETTING	PURPOSE	AVAILABLE ON
Sync	Fine tune the clarity of the image.	Computer only
Contrast	Sharpen the image.	All sources
Brightness	Increase/decrease brightness.	Video
Image Position	Move the image left or right and up or down.	Computer, PAL/SECAM video in full scale model with Fit-To-View turned off (see page 2-20)
Tint	Changes the color tones.	Video
Saturation	Increase/decrease color.	Video
Pixel Skip	Adjusts the image for text mode.	Computer Text mode only



CONTROL PANEL INDICATORS

These indicators provide important status information about your projector.

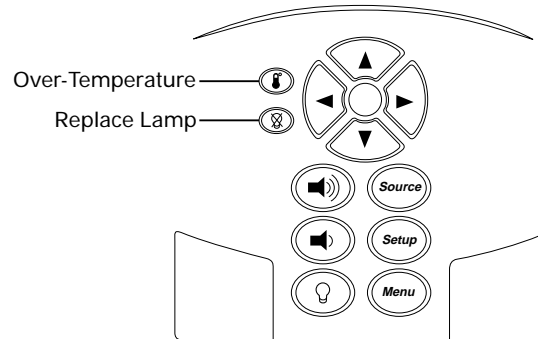





Figure 2-11 Lightbook projector's control panel indicators

INDICATOR	FUNCTION
	Glows red to warn of an over-temperature condition. Flashes quickly if the projector is not completely open.
	Flashes slowly if the spare lamp burns out. Glows red when the active lamp burns out. Flashes quickly if the projector is not completely open.

Over-Temperature

The  indicator glows red if the projector overheats. A thermostat automatically turns off the power to the lamp until the projector cools.

If an over-temperature condition occurs, perform the following checks while you allow the projector to cool:

- Verify that the room temperature is below 86° F (30° C).
- Check the intake and exhaust vents. Clear any obstruction to the air flow.
- Make sure that the fans are working. If the projector has reached an over-temperature condition and the fans are working, you should feel a strong flow of hot air from the left rear vent. If the fans are not working, the projector needs service.



NOTE: If you are using the projector at a high altitude location or in a warm room, you may want to switch to High Altitude mode (Preferences menu) to run the fans at a higher speed (see page 2-23).



After the projector returns to its normal operating temperature, turn the main power switch off and back on to clear the over-temperature indicator.



NOTE: The remote control's  key will not function after an over-temperature condition until the main power switch is turned off and on.

Projector Not Open

Both the  and  indicators will flash quickly if the projector is not completely open. Make sure that the projector locks into the open position.

Replace Lamp

The indicator will glow red if the primary bulb burns out. The indicator will flash if the spare projection lamp burns out. If both lamps have burned out, you cannot continue your presentation until you replace the lamp. See page 4-2 to replace the lamp.

NOTE: When the lamp nears the end of its life, it may shut off without the  lamp staying on. If this happens, press the  button twice. If the lamp does not stay on, switch to the spare bulb or replace it.



USING THE CYCLOPS REMOTE CONTROLS

The Cyclops® Remote Control contains all the key functions available on the projector control panel as well as several additional features.

The Cyclops Quick Remote allows you to control several of the projector's most popular features. For best results, aim the remote control at the projection screen or at the projector's front panel. Do not obstruct the red infrared eye located on the front of the projector.

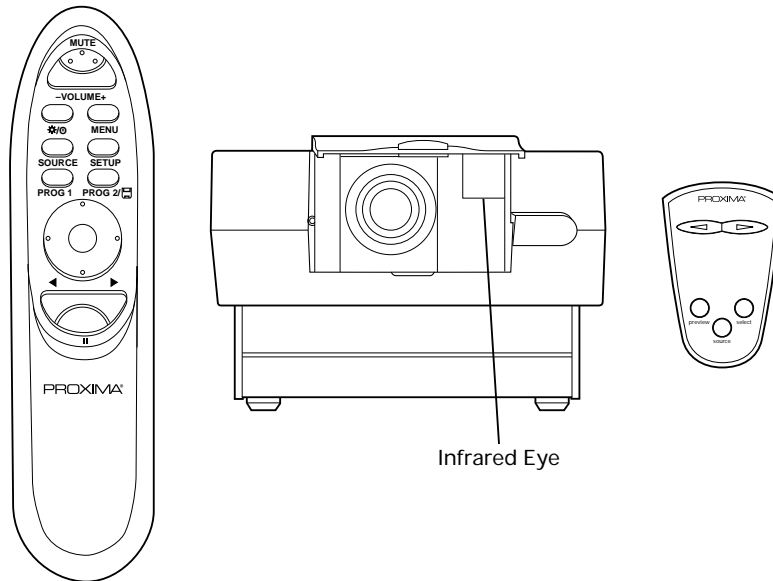



Figure 2-12 Cyclops Remote Control, Infrared Eye, and Cyclops Quick Remote



Cyclops Remote Control

KEY	FUNCTION
MUTE	Turns audio on or off.
- VOLUME +	Decreases or increases the volume of internal and external speakers.
☼/0	Turns the lamp on or off.
MENU	Displays or hide the menu.
SOURCE	Switches between connected sources.
SETUP	Displays the Setup menu (see page 2-7).
PROG1	Programmable key (see page 2-23).
PROG2/ 	Programmable key (see page 2-23).
	Acts like an arrow key or mouse click. Press the edges to move the screen cursor. Press the center to send a mouse click. To drag an object, position the cursor over it, then press the center button for two seconds. Move the cursor to the new location, and press the center button again to release it.

Cyclops Quick Remote

The Cyclops Quick Remote allows you to control the most often used projector functions.

NOTE: Several of the remote control functions require the installation of Proxima's Cyclops F/X software (see Chapter 3).

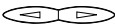
KEY	FUNCTION
	Moves a presentation (PowerPoint, Persuasion, etc.) forward or back one frame. This function can only be used if Cyclops F/X is installed.
Preview	Allows you to preview an image from a presentation (PowerPoint, Persuasion, etc.) if Cyclops F/X and a separate monitor are installed. Refer to the See It/Show It feature in Chapter 3 for more information.
Select	Selects a pre-programmed projector feature that you can choose from the Preferences menu (see page 2-23).
Source	Switches between connected sources.



OPERATING MODES

The Lightbook projector can operate in Local or Host mode.

Local Mode

Any time you activate the projector's menus or the drawing tools, the projector is in Local mode. In Local mode, the remote control can be used for projector menu and draw functions only. It does not communicate with the computer, even if it is attached through the SERIAL port.

In Local mode, the remote control can be used to:

- Select items in the projector menus.
- Control the drawing cursor.

Host Mode

If a data cable is connected between the projector's SERIAL port and the computer, the projector can operate in Host mode. In Host mode, the remote control can be used to control the Cyclops F/X software if it is installed on your computer. Cyclops F/X can be used with both the Cyclops Remote and Cyclops Quick Remote.

USING THE MENUS

Your Lightbook projector features a graphical user interface that makes it easy to control all of the projector's functions. Menu selections can be made with the projector control panel or remote control. Menus will change based on the type of video source you have connected.

- 1 Press MENU to display the on-screen menus.
- 2 Press the ▲ and ▼ keys or the edges of the remote control mouse disk to select the desired menu item. An item is highlighted when it is selected.
- 3 Use the ◀ and ▶ keys or mouse disk to move across the menus.
- 4 Use the ▲ and ▼ keys or mouse disk to move down a menu column or to change a menu value.
- 5 Press MENU again to close the menu. Settings are automatically saved when you exit the menus.

NOTE: You must use the Cyclops Remote to open the menus and select items in them. The Cyclops Quick Remote cannot access the menus.



Using the Main Menu

Press MENU to display the Main menu. To turn the menu off, press MENU again.



Figure 2-13 Main menu

The menu displays only those items that are relevant to the current input source (computer, video, or S-Video). The following table lists the Main menu options:

MENU	ACTIONS
Tools	Selects a projector tool.
Input Source	Selects a video source and adjusts the settings of an incoming signal.
Image	Sets the display characteristics.
Audio	Controls the audio volume.
Fine Audio	Selects mono or stereo. Adjusts balance, treble and bass.
Preferences	Programs a custom key on the remote control or increases the fan speed for high altitude use.
Advanced	Selects one of five languages for the menus, or selects rear, inverted or other projection options.
Help	Displays connection diagrams and general help.



Selecting a Tool

The Tools menu is used to set up and activate:

- The LightBoard™, WhiteBoard and BlackBoard tools.
- The Timer.
- The Reveal function.

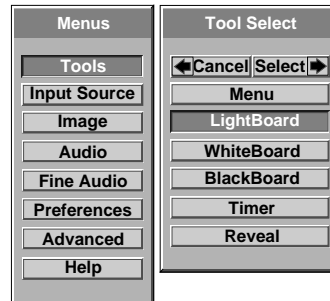

Figure 2-14 Tool Select menu

Use the ▲ and ▼ keys to select a tool. Press ► to select it or ◀ to cancel it.

Using the Draw Tools

The Draw tools allow you to highlight text or other objects on the screen or to draw on a white or black background with the remote control.

- 1 From the Tool Select menu, select one of the drawing tools.

LightBoard	Uses the Pencil tool to highlight or annotate the projected image.
WhiteBoard	Clears the screen and provides a white background for the Draw tool.
BlackBoard	Clears the screen and provides a dark background for the Draw tool.

- 2 The Draw toolbar appears in the upper left of the display.

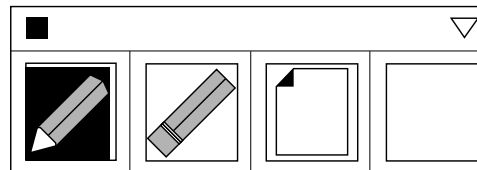

Figure 2-15 Toolbox

- 3 The current tool (Pencil or Eraser) is highlighted and a cursor appears. Use the remote control to draw on the screen.



Draw Tool Bar

The Draw tool bar has four options:



Pencil

Click to select the Pencil tool.



Eraser

Click to select the Eraser. You can erase portions of your highlights.



Clear All

Click to erase all previous highlighting.



New Color

Click to select a new color. This button also shows the currently selected color.

Choosing a Color

- 1 Click New Color or the down arrow in the upper right corner of the Draw tool bar to display the color palette.

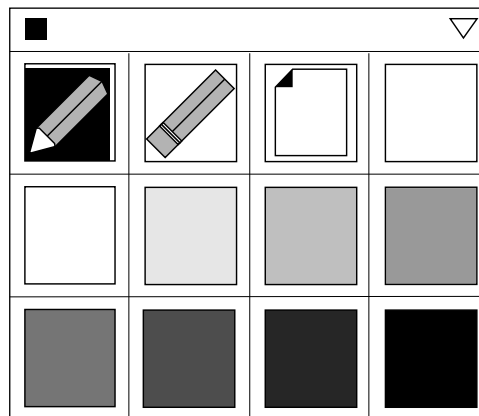

Figure 2-16 Toolbox Color palette

- 2 Click the color you want to use. The Color box takes on the selected color, and the color palette remains on the screen.
- 3 Click the Color box or the down arrow in the upper right corner again to turn the color selection boxes off.



- 4 To draw, click and hold the center of the MouseDisk at the desired starting point for about 2 seconds to lock it. Then, press the edges of the MouseDisk to move the Pencil tool and draw on the screen.
- 5 To exit Draw, click the small box in the upper left corner of the Draw tool bar.

You can move the Draw tool bar to another location on the screen. With the remote control, click and hold the center of the MouseDisk with the cursor on the top of the tool bar. Drag the bar to the new location and release the center button.

Setting the Timer

Use the Timer menu to start and reset the on-screen digital timer. You can set the Timer to count down for breaks, class activities, and other presentation requirements.

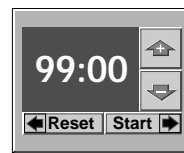

Figure 2-17 Timer menu

- 1 From Tool Select, choose Timer and press the ► key.
- 2 Use the ▲ and ▼ keys on the control panel or the MouseDisk on the remote control to set the time.
- 3 Press ◀ to reset the timer to the last setting used.
- 4 Press ▶ to start or stop the timer count down.



Reveal

Use this feature to slowly reveal a screen for greater audience impact.

- 1 Choose Reveal and press the ► key to select it.
- 2 Use the ▲, ▼, ◀ or ▶ keys to gradually display the image.

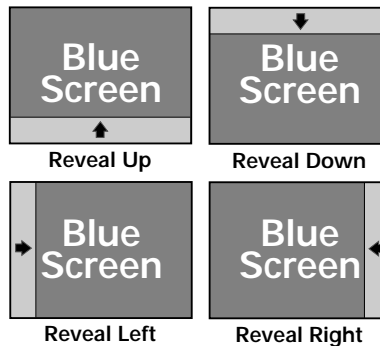

Figure 2-18 Reveal patterns

Input Source Menu

The Source Mode box indicates which video source has been detected by the projector.

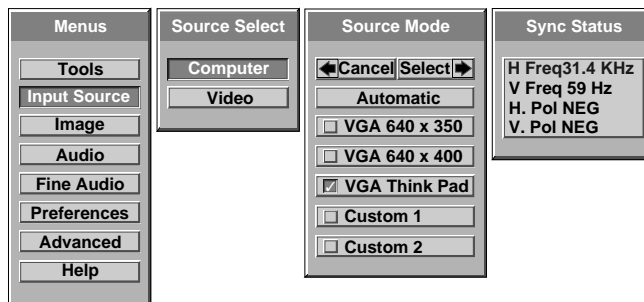

Figure 2-19 Input Source menu

MENUS	SETTING
Source Select	Selects computer and video input sources.
Source Mode	Changes to an input source that matches or is close to the current source.
Sync Status	Displays the Horizontal and Vertical frequency and the polarity of the current video source.



Changing the Input Video Source

Your Lightbook projector will check the connections and automatically select a size, position, and sync setting for any connected device.

- 1 To change the input source, use the ► key to move to the Source Select box.
- 2 Press the ▲ and ▼ keys to select Computer or Video.

NOTE: There will be a brief delay before the source changes.

Changing the Source Mode

Your Lightbook projector automatically senses the type of device connected to each input port.

To change the Source mode,

- 1 Choose Automatic if you want the projector to size and adjust the image automatically. You can save this setting into one of the available custom modes (see page 2-19).

The Source Mode box displays a next to all of the input source settings that match or are close to the type of source you have connected.

- 2 To change the Source Mode setting, use the ◀ and ▶ keys to move to the Source Mode box and use the ▲ and ▼ keys to select a different input source.
- 3 Use the ◀ and ▶ keys to either Cancel (◀) or Select (▶) the new source entry. A ✓ will appear in the box next to that option.

The input measurements of the current settings are displayed under the Sync Status heading, next to the currently selected video mode.

Recalling Custom User Settings

To recall your custom settings, select them from the Source Mode menu.

- 1 Use the ▲ and ▼ keys to select the custom settings (see page 2-19) that you want to recall.
- 2 Press ►. The projector will recall the custom settings.

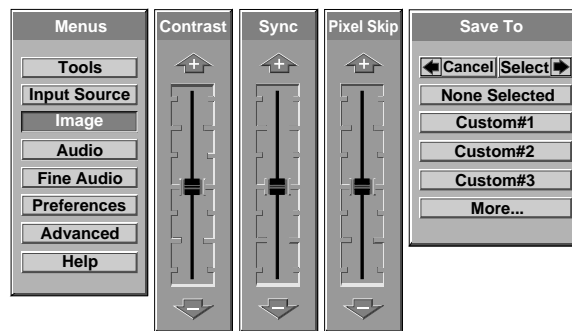

Image Menu

The Image menu displays a series of adjustment slide bars with the current settings. Use the ▲ and ▼ keys to move the bars up or down to adjust the settings.

NOTE: The menus vary according to the current input source.

Computer Source



Video Source

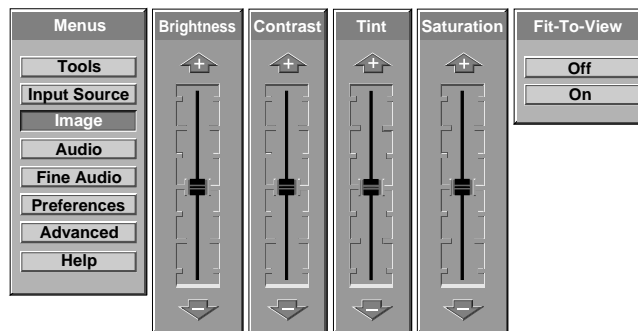

Figure 2-20 Image menus



The following table lists all of the available settings for the Image menu. Use the ▲ and ▼ keys to change them.

ADJUSTMENT	FUNCTION	SOURCE
Contrast	Increases or decreases the contrast level of the image.	All sources
Sync	Helps reduce uneven horizontal features, such as lines of text, streaks or shimmering in the image, or vertical black lines that may appear on the screen.	Computer
Pixel Skip	Adjusts the image for text mode.	Computer Text mode only
Brightness	Makes the screen image brighter or darker.	Video
Tint	Changes the color tones.	Video
Saturation	Increases or decreases the saturation of the image colors.	Video
Save To	Saves the current settings.	Computer
Fit to View	Compresses the image to fit on the display.	PAL/SECAM video only

Saving Custom Settings

A set of customized values for every video mode can be stored for up to twenty custom modes.

If you want to store custom settings,

- 1 Before you make any changes, use the ◀ ▶ keys to move to the Save To menu. Use the ▲ and ▼ keys to select Custom #1, 2, etc. Click More to see additional Custom Mode listings. Press ▶ to select a new Custom Mode number.
- 2 Make any desired projector adjustments.
- 3 Close the menu to save your changes to the new Custom Mode.



Audio Menu

Use this menu to select an audio source, adjust the volume, or to select speakers.

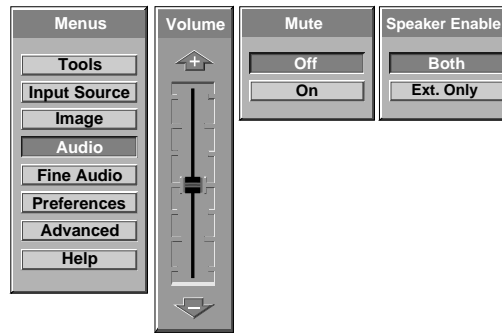

Figure 2-21 Audio menu

MENU ITEM	SETTING
Volume	Raises or lowers the speaker volume for the selected source.
Mute	Mutes the speaker sound.
Speaker Enable	Selects internal and external (Both) or external speakers only (Ext. Only).



Fine Audio Menu

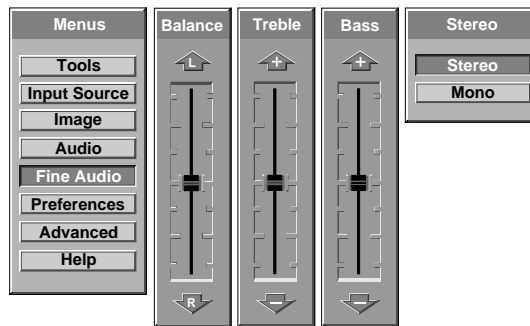

Figure 2-22 Fine Audio menu

MENU ITEM	SETTING
Balance	Adjusts the balance between the left and right speakers.
Treble	Adjusts the treble.
Bass	Adjusts the bass.
Stereo	Select stereo when playing a stereo source from both left and right audio inputs. Select Mono when using a monaural source for simulated stereo output.

Using the Audio Menus

You can include audio in your presentation in a variety of ways.

Selecting Stereo Audio

- 1 Open the Fine Audio menu and select Stereo. Adjust the balance, treble and bass.
- 2 Press MENU to exit.

Muting Audio with the Menu

- 1 Open the Audio menu.
- 2 Select Mute, then select On.
- 3 Press MENU to exit and mute the audio.



Simulating Stereo While Using a Monaural Source

- 1 Open the Fine Audio menu. Select the Stereo menu, and then select Mono.
- 2 Press MENU to exit.

NOTE: If you are using a monaural source, it must be connected to the L-AUDIO input.

Preferences Menu

Use this menu to tailor the projector to your personal presentation style.



Figure 2-23 Preferences menu

MENU ITEM	SETTING
-----------	---------

Prog Key 1 and 2 Assigns a specific projector function to one of the PROG keys on the Cyclops Remote Control or to the Select key on the Cyclops Quick Remote.

- LightBoard - Opens or closes the Draw tools.
- WhiteBoard - Draw on a white background.
- BlackBoard- Draw on a black background.
- Timer - Start or reset the Timer.
- Reveal- Gradually reveals the video image.
- Freeze- Freezes the image on the screen.
- Host - Enables a special effect selected in Cyclops F/X.

Operation Mode Select High Altitude to run the projector fans at higher speed. Use this setting if you are at a high altitude location or in a warm room.

To set the PROG 1 or 2 keys, use the ▲, ▼, ◀ and ▶ keys on the Cyclops Remote to select the function that you want to assign to each PROG key. The Select key on the Cyclops Quick Remote will select the feature assigned to the PROG 2 key in the Preferences menu.



Advanced Menu

Use the Advanced menu to adjust the projector settings to suit a particular presenter's style and taste.

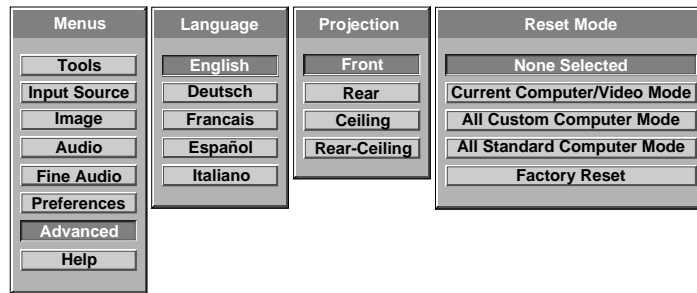

Figure 2-24 Advanced menu

MENU ITEM	FUNCTION
Language	Display the menus in any of five languages.
Projection	Flips the image for rear and ceiling projection.
Reset Mode	Select Reset to return the settings for the current image source to the factory defaults.



Help Menu

Select Help from the Main menu to display connection diagrams for your PC, Macintosh, or video source.



Figure 2-25 Help menu

- 1 Press ▲ or ▼ to select the item you want Help on. Press ► to display that item, or ◀ to cancel.

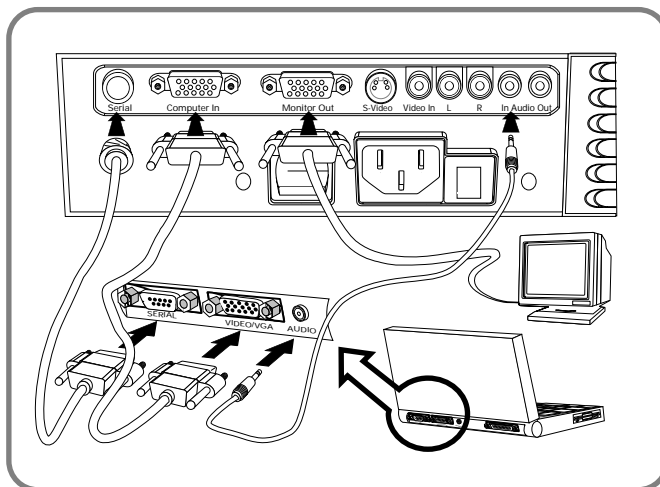

Figure 2-26 PC Help screen



Chapter 3

Cyclops F/X

Your projector comes with Cyclops F/X — software effects that you can use to make your presentations more interesting and effective. For example, you can use the Spotlight to call attention to specific areas on the image, use the Zoom or Magnify effects to focus on important information in the image, or use See-it/Show-it to preview images on your computer without distracting your audience.

You can use Cyclops F/X with either the one that came with your projector or the optional Cyclops interactive pointer system, or both at the same time.

NOTE: Cyclops F/X is not available for UNIX systems.

NOTE: You cannot use Cyclops F/X with the MediaExpress system.

To use Cyclops F/X, follow these steps (details are covered throughout this chapter):

- 1 Use the serial cable appropriate for your system (PCs: C936-6 or Macs: C470-6) to connect the serial port on your computer to the CYCLOPS port on the projector.

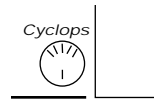

Figure 3-1 Cyclops port on the projector

- 2 Install the Cyclops F/X software.
- 3 Start Cyclops F/X, customize the effects, and assign them to specific keys on the keyboard or buttons on the remote control.
- 4 Minimize the Cyclops F/X main screen.

Then, just press the assigned key or button during your presentation to start an effect.

This chapter is designed to give you a brief introduction to the Cyclops F/X software.

NOTE: Updates to the Cyclops F/X software are available for download from the World Wide Web at <http://www.prxm.com>.



INSTALLING CYCLOPS F/X

Follow these steps to install the Cyclops F/X software:

- 1 Insert the disk labeled Proxima Cyclops F/X into your computer's floppy drive.
- 2 Do one of the following:
 - In Windows 95, choose Start, Run, then type a:\setup.exe (or the drive letter for your floppy drive).
 - In Windows 3.x, choose File, Run, then type a:\setup.exe (or the drive letter for your floppy drive).
 - On a Macintosh, double-click the disk icon, then double-click the Cyclops F/X Installer icon in the disk window. Drag the Cyclops F/X icon onto the hard disk icon.
- 3 Follow the instructions that appear on your screen.

STARTING CYCLOPS F/X

Once you're finished with the installation, do one of the following:

- In Windows 3.x or Windows 95, double-click the Cyclops F/X icon to start the program.
- For Macintosh users, the software will automatically load each time you start your computer.

Windows users

The first time you start the software, Cyclops F/X displays a Projector Setup Tutorial (Wizard). Follow the instructions that appear on your screen. When you have finished configuring your system, restart Windows.

The main screen of the F/X program appears:

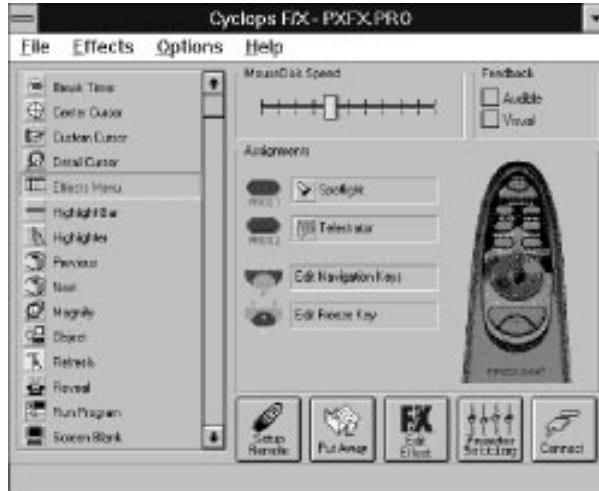

Figure 3-2 Cyclops F/X special effects

On the left side of this window is a list of the special effects. The Assignments area in the middle of the window provides options that allow you to customize your remote and software.

NOTE: If you open a menu, or if you're using the LightBoard tool, Cyclops F/X will be suspended.

ASSIGNMENTS AREA

The Assignments area displays the custom remote keys and their current assignments. To modify the custom remote keys:

- 1 Highlight the effect you want to assign.
- 2 Double-click the box next to the custom remote key in the Assignments area.



The Assignments area also contains five buttons:

BUTTON	FUNCTION
Setup Remote	Lets you switch the assignments display between the included Cyclops remote control and the optional Cyclops wand or laser pointer.
Put Away	Minimizes the F/X screen.
Edit Effect	Allows you to assign a shortcut key to the effect. You can also use this option to customize an effect.
Projector Setting	Allows you to adjust image, audio, and general settings on your projector.
Connect	Allows you to choose the COM port to which you will connect your projector.

In addition, the Assignments area allows you to control the MouseDisk speed on your remote, and gives you checkboxes to turn on audible and visual feedback.

CUSTOMIZING EFFECTS

Most effects have options that you can tailor to both the presentation and your own presentation style.

For example, you can customize the Spotlight effect to specify the shape and size of the spotlight. You can also change the name of each effect (for example, you can change the name from “Spotlight” to “Headlight”).

You can assign each effect to a key on the keyboard or a button on the remote control. The key or button you choose starts that effect.

To customize an effect:

- 1 Right-click the name of the effect and choose Edit from the menu. You can also select the desired effect and click the Edit Effect button to make your changes.
- 2 Adjust the settings in the appropriate dialog box and click OK.
- 3 When you’re finished customizing the effect, choose File and Save to save your settings.
- 4 Click the control box in the upper right corner to minimize the Cyclops F/X main screen.



NOTE: To access effects that are assigned to the Prog 1 and Prog 2 keys, assign the settings for those keys (in the projector's Preferences menu) to Host.

USING THE CYCLOPS INTERACTIVE POINTER SYSTEM

You can use the Cyclops interactive pointer system with Cyclops F/X. To set up the software, click Setup Remote in the Assignments area of the mains screen. Choose Cyclops Wand or Laser Pointer. The following screen appears:



Figure 3-3 Cyclops interactive pointer screen

Click the Show Navigation Bar checkbox to enable the navigation bar. This will provide you with a quick way to scroll through your slide show with the Cyclops wand or laser pointer.

Click on the Edit Navigation Bar button. The following screen appears:

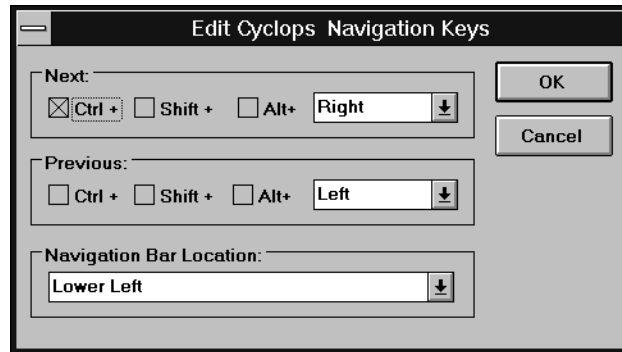

Figure 3-4 Edit Cyclops Navigation screen

Use this screen to assign different options to the navigation bar. To assign a new function to the navigation bar, click the Next or Previous areas and assign a function using the list boxes to the right.

You can also use this screen to define where the navigation bar will appear on your display. The default is Lower Left.

SEE-IT/SHOW-IT

See-it/Show-it is a feature of Cyclops F/X that previews the next slide in your presentation on your computer monitor—without switching from the slide your audience sees. The See-it/Show-it feature displays the image, along with a timer that counts down on your computer monitor until See-it/Show-it displays the next slide. You can use See-it/Show-it to preview slides so that you can interact with your audience, while preparing for the message on the next slide.

To use See-it/Show-it:

- 1 Click Edit Navigation Keys in the Assignments area of the Cyclops F/X main screen. The following screen appears:

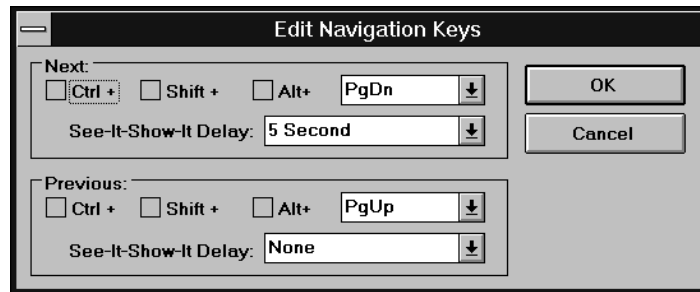

Figure 3-5 Edit Navigation Keys screen

- 2 Select a countdown time for the Forward or Reverse keys, or both. When you select a countdown time, See-it/Show-it is automatically enabled.
- 3 To disable See-it/Show-it, select None from the Forward and Reverse key list boxes.

To switch to See-it/Show-it, press the Forward or Reverse key once quickly. To end See-it/Show-it, press the Forward or Reverse key a second time. The counter disappears and the next slide immediately displays.

FREEZE

The Freeze option freezes the image on your projector so you can use your remote to control your computer. This might be handy when you want to perform functions on your computer without distracting your audience from your presentation. To edit the Freeze key settings, click the Edit Freeze Key option in the Assignments area. The following screen appears:

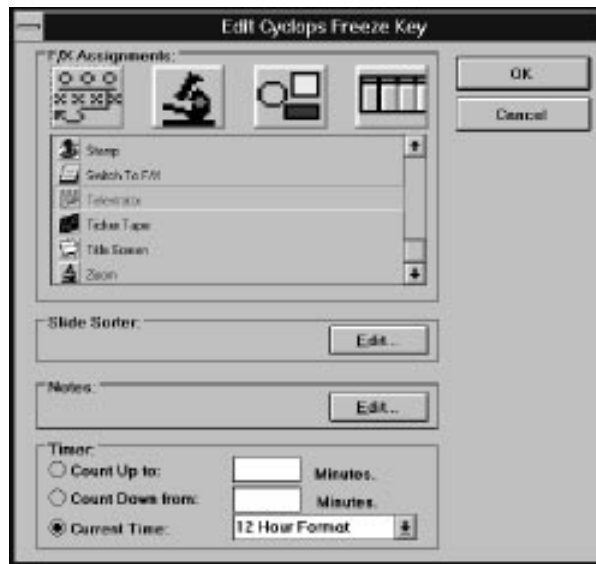

Figure 3-6 Edit Freeze Key screen

To use Freeze:

- 1 Press PAUSE on your Cyclops remote.
- 2 Use any of the remote keys to control your computer.
- 3 Press PAUSE again when you're ready to return to your presentation.

Once you freeze your screen, all of the other keys on your remote are available to control your computer. This means you can edit your current presentation, display slides from another presentation, or even open another application — all without distracting your audience.

NOTE: If you adjust the projector settings from your computer while you're in Freeze mode, your changes will not display until you exit .



STARTING AN EFFECT

Once you've customized an effect, you're ready to use it.

- 1 Before the presentation, start Cyclops F/X, then minimize the main screen.
- 2 During your presentation, press the key or button that you assigned to each effect to start the desired effect.

THE PRESENTATION EFFECTS

The following are the Presentation Effects. To end any of the effects, press the Esc key on your keyboard or the key on remote that you assigned for that effect.

Break Timer is a digital timer that counts down from a duration you set. Once you start the timer, click the MouseDisk once to lengthen the duration.

You can also use Break Timer to play a sound or select a background color or picture. If your computer is equipped with a sound card, you can select a .WAV file and play it continuously while the timer is running, or use it as an alarm that sounds when the timer expires.

To set a transparent background, uncheck Color and Picture. To display a picture, check Picture, click File, then select the desired .BMP file.

Center Cursor centers the mouse pointer on the screen. This helps prevent "losing" the cursor.

Custom Cursor changes the appearance of the mouse pointer to one of 30 images. Only the standard arrow pointer changes. The other standard icons (such as the hourglass) are not affected.

Detail Cursor magnifies the area around the pointer in a small rectangle.

Effects Menu displays a list of effects. Use this feature to start effects that you haven't assigned to a button or key. To start an effect, double-click its name. Press ESC on the keyboard to close the list without starting an effect.

Highlight Bar draws a horizontal bar across the screen. Move the bar up or down to draw attention to different areas on the screen. You can also change the color and width of the bar.

Highlighter works like a highlighter pen on your computer screen, by overlaying a semi-transparent color on your screen. You can change the color and width of the "pen."



Magnify enlarges a rectangular area around the mouse pointer. You can choose from three levels of magnification (200%, 400%, or 800%).

NOTE: To enlarge the entire screen, use the Zoom effect.

Next/Previous advances to the next or previous slide.

Object allows you to draw rectangles, squares, ellipses, and circles. You can change the color and width of each shape.

Refresh repaints the projected image. Use this feature to erase "remnants" of Stamp and Telestrator effects.

Reveal hides the image, then lets you incrementally reveal more and more of the image. You can specify a color for the hidden area, a horizontal or vertical effect, and the size of the Reveal window.

Run Program starts a program that you choose.

Screen Blank blanks the screen to a color that you choose.

Sound plays a .WAV file when you press a button. You can play the sound repeatedly or just once.

NOTE: You must have a sound card to use this effect.

Spotlight dims all of the image except for the area around the mouse pointer. You specify the shape and size of the spotlight (circular, square, or bar). Once you've started Spotlight, press the MouseDisk to change its size. Another setting makes the Spotlight visible against a black background.

Stamp allows you to choose from 15 different bitmaps to "stamp," or paste, over the projected image. You can also choose to play a sound each time you stamp.

Switch to F/X switches to the Cyclops F/X main screen.

Telestrator turns the mouse into a freehand drawing tool. You can customize the color and width of the line and "constrain" the drawing to only horizontal or vertical lines.

Ticker Tape displays a scrolling text message across the image. Just specify the text of that you want to appear, the typeface, and the point size. You can play a sound file each time the message runs across the image, and customize the background color and picture.



Title Screen projects an image from a .BMP file. You can use this effect to show a predefined image with transition effects during a presentation. You can also play an associated sound. Just specify which file to play and indicate whether to play it when the image appears or continuously.

Zoom enlarges the entire image to 200%, 400%, or 800% of its original size. You choose whether to show the mouse pointer during a Zoom and indicate the level of magnification. If you check the Show Cursor During Zoom checkbox, left-click to manually cancel the zoom. If you uncheck the Show Cursor During Zoom checkbox, left-click to change the zoom factor.

NOTE: Most effects have an option that lets you rename the command itself.

MENU COMMANDS

File menu

The File menu offers the following commands for working with profiles of effects.

MENU ITEM	FUNCTION
Reset to defaults	Resets the F/X options to the factory defaults.
Open	Opens a previously saved profile of settings.
Save	Saves recent changes to the current profile.
Save As	Saves the profile settings under a name and location you specify.
Exit	Quits the F/X program.

Effects menu

The Effects menu lets you change the items in the effects list.

MENU ITEM	FUNCTION
Edit	Allows you to edit F/X options.
Test	Tests the current effect.
Add	Allows you to add an effect.
Duplicate	Allows you to copy an effect.
Delete	Allows you to delete an effect.



Options menu

The Options menu offers commands that allow you to set up assignments on the remote, wand, or laser pointer, change the look and feel of the cursor, and change the COM port settings.

MENU ITEM	FUNCTION
Setup Remote	Allows you to display the assignments area for the Cyclops remote control or the optional Cyclops wand or laser pointer.
Cursor Options	Changes the look and feel of the cursor. Also includes an option that allows you to apply one of the Cyclops F/X custom cursor options to Windows.
Connect	Allows you to edit the COM port settings for your computer.



Chapter 4

Maintenance

CHANGING THE LAMP

Follow these steps to change the lamp when the primary bulb burns out:

- 1 Press the  key to turn the lamp off. Allow the fans to cool the lamp until the fans stop.
- 2 Turn the projector on its back.
- 3 Lift the tab and pull the lamp assembly up and out. Rotate the assembly and place it back in the projector.

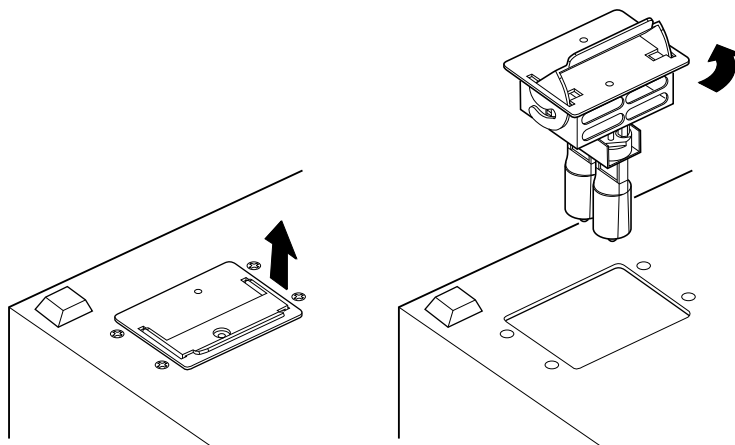





Figure 4-1 Changing the lamp

NOTE: Some lamps may fail without turning on the  indicator. If the lamp fails and the  indicator glows, allow the fans to cool the projector until they stop. If the lamp fails but the  indicator does not go on, press the  key to turn the lamp circuit off. Then, allow the fans to cool the projector until it stops.



REPLACING A BULB

- 1 Pull the lamp assembly out as shown in Figure 4-1.
- 2 Pull the bulb out. Insert a new bulb, being careful to avoid bending the pins.

NOTE: Avoid touching the bulb with your fingers. Oils from your hands can shorten the bulb life. Use a soft cloth to handle the bulb.

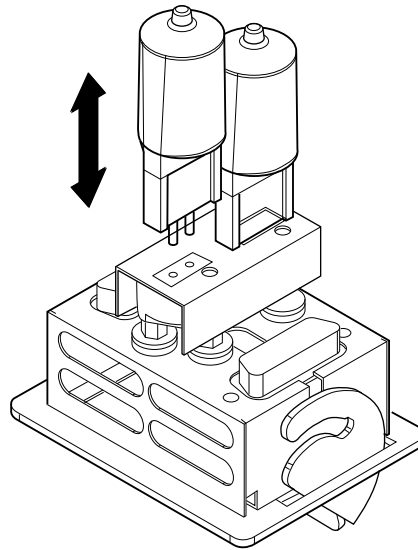

Figure 4-2 Removing a bulb

- 3 Replace the lamp assembly as shown in Figure 4-1.

CLEANING THE LENS

From time to time, you'll need to clean the lens.

- 1 Take a piece of lens tissue and form it into a loose swab. Wet it with lens cleaning fluid or denatured alcohol, and gently move it over the lens surface.
- 2 Take a part of the lens tissue that you haven't touched, and repeat the process, going over the lens in another direction.

⚠ CAUTION! Your projector contains electric circuitry and sensitive optics. Protect it from potential fluid spills.



CLEANING THE FAN FILTER

Clean the fan filter every 6 months. Clean it more often if the projector is used in dusty environments.

- 1 Turn the projector over.
- 2 Wipe the filter off, or use compressed air to blow off any dust that has accumulated on it.

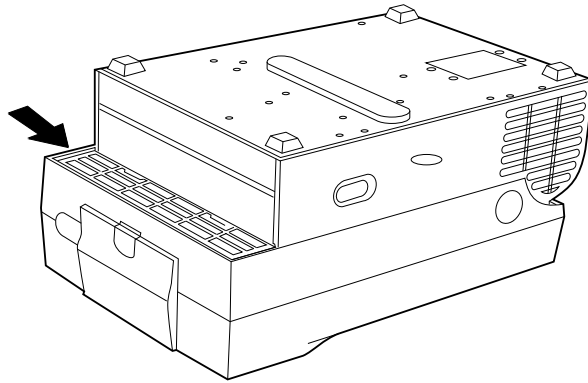

Figure 4-3 The Lightbook front filter

CHANGING BATTERIES - CYCLOPS REMOTE

To install or change the two AAA alkaline batteries in the remote control unit:

- 1 Locate the battery compartment at the lower rear of the case. Slide the cover off the battery compartment.
- 2 Remove the old batteries and replace them with new ones. Make sure to align the batteries in the proper orientation (see Figure 4-4).
- 3 Replace the cover on the battery compartment.

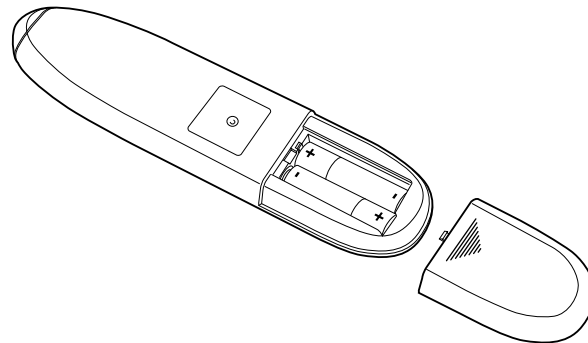

Figure 4-4 Installing batteries in the Cyclops Remote Control



CHANGING BATTERIES – CYCLOPS QUICK REMOTE

The Cyclops Quick Remote uses two 357A alkaline batteries.

- 1 Locate the battery compartment at the lower rear of the case. Press the corner down and slide it off.
- 2 Remove the old batteries and replace them with new ones. Make sure to align the batteries in the proper orientation.
- 3 Replace the battery cover.

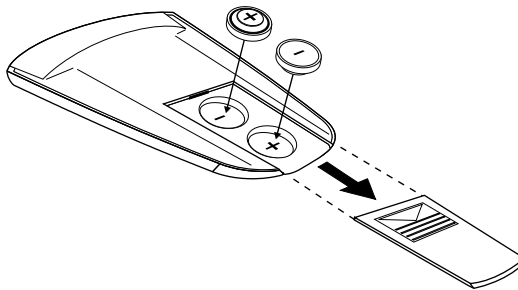

Figure 4-5 Installing batteries in the Cyclops Quick Remote



Chapter 5

Troubleshooting

PROBLEM	LIKELY CAUSE	POSSIBLE SOLUTION(S)
No image projected	No power to projector.	Turn power ON. Check AC cord. Check power to electrical outlet.
	Lamp not on. Lamp burned out.	Turn lamp ON. Replace lamp.
	Projector not completely open.	Push top assembly up and forward.
	Circuit breaker tripped.	Correct overload situation; press circuit breaker reset button.
	Over-temperature indication.	Allow projector to cool; turn projector OFF and then ON.
No computer image projected	Loose cable.	Check and secure cable connections.
	No power to computer.	Turn on computer.
	Incompatible video system.	If possible, check computer with another monitor.
	Laptop video port not activated.	Make sure laptop external video port is activated.
No video image projected	Video source(s).	Check video source(s).
	Loose/improper cabling.	Check and secure cabling between video source(s) and projector.
REPLACE LAMP indication	Burned-out lamp.	Replace lamp.



PROBLEM	LIKELY CAUSE	POSSIBLE SOLUTION(S)
Displayed image not square (keystoning)	Projector not placed at a proper angle to projection screen.	Adjust position of the projector and the screen. Use the Keystone Adjustment lever.
Projected image out of focus	Projection lens not focused.	Adjust the focus.
Projected image larger than screen	Projector too far from screen.	Move projector closer to screen.
Projected image smaller than screen	Projector too close to screen.	Move projector away from screen.
No image on the monitor	Power switch off or projector not running.	Computer must be on for computer monitor to display. Turn on projector and light the lamp.
	Cable not connected.	Connect cable.
Faint screen	Low CONTRAST or BRIGHTNESS settings.	Adjust CONTRAST and/or BRIGHTNESS.
Jittery, fuzzy text	Out of sync.	Adjust SYNC.
Image off-center	Position controls (arrow keys).	Adjust position controls.
	Compatibility problem.	Make sure the projector is compatible with one of the standards listed in Appendix A.
	Misalignment or damage to optical elements.	Projector requires service.
Cannot get entire image on screen; scrambled image	Compatibility problems.	Make sure the projector is compatible with one of the standards listed in Appendix A.
	Wrong video resolution.	Set video resolution on computer to 640 x 480.
"Shimmering" colors	SYNC out of adjustment.	Adjust SYNC.
Colors weak	Weak video signal.	Check for faulty video source, bad connection, or frayed cable.



PROBLEM	LIKELY CAUSE	POSSIBLE SOLUTION(S)
Getting excessive white or washout	CONTRAST and/or BRIGHTNESS too high.	Adjust CONTRAST and/or BRIGHTNESS.
Black and white image from color SECAM input	Video signal ambiguous.	Adjust Tint or Saturation.
No audio	Audio source(s).	Make sure that the audio source is turned on and functioning properly.
	Loose/improper cabling.	Check and secure cabling between audio source(s) and projector.
Over-Temperature indication	Air vent(s) clogged.	Allow projector to cool; clear obstructions from vents.
	Fan malfunction.	Allow projector to cool. Check for fan operation. If the fans are not working, call Proxima Customer Service.
	Room is warm or you are at high altitude.	Use the Preferences menu to switch to the High Altitude setting.
Remote Control doesn't work	Batteries upside-down or old.	Check battery placement or replace with new batteries.
	Projector IR receiver window blocked.	Remove object obstructing red IR receiver on front of projector.



WHERE TO GET HELP

If you need help:

- 1 Check the Troubleshooting Chart.
- 2 Call your dealer's technical support line and explain your problem.
- 3 Call Proxima at:

USA. and Canada:

(619) 457-5500. Press 1 for Customer Service.

(619) 457-8542 (Fax)

Outside USA and Canada:

(619) 457-5500. Press 1 for Customer Service.

(619) 622-0173 (Fax)

Europe:

+31 -43-358 5200

+31-43-358 5201 (Fax)

Internet (WorldWide Web)

<http://www.prxm.com> (Click Customer Service)

Returning your Projector for Repair

If the projector or any of its accessories are determined to be defective:

- 1 Contact Proxima Customer Service to request a Return Material Authorization (RMA) number.
- 2 Send the defective unit, including any accessories, cables, and the remote control, with the RMA number clearly marked on the outside of the shipping box, freight prepaid, to:

USA and Canada:

Proxima Corporation
RMA #
9440 Carroll Park Drive
San Diego, CA 92121

Europe:

Proxima Corporation
RMA #
Horsterweg 24
6191 RX Beek
The Netherlands

- 3 Pack the projector in its original box for safe shipment (include all accessories, cables, and the remote control). If you no longer have the original shipping materials, contact Proxima Customer Service for packaging.



ORDERING PARTS

Please order replacement and accessory parts through your local reseller,
or call Proxima at:

USA and Canada

(800) 447-7694 or

(619) 457-5500

Press 1 for Customer Service

Fax: (619) 457-8542

Europe

+31-43-358 5200

Fax: +31-43-358 5201

Outside USA and Canada

(619) 457-5500

Press 1 for Customer Service

Fax: (619) 622-0173





Appendix A

Specifications

Color	16.7 million colors
Display Technology	AM LCD
Resolution	VGA: 640 (H) x 480 (V) pixels
Contrast Ratio	125:1 typical
Aspect Ratio	4:3
Compatibility	NTSC, PAL, SECAM, S-Video PC (VGA) Apple Macintosh & PowerBook series Quadra, Centris
Projection Lamp	400 Watt Halogen Replacable lamp indicator light Lamp life 40-60 hours
Brightness	250 ANSI Lumens (typical)
Optics	High-Definition lens with variable focus
Keystone Correction	17-29 degrees, adjustable
Audio System	Digital stereo sound, two built-in 2 Watt speakers
Inputs	1 Computer Video 1 Composite Video (NTSC, PAL, SECAM, S-Video) 1 Computer Stereo Audio 1 Composite Video Stereo Audio 1 Serial/ADB
Outputs	Stereo Audio 1 Monitor
Power Source	90-260 VAC, 47-63 Hertz
Dimensions	5" (H) x 9 1/8" (W) x 13 1/2" (L) closed 12.7 cm (H) x 23.2 cm (W) x 34.3 cm (L) closed 6 3/8" (H) x 9 1/8" (W) x 17" (L) open 16.2 cm (H) x 23.2 cm (W) x 43.2 cm (L) open
Weight	11.35 lbs.
Throw Ratio	1.5:1 fixed lens
Screen Size	4.5 ft. (1.6m) to 13.5 ft. (4.5m)
Projection Distance	5 ft. (1.7m) to 18 ft. (6.0m) from screen



Appendix B

Accessories and Parts

REPLACEMENT PARTS

PART	PART NUMBER
Lamp	L82
Cyclops Remote Control	080-01101-1
Cyclops Quick Remote Control	A85
Power Cord - US	C1002-10
Power Cord - Europe	C1001-10
Power Cord - United Kingdom	C1004-10
Power Cord - Italy	C1003-10
VGA Video Cable	C951-6
VGA - Mac Adapter	C922
Mac - VGA Monitor Adapter	C924
S-Video Cable	C466-6
Computer Audio Cable	C498-6
Serial Cable	C936-6
Mini-jack to RCA Cable Adapter	C5105
Macintosh ADB Cable	C4070-6
Composite Video/Audio Cable	C497-6
Cyclops F/X Disks	A50 F/X
Soft Carrying Case	A260



OPTIONAL ACCESSORIES

OPTION	PART NUMBER
Deluxe Soft Carrying Case	A261
Deluxe Soft Case for Laptop	A262
Rolling Hard Case	A263
MicroSaver® Security Cable	K100





Index

A

- AC Circuit Breaker i-5, 1-3
- AC Plug i-5, 1-3
- AC Power i-5, 1-3
- AC Power Switch 1-4
- Accessories B-2
- ADB (Serial) Port i-5, 1-3
- ADB (Serial) Port Connection 1-12
- Advanced Menu 2-24
- Arrow Keys i-6, 2-5, 2-6
- Audio
 - Connecting from a composite video source 1-10
 - Muting 2-22
- Audio In Port i-5, 1-3, 1-9
- Audio Menu 2-21
- Audio Menus
 - Using 2-22
- Audio Out Port i-5, 1-3, 1-11
 - External Speaker System Connection 1-11
 - External Stereo System Connection 1-11
- Audio Port
 - Connecting the Source 1-9
 - Monaural or Stereo Source 1-10

B

- Balance
 - Fine Audio Menu 2-22
- Bass
 - Fine Audio Menu 2-22
- Batteries
 - Changing Quick Remote 4-4
 - Changing Remote Control 4-3
- BlackBoard 2-14
- Brightness 2-7
 - Image Menu 2-20
- Bulb Replacement 4-2

C

- Circuit Breaker i-4
- Circuit Breaker Reset switch 1-4

- Closing the Projector i-11, 2-4
- Color Palette 2-15
- Computer In Port 1-3
- Computer In Port i-5
- Connector Panel i-4, i-5, 1-3
- Connector Table i-5, 1-3
- Contents of Box
 - Accessories i-2
- Contrast 2-7
 - Image Menu 2-20
- Control Panel i-4
 - Keys Table i-6
- Control Panel Indicator
 - Over-Temperature 2-8
 - Projector Not Open 2-9
 - Replace Lamp 2-9
- Control Panel Indicators 2-8
- Control Panel Keys 2-5
- Control Panel Lights i-7
- Cooling Fans i-4
- Custom Settings
 - Recalling 2-18
- Custom Settings
 - Saving 2-20
- Cyclops Quick Remote i-4, 2-10
- Cyclops Remote Control i-4, 2-10

D

- Desktop PC
 - Connecting i-8
- Draw Tool Bar
 - Clear All 2-15
 - Eraser 2-15
 - New Color 2-15
 - Pencil 2-15
- Drawing Tools 2-14

F

- Fan Filter
 - Cleaning 4-3
- Fine Audio Menu 2-22
- Fit to View
 - Image Menu 2-20
- Focus Ring i-4
- Focusing the Image 2-2
- Frame Advance
 - Quick Remote 2-11

H

- Help
 - Where to get it 5-4
- Help Menu 2-25

I

- Image Menu 2-19
 - Adjustments Table 2-20
 - Computer Source 2-19
 - Video Source 2-19
- Image Position 2-7
- Input Source Menu
 - Source Mode 2-17
 - Source Select 2-17
 - Sync Status 2-17
- Input Video Source
 - Changing 2-18
- Internal Speakers i-4

K

- Keystone Adjustment i-4
- Keystoned Image
 - Correction 2-3

L

- L-Audio-R Port i-5, 1-3, 1-10
- Lamp
 - Changing 4-1
- Lamp Assembly Replacement 4-1
- Lamp Key i-6, 2-5, 2-6
 - Remote Control 2-11
- Language
 - Advanced Menu 2-24
- Lens
 - Opening i-3
- Lens Cleaning 4-2
- Lens Focus Ring 2-2
- LightBoard 2-14

M

- Macintosh
 - Video Connection 1-7
- Macintosh Adapters 1-7
- Macintosh Computer
 - Connecting i-9
- Main AC Power Switch i-4



Main Menu 2-13
Main Menu Options Table 2-13
Maintenance
 Changing Quick Remote
 Batteries 4-4
 Changing Remote
 BatteriesControl Batteries 4-3
 Fan Filter 4-3
 Lamp Assembly Replacement
 4-1
 Lens Cleaning 4-2
Menu Key i-6, 2-5, 2-6
 Remote Control 2-11
Menus 2-12
Monitor Out Port i-5, 1-3
Mouse Disk
 Remote Control 2-11
Mute
 Audio Menu 2-21
Mute Key
 Remote Control 2-11

N

Notebook
 Connecting i-7
 Video Connection 1-5
NTSC
 Connecting i-10

O

Opening the lens i-3
Opening the Projector i-3
Operating Modes
 Host Mode 2-12
 Local Mode 2-12
Operation Modes
 Preferences Menu 2-23
Ordering Parts 5-5
Over-Temperature 2-8

P

PAL
 Connecting i-10
Parts
 Replacement B-1
PC
 Video Connection 1-6

PC Help Screen 2-25
Pixel Skip 2-7
Power Cord Receptacle i-4
Power receptacle 1-4
Power Switch 2-2
Powering Up Projector 2-2
Preferences Menu 2-23
Preview Key
 Quick Remote 2-11
PROG1 and 2 Keys
 Preferences Menu 2-23
PROG1 Key
 Remote Control 2-11
PROG2 Key
 Remote Control 2-11
Projection
 Advanced Menu 2-24
Projector
 Closing i-11, 2-4
 Connecting Power 1-4
 Cooling and Airflow 1-2
 Main Parts i-4
 Moving 1-2
 Opening i-3, 2-1
 Positioning 1-1
 Setting up 1-1
 Transporting 1-2
 Turning Off 2-3
 Turning On 2-2

Q

Quick Remote 2-10
Quick Remote Batteries 4-4
Quick Remote Keys 2-11
Quick Start
 Desktop PC i-8
 Macintosh Computer i-9
 Notebook i-7

R

Recalling Custom Settings 2-18
Release Button i-4
Remote Control 2-10
Remote Control Batteries 4-3
Remote Control IR Lens i-4
Remote Control Keys 2-11
Repair of your Projector 5-4

Replacement Parts B-1
Reset Mode
 Advanced Menu 2-24
Returning your Projector for
Repair 5-4
Reveal 2-17

S

S-Video
 Connecting i-10
S-Video Port i-5, 1-3
S-Video Source
 Connecting i-10
Saturation 2-7
 Image Menu 2-20
Save To
 Image Menu 2-20
SECAM
 Connecting i-10
See-it/Show-it 3-7
Select Key
 Quick Remote 2-11
Serial (ADB) Port Connection
1-12
Serial Port i-5, 1-3
Settings Table 2-7
Setup Key i-6, 2-5, 2-7
 Remote Control 2-11
Setup Menu Key i-6
Source Key i-6, 2-5, 2-6
 Quick Remote 2-11
 Remote Control 2-11
Source Mode
 Changing 2-18
Speaker Enable
 Audio Menu 2-21
Special Configurations
 Video Connections i-10
Specifications A-1
Stereo
 Fine Audio Menu 2-22
Stereo Audio
 Simulating 2-23
Sync 2-7
 Image Menu 2-20



T

- Timer Menu 2-16
- Tint 2-7
 - Image Menu 2-20
- Tool Select Menu 2-14
- Tool Selection 2-14
 - Choosing a Color 2-15
 - Draw Tool Bar 2-15
- Tool Selection Menu
 - Timer 2-16
- Treble
 - Fine Audio Menu 2-22
- Troubleshooting 5-1
 - Help 5-4
 - Returning for Repair 5-4
- Turning off the Projector 2-3

V

- VGA Video Cable 1-6
- Video Connection
 - Macintosh 1-7
 - Notebook 1-5
 - PC 1-6
 - Special Configurations 1-8
- Video In Port i-5, 1-3
 - Composite Video Connections 1-9
- Volume
 - Audio Menu 2-21
- Volume Key 2-6
 - Remote Control 2-11
- Volume Keys i-6, 2-5

W

- WhiteBoard 2-14