



PR5020
PR3020
PR3010
DLP[®] Projector

USER'S MANUAL

www.planar.com

Copyright

This publication, including all photographs, illustrations and software, is protected under international copyright laws, with all rights reserved. Neither this manual, nor any of the material contained herein, may be reproduced without written consent of the author.

© Copyright June, 2006

Disclaimer

The information in this document is subject to change without notice. The manufacturer makes no representations or warranties with respect to the contents hereof and specifically disclaims any implied warranties of merchantability or fitness for any particular purpose. The manufacturer reserves the right to revise this publication and to make changes from time to time in the content hereof without obligation of the manufacturer to notify any person of such revision or changes.

Trademark Recognition

Kensington is a U.S. registered trademark of ACCO Brand Corporation with issued registrations and pending applications in other countries throughout the world.

All other product names used in this manual are the properties of their respective owners and are acknowledged.

Important Safety Information

Congratulations on purchasing the Planar DLP® projector!

Important:

It is strongly recommended that you read this section carefully before using the projector. These safety and usage instructions will ensure that you enjoy many years of safe use of the projector. Keep this manual for future reference.

Symbols Used

Warning symbols are used on the unit and in this manual to alert you of hazardous situations.

The following styles are used in this manual to alert you to important information.

Note:

Provides additional information on the topic at hand.

Important:

Provides additional information that should not be overlooked.

Caution:

Alerts you to situations that may damage the unit.

Warning:

Alerts you to situations that may damage the unit, create a hazardous environment, or cause personal injury.

Throughout this manual, component parts and items in the OSD menus are denoted in bold font as in this example:

“Push the **Menu** button on the remote control to open the **Main** menu.”

Remote Control

Some remote controls have a laser for pointing out items on a screen.

DANGER: Do not point the laser in the eyes. Doing so can damage the eyes permanently.

General Safety Information

- Do not open the unit case. Aside from the projection lamp, there are no user-serviceable parts in the unit. For servicing, contact qualified service personnel.
- Follow all warnings and cautions in this manual and on the unit case.
- The projection lamp is extremely bright by design. To avoid damage to eyes, do not look into the lens when the lamp is on.
- Do not place the unit on an unstable surface, cart, or stand.
- Avoid using the system near water, in direct sunlight, or near a heating device.
- Do not place heavy objects such as books or bags on the unit.

Power Safety

- Only use the supplied power cord.
- Do not place anything on the power cord. Place the power cord where it will not be in the way of foot traffic.
- Remove the batteries from the remote control when storing or not in use for a prolonged period.

Replacing the Lamp

Replacing the lamp can be hazardous if done incorrectly. Refer to “Replacing the Projection Lamp” on page 33 for clear and safe instructions for this procedure. Before replacing the lamp:

- Unplug the power cord.
- Allow the lamp to cool for about one hour.

Important Recycle Instructions:



Lamp(s) inside this product contain mercury. This product may contain other electronic waste that can be hazardous if not disposed of properly. Recycle or dispose in accordance with local, state, or federal Laws. For more information, contact the Electronic Industries Alliance at WWW.EIAE.ORG. For lamp specific disposal information check WWW.LAMPRECYCLE.ORG.

Cleaning the Projector

- Unplug the power cord before cleaning. Refer to “Cleaning the Projector” on page 36.
- Allow the lamp to cool for about one hour.

Regulatory Warnings

Before installing and using the projector, read the regulatory notices in the “Regulatory Compliance” section on page 46.

Symbol Explanations



DISPOSAL: Do not use household or municipal waste collection services for disposal of electrical and electronic equipment. EU countries require the use of separate recycling collection services.

Main Features

- *Lightweight unit, easy to pack away and transport*
- *Compatible with all major video standards including NTSC, PAL, and SECAM*
- *A high brightness rating allows for presentations in daylight or in lit rooms*
- *Supports resolutions up to SXGA+ at 16.7 million colors to deliver crisp, clear images*
- *Flexible setup allows for front , rear & ceiling mounted projections*
- *Line-of-vision projections remain square, with advanced keystone correction for angled projections*
- *Input source automatically detected*

Register Your Planar Products Today

Thank you for choosing Planar. To assure you receive all the benefits of your Planar product and services, registeryour Planar product today. Visit our website to register your product at

http://www.planar.com/support/product_registration.html

Cables, Replacement Lamps and Accessories

To find cables, replacement lamps and accessories for your Planar projector, LCD monitor, touchscreen or other Planar products visit our online store at www.PlanarOnline.com or find other stores who carry Planar products at <http://www.planar.com/howtobuy>

About this manual

This manual is intended for end users and describes how to install and operate the DLP® projector. Wherever possible, relevant information—such as an illustration and its description—has been kept on one page. This printer-friendly format is both for your convenience and to help save paper, thereby protecting the environment. It is suggested that you only print sections that are relevant to your needs.

Table of contents

GETTING STARTED..... 1

- PACKING CHECKLIST 1
- VIEWS OF PROJECTOR PARTS..... 2
 - Front-right View* 2
 - Top view—On-screen Display (OSD) buttons and LEDs* 3
 - Rear view* 5
 - Bottom view*..... 6
- REMOTE CONTROL PARTS 7
- REMOTE CONTROL OPERATING RANGE..... 9
- PROJECTOR AND REMOTE CONTROL BUTTONS..... 9

SETUP AND OPERATION..... 10

- INSERTING THE REMOTE CONTROL BATTERIES 10
- CONNECTING INPUT DEVICES 11
- STARTING AND SHUTTING DOWN THE PROJECTOR..... 13
- SETTING AN ACCESS PASSWORD (SECURITY LOCK) 15
- ADJUSTING THE PROJECTOR LEVEL..... 16
- ADJUSTING THE ZOOM, FOCUS AND KEYSTONE 17
- ADJUSTING THE VOLUME 17

ON-SCREEN DISPLAY (OSD) MENU SETTINGS..... 19

- OSD MENU CONTROLS 19
 - Navigating the OSD*..... 19
- SETTING THE OSD LANGUAGE 20
- MAIN MENU 22
 - Main Menu Functions Available for Connected Source* 23
- SETUP MENU 24
 - Setup Menu Functions Available for Connected Source*..... 24
 - Advance Feature* 25
 - User Color* 27
- CONFIG MENU 28
- UTILITY MENU 29
 - Utility Menu Functions Available for Connected Source* 30
- TOOL MENU 31
- STATUS MENU 32

MAINTENANCE AND SECURITY..... 33

- REPLACING THE PROJECTION LAMP..... 33
 - Resetting the Lamp*..... 36
- CLEANING THE PROJECTOR..... 36
 - Cleaning the Lens* 37
 - Cleaning the Case*..... 37
- USING THE KENSINGTON® LOCK 37

TROUBLESHOOTING 38

- COMMON PROBLEMS AND SOLUTIONS 38
- TIPS FOR TROUBLESHOOTING 38
- LED ERROR MESSAGES..... 39
- IMAGE PROBLEMS..... 39
- LAMP PROBLEMS 40
- REMOTE CONTROL PROBLEMS 40
- AUDIO PROBLEMS 40

SPECIFICATIONS..... 41

- Input/output connectors* 41
- PROJECTION DISTANCE V.S. PROJECTION SIZE..... 42
 - PR3020 and PR3010 Projection distance and size table*..... 42
 - PR5020 Projection distance and size table*..... 43
- TIMING MODE TABLE 44

REGULATORY COMPLIANCE 46

FCC WARNING 46

CANADA 46

SAFETY CERTIFICATIONS 46

FCC CLASS B, UL, C-UL, CE, CB, TUV-GS, CCC , ICES-003(CLASS B) 46

EN 55022 WARNING 46

Packing Checklist

Carefully unpack the projector and check that the following items are included:



DLP® PROJECTOR

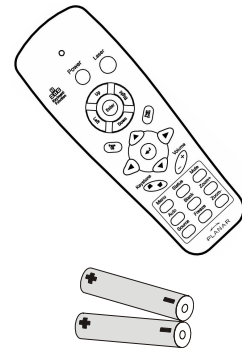

*REMOTE CONTROL
(WITH TWO AAA BATTERIES)*

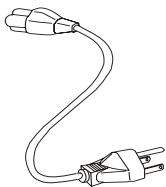

POWER CORD

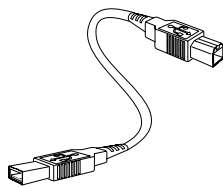

*USB CABLE
(USB TYPE A-TO-B USB)*

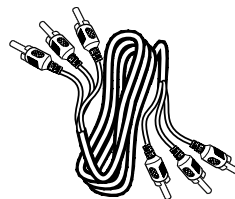

*COMPOSITE VIDEO CABLE
(RCA 3-TO-RCA 3)*

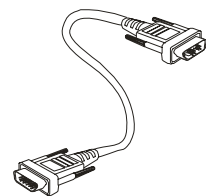

*COMPUTER CABLE
(VGA-VGA)*

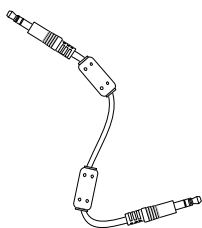

*AUDIO CABLE
(MINI JACK-TO-MINI JACK)*

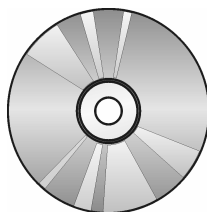

*CD-ROM (THIS USER'S
MANUAL)*



USERS GUIDE

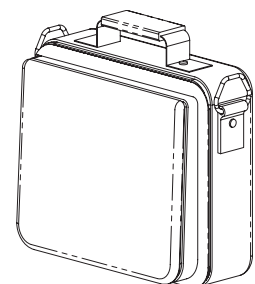

CARRYING CASE

Contact your dealer immediately if any items are missing, appear damaged, or if the unit does not work.

Caution:
Avoid using the projector in dusty environments.

Views of Projector Parts

Front-right View

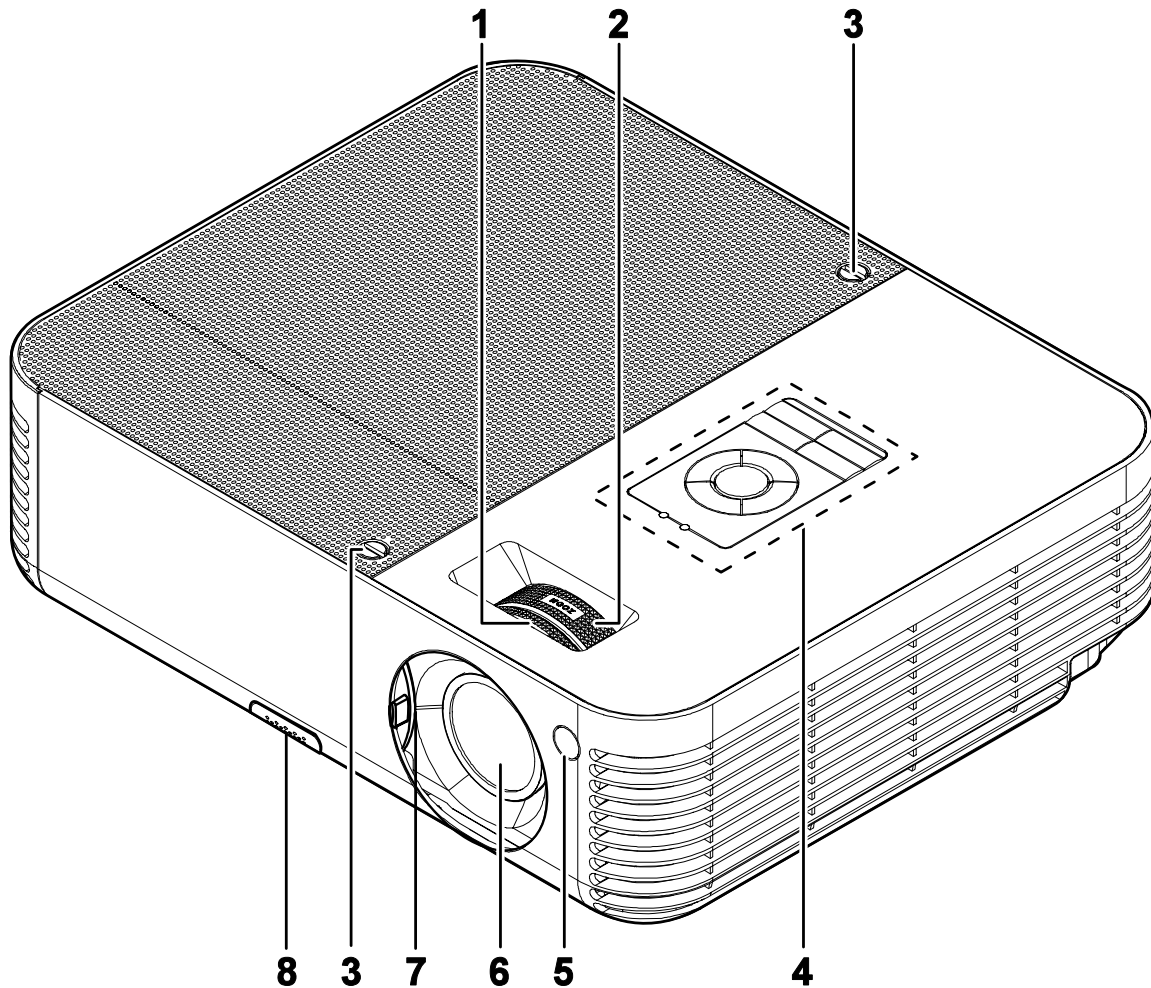

ITEM	LABEL	DESCRIPTION	SEE PAGE:
1.	Focus	Focuses the projected image	17
2.	Lens zoom	Enlarges the projected image	17
3.	Screws	Holds lamp to projector	
4.	See “Top view—OSD buttons and LEDs”		3
5.	Front IR receiver	Receiver for IR signal from remote control	7
6.	Lens	Slide lens cap before use.	
7.	Lens cover	Slide across to protect lens when not in use	

8.	Height-adjuster button	Push to release height adjuster	16
-----------	------------------------	---------------------------------	-----------

Important:
 Ventilation openings on the projector allow for good air circulation, which keeps the projector lamp cool. Do not obstruct any of the ventilation openings.

Top view—On-screen Display (OSD) buttons and LEDs

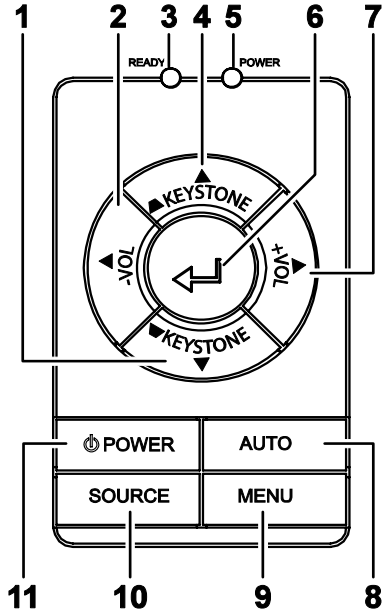

ITEM	LABEL	DESCRIPTION	SEE PAGE:
1.	Keystone/ Down cursor	Corrects image-trapezoid (wider bottom) effect Navigates and changes settings in the OSD	19
2.	VOL-/ Left cursor	Decreases volume Navigates and changes settings in the OSD	19
3.	Ready LED	Orange	Lamp ready—you can safely turn on or off the projector
		Flashing	Lamp not ready—do not press the power button
4.	Keystone/ UP cursor	Corrects image-trapezoid (wider top) effect Navigates and changes settings in the OSD	19
5.	Power LED	Green	Unit is powered on and working correctly
		Off	Unit is powered off
		Flashing	Operational error code (refer to “LED Error Messages” on page 39)
6.	Enter	Changes settings in the OSD	19

7.	VOL+/ Right cursor	Increases volume Navigates and changes settings in the OSD	19
8.	Auto	Optimizes image size, position, and resolution Navigates and changes settings in the OSD	13
9.	Menu	Opens and exits the OSD	
10.	Source	Detects the input device	
11.	Power	Turns the projector on or off	

Rear view

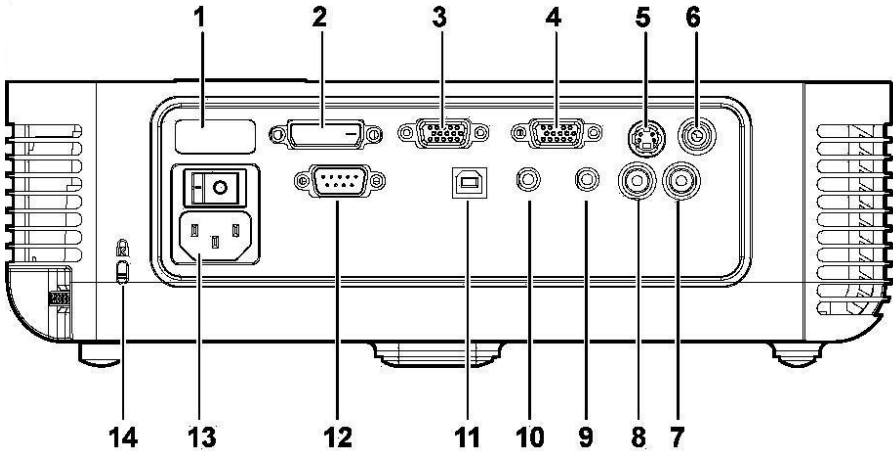

ITEM	LABEL	DESCRIPTION	SEE PAGE:
1.	Rear IR receiver	Receiver for IR signal from remote control	7
2.	DVI-D (For PR5020 only)	Connect a DVI-D cable (not supplied) from a computer	11
3.	VGA IN	Connect a VGA cable (supplied) from a computer	
4.	VGA OUT	Connect to a monitor (not supplied)	
5.	S-video	Connect the S-video cable (not supplied) from a video device	
6.	Video	Connect a composite video cable (supplied) from a video device.	
7.	Audio in-R	Connect the audio cable (supplied) from an audio input device.	
8.	Audio in-L	Connect the audio cable (supplied) from an audio input device.	
9.	Audio-in	Connect an audio cable(supplied) from the computer’s audio-out connector.	
10.	Audio-out	Audio loop-thru	
11.	USB	Connect the USB cable (supplied) from a computer	
12.	RS-232 (For PR5020 only)	Installation control	
13.	Power	Connect the power cord (supplied)	

14.	Security Lock	Secure to permanent object with a Kensington® Lock system	37
------------	---------------	---	-----------

Note:

If your video equipment has both S-video and RCA jacks (composite video) connect to the S-video connector.
S-video provides a better quality signal.

Bottom view

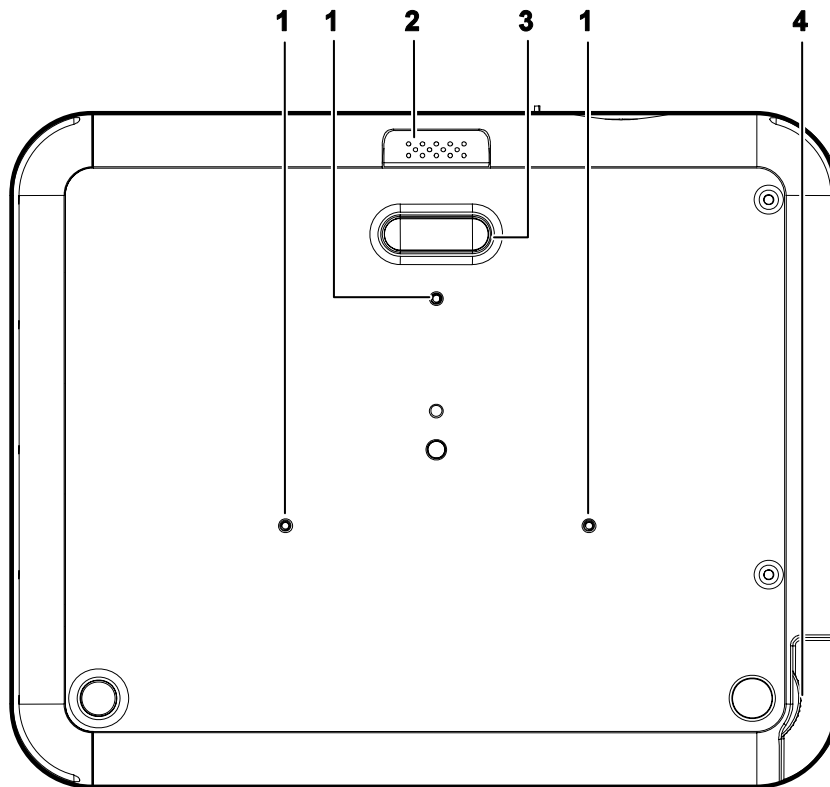

ITEM	LABEL	DESCRIPTION	SEE PAGE:
1.	Ceiling support holes	Contact your dealer for information on mounting the projector on a ceiling.	
2.	Height adjuster button	Push to release height adjuster	16
3.	Height adjuster	Adjuster drops down when adjuster button is pushed	
4.	Tilt adjuster	Adjust angle of the picture	

Remote Control Parts

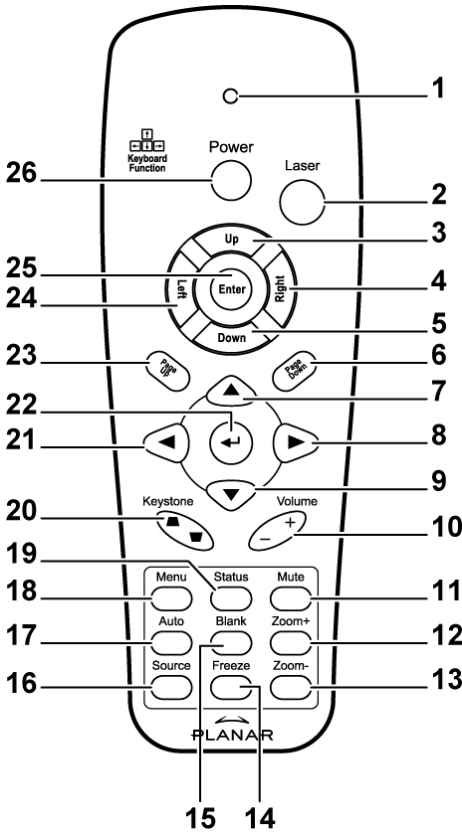

Important:

1. Avoid using the projector with bright fluorescent lighting turned on. Certain high-frequency fluorescent lights can disrupt remote control operation.
2. Be sure nothing obstructs the path between the remote control and the projector. If the path between the remote control and the projector is obstructed, you can bounce the signal off certain reflective surfaces such as projector screens.
3. The buttons and keys on the projector have the same functions as the corresponding buttons on the remote control. This user’s manual describes the functions based on the remote control.

ITEM	LABEL	DESCRIPTION	SEE PAGE:
1.	IR transmitter	Transmits signals to projector	
2.	Status LED	Lights when the remote control is used	
3.	Laser	Press to operate the on-screen pointer	
4.	Up	Up arrow when connected through USB to a PC	
5.	Right	Right arrow when connected through USB to a PC	
6.	Down	Down arrow when connected through USB to a PC	

ITEM	LABEL	DESCRIPTION	SEE PAGE:
7.	Page Down	Page down when connected through USB to a PC	
8.	Up cursor	Navigates and changes settings in the OSD	19
9.	Right cursor		
10.	Down cursor		
11.	Volume +/-	Adjusts volume	17
12.	Mute	Mutes the built-in speaker	
13.	Zoom+	Zoom in	
14.	Zoom-	Zoom out	
15.	Freeze	Freeze/unfreezes the on-screen picture	
16.	Blank	Makes the screen blank	
17.	Source	Detects the input device	
18.	Auto	Auto adjustment for phase, tracking, size, position	
19.	Menu	Opens the OSD	19
20.	Status	Opens the OSD Status menu (the menu only opens when an input device is detected)	32
21.	Keystone top/bottom	Corrects image-trapezoid (wider top/bottom) effect	17
22.	Left cursor	Navigates and changes settings in the OSD	19
23.	Enter	Changes settings in the OSD	
24.	Page Up	Page up when connected through USB to a PC	
25.	Left	Left arrow when connected through USB to a PC	
26.	Enter	Enter key when connected through USB to a PC	
27.	Power	Turns the projector on or off	13
28.	Laser	Use as on-screen pointer. DO NOT POINT IN EYES.	

Note:

The remote control can only interface with a computer when connected to the computer through a USB cable connection. The computer cable connects a computer to the projector for display purposes only.

Remote Control Operating Range

The remote control uses infrared transmission to control the projector. It is not necessary to point the remote directly at the projector. Provided you are not holding the remote perpendicular to the sides or the rear of the projector, the remote will function well within a radius of about 10 meters (33 feet) and 30 degrees above or below the projector level. If the projector does not respond to the remote control, move a little closer.

Projector and Remote Control Buttons

The projector can be operated using the remote control or the buttons on the top of the projector. All operations can be carried out with the remote control; however the buttons on the projector are limited in use. The following illustration shows the corresponding buttons on the remote control and on the projector.

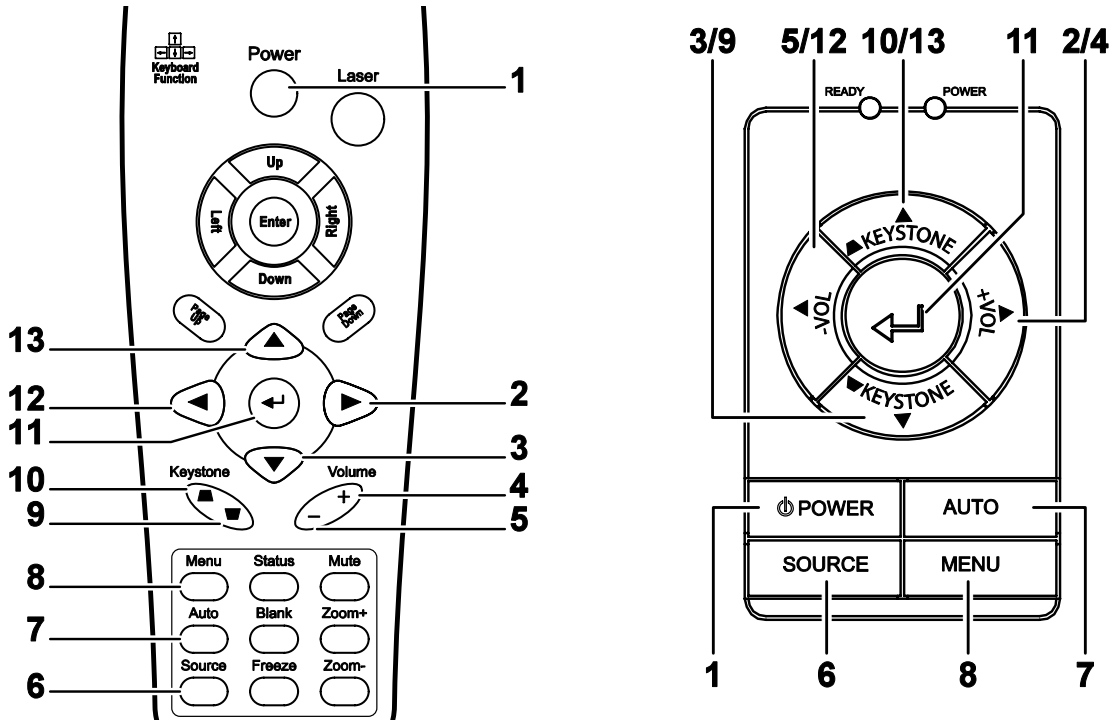

Some buttons on the projector have two functions. For example, item 10/13 on the projector functions both keystone button and as the up cursor key in OSD menus.

Inserting the Remote Control Batteries

1. Remove the battery compartment cover by sliding the cover in the direction of the arrow.

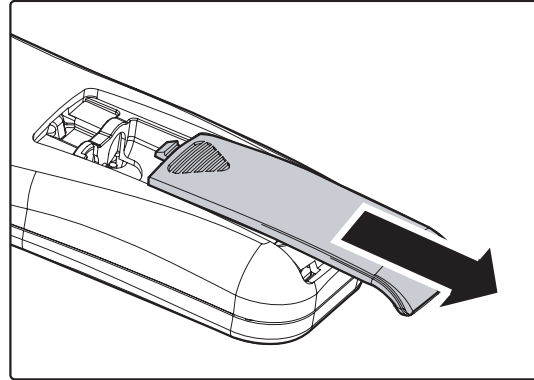

2. Insert the supplied batteries taking note of the polarity (+/-) as shown here.

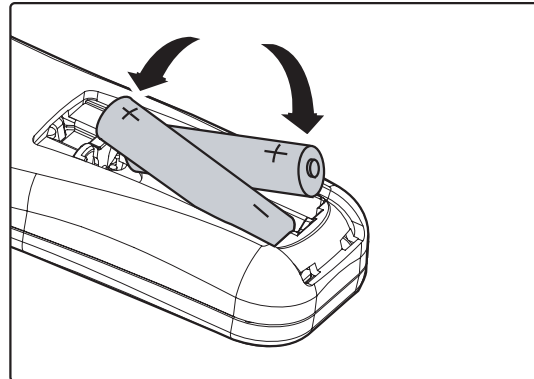

3. Replace the cover.

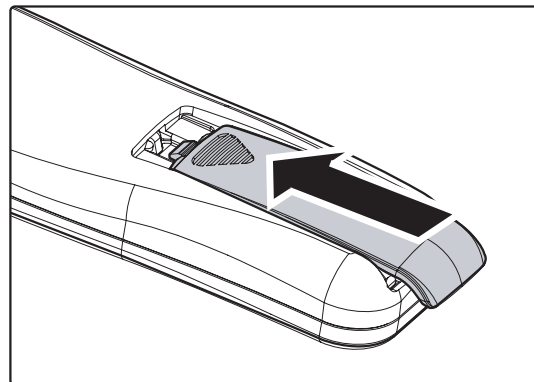

Caution:

1. Only use AAA alkaline batteries.
2. Dispose of used batteries according to local ordinance regulations.
3. Remove the batteries when not using the projector for prolonged periods.

Connecting Input Devices

A PC or notebook computer as well as video devices can be connected to the projector at the same time. Video devices include DVD, VCD, and VHS players, as well as movie camcorders and digital still cameras. Check the user manual of the connecting device to confirm it has the appropriate output connector.

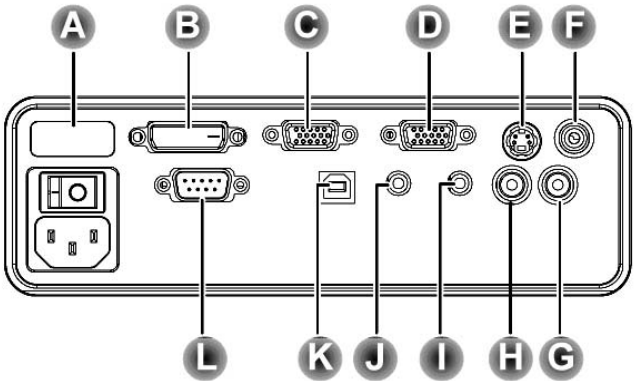

ITEM	LABEL	DESCRIPTION
A	Rear IR	Receiver for IR signal from remote control.
B	DVI-D (For PR5020 only)	Connect DVI-D cable (not supplied) from a computer.
C	VGA in	Connect a VGA cable (supplied) from a computer.
D	VGA out	Connect a VGA cable (not supplied) to a monitor.
E	S-video	Connect S-video cable (not supplied) from a video device.
F	Video	Connect a composite video cable (supplied) from a video device.
G	Audio in-R	Connect the audio cable (supplied) from an audio input device.
H	Audio in-L	Connect the audio cable (supplied) from an audio input device.
I	Audio-in	Connect an audio cable (supplied) from the computer’s audio-out connector.
J	Audio-out	Audio loop-thru
K	USB	Connect the supplied USB cable (supplied) from a computer for USB mouse function and firmware upgrades.
L	RS-232 (For PR5020 only)	Reserved for installation control.

Warning:

As a safety precaution, disconnect all power to the projector and connecting devices before making connections.

Starting and Shutting down the Projector

1. Slide the lens cover.
2. Connect the power cord to the projector [A]
Connect the other end to a wall outlet.
Switch [B] from on (O) to off (—)
3. The POWER and READY LEDs on the projector turn on.
Turn on the connected devices.
4. Ensure the Ready LED is on a steady (not flashing) orange and then press the **Power** button to turn on the projector.

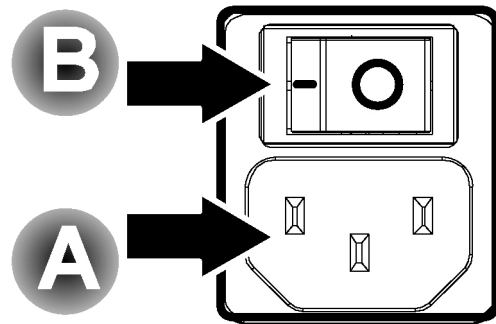

The projector splash screen displays and connected devices are detected.
If the connected device is a PC, press the appropriate keys on the computer keyboard to switch the display output to the projector. (Check the user manual of the PC to determine the appropriate Fn key combination to change display output.)



See “Setting an Access Password (Security Lock)” on page 15 if Security Lock is enabled.

5. If more than one input device is connected, press the **Source** button repeatedly to switch among devices. (DVD and HDTV are supported through the VGA connector.)
6. To turn off the projector, press the **Power** button. The projector prepares for shutdown and a “Wait a moment please...” message appears.



7. When the “Power Off?/Press Power again” message appears, press the **Power** button. The projector turns off.



8. Turn off the main **Power** switch when the **Ready** LED stops flashing.

Caution:

Do not unplug the power cord until the Ready LED stops flashing, indicating the projector has cooled down.

Setting an Access Password (Security Lock)

You can use the cursor (arrow) buttons to set a password and prevent unauthorized use of the projector. When enabled, the password must be entered after you power on the projector. (See “Navigating the OSD” on page 32 and “Setting the OSD Language” on page 32 for help on using OSD menus.)

Important:

Keep the password in a safe place. Without the password, you will not be able to use the projector. If you lose the password, contact your reseller for information on clearing the password.

1. Press the **Menu** button to open the OSD menu.
2. Press the cursor ◀▶ button to move to the **Setup** menu.
3. Press the cursor ▲▼ button to select **Advance Feature** and press **Enter** or ▶.
4. Press the cursor ▲▼ button to select **Security Lock**.
5. Press the cursor **Enter** or ▶ button to select **Enable**. (White text is selected.) A password dialog box automatically appears.
6. You can only use the following four cursor buttons: ▲ ▼ ◀ ▶ in the password fields. You can use any combination including the same arrow five times, but not less than six. Press the cursor buttons in any order to set the password. When you confirm the password, **OK** appears.

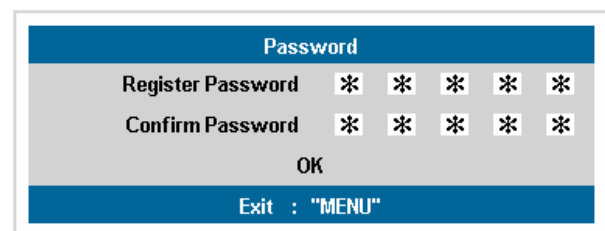
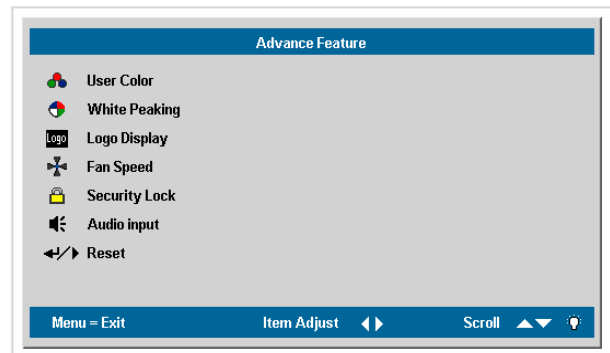
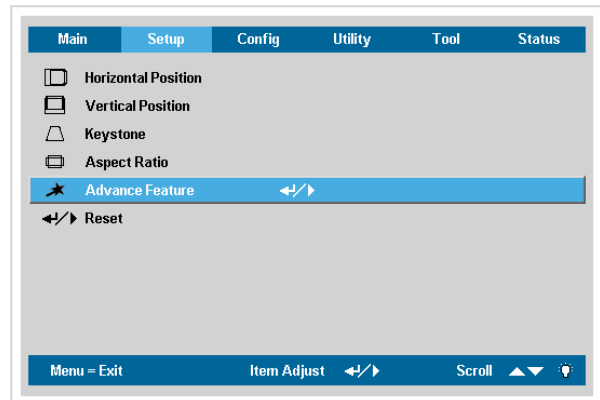

Every time you start the projector, a password dialog box appears.

Enter the password in the order you set it at step 6. (Press the **Menu** button to cancel if you enter the wrong password.)

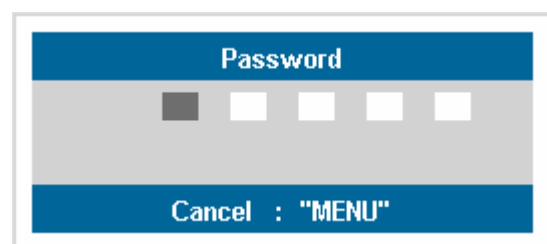

Adjusting the Projector Level

Take note of the following when setting up the projector:

- *The projector table or stand should be level and sturdy.*
- *Position the projector so that it is perpendicular to the screen.*
- *Be sure cables are not in the way or can cause the projector to be knocked over.*

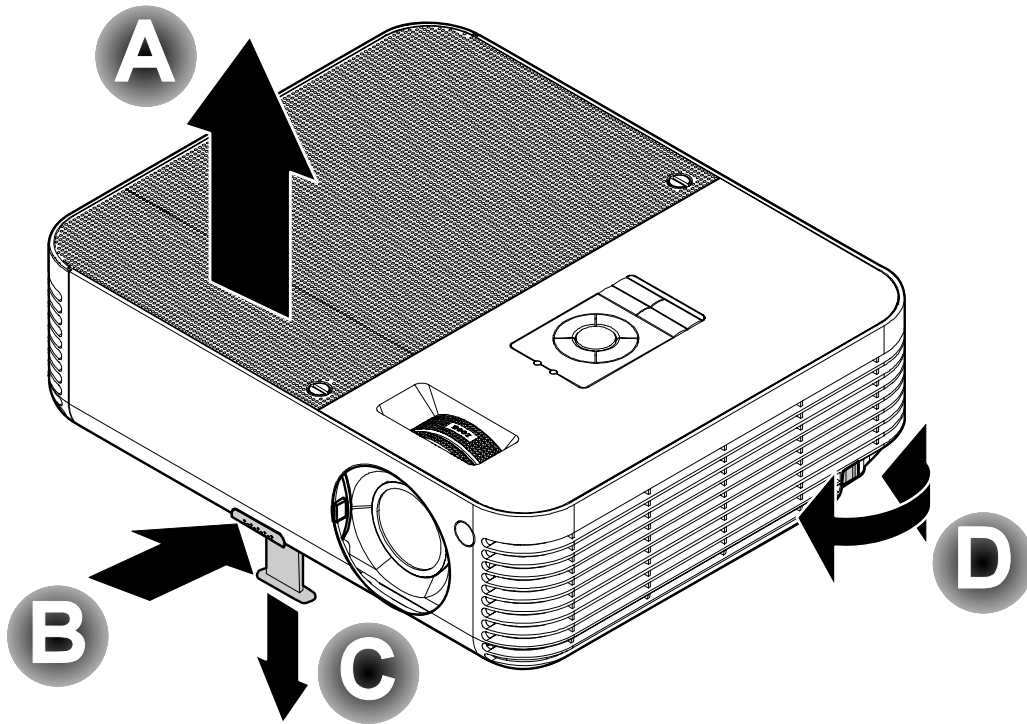

6. To raise the level of the projector, lift the projector [A] and press the height-adjuster button [B].

The height adjuster drops down [C].

7. To lower the level of the projector, press the height-adjuster button and push down on the top of the projector.

8. To adjust the angle of the picture, turn the tilt adjuster [D] right or left until desired angle has been achieved.

Adjusting the Zoom, Focus and Keystone

1. Use the **Image-zoom** control (on the projector only) to resize the projected image and screen size. **B**

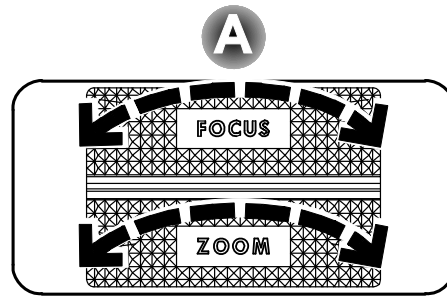

2. Use the **Image-focus** control (on the projector only) to sharpen the projected image **A**.

3. Press the **Keystone** button on the remote control. The keystone control appears on the display.

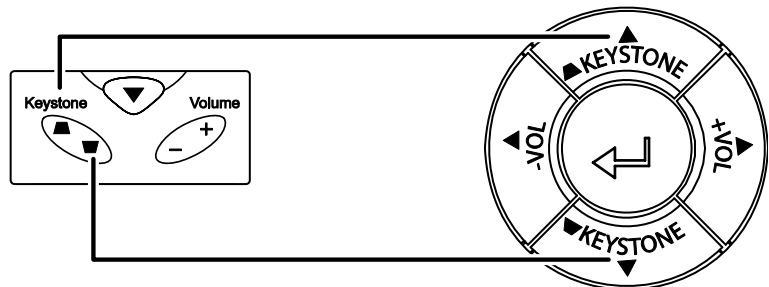

4. Use the **Keystone** button to correct image distortion.

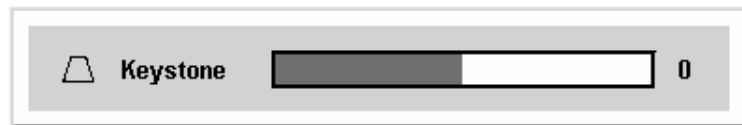

Adjusting the Volume

1. Press the **Volume +/-** button on the remote control. The volume control appears on the display.

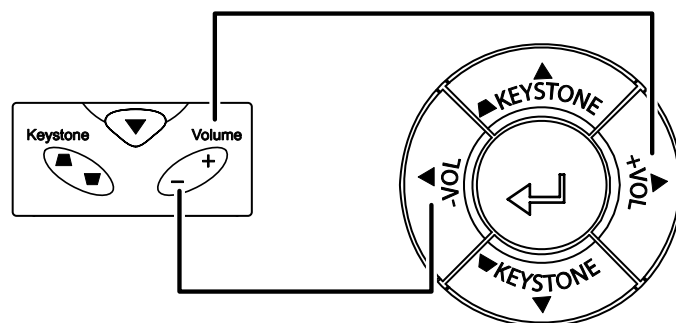

2. Use the **Volume +/-** button to adjust the level.



3. Press the **Mute** button to turn off the volume. (For remote only)



ON-SCREEN DISPLAY (OSD) MENU SETTINGS

OSD Menu Controls

The projector has an OSD that lets you make image adjustments and change various settings.

Navigating the OSD

You can use the remote control cursor buttons or the buttons on the top of the projector to navigate and make changes to the OSD. The following illustration shows the corresponding buttons on the remote control and on the projector.

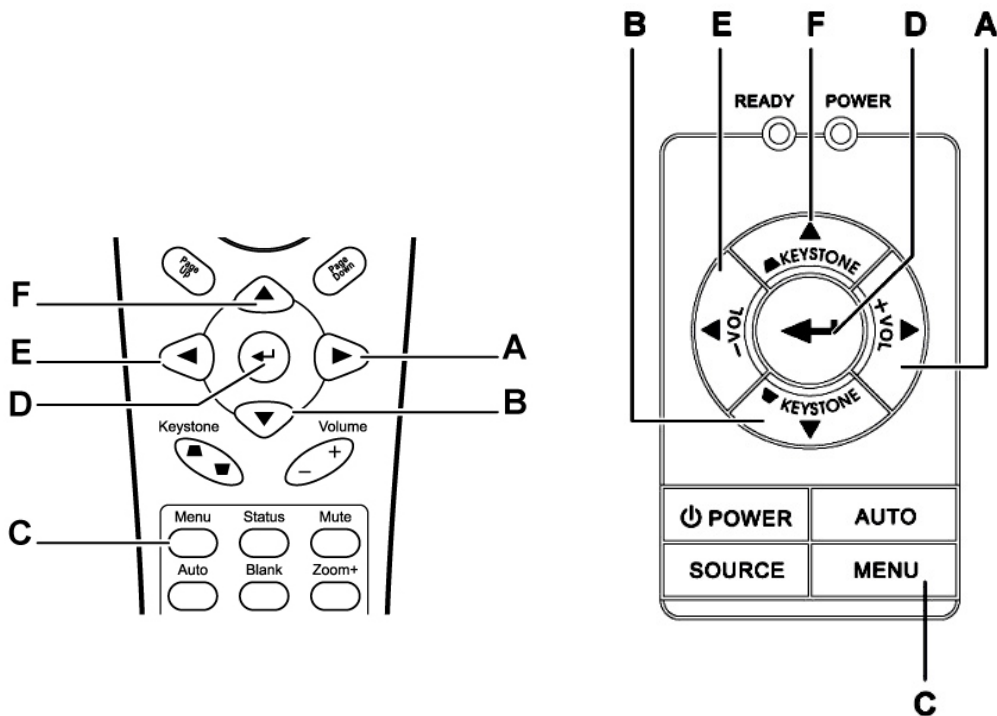

1. To open the OSD, press the **Menu** button.
2. There are six menus. Press the cursor ◀▶ button to move through the menus.
3. Press the cursor ▲▼ button to move up and down in a menu.
4. Press ◀▶ to change values for settings, and then press **Enter** or ▶ to confirm the new setting.
5. Press **Menu** to close the OSD or leave a submenu.

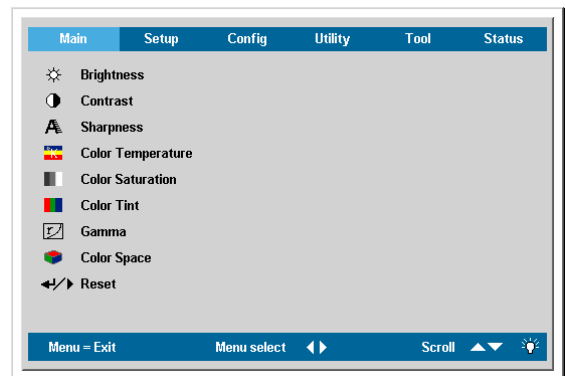

Note:

Depending on the video source not all items in the OSD are available. For example, the **Horizontal/Vertical Position** items in the Setup menu can only be modified when connected to a PC. Items that are not available cannot be accessed and are grayed out.

Setting the OSD Language

You may want to reference the OSD on your projector while reading this section. Set the OSD language to your preference before continuing. (The default language is English.)

1. Press the **Menu** button. The **Main** menu appears.

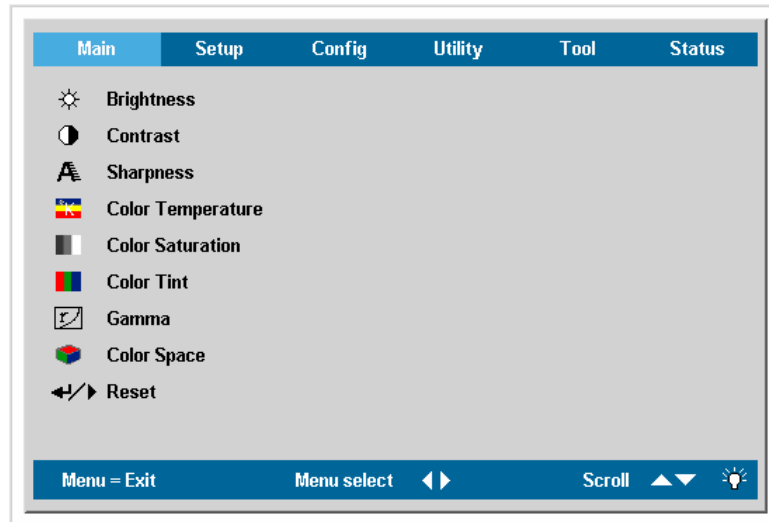

2. Press the cursor ◀▶ button until **Tool** is highlighted.

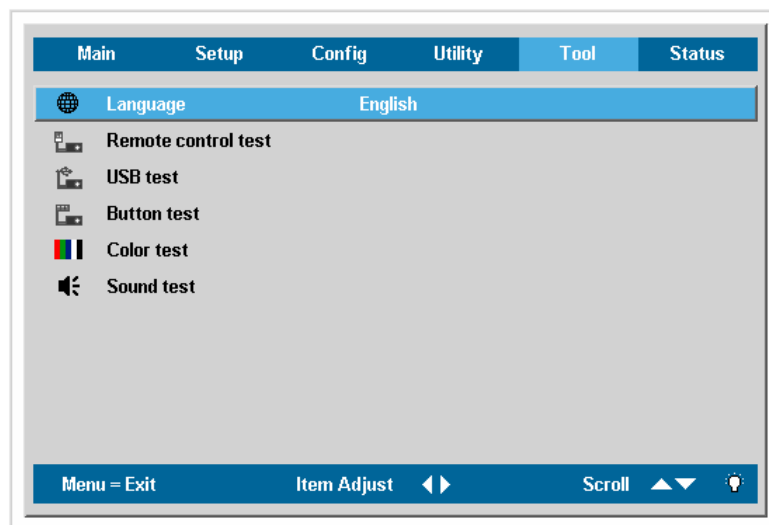

3. Press the cursor ▲▼ button until **Tool** is highlighted.
4. Press the ◀▶ button until your language is displayed.
5. Press the **Menu** button twice to close the OSD.

Setting the OSD Language

Use the following illustration to quickly find a setting or determine the range for a setting.

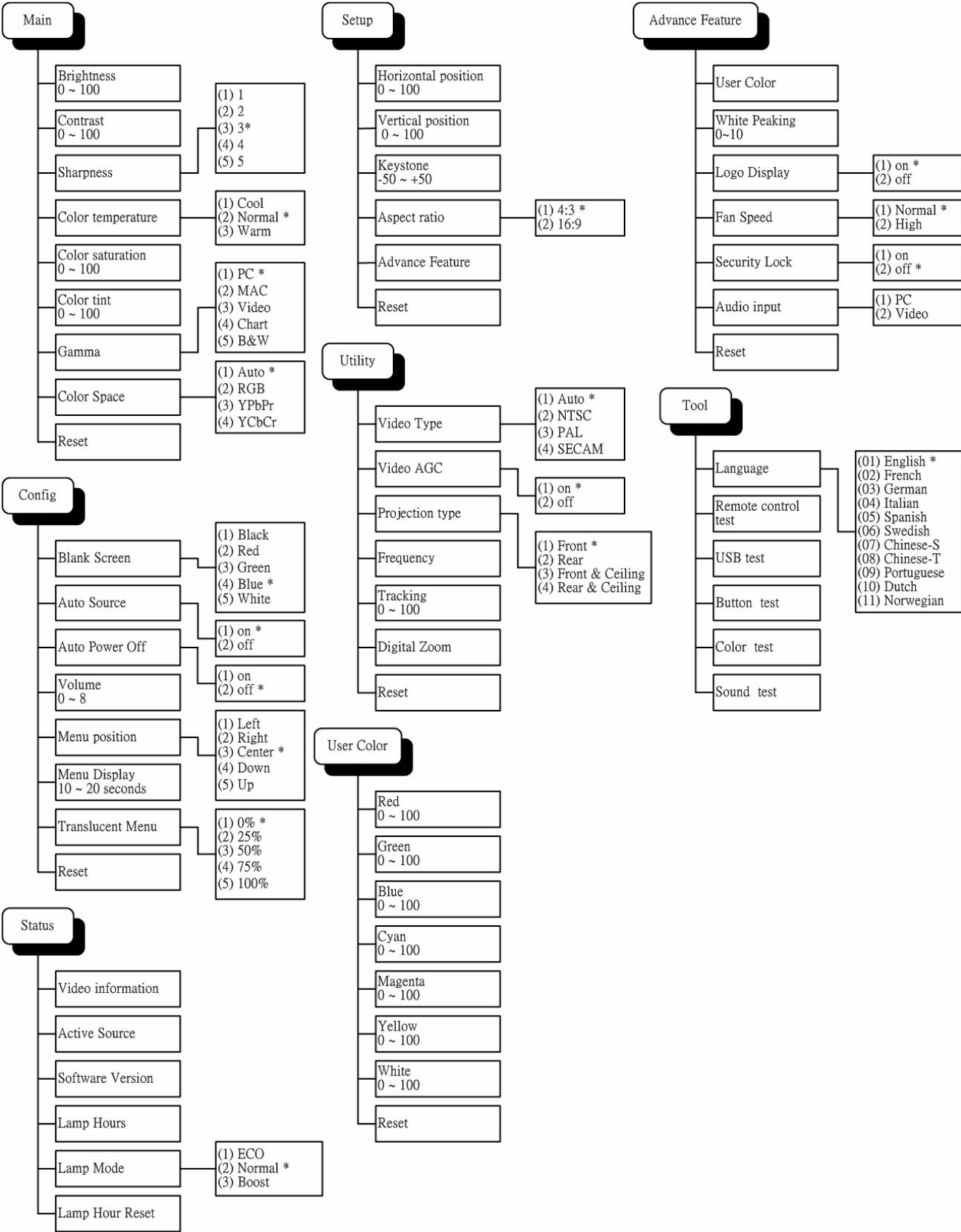

Main Menu

Press the **Menu** button to open the **OSD** menu. Press the cursor ◀▶ button to move to the **Main** menu. Press the cursor ▲▼ button to move up and down in the **Main** menu. Press ◀▶ to change values for settings, and then press **Enter** or ▶ to confirm the new setting.

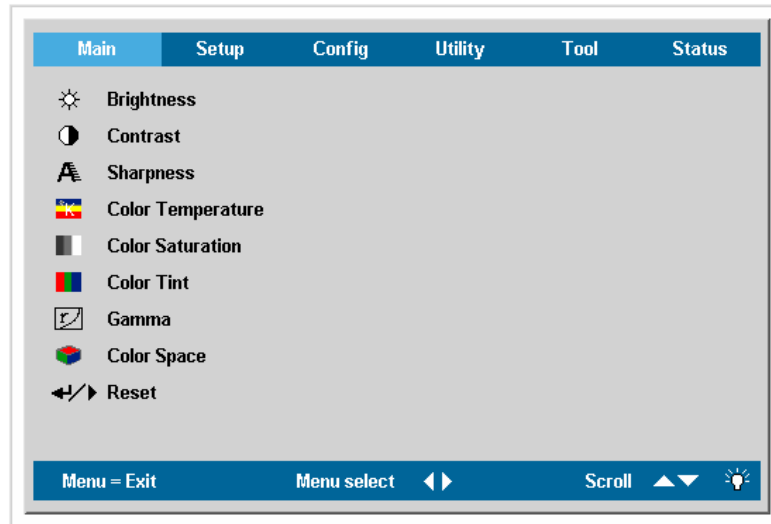

ITEM	DESCRIPTION	DEFAULT												
Brightness	Press the cursor ◀▶ button to adjust the brightness. (Range: 0 – 100)	50												
Contrast	Press the cursor ◀▶ button to adjust the contrast. (Range: 0 – 100)	50												
Sharpness	Press the cursor ◀▶ button to adjust the display sharpness (Range: 1-5)	3												
Color Temperature	Press the cursor ◀▶ button to adjust the color temperature. (Range: Cool/Normal/Warm)	Normal												
Color Saturation	Press the cursor ◀▶ button to adjust the video saturation. (Range: 0 – 100)	50												
Color Tint	Press the cursor ◀▶ button to adjust the video tint/hue. (Range: 0 – 100)	50												
Gamma	Press the cursor ◀▶ button to adjust the gamma correction of the display. <table border="1" style="margin-left: 40px;"> <thead> <tr> <th>Input</th> <th>Gamma</th> </tr> </thead> <tbody> <tr> <td>PC</td> <td>2.2</td> </tr> <tr> <td>MAC</td> <td>1.8</td> </tr> <tr> <td>Video</td> <td>2.4</td> </tr> <tr> <td>Chart</td> <td>2.2</td> </tr> <tr> <td>B&W</td> <td>2.4</td> </tr> </tbody> </table>	Input	Gamma	PC	2.2	MAC	1.8	Video	2.4	Chart	2.2	B&W	2.4	Data source: PC Video source: Video
Input	Gamma													
PC	2.2													
MAC	1.8													
Video	2.4													
Chart	2.2													
B&W	2.4													
Color Space	Press the cursor ◀▶ button to adjust the color space. (Range: Auto – RGB – YPbPr- YCbCr)	Auto												
Reset	Resets all Main settings to default values	—												

Main Menu Functions Available for Connected Source

Function	RGB	DVI	Component Video	Composite Video	S-video
Brightness	x	x	x	x	x
Contrast	x	x	x	x	x
Sharpness	x	x	x	x	x
Color Temp	x	x	x	x	x
Color Saturation			x	x	x
Color Tint			x	x	x
Gamma	x	x	x	x	x
Color Space	x	x	x	x	x
Reset	x	x	x	x	x

x = available to video source

Setup Menu

Press the **Menu** button to open the **OSD** menu. Press the cursor ◀▶ button to move to the **Setup** menu. Press the cursor ▲▼ button to move up and down in the **Setup** menu. Press ◀▶ to change values for settings, and then press **Enter** or ▶ to confirm the new setting.

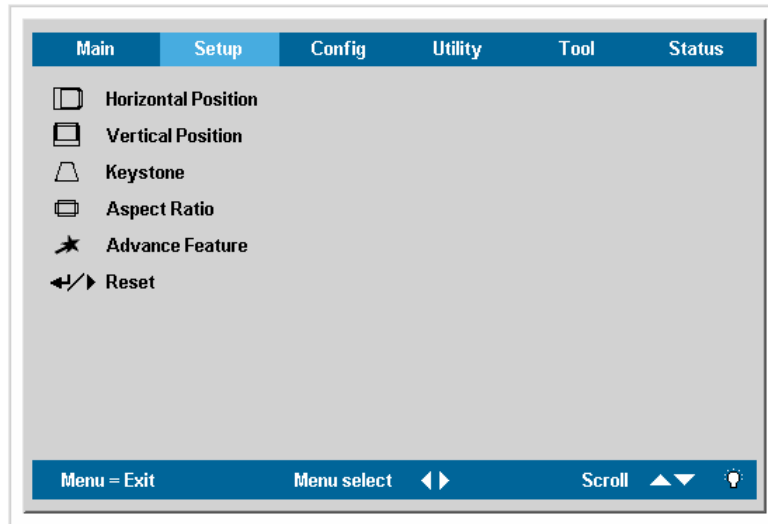

ITEM	DESCRIPTION	DEFAULT
Horizontal Position	Press the cursor ◀▶ button to move the image left or right. (Range: 0 – 100)	50
Vertical Position	Press the cursor ◀▶ button to move the image up or down. (Range: 0 – 100)	50
Keystone	Press the cursor ◀▶ button to correct distortion of the projected image. (Range: -50 – +50)	0
Aspect Ratio	Press the cursor ◀▶ button to toggle between the 4:3 standard format and the 16:9 High Definition TV (HDTV) format.	4:3
Advance Feature	See “Advance Feature” on page 25.	—
Reset	Resets Keystone and Aspect Ratio to default values	—

Setup Menu Functions Available for Connected Source

Function	RGB	DVI	Component Video	Composite Video	S-video
H Position	x				
V Position	x				
Keystone correction	x	x	x	x	x
Aspect Ratio	x	x	x	x	x
Advance Feature	x	x	x	x	x

Function	RGB	DVI	Component Video	Composite Video	S-video
Reset	x	x	x	x	x

x = available to video source

Advance Feature

Press the **Menu** button to open the **OSD** menu. Press ◀▶ to move to the **Setup** menu. Press ▲▼ to move to the **Advance Feature** menu and then press **Enter** or ▶. Press ▲▼ to move up and down in the **Advance Feature** menu. Press ◀▶ to change values for settings, and then press **Enter** or ▶ to confirm the new setting.

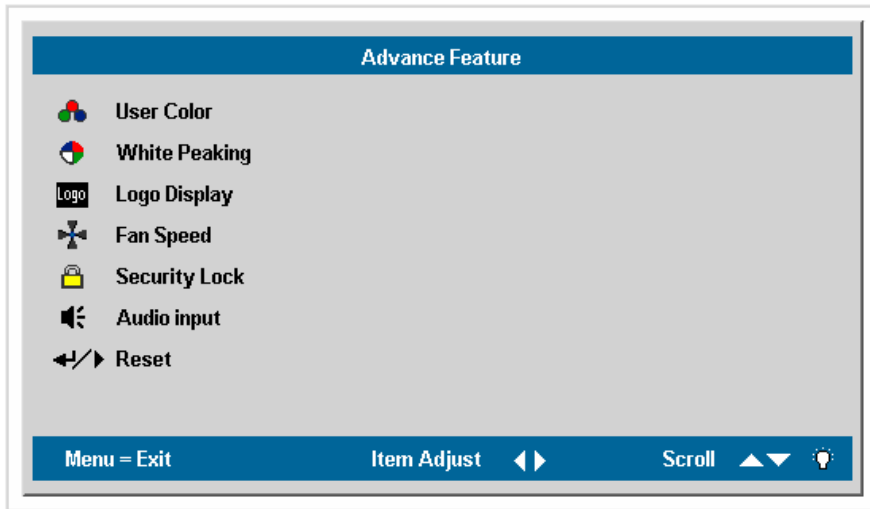

ITEM	DESCRIPTION	DEFAULT
User Color	This feature adjusts the color balance in each color of RGB (red, green, blue), and their neutral colors (cyan, magenta, yellow, white) by using color correction adjustment. Increasing a color’s setting heightens the intensity of that color on the screen, while a lower setting makes the color less intense. Press ▲▼ to select a color. Press ◀▶ to adjust the selected color. (Range: 0 – 100)	80
White Peaking	White Peaking increases the output in the brightest whites without changing the blacks and dark grays. It crushes the whites slightly, but it does not appear to clip them or seriously obscure white detail. If you prefer a stronger image, adjust toward the maximum setting. For a smoother, more natural image, adjust toward the minimum setting. Press ◀▶ to adjust the value of white peaking. (Range: 0 – 10)	Data source: 10 Video source: 2
Logo Display	Press ◀▶ to enable or disable if the logo displays when the projector starts, and when no source is detected. (Range: On – Off)	On
Fan Speed	Press the cursor ◀▶ button to toggle between normal and high fan speed Set Fan Speed to High in altitudes over 1500 meters (5000 feet).	Normal

ITEM	DESCRIPTION	DEFAULT
Security Lock	<p>Press the cursor ◀▶ button to enable or disable Security Lock. When you enable Security Lock a Register Password dialog box appears:</p> <p>You can only use the following four cursor buttons, ▲ ▼ ◀ ▶ in the password fields. Press the cursor buttons five times in any order and confirm to set the password. When the password is enabled, it must be entered every time after you power on the projector. See “Setting an Access Password (Security Lock)” on page 15 for steps on setting the password.</p>	—
Audio Input	Press the cursor ◀▶ button to toggle between PC and Video input channels.	Data Source: PC Video source: Video
Reset	Press Enter or ▶ to reset advance feature settings to default values	—

Note:

If Security Lock is enabled, you must enter the password every time the projector is turned on. However, if the projector is already turned on, Security Lock can be disabled without knowing the current password.

User Color

Press the **Menu** button to open the **OSD** menu. Press ◀▶ to move to the **Setup** menu. Press ▲▼ to move to the **Advance Feature** menu and then press **Enter** or ▶. Press ▲▼ to move to the **User Color** menu and then press **Enter** or ▶. Press ▲▼ to move up and down to select a color. Press ◀▶ to change values for settings, and then press **Enter** or ▶ to confirm the new setting.

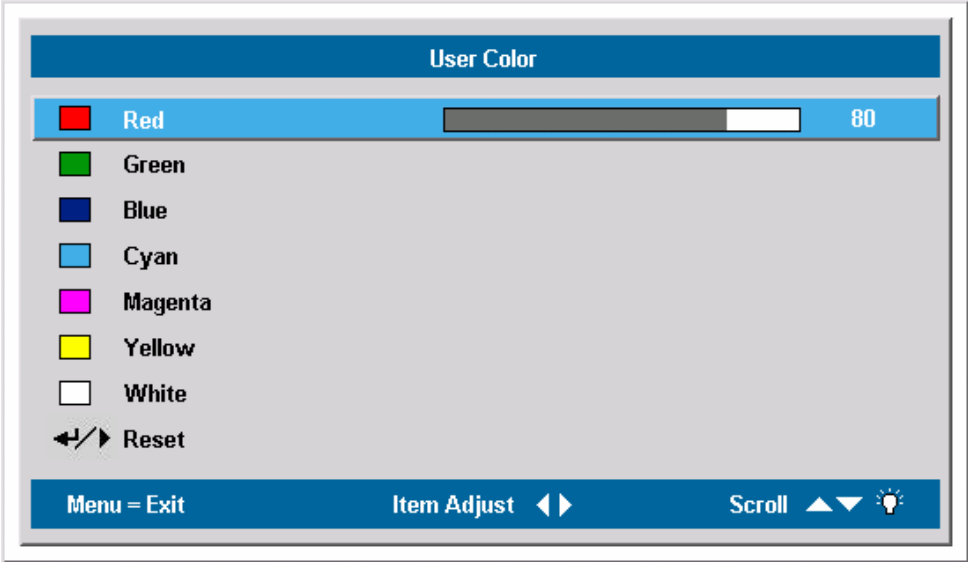

ITEM	DESCRIPTION	DEFAULT
Red	Press the cursor ◀▶ button to adjust the red color level. (Range: 0-100)	80
Green	Press the cursor ◀▶ button to adjust the green color level. (Range: 0-100)	80
Blue	Press the cursor ◀▶ button to adjust the blue color level. (Range: 0-100)	80
Cyan	Press the cursor ◀▶ button to adjust the cyan color level. (Range: 0-100)	80
Magenta	Press the cursor ◀▶ button to adjust the magenta color level. (Range:0-100)	80
Yellow	Press the cursor ◀▶ button to adjust the yellow color level. (Range: 0-100)	80
White	Press the cursor ◀▶ button to adjust the white color level. (Range: 0-100)	80
Reset	Resets all User Color settings to default values	—

Config Menu

Press the **Menu** button to open the **Main** menu. Press the cursor ◀▶ button to move to the **Config** menu. Press the cursor ▲▼ button to move up and down in the **Config** menu. Press ◀▶ to change values for settings, and then press **Enter** or ▶ to confirm the new setting.

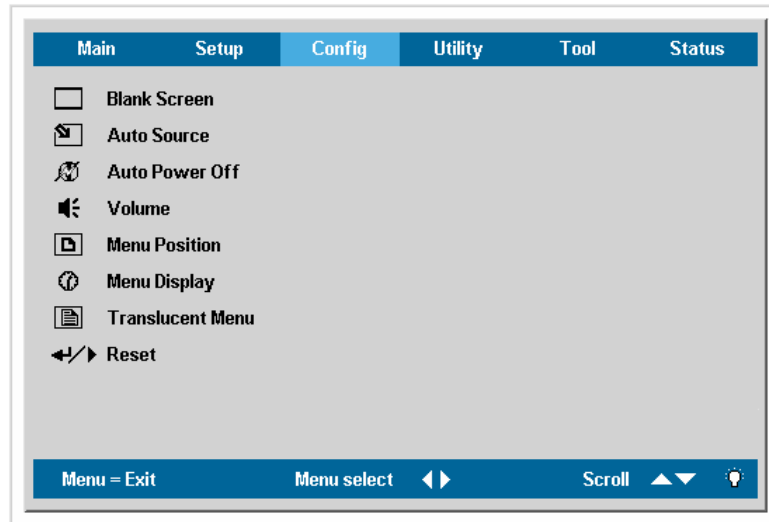







ITEM	DESCRIPTION	DEFAULT
Blank Screen	Press the cursor ◀▶ button to select a background color for the blank screen. (Range: Black – Red – Green – Blue – White)	Blue
Auto Source	Press the cursor ◀▶ button to enable or disable automatic source detection. (Range: On – Off)	On
Auto Power Off	Press the cursor ◀▶ button to enable or disable automatic shut-down of lamp after 10 minutes of inactivity. (Range: On – Off)	Off
Volume	Press the cursor ◀▶ button to adjust the audio volume level. (Range: 0 - 8)	4
Menu Position	Press the cursor ◀▶ button to position the OSD on screen. (Range: Left – Right – Center – Down – Up)	Center
Menu Display	Press the cursor ◀▶ button to determine the timeout delay of the OSD. (Range: 10 – 20 sec.)	15
Translucent Menu	Press the cursor ◀▶ button to set menu screen translucency. (Range: 0% – 100%)	0%
Reset	Resets all Config items to default values	

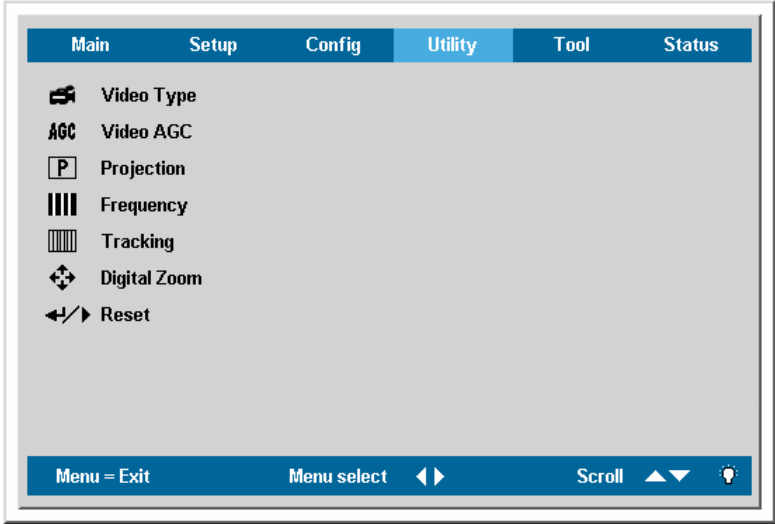

Note:
The Config menu functions are available to all video sources.

Utility Menu

Press the **Menu** button to open the **Main** menu. Press the cursor ◀▶ button to move to the **Utility** menu. Press the cursor ▲▼ button to move up and down in the **Utility** menu. Press ◀▶ to change values for settings, and then press **Enter** or ▶ to confirm the new setting.



ITEM	DESCRIPTION	DEFAULT
Video Type	Press the cursor ◀▶ button to select the video standard (Range: Auto – NTSC – PAL – SECAM)	Auto
Video AGC	Press the cursor ◀▶ button to enable or disable automatic gain control for the video source. (Range: On – Off)	On
Projection	Press the cursor ◀▶ button to choose from four projection methods: <div style="display: flex; flex-direction: column; gap: 10px;"> <div> Desktop mount, front of screen</div> <div> Desktop mount, rear of screen</div> <div> Ceiling mount, front of screen</div> <div> Ceiling mount, rear of screen</div> </div>	Desktop front 
Frequency	Press the cursor ◀▶ button to adjust the A/D sampling clock. (Range: 0° - 180°)	Auto detected
Tracking	Press the cursor ◀▶ button to adjust the A/D sampling number. (Range: 1 - 100)	Auto detected

ITEM	DESCRIPTION	DEFAULT
Digital Zoom	<p>Digital operation for zoom and pan adjustment. Press Enter or ▶. The Zoom menu appears.</p>  <p>Press ▲ to zoom in; press ▼ to zoom out. Press Enter or ▶ to open the Pan menu. (You must zoom in before you can open the Pan menu.)</p>  <p>Use the cursor buttons to pan the zoomed image. Press the Menu button to exit.</p>	—
Reset	Resets Video Type, Video AGC, Projection, and Digital Zoom to default values	—

Utility Menu Functions Available for Connected Source

Function	RGB	DVI	Component Video	Composite Video	S-video
Video Type				x	x
Video AGC				x	x
Projection	x	x	x	x	x
Frequency	x		x		
Tracking	x				
Digital Zoom	x		x	x	x
Reset	x	x	x	x	x

x = available to video source

Tool Menu

Press the **Menu** button to open the **Main** menu. Press the cursor ◀▶ button to move to the **Tool** menu. Press the cursor ▲▼ button to move up and down in the **Tool** menu. Press **Enter** or ▶ to confirm the new setting.

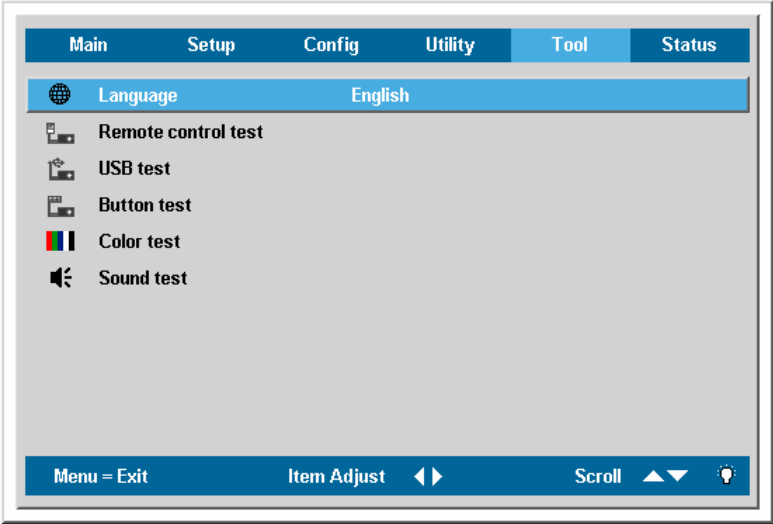

ITEM	DESCRIPTION	DEFAULT
Language	Press the cursor ◀▶ to select the desired language	English
Remote control test	Follow on-screen prompts to carry out the remote control test. You are returned to the Tool menu at the end or by pressing the Menu button.	
USB test	Follow on-screen prompts to carry out the USB test. You are returned to the Tool menu at the end or by pressing the Menu button.	
Button test	Follow on-screen prompts to carry out the button test. You are returned to the Tool menu at the end or by pressing the Menu button.	
Color test	Follow on-screen prompts to carry out the color test. You are returned to the Tool menu at the end or by pressing the Menu button.	
Sound test	Follow on-screen prompts to carry out the sound test. You are returned to the Tool menu at the end or by pressing the Menu button.	

Status Menu

Press the **Menu** button to open the **Main** menu. Press the cursor ◀▶ button to move to the **Status** menu. Press the cursor ▲▼ button to move up and down in the **Status** menu.

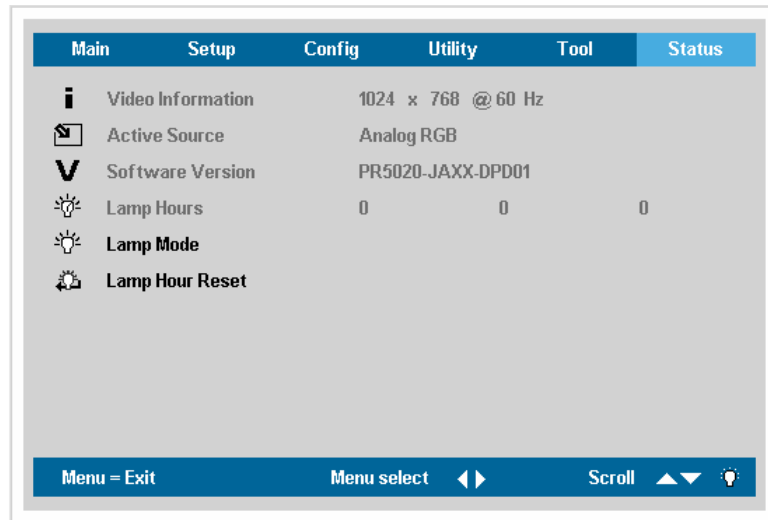

ITEM	DESCRIPTION	DEFAULT
Video Information	Displays the resolution and refresh rate for RGB/DVI mode. Displays the color standard for video mode.	These items are display only.
Active Source	Displays the active source.	
Software Version	Displays information about the software version.	
Lamp Hours	Shows the number of hours lamp has been in use for Eco , Normal and Boost modes.	
Lamp Mode	Press the cursor ◀▶ button to choose the lamp mode. Range: Eco , Normal and Boost. Eco mode uses less power and extends lamp life, but decreases lamp brightness. Boost mode uses more power and reduces lamp life, but increases lamp brightness.	Normal
Lamp Hour Reset	After replacing the lamp, this item should be reset. Refer to “Replacing the Projection Lamp” on page 36.	—

Replacing the Projection Lamp

The projection lamp should be replaced when it burns out. It should only be replaced with a certified replacement part, which you can order from your local dealer.

Important:

1. The lamp contains a certain amount of mercury and should be disposed of according to local ordinance regulations.
2. Avoid touching the glass surface of the new lamp: Doing so may shorten its operation life.

Warning:

Be sure to turn off and unplug the projector at least an hour before replacing the lamp. Failure to do so could result in a severe burn.

Note:

Safety glasses should be worn when replacing the lamp while the projector is ceiling mounted.

1. Loosen the two captive screws on the lamp compartment cover (A).

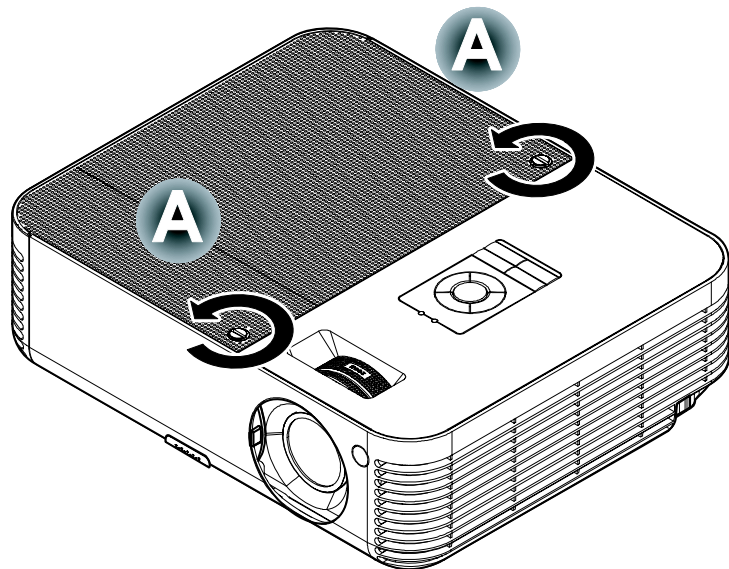

2. Open the lamp compartment cover (B).

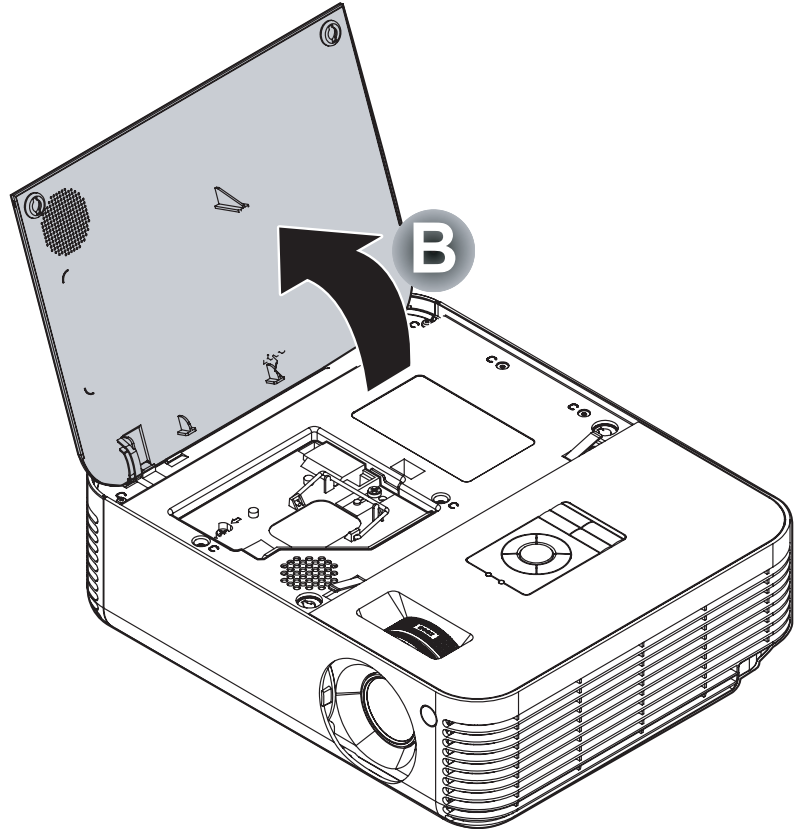

3. Remove the two screws from the lamp module (C).

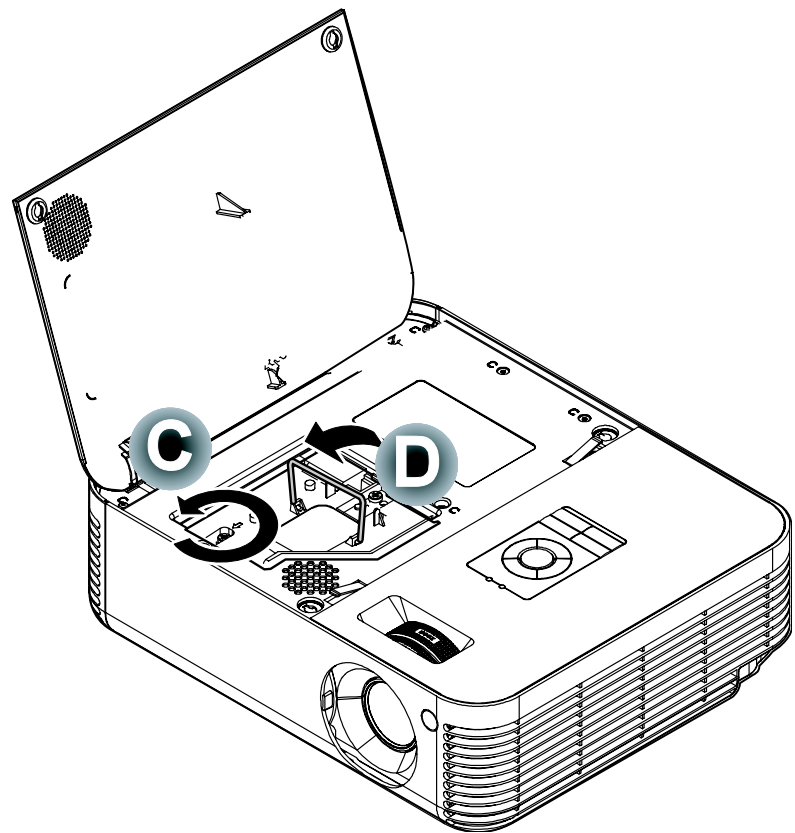

4. Lift the module handle up (D).

5. Pull firmly on the module handle to remove the lamp module (D)

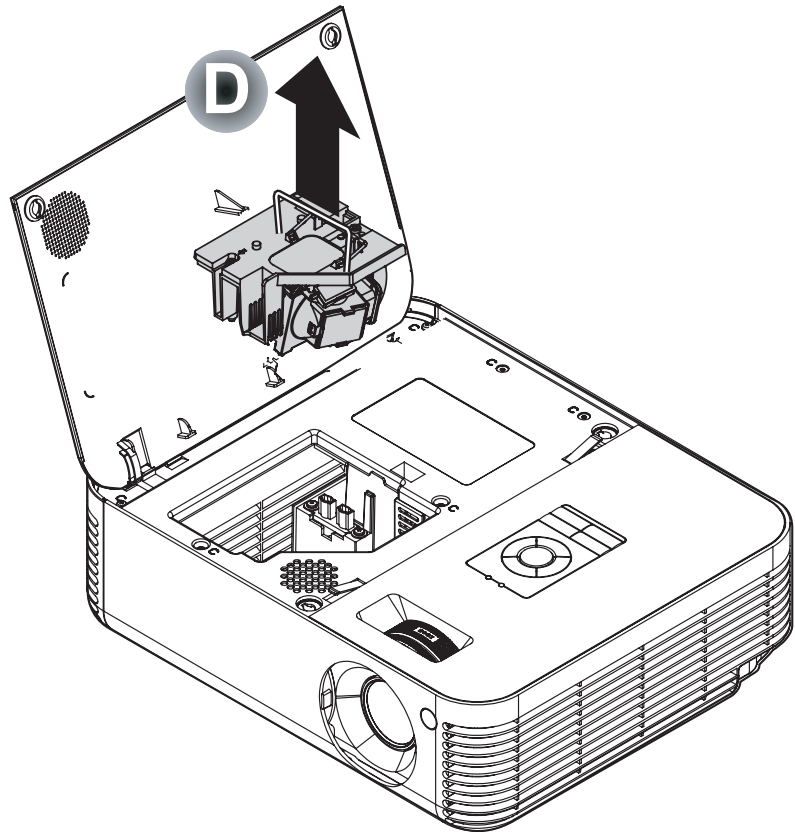

6. Reverse steps 1 to 5 to install the new lamp module.

Resetting the Lamp

After replacing the lamp, you should reset the lamp hour counter to zero. Refer to the following:

1. Press the **Menu** button to open the Main menu.
2. Press the cursor ◀▶ button to move to the **Status** menu.
3. Press the cursor ▲▼ button to move down to **Lamp Hour Reset**.
4. Press the cursor ▶ or **Enter** button.

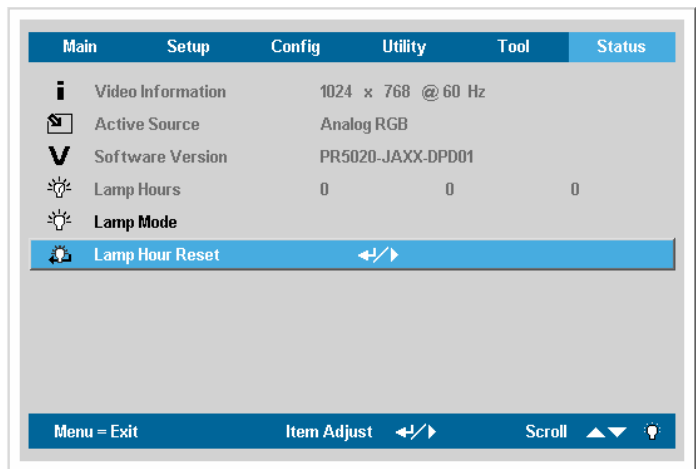

A message screen appears.

5. Press the cursor buttons in this order: ▼; ▲; ◀; ▶.
The **Status** menu appears again showing the **Lamp Hours** reset to zero.



Cleaning the Projector

Cleaning the projector to remove dust and grime will help ensure trouble-free operation.

Warning:

1. Be sure to turn off and unplug the projector at least an hour before cleaning. Failure to do so could result in a severe burn.
2. Use only a dampened cloth when cleaning. Do not allow water to enter the ventilation openings on the projector.
3. If a little water gets into the projector interior while cleaning, leave unplugged in a well-ventilated room for several hours before using.
4. If a lot of water gets into the projector interior when cleaning, have the projector serviced.

Cleaning the Lens

You can purchase optic lens cleaner from most camera stores. Refer to the following to clean the projector lens.

1. Apply a little optic lens cleaner to a clean soft cloth. (Do not apply the cleaner directly to the lens.)
2. Lightly wipe the lens in a circular motion.

Caution:

1. Do not use abrasive cleaners or solvents.
2. To prevent discoloration or fading, avoid getting cleaner on the projector case.

Cleaning the Case

Refer to the following to clean the projector case.

1. Wipe off dust with a clean dampened cloth.
2. Moisten the cloth with warm water and mild detergent (such as used to wash dishes), and then wipe the case.
3. Rinse all detergent from the cloth and wipe the projector again.

Caution:

To prevent discoloration or fading of the case, do not use abrasive alcohol-based cleaners.

Using the Kensington® Lock

If you are concerned about security, attach the projector to a permanent object with the Kensington slot and a security cable.

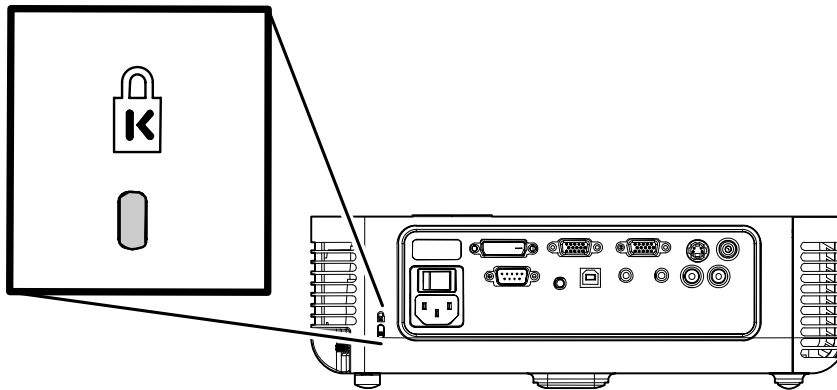

Note:

Contact your vendor for details on purchasing a suitable Kensington security cable.

The security lock corresponds to Kensington’s MicroSaver Security System. If you have any comment, contact: Kensington, 2853 Campus Drive, San Mateo, CA94403, U.S.A. Tel: 800-535-4242, <http://www.Kensington.com>.

Common problems and solutions

These guidelines provide tips to deal with problems you may encounter while using the projector. If the problem remains unsolved, contact your dealer for assistance.

Often after time spent troubleshooting, the problem is traced to something as simple as a loose connection. Check the following before proceeding to the problem-specific solutions.

- *Use some other electrical device to confirm that the electrical outlet is working.*
- *Ensure the projector is turned on.*
- *Ensure all connections are securely attached.*
- *Ensure the attached device is turned on.*
- *Ensure a connected PC is not in suspend mode.*
- *Ensure a connected notebook computer is configured for an external display. (This is usually done by pressing an Fn-key combination on the notebook.)*

Tips for Troubleshooting

In each problem-specific section, try the steps in the order suggested. This may help you to solve the problem more quickly.

Try to pin point the problem and thus avoid replacing non-defective parts. For example, if you replace batteries and the problem remains, put the original batteries back and go to the next step.

Keep a record of the steps you take when troubleshooting: The information may be useful when calling for technical support or for passing on to service personnel.

LED Error Messages

ERROR CODE MESSAGE	POWER LED/FLASHES	READY LED/FLASHES
Lamp usage task created error	2	1
Environment usage task created error	2	2
Thermal break status error	3	0
T1 temperature over temperature	3	1
T1 sensor status fail	4	1
Lamp lit error	5	1
Ballast SCI error	5	2
Ballast UART error	5	3
Fan1 error (Lamp)	6	1
Fan2 error (Ballast)	6	2
Fan3 error (Burner)	6	3
Fan4 error (Power)	6	4
Lamp door sensor detect high	7	0
DMD error	8	0
Color wheel error	9	0

Image Problems

Problem: No image appears on the screen

1. Verify the settings on your notebook or desktop PC.
2. Turn off all equipment and power up again in the correct order.

Problem: The image is blurred

1. Adjust the **Focus** on the projector.
2. Press the **Auto** button on the remote control or projector.
3. Ensure the projector-to-screen distance is within the 10-meter (33-foot) specified range.
4. Check that the projector lens is clean.

Problem: The image is wider at the top or bottom (trapezoid effect)

1. Position the projector so it is as perpendicular to the screen as possible.
2. Use the **Keystone** button on the remote control or projector to correct the problem.

Problem: The image is reversed or upside down

Check the **Projection** setting on the **Utility** menu of the OSD.

Problem: The image is streaked

1. Set the **Frequency** and **Tracking** settings on the **Utility** menu of the OSD to the default settings.

2. To ensure the problem is not caused by a connected PC's video card, connect to another computer.

Problem: The image is flat with no contrast

Adjust the **Contrast** setting on the **Main** menu of the OSD.

Problem: The color of the projected image does not match the source image.

Adjust the **Color Temperature** and **Gamma** settings on the **Main** menu of the OSD.

Lamp Problems

Problem: There is no light from the projector

1. Check that the power cable is securely connected.
2. Ensure the power source is good by testing with another electrical device.
3. Restart the projector in the correct order and check that the Power LED is green.
4. If you have replaced the lamp recently, try resetting the lamp connections.
5. Replace the lamp module.
6. Put the old lamp back in the projector and have the projector serviced.

Problem: The lamp goes off

1. Power surges can cause the lamp to turn off. Press the power button twice to turn off the projector. When the Ready LED is on, press the power button.
2. Replace the lamp module.
3. Put the old lamp back in the projector and have the projector serviced.

Remote Control Problems

Problem: The projector does not respond to the remote control

1. Direct the remote control towards remote sensor on the projector.
2. Ensure the path between remote and sensor is not obstructed.
3. Turn off any fluorescent lights in the room.
4. Check the battery polarity.
5. Replace the batteries.
6. Turn off other Infrared-enabled devices in the vicinity.
7. Have the remote control serviced.

Audio Problems

Problem: There is no sound

1. Adjust the volume on the remote control.
2. Adjust the volume of the audio source.
3. Check the audio cable connection.
4. Test the source audio output with other speakers.
5. Have the projector serviced.

Problem: The sound is distorted

1. Check the audio cable connection.
2. Test the source audio output with other speakers.
3. Have the projector serviced.

SPECIFICATIONS

Input/output connectors

	PR3010	PR3020	PR5020
Data in	×	×	DVI-D
	RGB HD-15		
Data out	RGB HD-15		
Video	composite video (RCAx1)		
	S-video		
Audio in	Stereo RCAx2 (L+R)		
	Stereo Mini-jack		
Audio out	Stereo Mini-jack		
Control	×	×	RS-232
	USB		
Security	Kensington lock		

Projection Distance V.S. Projection Size

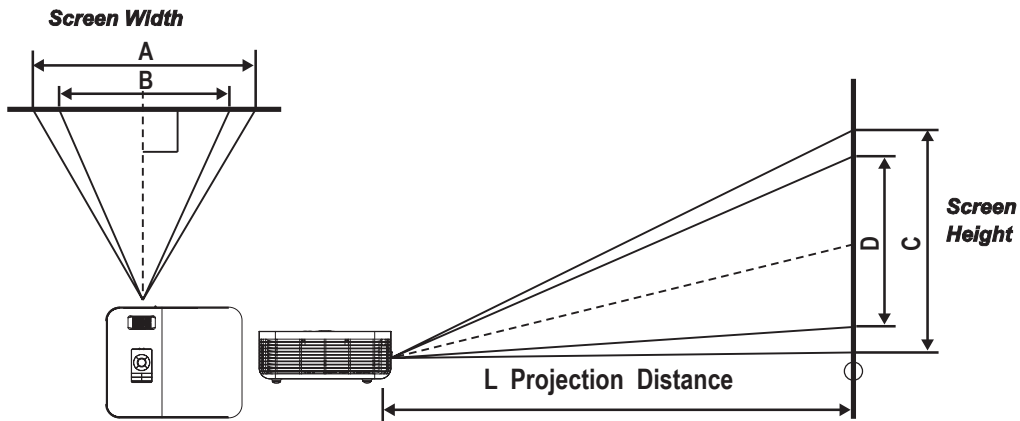

PR3020 and PR3010 Projection distance and size table

Projection Distance L	Max. Screen Size (Wide)		1.89	Max. Screen Size (Tele)		2.18
	Diagonal	Width A	Height C	Diagonal	Width B	Height D
1.00 m	0.66 m	0.53 m	0.40 m	0.57 m	0.46 m	0.34 m
3.28 '	26.04 "	20.83 "	15.62 "	22.57 "	18.06 "	13.54 "
1.50 m	0.99 m	0.79 m	0.60 m	0.86 m	0.69 m	0.52 m
4.92 '	39.06 "	31.25 "	23.43 "	33.86 "	27.09 "	20.32 "
2.40 m	1.59 m	1.27 m	0.95 m	1.38 m	1.10 m	0.83 m
7.87 '	62.49 "	49.99 "	37.50 "	54.18 "	43.34 "	32.51 "
2.80 m	1.85 m	1.48 m	1.11 m	1.61 m	1.28 m	0.96 m
9.18 '	72.91 "	58.33 "	43.74 "	63.21 "	50.57 "	37.93 "
3.20 m	2.12 m	1.69 m	1.27 m	1.83 m	1.47 m	1.10 m
10.50 '	83.32 "	66.66 "	49.99 "	72.24 "	57.79 "	43.34 "
3.60 m	2.38 m	1.90 m	1.43 m	2.06 m	1.65 m	1.24 m
11.81 '	93.74 "	74.99 "	56.24 "	81.27 "	65.01 "	48.76 "
4.00 m	2.65 m	2.12 m	1.59 m	2.29 m	1.83 m	1.38 m
13.12 '	104.15 "	83.32 "	62.49 "	90.30 "	72.24 "	54.18 "
4.40 m	2.91 m	2.33 m	1.75 m	2.52 m	2.02 m	1.51 m
14.43 '	114.57 "	91.66 "	68.74 "	99.33 "	79.46 "	59.60 "
4.80 m	3.17 m	2.54 m	1.90 m	2.75 m	2.20 m	1.65 m
15.74 '	124.98 "	99.99 "	74.99 "	108.36 "	86.69 "	65.01 "
5.20 m	3.44 m	2.75 m	2.06 m	2.98 m	2.39 m	1.79 m
17.06 '	135.40 "	108.32 "	81.24 "	117.39 "	93.91 "	70.43 "
5.60 m	3.70 m	2.96 m	2.22 m	3.21 m	2.57 m	1.93 m
18.37 '	145.82 "	116.65 "	87.49 "	126.42 "	101.13 "	75.85 "
7.00 m	4.63 m	3.70 m	2.78 m	4.01 m	3.21 m	2.41 m

22.96'	182.27"	145.82"	109.36"	158.02"	126.42"	94.81"
10.00 m	6.61 m	5.29 m	3.97 m	5.73 m	4.59 m	3.44 m
32.80'	260.38"	208.31"	156.23"	225.75"	180.60"	135.45"

PR5020 Projection distance and size table

Projection Distance L	Max. Screen Size (Wide)		1.8	Max. Screen Size (Tele)		2.1
	Diagonal	Width A	Height C	Diagonal	Width B	Height D
1.00 m	0.69 m	0.56 m	0.42 m	0.60 m	0.48 m	0.36 m
3.28'	27.34"	21.87"	16.40"	23.43"	18.75"	14.06"
1.50 m	1.04 m	0.83 m	0.63 m	0.89 m	0.71 m	0.54 m
4.92'	41.01"	32.81"	24.61"	35.15"	28.12"	21.09"
2.40 m	1.67 m	1.33 m	1.00 m	1.43 m	1.14 m	0.86 m
7.87'	65.62"	52.49"	39.37"	56.24"	44.99"	33.75"
2.80 m	1.94 m	1.56 m	1.17 m	1.67 m	1.33 m	1.00 m
9.18'	76.55"	61.24"	45.93"	65.62"	52.49"	39.37"
3.20 m	2.22 m	1.78 m	1.33 m	1.90 m	1.52 m	1.14 m
10.50'	87.49"	69.99"	52.49"	74.99"	59.99"	44.99"
3.60 m	2.50 m	2.00 m	1.50 m	2.14 m	1.71 m	1.29 m
11.81'	98.43"	78.74"	59.06"	84.36"	67.49"	50.62"
4.00 m	2.78 m	2.22 m	1.67 m	2.38 m	1.90 m	1.43 m
13.12'	109.36"	87.49"	65.62"	93.74"	74.99"	56.24"
4.40 m	3.06 m	2.44 m	1.83 m	2.62 m	2.10 m	1.57 m
14.43'	120.30"	96.24"	72.18"	103.11"	82.49"	61.87"
4.80 m	3.33 m	2.67 m	2.00 m	2.86 m	2.29 m	1.71 m
15.74'	131.23"	104.99"	78.74"	112.49"	89.99"	67.49"
5.20 m	3.61 m	2.89 m	2.17 m	3.10 m	2.48 m	1.86 m
17.06'	142.17"	113.74"	85.30"	121.86"	97.49"	73.12"
5.60 m	3.89 m	3.11 m	2.33 m	3.33 m	2.67 m	2.00 m
18.37'	153.11"	122.48"	91.86"	131.23"	104.99"	78.74"
7.00 m	4.86 m	3.89 m	2.92 m	4.17 m	3.33 m	2.50 m
22.96'	191.38"	153.11"	114.83"	164.04"	131.23"	98.43"
10.00 m	6.94 m	5.56 m	4.17 m	5.95 m	4.76 m	3.57 m
32.80'	273.40"	218.72"	164.04"	234.35"	187.48"	140.61"

Shaded rows are equivalent measurement in feet and inches

Timing Mode Table

The projector can display several resolutions. The following table outlines the resolutions that can be displayed by the projector.

Signal	Resolution	Frequency H. (KHz)	Frequency V. (Hz)	Video	Digital	Analog
NTSC	-	15.734	60.0	○	-	-
PAL/SECAM	-	15.625	50.0	○	-	-
VESA	640 x 350	37.9	85.1	-	○	○
	720 x 400	31.5	70.0	-	○	○
	720 x 400	37.9	85.0	-	○	○
	640 x 480	31.5	60.0	-	○	○
	640 x 480	37.9	72.8	-	○	○
	640 x 480	37.5	75.0	-	○	○
	640 x 480	43.3	85.0	-	○	○
	800 x 600	37.9	60.3	-	○	○
	800 x 600	46.9	75.0	-	○	○
	800 x 600	48.1	72.2	-	○	○
	800 x 600	53.7	85.1	-	○	○
	1024 x 768	48.4	60.0	-	○	○
	1024 x 768	56.5	70.1	-	○	○
	1024 x 768	60.0	75.0	-	○	○
	1024 x 768	68.7	85.0	-	○	○
1280 x 1024	64.0	60.0	-	○	○	
1600 x 1200**	75.0	60.0	-	-	○	
Apple Macintosh	640 x 480	35.0	66.7	-	○	○
	832 x 624	49.7	74.5	-	○	○
	1024 x 768	60.2	74.9	-	○	○
	1152 x 870	68.7	75.1	-	○	○
SDTV	480i	31.5	30.0	-	-	-
	576i	31.3	25.0	-	-	-
	480p	31.5	60.0	-	-	-
HDTV	576p	31.3	50.0	-	-	-
	720p	45.0	60.0	-	-	-

○: Frequency supported - : Frequency not supported

The native resolution for the PR5020 and PR3020 is 1024 x 768. The native resolution for the PR3010 is 800 x 600. Resolution other than native mode may be displayed with uneven size of text or lines.

UXGA resolution with half-sampling

Digital Timing is only for PR5020

Projector Dimensions

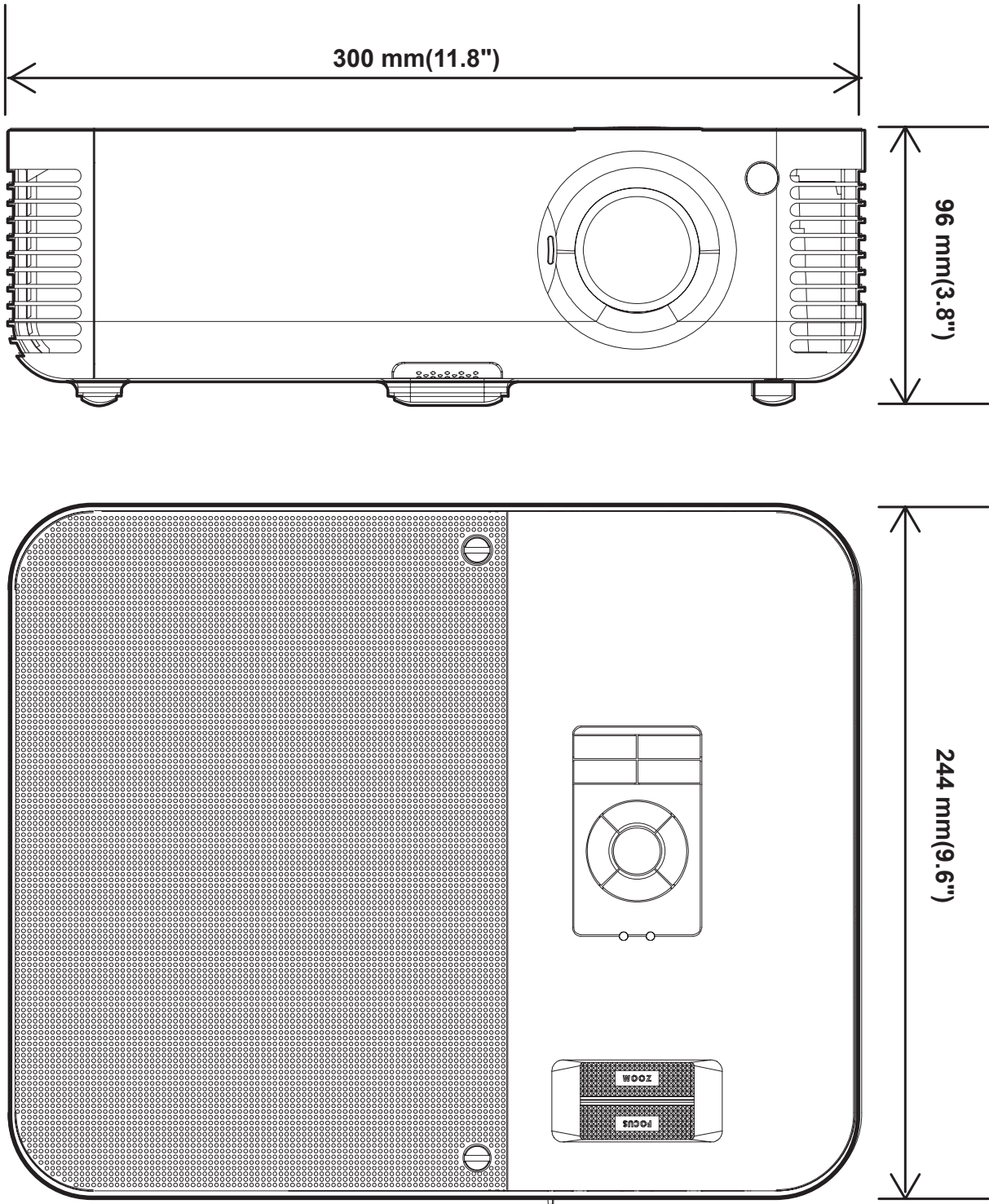

FCC Warning

This equipment has been tested and found to comply with the limits for a Class B digital device pursuant to Part 15 of the FCC Rules. These limits are designed to provide reasonable protection against harmful interference when the equipment is operated in a commercial environment.

This equipment generates, uses, and can radiate radio frequency energy and, if not installed and used in accordance with the instruction manual, may cause harmful interference to radio communications. Operation of this equipment in a residential area is likely to cause harmful interference in which case the user will be required to correct the interference at his own expense.

Changes or modifications not expressly approved by the parties responsible for compliance could void the user's authority to operate the equipment.

Canada

This class B digital apparatus complies with Canadian ICES-003.

Safety Certifications

FCC Class B, UL, C-UL, CE, CB, TUV-GS, CCC , ICES-003(Class B)

EN 55022 Warning

This is a Class B product. In a domestic environment, it may cause radio interference, in which case the user may be required to take adequate measures. The typical use is in a conference room, meeting room, or auditorium.

Planar System, Inc.

Customer Service

Online Support: <http://www.planar.com/support>

E-mail: PlanarSupport@planar.com

Tel: US/Canada 1-866-PLANAR-1 (1-866-752-6271 or 1-503-748-5953)

Hours: M-F, 8am-8pm Eastern Time

© 2006 Planar Systems, Inc. Planar is a registered trademark of Planar Systems, Inc.

Other brands and names are the property of their respective owners.

Technical information in this document is subject to change without notice