

FRONT VIEW & ROOF TOP VIEW WITH BUILDING

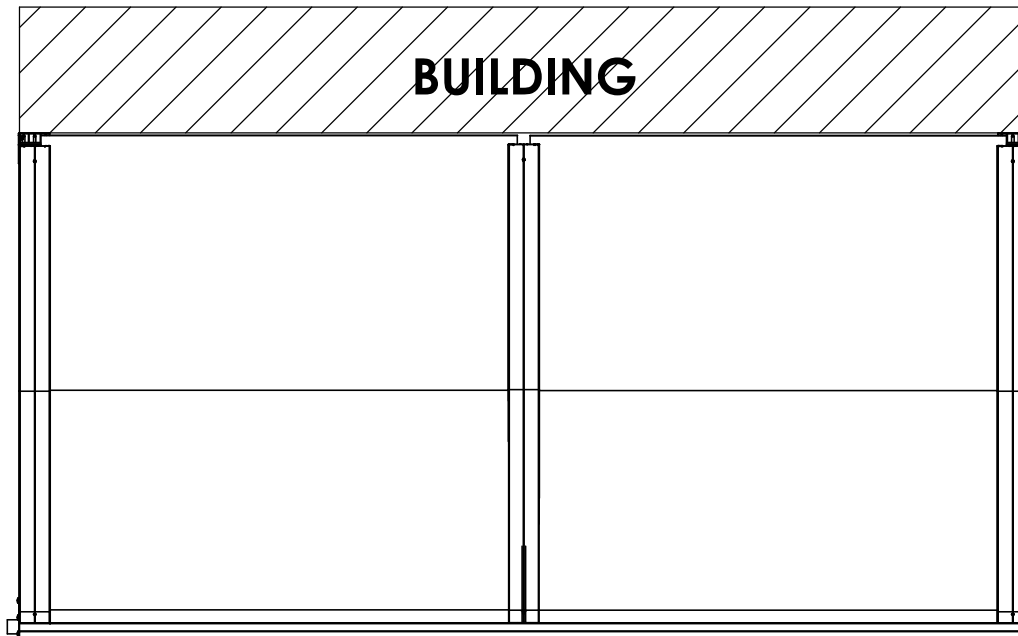
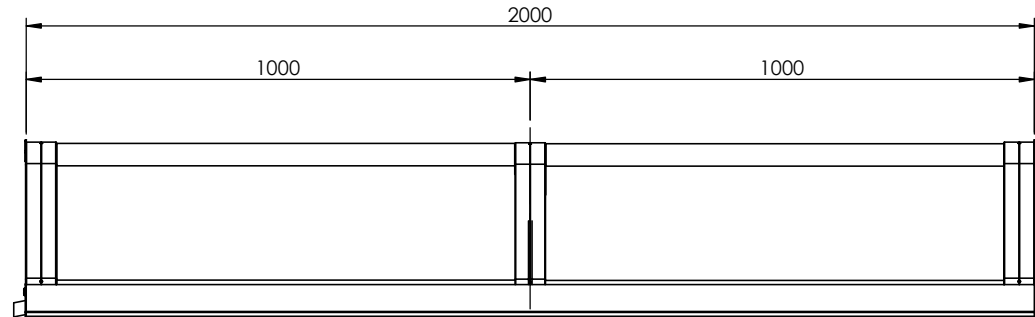

Originator :
Able Canopies Ltd

Drawing Title :
The Orwell

Product Name :
The Orwell Wallmounted

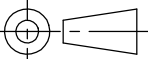
 3rd Angle Projection	Page	Date	Page Size	Scale	Drawn
	3 OF 5	03/02/15	A4 (L)	NTS	SHYAM

<small>This drawing and the product it displays is the sole property of Able Canopies Ltd. Any reproduction of the drawing or product without the written permission of Able Canopies Ltd is prohibited.</small>	Finish	Issuer	(Tol) +/-	Sequence	Revision
	PPC	ACS	1 mm	000001	V1.0

CROSS SECTION VIEW & ISOMETRIC VIEW

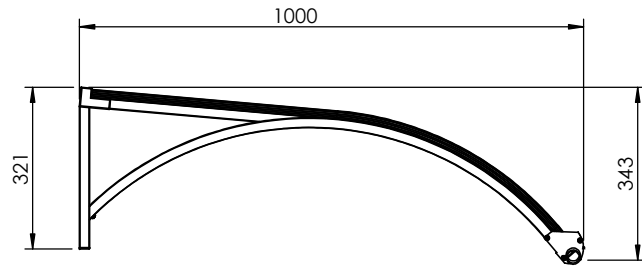
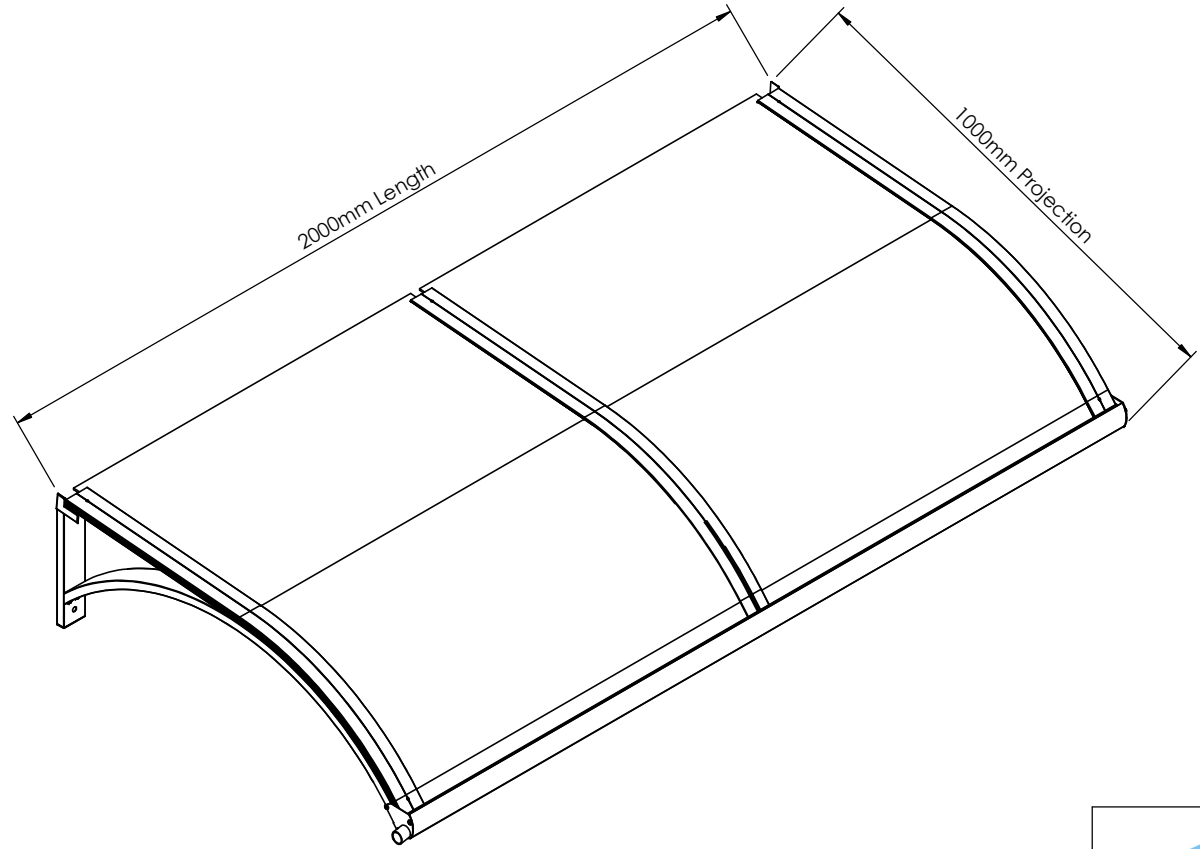

Originator :
Able Canopies Ltd

Drawing Title :
 The Orwell

Product Name :
 The Orwell Wallmounted

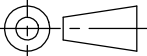
 3rd Angle Projection	Page	Date	Page Size	Scale	Drawn
	4 OF 5	03/02/15	A4 (L)	NTS	SHYAM

This drawing and the product it displays is the sole property of Able Canopies Ltd. Any reproduction of the drawing or product without the written permission of Able Canopies Ltd is prohibited.	Finish	Issuer	(Tol) +/-	Sequence	Revision
	PPC	ACS	1 mm	000001	V1.0

PRODUCT DETAIL

Glazing Bar Detail

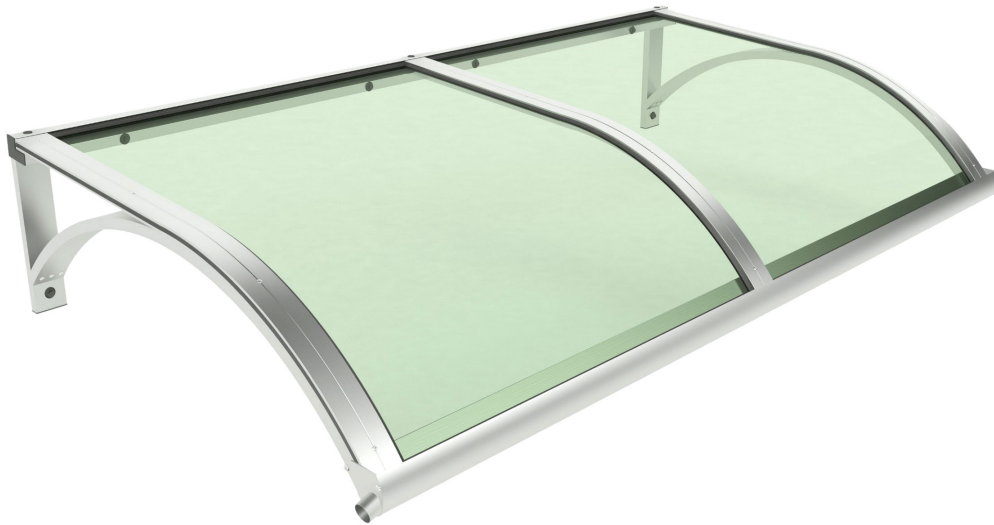
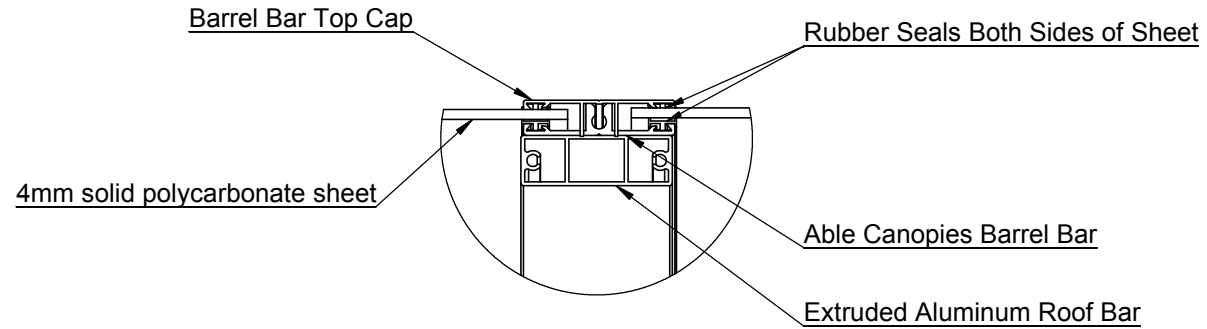

Originator :
Able Canopies Ltd

Drawing Title :
 The Orwell

Product Name :
 The Orwell Wallmounted

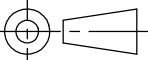
 3rd Angle Projection	Page	Date	Page Size	Scale	Drawn
	5 OF 5	03/02/15	A4 (L)	NTS	SHYAM

This drawing and the product it displays is the sole property of Able Canopies Ltd. Any reproduction of the drawing or product without the written permission of Able Canopies Ltd is prohibited.	Finish	Issuer	(Tol) +/-	Sequence	Revision
	PPC	ACS	1 mm	000001	V1.0