

National Aeronautics and
Space Administration

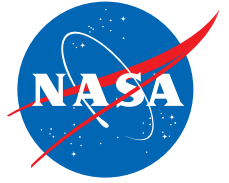

NASA'S
BEST
STUDENTS

BEGINNING ENGINEERING,
SCIENCE, AND TECHNOLOGY

An Educator's Guide to the Engineering Design Process
Grades K-2

This publication is in the Public Domain and is not protected by copyright.
Permission is not required for duplication.
EG-2011-3-036-GSFC

PROJECT SPONSOR

NASA Human Exploration and Operations Mission Directorate
Jerry Hartman, Education Lead

AUTHORS

*University of Maryland, Baltimore County &
NASA Goddard Space Flight Center*
Susan Hoban, PhD
Marci Delaney, PhD

CONTRIBUTORS

*Anne Arundel County
Public Schools, Maryland*
Don Higdon
Maureen McMahon, PhD
Tracy Clark-Keegan

Columbia Academy, Maryland
Brittany Hamolia

Fallston Middle School, Maryland
Victor Perry

University of Maryland, Baltimore County
Jamie Gurganus

EDITORS

Marci Delaney
Michelle Graf
Caitlin Toth

EPD GRAPHIC DESIGN

Adam Martin, UMBC

BOOK AND VIDEO LIST

Diane McKamy, St. Michael's School, MA

BEST EDP VIDEO SERIES

Production

Chris Smith, Honeywell

Written by

Chris Smith
Don Higdon

On camera talent

Don Higdon

Students from

Anne Arundel County Public Schools

BEST VIDEO SERIES

Animations and production

Chris Smith, Honeywell

Written by

Marci Delaney
Chris Smith
Brittany Hamolia

Voice Talent

Rick Varner, NASA GSFC &
Pennsylvania State University

MATERIALS

Standard Measuring Tools

*Below is a **suggested** list of materials needed to complete all activities in this guide for a group of 24-32 students (~8 teams). In addition, for your convenience, a NASA BEST Kit is available for purchase from Science Kit/Boreal Laboratories (www.sciencekit.com/NASABEST/), which supports ~30 students.*

- Digital scale (1)
- Graduated cylinder (1)
- Meter sticks (1 per team)
- Measuring tape (1)
- Rulers (1 per team)
- Stopwatches (1 per team)
- Thermometers (2 per team)





Materials for Activities & General Building Supplies



- aluminum foil
- balloons, assorted
- bamboo skewers
- binder clips, assorted
- blindfolds (1 per team)
- bubble wrap
- buttons or beads, assorted (~10 per team)
- cardboard
- card stock
- cardboard boxes (1 per team)
- c-clamps (at least two)
- cheesecloth
- clothespins (with springs)
- cloth swatch, i.e. quilting square
- coffee filters
- colored pencils and crayons
- cotton balls
- empty paper towel tubes
- empty toilet paper tubes
- fishing line, ~20 lb. test, 5 m
- film canisters
- glow sticks (2)
- glue sticks
- index cards
- mailing tube, 4" diameter or oatmeal canister
- mini foil pie plates (1 per team)
- modeling clay
- paper bags
- paper clips, assorted
- pennies (at least 10 per team)
- pipe cleaners
- plastic cups
- plastic eggs (1 per team)
- plastic people (i.e. Lego® or Playmobil®)¹
- plastic wrap
- popsicle sticks and/or tongue depressors
- rubber bands, assorted
- scissors
- shoe boxes or similar size boxes
- staplers and staples
- stirrer sticks
- straws
- string
- tape: masking, electrical, transparent and duct tapes
- wheels: i.e. model car wheels (plastic or wood), empty thread spools, or rotelle pasta (4-6 per team)

materials

¹ If toy plastic people are unavailable, encourage students to make their own "astronauts".

Table of Contents

ACTIVITIES

Build a Satellite to Orbit the Moon

Teacher Page	12
Student Pages	14 - 23

Launch Your Satellite

Teacher Page	26
Student Pages	28 - 35

Prepare for a Mission

Teacher Page	38
Student Pages	40 - 49

Design a Lunar Buggy

Teacher Page	52
Student Pages	54 - 61

Design a Landing Pod

Teacher Page	64
Student Pages	66 - 73

Design a Crew Exploration Vehicle

Teacher Page	76
Student Pages	78 - 85

Launch Your CEV

Teacher Page	88
Student Pages	90 - 99

Design a Lunar Thermos

Teacher Page	102
Student Pages	104 - 113

Build a Solar Oven

Teacher Page	116
Student Pages	118 - 125

APPENDIX

National Standards	127
Original Sources	129
Recommended Books & Videos	130
Certificate	135

ENGINEERING DESIGN PROCESS



Build a Satellite to Orbit the Moon

DESIGN challenge

To design and build a satellite that will orbit the moon. It must carry a combination of cameras, gravity probes, and heat sensors to investigate the Moon's surface. The satellite will need to pass a 1-meter Drop Test without any parts falling off of it.

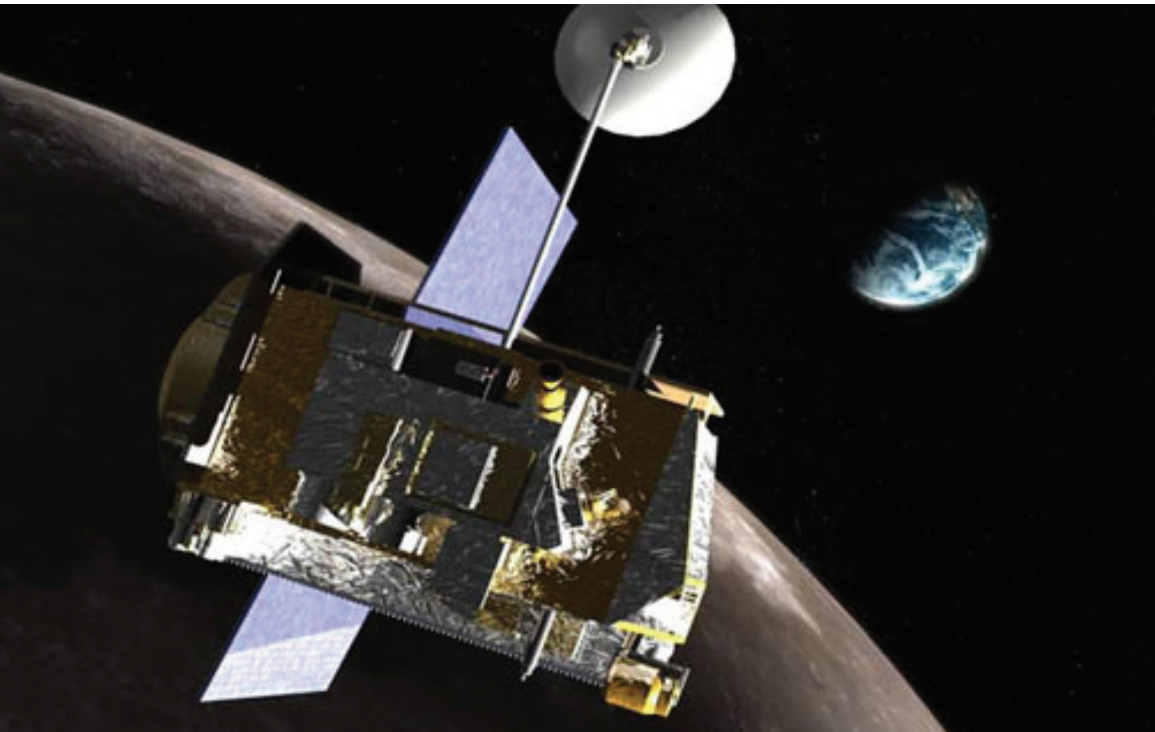

OBJECTIVE

To demonstrate an understanding of the Engineering Design Process while utilizing each stage to successfully complete a team challenge.

PROCESS SKILLS

Measuring, designing, evaluating

MATERIALS

General building supplies

Bag of various sized buttons

STUDENT PAGES

Design Challenge

Ask, Imagine and Plan

Experiment and Record

satellite

MOTIVATE

- Spend a few minutes asking students if they know what engineers do, then show the NASA's BEST Students video titled, "Engineering":
<http://svs.gsfc.nasa.gov/goto?10515>
- Using the *Engineering Design Process (EDP)* graphic on the previous page, discuss the EDP with your students
 - **Ask** a question first about the goal.
 - **Imagine** a possible solution.
 - **Plan out** a design and draw your ideas.
 - **Create** and construct a working model.
 - **Experiment** and test that model.
 - **Improve** and try to revise that model.



SET THE STAGE: **ASKIMAGINE & PLAN**

- Share the *Design Challenge* orally with the students (see next page).
- As a group, have students ask questions about the Challenge and brainstorm ideas. Then have students break into teams to create a drawing of a satellite. All drawings should be approved before building begins.

CREATE

- Distribute materials for students to build their satellites based on their designs and specifications.

EXPERIMENT

- Teams should make observations of the satellite drop and record them in the data tables of their worksheet or report orally to a group leader.



IMPROVE

- Have students inspect their satellite and rework their design if needed.

CHALLENGE CLOSURE

Engage the students in a discussion with the following questions:

- *List two things you learned about what engineers do through building your satellite today.*
- *What was the greatest difficulty you encountered while trying to complete this challenge? How did you solve this problem?*

PREVIEWING NEXT SESSION

Ask teams to bring back their satellite model for use at the next session. You may want to store them in the classroom or have one of the club facilitators be responsible for their safe return.

DESIGN challenge

To design and build a satellite that will orbit the moon. It must carry a combination of cameras, gravity probes, and heat sensors to investigate the Moon's surface. The satellite will need to pass a 1-meter Drop Test without any parts falling off of it.



Build a Satellite
Teacher page

satellite

NASA's Lunar Exploration Missions

NASA's lunar exploration missions will collect scientific data to help scientists and engineers better understand the Moon's features and environment. These missions will ultimately help NASA determine the best locations for future human exploration and lunar bases.

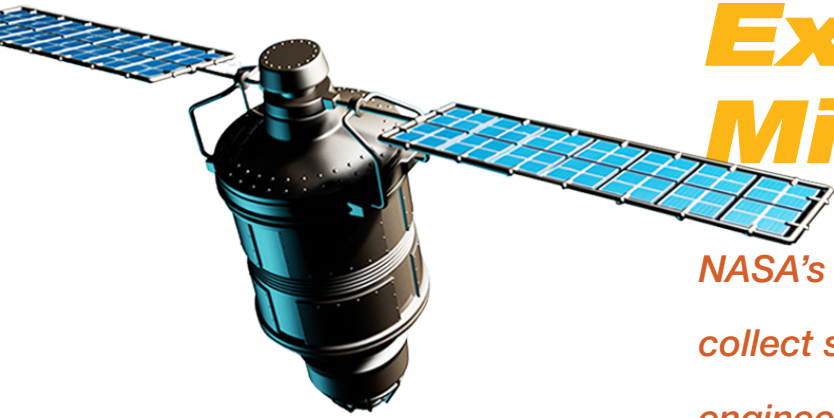



SATELLITE INSTRUMENTS

The information gathered by lunar exploration missions will add to information collected during earlier missions.

Some of these missions gathered data that caused scientists to have more questions — questions they hope to solve with new instruments on new satellites. For example, NASA has recently sent a satellite to look for water ice on the Moon. Thus, that satellite carried instruments (sometimes called “detectors” or “sensors”) to look for the ice. Other instruments will help collect data to make exact maps of the Moon’s surface and make careful measurements of the radiation falling on the lunar surface for the safety of future lunar explorers.

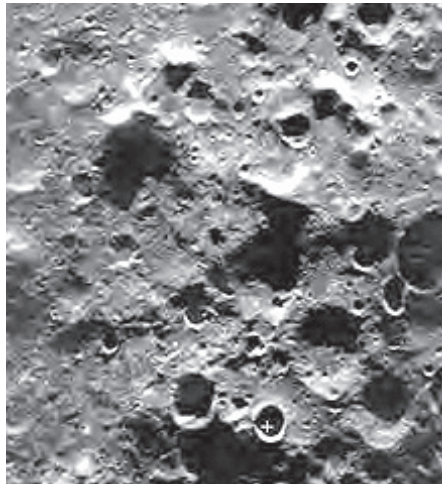

DESIGN challenge

To design and build a satellite that will orbit the moon. It must carry a combination of cameras, gravity probes, and heat sensors to investigate the Moon’s surface. The satellite will need to pass a 1-meter Drop Test without any parts falling off of it.

TEAMWORK IS IMPORTANT

The different instruments are designed, tested, and assembled by different teams of engineers and scientists. The separate teams must work together to ensure instruments are the right mass, fit correctly, and make proper measurements. Working together is an important skill for *everyone* to practice.



Build a Satellite
Student page

Build a Satellite

THE CHALLENGE:

Your mission is to build a model of a lunar exploration satellite with the general building supplies available. Use different shape and sizes of buttons or beads to represent the various instruments. Your team must:

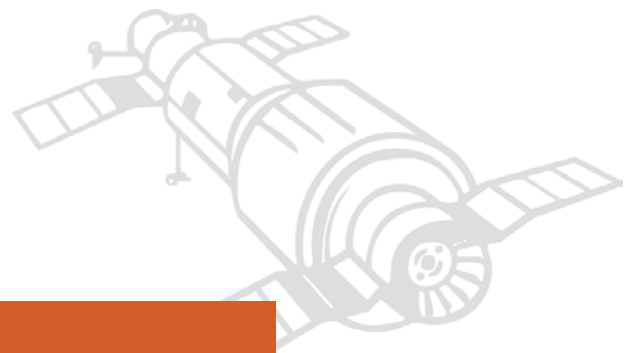

DESIGN challenge

To design and build a satellite that will orbit the moon. It must carry a combination of cameras, gravity probes, and heat sensors to investigate the Moon's surface. The satellite will need to pass a 1-meter Drop Test without any parts falling off of it.

- 1. Use a combination of instruments that cannot go above four (4) solar cells to power your satellite.**
- 2. The satellite must withstand a drop from above your head without any pieces falling off.**

Design a Satellite
Student page

satellite

ASK IMAGINE & PLAN

For this activity, you must design your own satellite. These are the instruments you may choose to put on your satellite:



Camera
Takes Pictures



Gravity Probe
Measures Gravity



Heat Sensor
Measures Temperature

Each of these instruments requires a certain number of solar cells to operate on your satellite. A solar cell  collects energy from the sun to power the instruments.

needs



needs



needs



If you were to build a satellite with one (1) camera and one (1) heat sensor, how many solar cells would you need? Complete the number sentence below:

$$\underline{\hspace{2cm}} + \underline{\hspace{2cm}} = \underline{\hspace{2cm}}$$

(camera) (heat sensor) (total solar cells)

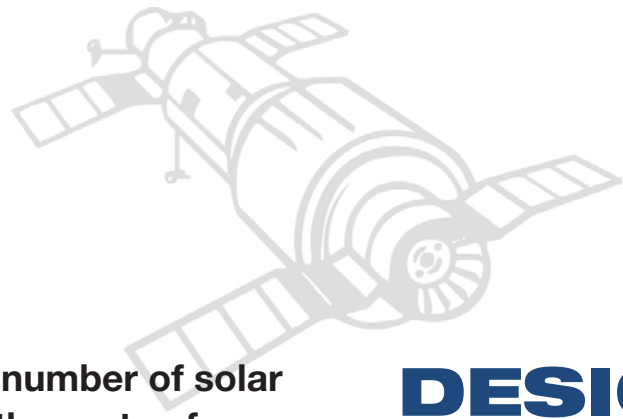

Draw your satellite. Include the correct number of solar cells it will need. Make sure to label all the parts of your satellite.

DESIGN challenge

To design and build a satellite that will orbit the moon. It must carry a combination of cameras, gravity probes, and heat sensors to investigate the Moon's surface. The satellite will need to pass a 1-meter Drop Test without any parts falling off of it.

Build a Satellite
Student page

satellite

Approved by: _____



Experiment & Record

Drop your satellite from above your head. Describe to your teacher what happened during your satellite's drop or make a drawing.

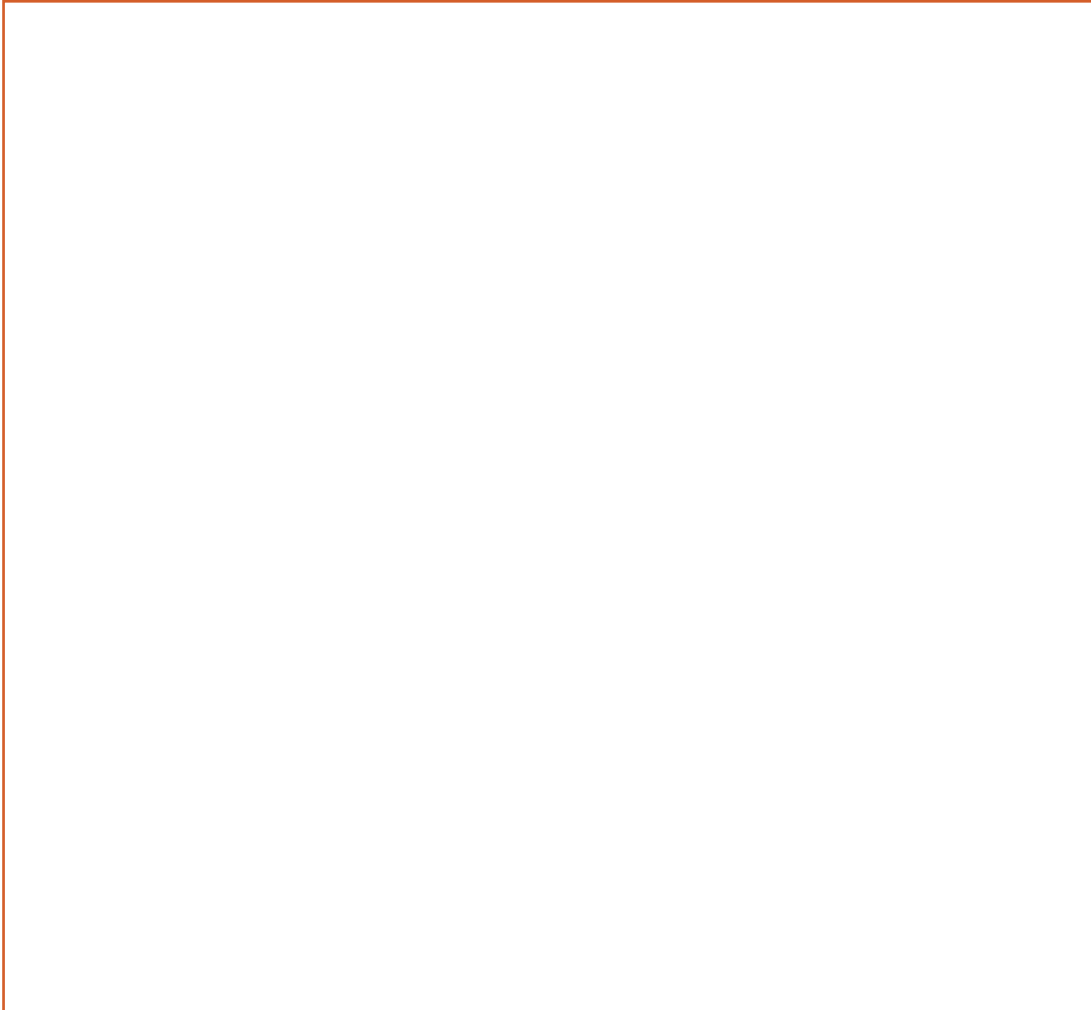

Did any instruments fall off the satellite? Yes No

Was the satellite damaged during the fall? Yes No

If you answered yes to either question above, discuss with your team how you should design your satellite differently. If there is time, make changes in your drawing and add those changes to your satellite.

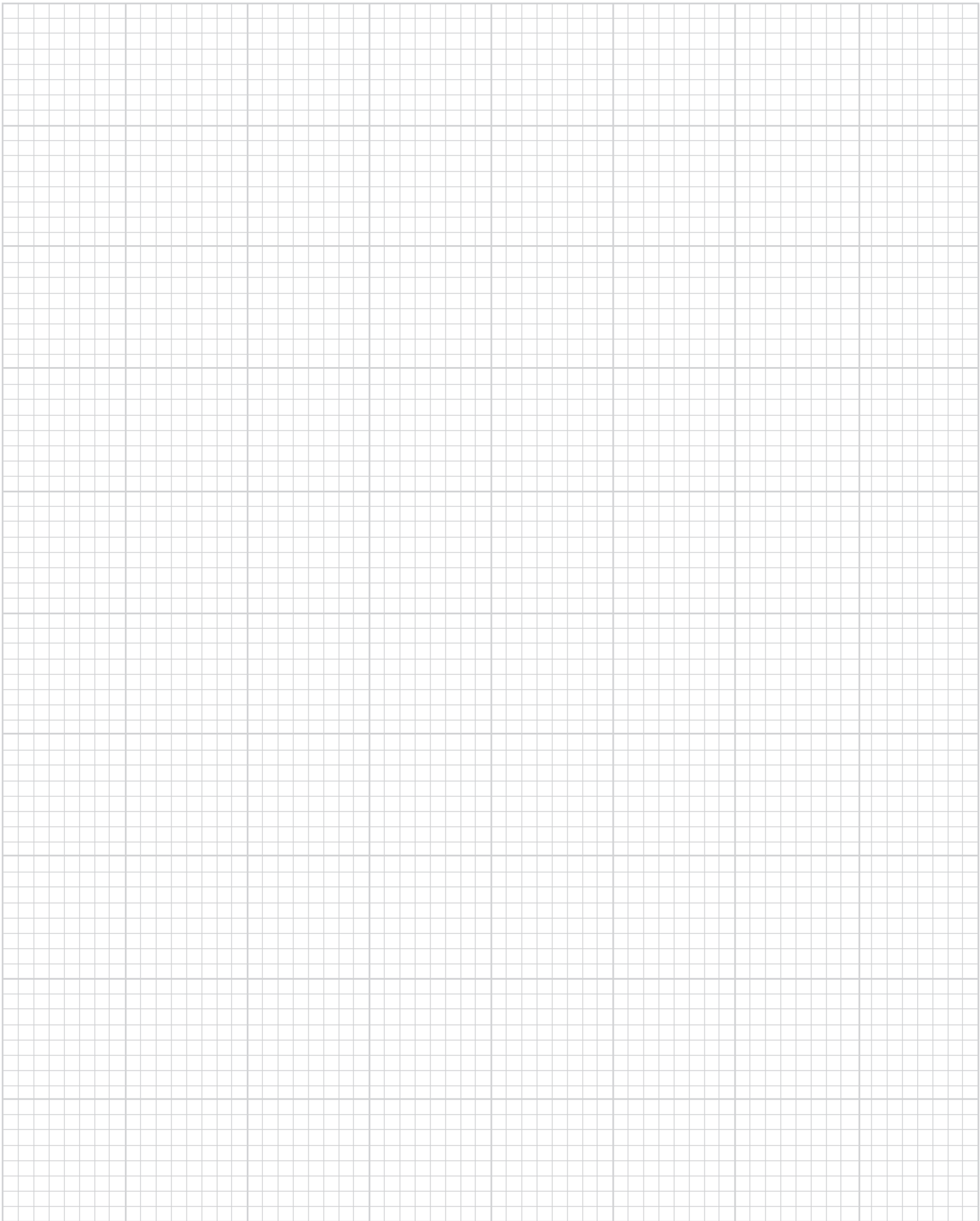

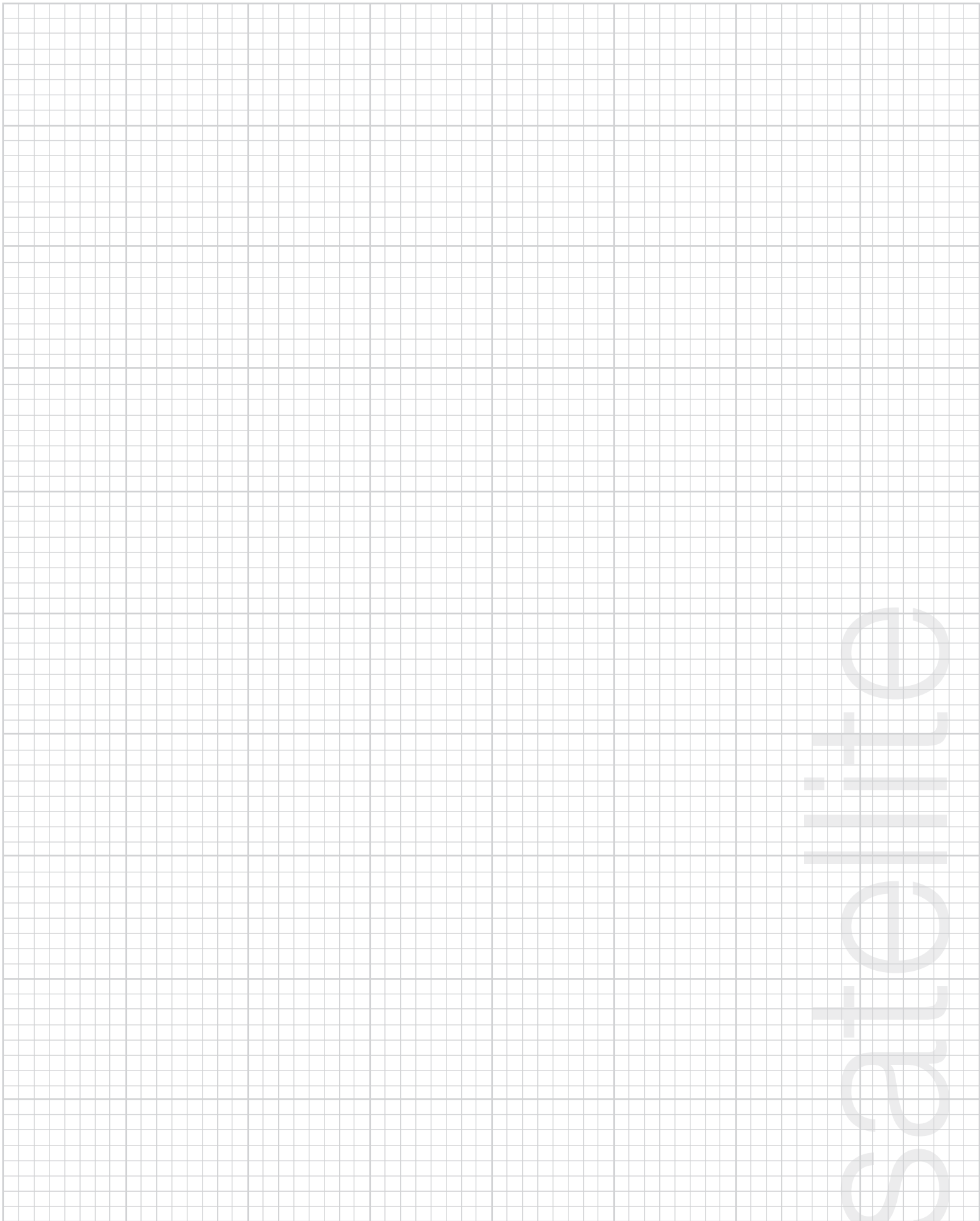

DESIGN challenge

To design a balloon rocket to launch the satellite that was built in the last activity. The goal is to get the satellite to go as far as possible.

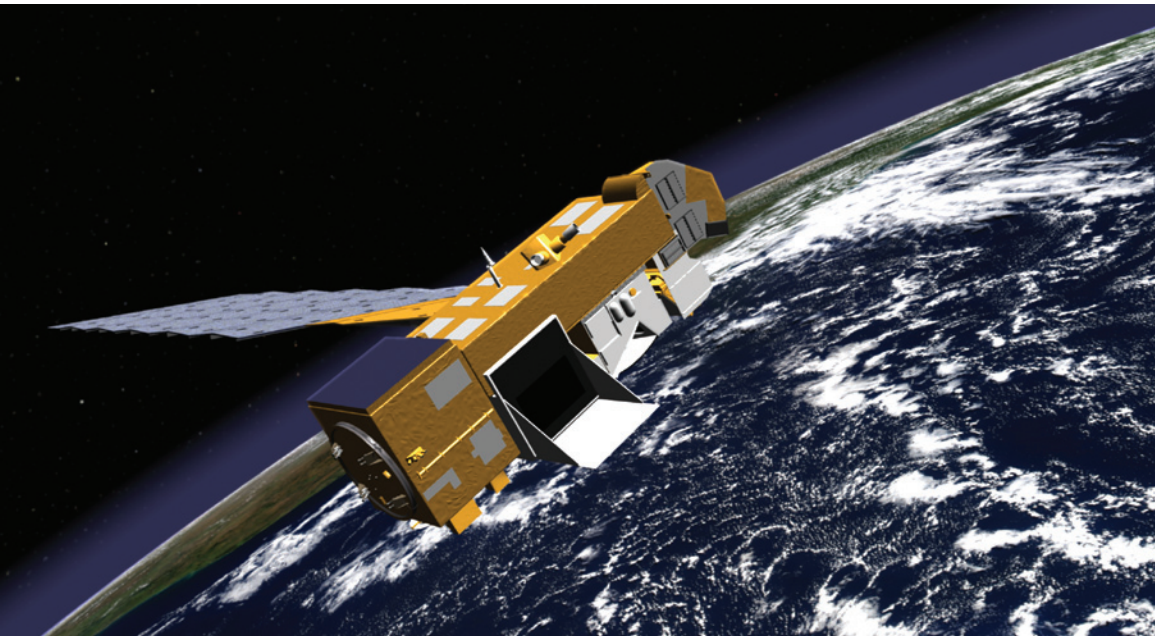

OBJECTIVE

To demonstrate an understanding of the Engineering Design Process while utilizing each stage to successfully complete a team challenge.

PROCESS SKILLS

Observing, communicating, measuring, collecting data, inferring, predicting, making models

MATERIALS

Satellite model from previous activity

General building supplies

Rulers or meter sticks

Binder clips or clothes pins

Balloons (several per group)

Straws

5-meter fishing line set-up strung between two tables

STUDENT PAGES

Design Challenge

Ask, Imagine and Plan

Experiment and Record

PRE-ACTIVITY SET-UP

The fishing line apparatus should be at least 5 meters in length. Clamp or tie one end at table or chair height and stretch the line across the space to another table/chair at the same level. Holding the free end of the line taut for each trial enables easy restringing of the successive balloon rockets. The line must be very taut for best results. Shoot the rockets toward the tied end. Two fishing line set-ups should be sufficient for a group of 20 students. *Note: If the opening in the balloons tends to stick, try putting a little hand lotion inside the opening.*

MOTIVATE

- Show the video of a recent rocket launch, titled, “Liftoff...To the Moon!”
<http://lunar.gsfc.nasa.gov/launch.html>

SET THE STAGE:

ASKIMAGINE & PLAN

- Share the *Design Challenge* with the students and ask students to retrieve their satellites from last session.
- Demonstrate how a balloon rocket works by sending a balloon connected to a straw up the fishing line. Do not model how best to attach the satellite or how best to power the rocket, other than releasing the air by using your fingers.
- Ask the students, “How can we use this set up to launch your satellite?” Remind students that one end of the set up is the launch pad and the other end is the Moon.
- Remind students to ask questions and brainstorm, then break into teams to create a drawing. All drawings should be approved before building.

CREATE

- Challenge the teams to build their rockets based on their plans and remind them to keep within specifications. They will also need to attach their satellites from the previous session.

EXPERIMENT

- Send each team to their assigned launch sites to test their rockets, completing the data tables as they conduct each trial launch.

IMPROVE

- After their first set of trials, allow teams to make adjustments to their rockets.
- Teams re-launch satellites and record launch distance.
- Teams should then discuss how far their rocket traveled and which combination of variables gave the best results.

CHALLENGE CLOSURE

Engage the students in the following questions:

- *What was the greatest challenge for your team today?*
- *Which straw length did you choose and why did you choose it?*
- *If you had more time, what other rocket element would you change (ex: balloon shape or size)?*

PREVIEWING NEXT SESSION

Ask teams to think about how humans navigate robotic rovers on a distant planet or moon. How are they programmed? How do the rovers receive messages from a team on Earth?

DESIGN challenge

To design a balloon rocket to launch the satellite that was built in the last activity. The goal is to get the satellite to go as far as possible.

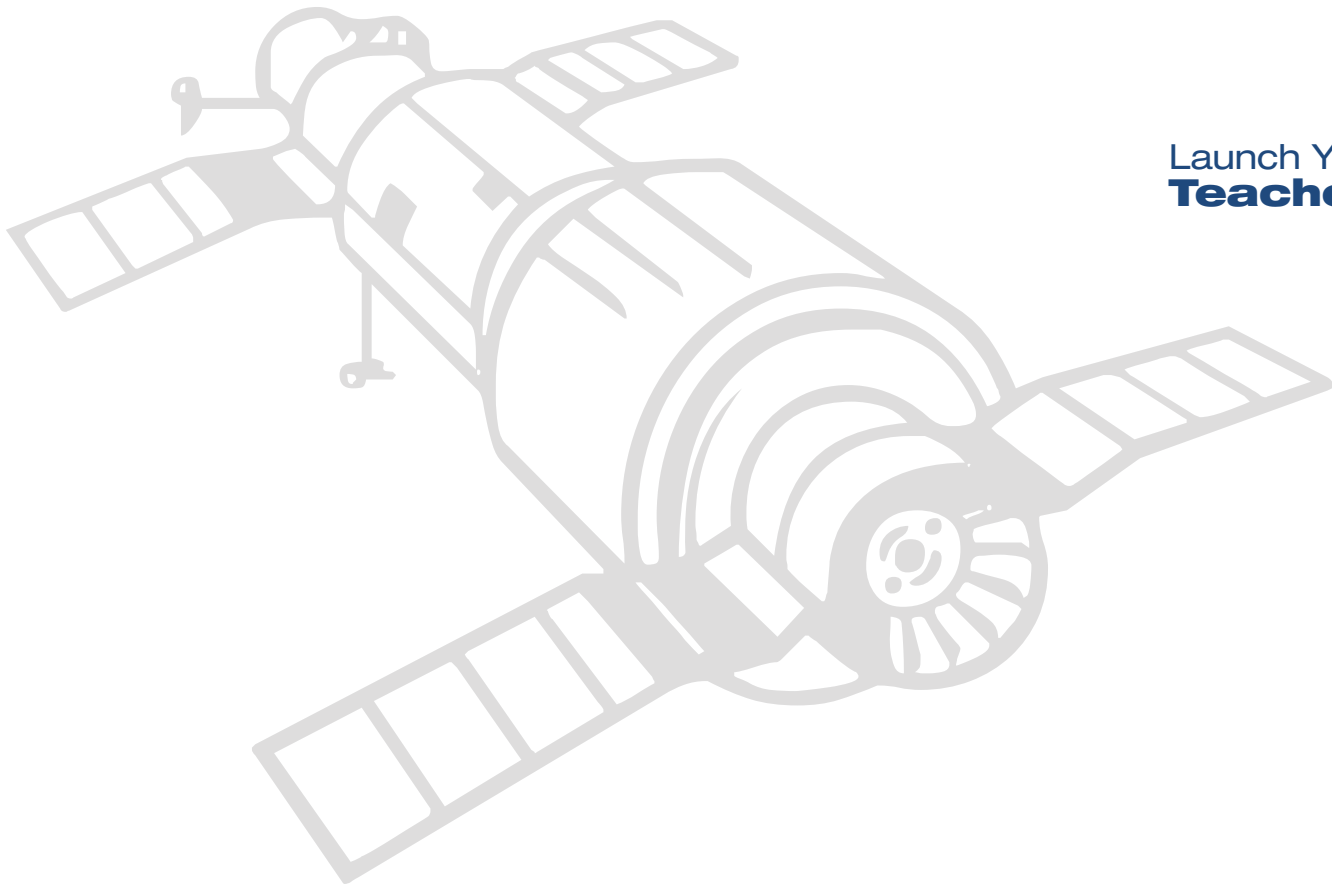

Launch Your Satellite
Teacher page



3, 2, 1 . . . We have lift-off!

NASA launches several rockets each year. There are actually several launch facilities around the United States. You probably know of the launch pad at Kennedy Space Center in Florida, but did you know there is a launch facility at Vandenberg Air Force Base in California, one at Wallops Flight Facility in Virginia, and another at White Sands Missile Range in New Mexico? A rocket is just the launch vehicle that carries a payload into space. A payload is the load, or package or set of instruments, that needs to be delivered to a destination. When you watched the video for this session, you saw an Atlas V rocket carry a payload, the LRO and LCROSS satellites, to a destination: an orbit around the Moon.



THE CHALLENGE:

Your mission is to design and build a **launch vehicle** to send a payload to the Moon. The **launch vehicle** is a balloon rocket assembly. Your **payload** is the satellite you built at the last session. Your team must also determine how to attach your satellite to the balloon assembly and then launch it down a fishing wire.

DESIGN challenge

To design a balloon rocket to launch the satellite that was built in the last activity. The goal is to get the satellite to go as far as possible.

Launch Your Satellite
Student page

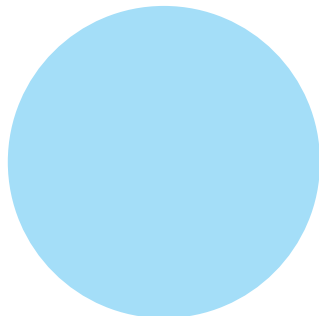
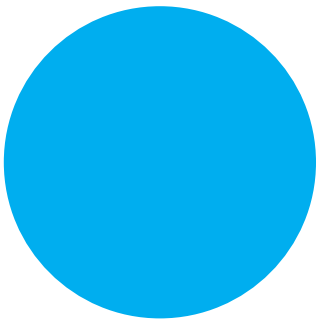

launch your satellite

ASK IMAGINE &**PLAN**

Draw and label your balloon rocket design that includes the satellite design.

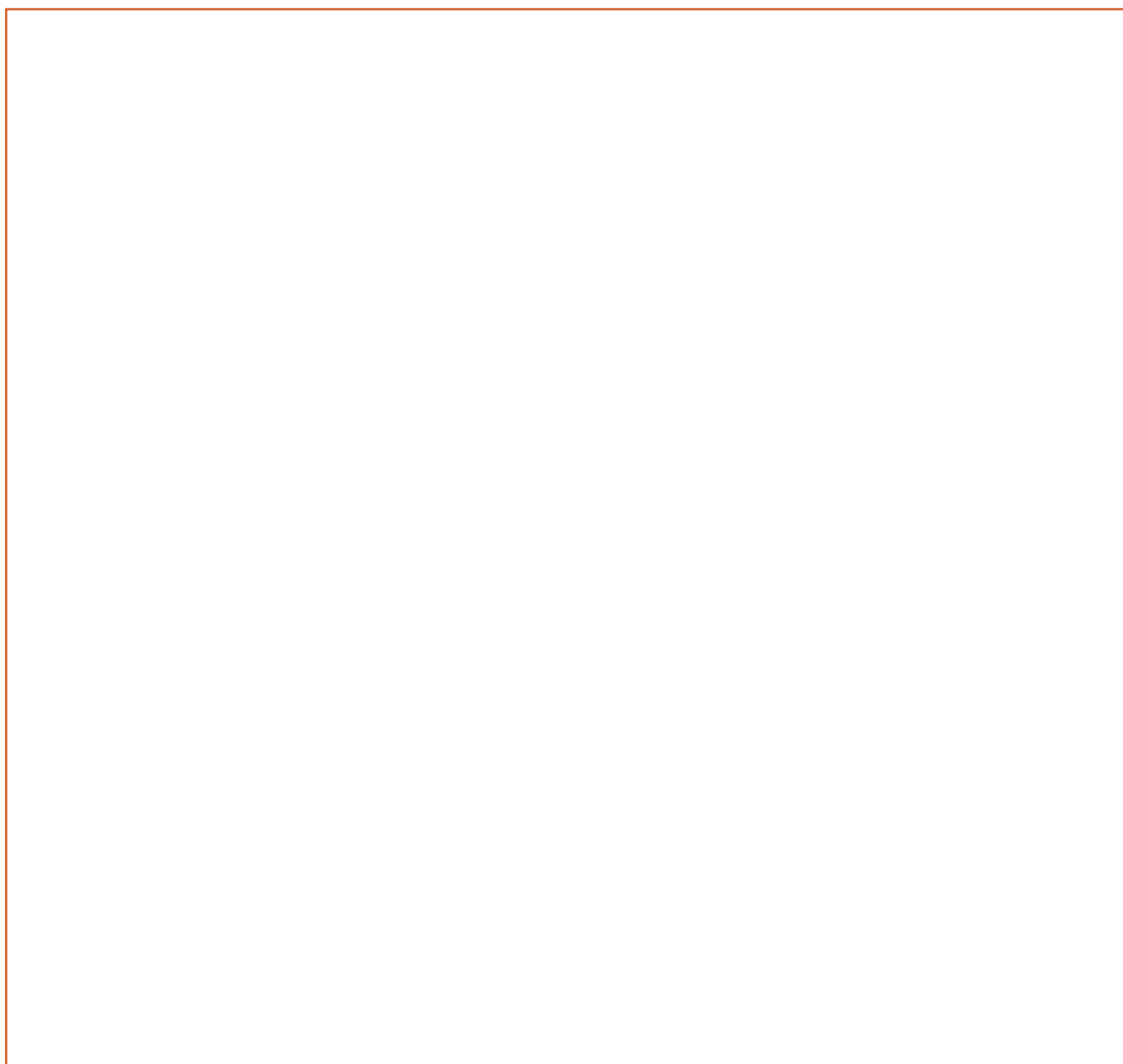



DESIGN challenge

To design a balloon rocket to launch the satellite that was built in the last activity. The goal is to get the satellite to go as far as possible.

Launch Your Satellite
Student page

Approved by: _____

Experiment & Record



Your challenge is to launch your balloon rocket the farthest distance! Build your rocket with **ONE** balloon attached to a drinking straw. Test three different lengths of straw.



Balloon Rocket Data Table 1

	Trial 1	Trial 2	Trial 3
Straw Length	Short _____ cm	Medium _____ cm	Long _____ cm
Distance traveled (cm)			

DESIGN challenge

To design a balloon rocket to launch the satellite that was built in the last activity. The goal is to get the satellite to go as far as possible.

Now that you tried three different lengths of straw, build your final rocket – the one your team expects to go the farthest.

Balloon Rocket Data Table 2

Rocket Elements	New Trial after re-design
Balloon length (cm)	
Straw Length (cm)	
Distance traveled (cm)	

Launch Your Satellite
Student page

launch your satellite

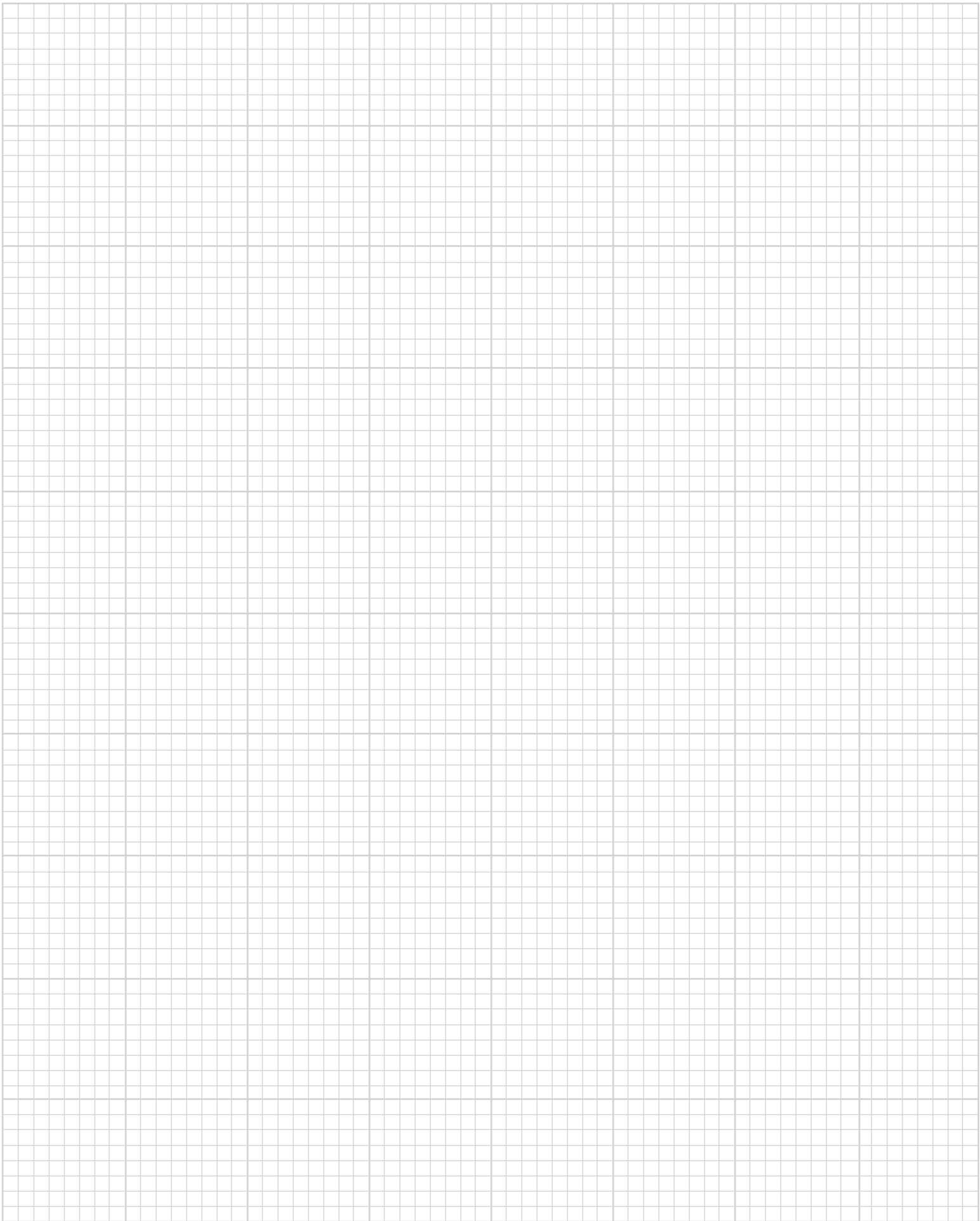

launch your satellite

DESIGN challenge

To execute a mini-simulation of a robotic mission with a goal to command a human-robot through a set course to retrieve a piece of lunar ice.



OBJECTIVE

To demonstrate an understanding of the Engineering Design Process while utilizing each stage to successfully complete a team challenge.

PROCESS SKILLS

Mapping, communication, measuring, logical thinking

MATERIALS

Rulers or meter sticks

Blindfolds

“Prize” as lunar ice sample

STUDENT PAGES

Design Challenge

Ask, Imagine and Plan

Experiment and Record

PRE-ACTIVITY SET-UP

Set up a small obstacle course with a few chairs, waste paper baskets, and/or a table. The course does not have to be too complicated, but set it up so students will have to take at least one right turn and one left turn. Also, give the students enough obstacles so there is more than one path to take to the “finish”. An area of about 25 square meters is recommended.

Please note: This activity will require two 60-90 minute sessions to complete. Make sure to set up the obstacle course exactly the same for both sessions. Also, the student acting as the robot will need to be blindfolded for this activity. Please take time to discuss with your students about assisting or “spotting” their blindfolded peer.

prepare for a mission

MOTIVATE

- Explain to the students that many of NASA's missions are conducted by robots. Ask students to draw their ideas of what a robot looks like and compare the differences.

SET THE STAGE: **ASKIMAGINE &PLAN**

- Share the *Design Challenge* with the students. Remind students to take the time to ask questions about the challenge and imagine a solution.
- Students must draw their chosen course on the map and include at least one right turn and one left turn. Map should be approved before proceeding to next step.
- Let students practice commands to use with their robot. These commands are simple words, plus a number for steps taken.



CREATE

- Students will define the robot's route through the lunar landing site and count the number of steps needed for each command. They will then create a command sequence to use for their robot that matches the route they have planned on their maps.

EXPERIMENT

- Student teams must navigate the lunar landing site, using the command sequence each team designed. Have students cut out the commands into strips of paper and designate one student per team to deliver each command. Designate another team member to run a stopwatch. Position the robots at the start and have the teams sitting or standing aside from the obstacle course. The students designated to deliver commands are to deliver one command at a time – one student walks to the robot, delivers one

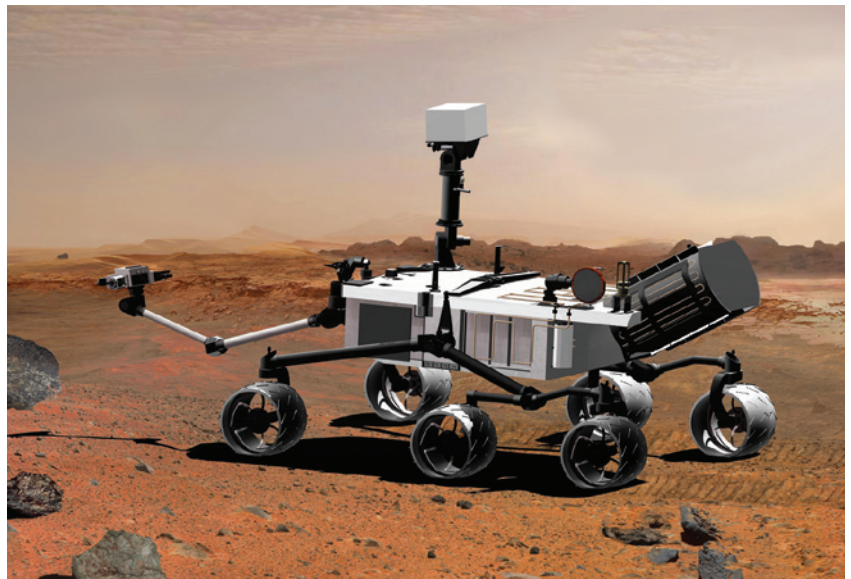

command, then returns to the team. Robot performs the command. The next student then walks to the robot and delivers the command, returns, etc. Only one command is delivered at a time to represent one line of code sent over a radio signal. The rest of the team cannot deliver another command until they have determined if the robot has successfully executed that command. Have each team record how much time it takes to successfully complete the task when the robot picks up the “lunar ice”.

CHALLENGE CLOSURE

Engage students in the following questions:

- Did each team pick the same route or were there several routes to get to the lunar ice? Which route worked the best?
- Why did you have to deliver each command separately? How does it relate to communicating with robots in space?

PREVIEWING NEXT SESSION

Ask teams to think about how a spacecraft might land on the Moon safely. Ask them to think about why it does not make sense to use a parachute on the Moon. Answer: There is no air on the Moon to fill up the parachute.

DESIGN challenge

To execute a mini-simulation of a robotic mission with a goal to command a human-robot through a set course to retrieve a piece of lunar ice.



Prepare for a Mission
Teacher page

The Discovery Mission

Every NASA mission has several parts leading to its success. When leading a remote mission on another planet or moon, NASA scientists and engineers must plan every step of the mission carefully. When



using robots or rovers, each mission team calibrates and programs these machines to accomplish the mission objective, such as to travel to certain locations on that planet or moon. In addition, NASA must use radio signals to send their commands. So a mission on a distant planet could take minutes to hours to days to communicate to that robot.





DESIGN challenge

The Challenge:

Your team has been chosen to operate a robotic Discovery Mission on the surface of the Moon. You will be given a specific starting location, and your robot must move through a lunar landscape to the location of the “lunar ice” without bumping into any “lunar boulders” or other obstacles. To successfully complete the Discovery Mission, your robot must pick up a piece of “lunar ice.”

To execute a mini-simulation of a robotic mission with a goal to command a human-robot through a set course to retrieve a piece of lunar ice.

Before your robot begins to move on the lunar surface, you will have to complete the following activities:

- 1. Designate your robot** - One student in each team must volunteer to be the robot. The robot will be the person who actually walks through the course, blindfolded, following the instructions of her/his team. The team should give their robot a name.
- 2. Map the robot's route** – Using the map in your worksheets, mark out a route for the robot.
- 3. Learn to communicate with your robot** – Each team must develop commands for your robot. You will practice these commands until you and the robot are comfortable with them. These will be the commands that you will give the robot to travel through the path you have drawn on the map.
- 4. Program the robot** – Use the commands that you practiced to tell the robot how to navigate the path you have drawn on the map.

Prepare for a Mission
Student page

ASK IMAGINE & PLAN

STEP 1 - Designate your robot.

One person from your team must volunteer to be the robot.

STEP 2 - Mapping

On the next page is a map for the Discovery Mission. Using a pencil, draw arrows on your map and create a route your robot will take to get to the lunar ice sample. You must include at least one right turn and one left turn.



Create the route for your robot within the diagram below.

Finish

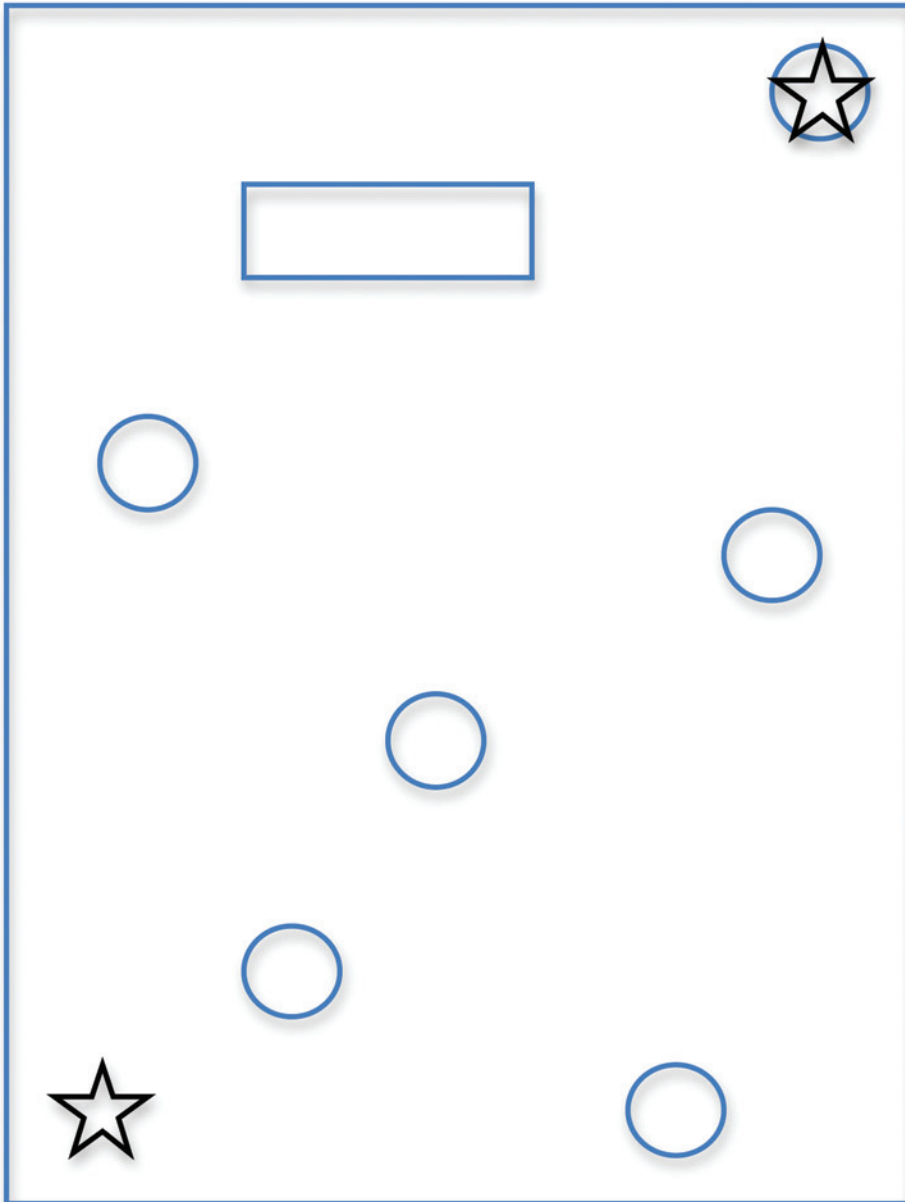

Start

DESIGN challenge

To execute a mini-simulation of a robotic mission with a goal to command a human-robot through a set course to retrieve a piece of lunar ice.

Prepare for a Mission
Student page

Approved by: _____

STEP 3 - Communicate with your robot



When you program a robot, you must use simple words and be specific in your directions. If you want your robot to go forward, how many steps should the robot go?

Practice the words below with your robot and see if your robot follows the commands correctly.

Sample Command for Robot	Action by robot
MOVE FORWARD TWO STEPS	Walk forward two steps.
MOVE BACKWARD ONE STEP	Walk backward one step.
TURN RIGHT	Turn to the right.
TURN LEFT	Turn to the left.
PICK UP LUNAR ICE	Pick up the lunar ice sample.

Were any of these commands difficult for your robot to execute? If so, which ones?

Suggest a better command to use with your robot.



STEP 4 - Program your robot

Review the map with the route your team has created for your robot. Now your team needs to create commands for your robot to match your route. Write down one command that matches each arrow on your map.

DESIGN challenge

To execute a mini-simulation of a robotic mission with a goal to command a human-robot through a set course to retrieve a piece of lunar ice.

Command Sequence

1.
2.
3.
4.
5.
6.
7.
8.
9.
10.

Prepare for a Mission
Student page

prepare for a mission

Experiment & Record

Execute the Discovery Mission!

It is time to let your Robot explore the Moon!

You planned your route and practiced your

commands. Now complete the mission. Take

the complete command sequence your team

designed and cut each command out of the

page as separate pieces of paper. Designate

two team members to deliver the commands

to the Robot and divide those sheets of paper

amongst them. Another team member or your

teacher can use a stopwatch to time how long it

takes for the Robot to reach the Lunar

ice sample. Record each team's time in

the next page to compare how long the

mission took for each team!



Discovery Mission Data Table

Team Name	Time (seconds)
1.	
2.	
3.	
4.	
5.	

Prepare for a Mission
Student page

prepare for a mission

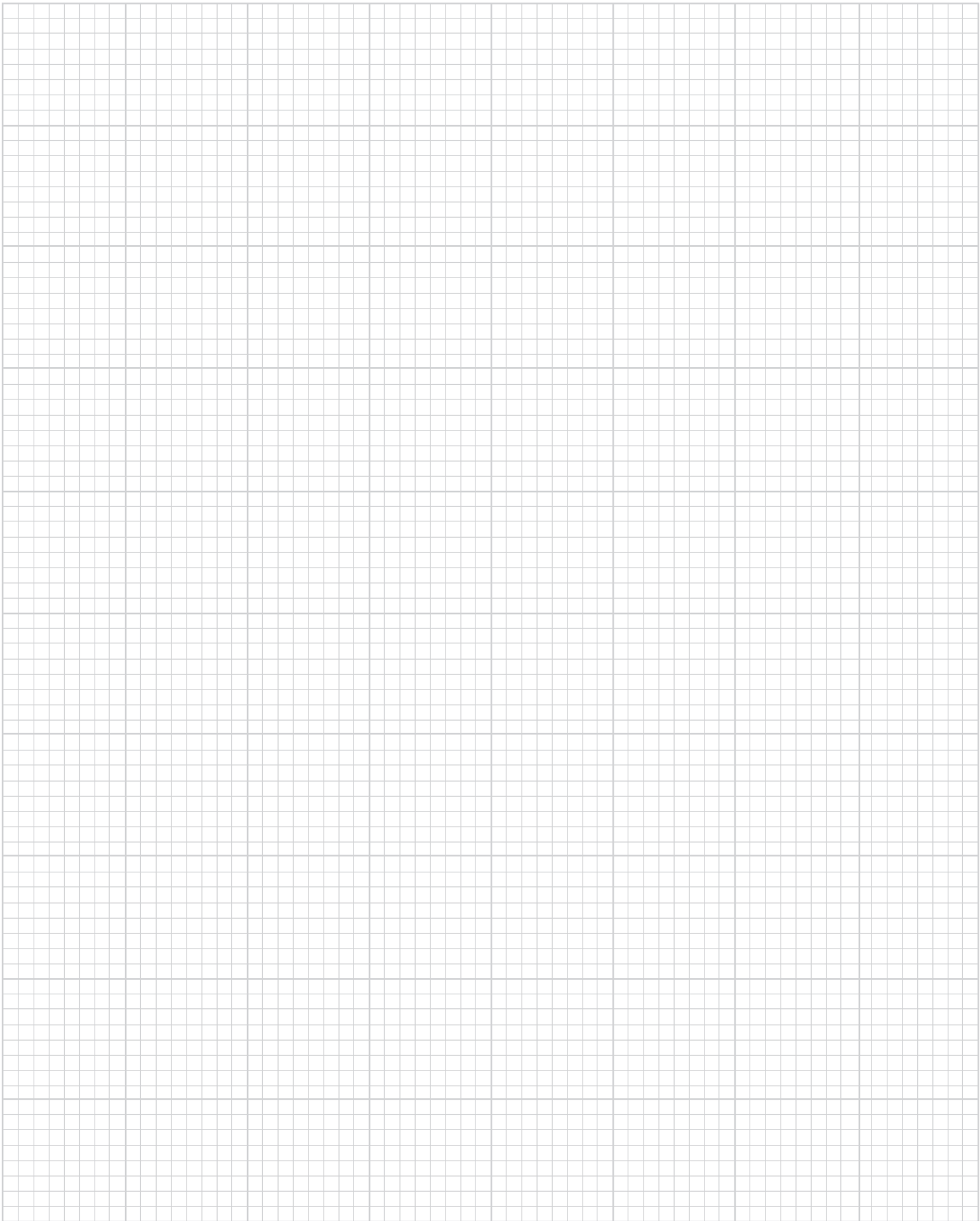

Prepare for a mission

Design a Lunar Buggy

DESIGN challenge

To design and build a model of a Lunar Buggy that will carry equipment and astronauts on the surface of the Moon and to determine the best slope of ramp for the rover to travel the farthest distance.



OBJECTIVE

To demonstrate an understanding of the Engineering Design Process while utilizing each stage to successfully complete a team challenge.

PROCESS SKILLS

Measuring, designing, evaluating

MATERIALS

General building supplies

Meter stick

Digital scale

Small plastic people (i.e. Lego)

Plastic eggs

Pennies or washers (“cargo”)

Wheels

Something to use as a ramp (preferably a flat surface that would enable the buggy to roll for 25 cm or more)

STUDENT PAGES

Design Challenge

Ask, Imagine and Plan

Experiment and Record

PRE ACTIVITY SET-UP

Set up a small ramp for the students to use with their Lunar Buggies. It can be made with something as simple as a large book set up on a table or a piece of wood propped up on chair.

MOTIVATE

- Show the video about the Apollo 15 Lunar Rover on the Moon:

<http://starchild.gsfc.nasa.gov/Videos/StarChild/space/rover2.avi>

- Ask students to pay attention to the comments made about the difficulties in driving on the lunar soil.

SET THE STAGE: **ASKIMAGINE & PLAN**

- Share the *Design Challenge* with the students.
- Remind students to ask questions and brainstorm ideas, then break into teams to create a drawing of a Lunar Buggy. All drawings should be approved before building.

CREATE

- Challenge the teams to build their Lunar Buggy based on their designs. Remind them to keep within specifications.

EXPERIMENT

- Students will let their rover roll down the ramp and record their observations.
- Students will test how much cargo weight their rovers can support by adding pennies (or washers, rocks, etc) to the plastic egg.

IMPROVE

- Students should improve their Lunar Buggy models based on results of the experiment phase.



CHALLENGE CLOSURE

Engage the students in the following questions:

- *Did the cargo mass make a difference on your Buggy's performance?*
- *How did the slope of the ramp affect your Buggy's performance?*

PREVIEWING NEXT SESSION

Ask teams to bring back their Lunar Buggy models for use in next session's challenge. You may want to store them in the classroom or have the facilitator be responsible for their safe return next session.

Ask teams to think about potential landing pods for use during the next session. Tell students they will be building the landing pod out of the materials that have been available to them. The pod will be dropped from as high as possible (out a second story window, off a tall ladder, or from the top of a staircase).

DESIGN challenge

To design and build a model of a Lunar Buggy that will carry equipment and astronauts on the surface of the Moon and to determine the best slope of ramp for the rover to travel the farthest distance.

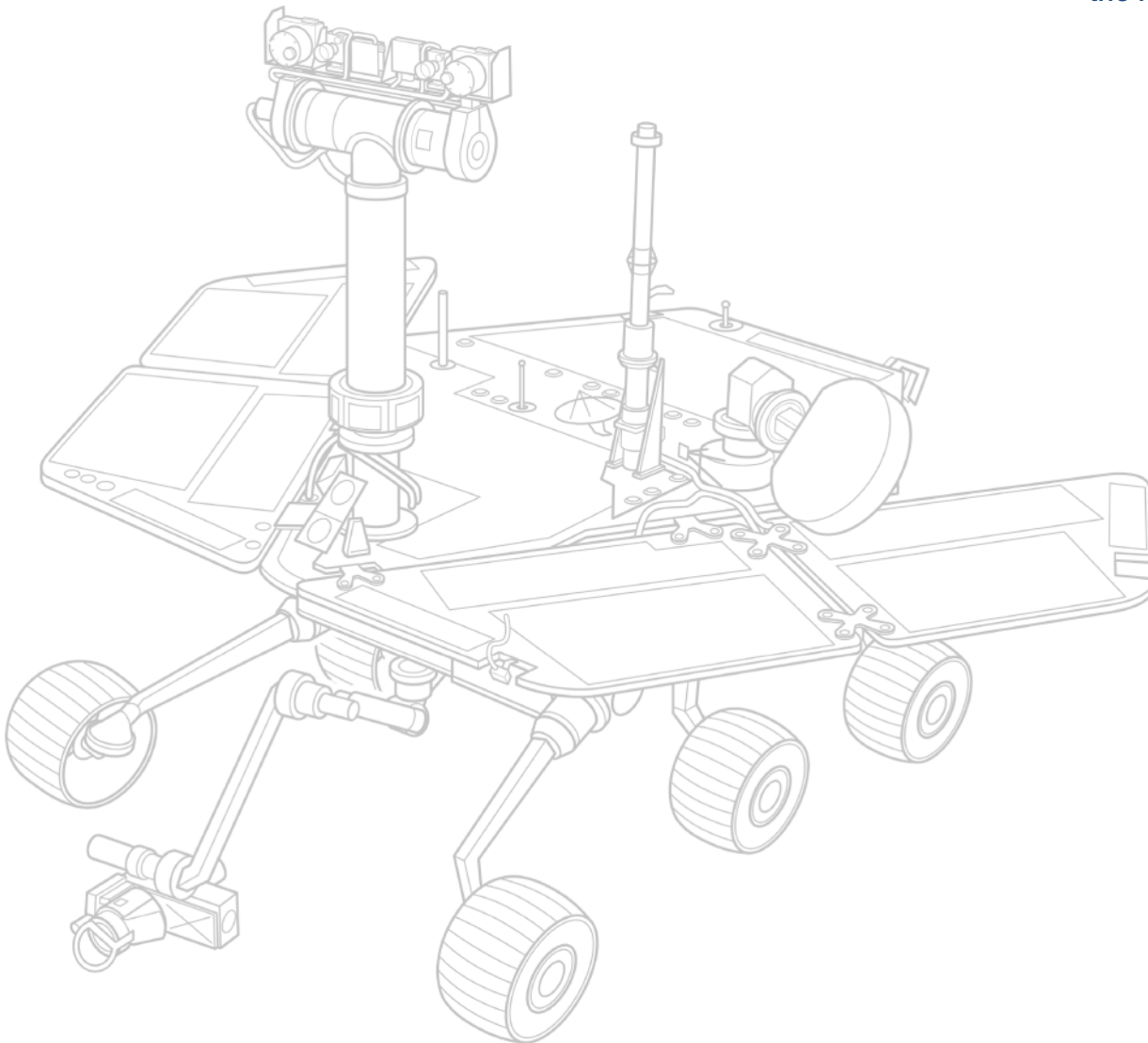

Design a
Lunar Buggy
Teacher page

Let's Go for a Ride!

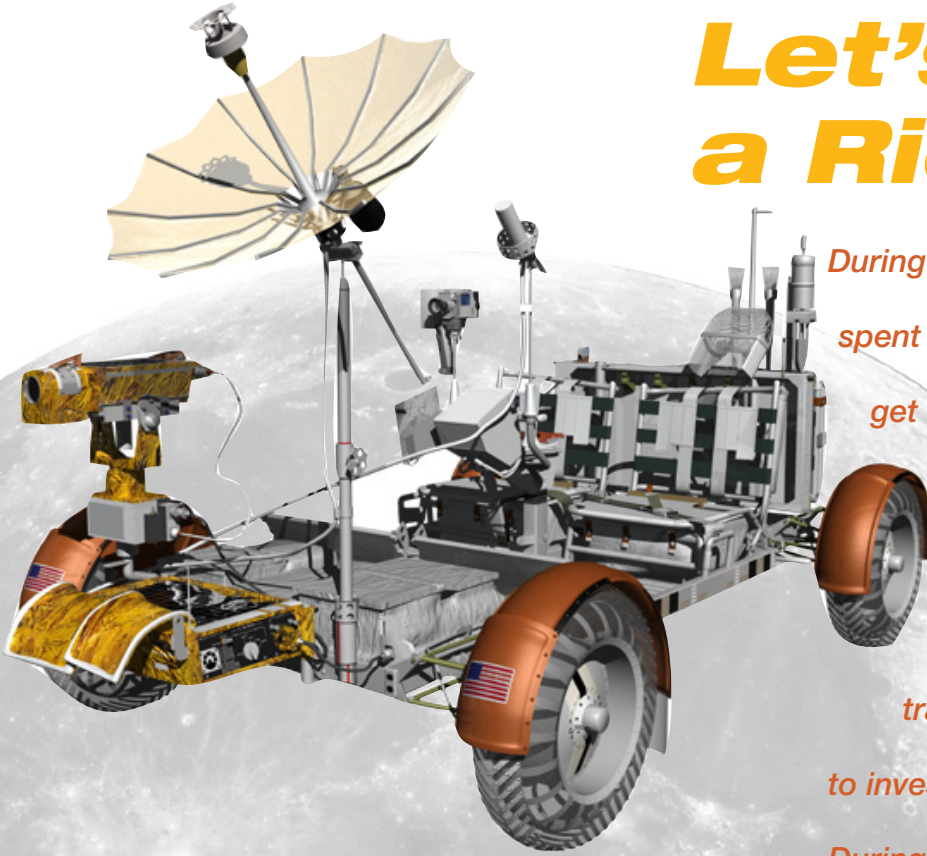

During the first set of activities, we have spent some time thinking about how to get to the Moon. Now you need to think about landing on the Moon, and how to deliver cargo to the Moon. Astronauts will need a mode of transportation in order to get around to investigate different areas of the Moon. During the Apollo missions, astronauts drove a Lunar Buggy several kilometers away from their spacecraft. Today you get to be the engineers designing a new Lunar Buggy that can perform functions the Apollo Lunar Buggy could not. Your challenge is to build a model of a Lunar Buggy that astronauts will eventually use to carry astronauts and cargo on the Moon.

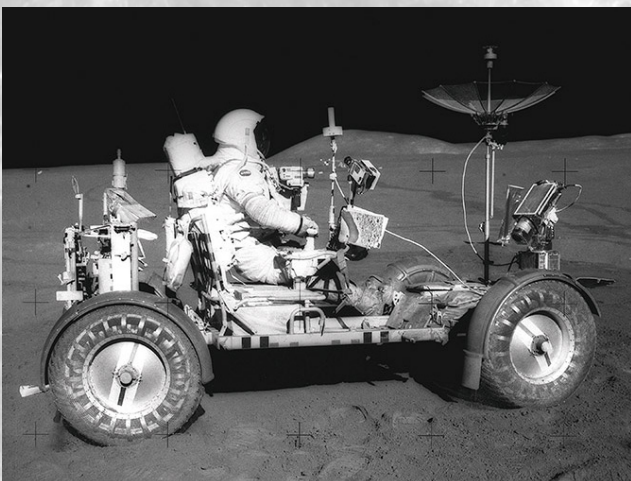

THE CHALLENGE:

Each team must design and build a Lunar Buggy with the following constraints:

- 1. The Lunar Buggy must carry one plastic egg snugly. The egg may not be taped or glued into place. (The egg represents the cargo hold.)**
- 2. The Lunar Buggy must be able to roll with cargo in the cargo hold (pennies, buttons, washers, rocks, etc).**
- 3. The Lunar Buggy must have room for two “astronauts”. You may use plastic people provided to you or make your own. Your astronauts may not be taped or glued into place.**
- 4. The Lunar Buggy must roll on its own down a ramp for a distance of approximately 50 cm in a straight line beyond the ramp.**
- 5. The Lunar Buggy must be able to hold cargo and astronauts in place and in tact as the Buggy rolls down the ramp.**



DESIGN challenge

To design and build a model of a Lunar Buggy that will carry equipment and astronauts on the surface of the Moon and to determine the best slope of ramp for the rover to travel the farthest distance.

Design a
Lunar Buggy
Student page

ASK IMAGINE &**PLAN**

Draw and label your Lunar Buggy:



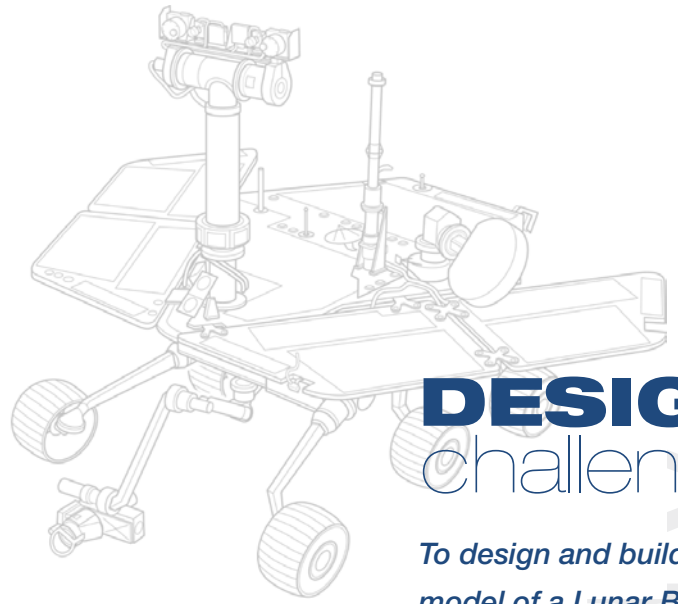

DESIGN challenge

To design and build a model of a Lunar Buggy that will carry equipment and astronauts on the surface of the Moon and to determine the best slope of ramp for the rover to travel the farthest distance.



Design a
Lunar Buggy
Student page

Approved by: _____

Experiment & Record



Measure the mass of your cargo on a digital scale or balance. Record the data in the table under Trial 1. Test your buggy on the ramp. Measure the distance it travels down the ramp. Record the distance in the table under Trial 1.

Lunar Buggy Data Table

	Trial 1	Trial 2
Cargo Mass (grams)		
Distance travelled down ramp (cm):		

Did your design work well? If not, redesign your Buggy and try a different amount of cargo, then experiment again. Record your data in the table for Trial 2.

Describe or draw any changes you made to your Buggy:

DESIGN challenge

To design and build a model of a Lunar Buggy that will carry equipment and astronauts on the surface of the Moon and to determine the best slope of ramp for the rover to travel the farthest distance.

Design a
Lunar Buggy
Student page

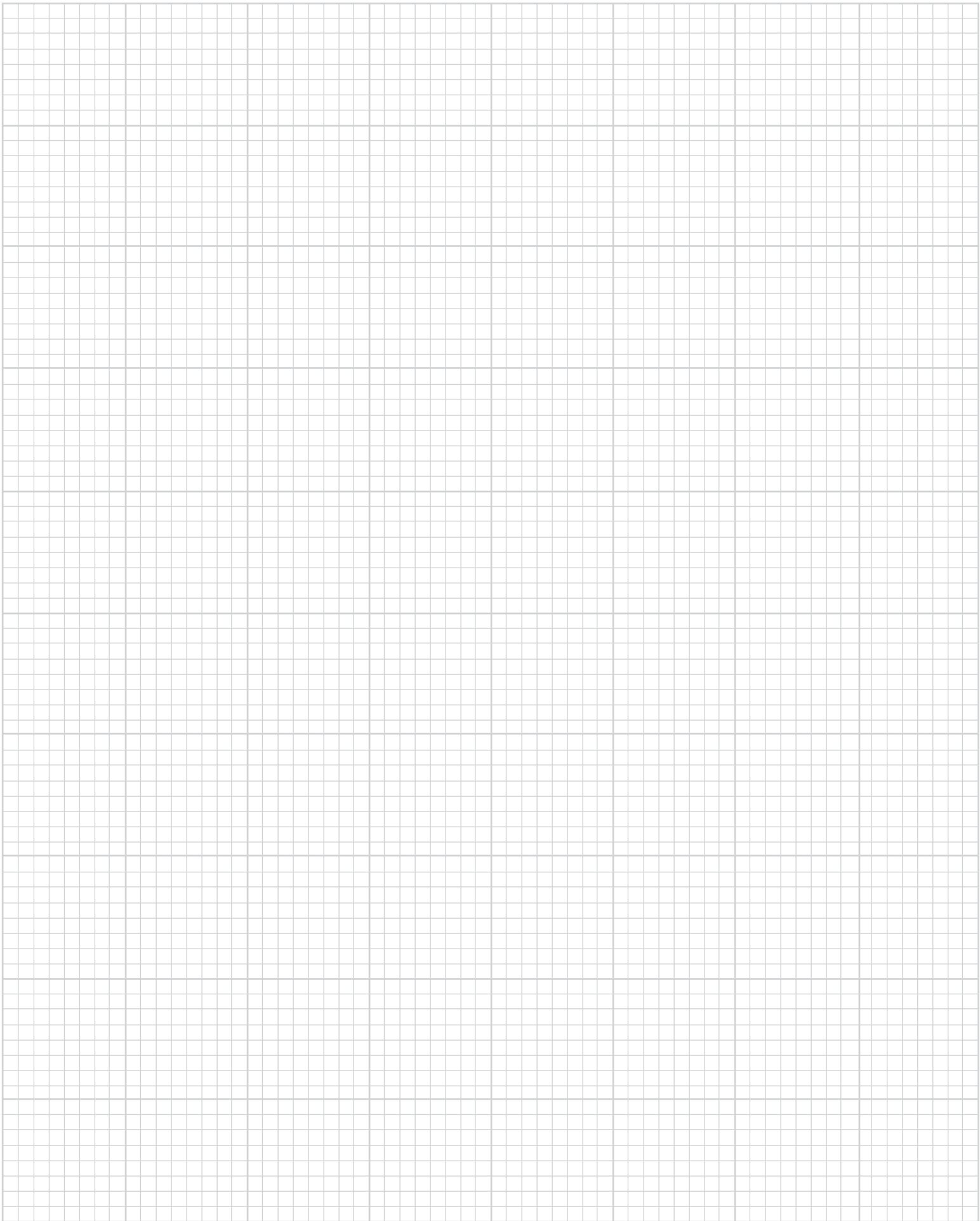

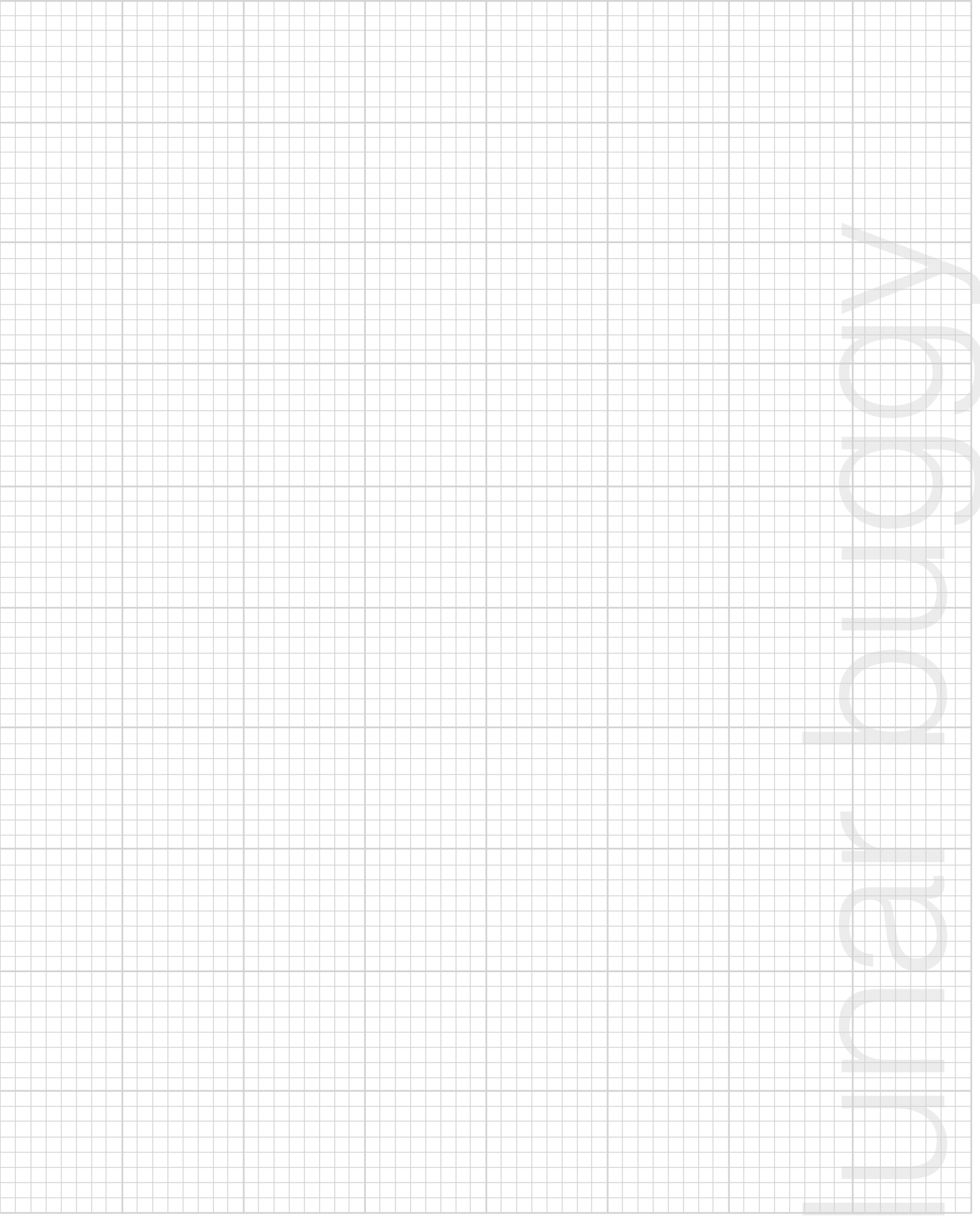

Design a Landing Pod

DESIGN challenge

To design and build a Landing Pod for the model Lunar Buggy that was built in the previous session.



OBJECTIVE

To demonstrate an understanding of the Engineering Design Process while utilizing each stage to successfully complete a team challenge.

PROCESS SKILLS

Measuring, designing, evaluating

MATERIALS

Lunar Buggy with egg cargo

General building supplies

Meter stick

Balloons

Bubble wrap and/or packaging material

Cardboard and/or shoeboxes

STUDENT PAGES

Design Challenge

Ask, Imagine and Plan

Experiment and Record

Please note: This activity may require two 60-90 minute sessions to complete.

landing pod

MOTIVATE

- Show the video titled “Entry, Decent, and Landing (EDL).”

<http://marsrovers.nasa.gov/gallery/video/challenges.html>

- Ask students to pay particular attention to the ways NASA slowed the rovers down as they entered the atmosphere. Note the difference between the Martian atmosphere and that of the Moon.

SET THE STAGE: **ASKIMAGINE & PLAN**

- Share the *Design Challenge* with the students.
- Remind students to ask questions and brainstorm ideas, then break into teams to create a drawing of a Landing Pod. All drawings should be approved before building.

CREATE

- Challenge the teams to build their Landing Pod based on their designs. Remind them the Lunar Buggy must be secured inside the Pod but cannot be taped or glued in place. Students should also be sure that the egg inside the rover is empty.

EXPERIMENT

- The actual “landing” is simulated by the facilitator. Suggestions: Drop Landing Pods safely out of a second story window, from a landing of a stairwell or from the top of a ladder. (Safety note: follow the manufacturer’s recommendation when using a ladder.) Just be sure the students know ahead of time what to expect.
- Open each Landing Pod after it comes to rest and check Buggy is upright.
- Using the same ramp as last session, place the Landing Pod at the top of the ramp and let the Lunar Buggy roll out. (It might require a little push.)
- The students should measure the distance the Buggy rolls and check to see if the egg stayed closed.

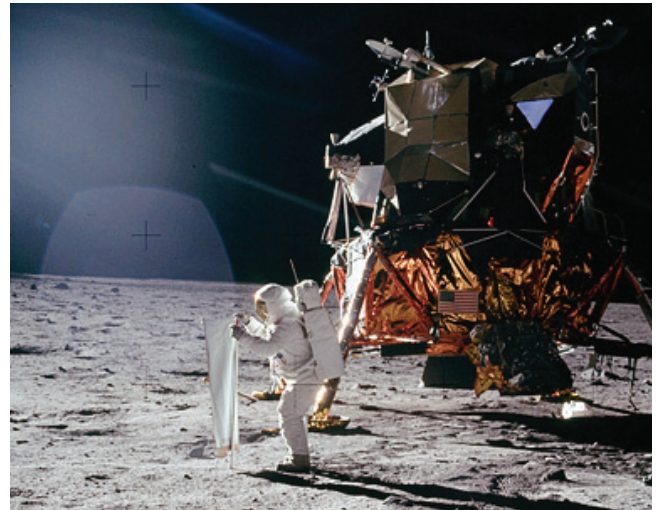

IMPROVE

- Students improve their Landing Pods based on results of the three trial drops.

CHALLENGE CLOSURE

Engage the students with the following questions:

- Which materials worked best to protect the Lunar Buggy?
- If you knew ahead of time that your Buggy had to survive a landing, would you have made any changes to your design?

PREVIEWING NEXT SESSION

Soon NASA will send the next generation of explorers to Mars or other destinations in the solar system aboard a new Crew Exploration Vehicle (CEV). The next session will have teams design and build a CEV that will carry two - 2 cm sized passengers safely and will fit within a certain size limitation.

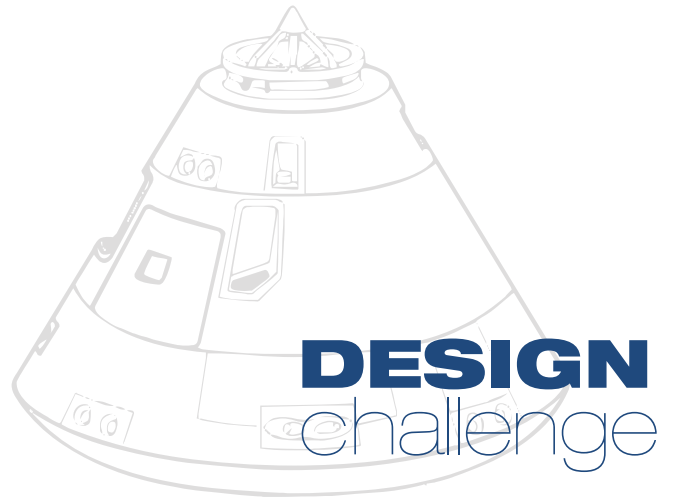

DESIGN challenge

To design and build a Landing Pod for the model Lunar Buggy that was built in the previous session.



Design a Landing Pod
Teacher page

landing pod

Fragile Cargo! Handle with Care!

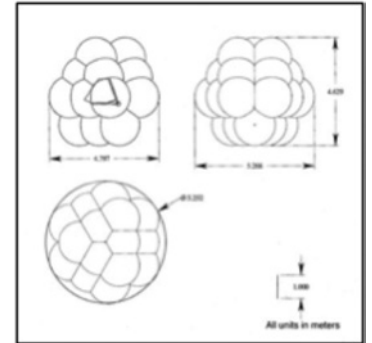
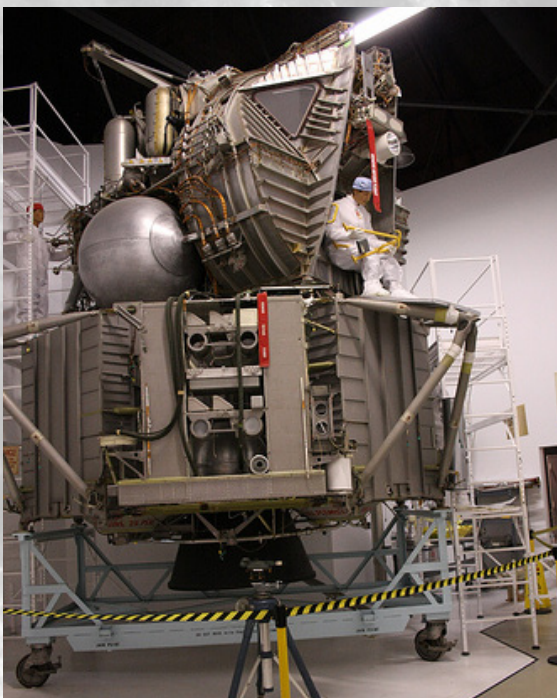

Now that you have designed a Lunar Buggy that will transport astronauts around the lunar surface, you need to think about safely delivering this vehicle to the Moon. When NASA sent its two robotic rovers, **Spirit** and **Opportunity**, to Mars, they landed on Mars in a very interesting fashion. They fell out of the Martian sky, slowed down by a parachute and then bounced on the surface until they came to a stop! How did they do that? The rovers were inside a landing pod made of AIR BAGS! But the Martian atmosphere and surface is very different from the Moon, so to repeat this on the Moon would require several design modifications.

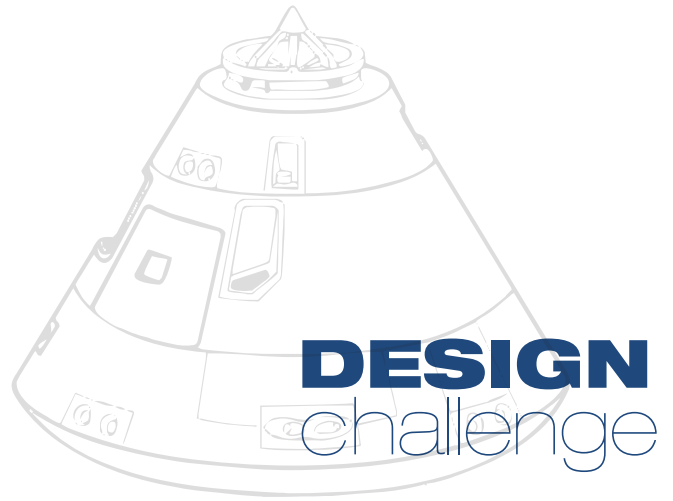

THE CHALLENGE:

Each team must design and build a Landing Pod that will safely deliver your Lunar Buggy to the Moon's surface. The Landing Pod must meet the following constraints:

- 1. The Landing Pod must safely deliver your Lunar Buggy to the surface from a height given by the teacher.*
- 2. The Landing Pod must land RIGHT-SIDE up and the Lunar Buggy must be able to roll out, so it must land in the correct orientation.*
- 3. Materials of the Landing Pod must be reusable for other missions on the lunar surface. If a balloon pops or tape folds over on itself, those items are no longer reusable.*
- 4. The Landing Pod must have a hatch or door for release of the Lunar Buggy, and should then roll out with no more than a nudge onto the ramp. Therefore, the Lunar Buggy cannot be taped or glued inside the Landing Pod.*
- 5. The Lunar Buggy should not suffer any damage from the lunar landing and still be able to roll down a ramp.*

To design and build a Landing Pod for the model Lunar Buggy that was built in the previous session.

Design a
Landing Pod
Student page

ASK IMAGINE &**PLAN**

Draw your Landing Pod and label the materials you plan to use to protect your Lunar Buggy. Make sure to indicate the “door” or “hatch” on the Landing Pod.

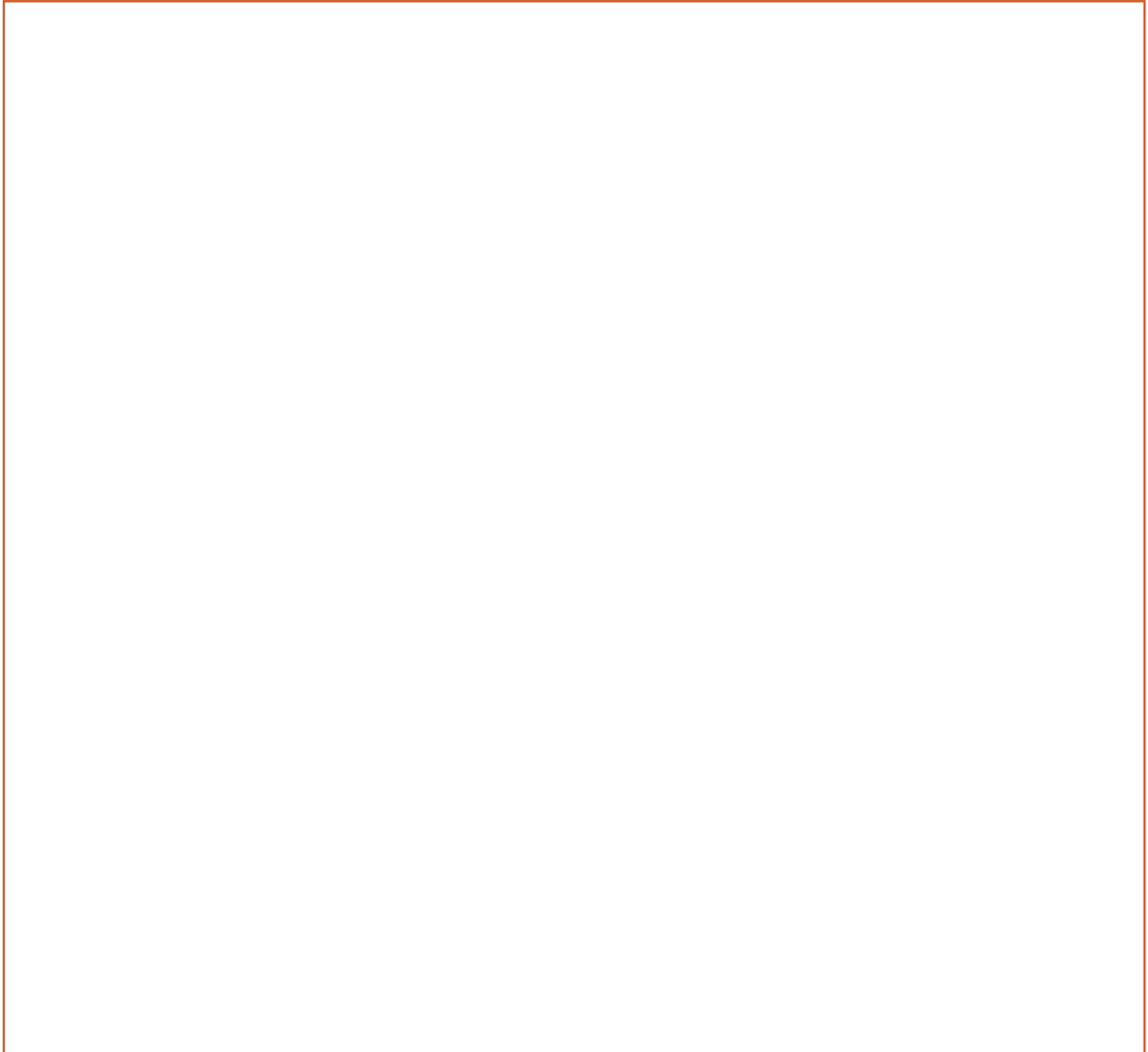

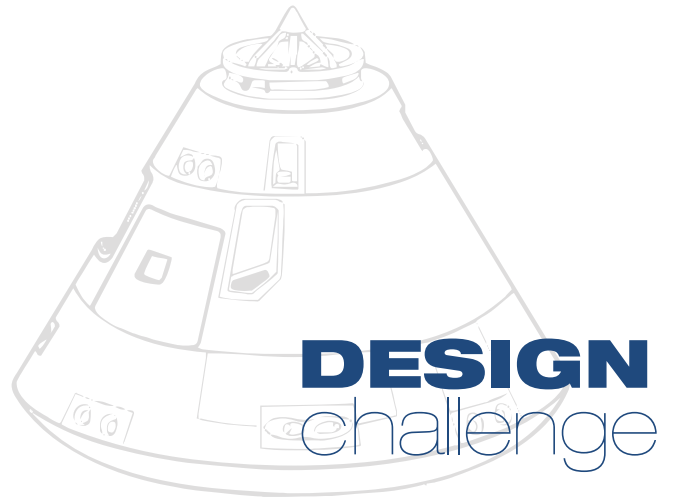

DESIGN challenge

*To design and build a
Landing Pod for the model
Lunar Buggy that was built
in the previous session.*

Design a
Landing Pod
Student page

Approved by: _____

Experiment & Record

Make two test drops with your Landing Pod, but use a height that is less than the final drop height given by your teacher. Record what happens to your Landing Pod and the Buggy inside.

Landing Pod Data Table

Trial	Drop Height (m)	Observations
1		
2		

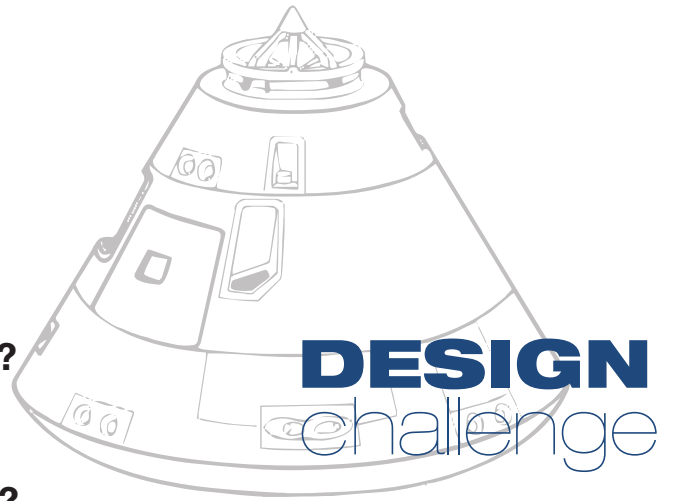

Was the Landing Pod damaged during the fall?
 Yes No

Was the Lunar Buggy damaged during the fall?
 Yes No

If you answered yes to either question above, discuss with your team how you should design the Landing Pod differently. If there is time, make changes in your drawing and add those changes to the Landing Pod.

To design and build a Landing Pod for the model Lunar Buggy that was built in the previous session.

Now for the actual lunar landing! Follow your teacher's instructions and answer the following questions.

Design a
 Landing Pod
Student page

Post Lunar Landing Questions

Did the Landing Pod remain closed during impact? (YES or NO)	Did the Lunar Buggy land in an upright position? (YES or NO)	How far did the Buggy roll beyond the ramp? (cm)

Draw a picture showing your Lunar Buggy and Landing Pod after the drop. Include any damage that may have occurred.

landing pod

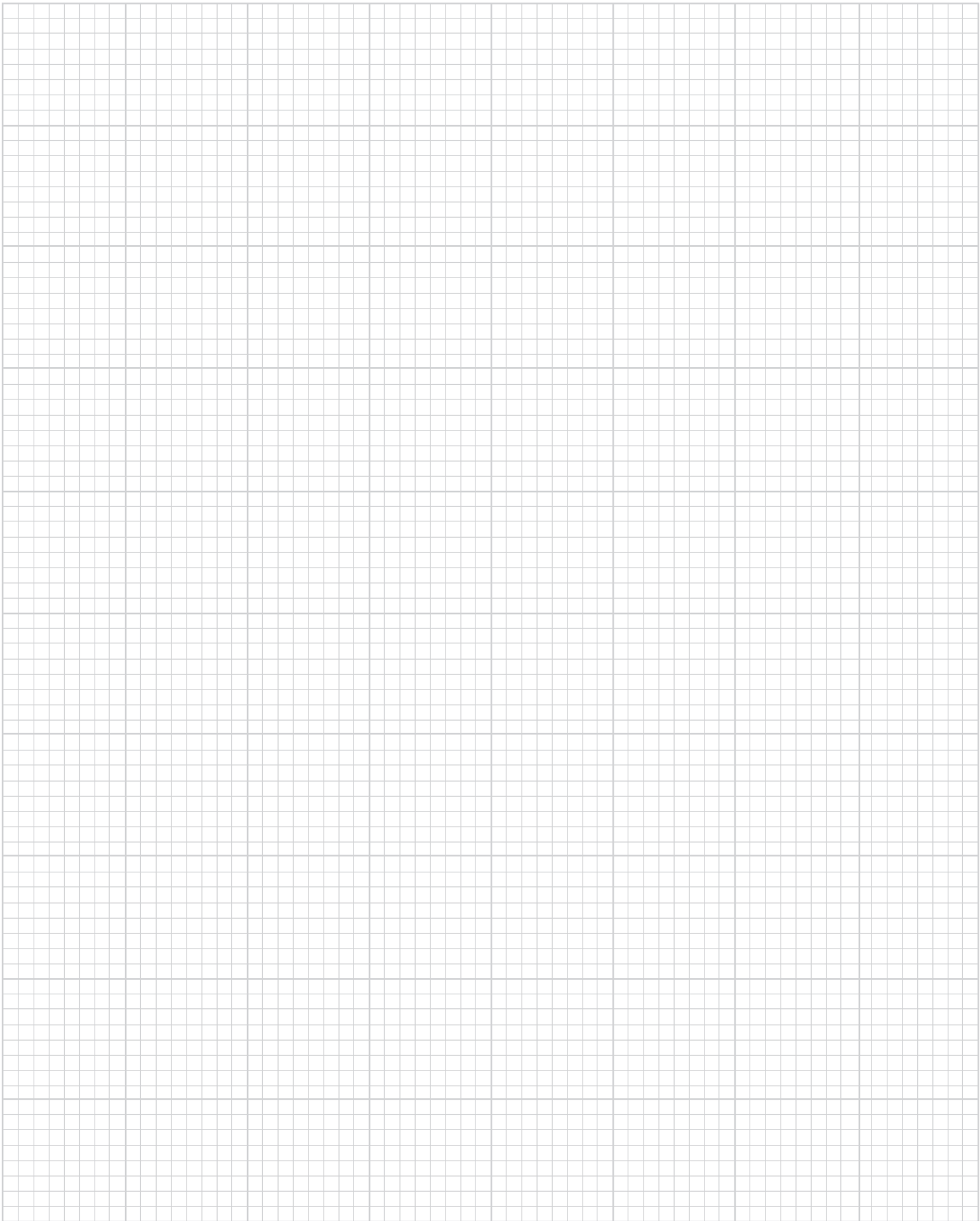

landings pool

Design a Crew Exploration Vehicle

DESIGN challenge

To design and build a Crew Exploration Vehicle (CEV) that will carry two - 2 cm sized passengers safely and will fit within a certain volume (size limitation). The CEV will be launched in the next session.

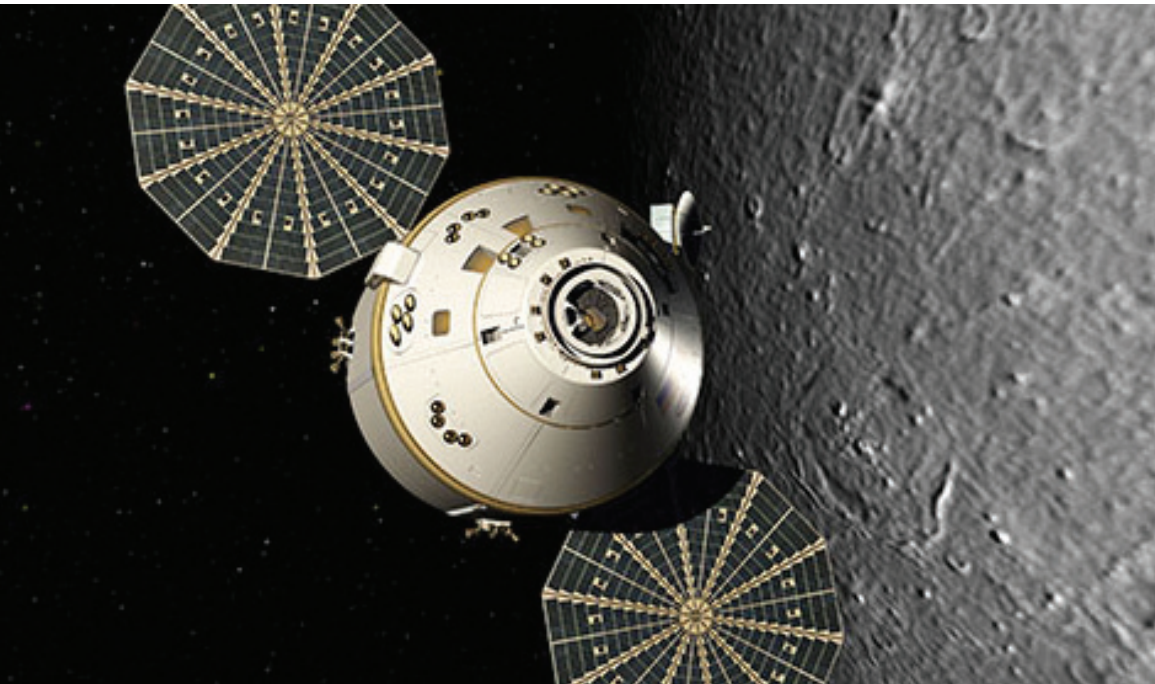

OBJECTIVE

To demonstrate an understanding of the Engineering Design Process while utilizing each stage to successfully complete a team challenge.

PROCESS SKILLS

Measuring, designing, evaluating

MATERIALS

General building supplies

Mailing tube, oatmeal canister, or small coffee can (used as size constraint)

2 plastic people (i.e. Lego)

STUDENT PAGES

Design Challenge

Ask, Imagine and Plan

Experiment and Record

PRE-ACTIVITY SET-UP

Select a size constraint (mailing tube, oatmeal canister or coffee can). Fill in the sentence on the Design Challenge so students will know what the size constraint is for their CEV.

exploration

MOTIVATE

- Show the NASA BEST video titled “Repeatability”:
<http://svs.gsfc.nasa.gov/goto?10515>
- Ask the students why it is important to test their own designs.

SET THE STAGE:

ASKIMAGINE &PLAN

- Share the *Design Challenge* with the students.
- Remind students to ask questions and brainstorm ideas, then break into teams to create a drawing of a CEV. All drawings should be approved before building.

CREATE

- Challenge the teams to build their CEVs based on their designs and to keep within specifications.
- Visit each team and test their designs to ensure they fit within the size specifications of the cylinder you are using.

EXPERIMENT

- Each team should conduct two drop tests from about 1 meter. The students can simply hold the CEV model over their heads and drop it. They should record their results after each test, and note what changes they plan to make as a result of the drop test.

IMPROVE

- After each drop test, the students should improve the CEV models based on the results of the experiment.

CHALLENGE CLOSURE

Engage the students with the following questions:

- *What was the greatest challenge for your team today?*
- *Why was it important that the hatch stay closed during the Drop tests?*
- *What process will your CEV undergo that makes it important for the astronauts to stay secured in their seats?*

PREVIEWING NEXT SESSION

Ask teams to bring back their CEV model for use in next session's challenge. You may want to store them in the classroom or have one of the facilitators be responsible for their safe return next session.

Ask teams to think about potential launch mechanisms before the next session. Tell them they will be building a launcher out of the standard materials that have been available to them, including large rubber bands.



DESIGN challenge

To design and build a Crew Exploration Vehicle (CEV) that will carry two - 2 cm sized passengers safely and will fit within a certain volume (size limitation). The CEV will be launched in the next session.



Design a CEV
Teacher page

exploration

Taking humans back to the Moon...40 years later!

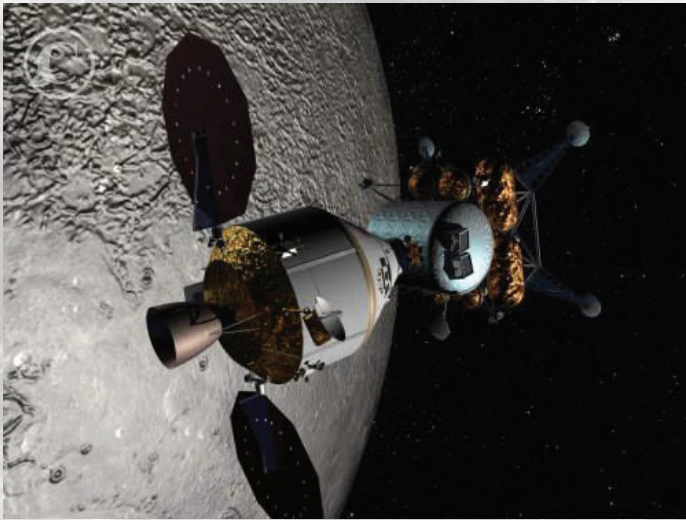

NASA needs a new vehicle to take astronauts to the Moon because the Space Shuttle was never designed to leave the Earth's orbit. NASA and its industry partners are working on a space vehicle that will take astronauts to the Moon, Mars, and beyond.

This spacecraft is called the Crew Exploration Vehicle (CEV). The CEV is a vehicle to transport human crews beyond low-Earth orbit and back again. The CEV must be designed to serve multiple functions and operate in a variety of environments.

THE CHALLENGE:

Each team must design and build a Crew Exploration Vehicle with the following constraints:

- 1. The CEV must safely carry two “astronauts”. You must design and build a secure seat for the astronauts, without gluing or taping them in place. The astronauts should stay in their seats during each drop test.*
- 2. The CEV must **fit within** the _____.*
This item serves simply as a size constraint. The CEV is not to be stored in this or launched from this item.
- 3. The CEV must have one hatch that opens and closes and is a size that your “astronauts” can easily enter/exit from. The hatch should remain shut during all drop tests.*

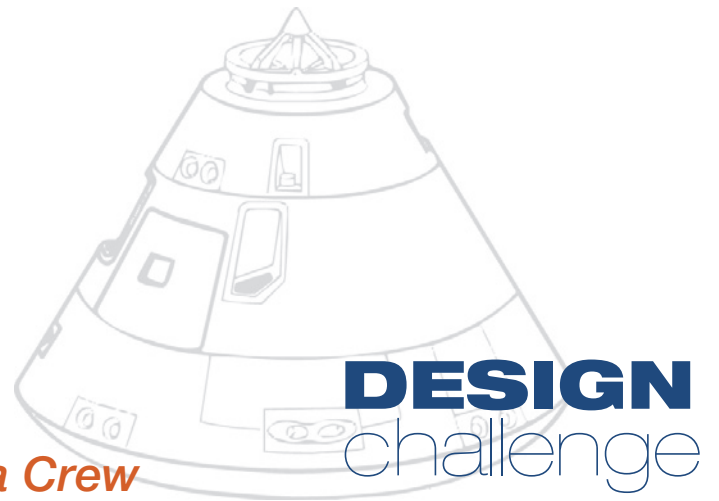

To design and build a Crew Exploration Vehicle (CEV) that will carry two - 2 cm sized passengers safely and will fit within a certain volume (size limitation). The CEV will be launched in the next session.

Design a CEV
Student page

exploration

ASK IMAGINE & PLAN

Draw your Crew Exploration Vehicle (CEV) and show where the astronauts will sit.

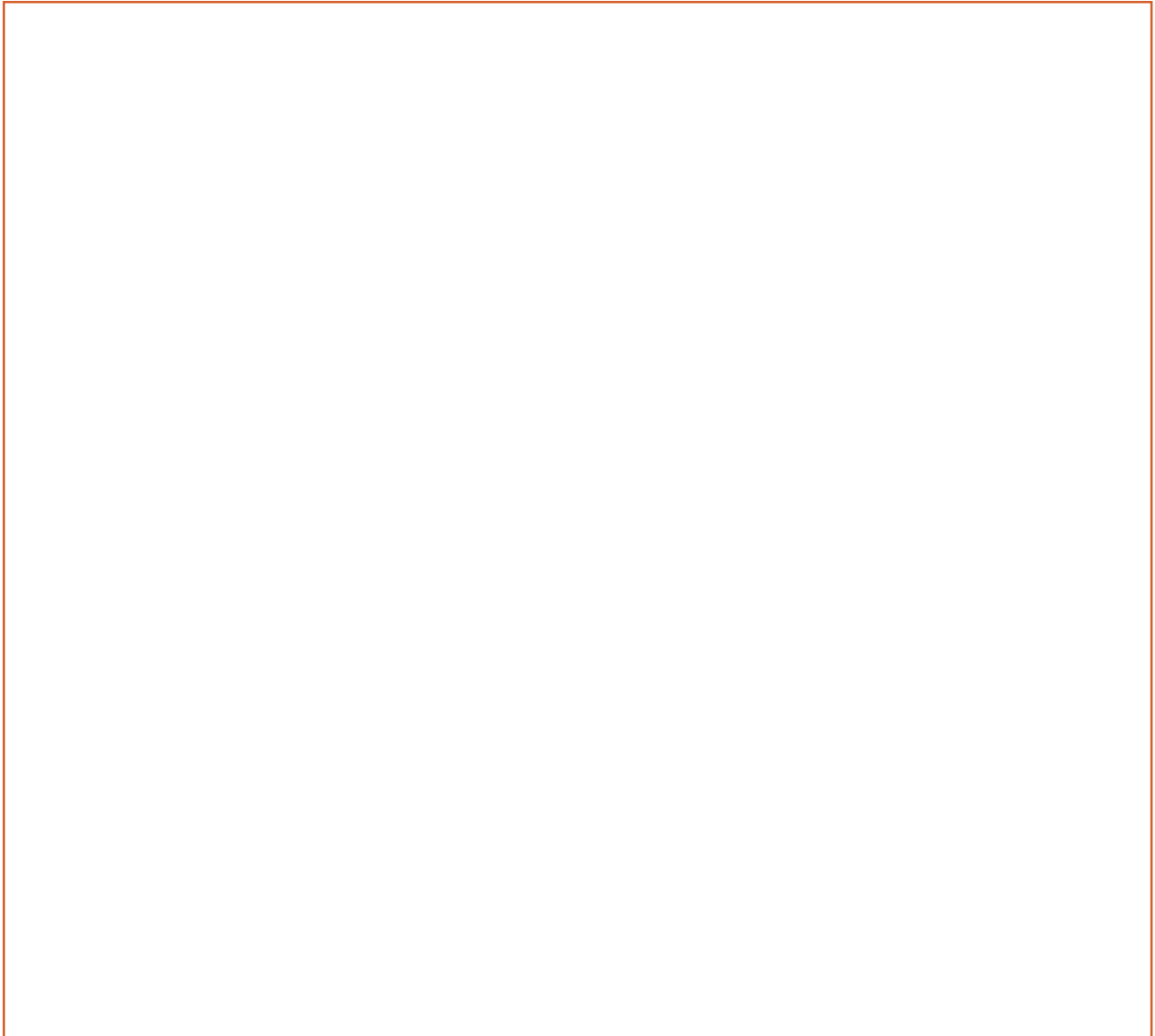

Approved by: _____

Review your team's design. Answer the questions in the table.



DESIGN challenge

Vehicle components	Use	Measurement
Astronauts	Crew	How many?
CEV	Carries crew to Moon	<p>What is the diameter (cm) of the container serving as your size constraint?</p> <p>Does your CEV fit the size restrictions?</p>
Hatch	Allows entry and exit	<p>How many people wide?</p> <p>How many people high?</p>

To design and build a Crew Exploration Vehicle (CEV) that will carry two - 2 cm sized passengers safely and will fit within a certain volume (size limitation). The CEV will be launched in the next session.

Design a CEV
Student page

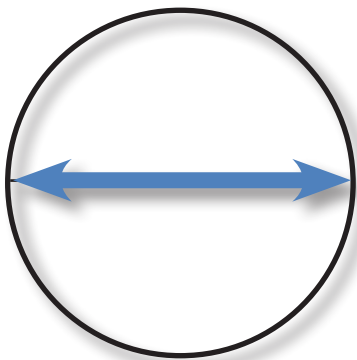

HINT!

What is diameter? The diameter is the length of a straight line that passes through the center of a circle. Use a ruler to measure the line from one edge of the circle to the opposite edge.

exploration

Experiment & Record

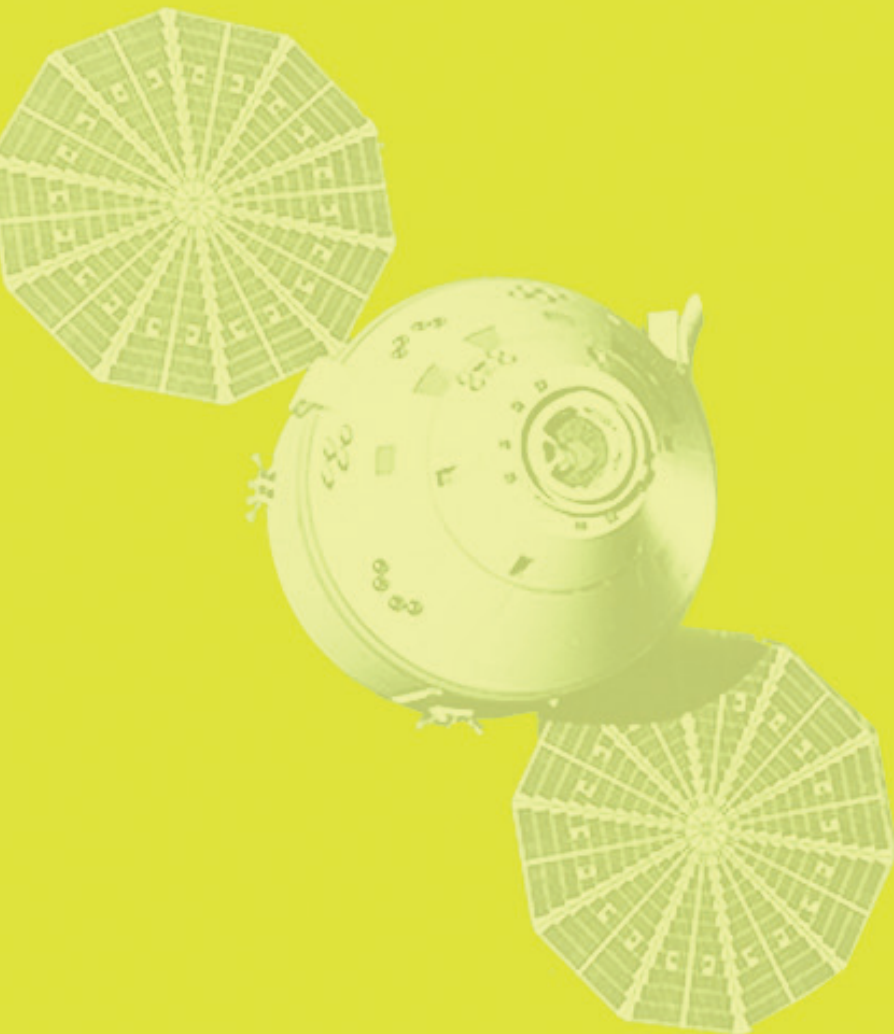

**Drop your CEV from over your head.
Answer the questions in the table.**

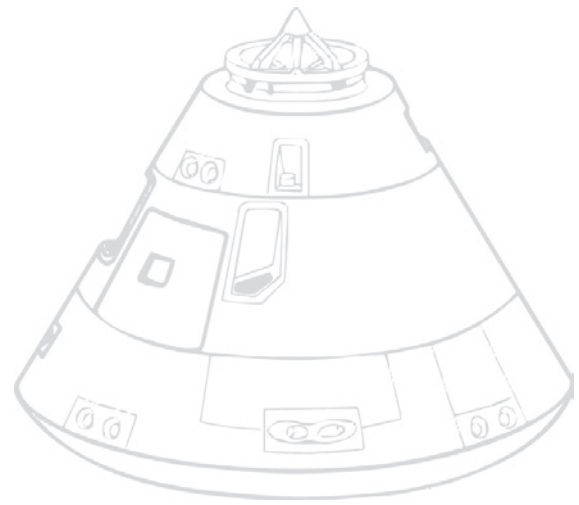

CEV Drop Test Observation Table

Trial Number	Observations
1	<p>Did the astronauts stay in their seats? YES or NO</p> <p>Did the door fly open? YES or NO</p>
2	<p>Did the astronauts stay in their seats? YES or NO</p> <p>Did the door fly open? YES or NO</p>

Design a CEV
Student page

If any damage occurred to your CEV, or your astronauts did not stay in place, discuss with your team how you should design the CEV differently. If there is time, make changes in your drawing and add those changes to the model CEV.

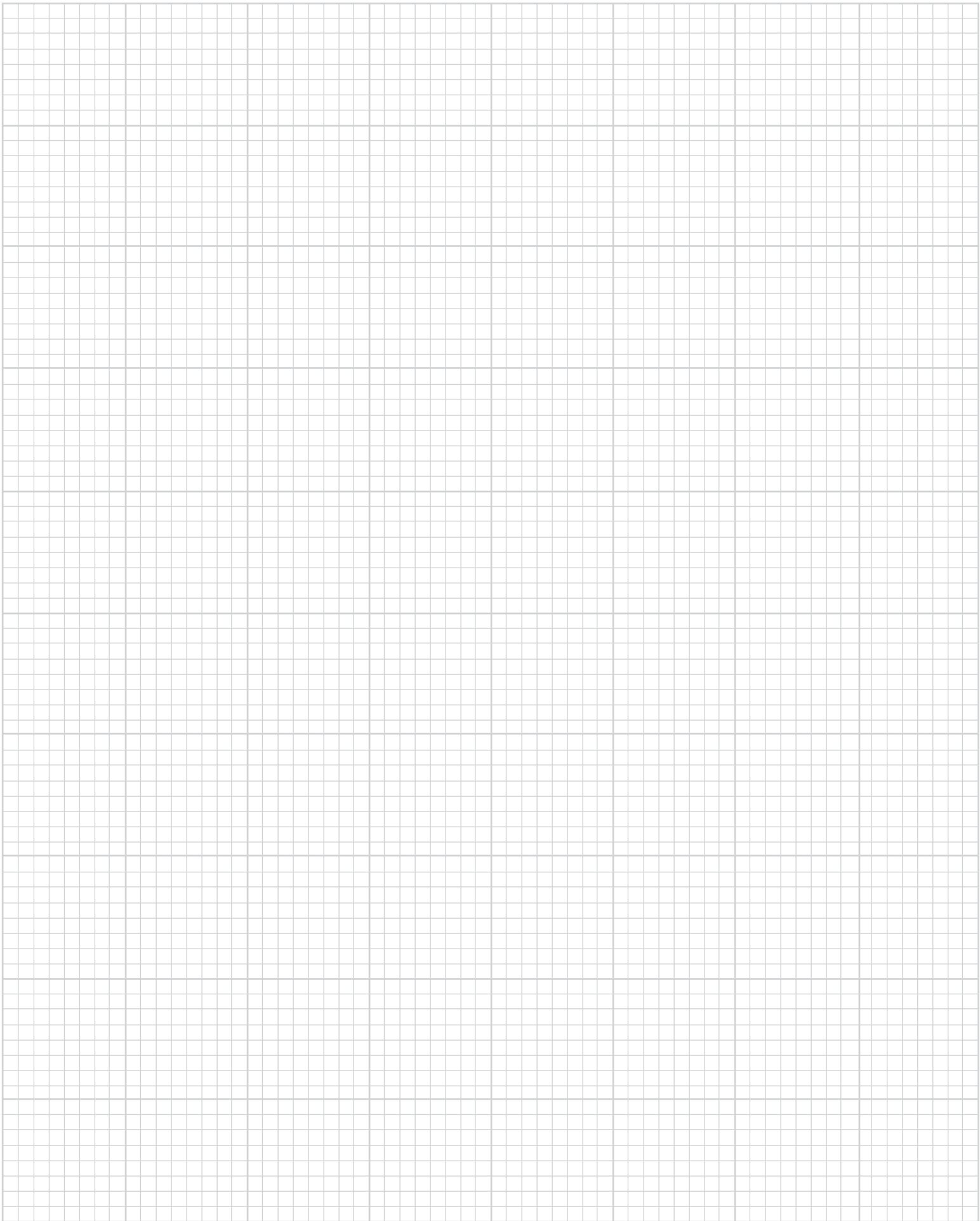

exploration



DESIGN challenge

To design and test a Reusable Launcher for the Crew Exploration Vehicle (CEV). The CEV should travel 5 meters when launched.

OBJECTIVE

To demonstrate an understanding of the Engineering Design Process while utilizing each stage to successfully complete a team challenge.

PROCESS SKILLS

Measuring, designing, evaluating

MATERIALS

General building supplies

Meter stick or measuring tape

C-clamps

Rubber bands of various sizes

Model CEV from previous activity

STUDENT PAGES

Design Challenge

Ask, Imagine and Plan

Experiment and Record

PRE ACTIVITY SET UP

See next page.

launch your CEV

MOTIVATE

- Show the first two minutes of the video titled “Constellation: Flight Tests”. (if time permits, show all)
www.nasa.gov/mission_pages/constellation/multimedia/index.html
- Ask the students what was the most important lesson learned from those images? (test, test and test again!)

SET THE STAGE:

ASKIMAGINE & PLAN

- Share the *Design Challenge* with the students.
- Emphasize that the objective is to build a launcher producing repeatable results. It is more important for the CEV to launch the same distance each time than for the CEV to be launched the farthest.
- Remind students to ask questions and brainstorm ideas, then break into teams to create a drawing of a reusable launcher. All drawings should be approved before building.

CREATE

- Challenge the students to build a Reusable Launcher based on their designs.

EXPERIMENT

- Conduct two sets of tests: 3 launches, each using three different set-ups. Record data.

IMPROVE

- Students improve the Reusable Launcher based on results of the tests.

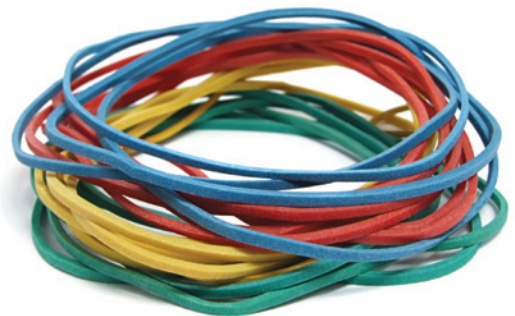

CHALLENGE CLOSURE

Engage the students with the following questions:

- *Why was it important that the launcher be reusable?*
- *Why was it important that your results were repeatable?*

PREVIEWING NEXT SET OF ACTIVITIES

The Moon is a very harsh environment. There is no atmosphere to protect astronauts and their equipment from solar radiation and the extreme temperature swings between night and day. Next session, we will begin to find ways to protect astronauts from those extreme temperature changes.

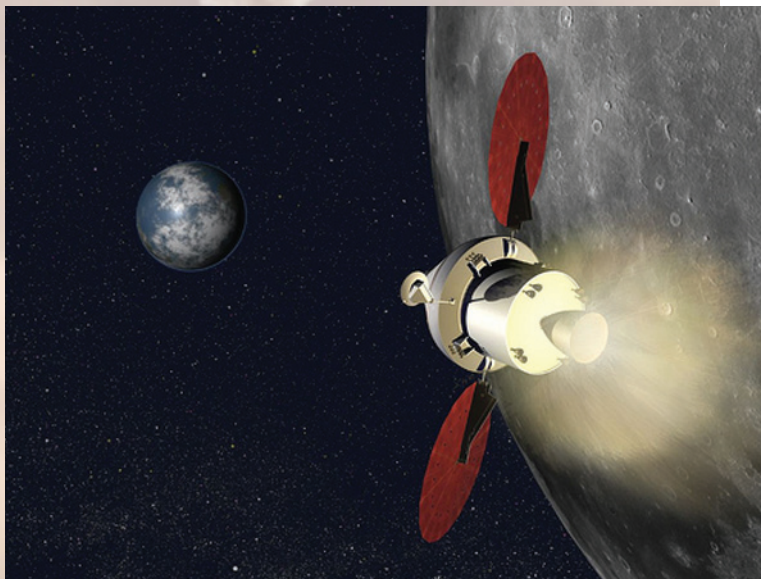

DESIGN challenge

To design and test a Reusable Launcher for the Crew Exploration Vehicle (CEV). The CEV should travel 5 meters when launched.

Launch Your CEV
Teacher page



It's Time to Launch into Space!

For years, NASA has been reusing launch components to send rockets and the Space Shuttle into space. For example, the solid rocket boosters (SRB's) on the Space Shuttle are often retrieved from the ocean, brought back to Kennedy Space Center, then cleaned and prepped for another Shuttle Launch. Why? The same reason we recycle our aluminum cans. It helps the environment and helps us save money for future launches. During this session, you must design and test a Reusable Launcher for your Crew Exploration Vehicle that will journey to the Moon. Therefore, your goal will be to launch your CEV into orbit around the Moon.



THE CHALLENGE:

To design and test a Reusable Launcher with the following constraints:

- 1. Launch the CEV to reach a goal of **5 meters**. See the drawing on the previous page for an idea of how to set up your launch.*
- 2. The Launcher must be reusable for each trial. If your rubber band breaks because it was pulled too far, it is not reusable for another launch.*
- 3. The Launcher produces a repeatable outcome. If you set up the Launcher the same way twice, the CEV should travel the same distance both times. It is more important that the CEV is launched the same distance using the same setup than it is to get the CEV to travel the farthest distance.*

DESIGN challenge

To design and test a Reusable Launcher for the Crew Exploration Vehicle (CEV). The CEV should travel 5 meters when launched.

Launch Your CEV
Student page



Launch Set-Up

Use ruler or tape to measure how far the rubber band is pulled back.

Launcher goes here.

Target: Moon

5 meters

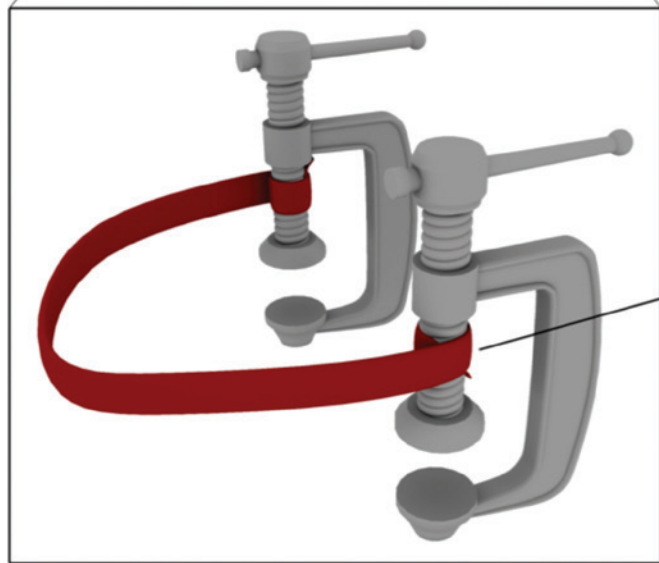
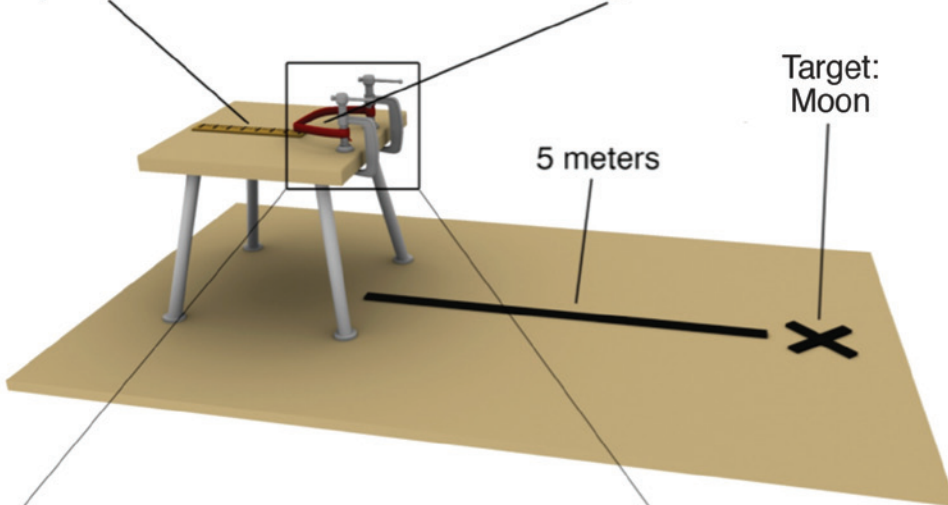

Clamp down or wrap a rubber band.

DESIGN challenge

To design and test a Reusable Launcher for the Crew Exploration Vehicle (CEV). The CEV should travel 5 meters when launched.

Launch Your CEV
Student page

launch your CEV

ASK IMAGINE &**PLAN**

Draw and label a picture of your team's Reusable Launcher.





MAKE A PREDICTION!

If you change how far back you pull the rubber band, how will it affect the launch?

DESIGN
challenge

To design and test a Reusable Launcher for the Crew Exploration Vehicle (CEV). The CEV should travel 5 meters when launched.

Launch Your CEV
Student page

Approved by: _____

Experiment & Record

1. Measure how far back you pull the rubber band and record it in the table. Launch your CEV and record the distance it travels. Repeat the experiment two more times with the same pull length.

2. Now pull the rubber band back at a different length and launch your CEV. Measure the new distance and record your data. Repeat.

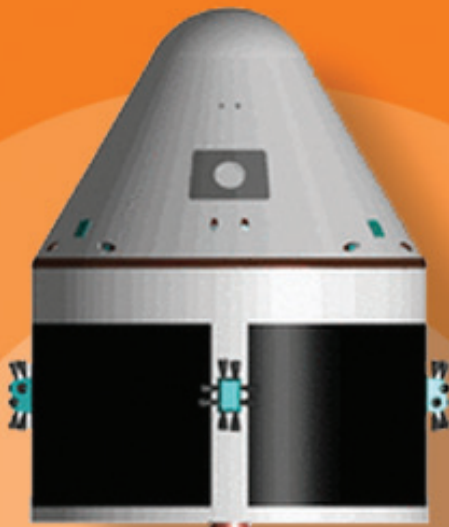

CEV Launch Data Table

Trial	Distance rubber band is pulled back	Distance traveled (m)	Distance from target (m)
1	Setup A: ____ cm		
2	Setup A: ____ cm		
3	Setup A: ____ cm		
1	Setup B: ____ cm		
2	Setup B: ____ cm		
3	Setup B: ____ cm		

Did your launcher produce the same distances for each pull of the rubber band? If not, discuss with your team how to improve the launcher. Make those changes and repeat the experiment.

launch your cev

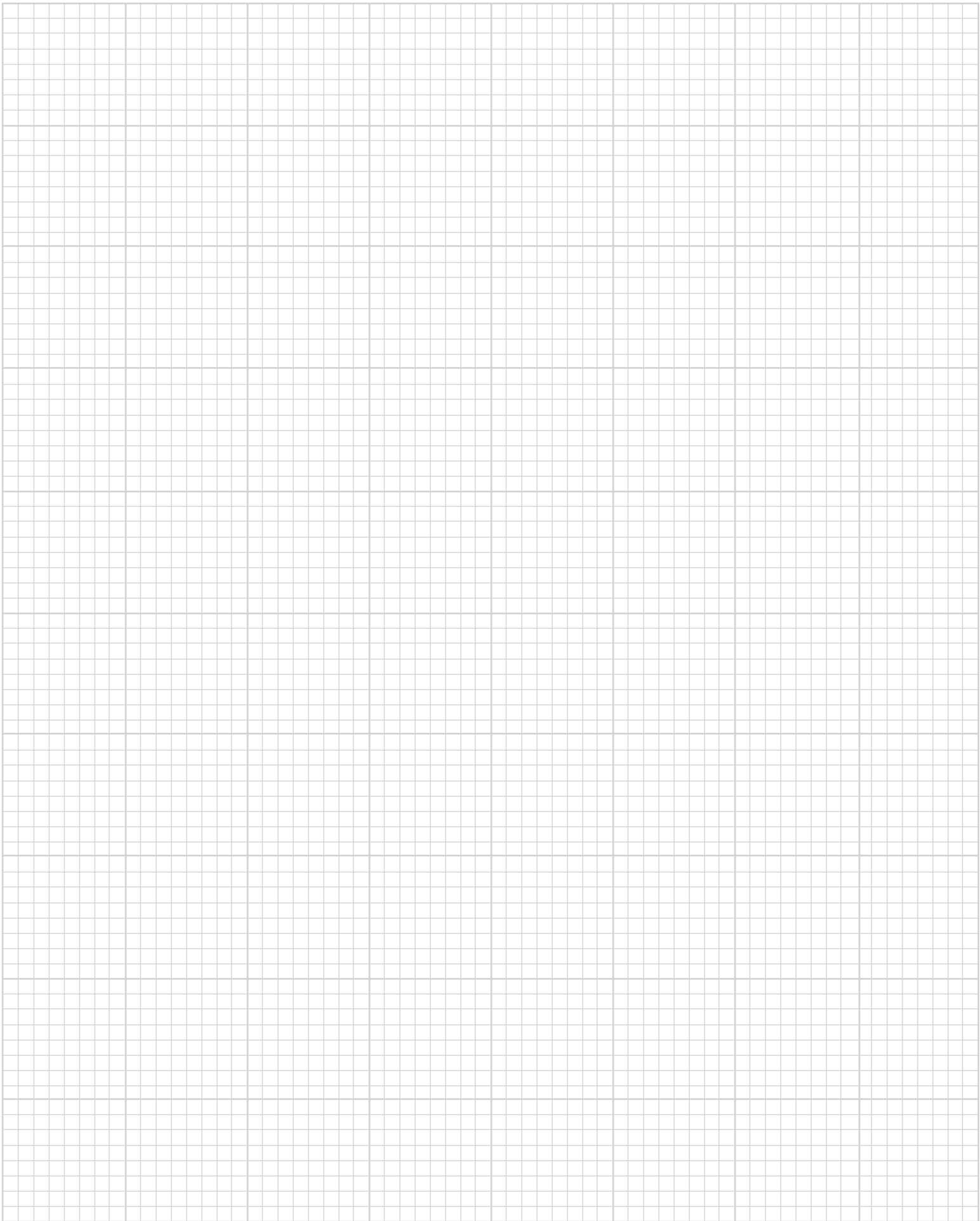

launch your ceV

DESIGN challenge

To design an insulator for a cup of warm water to maintain water temperature relatively constant. To apply the understanding of how things get warmer and cooler heat transfer.

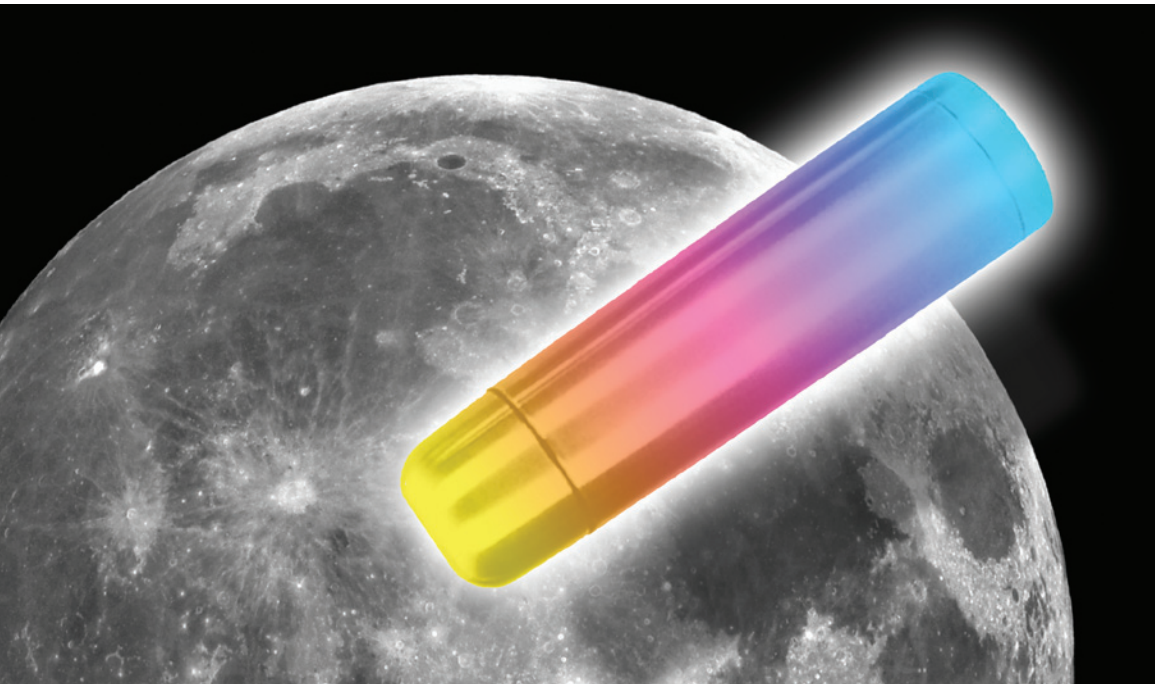

OBJECTIVE

To demonstrate an understanding of the Engineering Design Process while utilizing each stage to successfully complete a team challenge.

PROCESS SKILLS

Experimental design, measuring, and data analysis

MATERIALS

Glow sticks (2)

Thermometers

Stopwatches

Graduated cylinders

Plastic cups

Insulating materials

(e.g. bubble wrap, paper, cloth, sand, water, foil, Styrofoam, etc.)

STUDENT PAGES

Design Challenge

Ask, Imagine and Plan

Experiment and Record

PRE-ACTIVITY SET UP

While the students are using the EDP to create an insulator, they will also be conducting a scientific experiment that requires a control. While the students test their cups, place a cup of hot water and a cup of cold water at the front of the room, un-insulated, each holding a thermometer. Set a timer for every 30 seconds and record the data to share with the students so they may compare their data.

MOTIVATE

- Ever wonder what is involved in designing today's spacesuits? Check out this interactive site to learn about NASA's spacesuits:

www.nasa.gov/audience/foreducators/spacesuits/home/clickable_suit.html

SET THE STAGE:

ASKIMAGINE &PLAN

- Share the *Design Challenge* with the students
- Let students pretend to be molecules. First have them stand still and close together. Then have the students wiggle and then walk and move around to demonstrate more heat energy entering the system. Have them move faster and jump up and down as even more energy enters the system. Then have the students stop to notice where they are standing. (Note: They should be much farther apart and should feel much warmer than they were originally.)
- Place a glow stick in a clear cup of hot water and a clear cup of cold water, then turn off the lights. Using the knowledge they just acquired from the earlier activity, ask the students to select the glow stick with more molecular movement.
- Remind students to ask questions and brainstorm ideas, then break into teams to create a drawing of a lunar thermos. All drawings should be approved before building.

CREATE

- Have students practice measuring temperature on the thermometer.
- Challenge the students to devise an insulation system to keep warm water at a constant temperature.

EXPERIMENT

- Have students follow the directions on the Experiment and Record worksheet to complete their experiment.

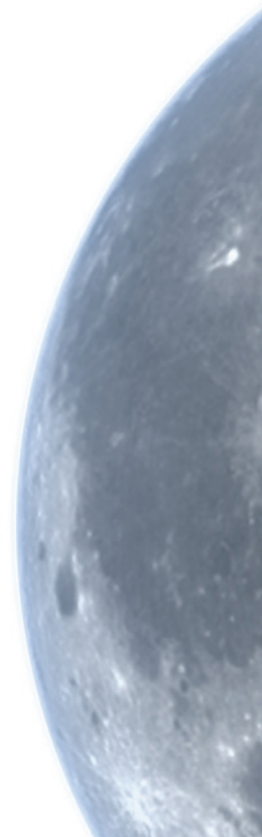

IMPROVE

- Have students design other combinations of materials to decrease any temperature fluctuation from their first design.

CHALLENGE CLOSURE

Engage the students in the following questions:

- *How much did the temperature of the water change in your Lunar Thermos?*
- *How does your experiment's data compare to the control experiment your teacher conducted at the front of the room?*

PREVIEWING NEXT WEEK

During this session, you explored designing insulation to reduce temperature changes, much like protecting humans from the extreme temperature swings on the Moon's surface. What if you needed to capture heat energy instead?

DESIGN challenge

To design an insulator for a cup of warm water to maintain water temperature relatively constant. To apply the understanding of how things get warmer and cooler heat transfer.

Design
a Lunar Thermos
Teacher page





Oh, to not have an atmosphere!

There is no atmosphere on the Moon, so temperatures fluctuate through a very wide range. In the shadowed areas of the moon, the temperature can be as low as -180°C (or -300°F), and in the sunlit areas, it is about 100°C (or 212°F), which is the boiling point for water! These are serious extremes for human beings! Furthermore, there are spots on the Moon that are permanently exposed to the Sun, and others permanently in shadow. It is in the permanently shadowed areas of some craters that scientists believe water ice may exist.

Protecting Ourselves

Anyone living on the Moon - even for a short while - will have to deal with this temperature variation and be protected properly from its damaging effects. Just think about the number of layers you wear when going outside on a very cold winter's day. The goal in designing a space suit is to create protective layers to keep a human body at a fairly constant temperature. Therefore, we must understand how heat moves. We need to design protective wear to **prevent** heat from being transferred to, or transferred away, from our bodies. How could we **insulate** ourselves from the wide variations of temperature in the lunar environment?

THE CHALLENGE:

Your mission is to design a “Lunar Thermos” – a protective insulator for a cup of warm water. You must also conduct an experiment to compare your insulated cups to unprotected cups set up by your teacher. The design constraints are:

- 1. Use any combination of materials available to you to create a protective insulating layer to keep 100 ml of warm tap water at a relatively constant temperature.*
- 2. Your “Lunar Thermos” temperatures should change by no more than 3 °C over 5 minutes.*

DESIGN challenge

To design an insulator for a cup of warm water to maintain water temperature relatively constant. To apply the understanding of how things get warmer and cooler heat transfer.

Design
a Lunar Thermos
Student page

ASK IMAGINE & PLAN

Draw a picture of a warm human standing on the Moon in the cold, lunar night. In your picture, show how heat moves between the human and the air around him or her. Make sure to label the arrows warm and cool.



Now imagine that the sun comes up, and the human is standing on the hot lunar surface. Draw a picture showing how heat moves between the human and the air around him or her. Make sure to label the arrows warm and cool.



lunar thermos

Draw and label the materials you will use to build your Lunar Thermos.



Approved by: _____

lunar thermos

Experiment & Record

- 1. Collect necessary materials and create your Lunar Thermos.**
- 2. Using a graduated cylinder, collect 100 mL of warm tap water and pour it into your insulated plastic cup.**
- 3. Use a stopwatch to measure 30 seconds. Record the temperature of the water. Repeat until you reach 5 minutes total.**

Lunar Thermos Data Table

Time (Min:sec)	Water Temperature (°C)
0:00	
0:30	
1:00	
1:30	
2:00	
2:30	
3:00	
3:30	
4:00	
4:30	
5:00	

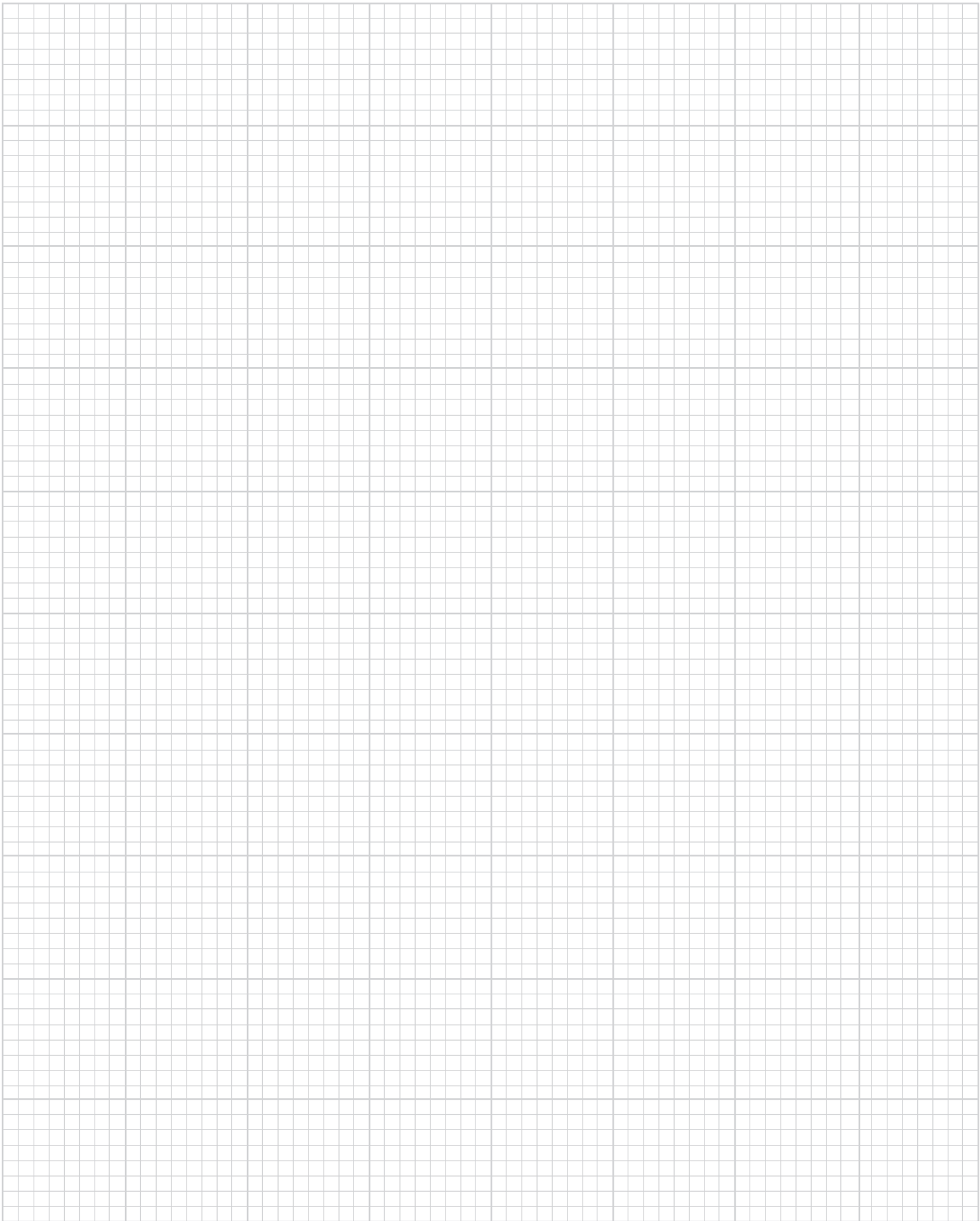

junar thermos

Build a Solar Oven

DESIGN challenge

To design and build a solar box cooker, and test it to see if it works well enough to make S'mores.

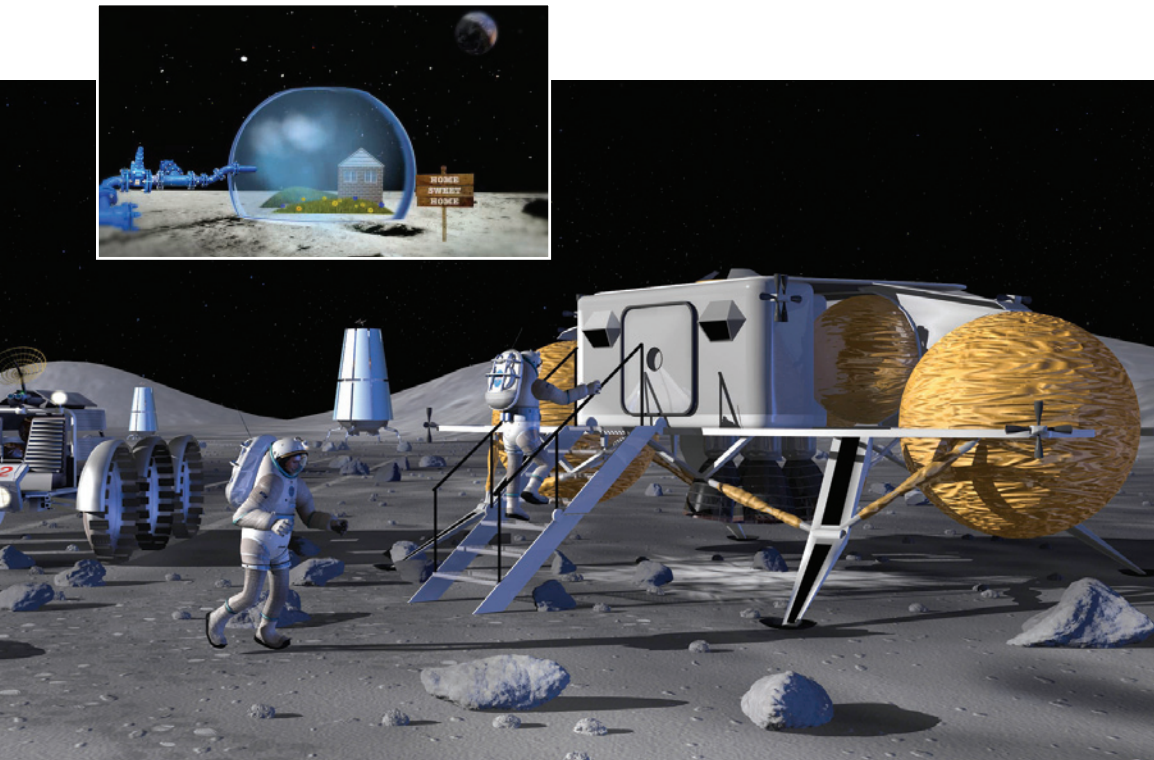

OBJECTIVE

To demonstrate an understanding of the Engineering Design Process while utilizing each stage to successfully complete a team challenge.

PROCESS SKILLS

Experimental design, measuring and data analysis

MATERIALS

Thermometers

Stopwatches

Cardboard box
(no smaller than 40cm wide)

Aluminum pie pans

Aluminum foil

Black construction paper

Plexiglass or plastic wrap big enough to cover the box

Sunshine, OR gooseneck lamp with 100 W bulb

S'mores fixin's (graham crackers, marshmallows and chocolate)

Oven mitts or tongs

STUDENT PAGES

Design Challenge

Ask, Imagine and Plan

Experiment and Record

PRE-ACTIVITY SETUP

It is recommended to take a few minutes at the start of the session to discuss safe handling procedures of the food and of their solar ovens when exposed to the sun: (1) Remind students the importance of hand washing before handling food; and (2) Ovens will get hot and will require the use of protective gear or a tool to manipulate items in and out of the ovens.

Please note: This activity may require two 60-90 minute sessions to complete.

solar oven

MOTIVATE

- Have students watch the video “Living on the Moon“:

<http://svs.gsfc.nasa.gov/goto?10515>

SET THE STAGE:

ASKIMAGINE & PLAN

- Share the *Design Challenge* with the students
- Remind students to ask questions and brainstorm ideas, then break into teams to create a drawing of a solar oven. All drawings should be approved before building.
- Tell students that if they succeed in their design, a tasty treat will be had!

CREATE

- Hand out the materials to the students and challenge them to build their own solar ovens.

EXPERIMENT

- Have students follow the directions on the Experiment and Record worksheet to complete their experiment.
- Once the oven is built, students should place a S'more and the thermometer in the box and cover the top with plastic wrap (or plexiglass lid).
- Place the box in direct sunlight (students may have to tilt the box so that there are no shadows inside). If it is a cloudy day, use a gooseneck lamp with the 100 W bulb.
- Assist students when measuring the temperature or removing items from the solar oven once exposed to the sun. Ensure safety measures are in place.



IMPROVE

If there is time, have students inspect their designs and the experiment results. Allow teams to rework their design if needed.

CHALLENGE CLOSURE

Engage the students in the following questions:

- *Whose oven got to the highest temperature?*
- *Whose oven melted the marshmallows and the chocolate?*
- *Does it make a difference to use actual sunlight compared to light from a lamp? Why or why not?*
- *What else could you cook using a solar oven?*

END OF PROGRAM

This session concludes the NASA Beginning, Engineering, Science and Technology activities. Students now should have a firm grasp of the Engineering Design Process and how it is applied in real applications of our quest to travel to the Moon, Mars and beyond. Fill out a certificate for each student for completing all the steps to becoming a NASA BEST student (see end of guide).

DESIGN challenge

To design and build a solar box cooker, and test it to see if it works well enough to make S'mores.

Build a Solar Oven
Teacher page

solar oven

Can we cook while on the Moon?

While astronauts might have to bring just about everything with them when we establish a habitat on the Moon, one thing they won't need is solar energy. There may be no atmosphere, no climate nor weather on the Moon, but that DOES make it an ideal place to collect solar energy. Much of the Moon is exposed to sunlight constantly, except briefly during a rare lunar eclipse. If that energy could be harnessed, it could power almost everything in the lunar habitat...including that most important device that helps prepare delicious food – an oven!

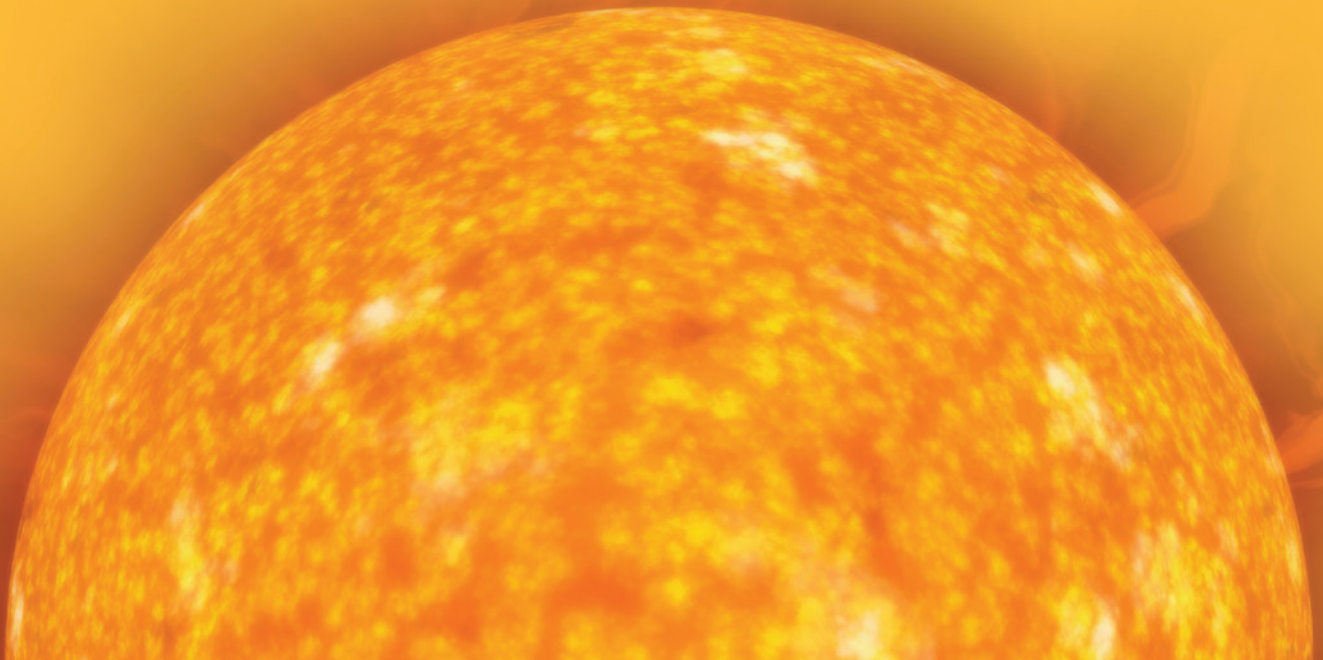

THE CHALLENGE:

Your mission is to design and build a solar oven to cook your own S'mores with the materials provided. Your design constraints are:

1. The oven must have a "footprint" of no more than 40 cm x 40 cm.
2. In 5 minutes, the temperature inside the box must increase by 5°C.

SAFETY NOTE: *Contents of solar oven can get very hot. Seek assistance from your teacher and use oven mitts, other protective gear or tools (i.e. tongs) when manipulating anything inside of your oven!*



DESIGN challenge

To design and build a solar box cooker, and test it to see if it works well enough to make S'mores.

Build a Solar Oven
Student page

solar oven

ASK IMAGINE & PLAN

Place a piece of white paper and a piece of black construction paper outside in the sun or under a lamp. Place a thermometer on top of each piece of paper. Let it sit for 5 minutes.

Which piece of paper had a higher temperature? _____

Can using aluminum foil help your oven? How? _____

Using the answers above, design and label your solar oven.

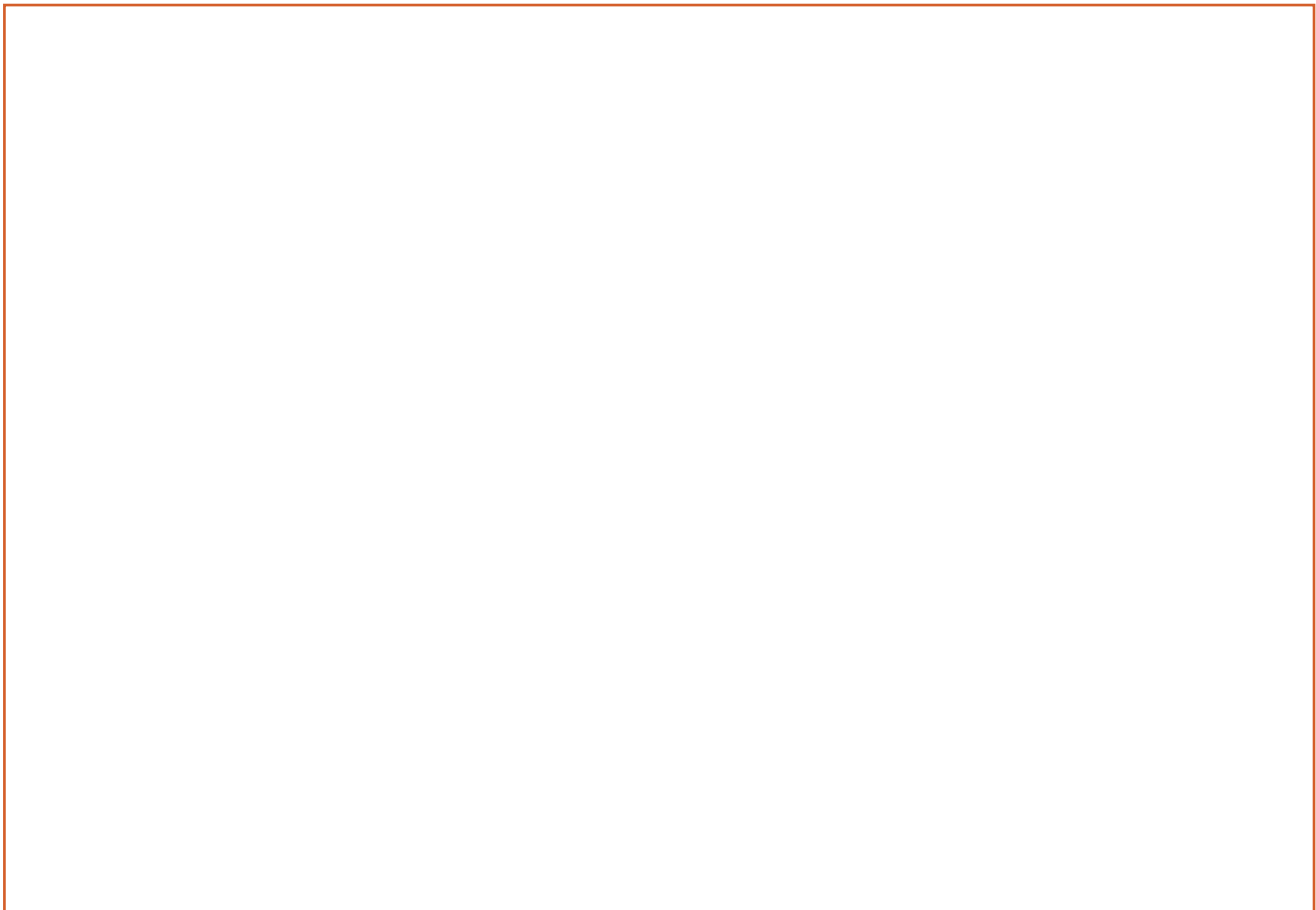

Build a Solar Oven
Student page

Approved by: _____

Experiment & Record

1. Using the materials provided, build your solar oven based on your design. Remember the goal is to capture heat in your oven to cook S'mores.
2. Place one S'more in the middle of the oven (1 graham cracker, 1 piece of chocolate, 1 marshmallow). Cover with plastic wrap and begin cooking.
3. Record the temperature every 30 seconds for ten and a half minutes. Record the temperature change in the table on the next page.

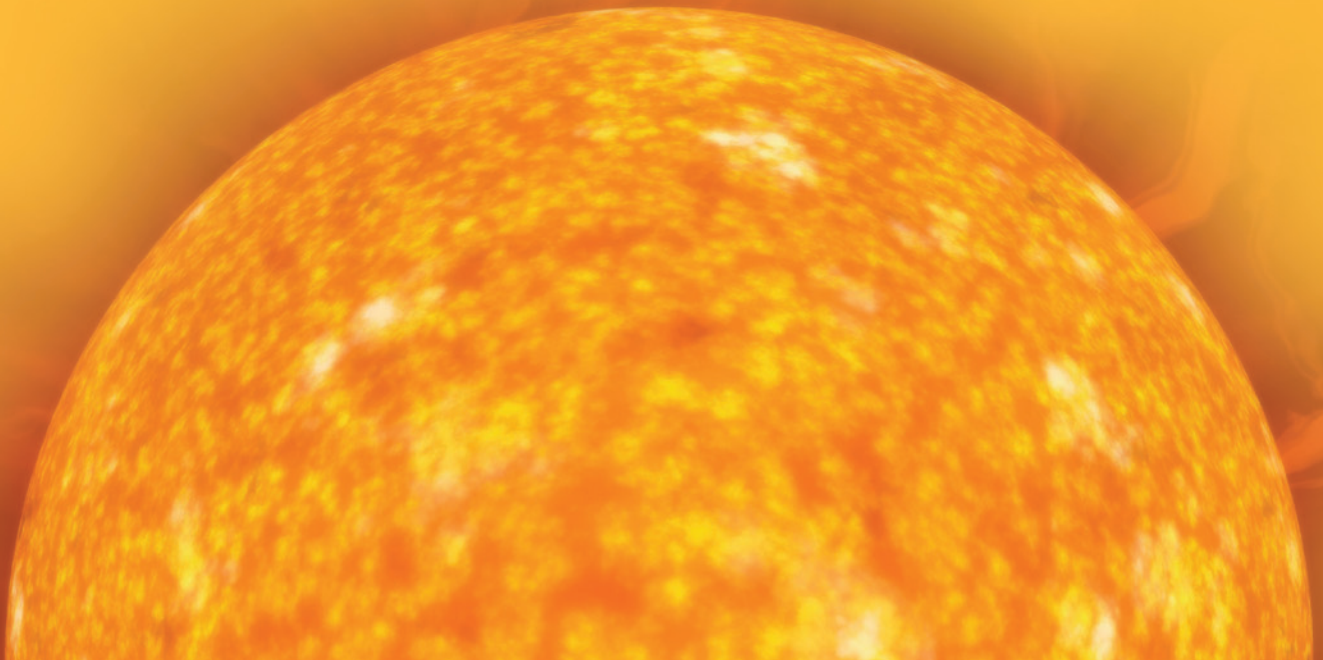

Solar Oven Data Table

Time Min:sec	Oven Temperature °C
0:00	
1:00	
2:00	
3:00	
4:00	
5:00	

Did your S'more melt? YES OR NO

If the answer is no, discuss with your team how to improve your solar oven. Make the changes on your drawing.

Build a Solar Oven
Student page

solar oven

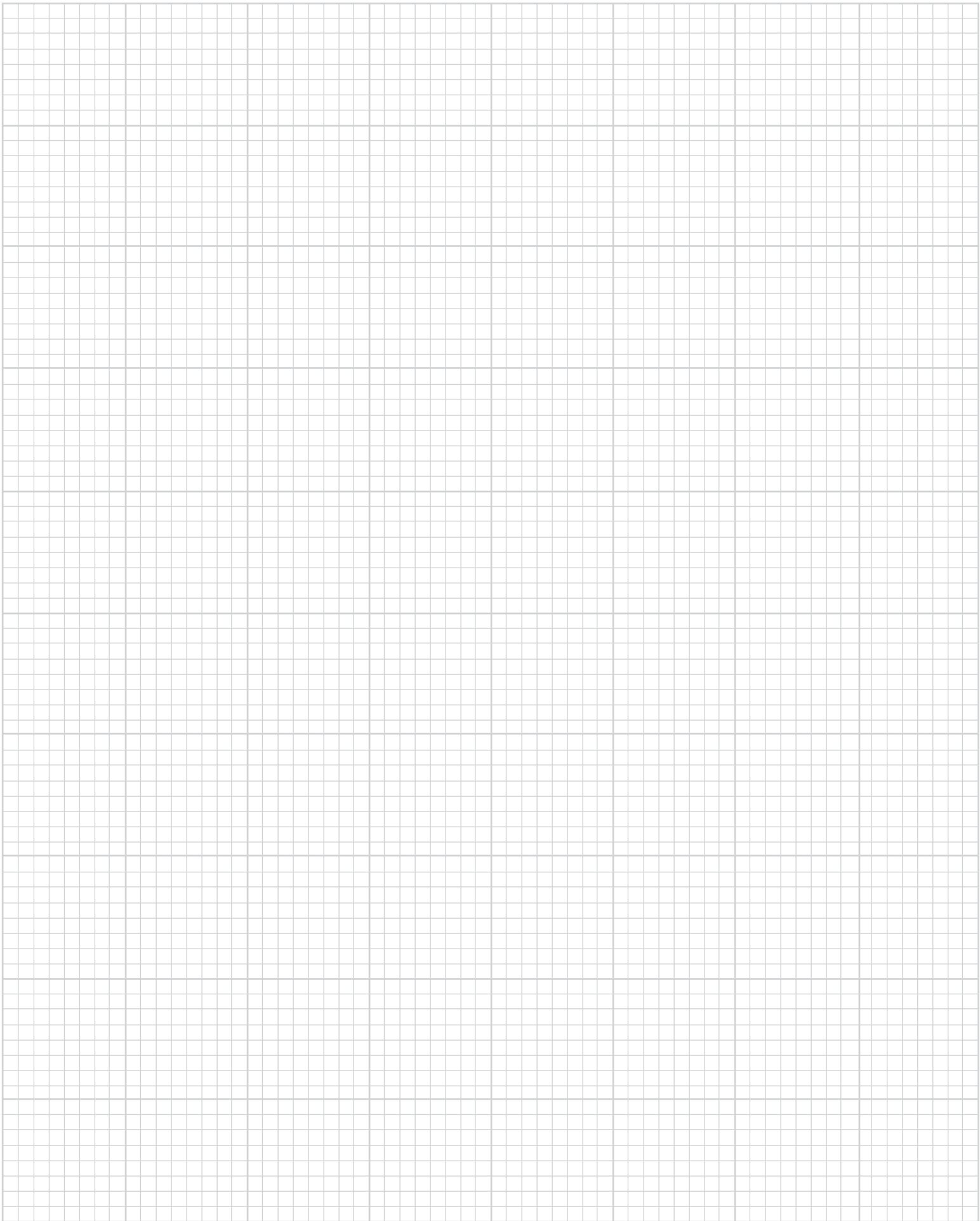

solar oven

ALIGNMENT TO NATIONAL STANDARDS

SCIENCE

Science as Inquiry

Develop abilities necessary to do scientific inquiry.

✓ ✓ ✓

Develop understanding about scientific inquiry.

✓ ✓ ✓

Science and Technology

Develop abilities to do technological design.

✓ ✓ ✓

Develop understanding about science and technology.

✓ ✓ ✓

History of Nature and Science

Develop understanding of science as a human endeavor.

✓ ✓ ✓

TECHNOLOGY & ENGINEERING

Creativity and Innovation

Apply existing knowledge to generate new ideas, products or processes.

✓ ✓ ✓

Create original works as a means of personal or group expression.

✓ ✓ ✓

Use models and simulations to explore complex systems and issues.

✓ ✓ ✓

Research and Information Fluency

Locate, organize, analyze, evaluate, synthesize and ethically use information from a variety of sources and media.

✓ ✓ ✓

Evaluate and select information sources and digital tools based on the appropriateness to specific tasks.

✓ ✓ ✓

Critical Thinking, Problem Solving, and Decision Making

Identify and define authentic problems and significant questions for investigation.

✓ ✓ ✓

Digital Citizenship

Exhibit a positive attitude toward using technology that supports collaboration, learning and productivity.

✓ ✓ ✓

MATHEMATICS

Numbers and Operations

Understand numbers, ways of representing numbers, relationships among numbers, and number systems.

Compute fluently and make reasonable estimates.

Count with understanding and recognize “how many” in sets of objects.

Connect number words and numerals to the quantities they represent, using various physical models and representations.

K	1	2
----------	----------	----------

	✓	✓
--	---	---

	✓	✓
--	---	---

✓	✓	✓
---	---	---

✓	✓	✓
---	---	---

Measurement

Understand measurable attributes of objects and the units, systems, and processes of measurement.

Apply appropriate techniques, tools, and formulas to determine measurements.

✓	✓	✓
---	---	---

✓	✓	✓
---	---	---

Data Analysis and Probability

Formulate questions that can be addressed with data and collect, organize, and display relevant data to answer them.

Develop and evaluate inferences and predictions that are based on data.

		✓
--	--	---

		✓
--	--	---

Problem Solving

Build new mathematical knowledge through problem solving.

Solve problems that arise in mathematical and in other contexts.

Apply and adapt a variety of appropriate strategies to solve problems.

✓	✓	
---	---	--

✓	✓	
---	---	--

✓	✓	
---	---	--

Communication

Communicate mathematical thinking coherently and clearly to peers, teachers and others.

Analyze and evaluate the mathematical thinking and strategies of others.

Use the language of mathematics to express mathematical ideas precisely.

✓	✓	✓
---	---	---

✓	✓	✓
---	---	---

✓	✓	✓
---	---	---

Connections

Recognize and apply mathematics in contexts outside of mathematics.

✓	✓	✓
---	---	---

ORIGINAL SOURCES

Launch Your Satellite adapted from **Rockets Educator Guide**:

www.nasa.gov/pdf/58269main_Rockets.Guide.pdf

Prepare for a Mission adapted from **Principles of Remote Exploration** at:

learners.gsfc.nasa.gov/PREP/

Design the new Crew Exploration Vehicle! adapted from **NASA's KSNTM 21st Century Explorer newsbreak "What will replace the space shuttle?"** at:

education.jsc.nasa.gov/explorers/pdf/p5_educator.pdf

Build a Solar Oven was adapted from **Lunar Nautics**, but is also a very popular activity found in many science textbooks:

www.nasa.gov/audience/foreducators/topnav/materials/listbytype/Lunar_Nautics_Designing_a_Mission.html

RECOMMENDED BOOKS AND VIDEOS

Need a little background information about the Moon, NASA History or earlier space exploration missions? Below is a suggested library list to help prepare you to provide answers to your students, or material to share with or recommend to your students to explore further. We thank our friends at St. Michael School in Hudson, MA for compiling this comprehensive list.

Adamson, Thomas K. **First Moon Landing.** Mankato, Minn: Capstone, 2007. Print. *The story of the first landing of men on the Moon in July of 1969. Picture book.*

Aguilar, David A. **11 Planets: A New View of the Solar System.** Washington DC: National Geographic, 2008. Print. *Provides an introduction to the planets of the solar system, including the two new dwarf planets, Ceres and Eris.*

Aldrin, Buzz. **Reaching for the Moon.** New York: Harper Collins, 2005. Print. *An Apollo 11 astronaut takes readers on his journey that began in his childhood and led him to achieve his dream of walking on the Moon, bringing to life an unparalleled moment in history for a new generation and showing how everyone can strive to achieve their dreams.*

AstroPuppies in Space. Dir. Tim Tully. 2009. Universe Productions, 2009. DVD. *Dramatic NASA videos and stunning photos from the Hubble Space Telescope are blended with puppetry and instructive animations, songs, and poems. This is an entertaining and educational introduction to astronomy and space exploration for young children. (Amazon)*

Bell, Jim. **Mars 3-D: A Rover's-Eye View of the Red Planet.** New York: Sterling, 2009. Print. *Presents the harsh landscape of the Red Planet through 3-D and color images from the robotic explorers Spirit and Opportunity; provides a close-up look at the Martian rocks, craters, valleys, and other geologic configurations.*

Bennett, Jeffrey. **Max Goes to Mars: A Science Adventure With Max the Dog.** Boulder, Colorado: Big Kid Science, 2006. Print. *When Max the dog becomes the first canine to embark on a mission to Mars, he makes one of the most important discoveries of all time, in a book that includes facts about Mars.*

Bennett, Jeffrey. **Max Goes to the Moon: A Science Adventure With Max the Dog.** Boulder, Colorado: Big Kid Science, 2003. Print. *Taking the first trip to the Moon since the Apollo missions, Max the dog and his friend Tori help set up the first colony on the Moon.*

Bunting, Eve. **My Robot.** Orlando, FL: Harcourt, 2006. Print. *Cecil the robot is good at playing tag, leading the school band, and performing tricks with the dog, but there is one important thing he does best of all.*

Chaikin, Andrew. **Voices from the Moon: Apollo Astronauts Describe Their Lunar Experiences.** New York: Viking, 2009. Print. *Provides recollections from Apollo astronauts and a collection of photographs that document the history of the Apollo space program.*

Chaikin, Andrew, Victoria Kohl, and Alan Bean. **Mission Control, This Is Apollo: The Story of the First Voyages to the Moon.** New York: Penguin Group, 2009. Print. *Discusses the historic moment in 1969 when Apollo 11 landed on the Moon, the major events that led up to this mission, and the advancements that have been made in space exploration from the Mercury missions to the present day.*

- Cobb, Vicki. **I Fall Down**. New York: Harper Collins, 2004. Print. *Hands-on experimentation and fun facts provide beginning readers with a simple introduction to the concept of gravity in terms of how it works, why it works, and its importance in our everyday lives.*
- Crelin, Bob. **Faces of the Moon**. Watertown, MA: Charlesbridge, 2009. Print. *Describes the Moon's phases as it orbits the Earth every 29 days using rhyming text and cut-outs that illustrate each phase.*
- Dahl, Michael. **On the Launch Pad : A Counting Book About Rockets**. Minneapolis, Minn.: Picture Window Books, 2004. Print. *A countdown from twelve to one as a space shuttle awaits liftoff.*
- Dean, James, et al. **NASA/Art: 50 Years of Exploration**. New York: Abrams: In association with NASA and the Smithsonian Institution, 2008. Print. *Ranging from the establishment of NASA in 1958 to the present day, the history of space exploration is chronicled through the work of some of the world's most renowned artists, including Robert Rauschenberg, Andy Warhol, Norman Rockwell, James Wyeth, Alexander Calder, Nam June Paik, William Wegman, and Annie Leibovitz, among others.*
- Floca, Brian. **Moonshot: The Flight of Apollo 11**. New York: Atheneum Books for Young Readers, 2008. Print. *From putting on their special uniforms and strapping themselves down in their seats to shooting off into the sky and floating about in space, this informative picture book provides an up-close look at this historic mission to the Moon that took place forty years ago.*
- Glatzer, Jenna. **Exploration of the Moon: How American Astronauts Traveled 240,000 Miles to the Moon and Back, and the Fascinating Things They Found There**. Philadelphia: Mason Crest Pub., 2003. Print. *Discusses the Apollo space program of the 1960s and later unmanned NASA probes of the Moon and describes the effects of space flight on the astronauts and some of what has been learned about the moon.*
- "**The Great Robot Race: The DARPA Grand Challenge.**" NOVA. PBS. WGBH, Boston, 18 Mar. 2006. Television. *This Nova episode shows the real race of driverless vehicles crossing 130 miles of the Mojave Desert.*
- Henderson, Harry. **Modern Robotics : Building Versatile Machines**. New York: Chelsea House, 2006. Print. *Profiles eleven individuals, including mathematicians, engineers, and inventors, who have greatly influenced the field of robotics, focusing on their struggle to accomplish what they have.*
- Hyland, Tony. **How Robots Work**. North Mankato, Minn.: Smart Apple Media, 2008. Print. *Describes the kinds of jobs that robots are programmed to do and explains how they work, including how they move, sense the outside world, express feelings, and solve problems.*
- "**In the Shadow of the Moon.**" Dir. Ron Howard. 11-7-07. Lionsgate Entertainment, 02-22-08. DVD. *IN THE SHADOW OF THE MOON is an intimate epic, which vividly communicates the daring and the danger, the pride and the passion, of this extraordinary era in American history. Between 1968 and 1972, the world watched in awe each time an American spacecraft voyaged to the Moon. Only 12 American men walked upon its surface and they remain the only human beings to have stood on another world. IN THE SHADOW OF THE MOON combines archival material from the original NASA film footage, much of it never before seen, with interviews with the surviving astronauts, including Jim Lovell (Apollo 8 and 13), Dave Scott (Apollo 9 and 15), John Young (Apollo 10 and 16), Gene Cernan (Apollo 10 and 17), Mike Collins (Apollo 11), Buzz Aldrin (Apollo 11), Alan Bean (Apollo 12), Edgar Mitchell (Apollo 14), Charlie Duke (Apollo 16) and Harrison Schmitt (Apollo 17). The astronauts emerge as eloquent, witty, emotional and very human.* (Amazon)

- “Is There Life on Mars?”** NOVA. PBS. WGBH, Boston, 30 Nov. 2008. Television. *Four years after they landed on Mars, NASA’s twin robot explorers, Spirit and Opportunity, have lasted 16 times longer and driven 20 times farther than expected. Today they are joined by an aerial armada of hi-tech satellites, surveying Mars from orbit to reconstruct the planet’s mysterious history. And on May 25, 2008, they also got company on the ground: NASA’s Phoenix probe. NOVA’s Is There Life on Mars? showcases the latest scientific revelations from a planet, once alien, now poised to reveal provocative new clues in the tantalizing quest to plumb its past for signs of water and, perhaps, even life.* (Amazon)
- Jedicke, Peter. **Great Moments in Space Exploration.** New York: Chelsea House, 2007. Print. *Describes the steps taken in the history of space exploration, from the development of rockets and satellites to manned space flight and robot rovers.*
- Jefferis, David. **Space Probes: Exploring Beyond Earth.** New York: Crabtree, 2009. Print. *Introduces space probes and explains how they monitor the planets and other bodies in the solar system.*
- Kerley, Barbara. **Greetings from Planet Earth.** New York: Scholastic, 2007. Print. *Set in 1977, Theo is inspired to do a class project based on space exploration and life on Earth, thus leading him to think about his own life, the mystery surrounding his father in Vietnam, and possibly painful family secrets held by his mother.*
- Marino, Nan. **Neil Armstrong Is My Uncle & Other Lies Muscle Man McGinty Told Me.** New York: Roaring Brook Press, 2009. Print. *Tamara dreams of the day when ten-year-old Muscle Man McGinty’s constant lies catch up to him, but when an incredible event takes place in the summer of 1969, her outlook on life is altered in the most surprising way.*
- McCarthy, Meghan. **Astronaut Handbook.** New York: Knopf, 2008. Print. *Journey aboard the “Vomit Comet” where the students of an astronaut school learn what it is like to do this exciting job by experiencing weightlessness, getting their measurements taken for a space suit, and performing a space walk!*
- Moon Machines.** Science Channel: A Discovery Company. 16 June 2008. Television. *The right tools for the job... The U.S. Moon missions would never have gotten 10 feet off the ground without the pioneering engineers and manufacturers and the amazing machines they created to turn science fiction into history-making headlines. From nuts and bolts to rockets and life support systems, every piece of gear was custom made from scratch to perform cutting-edge scientific tasks while withstanding the violent rigors of space travel. Now here’s your chance to climb aboard the capsule, put on a spacesuit and learn the real stories behind the right stuff.* (Amazon)
- Piddock, Charles. **Future Tech: From Personal Robots to Motorized Monocycles.** Washington DC: National Geographic, 2009. Print. *Explores the latest advances in technology and looks at future developments in robotics, medicine, transportation, and family life.*
- Platt, Richard, and David Hawcock. **Moon Landing.** Somerville, MA: Candlewick Press, 2008. Print. *A pop-up celebration of Moon exploration recreates the excitement of humankind’s dreams of traveling to the Moon, the race to conquer space, the technology needed to reach the Moon and sustain the astronauts in space, and the first Moon landing itself.*
- Potter, Frank, and Christopher P Jargodzki, **Mad About Modern Physics: Braintwisters, Paradoxes, and Curiosities.** Hoboken, NJ: J Wiley, 2005. Print.

- Prochnow, Dave. **101 Outer Space Projects for the Evil Genius**. New York: McGraw-Hill, 2007. Print. *Describes projects, from model rockets and telescopes to star maps and home planetariums, related to the field of astronomy.*
- Pyle, Rod. **Destination Moon: The Apollo Missions in the Astronauts' Own Words**. New York: Harper Collins, 2005. Print. *Encompassing the firsthand accounts of the astronauts and other participants, a complete history of NASA's Apollo program includes coverage of the Apollo 11 Moon landing and the near-catastrophic Apollo 13 mission.*
- Rinard, Judith. **Book of Flight: The Smithsonian National Air and Space Museum**. Buffalo, NY: Firefly Books, 2007. Print. *The major milestones in flight history illustrated from the collections of the National Air and Space Museum. Includes the development of flight and diagrams explaining flight science and technology.*
- Siy, Alexandra. **Cars on Mars: Roving the Red Planet**. Watertown, MA: Charlesbridge, 2009. Print. *Presents an introduction to the Mars Exploration Rovers (MERS), "Spirit" and "Opportunity," with photographs of the Mars landscape taken over a five-year period as the rovers searched for water on the red planet.*
- Stone, Jerry. **One Small Step: Celebrating the First Men on the Moon**. New York: Henry Holt, 2009. Print. *A celebration of the fortieth anniversary of the Apollo 11 Moon landing is a collection of keepsakes and memories that bring America's historic moment of pride and accomplishment to life for a new generation.*
- Stone, Tanya Lee. **Almost Astronauts: 13 Women Who Dared To Dream**. Somerville, MA: Candlewick Press, 2009. Print. *Presents the story of the thirteen women connected with NASA's Mercury 13 space mission, who braved prejudice and jealousy to make their mark and open the door for the female pilots and space commanders that would soon follow.*
- Thimmesh, Catherine. **Team Moon : How 400,000 People Landed Apollo 11 on the Moon**. Boston: Houghton Mifflin, 2006. Print. *From the engineers to the suit testers, the story of the many people in various professions who worked behind-the-scenes to get Apollo 11 on the Moon and safely back is presented through quotes, transcripts, national archives, and NASA photos.*
- Tiner, John Hudson. **100 Scientists Who Shaped World History**. San Mateo, CA: Bluewood Books, 2000. Print. *Profiles the scientists who made significant contributions, describes their failures and accomplishments, and explains how they impacted science and society.*
- Todd, Traci. **A Is for Astronaut: Exploring Space from A to Z**. San Francisco: Chronicle Books, 2006. Print. *Provides simple information about space arranged in alphabetical order with vintage and contemporary photographs, including pictures of Ham, the first chimpanzee in space and Neil Armstrong, the first astronaut to walk on the Moon.*
- VanCleave, Janice Pratt. **Engineering for Every Kid: Easy Activities That Make Learning Science Fun**. San Francisco: Jossey-Bass, 2006. Print. *Explains some of the basic physical principles of engineering, accompanied by activities that illustrate those principles.*
- Van Der Linden, F. Robert. **Best of the National Air and Space Museum**. New York: Harper Collins, 2006. Print. *A photographic tour of some of the top displays from the National Air and Space Museum is complemented by information on each item's history, design, and purpose.*

When We Left Earth. Discovery. June 2008. Television. *Since the dawn of mankind, we have stared up at the lights in the sky and wondered... Now join the heroic men and women who have dared the impossible on some of the greatest adventures ever undertaken - the quest to reach out beyond Earth and into the great unknown of space! To celebrate 50 years of incredible achievements, the Discovery Channel has partnered with NASA to reveal the epic struggles, tragedies and triumphs in a bold chapter of human history. Along with the candid interviews of the people who made it happen, hundreds of hours of never-before-seen film footage from the NASA archives - including sequences on board the actual spacecraft in flight - have been carefully restored, edited and compiled for this landmark collection.* (Amazon)

- - -. **Robots at Work and Play.** North Mankato, Minn: Smart Apple Media, 2008. Print. *Describes how robots can be used to perform work and provide entertainment.*

- - -. **Space Robots.** North Mankato, Minn.: Smart Apple Media, 2008. Print. *Describes how robots have been and will be used to explore the Moon, Mars, and other planets and how they can be used to assist humans during manned missions into space.*

- - -. **Moon 3-d : The Lunar Surface Come to Life.** New York: Sterling, 2009. Print. *Presents a history of the exploration of the Moon along with a collection of 3-D images that can be seen with the provided special glasses.*

***All annotations of books supplied by Baker and Taylor School Selection*

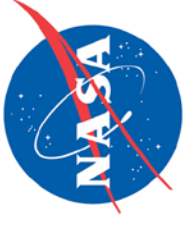

This certifies that

is officially a NASA's BEST STUDENT!

For achievement in understanding and
applying the Engineering Design Process

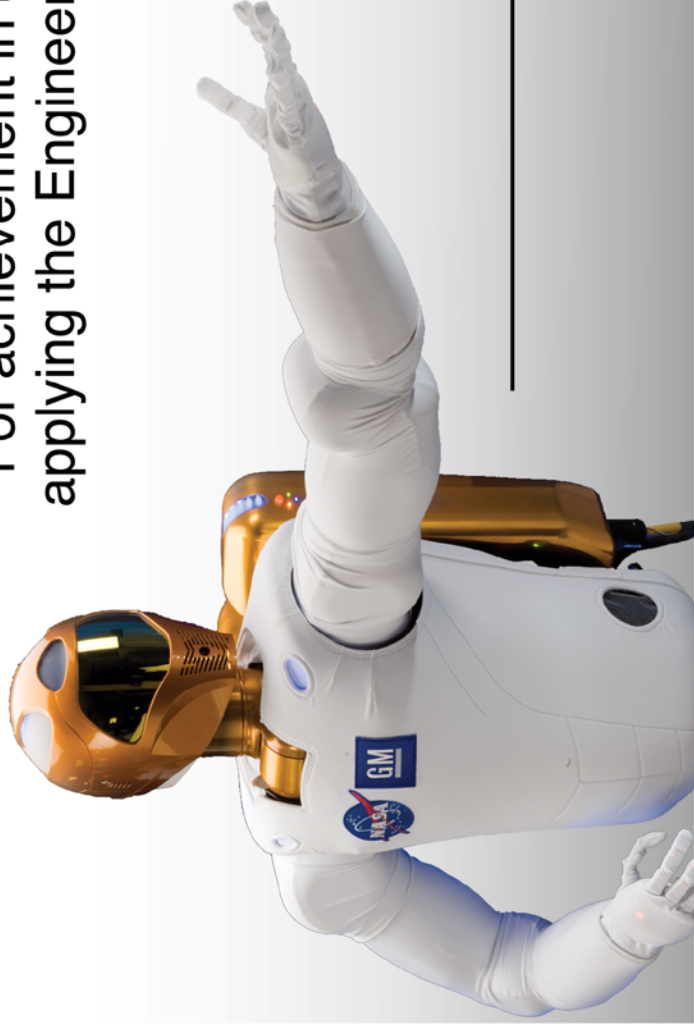

BEST

BEGINNING
ENGINEERING,
SCIENCE,
AND TECHNOLOGY

