

Originally Processed With FOIA(s):

S

FOIA Number:

S

# FOIA MARKER

**This is not a textual record. This is used as an administrative marker by the George Bush Presidential Library Staff.**

---

**Record Group/Collection:** George H.W. Bush Presidential Records  
**Collection/Office of Origin:** Speechwriting, White House Office of  
**Series:** Speech File Backup Files  
**Subseries:** Chron File, 1989-1993

---

**OA/ID Number:** 13821  
**Folder ID Number:** 13821-007

---

**Folder Title:**  
Provo, [UT] Rally 7/18/92 [OA 7575] [1]

---

---

| Stack:   | Row:      | Section:  | Shelf:   | Position: |
|----------|-----------|-----------|----------|-----------|
| <b>G</b> | <b>26</b> | <b>22</b> | <b>6</b> | <b>4</b>  |

---

UTAH

Mayor of Provo.

801-379-6180

→ Raylene Ireland

POB. 1849

846803

Gov. Bangerter's office

801-538-1000

Steve McKam - Chief of Staff

Hester - press secretary

→ Debbie Turner - 624-7704

GOP CHM - 7 BRUCE ROBERT (HART)

0 - 801-254-9340

11 - 801-254-2658

GOP HQ - 801-533-9777

GOP HEADQUARTERS

→ EXEC. DIR. - DAVID HANSEN

801-533-9777

EX David 2 to CM

Audience of through  
Utah Valley - not just  
Provo - 23,000 people  
out of tickets by mass today -

Nexis  
Lexis  
DNC  
Platform  
Mention  
of God  
Bingo

Debbie Turner, Dir.  
State of Utah  
Wash. of R. of Gov.  
444 N. Capitol St. Suite 204  
WDC 20001

As Delivered  
379-6107 (fax)  
(801)

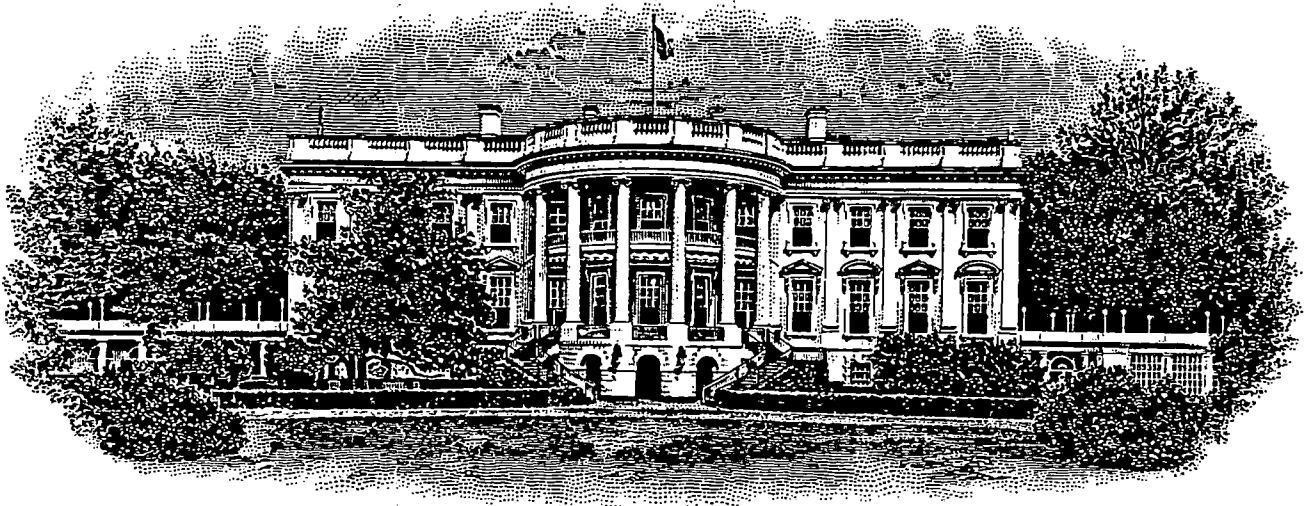

## OFFICE OF PRESIDENTIAL SPEECHWRITING

### FACSIMILE TRANSMITTAL SHEET

Number of Pages (Including Cover) 6  
To RAYLENE IRELAND  
Fax Number 801-379-6107  
Date 27 JULY 1992  
From JEANNIE BUNTON  
Office Number 202-456-7750

\*\*\*\*\*

COMMENTS

\*\*\*\*\*

*As promised. Many thanks.  
I'm grateful for all of your help.  
Hope to one day visit Ford!*

17 July 1992

MEMORANDUM FOR STEVE PROVOST  
CHRISTINA MARTIN

FROM: JEANNIE BUNTON 

SUBJECT: **FACT CHECK CHANGES [UTAH]**

DNC PLATFORM: Paula Nowlankowski, dir of research at RNC [202-863-8018] said "can neither deny or confirm that the final DNC Platform as approved at convention has God in it. She said the Dems did reject referencing God in the platform during the hearing process. See attached Washington Times article.

[p. 8 staffed version]

David O. McKay quote should read:

"No other success can compensate for failure in the home."

We found that he said it, can't confirm when -- he was president of the Church of Jesus Christ of Latter Day Saints 1953-1970.

[p. 10 staffed version]

Those of you at BYU ... are here to be [delete specific reference to summer school program because that is the motto for the entire university, not just the summer school program].

MISC.

The Brady Bunch went off the air in 1973 / re-runs started in 1976-77. So factually we're ok with that one.

ACKS: we need to mention the BYU faculty -- according to advance there will be some faculty in audience -- 24 people on DAIS.

Richard Harrington will be at event according to advance, as well as Lt. Gov. Val Oveson, and Gov. Bangerter.

Sen. Garn is retiring this year. Sen. Hatch is not.

Agree with Gray to drop "WordPerf" ref. accomplish the same point without mentioning them specifically -- especially since there are other computer company headquarters in the Utah Valley -- this way we don't offend anyone.

"Rise and Shout" is the chorsu to the BYU fight song: Rise and Shout -- the Cougars are out -- and on the trail to glory -- would prob. get a favorable response from students in audience

####

THE WHITE HOUSE

Office of the Press Secretary  
(Salt Lake City, Utah)

For Immediate Release

July 18, 1992

REMARKS BY THE PRESIDENT  
TO BRIGHAM YOUNG UNIVERSITY AND PROVO COMMUNITY

Marriott Center  
Brigham Young University  
Provo, Utah

11:20 A.M. MDT

THE PRESIDENT: Thank you very much. (Applause.) Thank you all for that warm welcome. And may I just single out your President -- Mr. President -- it sounds pretty good, doesn't it, for Rex -- but to say to Rex Lee that I am delighted to have been introduced by him, a man who has served, first, his government with such great distinction, integrity and honor; and now serves this wonderful university in a position of extraordinary leadership. (Applause.)

Allow me for a moment just to acknowledge Senator Hatch; Governor Norman Bangertter, my friend over here; Val Oveson, Lieutenant Governor; Mayor Joseph Jenkins. And may I just suggest that it is appropriate that I pay, and you all pay, a special tribute to Senator Jake Garn who's retiring this fall, after years of dedicated service to Utah and the entire nation. (Applause.)

And again, to President Lee and Provo's Hafen, and Ron Hyde and Dee Anderson, BYU Vice President, let me just say thank you for inviting me here today. More than that, I want to thank you for extending an invitation to all the presidential candidates to come to BYU and share their views. And this is appropriate -- the university not pulling back but permitting people to have a fair say in this important election year. And I salute you for that. (Applause.)

I noticed that on your seal it says that "The glory of God is intelligence." I would add that intelligence and education are absolutely necessary to fulfill your democratic obligation. So I salute you for your desire to learn more about all our candidates and where we want to lead this great nation. (Applause.)

And in this spirit of free speech let me register one strongly-held view. I want to change things. And one thing I want to change is the control of the House of Representatives in Washington. (Applause.) For 35 -- you talk about change -- for 35 years, 36, one party has controlled that one institution, the House of Representatives. And enough of these bank scandals and post office scandals. We've got to change control, and that's why I want Richard Harrington in the United States Congress. (Applause.)

Let me say I agree with him on this, and with the senators, that a strong America has led the world to change. And we have not surrendered one single ounce of our sovereignty. We are the leader of the free world, undisputed, on our terms. We're the United States of America. (Applause.)

You know, BYU is a special place, of physical beauty and spiritual strength. (Applause.) A place devoted to a simple creed: "Enter to learn. Go forth to serve." I happen to believe that there is no higher calling than serving humanity. So I say thank you for choosing BYU. This home of the Cougars

MORE

feels like my home. And thanks for that warm welcome.  
(Applause.)

I spent two days this past week far away from TV and radio. Didn't listen -- watch one or listen to the other -- up in Wyoming, trout fishing with Secretary of State Jim Baker, and our sons, Jamie and Jeb. But I'm aware that something else was going on in America this week. (Laughter.) Something real important. This is the week when all across America, crowds of panting, sweating people overran their neighborhood video stores. (Laughter and applause.)

From Tallahassee to Tempe, Americans turned on their TV and decided they'd rather watch "Action Jackson" than listen to -- well, never mind. (Applause.) Now, look, don't get the idea that this is some kind of partisan attack. (Laughter.) Stop by Rich's Video down on Freedom Boulevard -- (applause) -- and I'm sure Rich will tell you, give it to you straight. Sales aren't all that bad during the Republican Convention either. (Laughter.) So I want to be fair about this. (Applause.)

I didn't get a chance, as I said, to see the other party on TV. But I couldn't help but notice one little comment made by one of the conventioners. It was made by a man named McGovern. First name, same as mine, George. You remember him? Over the years Mr. McGovern hasn't always been my biggest fan. (Laughter.) So I was kind of surprised by what he said in the newspaper. He called this year's Democratic ticket "a Trojan horse." And he said -- and I quote -- "They're much more liberal underneath and will prove it when they're elected." Now, I know I've never said this publicly, but, one, they won't be elected, and George McGovern is an incredibly insightful man. (Laughter and applause.)

You may not believe this, but that's all I'm going to say about the other party. You didn't invite me here to talk about the other side. You want to know what I have to offer and what I believe and what's in my heart. (Applause.) Let me just start by explaining a little bit about where I see America today.

Here at BYU you like to say that the world is your campus. Your president telling me about the numbers of foreign languages that are taught and spoken by the students on this campus. Well, that campus, internationally, has been through incredible change in four years. Because of our leadership, because of America's sacrifice and commitment, millions more people breathe free today. (Applause.)

When you go to bed tonight you can sleep knowing that we are safer from nuclear destruction. Safer than we were a decade ago. Safer than we were a year ago. Safer than we were even a month ago, before I met with Boris Yeltsin in the White House to get rid of some of these nuclear weapons. (Applause.)

But this new world that we live in poses new challenges and new opportunities. The challenge is this: Can we compete now that so many other nations are playing our game? It's a tough question. But since the answer is, inevitably, yes, consider the opportunity we face.

More of the world's people hungry for our products. More of the world's people eager for our services. More good jobs for you and all your classmates. What do we need to take advantage of this opportunity? The same values, the same principles, the same ideas, that we used to change the world.

To start, I believe we need to get to work today to create more opportunity for more people. You can't build a home without a hammer, and you can't build a dream without a job.  
(Applause.)

MORE

Work isn't just good for our wallets. Work elevates us. It teaches us values. It gives us purpose. Some people tear down our economy and they say we're second-rate, second-class. But keep in mind just a few facts. We are still the world's largest and most vibrant economy. We've tamed the lion of inflation. And consider this: The last time interest rates stayed this low the Brady Bunch wasn't even on TV yet. (Applause.)

Our factories produce a higher percentage of the world's manufactured goods than we did 20 years ago. And we've emerged as the world's export champion. Last year the Japanese government asked who leads the world in 143 critical technology industries. Japanese firms led in 33 and the United States in 43. And I wouldn't be surprised to learn if that report was put together on software made right here in Utah. (Applause.)

But while our economy is growing today it's not growing fast enough. Many of you are working your way through this great university. When you graduate you don't want to get letters that say: "We'll keep your resume on file." You want letters that say: "How fast can you get here and take the job?"

I used to run a business and meet a payroll. I learned the only way government can create jobs is to help the people who create jobs. (Applause.) That means providing incentives so that businesses can create jobs. And it means getting our own house in order by making like Paul Bunyon and taking an axe to the rotting tree that is the federal budget deficit. (Applause.)

Governor Norm Bangerter, just back from a trip to St. Petersburg, to Russia, came to have breakfast this morning. And this is his philosophy; it's the philosophy that Governor Bangerter follows and Utah follows. And we've got to bring some of that Utah attitude to Washington, D.C. (Applause.) And like your Governor, we need a line-item veto, and we're going to get it. We're going to get the American people to insist we have it. (Applause.)

And like you, we need a balanced budget amendment to the Constitution. And we're going to get that, too. (Applause.)

Thirty-one times in the past three years I've had to wield my veto pen -- many times to cut away wasteful government spending. And with the help of Senator Orrin Hatch and then a new Congress coming in with him, we're going to continue to stand on principle and protect your pocketbooks. And we're going to treat wasteful spending the way Carl Malone will treat other teams' jump shot in Barcelona. (Applause.) We're going to swat it into the front row. (Laughter.)

And I also believe that we need to restore the special values that have carried this nation for 200 years. Americans need to understand something that you all know very, very well and that your lives epitomize. No other success can compensate for failure in the home. (Applause.)

David O. McKay's words harken back to a different age. And today we can fly from Paris to New York and arrive earlier than we left. (Laughter.) But do we too often leave behind the difference between right and wrong? We can explore a world beyond the stars, but do we too often ignore a neighbor down the street? We can turn natural ingredients into miracle medicines, but why do we feel the need to turn every argument into a lawsuit? (Applause.)

And by the way, I am not going to give up, I'm going to continue to fight for legislation that puts a stop to all these frivolous lawsuits. (Applause.) We need to give doctors the chance to practice medicine, dads and moms to coach Little League without worrying that they're going to end up in a courtroom every single week. (Applause.)

So where do we get our traditional values? Where do we get our traditional values? We learn them in our living rooms and in our churches. And while religion and families help keep our lives together, government can help keep our families together. Government can reward work, not welfare dependency. Welfare programs can and must encourage families not to fall apart, but to stay together. (Applause.)

And government can and must, in my view, give families in Utah and every other state the option of deciding where their kids are educated. (Applause.) Whether it's a public school, a private school or a church school -- it doesn't matter -- let the parents choose. That is the American way. (Applause.)

And I also believe we need to restore respect for the law. Peace in the world, it's fine but it's not enough. And if people don't feel safe in their own backyard, it doesn't seem to matter. What do you say to an elderly woman who watches the Berlin Wall fall on television right before her eyes, but is afraid to walk into her neighborhood grocery store? What do you say to kids in our cities who hear of the Russians reducing nuclear weapons, but then have to walk through a metal detector at school every single morning? What do you say to these Americans? You say enough is enough. And let's put an end to the lawlessness. And let's get rid of the drugs. And let's say "sayonara" to the crack dealers and the criminals. (Applause.)

We can help with legislation. You can help in your neighborhoods and your local institutions. But let's pledge to make America safe again. (Applause.)

As you know, this has been an important week in American politics for a couple of reasons. I met a guy in Wyoming yesterday who noted that the week I went fishing, one of my opponents dropped out of the race. And he wondered if I wanted to stay out West and bag another trophy hunting next week. (Laughter.)

But let me just make a serious observation. It's easy for me to stand here as an incumbent President of the United States and quietly applaud Ross Perot's withdrawal from the campaign -- but to salute the fact that this strange political year is suddenly much more "normal." But I can't do that. The fervor of the Perot supporters, of those sensational volunteers transcends politics as usual.

And there was an election in America this summer -- no ballots cast, no polls open, but a referendum took place nonetheless. Nobody won, but politics lost. And politics lost because it is becoming irrelevant to more and more Americans. And for too many people, politics is now the opposite of progress. (Applause.) And so my message to anyone dissatisfied with America is this: Don't quit. Don't walk away from the system. Don't believe that because there's no protest vote you have no vote at all.

Ross Perot's supporters believe in the same principles in which I believe -- about cutting the size of government, about letting parents choose their kids' day care and high schools. And most of all, we agree about the need to break the deadlock in Washington, D.C. (Applause.)

And it is time to say so long to politics as usual. And more than that, it's high time to shake up the system. And if you'll excuse just one more political observation, you give me a Congress that shares my values and your values and you'd see this system not just shaken, but rattled and even rolled. (Applause.) And you will see real progress in our great country.

And I know that Provo is one of America's youngest cities. For years, more babies were born at Utah Valley Hospital

MORE

than any other hospital in America. (Applause.) More than most hospitals in the world. (Laughter.) And I heard from some not-so-reliable sources that lately some hospitals way up in northern Europe are surpassing your birth rates. But I guess that in Utah babies are born because of hope. Well, way up in northern Europe they are born because of hope and weather. (Laughter.)

Now, as I look out on this audience today, my guess is you're probably asking the question that every young generation asks: Will the future be bright? Will the dream stay alive? And despite all our challenges, I am betting on America. And I know you are, too.

I still believe -- I still believe in America's capacity to confront any challenge and seize any opportunity. And if we can topple the Berlin Wall, and if we can reduce the threat of nuclear weapons, and if we can do those things, we can build a strong economy and we can -- and if we can lift that Iron Curtain, we can bring the curtain down on immorality and indifference. (Applause.) And if we can help people walk free in Eastern Europe, we can take back the streets in the United States of America. (Applause.)

So this then is our mission. And this is our crusade. And together I am absolutely confident that we can get the job done for the United States of America.

God bless you. And may God bless our great country. Thank you very, very much. (Applause.)

END

11:45 A.M. MDT

THE WHITE HOUSE

WASHINGTON

SCHEDULE OF THE PRESIDENT

FOR

SALT LAKE CITY AND PROVO, UTAH

JULY 17 - 18, 1992

EVENTS:

Meeting with Mormon Church Leaders  
Meeting with Utah GOP Leaders  
Ask George Bush with Outdoor Groups  
Address to Brigham Young University and Provo Community

DRESS:

Men - Business Suit  
Women - Day Dress

CONTACT:

Office of Presidential Advance  
Ed Murnane - 202/456-7565

Trip Coordinator  
Suzanne Faulk - 202/456-7565

Salt Lake City, Utah, Signal - 801/531-3800  
- \*96/37-000

ADVANCE:

|                  |             |                 |        |
|------------------|-------------|-----------------|--------|
| Craig Ray        | - LEAD      | Dianne Harrison | -SITE  |
| Topper Ray       | - PRESS     | Bobby Peede     | -SITE  |
| Ed Skrodzki      | - USSS      | Heather Herring | -SITE  |
| Michelle Johnson | - MIL. AIDE | Dan McCardell   | -PRESS |
| Dave Miller      | - WHCA      |                 |        |
| Tom Armstrong    | - AFI       |                 |        |

|                |               |               |              |
|----------------|---------------|---------------|--------------|
| Kevin Hart     | - SITE PROVO  | Denise Dunkel | -PRESS PROVO |
| Hopson Nance   | - SITE PROVO  |               |              |
| Peter Gaillard | - PRESS PROVO |               |              |

WEATHER:

Partly Cloudy/high 70s

SCHEDULE OF THE PRESIDENT

FOR

SALT LAKE CITY AND PROVO, UTAH

JULY 17 - 18, 1992

1:45 pm  
(M.D.T.)

THE PRESIDENT arrives Salt Lake City International Airport, Salt Lake City, Utah and proceeds to Motorcade.

Met by:

The Honorable W. Val Oveson  
Lt. Governor of Utah

The Honorable Jake Garn  
United States Senator

The Honorable Orrin Hatch  
United States Senator

Mr. Bruce R. Hough  
State GOP Chairman

Ms. Bonnie H. Stephens  
Bush-Quayle Chairman

Mr. Christopher Cannon  
Victory '92 Finance Chairman

Mr. John Huntsman, Sr.  
Chairman of Huntsman Chemical Corp.

Mr. John Huntsman, Jr.  
Bush-Quayle Finance

Mr. John Price  
Bush/Quayle Supporter

Ms. Arlene Ellis  
National Committeewoman-Elect

**Daily Point of Light Greeters:**

Ms. Lillian Smith  
Volunteer Counselor and 694th Daily Point of Light

Mr. Dennis Hansen  
Guest of Ms. Smith

Mr. Dave Burton  
President, STARS and 786th Daily Point of Light

Ms. Pamela Hutchins  
Vice President, STARS and 786th Daily Point of  
Light

Mr. Pepper Provenzano  
President and Founder, TreeUtah and 712th Daily  
Point of Light

Mr. Leroy Hooten  
Guest of Mr. Provenzano

1:55 pm

THE PRESIDENT boards Motorcade and departs Salt  
Lake City International Airport en route Marriott  
Hotel.

**MOTORCADE ASSIGNMENTS:**

|           |  |
|-----------|--|
| Lead      | C. Ray   |
| Spare     | B. Farish<br>Doctor                                      |
| LIMO      | THE PRESIDENT  |
| Follow Up |  |
| Control   | S. Skinner<br>Adm. Howe<br>Mil. Aide                     |
| Support   | J. Smith<br>E. Murnane<br>Official Photographer<br>Medic |
| WHCA      | J. Gaughan   |
| Camera I  | J. Herrick   |

|              |                                       |
|--------------|---------------------------------------|
| Staff I      | R. Porter<br>S. Provost<br>R. Kaufman |
| Guest I      | B. Teeter                             |
| Camera II    |                                       |
| Wire I       |                                       |
| Wire II      |                                       |
| Staff Van    | All Remaining Staff                   |
| Guest Van    | All Remaining Guests                  |
| Press Van I  | M. Busch                              |
| Press Van II |                                       |

(Drive Time: 10 Minutes)

GUEST AND STAFF INSTRUCTIONS:

Upon arrival at Marriott Hotel, Guests and Staff should proceed to 14th Floor Foyer for Room Assignments and Keys.

Guests and Staff attending the meeting with Mormon Church Leaders should board Motorcade no later than 2:40 p.m.

2:05 pm

THE PRESIDENT arrives Marriott Hotel and proceeds to Suite.

Met by:

Mr. Steve Hart  
General Manager, Marriott Hotel

Mr. Steve Huey  
Director of Marketing, Marriott Hotel

Mr. Richard Boden  
Director of Security, Marriott Hotel

2:10 pm THE PRESIDENT arrives Suite for Private Time.

(PRIVATE TIME: 35 MINUTES)

2:45 pm THE PRESIDENT departs Suite and proceeds to Motorcade.

2:50 pm THE PRESIDENT boards Motorcade and departs Marriott Hotel en route Church of Jesus Christ of Latter Day Saints, Administration Building.

MOTORCADE ASSIGNMENTS:

Same as on Arrival.

(Drive Time: 5 Minutes)

GUEST AND STAFF INSTRUCTIONS:

Upon arrival at Church of Jesus Christ of Latter Day Saints, Guests and Staff will be escorted to Staff Holding Room.

Please board Motorcade no later than 3:40 pm for transport to the Marriott Hotel.

2:55 pm THE PRESIDENT arrives Church of Jesus Christ of Latter Day Saints, Administration Building and proceeds to North Board Room.

Met by:

Bruce L. Olsen  
Director, Public Affairs, Church of Latter Day Saints

EVENT: MEETING WITH MORMON CHURCH LEADERS

EXPANDED POOL (AT END ONLY)

3:00 pm THE PRESIDENT, accompanied by Mr. Olsen, arrives North Board Room, takes Seat and begins participation in Meeting.

Met by:

President Gordon B. Hinckley  
First Counselor, Church of Latter Day Saints

President Thomas S. Monson  
Second Counselor, Church of Latter Day Saints

3:45 pm THE PRESIDENT, accompanied by President Hinckley and President Monson, concludes participation in Meeting, departs North Board Room and proceeds to Motorcade.

NOTE: At the conclusion of the Meeting, THE PRESIDENT, accompanied by President Hinckley and President Monson, proceeds to Foyer for Photo Opportunity.

3:50 pm THE PRESIDENT boards Motorcade and departs Church of Jesus Christ of Latter Day Saints, Administration Building en route Marriott Hotel.

MOTORCADE ASSIGNMENTS:

Same as on Arrival.

(Drive Time: 5 Minutes)

GUESTS AND STAFF INSTRUCTIONS:

Upon on arrival at Marriott Hotel, Guests and Staff will be escorted to Salon J, Staff Holding Area.

3:55 pm THE PRESIDENT arrives Marriott Hotel and proceeds to Salon J.

EVENT: MEETING WITH UTAH GOP LEADERS

CLOSED PRESS

4:00 pm THE PRESIDENT arrives Salon J, takes Seat and begins participation in Meeting.

4:30 pm THE PRESIDENT concludes participation in Meeting, departs Salon J and proceeds to Suite.

4:35 pm THE PRESIDENT arrives Suite for RON.

RON Salt Lake City, Utah

Saturday, July 18, 1992

GUESTS AND STAFF INSTRUCTIONS:

5:00 am **Baggage Call.** Please place all unlocked baggage outside your room at this time.

8:40 am Guests and Staff should board Motorcade at this time for transport to Red Butte Gardens.

9:00 am Transportation to the Airport will be available for Guests and Staff not attending the Ask George Bush Event.

8:40 am

THE PRESIDENT departs Suite and proceeds to Motorcade.

NOTE: Six police photos will be taken at this time.

8:45 am

THE PRESIDENT boards Motorcade and departs Marriott Hotel en route Red Butte Gardens.

MOTORCADE ASSIGNMENTS:

|           |  |
|-----------|--|
| Lead      | C. Ray   |
| Spare     | B. Farish<br>Doctor  |
| LIMO      | THE PRESIDENT  |
| Follow Up |  |
| Control   | S. Skinner<br>Adm. Howe<br>Mil. Aide                         |
| Support   | M. Fitzwater<br>E. Murnane<br>Official Photographer<br>Medic |
| WHCA      | J. Gaughan   |
| Camera I  | J. Herrick   |
| Staff I   | R. Porter<br>S. Provost<br>R. Kaufman                        |
| Guest I   | R. Teeter  |
| Camera II |  |
| Wire I    |  |
| Wire II   |  |
| Staff Van | All Remaining Staff  |

|              |                      |
|--------------|----------------------|
| Guest Van    | All Remaining Guests |
| Press Van I  | M. Busch             |
| Press Van II |                      |

(Drive Time: 10 Minutes)

GUESTS AND STAFF INSTRUCTIONS:

Upon Arrival at Red Butte Gardens, Guests and Staff will be escorted to Holding Trailers and/or Staff Viewing Area.

Guests and Staff should board Motorcade no later than **9:25 am** for transport to Salt Lake City International Airport.

8:55 am THE PRESIDENT arrives Red Butte Gardens and proceeds to Water Pavilion Garden.

Met by:

Mr. and Mrs. Arthur K. Smith (June)  
President, University of Utah

Ms. Mary Pat Matheson  
Director, Red Butte Gardens and Arboretum

NOTE: Lt. Governor W. Val Oveson introduces THE PRESIDENT as he sees him approaching.

EVENT: ASK GEORGE BUSH WITH OUTDOOR GROUPS

EXPANDED POOL

9:00 am THE PRESIDENT, accompanied by Mr. and Mrs. Smith and Ms. Matheson, arrives Water Pavilion Garden, proceeds to Seat and begins participation in Ask George Bush.

9:30 am THE PRESIDENT concludes participation in Ask George Bush, departs Water Pavilion Garden and proceeds to Motorcade.

9:35 am THE PRESIDENT boards Motorcade and departs Red Butte Gardens en route Salt Lake City International Airport.

MOTORCADE ASSIGNMENTS:

Same as on Arrival.

(Drive Time: 15 Minutes)

9:50 am THE PRESIDENT arrives Salt Lake City International Airport and proceeds to board Air Force One (C - 20).

9:55 am (M.D.T.) THE PRESIDENT departs Salt Lake City, Utah en route Provo, Utah.

(Flying Time: 50 minutes)  
(Time Change: None)  
(Interchange: Yes C-9/C-20)  
(Food Service: Snacks)

10:45 am THE PRESIDENT arrives Provo Airport, Provo, Utah and proceeds to Motorcade.

Met by:

The Honorable Joseph Jenkins  
Mayor of Provo

Mr. Richard Harrington  
Republican nominee for Congress, 3rd District

The Honorable Gary Herbert  
Chairman, Utah County Board of Commissioners

Mr. Mike Stewart  
Salt Lake City Commissioner

Mr. Lewis Billings  
GOP County Chairman

Mr. Rex Lee  
President, Brigham Young University

Ms. Christine Fox  
Utah State Legislator

Mr. Blake Roney  
President, NuSkin

Mr. Frank Switter  
GOP Supporter

Ms. Pearl Rex  
GOP Volunteer

10:55 am

THE PRESIDENT departs Provo Airport en route  
Brigham Young University.

MOTORCADE ASSIGNMENTS:

|           |  |
|-----------|--|
| Lead      | C. Ray   |
| Spare     | B. Farish<br>Doctor  |
| LIMO      | THE PRESIDENT  |
| Follow Up |  |
| Control   | S. Skinner<br>Adm. Howe<br>Mil. Aide                         |
| Support   | M. Fitzwater<br>E. Murnane<br>Official Photographer<br>Medic |
| WHCA      | J. Gaughan   |
| Camera I  | J. Herrick   |
| Staff I   | R. Porter  |

|              |                      |
|--------------|----------------------|
|              | S. Provost           |
|              | R. Kaufman           |
| Guest I      | B. Teeter            |
| Camera II    |                      |
| Wire I       |                      |
| Wire II      |                      |
| Staff Van    | All Remaining Staff  |
| Guest Van    | All Remaining Guests |
| Press Van I  | M. Busch             |
| Press Van II |                      |

(Drive Time: 10 Minutes)

GUESTS AND STAFF INSTRUCTIONS:

Upon arrival at Brigham Young University Marriott Center, Guests and Staff will be escorted to Staff Holding Room and/or Staff Viewing Area.

Please board Motorcade no later than **11:35 am** for transport to Provo Airport.

11:05 am THE PRESIDENT arrives Brigham Young University Marriott Center and proceeds to Holding Room.

11:06 am THE PRESIDENT arrives Holding Room and holds briefly.

11:08 am THE PRESIDENT, accompanied by Mr. Lee, departs Holding Room and proceeds to Off-Stage Announcement Area.

11:09 am

THE PRESIDENT, accompanied by Mr. Lee, arrives Off-Stage Announcement Area and holds briefly.

NOTE: Dais Participants will be on Stage prior to THE PRESIDENT

EVENT: REMARKS TO STUDENTS AND FACULTY OF BRIGHAM YOUNG UNIVERSITY

OPEN PRESS

RUFFLES AND FLOURISHES

OFF-STAGE ANNOUNCEMENT

HAIL TO THE CHIEF

REMARKS

TELEPROMPTER

11:10 am

THE PRESIDENT, accompanied by President Rex Lee, is announced onto Stage and proceeds to Seat on Dais.

11:11 am

THE PRESIDENT is introduced for Remarks by President Lee.

11:15 am

THE PRESIDENT Remarks.

11:35 am

THE PRESIDENT concludes remarks and returns to Seat on Dais.

11:36 am Mr. Lee introduces The Children's Choir and Ms. Luana Miller.

11:37 am Daily Points of Light song performed by West Ridge Elementary School Choir.

11:40 am Benediction by Luana Miller, Student.

11:42 am THE PRESIDENT, accompanied by Mr. Lee and The Honorable Joseph Jenkins, Mayor of Provo, concludes participation in Program, departs Stage and proceeds to Holding Room.

NOTE: En route Holding Room, THE PRESIDENT is presented with a T-Shirt by Mr. Jason Hall, President, Brigham Young University Student Body.

11:43 am THE PRESIDENT, accompanied by Mr. Lee and Mayor Jenkins, arrives Holding Room and holds briefly.

NOTE: At this time, THE PRESIDENT is presented with books by President Lee and a Statuette by Mayor Jenkins.

11:45 am THE PRESIDENT departs Holding Room and proceeds to Motorcade.

NOTE: Six Police Photos will be taken at this time.

11:46 am THE PRESIDENT boards Motorcade and departs Brigham Young University Marriott Center en route Provo Airport.

MOTORCADE ASSIGNMENTS:

Same as on Arrival.

(Drive Time: 10 Minutes)

11:56 am THE PRESIDENT arrives Provo Airport and proceeds to board Air Force One.

12:00 pm THE PRESIDENT departs Provo, Utah en route  
(M.D.T.) Hagerstown, Maryland.

(Flying Time: 3 Hours 40 Minutes)  
(Time Change: Ahead 2 Hours)  
(Interchange: No)  
(Food Service: Lunch)

NOTE: Guests and Staff not manifested aboard C-20 will depart Provo, Utah aboard C-9 at 12:10 pm M.D.T. en route Andrews Air Force Base. En route Andrews there will be two refueling stops; Salt Lake City, Utah and Salina, Kansas. Each refueling stop will be one hour. Arrival at Andrews is scheduled for 8:25 pm E.D.T.

5:40 pm THE PRESIDENT arrives Hagerstown Airport,  
(E.D.T.) Hagerstown, Maryland and proceeds to board Marine One.

5:50 pm THE PRESIDENT departs Hagerstown, Maryland en route Camp David.

(Flying Time: 10 Minutes)

6:00 pm THE PRESIDENT arrives Camp David.

DIAS PART - 2 SENS / GOV'S  
SPEAK OF GETS THERE

AUDIENCE:  
"ENTIRE UTAH VALLEY"

Sens: Orrin Hatch, Jake Garn

Gov. NORM BANGERTER

MAYOR JOSEPH JENKINS OF PROVO (Joe)

Presidential Remarks  
Bush-Quayle Rally  
Provo, Utah  
18 July 1992  
Draft

SPORTS COMPLEX  
- Marriott Center - basketball court /  
- Cougars play there - last yr. winning  
- Season - 20 games  
Indoor - 22,000 people (20,000)

- Band - Highschool band - Temp View Orch.  
- Song - Point of light "The Children's Choir"  
NO INVOCATION

OSA / LTC

INTRO - PRESIDENT LIFE, PRES. BYU  
Am. flags - NO BP BANNERS

→ Marie Osmond(?)

[Sold out football season past 10 yrs.]

→ 10,000 BYU STUDENTS - SUMMER SCHOOL  
Phrase on gate - "Enter to learn - go forth to serve"

lot of elected / and candidates "the world is our campus"

PETA's drives by sign

Good morning everybody. It's great to be out West ... and be able to pay a visit to this outstanding university.

"The West is where we all go someday ... a famous writer once wrote. "It's where we go when we hear there is 'gold in them thar hills.' Where we go to grow with the country. Where we chase our young dreams ... or spend our old age."

And today I can add ... with complete authority ... that the West also isn't all that bad a place to be ... when your personality is being pummelled ... your character questioned ... and your administration verbally assassinated ... 4,000 miles away.

ACTUAL LAND MILES IS (≈ 2,300)

I spent the past couple days away from a television set ... up in Wyoming trout fishing with Secretary of State Jim Baker ... and our two sons. Jamie; Jeb

But I am aware that something else was going on in America this week. Something real important.

This is the week when all across America ... crowds of panting, sweating people overran their neighborhood video stores. From Tallahassee to Tempe ... Americans turned on their TV and decided they'd rather rent "Action Jackson" than listen to: Well, never mind.

Now ... please don't get the idea this is some kind of partisan attack. Stop by <sup>Rich Adams</sup> Rich's Video down on Freedom Boulevard ... and I'm sure Rich'll tell it to you straight. Sales aren't all that bad during the Republican Convention either.

I know you have a lot on your minds beside politics. And I hate to poison the air with partisan talk. But let me just respond just a little to what went on in Manhattan.

If you're one of those who prefer video renting to politicians venting ... I'll put it simple. You can sum up all you need to know about the Manhattan meeting with the title of a 1965 Cliff

Robertson comedy: "Masquerade."

LARS

From what I heard about the convention ... I wonder if the Democrats are donning a disguise.

They're saying the right things. Pride in America's strength.

Support for entrepreneurs. (~~Belief in God~~) Respect for law and order. ←

In fact ... if it weren't for the \$9,000 stuffed ponies at the toy store on the corner ... and the bullet proof vests being sold on street corners ... you could close your eyes and think they were at this "home above the range" in Provo ... not the "home of the hockey Rangers" in New York City.

LARS

But you know ... I couldn't help but wonder ... do they really mean what they say? Or is this new costume something the Democrats plan on discarding ... maybe sometime right after Halloween?

\* Think about it. If they celebrate the end of the Cold War ... how come they never supported the strength that won it?

If they claim to be buddies with business people ... how come  
→ they want to load 'em down with new taxes?

If they are really the party of new ideas and open ears ... why not allow just one speaker to talk about the rights of the unborn?

Rep. Floyd Flake

✓ And if they start their convention with a prayer ... how come you can read all 10,000 words in their party platform ... and never run across three simple letters: G-O-D.

✓ double check our platform MOST CURRENT AVAIL COPY  
LARS GET RNC 92 platform / RNC -  
3

Now ... don't take my word that the Democrats may not be what they appear to be. I'm a little biased.

Listen instead ... to a party elder. A guy named McGovern.  
First name George. He called this year's Democratic Party ... a  
"Trojan Horse."

He said ... and I quote ... "they're much more liberal underneath ... and will prove it when they're elected."

*NYT ARTICLE 14 July 1992*

→ I've know I've never said this publicly. But that McGovern.  
He's an incredibly insightful man!

Now ... let me be straight with you. This election isn't going to be decided on what we say about the other side ... or what they say about us ... for that matter.

What matters ... is what we have to offer the American people.

My view of America is a little different than what you may have heard this week. *(From the Dems) implies abt him - -*

We have problems ... yes ... but also opportunities.

After four decades of sacrifice ... we've seen in the past four years ... change of almost Biblical proportions. Captive nations set free. The dark corners of the world bathed in the sunshine of freedom and free enterprise.

Today ... the specter of nuclear war is receding. While the world can still be uncertain and even dangerous ... we've been able to slow defense spending by a thousand dollars for every American family. *BOB GRADY (ASK NELSON)*

Our economic fundamentals are okay. We've tamed inflation. Interest rates are the lowest in two decades. And we stepped from our corner ... as the heavyweight champion of exports.

*JD FOSTER - CEA 5084 CAN SAY THIS @ LONG TERM? CAN @ SHORT-TERM*

Last year ... the Japanese government asked who leads the world in 143 critical technology industries. Japanese firms led in 33. America in 43.

*PORTER / VENTUR INFO*

And I wouldn't be suprised to learn ... that the report was put together on Wordperfect software ... made right here in Provo.

*Clayton  
Ventur /  
Kris Spuehan*

Does this mean that everything is okay in America? Not by a longshot. But we have to keep our challenges in perspective.

Think about why ... for four decades ... we sacrificed our taxes ... our tears ... even shed our blood ... for people in faraway lands.

Part of it was selflessness. America is the most generous nation the world has ever known.

But part of it was self-interest.

We understood that if we could reduce the threat of nuclear war ... if we could turn more of the world's people to freedom and free enterprise ... our own children would be more secure ... more prosperous.

Well ... we've worked our miracles around the world. Now it's time to work a miracle in America.

\* - ?

First ... we must create more opportunity for more people.

Second ... it's time for a moral revival ... a return to the solid values that built this city ... and carried our nation for 200 years.

Third. We have to understand ... that peace in the world means nothing ... if we are not secure in our own backyards.

Government has to guarantee the security of all our people.

\* These are the three principles I will rely on to lead this nation the next four years.

- *FIRST PRIORITY* -

Our economy is growing today ... but it must grow faster.

Too many people have worked for a company for twenty years ...

only to fear that the next mail run will bring a pink slip. And

many of you young people are saving your way through Brigham (BYU)

✓ Young ... you deserve to be able to find a job on graduation day.

I used to run a business ... meet a payroll. I learned the only way that government can create jobs ... is to support the people who create jobs.

This is the creed Governor Norm Bangerter follows. He understands that the only surefire way to give people unlimited dreams ... is by limiting the size of government.

Only then ... can we create incentives ... so that people can invest in our future.

We're going to bring some of Norm's attitude to Washington.

Like your Governor ... we need a line item veto ... and I'm going to get it.

Like your Governor ... we need a balanced budget amendment to the Constitution ... and I'm going to get it.

And despite <sup>31</sup> (23) vetoes in three years ... cutting ~~(-7-)~~ billion<sup>s</sup> in proposed Congressional spending ... we need even more discipline on the Potomac.

With the help of a new Congressman named Richard Harrington ... we're going to treat wasteful government spending the way Karl Malone will treat a ~~European~~ jump shot in Barcelona. We're going to swat it into the front row!

JAZZ VERY POP. IN PROVS!

Second priority. A moral revolution in America.

We talk alot about family values. But what are they?

You can search the libraries from Portland, Maine to Portland, Oregon ... and never find a more eloquent definition than this:

(insert Mormon creed)

( ) words ... were written two hundred years ago ... in a different age ... a different time.

Today we can fly from Paris to New York and arrive earlier than we left ... but do we too often leave behind the difference between right and wrong?

We can explore a world beyond the stars ... but too often <sup>we</sup> ignore a neighbor down the street.

*key word!* *PAT WHITE -*  
We can drop a machine to the depths of the ocean ... but why do we feel the need to sue at the drop of a lawyer's name?

Government has a role ... in promoting values ... by supporting policies that help keep families together. By giving parents the freedom to choose their schools and their day care centers. By reforming welfare ... and stop encouraging single parents from having more children.

Only then ... can our nation find it's way back to our foundation.

My third priority. Quite simple. Restore respect for the law.

Elderly women in this country ... watch the Berlin Wall fall on television ... but are afraid to walk to their neighborhood grocery store.

*mind democracy?*

If we can topple the Berlin Wall ... we can build a strong economy. If we can lift the iron curtain ... we can bring the curtain down on immorality and indifference. If we can help people walk free in Eastern Europe ... we can take back the streets of America.

This is our mission. Together we'll accomplish it.

God bless you and God bless America.

(1990)  
2 years ago the Utah Valley Regional Medical Center delivered more babies than any other hospital in the country *per capita* *city*  
last yr. 1991 some hospital in Alaska displaced them as number one.

*Kathy*

6TH STORY of Level 1 printed in FULL format.

Copyright 1992 News World Communications, Inc.  
The Washington Times

July 4, 1992, Saturday, Final Edition

SECTION: Part A; NATION; Pg. A3

LENGTH: 613 words

HEADLINE: Democrats won't say 'God' but support 'religious faiths'

BYLINE: Larry Witham; THE WASHINGTON TIMES

BODY:

The Democratic platform committee has rejected use of the term "God," but is departing from recent tradition to note favorably the "religious faiths" of Americans.

At the mid-June drafting session, Sen. Joseph Lieberman, Connecticut Democrat, "indicated his desire that some reference to God be included in the platform," said an aide to the senator.

Though Mr. Lieberman's suggestion was set aside, the senator is satisfied with the substitution of "religious faiths," an aide said.

The aide said this language about religion made "a broad break from the past." He added that "many Democrats almost seem embarrassed to make reference to God."

The current platform draft says Americans have personal responsibility "for the religious faiths they follow, the ethics they practice, the values they instill. . . ."

While God and country have been evoked in state documents, political speeches and platforms since George Washington, the Republican Party is the master of this tradition of "civil religion," historians say.

"Republicans do it very well because they do it unselfconsciously," said Forest McDonald, a historian of American politics at the University of Alabama.

"I think the Democrats are crazy for taking it [the word God] out," he said. "This is a very religious country."

But Stuart Eizenstat, a Democratic platform committee member and former Carter administration domestic policy adviser, said contrived use of religious symbols can backfire.

"The Democratic Party has tended to be a more secular party in terms of separation of church and state," said Mr. Eizenstat, a Washington lawyer.

Evoking religious ideas and symbols "only makes sense if it is part and parcel or the centerpiece of the candidate," he said. "The worse thing you can do is try to fabricate [religion] or be phony for political reasons."

The Washington Times, July 4, 1992

Though the term "God" was rejected, "religious faiths" was included to show the Democratic concern for national values, he and other Democrats said.

"It was just part of the effort by the Democratic Party to not allow the Republicans to solely appropriate the issue of values," Mr. Eizenstat said. "It's better to revive issues of family, community, neighborhood, which are secular symbols."

These differences over religion have revealed themselves in the past.

While the Republican Party platform of 1988 mentioned the American people's "faith in God," the Democratic Party platform talked of a "spiritually stronger" nation by its example to the world.

The 1992 Republican Party platform will be drafted before September.

The differences over religion also appeared in speeches at the two parties' 1988 conventions.

Democratic presidential candidate Michael Dukakis neither mentioned God nor religion but focused on equality and opportunity.

The Rev. Jesse Jackson's 1988 Democratic Convention speech said "providence" brought him and Mr. Dukakis together, while his 1984 convention speech was more a sermon, historians say.

In his 1988 convention speech, President Bush mentioned "our religious faith," said he believed "there's a God and He is good," cited Catholic and "Bible study" groups and thanked God for an adopted grandchild.

Mr. Eizenstat noted that though President Carter was a Baptist and Sunday school teacher, he rarely evoked the God-and-country of civil religion.

Critics of Republican civil religion have compared President Carter's "prophetic" appeal for American's to sacrifice during the energy crisis with President Reagan's call to reap God's blessings.

Democrats  
rejected a reference  
to God

# Democrats won't say 'God' but support 'religious faiths'

By Larry Witham  
THE WASHINGTON TIMES

The Democratic platform committee has rejected use of the term "God," but is departing from recent tradition to note favorably the "religious faiths" of Americans.

At the mid-June drafting session, Sen. Joseph Lieberman, Connecticut Democrat, "indicated his desire that some reference to God be included in the platform," said an aide to the senator.

Though Mr. Lieberman's suggestion was set aside, the senator is satisfied with the substitution of "religious faiths," an aide said.

The aide said this language about

religion made "a broad break from the past." He added that "many Democrats almost seem embarrassed to make reference to God."

The current platform draft says Americans have personal responsibility "for the religious faiths they follow, the ethics they practice, the values they instill...."

While God and country have been evoked in state documents, political speeches and platforms since George Washington, the Republican Party is the master of this tradition of "civil religion," historians say.

"Republicans do it very well because they do it unselfconsciously," said Forest McDonald, a historian of American politics at the University of Alabama.

"I think the Democrats are crazy for taking it [the word God] out," he said. "This is a very religious country."

But Stuart Eizenstat, a Democratic platform committee member and former Carter administration domestic policy adviser, said contrived use of religious symbols can backfire.

"The Democratic Party has tended to be a more secular party in terms of separation of church and state," said Mr. Eizenstat, a Washington lawyer.

Evoking religious ideas and symbols "only makes sense if it is part and parcel of the centerpiece of the candidate," he said. "The worse thing

you can do is try to fabricate [religion] or be phony for political reasons."

## Democratic Convention Lineup: Who's Missing From the List?

Absent from the array of speakers and participants for this month's Democratic National Convention in New York are New York Gov. Mario M. Cuomo and former California governor Edmund G. "Jerry" Brown Jr.

In announcing the July 13-16 convention lineup yesterday, Democratic National Committee Chairman Ronald H. Brown said it represents "the best of the Democratic Party—integrity, creative ideas and change."

Convention planners had hoped to persuade Cuomo to nominate Arkansas Gov. Bill Clinton, but Cuomo has not agreed. Cuomo, who gave a riveting speech at the 1984 convention, has said repeatedly he does want to address this one.

DNC press secretary Ginny Terzano said that Jerry Brown, the Clinton campaign and the DNC are discussing Brown's role because the former governor has not endorsed Clinton or decided whether to have himself nominated.

Brown's sister, California Treasurer Kathleen Brown, however, will speak to delegates.

And Jesse L. Jackson is on the program at Ron Brown's request. "The chairman is certain that Reverend Jackson will endorse Governor Clinton prior to the convention," Terzano said.

Three of the men Clinton defeated for the nomination—Sens. Tom Harkin (Iowa) and Bob Kerrey (Neb.) and former Massachusetts senator Paul E. Tsongas—will speak. But Virginia Gov. L. Douglas Wilder, the first to drop out of the presidential primaries, is not expected on the podium.

Although Clinton is expected to have named his running mate before the convention opens, many of those he is considering will address the convention. They include Sen. Albert Gore Jr. (Tenn.), John D. "Jay" Rockefeller IV (W.Va.), Harris Wofford (Pa.) and Rep. Lee Hamilton (Ind.).

D.C. Mayor Sharon Pratt Kelly, Del. Eleanor Holmes Norton (D.C.) and Baltimore Mayor Kurt Schmoke will appear Tuesday night, and Sen. Barbara A. Mikulski (Md.), a convention co-chairman, will speak Monday.

The DNC announced last month that keynote speakers will be Sen. Bill Bradley (N.J.), Georgia Gov. Zell Miller and former representative Barbara Jordan (Tex.). Texas Gov. Ann Richards is convention chairman.

form of 1988 mentioned the American people's "faith in God," the Democratic Party platform talked of

convention speech was more a sermon, historians say. In his 1988 convention speech

The Washington Post

DATE: 7/3/92  
PAGE: 13



Republican  
National  
Committee

**FACSIMILE TRANSMISSION**

DATE: 7/17/92  
TO: Jeannie Bunton  
FAX NUMBER: 456-6218  
FROM: Eric Lebson  
NUMBER OF PAGES INCLUDING COVER SHEET: 2

**IF ALL PAGES ARE NOT RECEIVED, PLEASE CALL (202) 863-8666**

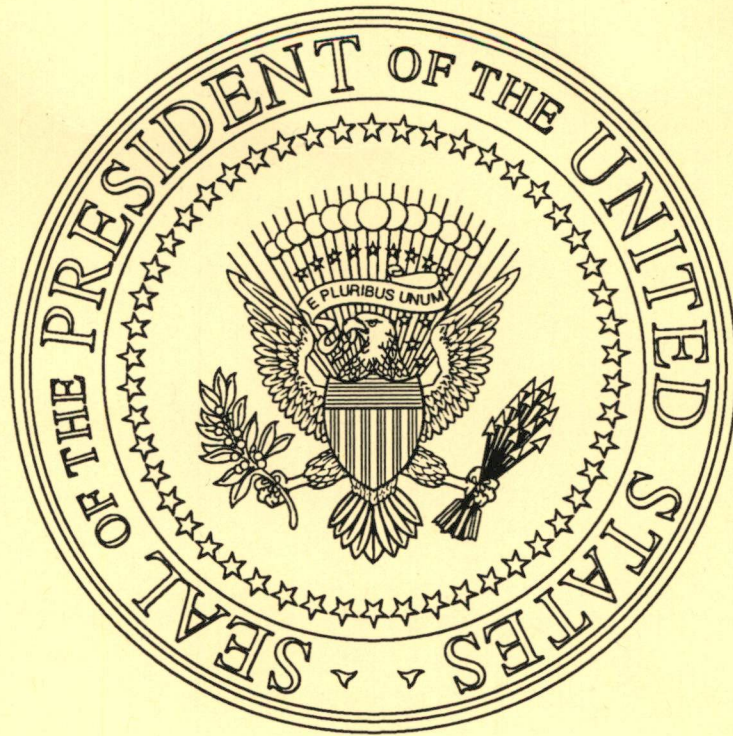

**THE TRIP OF  
THE PRESIDENT  
TO  
JACKSON, WYOMING;  
SALT LAKE CITY,  
& PROVO, UTAH**

**July 17-18, 1992**

The Trip of the President to  
Jackson, Wyoming,  
Salt Lake City, and Provo, Utah  
July 17-18, 1992

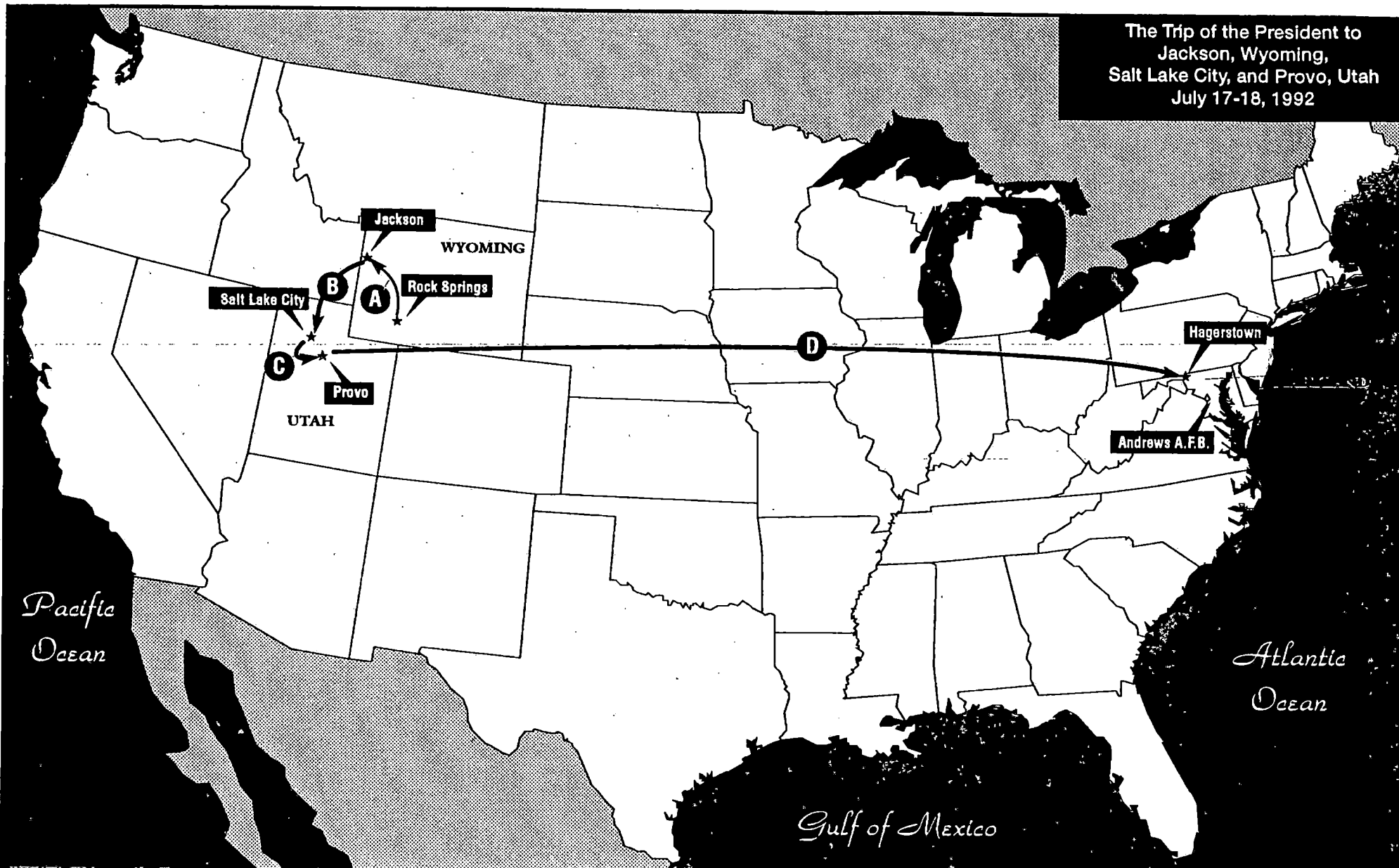

| From/To                                     | Statute Miles | Flying Time            |
|---|---------------|------------------------|
| A Boulder , Wyoming - to - Jackson, Wyoming | 0075          | 0 hours and 45 minutes |
| B Jackson - to - Salt Lake City, Utah       | 0210          | 1 hours and 15 minutes |
| C Salt Lake City - to - Provo, Utah         | 0045          | 0 hours and 25 minutes |
| D Provo - to - Hagerstown, Maryland         | 1840          | 3 hours and 40 minutes |
| E Hagerstown - to - Camp David              | 0012          | 0 hours and 15 minutes |

**LEGEND**

Air Force One flight 

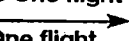
Marine One flight 

THE WHITE HOUSE  
WASHINGTON

SCHEDULE OF THE PRESIDENT

FOR

JACKSON, WYOMING

JULY 17, 1992

EVENT:

Picnic Lunch with Jackson Hole Service Clubs

DRESS:

Men - Casual  
Women - Casual

CONTACTS:

Presidential Advance Office  
Ed Murnane - 202/456-7565  
  
Trip Coordinator  
Kris Goodwin - 202/456-7565  
  
Jackson, Wyoming Signal - 307/537-5626  
- \*96 31 000

ADVANCE:

David Anderson - LEAD  
Bobby Carr - PRESS  
George Luczko - USSS  
Brad Fuggitt - WHCA  
Michelle Johnson - MIL. AIDE  
John Kearns - AFI  
Ken Inhoff - HMX

WEATHER:

Partly Cloudy/Mid 80's

SCHEDULE OF THE PRESIDENT

FOR

JACKSON, WYOMING

JULY 17, 1992

11:30 am

THE PRESIDENT arrives Jackson Hole Airport, Jackson, Wyoming and proceeds to Seat at Picnic Table.

Met by:

The Honorable Craig Thomas  
U.S. Representative, Wyoming

The Honorable William Westbrook  
Mayor of Jackson, Wyoming

**Point of Light Greeters:**

Reverend Dan Gorman  
Executive Director of Central Wyoming Rescue  
Mission and 825th Daily Point of Light

Ms. Rosemary Shelley  
Central Wyoming Rescue Mission Volunteer  
and 825th Daily Point of Light

Ms. Kris Hunt  
Director, Wind River Youth Center and 800th  
Daily Point of Light

Ms. Janet Davis  
Co-Founder, Wind River Youth Center and 800th  
Daily Point of Light

Mr. Mack McFarland  
Supervisor, Yellowstone Recovery Corps and  
160th Daily Point of Light

Mr. John Macintosh  
Director, Yellowstone Recovery Corps and  
160th Daily Point of Light

GUEST AND STAFF INSTRUCTIONS:

All Staff staying in Jackson, Wyoming should meet in Staff Office, Room 114 of the Antler Motel, no later than 10:30 am for transport to Event Site.

Upon arrival of Marine One, Guests and Staff will be escorted to Staff Table/Viewing Area.

Please board Staff Bus no later than 12:20 pm for transport to C-130.

EVENT: PICNIC LUNCH WITH JACKSON HOLE SERVICE CLUBS

OPEN PRESS

TOAST LECTERN

REMARKS

NOTE: THE PRESIDENT will proceed through Food Line en route Picnic Table.

11:40 am THE PRESIDENT arrives Picnic Table, is Seated, and begins participation in Picnic Lunch.

12:00 pm THE PRESIDENT is introduced for Remarks by The Honorable Craig Thomas, U.S. Representative, Wyoming.

NOTE: THE PRESIDENT proceeds on Stage at this time.

12:02 pm THE PRESIDENT Remarks.

12:17 pm THE PRESIDENT concludes Remarks, departs Stage, and proceeds to Motorcade.

NOTE: Six Police Photos will be taken at this time.

12:22 pm THE PRESIDENT boards Motorcade and departs Picnic Site en route Tarmac.

MOTORCADE ASSIGNMENTS:

|           |                         |
|-----------|-------------------------|
| LIMO      | THE PRESIDENT           |
| Control   | S. Skinner<br>Mil. Aide |
| Staff Bus | All Remaining Staff     |
| Press Bus | M. Busch                |

(Drive Time: 3 Minutes)

12:25 pm THE PRESIDENT arrives Tarmac and proceeds to board Air Force One (C-20).

12:30 pm (M.D.T.) THE PRESIDENT departs Jackson, Wyoming en route Salt Lake City, Utah.

(Flying Time: 1 Hour 15 Minutes)  
(Time Change: None)  
(Interchange: Yes/C-20/C-130)  
(Food Service: Snacks)

SCENARIO

THE WHITE HOUSE

WASHINGTON

VISIT OF THE PRESIDENT

TO

JACKSON, WYOMING

JULY 17, 1992

EVENT: Picnic Lunch with Jackson Hole Service Clubs

DATE: Friday, July 17, 1992

TIME: 11:40 am - 12:17 pm

LOCATION: Jackson Hole Airport, Tarmac

ATTENDEES: 2,000

PRESS: Open

SCENARIO: THE PRESIDENT arrives Jackson Hole Airport, Jackson, Wyoming, and is greeted by The Honorable Craig Thomas, U.S. Representative, Wyoming; The Honorable William Westbrook, Mayor of Jackson, Wyoming; Reverend Dan Gorman, Executive Director, Central Wyoming Rescue Mission and 825th Daily Point of Light; Ms. Rosemary Shelley, Central Wyoming Rescue Mission Volunteer and 825th Daily Point of Light; Ms. Kris Hunt, Director, Wind River Youth Center and 800th Daily Point of Light; Ms. Janet Davis, Co-Founder, Wind River Youth Center and 800th Daily Point of Light; Mr. Mack McFarland, Supervisor, Yellowstone Recovery Corps and 160th Daily Point of Light; and Mr. John Macintosh, Director, Yellowstone Recovery Corps and 160th Daily Point of Light. Following the Greetings, THE PRESIDENT proceeds to Picnic Table. (NOTE: En route Picnic Table, THE PRESIDENT will proceed through Food Line.) THE PRESIDENT arrives Picnic Table and begins participation in Picnic Lunch. Upon conclusion of Lunch, THE PRESIDENT is introduced for Remarks by Congressman Thomas. THE PRESIDENT proceeds on Stage and Remarks (Enter Stage Left). (NOTE: THE PRESIDENT will remark from a Toast Lectern.) THE PRESIDENT concludes Remarks, departs Stage (Exit Stage Left), and proceeds to Motorcade. (NOTE: Six Police Photos will be taken at this time.) THE PRESIDENT boards Motorcade and departs Picnic Site en route Tarmac. THE PRESIDENT arrives Tarmac and proceeds to board Air Force One (C-20). THE PRESIDENT departs Jackson, Wyoming en route Salt Lake City, Utah.

The Backdrop for the Address will be the Grand Teton mountain range and three covered wagons.

The Press Platform will be located straight-on at 60 feet.



JACKSON, WYOMING  
 Picnic with Jackson Service Clubs  
 Overview Diagram  
 Friday, July 17, 1992

Grand  
 Teton  
 Mountain  
 Range

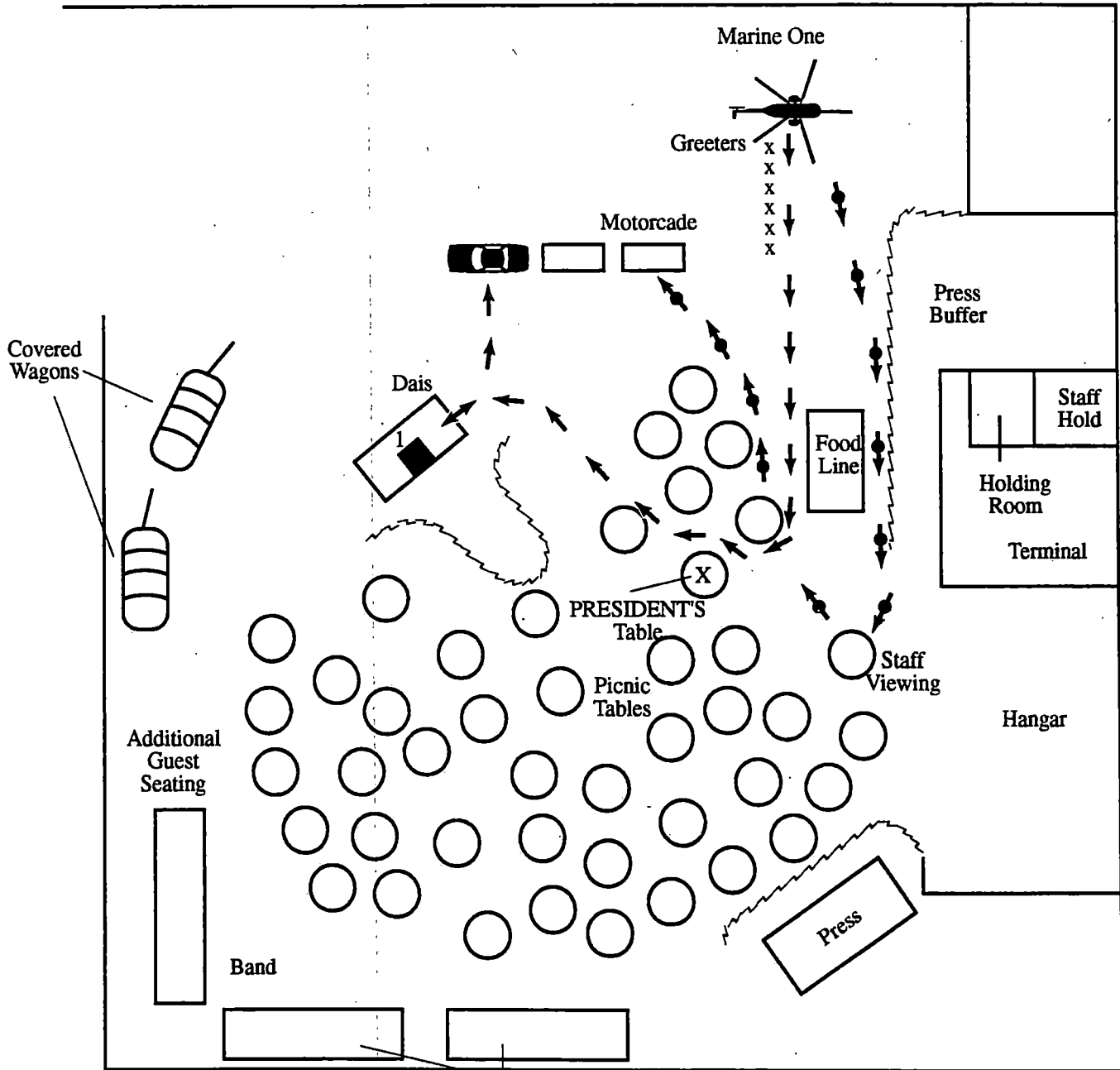

Dais  
 1. THE PRESIDENT

**KEY:**

- ➔ THE PRESIDENT
- ➔ GUESTS / STAFF
- X GREETERS

JACKSON, WYOMING  
Picnic with Jackson Hole Service Club  
Seating Diagram  
Friday, July 17, 1992

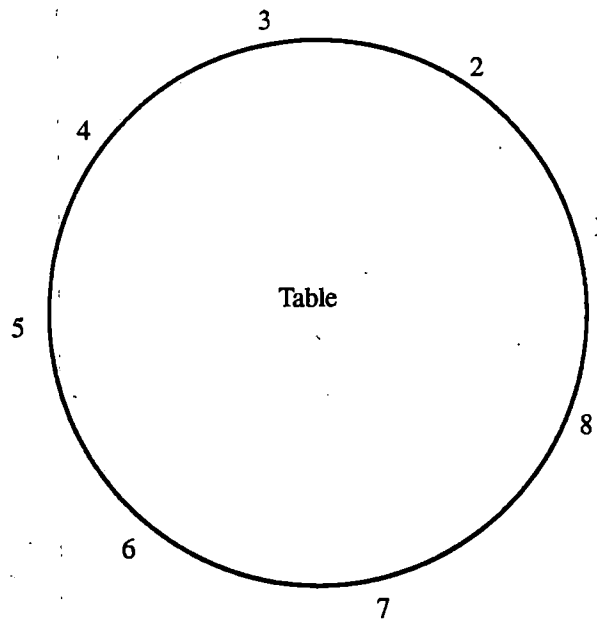

1. THE PRESIDENT
2. Mr. William Westbrook, Mayor, Jackson, Wyoming
3. Mr. Tony Ligori, President, Rotary Club of Jackson Hole
4. Mr. Joseph Rogers, President, Jackson Chamber of Commerce
5. Mr. Bruce Morse, President, Kiwanis Club of Jackson Hole
6. Mr. Brad Lvense, President, Jaycees of Jackson Hole
7. Mr. Charles Gallaway, President, Lions Club of Jackson Hole
8. Ms. Clarene Law, Board of Directors, Community Entry Services

KEY:

→ THE PRESIDENT

JACKSON, WYOMING  
 Jackson Airport  
 Departure Diagram  
 Friday, July 17, 1992

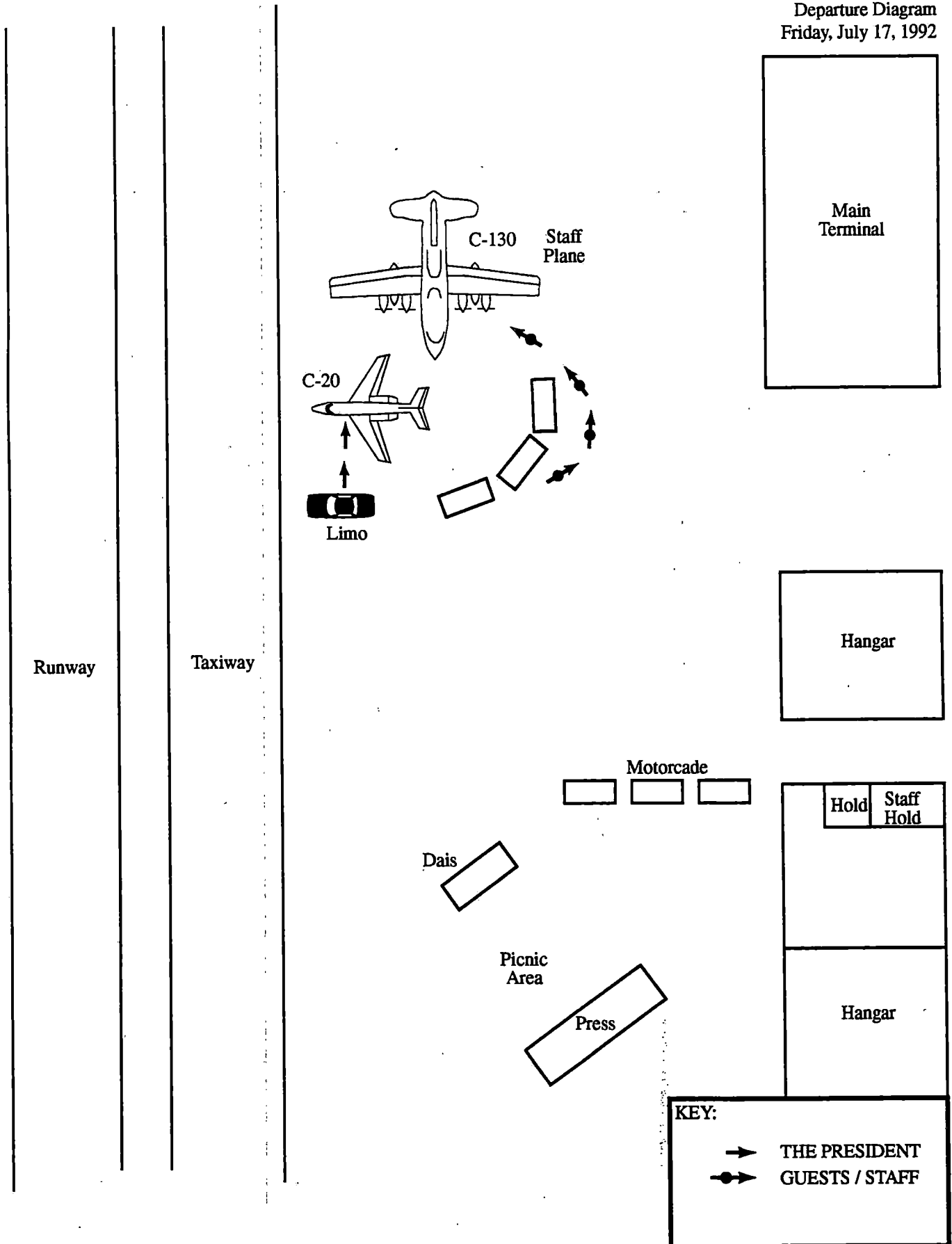



THE WHITE HOUSE

WASHINGTON

SCHEDULE OF THE PRESIDENT

FOR

SALT LAKE CITY AND PROVO, UTAH

JULY 17 - 18, 1992

EVENTS:

Meeting with Mormon Church Leaders  
Meeting with Utah GOP Leaders  
Ask George Bush with Outdoor Groups  
Address to Brigham Young University and Provo Community

DRESS:

Men - Business Suit  
Women - Day Dress

CONTACT:

Office of Presidential Advance  
Ed Murnane - 202/456-7565

Trip Coordinator  
Suzanne Faulk - 202/456-7565

Salt Lake City, Utah, Signal - 801/531-3800  
- \*96/37-000

ADVANCE:

|                  |             |                 |        |
|------------------|-------------|-----------------|--------|
| Craig Ray        | - LEAD      | Dianne Harrison | -SITE  |
| Topper Ray       | - PRESS     | Bobby Peede     | -SITE  |
| Ed Skrodzki      | - USSS      | Heather Herring | -SITE  |
| Michelle Johnson | - MIL. AIDE | Dan McCardell   | -PRESS |
| Dave Miller      | - WHCA      |                 |        |
| Tom Armstrong    | - AFI       |                 |        |

|                |               |               |              |
|----------------|---------------|---------------|--------------|
| Kevin Hart     | - SITE PROVO  | Denise Dunkel | -PRESS PROVO |
| Hopson Nance   | - SITE PROVO  |               |              |
| Peter Gaillard | - PRESS PROVO |               |              |

WEATHER:

Partly Cloudy/high 70s

SCHEDULE OF THE PRESIDENT  
FOR  
SALT LAKE CITY AND PROVO, UTAH  
JULY 17 - 18, 1992

1:45 pm  
(M.D.T.)

THE PRESIDENT arrives Salt Lake City International Airport, Salt Lake City, Utah and proceeds to Motorcade.

Met by:

The Honorable W. Val Oveson  
Lt. Governor of Utah

The Honorable Jake Garn  
United States Senator

The Honorable Orrin Hatch  
United States Senator

Mr. Bruce R. Hough  
State GOP Chairman

Ms. Bonnie H. Stephens  
Bush-Quayle Chairman

Mr. Christopher Cannon  
Victory '92 Finance Chairman

Mr. John Huntsman, Sr.  
Chairman of Huntsman Chemical Corp.

Mr. John Huntsman, Jr.  
Bush-Quayle Finance

Mr. John Price  
Bush/Quayle Supporter

Ms. Arlene Ellis  
National Committeewoman-Elect

**Daily Point of Light Greeters:**

Ms. Lillian Smith  
Volunteer Counselor and 694th Daily Point of Light

Mr. Dennis Hansen  
Guest of Ms. Smith

Mr. Dave Burton  
President, STARS and 786th Daily Point of Light

Ms. Pamela Hutchins  
Vice President, STARS and 786th Daily Point of  
Light

Mr. Pepper Provenzano  
President and Founder, TreeUtah and 712th Daily  
Point of Light

Mr. Leroy Hooten  
Guest of Mr. Provenzano

1:55 pm

THE PRESIDENT boards Motorcade and departs Salt  
Lake City International Airport en route Marriott  
Hotel.

MOTORCADE ASSIGNMENTS:

|           |  |
|-----------|--|
| Lead      | C. Ray   |
| Spare     | B. Farish<br>Doctor                                      |
| LIMO      | THE PRESIDENT  |
| Follow Up |  |
| Control   | S. Skinner<br>Adm. Howe<br>Mil. Aide                     |
| Support   | J. Smith<br>E. Murnane<br>Official Photographer<br>Medic |
| WHCA      | J. Gaughan   |
| Camera I  | J. Herrick   |

|              |                                       |
|--------------|---------------------------------------|
| Staff I      | R. Porter<br>S. Provost<br>R. Kaufman |
| Guest I      | B. Teeter                             |
| Camera II    |                                       |
| Wire I       |                                       |
| Wire II      |                                       |
| Staff Van    | All Remaining Staff                   |
| Guest Van    | All Remaining Guests                  |
| Press Van I  | M. Busch                              |
| Press Van II |                                       |

(Drive Time: 10 Minutes)

GUEST AND STAFF INSTRUCTIONS:

Upon arrival at Marriott Hotel, Guests and Staff should proceed to 14th Floor Foyer for Room Assignments and Keys.

Guests and Staff attending the meeting with Mormon Church Leaders should board Motorcade no later than 2:40 p.m.

2:05 pm

THE PRESIDENT arrives Marriott Hotel and proceeds to Suite.

Met by:

Mr. Steve Hart  
General Manager, Marriott Hotel

Mr. Steve Huey  
Director of Marketing, Marriott Hotel

Mr. Richard Boden  
Director of Security, Marriott Hotel

2:10 pm THE PRESIDENT arrives Suite for Private Time.

(PRIVATE TIME: 35 MINUTES)

2:45 pm THE PRESIDENT departs Suite and proceeds to Motorcade.

2:50 pm THE PRESIDENT boards Motorcade and departs Marriott Hotel en route Church of Jesus Christ of Latter Day Saints, Administration Building.

MOTORCADE ASSIGNMENTS:

Same as on Arrival.

(Drive Time: 5 Minutes)

GUEST AND STAFF INSTRUCTIONS:

Upon arrival at Church of Jesus Christ of Latter Day Saints, Guests and Staff will be escorted to Staff Holding Room.

Please board Motorcade no later than 3:40 pm for transport to the Marriott Hotel.

2:55 pm THE PRESIDENT arrives Church of Jesus Christ of Latter Day Saints, Administration Building and proceeds to North Board Room.

Met by:

Bruce L. Olsen  
Director, Public Affairs, Church of Latter Day Saints

EVENT: MEETING WITH MORMON CHURCH LEADERS

EXPANDED POOL (AT END ONLY)

3:00 pm THE PRESIDENT, accompanied by Mr. Olsen, arrives North Board Room, takes Seat and begins participation in Meeting.

Met by:

President Gordon B. Hinckley  
First Counselor, Church of Latter Day Saints

President Thomas S. Monson  
Second Counselor, Church of Latter Day Saints

3:45 pm THE PRESIDENT, accompanied by President Hinckley and President Monson, concludes participation in Meeting, departs North Board Room and proceeds to Motorcade.

NOTE: At the conclusion of the Meeting, THE PRESIDENT, accompanied by President Hinckley and President Monson, proceeds to Foyer for Photo Opportunity.

3:50 pm THE PRESIDENT boards Motorcade and departs Church of Jesus Christ of Latter Day Saints, Administration Building en route Marriott Hotel.

MOTORCADE ASSIGNMENTS:

Same as on Arrival.

(Drive Time: 5 Minutes)

GUESTS AND STAFF INSTRUCTIONS:

Upon on arrival at Marriott Hotel, Guests and Staff will be escorted to Salon J, Staff Holding Area.

3:55 pm THE PRESIDENT arrives Marriott Hotel and proceeds to Salon J.

EVENT: MEETING WITH UTAH GOP LEADERS

CLOSED PRESS

4:00 pm THE PRESIDENT arrives Salon J, takes Seat and begins participation in Meeting.

4:30 pm THE PRESIDENT concludes participation in Meeting, departs Salon J and proceeds to Suite.

4:35 pm THE PRESIDENT arrives Suite for RON.

**RON Salt Lake City, Utah**

Saturday, July 18, 1992

GUESTS AND STAFF INSTRUCTIONS:

- 5:00 am **Baggage Call.** Please place all unlocked baggage outside your room at this time.
- 8:40 am Guests and Staff should board Motorcade at this time for transport to Red Butte Gardens.
- 9:00 am Transportation to the Airport will be available for Guests and Staff not attending the Ask George Bush Event.

8:40 am

THE PRESIDENT departs Suite and proceeds to Motorcade.

NOTE: Six police photos will be taken at this time.

8:45 am

THE PRESIDENT boards Motorcade and departs Marriott Hotel en route Red Butte Gardens.

MOTORCADE ASSIGNMENTS:

|           |  |
|-----------|--|
| Lead      | C. Ray   |
| Spare     | B. Farish<br>Doctor  |
| LIMO      | THE PRESIDENT  |
| Follow Up |  |
| Control   | S. Skinner<br>Adm. Howe<br>Mil. Aide                         |
| Support   | M. Fitzwater<br>E. Murnane<br>Official Photographer<br>Medic |
| WHCA      | J. Gaughan   |
| Camera I  | J. Herrick   |
| Staff I   | R. Porter<br>S. Provost<br>R. Kaufman                        |
| Guest I   | R. Teeter  |
| Camera II |  |
| Wire I    |  |
| Wire II   |  |
| Staff Van | All Remaining Staff  |

|              |                      |
|--------------|----------------------|
| Guest Van    | All Remaining Guests |
| Press Van I  | M. Busch             |
| Press Van II |                      |

(Drive Time: 10 Minutes)

GUESTS AND STAFF INSTRUCTIONS:

Upon Arrival at Red Butte Gardens, Guests and Staff will be escorted to Holding Trailers and/or Staff Viewing Area.

Guests and Staff should board Motorcade no later than 9:25 am for transport to Salt Lake City International Airport.

8:55 am

THE PRESIDENT arrives Red Butte Gardens and proceeds to Water Pavilion Garden.

Met by:

Mr. and Mrs. Arthur K. Smith (June)  
President, University of Utah

Ms. Mary Pat Matheson  
Director, Red Butte Gardens and Arboretum

NOTE: Lt. Governor W. Val Oveson introduces THE PRESIDENT as he sees him approaching.

EVENT: ASK GEORGE BUSH WITH OUTDOOR GROUPS

EXPANDED POOL

9:00 am

THE PRESIDENT, accompanied by Mr. and Mrs. Smith and Ms. Matheson, arrives Water Pavilion Garden, proceeds to Seat and begins participation in Ask George Bush.

9:30 am THE PRESIDENT concludes participation in Ask George Bush, departs Water Pavilion Garden and proceeds to Motorcade.

9:35 am THE PRESIDENT boards Motorcade and departs Red Butte Gardens en route Salt Lake City International Airport.

MOTORCADE ASSIGNMENTS:

Same as on Arrival.

(Drive Time: 15 Minutes)

9:50 am THE PRESIDENT arrives Salt Lake City International Airport and proceeds to board Air Force One (C - 20).

9:55 am (M.D.T.) THE PRESIDENT departs Salt Lake City, Utah en route Provo, Utah.

(Flying Time: 50 minutes)  
(Time Change: None)  
(Interchange: Yes C-9/C-20)  
(Food Service: Snacks)

10:45 am THE PRESIDENT arrives Provo Airport, Provo, Utah and proceeds to Motorcade.

Met by:

The Honorable Joseph Jenkins  
Mayor of Provo

Mr. Richard Harrington  
Republican nominee for Congress, 3rd District

The Honorable Gary Herbert  
Chairman, Utah County Board of Commissioners

Mr. Mike Stewart  
Salt Lake City Commissioner

Mr. Lewis Billings  
GOP County Chairman

Mr. Rex Lee  
President, Brigham Young University

Ms. Christine Fox  
Utah State Legislator

Mr. Blake Roney  
President, NuSkin

Mr. Frank Switter  
GOP Supporter

Ms. Pearl Rex  
GOP Volunteer

10:55 am

THE PRESIDENT departs Provo Airport en route  
Brigham Young University.

MOTORCADE ASSIGNMENTS:

|           |  |
|-----------|--|
| Lead      | C. Ray   |
| Spare     | B. Farish<br>Doctor  |
| LIMO      | THE PRESIDENT  |
| Follow Up |  |
| Control   | S. Skinner<br>Adm. Howe<br>Mil. Aide                         |
| Support   | M. Fitzwater<br>E. Murnane<br>Official Photographer<br>Medic |
| WHCA      | J. Gaughan   |
| Camera I  | J. Herrick   |
| Staff I   | R. Porter  |

|              |                      |
|--------------|----------------------|
|              | S. Provost           |
|              | R. Kaufman           |
| Guest I      | B. Teeter            |
| Camera II    |                      |
| Wire I       |                      |
| Wire II      |                      |
| Staff Van    | All Remaining Staff  |
| Guest Van    | All Remaining Guests |
| Press Van I  | M. Busch             |
| Press Van II |                      |

(Drive Time: 10 Minutes)

GUESTS AND STAFF INSTRUCTIONS:

Upon arrival at Brigham Young University Marriott Center, Guests and Staff will be escorted to Staff Holding Room and/or Staff Viewing Area.

Please board Motorcade no later than 11:35 am for transport to Provo Airport.

11:05 am THE PRESIDENT arrives Brigham Young University Marriott Center and proceeds to Holding Room.

11:06 am THE PRESIDENT arrives Holding Room and holds briefly.

11:08 am THE PRESIDENT, accompanied by Mr. Lee, departs Holding Room and proceeds to Off-Stage Announcement Area.

11:09 am THE PRESIDENT, accompanied by Mr. Lee, arrives Off-Stage Announcement Area and holds briefly.

NOTE: Dais Participants will be on Stage prior to THE PRESIDENT

EVENT: REMARKS TO STUDENTS AND FACULTY OF BRIGHAM YOUNG UNIVERSITY

OPEN PRESS

RUFFLES AND FLOURISHES

OFF-STAGE ANNOUNCEMENT

HAIL TO THE CHIEF

REMARKS

TELEPROMPTER

11:10 am THE PRESIDENT, accompanied by President Rex Lee, is announced onto Stage and proceeds to Seat on Dais.

11:11 am THE PRESIDENT is introduced for Remarks by President Lee.

11:15 am THE PRESIDENT Remarks.

11:35 am THE PRESIDENT concludes remarks and returns to Seat on Dais.

11:36 am Mr. Lee introduces The Children's Choir and Ms. Luana Miller.

11:37 am Daily Points of Light song performed by West Ridge Elementary School Choir.

11:40 am Benediction by Luana Miller, Student.

11:42 am THE PRESIDENT, accompanied by Mr. Lee and The Honorable Joseph Jenkins, Mayor of Provo, concludes participation in Program, departs Stage and proceeds to Holding Room.

NOTE: En route Holding Room, THE PRESIDENT is presented with a T-Shirt by Mr. Jason Hall, President, Brigham Young University Student Body.

11:43 am THE PRESIDENT, accompanied by Mr. Lee and Mayor Jenkins, arrives Holding Room and holds briefly.

NOTE: At this time, THE PRESIDENT is presented with books by President Lee and a Statuette by Mayor Jenkins.

11:45 am THE PRESIDENT departs Holding Room and proceeds to Motorcade.

NOTE: Six Police Photos will be taken at this time.

11:46 am THE PRESIDENT boards Motorcade and departs Brigham Young University Marriott Center en route Provo Airport.

MOTORCADE ASSIGNMENTS:

Same as on Arrival.

(Drive Time: 10 Minutes)

11:56 am THE PRESIDENT arrives Provo Airport and proceeds to board Air Force One.

12:00 pm (M.D.T.) THE PRESIDENT departs Provo, Utah en route Hagerstown, Maryland.

(Flying Time: 3 Hours 40 Minutes)  
(Time Change: Ahead 2 Hours)  
(Interchange: No)  
(Food Service: Lunch)

NOTE: Guests and Staff not manifested aboard C-20 will depart Provo, Utah aboard C-9 at 12:10 pm M.D.T. en route Andrews Air Force Base. En route Andrews there will be two refueling stops; Salt Lake City, Utah and Salina, Kansas. Each refueling stop will be one hour. Arrival at Andrews is scheduled for 8:25 pm E.D.T.

5:40 pm  
(E.D.T.)

THE PRESIDENT arrives Hagerstown Airport, Hagerstown, Maryland and proceeds to board Marine One.

5:50 pm

THE PRESIDENT departs Hagerstown, Maryland en route Camp David.

(Flying Time: 10 Minutes)

6:00 pm

THE PRESIDENT arrives Camp David.

By  
- Faculty Members/  
Utah Valley Community

THIS GUESTS:  
[ 24 people onstage ]

People on team in 1991

Mr. Todd B. ~~Smith~~ <sup>Smith</sup>

Academy VP & BYU

Gov. Bangert

Ut. Gov. Van Oosten

Richard Thompson

• TUMP VIEW (HORSES)

- Thundersburds

To \_\_\_\_\_

Date \_\_\_\_\_ Time \_\_\_\_\_

## WHILE YOU WERE OUT

M \_\_\_\_\_

of \_\_\_\_\_

Phone \_\_\_\_\_

Area Code

Number

Extension

|                   |  |                 |  |
|-------------------|--|-----------------|--|
| TELEPHONED        |  | PLEASE CALL     |  |
| CALLED TO SEE YOU |  | WILL CALL AGAIN |  |
| WANTS TO SEE YOU  |  | URGENT          |  |

RETURNED YOUR CALL

Message \_\_\_\_\_

\_\_\_\_\_

\_\_\_\_\_

\_\_\_\_\_

\_\_\_\_\_

\_\_\_\_\_

Operator \_\_\_\_\_



**AMPAD**  
EFFICIENCY®

23-023

**CARBONLESS**



THE WHITE HOUSE

WASHINGTON

VISIT OF THE PRESIDENT

TO

SALT LAKE CITY, UTAH

JULY 17 - 18, 1992

EVENT: Meeting with Mormon Church Leaders

DATE: Friday, July 17, 1992

TIME: 3:00 pm - 3:45 pm

LOCATION: North Board Room, Church of Jesus Christ of Latter Day Saints Administration Building

ATTENDEES: 20

PRESS: Expanded Pool (At Conclusion Only)

SCENARIO: THE PRESIDENT arrives The Church of Jesus Christ of Latter Day Saints, Administration Building and is met by: Mr. Bruce Olsen, Director, Public Affairs, Church of Latter Day Saints. Following the Greeting, THE PRESIDENT, accompanied by Mr. Olsen, proceeds to North Board Room. THE PRESIDENT, accompanied Mr. Olsen, arrives North Board Room and is Met by: President Gordon B. Hinckley, First Counselor and President Thomas S. Monson, Second Counselor. Following the Greetings, THE PRESIDENT, accompanied by President Hinckley and President Monson, takes Seat and begins participation in Meeting. THE PRESIDENT, accompanied by President Gordon Hinckley and President Thomas Monson, concludes participation in Meeting, departs North Board Room and proceeds to Foyer for Photo Opportunity. THE PRESIDENT, accompanied by President Hinckley and President Monson, concludes participation in Photo-Opportunity, bids farewell and proceeds to Motorcade. THE PRESIDENT boards Motorcade and departs The Church of Jesus Christ of Latter Day Saints, Administration Building en route Marriott.

The backdrop for the Photo-Opportunity are marble pillars flanked by plants.

THE WHITE HOUSE  
WASHINGTON

VISIT OF THE PRESIDENT  
TO  
SALT LAKE CITY, UTAH  
JULY 17 - 18, 1992

EVENT: Meeting with Utah GOP Leaders  
DATE: Friday, July 17, 1992  
TIME: 4:00 pm - 4:30 pm  
LOCATION: Salon J, Marriott Hotel  
ATTENDEES: 20-50 Participants  
PRESS: Closed  
SCENARIO: THE PRESIDENT arrives Marriott and proceeds upstairs to Salon J. THE PRESIDENT arrives Salon J, takes Seat, and begins participation in Meeting. THE PRESIDENT concludes participation in Meeting, departs Salon J and proceeds to Suite.

THE WHITE HOUSE

WASHINGTON

VISIT OF THE PRESIDENT

TO

SALT LAKE CITY, UTAH

JULY 17 - 18, 1992

EVENT: Ask George Bush with Outdoor Groups

DATE: Saturday, July 18, 1992

TIME: 9:00 - 9:30 am

LOCATION: Water Pavilion Garden, Red Butte Gardens

ATTENDEES: 150

PRESS: Expanded Pool

SCENARIO: THE PRESIDENT arrives Red Butte Gardens and is met by: Mr. and Mrs. Arthur K. Smith (June), President, University of Utah and Ms. Mary Pat Matheson, Director, Red Butte Garden and Arboretum. Following the Greetings, THE PRESIDENT, accompanied by President and Mrs. Smith and Ms. Matheson, proceeds up walkway to the Water Pavilion Garden. THE PRESIDENT arrives Water Pavilion Garden and is introduced by Lt. Governor W. Val Oveson. THE PRESIDENT proceeds to Park Bench and begins participation in Ask George Bush Meeting. THE PRESIDENT concludes participation in Ask George Bush Meeting, departs Water Pavilion Garden and proceeds to Motorcade. THE PRESIDENT boards Motorcade and departs Red Butte Gardens en route Salt Lake City International Airport.

The backdrop is a pond, wild flowers and mountain vista (Wasatch Mountain Range of the Rocky Mountains). The press are located straight-on at 35 feet on ground level. A slightly raised platform is straight-on at 20 feet.

THE WHITE HOUSE

WASHINGTON

VISIT OF THE PRESIDENT

TO

PROVO, UTAH

JULY 17 - 18, 1992

EVENT: Address to Brigham Young University and Provo Community

DATE: Saturday, July 18, 1992

TIME: 11:10 am - 11:35 am

LOCATION: Marriott Center, Brigham Young University

ATTENDEES: 20,000 University Student and Members of Community

PRESS: Open

SCENARIO: THE PRESIDENT arrives Brigham Young University Marriott Center and proceeds to Holding Room and holds briefly. THE PRESIDENT departs Holding Room and, accompanied by Mr. Rex Lee, President, Brigham Young University proceeds to Off-Stage Announcement Area and holds briefly. THE PRESIDENT, accompanied by Mr. Lee, is announced onto stage to Full Honors played by Timpview High School Orchestra, proceeds to Seat and is seated (Enter Stage Right). THE PRESIDENT is introduced for Remarks by Mr. Lee. THE PRESIDENT Remarks. (NOTE: A teleprompter will be used.) THE PRESIDENT concludes Remarks returns to Seat and remains standing. Mr. Lee proceeds to Podium and introduces West Ridge Elementary School Choir and the benediction. The West Ridge Elementary School Choir performs "A Thousand Points of Light". (NOTE: The West Ridge Elementary School Choir is located immediately behind the Stage. During the performance, they will hold "candles" representing the thousand points of light.) Upon conclusion of the performance, Luana Miller, Student, Brigham Young University, proceeds to podium and offers the Benediction. Following the benediction, THE PRESIDENT, accompanied by Mr. Lee and The Honorable Joseph Jenkins, Mayor of Provo, departs Stage (Exit Stage Right) and proceeds to Holding Room. En route to Holding Room, THE PRESIDENT is met by: Mr. Jason Hall, President, Brigham Young

Student Body. Mr. Hall presents THE PRESIDENT with a Brigham Young University t-shirt. (NOTE: Mr. Hall, is restricted to a wheelchair). Upon conclusion of the gift presentation, THE PRESIDENT, accompanied by Mr. Lee and Mayor Jenkins, proceeds to Holding Room. THE PRESIDENT, accompanied by Mr. Lee and Mayor Jenkins, arrives Holding Room and participates in Gift Presentations. (NOTE: THE PRESIDENT is presented with books by Mr. Lee and a Statuette by Mayor Jenkins. Following the presentations, THE PRESIDENT departs Holding Room and proceeds to Motorcade. (NOTE: Six Police Photos will be taken at this time.) THE PRESIDENT boards Motorcade, departs Marriott Center en route to Provo Airport.

The Backdrop is a 100 member children's choir and a blue and white banner reading "BYU and Utah Families Welcome President Bush." The Press Platform is located straight-on at 55 feet.



Salt Lake City  
International  
Airport

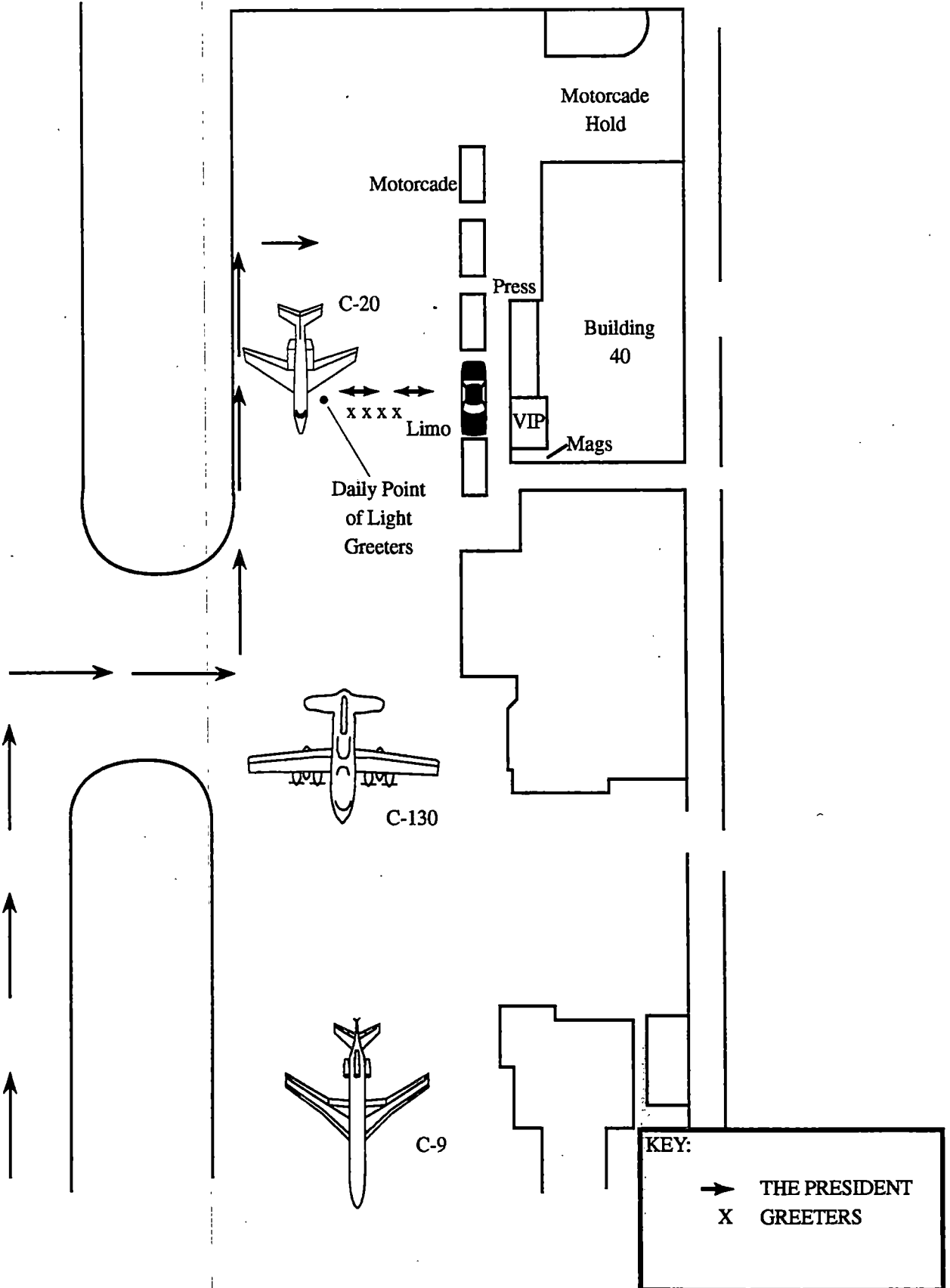

TAB B  
 SALT LAKE CITY, UTAH  
 Marriott Hotel - Garage Level  
 Arrival/Departure Diagram  
 July 17 - 18, 1992

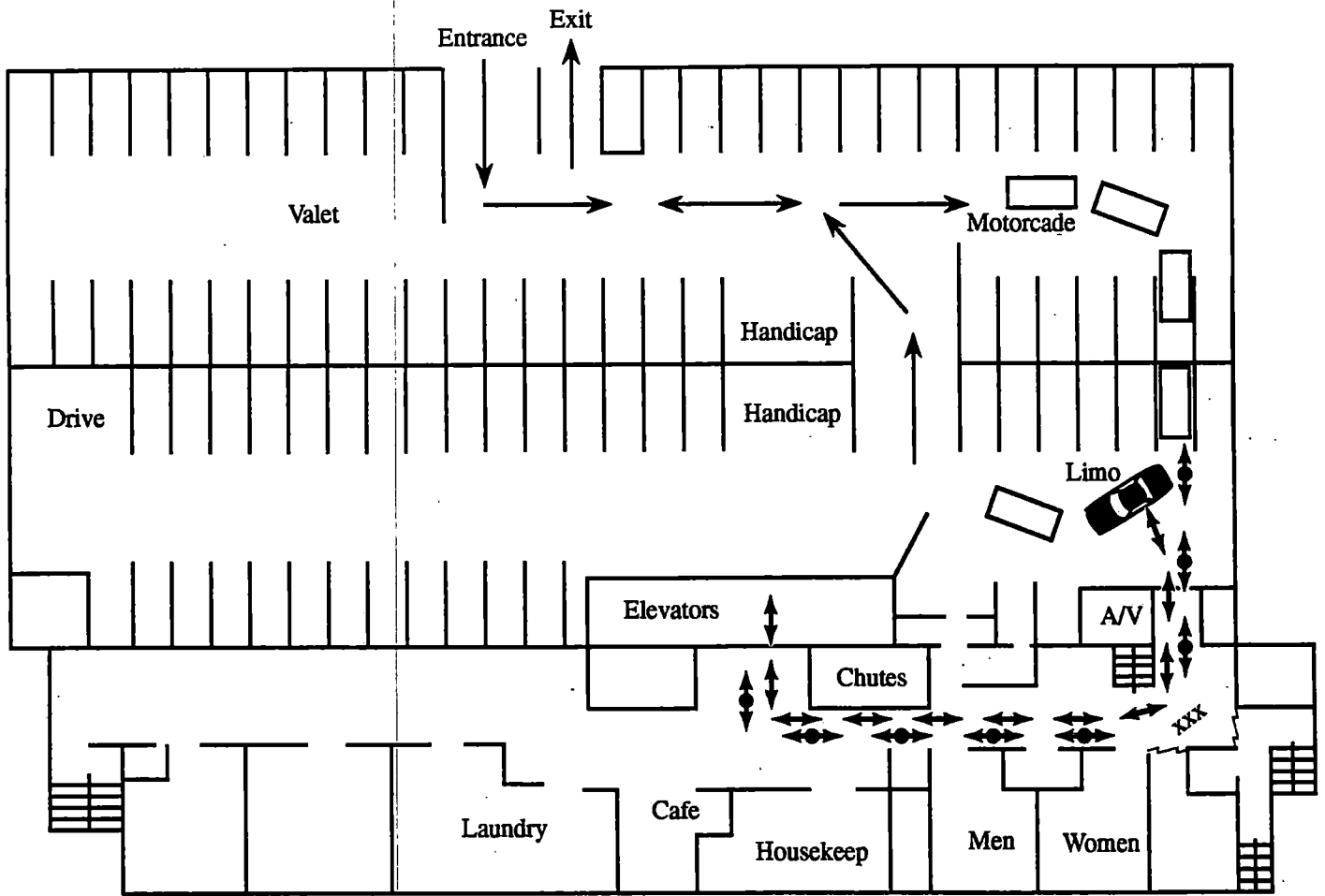

P-1 Parking Garage and Back of House

**KEY:**

- THE PRESIDENT
- GUESTS / STAFF
- X GREETERS



**TAB D**  
**SALT LAKE CITY, UTAH**  
**Latter Day Saints Church Administration Building**  
**Meeting With Leadership**  
**Friday, July 17, 1992**

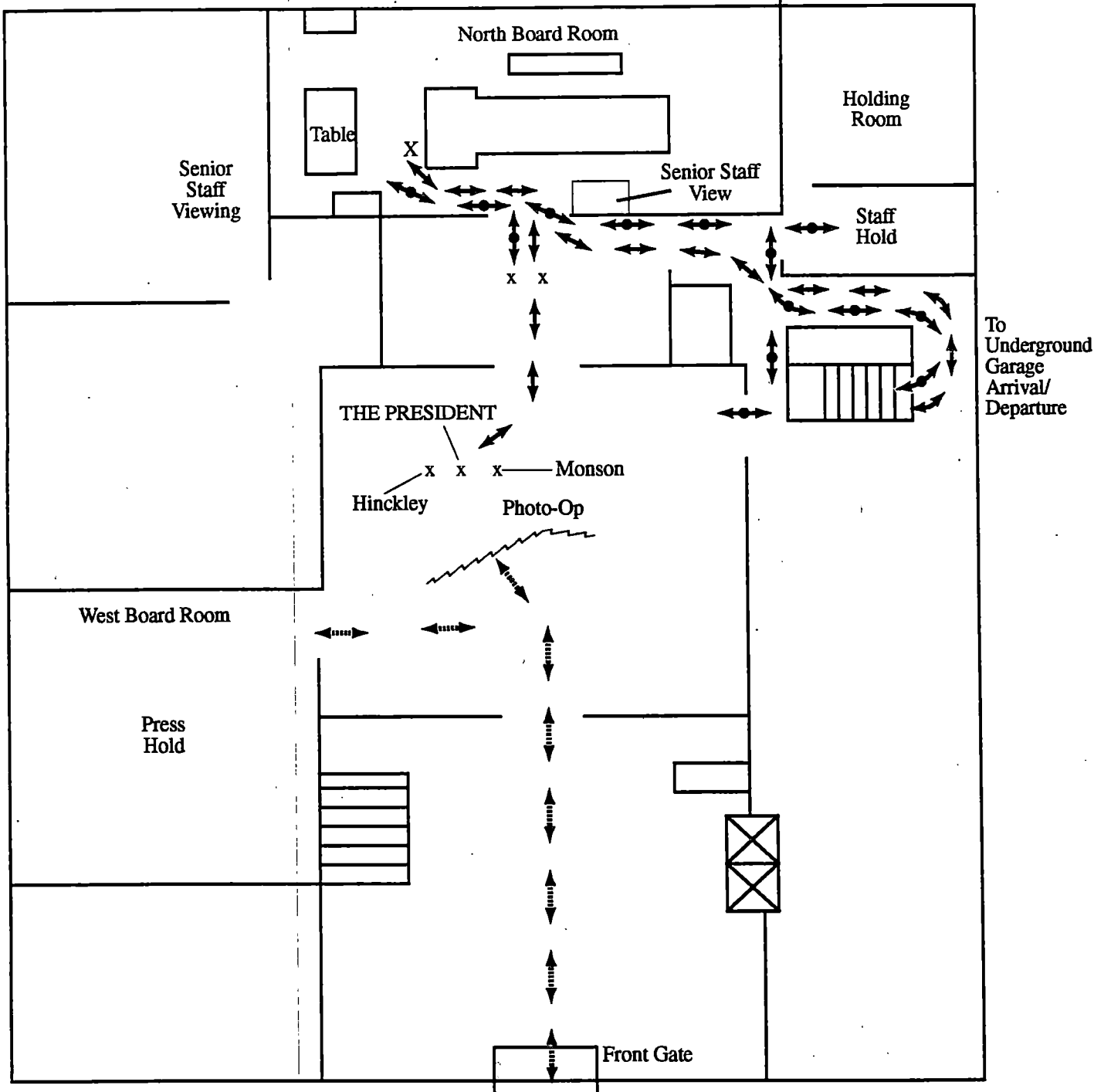

**KEY:**

- THE PRESIDENT
- GUESTS / STAFF
- - - - -> PRESS POOL
- X GREETERS

TAB E  
 SALT LAKE CITY, UTAH  
 Latter Day Saints Church  
 Meeting With Church Leadership  
 Friday, July 17, 1992

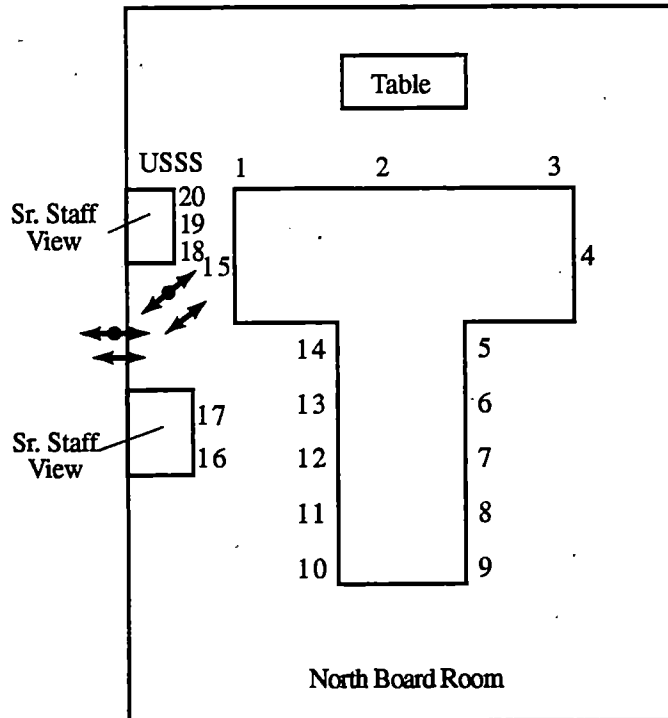

1. THE PRESIDENT
2. President Gordon Hinckley
3. President Thomas Monson
4. Sec. Michael Watson
5. Elder Russell Nelson
6. Elder Dalin Oaks
7. Elder Russell Ballard
8. Elder Joseph B. Wirthlin
9. Elder Richard Scott
10. Elder Neal Maxwell
11. Elder James Faust
12. Elder David Haight
13. Elder Tom Perry
14. Elder Boyd Packer
15. President Howard Hunter
16. Samuel Skinner
17. Bruce Olsen, Dir. Public Affairs
18. Roger Porter
19. Judy Smith
20. Dave Hanson, Executive Director, Utah Republican Party

**KEY:**

- THE PRESIDENT
- GUESTS / STAFF

TAB F  
SALT LAKE CITY, UTAH  
Red Butte Gardens  
Arrival/Departure Diagram  
Saturday, July 18, 1992

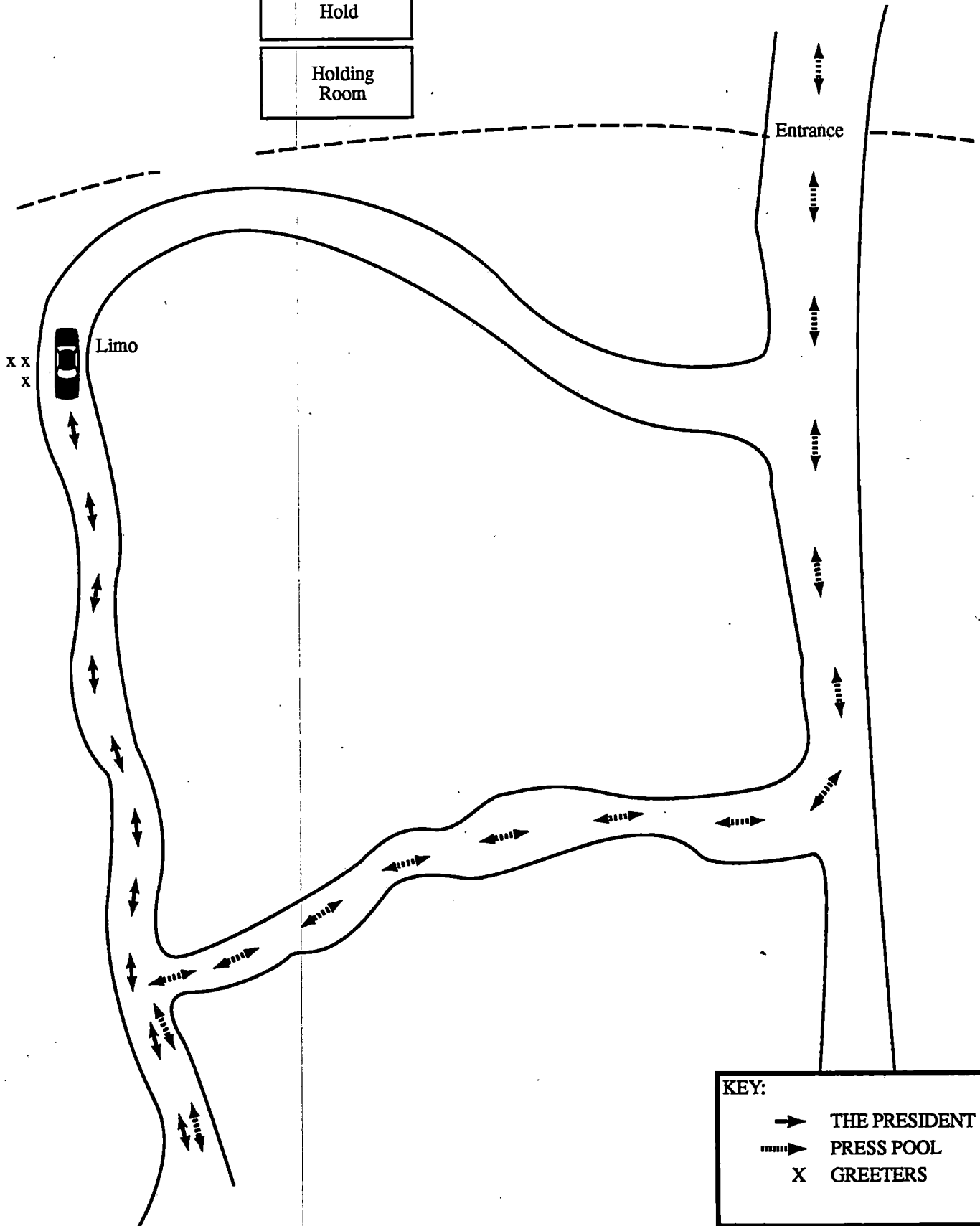
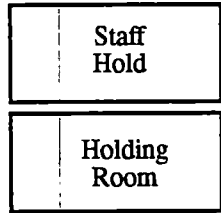

TAB G  
 SALT LAKE CITY, UTAH  
 Red Butte Gardens  
 Ask George Bush  
 Saturday, July 18, 1992

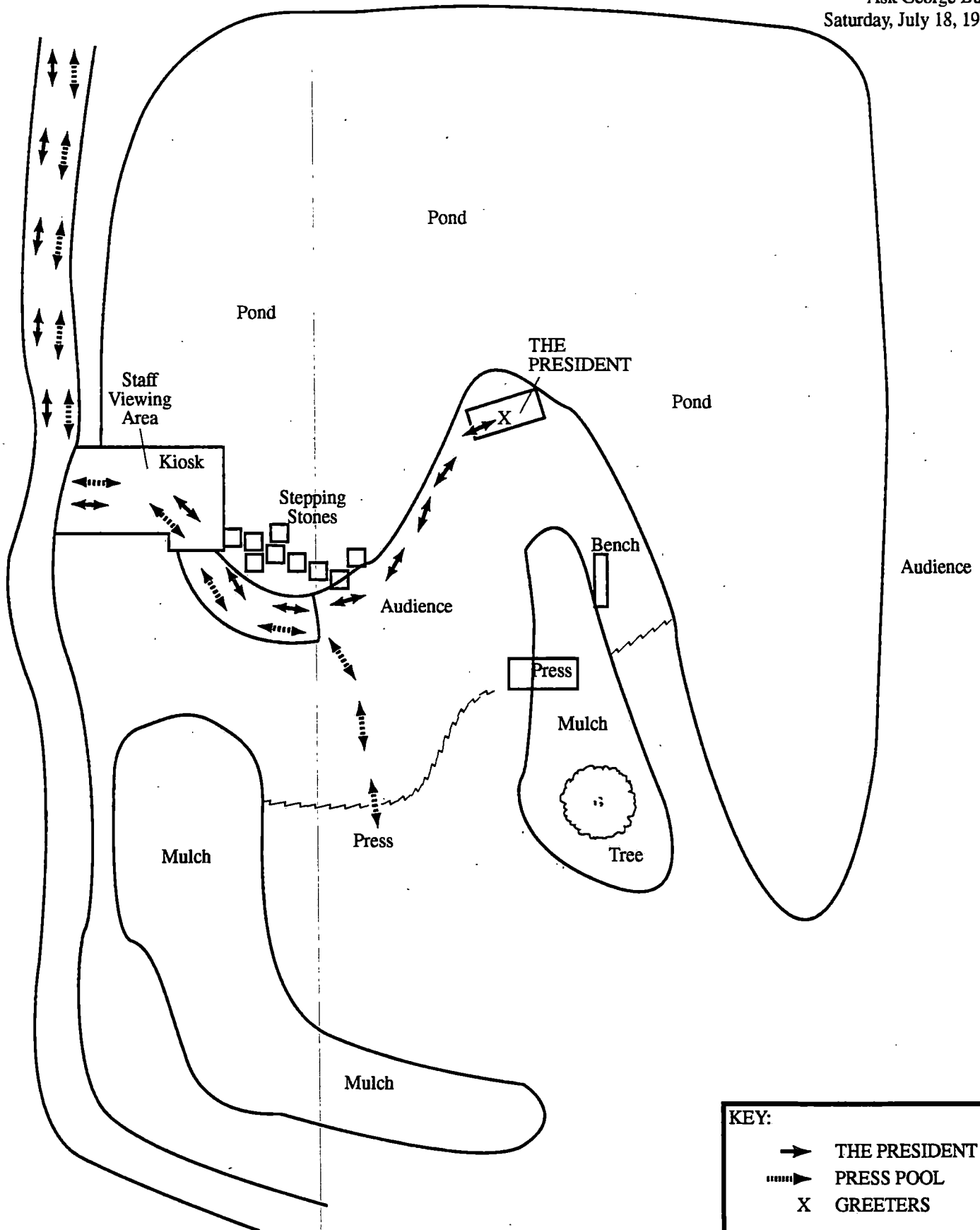

KEY:  
 → THE PRESIDENT  
 ..... PRESS POOL  
 X GREETERS

TAB H  
PROVO, UTAH  
Airport  
Arrival/Departure Diagram  
Saturday, July 18, 1992

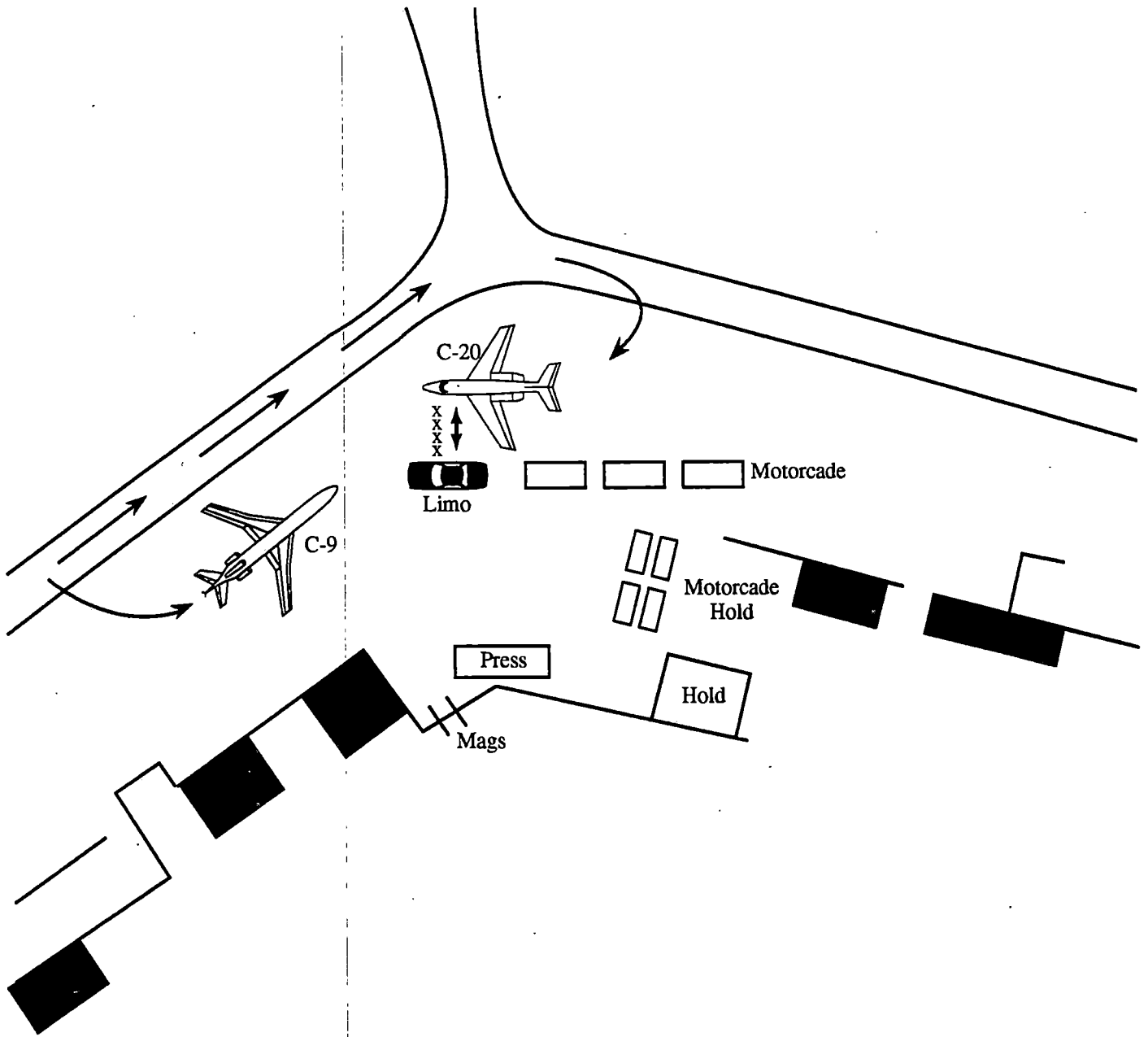

KEY:

→ THE PRESIDENT

TAB I  
 PROVO, UTAH  
 Brigham Young University  
 Marriott Center  
 Arrival/Departure Diagram  
 Saturday, July 18, 1992

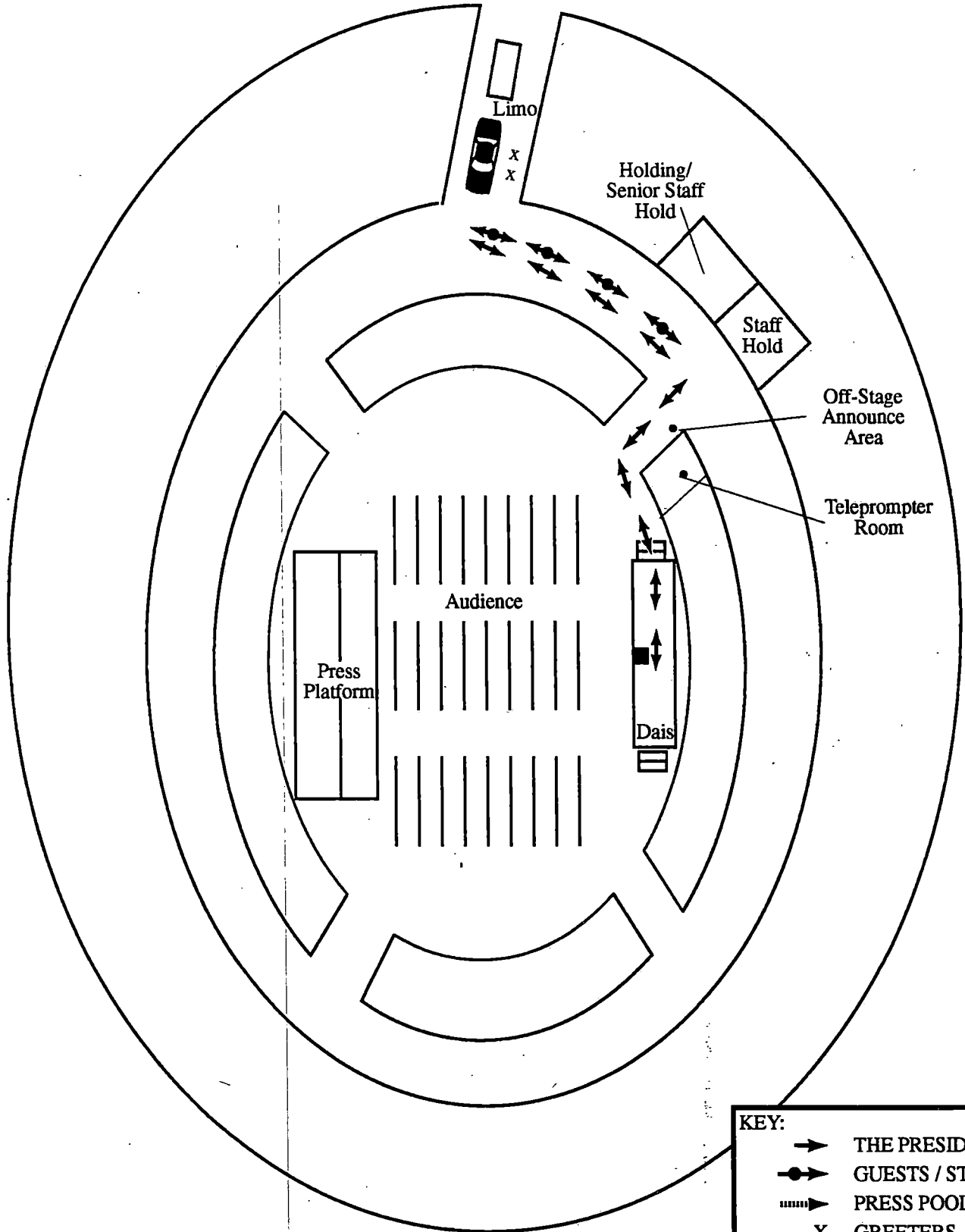
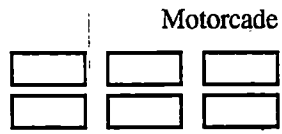

**KEY:**

- THE PRESIDENT
- GUESTS / STAFF
- .....→ PRESS POOL
- X GREETERS

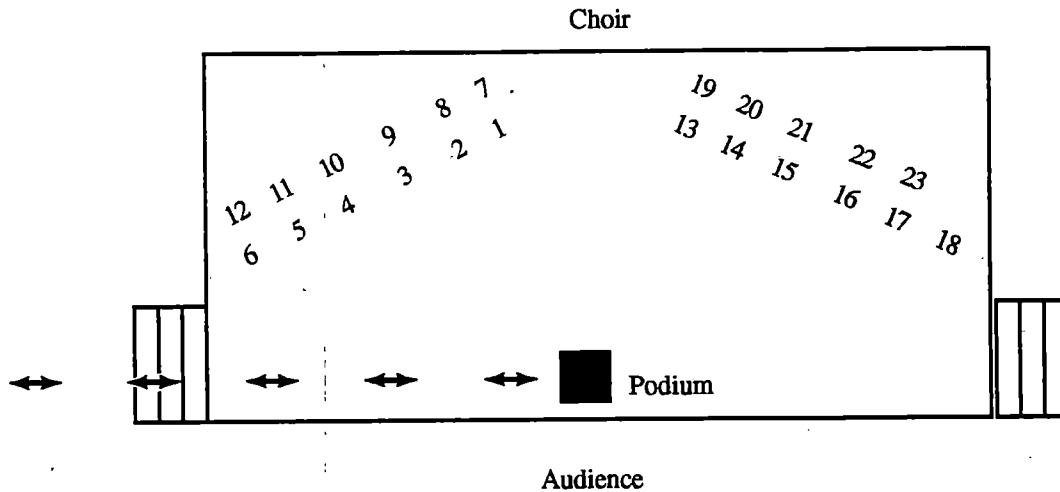

1. President Rex Lee, President Brigham Young University
2. THE PRESIDENT
3. Senator Jake Garn
4. Governor Norman Baugertee
5. Senator Orrin Hatch
6. Richard Harrington, Candidate Utah 3rd Congressional District
7. Jon Huntsman, President Huntsman Chemical
8. USSS
9. Joseph Cannon, US Senator Candidate
10. Mike Leavitt, Utah Gubernatorial Candidate
11. Bob Bennett, US Senate Candidate
12. Richard Eyre, Utah Gubernatorial Candidate
13. Bruce Hafen, Provost, Brigham Young University
14. Lt. Governor Val Oveson
15. Joseph Jenkins, Mayor of Provo
16. Bruce Hough, Utah GOP Chairman
17. Lewis Billings, Utah County GOP Chair
18. Dee Anderson, Vice President, Brigham Young University
19. Luana Miller, Student Prayer
20. Enid Green, Candidate Utah 2nd Congressional District
21. Jim Bartletson, Candidate Utah 2nd Congressional District
22. Ron Hyde, Vice President, Brigham Young University
23. Donald Butler, Chairman Provo City Council

KEY:

→ THE PRESIDENT

ROOM LIST

WHITE HOUSE ROOM LIST

FOR

SALT LAKE CITY AND PROVO, UTAH

JULY 17 - 18, 1992

| OFFICE              | HOTEL    | ROOM           | DROP  |
|---------------------|----------|----------------|-------|
| Staff Office        | Marriott | 1433           | 37220 |
| Senior Staff Office | Marriott | 1626           | 37281 |
| USSS Command Post   | Marriott | 1220           | 37238 |
| WHCA Office         | Marriott | 1422           | 37240 |
| WHCA Comm. Center   | Marriott | 1404           | 37242 |
| Press Office        | Marriott | 1434           | 37227 |
| Filing Center       | Marriott | Alta and Snow. |       |
| Travel Office       |          |                | 37217 |
| Security Room       | Marriott | 1519           | 37308 |
| Pantry              |          |                | 37307 |
| Motorpool Dispatch  | Marriott | 234            |       |

| LAST NAME  | FIRST    | HOTEL     | ROOM | DROP  |
|------------|----------|-----------|------|-------|
| ARMSTRONG  | Tom      | Marriott  | 1437 |       |
| BAUTISTA   | Manolita | Marriott  | 1510 | 37387 |
| BIDDLE     | Susan    | Marriott  | 1527 | 37338 |
| BYERS      | Bob      | Marriott  | 1523 |       |
| BUSCH      | Michael  | Marriott  | 1536 | 37334 |
| CALVERY    | Steve    | Marriott  | 1601 |       |
| CARPENTER  | Dave     | Marriott  | 1538 |       |
| CLARK      | Torrie   | Marriott  | 1535 |       |
| COLEMAN    | Herbert  | Marriott  | 1424 |       |
| COLLINS    | Tracey   | Marriott  | 1637 |       |
| DREYLINGER | John     | Marriott  | 1634 | 37216 |
| FARISH     | Bill     | Marriott  | 1511 | 37325 |
| FERNANDEZ  | Ramon    | Marriott  | 1432 |       |
| GAILLARD   | Peter    | Excelsior |      |       |
| GAUGHAN    | John     | Marriott  | 1439 | 37380 |
| GWYN       | Robert   | Marriott  | 930  |       |
| HARRISON   | Dianne   | Marriott  | 1425 |       |
| HART       | Kevin    | Excelsior |      |       |
| HERRICK    | John     | Marriott  | 1518 | 37324 |
| HERRING    | Heather  | Marriott  | 1429 |       |
| HOGHAUG    | Erik     | Marriott  | 1632 | 37349 |

| LAST NAME | FIRST     | HOTEL     | ROOM      | DROP  |
|-----------|-----------|-----------|-----------|-------|
| HOOLEY    | Gaylynn   | Marriott  | 1636      |       |
| HOWE      | Adm       | Marriott  | 1516 (12) | 37315 |
| JOHNSON   | Michelle  | Marriott  | 1517      | 37381 |
| JONES     | Jeff      | Marriott  | 1510      |       |
| JUSTICE   | Wayne     | Marriott  | 1438      |       |
| KANE      | Bob       | Marriott  | 1618      |       |
| KAUFMAN   | Ron       | Marriott  | 1532      | 37215 |
| KOROSCIL  | Thomas    | Marriott  | 1515      | 37384 |
| LEANDER   | Susan     | Marriott  | 1635      |       |
| MARTIN    | Christina | Marriott  | 1522      | 37340 |
| MATZ      | Anna      | Marriott  | 1639      |       |
| MCCARDELL | Dan       | Marriott  | 1426      |       |
| MCHALE    | Kevin     | Marriott  | 1408      |       |
| MCQUEENEY | Scott     | Marriott  | 1629      |       |
| MILLER    | Dave      | Marriott  | 601       |       |
| MURNANE   | Ed        | Marriott  | 1524      | 37322 |
| NANCE     | Hopson    | Excelsior |           |       |
| OTT       | Chris     | Marriott  | 1630      |       |
| PEEDE     | Bobby     | Marriott  | 1428      |       |
| PHILLIPS  | David     | Marriott  | 1431      |       |
| PORTER    | Roger     | Marriott  | 1537      | 37319 |
| PROVOST   | Steve     | Marriott  | 1528      |       |
| RAY       | Craig     | Marriott  | 1415      | 37210 |
| RAY       | Topper    | Marriott  | 1427      | 37213 |
| SANCHEZ   | Godó F.   | Marriott  | 1432      |       |
| SHEBUSKI  | Ellen     | Marriott  | 1430      | 37385 |
| SKINNER   | Sam       | Marriott  | 1506 (2)  | 37313 |
| SKRODZKI  | Ed        | Marriott  | 1218      | 37230 |
| SMITH     | Judy      | Marriott  | 1520      | 37333 |
| SOBICH    | Peter     | Marriott  | 1625      |       |
| SUNTUM    | Peggy     | Marriott  | 1608      |       |
| TEETER    | Robert    | Marriott  | 1531      |       |
| VALDEZ    | David     | Marriott  | 1540      | 37337 |
| WALSH     | Sean      | Marriott  | 1625      | 37334 |
| YOUNG     | Phil      | Marriott  | 1633      | 37383 |