

Originally Processed With FOIA(s):

S

FOIA Number:

S

# FOIA MARKER

**This is not a textual record. This is used as an administrative marker by the George Bush Presidential Library Staff.**

---

**Record Group/Collection:** Donated Historical Materials

**Collection/Office of Origin:** Frieden, Lex, Collection

**Series:** Related Materials

**Subseries:** Conferences

---

**OA/ID Number:** 52070

**Folder ID Number:** 52070-009

---

**Folder Title:**

"1976 Conference on Systems and Devices for the Disabled, June 10-12, 1976"

---

**Stack:**

**Row:**

**Section:**

**Shelf:**

**Position:**

---

**BIOMEDICAL  
ENGINEERING**

C



T  
E  
R



**1976 CONFERENCE**

**ON**

**SYSTEMS AND DEVICES**

**FOR**

**THE DISABLED**

*SPONSORED BY:*

The Regional Medical Rehabilitation Research and Training  
Center #7, Tufts - New England Medical Center

The Biomedical Engineering Center, Tufts - New England  
Medical Center

The Department of Physical and Rehabilitation Medicine,  
Tufts University School of Medicine

The Rehabilitation Institute, New England Medical  
Center Hospital

June 10, 11, & 12, 1976

BOSTON, MASSACHUSETTS

**PROCEEDINGS**

# The 1976 Conference on Systems and Devices for the Disabled

## PROGRAM

Thursday – June 10, 1976

8:00 Registration

9:00 Opening Remarks

## CONCURRENT SESSIONS

### Session A

#### 10:00 TECHNOLOGY IN THERAPY AND EDUCATION

The Systems Point of View and its Application to the Education of the Physically Handicapped

✓ Esposito, Adaptive Therapeutic Systems, Inc.  
New Haven, Conn.

A Complete system for Meeting the Seating Requirements for the Multiply Handicapped

✓ Daher, Holte, Paul, Shriners Hospital for Crippled Children  
Winnipeg, Manitoba

The Synaptor

✓ Tigges, Gingher, State University of New York at Buffalo

### Session C

#### 10:00 SYSTEMS FOR SPINAL CORD INJURED CLIENTS

Voice Recognition and Control System

Clark, Roemer, University of California at Santa Barbara

Talking to Computers - Powerful New Tools for the Physically Disabled

Miller, Scope Electronics Inc., Reston, VA

✓ A Self Contained Pneumatically Operable Tape Recorder/  
Dictaphone for the High Quadriplegic Patient

Gold, Institute of Rehabilitation Medicine, NYU

12:00 Lunch

### Session B

#### 1:30 NON-VOCAL COMMUNICATION

What Do You Do if You Can't Talk with Your Voice or Hands?

✓ LeBlanc, Children's Hospital at Stanford

✓ The Tufts Non-Vocal Communication Program *RT-7*

Baletsa, Foulds, Crochetiere, Tufts - New England Medical Center

A Symbol Communication System for the Non-Verbal Severely Handicapped - with Audio and Sentence Output

✓ Charbonneau, Cassalter, National Research Council of Canada  
Warrwick, Cote, Ottawa Crippled Children's Treatment Centre

Communication System Prescription Following Brainstem Infarction: A Learning Experience

Cockrell, University of Michigan Medical Center  
Konzen, V.A. Hospital, Ann Arbor Michigan

A Programmable Light Box for the Physically Handicapped

Eberle, Southern Methodist U., Romaine, Zale Foundation

Individualization in a Speech Prosthesis System

Eulenberg, Michigan State University

### Session D

#### 1:30 SYSTEMS FOR SPINAL CORD INJURED CLIENTS

Digital Prosthetic System for Communications and Control

Yankielun, Bell Laboratories, Homdel, N.J.

Wheelchair Based Environmental Control for Quadriplegics

Bayer, Beery, Romich, Romich, Beery and Bayer Inc.  
Shreve, Ohio

Spoon Lifter Self Feeding Device

Morewood, Winsford Products, Inc.  
Pennington, N.J.

✓ Preliminary Report: Evaluation of Various Electronic Devices  
to Increase Mobility and Independence of Very High Level  
Quadriplegic Patients

Zimmerman, Palsgrove, Stratford, Institute of Rehabilitation  
Medicine, NYU

A Powered Control for the Operation of a Cassette Tape  
Recorder with a Mouth Stick

French, Siechen, Silverstein, Johns Hopkins University

# PROGRAM

Friday – June 11, 1976

## CONCURRENT SESSIONS

### Session E

#### 9:00 NON-VOCAL COMMUNICATION

The Three Basic Approaches to Communication for Non-Vocal Individuals and the Development of "Universal" Adaptable Aides  
Raitzer, University of Wisconsin

Teaching Typing Skills to C.P. Children  
Bullock, Kennedy Memorial Hospital, Boston

RETA - Remote Electronic Typing Aid  
Stromsmoe, University of Alberta  
Kozak, Vaneldik, Kingma Harding and Assoc. Ltd.

Computer Aided Communication Device  
Tallman, United Cerebral Palsy of Middlesex Co.  
Edison, N.J.

Electronic Visual Communicator  
Rogers, United Cerebral Palsy of Western N.Y.

A Display Board for Non-Vocal Communication Encoded as Eye Movements  
Rosen, Drinker, Dalrymple, M.I.T., Cambridge

### Session G

#### 9:00 SENSORY MOTOR MEASUREMENT AND CONTROL

✓ A Single System for Displaying EMG Activity, Designed for Therapy, Documentation of Results, and Analysis of Research  
Brudny, Weisinger, Silverman, ICD Rehabilitation and Research Center, N.Y.C.

✓ Biomedical Engineering Experience and Developments in Functional Electrical Stimulation  
Canzoneri, Koenig, Jameson, TIRR/Baylor College of Medicine, Houston

A System for the Measurement of Vertical Foot Forces  
Molinder, Sergengecti, Harvey Mudd College  
Levin, C. F. Braun Co.

EMG Kneelocking Prosthesis  
Carter, Austin, Polytechnic Institute of New York

Clinical Application of the Improved Boston Arm  
Williams, Liberty Mutual Research Center

12:00 Lunch

### Session F

#### 1:30 MOBILITY AIDS AND WHEELCHAIR CONTROLS

✓ A Pneumatically Activated Electronic Controller for a Powered Wheelchair  
Kaplan, Childress, Stysik, Northwestern University

An Ocular Control Device for Use by the Severely Handicapped  
Rinard, Rugg, University of Denver

Automotive Controls for the Handicapped  
Reichenberger, V.A. Bioengineering Research Service

✓ A Proportional Speed Breath Operated Motorized Wheelchair For Quadriplegic and other Severely Disabled Patients  
Youdin, Institute of Rehabilitation Medicine, NYU

Mass Transportation for the Handicapped and Elderly-Myth, Daydream, or Impending Reality?  
DeBenedictis, The Franklin Institute of Philadelphia

On the Road and Out of the Mud  
Stryker, University of Massachusetts

### Session H

#### 1:30 INNOVATIVE PROGRAMS

Therapy Projects in Mechanical Engineering Design  
Pfeiffer, McGill University

"Do it Yourself" Devices for the Disabled  
Warren, Draper Laboratories, Cambridge, Mass.

Clinical Engineering Laboratory  
Sheppard, Page, Clason, Brown, University of Maine

Toys as Learning Materials and Sensory Enhancers for Hearing Impaired Children  
Kemnitzner, Michigan State University

Bridging the Humanist - Mechanist Gap - Creative Technological Aids for the Disabled  
Dalrymple, Kaufman, MIT  
Dristoch, Kamil, Kennedy Memorial Hospital

## PROGRAM

Saturday — June 12, 1976

### CONCURRENT SESSIONS

#### Session I

##### 9:00 SYSTEMS OF TECHNICAL SERVICE DELIVERY

Delivery of Technical Services to the Handicapped Child  
Daher, von Kampen, Shriner's Hospital for Crippled Children

The Rehabilitation Engineering Clinic  
Gaddis, Tufts - New England Medical Center

Technical Aids for the Severely Physically Disabled  
Perry, Kinsmen Rehabilitation Foundation of B.C.

The Clinical Engineer: Newest Member of the Spinal Cord  
Injury Rehabilitation Team  
Sheredos, Castle Point V.A. Hospital

Device-Aided Family Care of a Severely Handicapped Person  
van Lint, Mission Research Corp., San Diego, California

#### Session K

##### 9:00 SENSORY IMPAIRMENT

What's New in Recording Equipment for the Blind?  
Morris, American Printing House for the Blind

Audiometric Determination of Urinary Glucose Concentration  
for the Visually Impaired Diabetic Patient  
Ereneh, Siebens, Seltzer, Johns Hopkins University

Psychological Factors Having a Bearing on Successful  
Utilization of Prosthetics and Sensory Aids  
De l'Aune, Eastern Blind Rehabilitation Center  
Needham, V.A. Hospital, West Haven, Conn.

The ARTS Computer  
Duran, Protestant Guild for the Blind

Audio Response Equipment for the Blind  
Hopkins, State of Washington Dept. of Social & Health Serv.

The Vari Speech II - Speech Time Compressor/Expander  
Lee, MIT

12:00 Lunch

#### Session J

##### 1:30 VOCATIONAL REHABILITATION

Industrial Engineering Application in a Sheltered Workshop  
Environment  
Swarts, Smith, Texas A & M University

Tennessee Valley Authority: A Demonstration Project in  
Vocational Rehabilitation and Biomedical Engineering  
Craig, Hilton, Campbell, Tennessee Valley Authority  
Wm.

#### Session L

##### 2:30 SENSORY IMPAIRMENT

SPELLEX - A System of Speech Aids for the Visually  
Handicapped in Vocational Training  
Suen, Beddoes, Concordia University, Montreal, Canada

Deafness - Blindness and Resultant Communication Problems  
Kruger, National Center for Deaf-Blind Youths and Adults

The Development of a Real-Time Spectrograph, with  
Implications for Speech Training for the Deaf  
Stewart, Larkin, Houde, Center for Communications Research

Auditory Aid to Deaf Speakers in Monitoring Fundamental  
Voice Frequencies  
Villchur, Foundation for Hearing Aid Research  
Killion, Industrial Research Products

A New Approach to Aural Prosthetics  
Hotch, Mitre Corporation

A Comparison of Frequency Spectral Shifting and Frequency  
Division as a Possible Hearing Aid  
Campbell, Shultheis, Barton, Ohio State University

## TABLE OF CONTENTS

	Page
Editors Note	i
Program	ii
 <u>SESSION A: TECHNOLOGY IN THERAPY AND EDUCATION</u>	
The Systems Point of View and its Application to the Education of the Physically Handicapped Esposito, Adaptive Therapeutic Systems, Inc., New Haven, Conn.	1
A Complete System for Meeting the Seating Requirements for the Multiply Handicapped Daher, Holte, Paul, Shriners Hospital for Crippled Children Winnipeg, Manitoba	5
The Synaptor Tigges, Gingher, State University of New York at Buffalo	9
 <u>SESSION B: NON-VOCAL COMMUNICATION</u>	
What Do you Do if You Can't Talk with Your Voice or Hands? LeBlanc, Children's Hospital at Stanford	12
The Tufts Non-Vocal Communication Program Baletsa, Foulds, Crochetiere, Tufts-New England Medical Center	14
A Symbol Communication System for the Non-Verbal Severely Handicapped - with Audio and Sentence Output	18
Communication System Prescription Following Brainstem Infarction: A Learning Experience Cockrell, University of Michigan Medical Center Konzen, V.A. Hospital, Ann Arbor, Michigan	20
A Programmable Light Box for the Physically Handicapped Eberle, Southern Methodist U., Romaine, Zale Foundation	23

	Page
<u>SESSION C: SYSTEMS FOR SPINAL CORD INJURED CLIENTS</u>	
Talking to Computers - Powerful New Tools for the Physically Disabled Miller, Scope Electronics Inc., Reston, VA	25
A Self Contained Pneumatically Operable Tape Recorder/Dictaphone for the High Quadriplegic Patient	30
<u>SESSION D: SYSTEMS FOR SPINAL CORD INJURED CLIENTS</u>	
Wheelchair Based Environmental Control for Quadriplegics Bayer, Beery, Romich, Romich, Beery and Bayer, Inc. Shreve, Ohio	33
Spoon Lifter Self Feeding Device Morewood, Winsford Products, Inc., Pennington, N.J.	38
Interim Report: Evaluation of Various Electronic Devices to Increase Mobility and Independence of Very High Level Quadriplegic Patients Zimmerman, Palsgrove, Stratford, Institute of Rehabilitation Medicine, NYU	42
A Powered Control for the Operation of a Cassette Tape Recorder with a Mouth Stick French, Siebens, Silverstein, Johns Hopkins University	45
<u>SESSION E: NON-VOCAL COMMUNICATION</u>	
The Three Basic Approaches to Communication for Non-Vocal Individuals and the Development of "Universal" Adaptable Aides Raitzer, University of Wisconsin	50
Teaching Typing Skills to C.P. Children Bullock, Kennedy Memorial Hospital, Boston	55
RETA - Remote Electronic Typing Aid Stromsmoe, University of Alberta Kozak, Vaneldik, Kingma Harding and Assoc. Ltd.	57

	Page
Computer Aided Communication Device Tallman, United Cerebral Palsy of Middlesex Co, Edison, N.J.	61
Electronic Visual Communicator Rogers, United Cerebral Palsy of Western, N.Y.	66
A Display Board for Non-Vocal Communication Encoded as Eye Movements Rosen, Drinker, Dalrymple, MIT, Cambridge	70

SESSION F: MOBILITY AIDS AND WHEELCHAIR CONTROLS

A Pneumatically Activated Electronic Controller for a Powered Wheelchair Kaplan, Childress, Stryzik, Northwestern University	72
An Ocular Control Device for Use by the Severely Handicapped Rinard, Rugg, University of Denver	76
Automotive Controls for the Handicapped Reichenberger, V.A. Bioengineering Research Service	80
A Proportional Speed Breath Operated Motorized Wheelchair for Quadriplegic and other Severely Disabled Patients Youdin, Institute of Rehabilitation Medicine, NYU	86
Mass Transportation for the Handicapped and Elderly-Myth, Daydream, or Impending Reality? DeBenedictis, The Franklin Institute of Philadelphia	89
On the Road and Out of the Mud Stryker, University of Massachusetts	91

SESSION G: SENSORY MOTOR MEASUREMENT AND CONTROL

A Single System for Displaying EMG Activity, Designed for Therapy, Documentation of Results, and Analysis of Research Brudny, Weisinger, Silverman, ICD Rehabilitation and Research Center, N.Y.C.	93
---	----

	Page
Biomedical Engineering Experience and Developments in Functional Electrical Stimulation Canzoneri, Loenig, Jameson, TIRR/Baylor College of Medicine, Houston, Texas	99
A System for the Measurement of Verticle Foot Forces Molinder, Serdengecti, Harvey Mudd College Levin, C.F. Braun Co.	104
Clinical Application of the Improved Boston Arm Williams, Liberty Mutual Research Center	109
 <u>SESSION H: INNOVATIVE PROGRAMS</u>	
Therapy Projects in Mechanical Engineering Design Pfeiffer, McGill University	114
"Do it Yourself" Devices for the Disabled Warren, Draper Laboratories, Cambridge, Mass.	119
Toys as Learning Materials and Sensory Enhancers for Hearing Impaired Children Kemnitzer, Michigan State University	125
Bridging the Humanist - Mechanist Gap - Creative Technological Aids for the Disabled Dalrymple, Kaufman, MIT Driscoll, Kamil, Kennedy Memorial Hospital	127
 <u>SESSION I: SYSTEMS OF TECHNICAL SERVICE DELIVERY</u>	
Delivery of Technical Services to the Handicapped Child Daher, vonKampen, Shriner's Hospital for Crippled Children	131
The Rehabilitation Engineering Clinic Gaddis, Tufts-New England Medical Center	136
Technical Aids for the Severely Physically Disabled Perry, Kinsmen Rehabilitation Foundation of B.C.	140

	Page
The Clinical Engineer: Newest Member of the Spinal Cord Injury Rehabilitation Team Sheredos, Castle Point V.A. Hospital	142
Device-Aided Family Care of a Severely Handicapped Person vanLint, Mission Research Corp., San Diego, California	146
 <u>SESSION J: VOCATIONAL REHABILITATION</u>	
Industrial Engineering Application in a Sheltered Workshop Environment Swarts, Smith, Texas A & M University	151
Tennessee Valley Authority: A Demonstration Project in Vocational Rehabilitation and Biomedical Engineering Craig, Hilton, Campbell, Tennessee Valley Authority	157
 <u>SESSION K: INNOVATIVE PROGRAMS</u>	
What's New in Recording Equipment for the Blind? Morris, American Printing House for the Blind	159
Audiometric Determination of Urinary Glucose Concentration for the Visually Impaired Diabetic Patient French, Siebens, Seltzer, Johns Hopkins University	162
Psychological Factors Having a Bearing on Successful Utilization of Prosthetics and Sensory Aids De l'Aune, Eastern Blind Rehabilitation Center Needham, V.A. Hospital, West Haven, Conn.	167
The ARTS Computer Duran, Protestant Guild for the Blind	171

SESSION L: SENSORY IMPAIRMENT

SPELLEX - A System of Speech Aids for the Visually Handicapped in Vocational Training Suen, Beddors, Concordia University, Montreal, Canada	175
Deafness - Blindness and Resultant Communication Problems Kruger, National Center for Deaf - Blind Youths and Adults	178
The Development of a Real - Time Speech Spectrograph, with Implications for Speech Training for the Deaf Stewart, Larkin, Houde, Center for Communications Research	184
Auditory Aid to Deaf Speakers in Monitoring Fundamental Voice Frequencies Villchur, Foundation for Hearing Aid Research Killion, Industrial Research Products	189
A New Approach to Aural Prosthetics Hotch, Mitre Corporation	192
A Comparison of Frequency Spectral Shifting and Frequency Division as a Possible Hearing Aid Campbell, Shultheis, Barton, Ohio State University	198

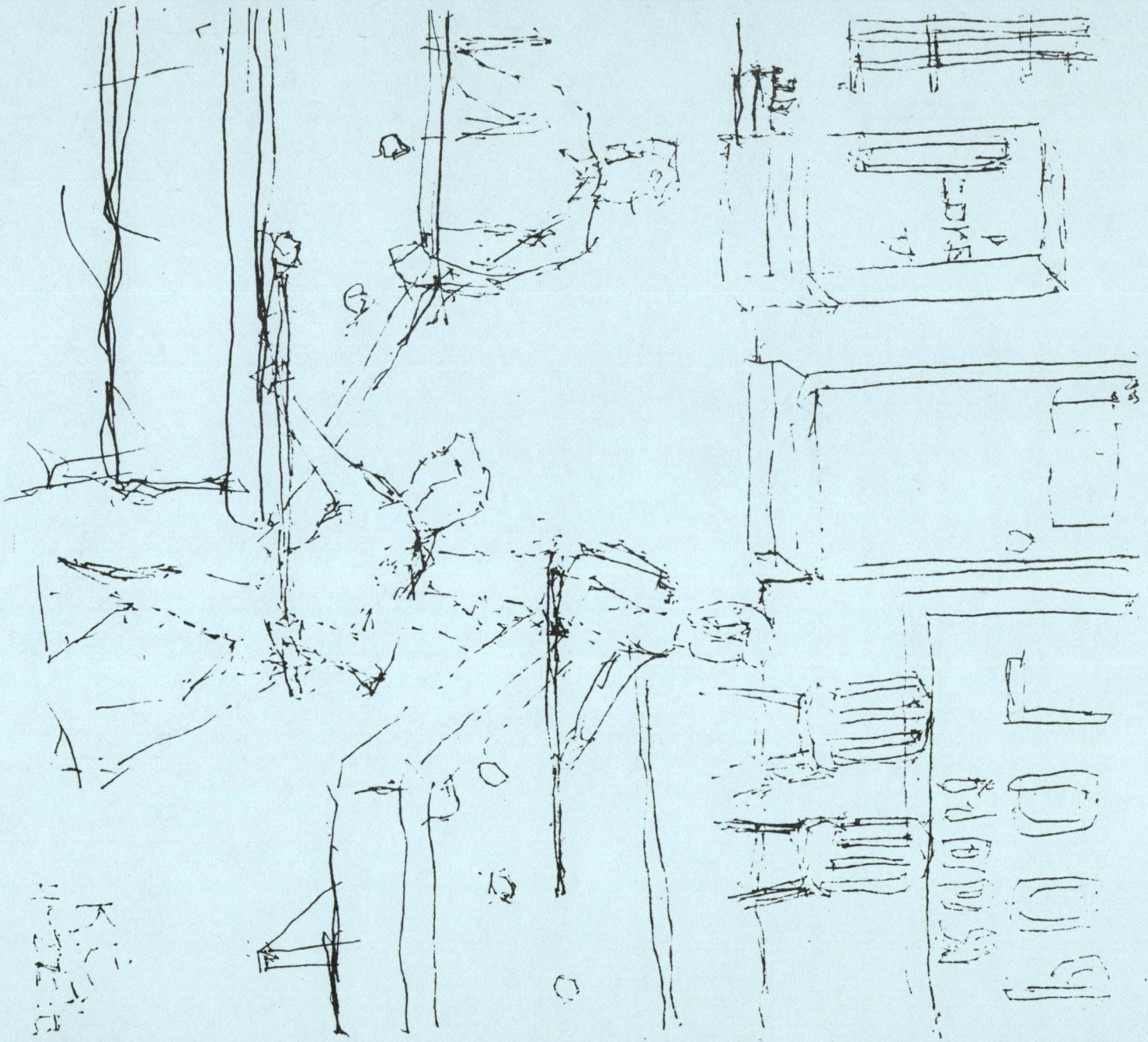

1/20/99  
K. S. H.

# TECHNOLOGY IN THERAPY AND EDUCATION

SESSION A

THE SYSTEMS POINT OF VIEW  
AND ITS APPLICATION TO THE EDUCATION  
OF THE PHYSICALLY HANDICAPPED

by Louis G. Esposito, Vice President  
Adaptive Therapeutic Systems, Inc.  
Madison, Connecticut 06443

Summary - The unmet and to-be-met educational needs of this nation's severely physically handicapped school-aged consumers calls for new and more effective delivery systems. More emphasis needs to be placed on educational product as opposed to process. A typical system is herein discussed which satisfies those needs while not interfering with long-term rehabilitation goals.

The systems point of view, long known to engineering and scientific communities, is more an attitude of mind informed for our purposes here by a background in the behavioral, biological and physical sciences than a precise procession of procedures. Understandably, the concept of a systems approach to the education of a physically handicapped person may seem overly grand to someone engaged in the operation of some limited and isolated aspect of the system. But even this person whether a special educator, a therapist or even the operator of the special school bus will do well to accept this new broadening of perspective which may not, he feels, be imperative for him. These specialists are all functional links in what, when totally integrated, can be a systematic approach to a complex educational problem.

The systems point of view takes into account the whole world within which education for the physically handicapped takes place. To acquire the systems point of view, all of the functional requirements of the educational process at hand have to be considered before a final design is approved. Experts in transportation, as well as education, therapy and administration must be called in to work with the system designers in order to list and analyze as exhaustively as possible, and as early in the program as practical, how the purposes, the requirements, the operations and functions (and the budgets) affect the constraints in all the considerations which affect the design process and ultimately the design of the system itself. Beyond that, the systematic design demands that one works from general considerations to the particular. The body of considerations regarding each aspect of the special educational delivery system must be distilled down to the actual ingredients which will successfully fulfill each process link. A third major point about the systems approach is that

it must be pragmatic in that those the system was designed to benefit, it must benefit. The tests in terms of determining the efficacy of the overall design ought to be built in to the original goals and objectives of the program. Without moralizing, the measurement unit of an educational program ought to be educational-product. And the educational-product must be measured in terms of the actual quotient of it received by the users of the system. Lastly, it is important to consider that all of the above has to be achieved with an attitude of compromise because there are always interdependencies between cost, size, weight, materials, reliability, maintainability, operation, adjustability and staff/user training requirements.

This paper will be limited to a discussion of an application of the systems point of view to a small, but inordinately expensive (in dollar as well as human energy terms) aspect of the total special educational spectrum. The historical lack of demonstrable consistent educational result speaks loudly for a review and alteration of the manner in which educational services are delivered to the severely physically handicapped consumer. This discussion must be further limited to the actual delivery of educational services to these consumers in a classroom setting, for although it is expected that transportation links may ultimately contribute to educational product in ways which use delivery time constructively, no adequate discussion of them is possible at this writing.

Recent events add urgency to the necessity for the program review and alteration mentioned earlier. In late 1975, President Ford signed into law S-6, the Education For All Handicapped Act. Special emphasis under the Act will be directed to the educational needs of the severely physically handicapped. Although

a small group when compared to the nearly 8,000,000 million handicapped school-age children in this nation, they will make up a large percentage increase of new students enrolled as a result of the initiatives of the Act. It is estimated that the population of physically handicapped school-aged is about 400,000. Approximately thirty percent of that number have severe enough orthopedic problems to prevent their receiving an adequate education (assuming of course, that they had gotten into school in the first place). Another twenty-five percent of the total are mentally retarded with slight orthopedic problems which might interfere with their ability to benefit from special educational programs. Let's now consider the former thirty percent (120,000 school aged children) largely unserved, mentally retarded at one end of their spectrum and bright at the other: What has the cost of not applying the systems approach been? Justice delayed is justice denied, for the want of an efficacious method of delivering educational services to this class of user, the cost has been the denial of their rights as citizens to a free and appropriate education. A relatively simple, cost-effective, systematic method of delivering educational services to these consumers is certainly within our capability.

The study of these users, of the ability within their disability, their deficiencies and their needs produces a brand of human engineering which can design and build adaptations to augment their deficient human capabilities. It is difficult to imagine the active use of methods which are costly, difficult to perform, and abstract when considered in terms of the actual educational needs of the physically handicapped consumer - but such is the present situation. Much of the presently relied upon educational programming for these consumers consists of interdisciplinary teams operating in tandem with special educational staffs attempting to modify the student rather than the equipment or the task. There are those who argue that not only does the old method not work, it can't work in view of what is now known about the criteria for its successful application. For a special educator to be forced to wait until therapy can turn over enough in the way of motor performance to accomplish educational goals requiring this performance is a waste of valuable manpower.

Better is a parallel method of approach which restricts its objectives to simplifying the transactions between the student and himself and also the task at hand so that it becomes proper to look for some lowest common motor skill denominators among all this to insure that everyone will be able to see, hear, read, touch, manipulate etc. appropriately enough to accomplish the educational task at hand. The parameters of such a class-

room oriented system follow.

1. General. The system should fit into presently extant manpower schemes. Its intention being to better utilize existing skills and manpower rather than revolutionize the industry. Emphasis should be shifted from personnel-intensive to equipment-intensive wherever possible. Certain aspects of the new educational Program therefore, will actually become part of physical plant as opposed to variable labor cost. Whenever possible the system should contain provisions for synthesizing the efforts of both special education and therapy personnel. When therapy and educational goals are matched it becomes possible to produce the effect of double gains for the same investment of time. Emphasis must be shifted from rehabilitation to function. A therapeutic scheme which is able to provide a student with the functional ability he needs to accomplish is fine as long as its application does not take the student out of class for long periods. A preferred method would be to provide the student with the functional skills he needs to accomplish instantly - in the classroom - without blocking any road to rehabilitation which may be in the students future.

Finally, although emphasis should be shifted from equipment to people, the equipment itself should not limit the individual by, either making him totally dependent on it for accomplishment, or alienating him because of cosmetic factors which produce fear of being conspicuous; or difficulty of operation and the possibility of breakdown.

2. Specific. Positioning is at the center of any program of education for the severely handicapped. Failure to acknowledge the functional importance of this single item can mean the difference between the success or failure of the entire educational mission. Positioning (including prone-positioning) can enhance (if appropriate) or detract from a student's ability to accomplish educational goals. The approaches to positioning are many, but the requirements are clear. Positioning devices must have adjustable capabilities. For cost/user and cost/year considerations a device which can grow with an individual, or be used with a population of different sized people is a must. Other rapidly changeable adjustments will include of necessity the ability to anatomically attitude the body into positions which enhance accomplishment. Such positions would seek to enable all of the bodily sensory feedback systems which contribute to sitting balance. The device ought to offer both passive and active restraints so that various classes of users can be accommodated. Expanding from fitting and attitude to systems considerations, all that the student needs to augment his own capabilities should be a part of the positioning system. Deltoid aids which lift the upper extremities

thus negating gravity can be a valuable assistance. A desk which is at the right height and angle to do the most good for the student is another necessity. Lastly, the positioning device should be as mobile as possible without jeopardizing any of the above. The ideal in this instance would be a portable device accomplishing the above which is an element in the transportation system as well.

Adaptive devices are a second specific area which through their use (or not) will make a difference as to whether a functional task is accomplished. An adaptive device must be specific as to the type of assistance it provides its users. It must be designed from the user out as opposed to from available technology in, taking into consideration the users capabilities and needs, but avoiding prescription at all costs. It must do for the user what it was designed to do in a manner which interferes at a minimum with the individuals long-term ability to wean himself away from the device to independence. The specific functional areas which need to be designed to are communication skills (including writing) and self-help skills, e.g. self-feeding, and other activities of daily living. Central to the issue of designing adaptations is the major goal of a patients ultimate independence (from the inability to accomplish the task, and later from the device itself). Two inputs of knowledge become essential. First, we must know how the nonhandicapped perform a given task, from this the handicapped's deficits are subtracted and the difference is made up in adaptation. Second, we must learn how rehabilitation or muscle re-education takes place so that devices can be designed with these data in mind.

There is nothing in any of the above beyond present technology. One hears the lament, "We put a man on the moon, why can't we educate the physically handicapped?" The reasons are obvious. The lack of clear cut measurable objectives and the cost-ineffect of the methods historically applied have combined to make any comparison to a systems oriented project unrealistic. But it can be changed, and never before in history has there been so great an imperative to do so.

#### References

1. Basmajian, J.V.: Neuromuscular Facilitation Techniques - an editorial. Arch. Phys. Med: 40-42 (Jan.) 1971
2. Bowen, Hugh M.: Rational Design 1. Ind. Des: 58-61 (Feb.) 1964
3. Mancino, P.: An Educational Approach for the Severely Involved Physically Handicapped Person. Copyright 1973, Adaptive Therapeutic System, Inc. Madison, Conn.



BASIC POSITIONING DEVICE (BPD)



BPD WITH DELTOID AID

4. Marinacci, A.A. and Horande, M. Electromyogram in Neuromuscular Re-Education. Bull, L.A. Neurol. Soc.: Vol. 25, No. 2, 57-71, (June) 1960
5. Robinson, R.O.: The Frequency of Other Handicaps in Children With Cerebral Palsy. Dev. Med. Child. Neurol. 15, 305-312, 1973
6. Taft, L.T.: Are We Handicapping the Handicapped? Dev. Med. Child. Neurol. 15, 401-402, 1973
7. Zimmerman, M.E. : Current Concepts and Use of Self-Help Devices. Copyright 1964, WFOT, Wm. C. Brown Co., Inc. Dubuque, Iowa

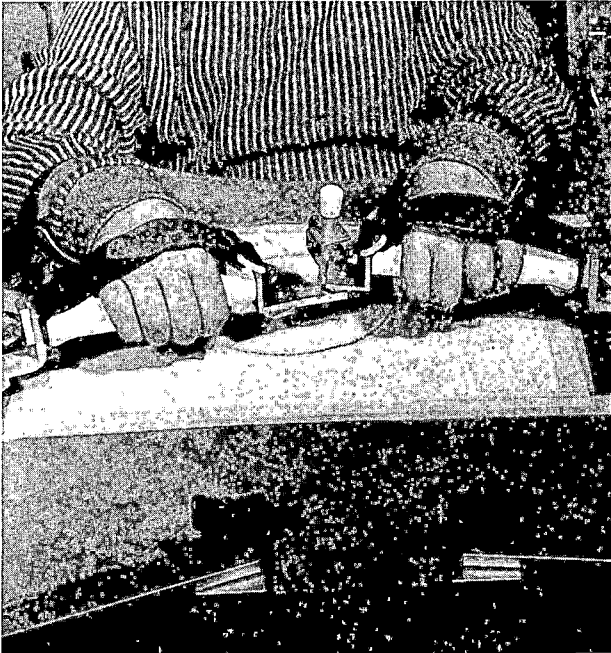

SIMPLE WRITING AID TABLE WRITER-



BPD WITH HEAD POSITION CONTROL

A COMPLETE SYSTEM FOR MEETING THE SEATING  
REQUIREMENTS FOR THE MULTIPLY HANDICAPPED

R. L. Daher, M.Sc.

Director

Rehabilitation Engineering Department  
Shriners Hospital for Crippled Children

R. N. Holte, M.Sc.

Design Engineer

Rehabilitation Engineering Department  
Shriners Hospital for Crippled Children

I. T. Paul

Chief Machinist

Rehabilitation Engineering Department  
Shriners Hospital for Crippled Children

Summary - Provision of functional postural seating for the multiply handicapped to date has been on a more or less individual basis. The concept described is a complete system to meet all seating requirements and involves three subdivisions of the entire program, namely, a clinical fitting or measurement seat; an assembly of prefabricated functional basic components; and custom fitting by either hand shaping of foam casting technique.

#### Introduction

To review the consequences of inadequate support for the unstable spines of multiply handicapped individuals confined to wheelchairs would be repetitious of many articles already published on this subject. Special seating is routinely prescribed by clinic chiefs involved in the medical management of the multiply handicapped. The problem of custom designing and fitting each insert on an individual basis resulted in long delays and many hours of Rehabilitation Engineering staff time spent on each chair. Consequently, a total system approach was evolved which hopefully could be adapted to meet all the functional seating requirements presented for solution to the engineering team.

The sequence of design was in the order described in the following paragraphs.

#### The Fitting Chair

The fitting chair allows for immediate clinical assessment of the patient in an appropriate seated position (Figure 1). In lieu of anatomical measurements of a deformed patient which are correlated to the seating problem, the chair provides basic reference details which are duplicated in the final postural seat (Figure 2). This chair cannot be used if the spine is severely deformed. For these cases the foaming seat (to be described) is employed.

The design criteria considered necessary to accommodate most cases seen at clinic is as follows:

- 1) Adjustable seat angle and depth.
- 2) Adjustable back support angle.
- 3) Adjustable seat/back support angle.
- 4) Various bolster configurations which can be attached at any position on the back (Figure 2



Figure 1, Clinical Application of Fitting Chair

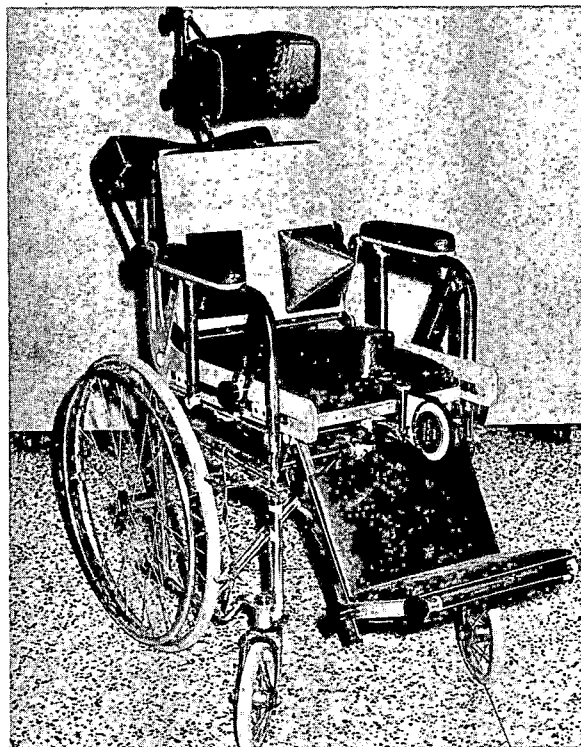

Figure 2, Fitting Chair

- and 3). The seat back is finished in velcro hook backing.
- 5) Variable back support curvature (contour) to provide optimum support in conjunction with the bolsters.
  - 6) Interchangeable head support pads (Figure 4).
  - 7) Variable head support position.
  - 8) Adjustable leg supports: length and angle.

All measurements and angles are recorded on a measurement chart specifically detailed to the fitting chair.

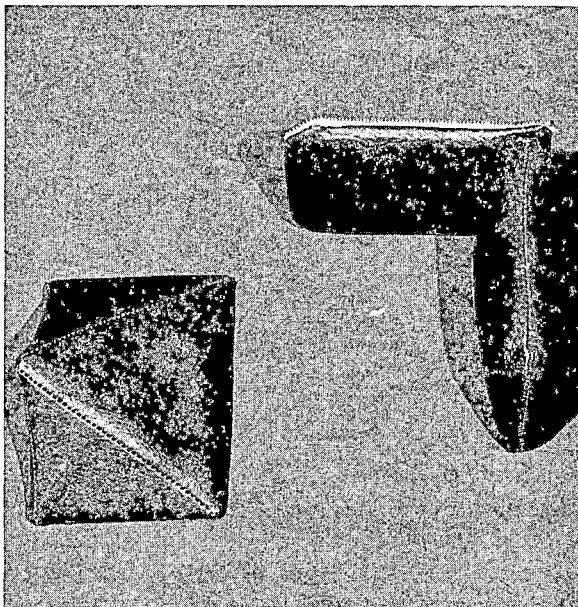

Figure 3, Bolster configurations applied to Back Support

#### Basic Components

The wheelchair insert components are designed on a modular basis so that any combination obtained using the fitting chair can readily be transferred to the final postural seat. Two alternative types of functional components are available. For the patient restricted to a seated position, a fixed angle frame or an optional reclining-tilt mechanism for resting and shifting body weight are available depending on requirements (Figure 5). For the patient who can stand with support a stand-up mechanism may be prescribed (Figures 6 and 7)<sup>1</sup>.

At this time the design of the basic components are in prototype stage. Ultimately all basic components will be manufactured by a commercial enterprise leaving only the final fitting and upholstering for completion by the Rehabilitation Engineering staff.

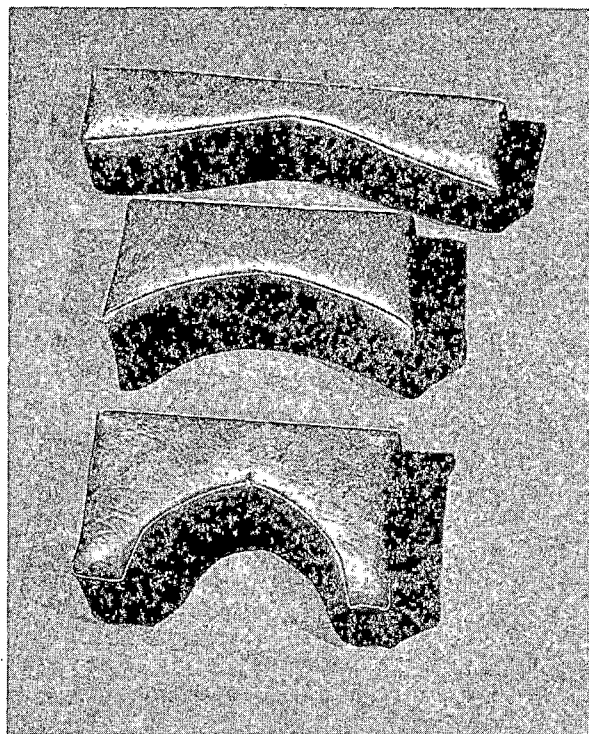

Figure 4, Head Support Variations



Figure 5, Functional Insert Components Applied from Fitting Chair



Figure 6, Stand-Up Wheelchair

Custom Fitting

The final fitting of the seat may be completed by two methods. In the case where the spinal deformity has not progressed to excessive limits the measurements as obtained with the fitting chair may be duplicated by standard upholstery procedures using appropriate padding with applied support bolsters. In cases of excessive spinal deformity, a urethane foam seat is custom molded directly to the patient using the specially designed "air seat" (Figure 8).

The "air seat" is a thin (0.005 inches) rectangular latex-rubber balloon sealed to a plywood base by a quick release metal frame. The balloon is fabricated from stock latex sheet\* to any preferred size depending on the deformity and physical size of the patient. Prior to positioning the patient on the balloon, air is introduced to the point where the rubber is lifted to form without stretching. In essence the latex rubber provides only a seal and the patient sits on air. The patient's weight causes a slight pressure inside the box resulting in the rubber contouring to the body.

After positioning the patient in the best obtainable postural position, urethane foam (in liquid form) is injected into the air cavity. Within 45 seconds the chemical reaction commences and the initial liquid foams up replacing the air to form the end product. Within ten minutes the foam has hardened leaving a permanent impression of the patient in the required seated position.



Figure 7, Stand-Up Wheelchair used in a Classroom

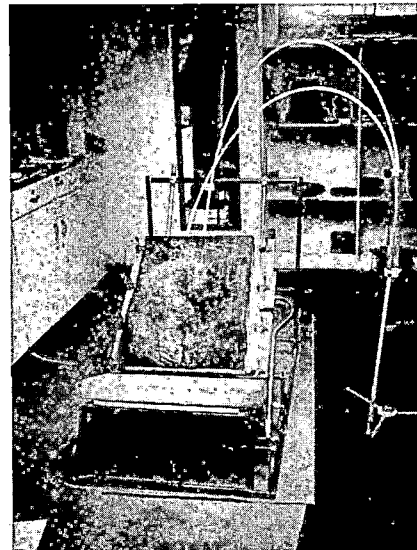

Figure 8, Air Seat for Foaming Contoured Backs

During the injection and reaction cycle the air flows out at a constant pressure through a regulator valve. A constant pressure equal to that required to support body weight must be maintained throughout the entire cycle. Maintenance of constant pressure is absolutely essential to avoid the balloon from distorting to an undesirable shape. The hydrostatic regulator is a simple water column into which the vent lines (Figure 8) are inserted to a depth just enough to counterbalance the pressure caused by the body weight (0.25 psi to 0.50 psi). During the injection and reaction cycle the air bubbles through the water thereby maintaining a relatively constant pressure.

After the contoured foam has been removed from the mold it is trimmed and attached to the mechanical components completing the insert. Final upholstery is completed by either spraying a colored urethane coating over the foam or by vacuum forming a vinyl cover to the preset contours.

At the time of submission of this paper the testing stage had not been completed. Figure 9 indicates the custom contours obtainable. Further results will be discussed during the conference.

**\*Acknowledgement:**

Appreciation is extended by the authors to Mr. E. Martens and Mr. J. A. Ingraham of the Spiroll Corporation Ltd., Winnipeg, Manitoba for their technological assistance and provision of the rubber sheeting used.

**Reference:**

1. R. M. Letts, R. Fulford, D. A. Hobson, Mobility Aids for the Paraplegic Child, The Journal of Bone and Joint Surgery, January 1976, Vol. 58 A/1.

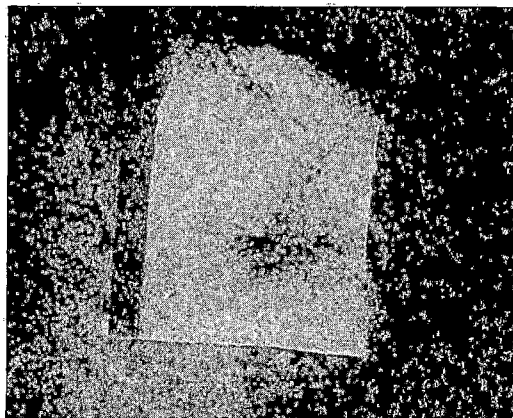

Figure 9, Sample of Obtainable Foamed Contours for Air Seat

AN INNOVATION IN THE INTEGRATION OF ACTIVITY AND EXERCISE IN OCCUPATIONAL THERAPY -- THE SYNAPTOR

by

Kent Nelson Tigges, OTR  
Chairman and Associate Professor  
Department of Occupational Therapy  
State University of New York at Buffalo  
Buffalo, New York

and

Merlene C. Gingher, LPT, OTR  
Assistant Professor  
Department of Occupational Therapy  
State University of New York at Buffalo

The Synaptor is a solid state mechanism, developed by occupational therapists, with an electronic goniometer, digital counter, and timing mechanism which quantitatively measures the number of active, dynamic exercises performed by an individual as part of his or her total treatment program. The Synaptor is able to provide the client with a specific activity or motivational device of personal choice through the client's performance of specific therapeutic exercise for increasing joint range of motion or muscle strength.



While client exercises elbow, corn is popping.

Man performs in his environment by simultaneously integrating, synthesizing and directly applying theoretical concepts and ideas. In the developmental frame of reference we see man engaging and experimenting in life activities in his attempt to become independent and skillful in adapting and adjusting to his environment.

Example 1: A child does not just practice motor patterns and skills for six years and then spontaneously dress himself acceptably on the first try.

Example 2: A person does not just read the set of instructions, watch a video-tape demonstration, and then, the first time behind the wheel of a car, drive with precision and confidence.

Man obtains a sense of self-worth by being able to achieve in life skills and activities. The more man invests in life and, in particular, in his own growth and development, the greater will be his own personal sense of self worth,



Saw operates while client continues exercise.

accomplishment, and well-being.

Although normal growth and development may be impeded by illness, disappointment, disease and/or disability, man's basic learning processes do not change.

It is from the basic tenets of learning--that is, simultaneously combining and integrating cognitive, affective, sensory, and psychomotor learning processes--that occupational therapists approach their practice.

Occupational therapists approach treatment and rehabilitation by first evaluating the physical deficits. Second, in collaboration with the client, they determine short-term and long-term goals. Third, again in collaboration with the client, they select the appropriate life activity that will provide the necessary motivation and at the same time provide the necessary movement or exercise necessary to remediate the given problem.

Our goal is to facilitate the return of the

client to his or her highest possible level of functional independence in activities of daily living.

In selecting an activity for treatment or rehabilitation, the following criteria must be met:

1. The activity must provide the specific motion as is indicated by the specific treatment objectives; such as, increase of range of motion, increasing muscle strength, improving coordination, increasing circulation.
2. The activity must be gradable--simple to complex, gross to fine--to accommodate for the developmental level and/or the loss or impairment of physical function.
3. The activity must be appropriate for the age and personal preference and identity of the client.
4. It must be socially, ethnically, life-style appropriate.
5. The activity must be intellectually appropriate.
6. It must be motivationally appropriate. It must be an activity that more than adequately captures the interest, enthusiasm, desire, and the immediate personal needs of the client.
7. It must be an activity that the therapist can operate and adequately teach the client.

The development of the Synaptor was originated out of the difficulty of not having appropriate activities that could be utilized during the acute stages of illness or disability when a client had minute and/or limited movement.

During the acute stage of illness or disability where joint range of movement and/or muscle strength is restricted or limited, there are virtually no meaningful or appropriate activities that can be selected according to the prescribed criteria.

The first child you saw in the film had just had a cast removed from her arm following a fracture of the radius and ulna. She had slight contractures due to the elbow being immobilized. Full extension was not possible. She was fearful of extending her elbow because of pain and discomfort. With the use of the Synaptor she was able to operate the train--an activity of her choice. Her excitement and interest in operating the train captured her attention and enthusiasm and she "forgot" about the pain and discomfort and actually looked forward to her treatment.

The nun in the film had recently had a total knee meniscectomy. Treatment indications were to increase range of motion. At the time of initiating treatment the client had marked limitation in knee extension. In this case there were no appropriate activities that could be selected to provide for knee extension, let alone be of interest to the client. With the use of the Synaptor the client was able to operate the blender and make a milkshake while at the same time obtaining the specific and appropriate knee extension exercise.

The development of the Synaptor now makes possible the unique application of occupational therapy philosophy and practice during the acute stage of illness and/or disability.

The concept of the Synaptor was introduced to the United States by myself. At the present time the Occupational Therapy Department at the State University of New York at Buffalo is the major center for researching the application of the Synaptor in acute treatment.

Since the film was made two additional component mechanisms have been developed and studied through clinical use. Professor Gingher will discuss the capabilities of the Synaptor and the components.

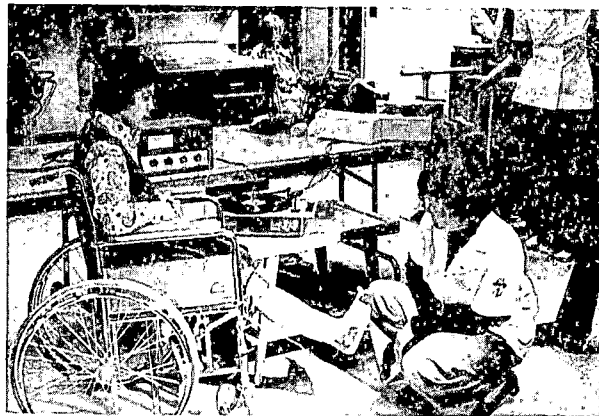

The record plays as long as exercise continues.

The Synaptor is a solid state mechanism with an electronic goniometer, digital counter, and timing mechanism which quantitatively measures the number of active, dynamic exercises performed by an individual as part of his or her total treatment program.

The beauty of the Synaptor is its ability to provide the individual with a means of personal motivation for treatment. As previously discussed by Professor Tigges, one of the criteria in selecting an activity for a client is that the activity be motivationally appropriate; i.e., it must be an activity that more than adequately captures the interest, enthusiasm, desire, and immediate needs of the client.

Because there are many acute conditions, disabilities, and/or situations where a client has only limited motion of a joint or limited strength in a muscle, it is often impossible to choose an activity for a client that meets all the criteria. Activities must be modified or adapted in most situations to the individual needs. There are, however, some instances where there is no choice of activity, even with maximum modification available. With the Synaptor, one needs never to adapt the motivation or activity of choice.

An area of difficulty regarding choice of activity is in the case of acute orthopedic conditions.

An example of such a condition is the

patient who has been immobilized in a cast or who has recently had the cast removed. He or she may have joint range limitations as well as muscle atrophy and weakness. Even if the patient has only 1° of motion, he or she will be able to operate a motivation of choice and simultaneously perform the proper exercises to actively improve joint range of motion.

Another area of concern is that of a recent trauma to the spinal cord where the patient may have limitations or weakness in all extremities but head and neck; thus, quadriplegia.

This patient may have been receiving passive treatments up to this time, such as bed positioning or range of motion. He or she is now able to participate. However, all he or she is able to do is move head, neck and shoulders-- although shoulders are limited. With the Synaptor and the light emitting photo transistor - light gate component, he or she is able to perform the necessary motion in his or her head and neck to allow his or her choice of motivation; for example, the television to run. Thus, he or she is performing a specific exercise actively and under his or her own volition is able to turn on the television to watch a favorite program. In turn, this reinforces the desire to continue the treatment.

In cases of thrombophlebitis, some knee injuries and some fractures of the femur -- where patients are either in traction or non-weight bearing -- it is advisable to have the patient perform isometric exercises. There is usually little motivation to perform isometrics and in this case, there is no activity available at all.

In the case of thrombophlebitis, isometric exercises will help improve venous return and avoid pooling if performed by the affected extremity. Isometrics will maintain or increase strength in the patient with knee injury who is unable to perform active exercise due to joint range limitations. In the cases of those with femur fractures, isometric exercise will again maintain strength or increase the muscle strength of those muscles limited in active exercise due to traction or non-weight bearing status.

The Quadriceps Isometric Contraction Monitor (QICM) is a component used with the Synaptor especially developed for isometric exercise of the quadriceps musculature. This component was developed by me in partial fulfillment of my master of science degree in occupational therapy. With the assistance of Professor Terry Karselis, MT (ASCP), the design of the QICM was agreed upon and he was solely responsible for the adaptation of this component to use with the Synaptor.

Professor Karselis has also been responsible for the total design, development, and electronic adaptation of the light emitting diode - photo transistor light gate.

The Synaptor enables the individual to utilize the muscle strength and range of motion he or she has to operate an electric device or motivation of his or her choice while he is exercising and carrying out the proper treatment.

By plugging the motivational device into the Synaptor and setting the goniometer, timing

device and digital counter, the patient is able to exercise and provide the power to run the device of choice. If the patient fails to complete the required therapeutic exercise during the time set by the therapist, the motivation would switch off until the exercise is repeated...

We will now demonstrate the Synaptor and components. May I please have a volunteer from the audience?

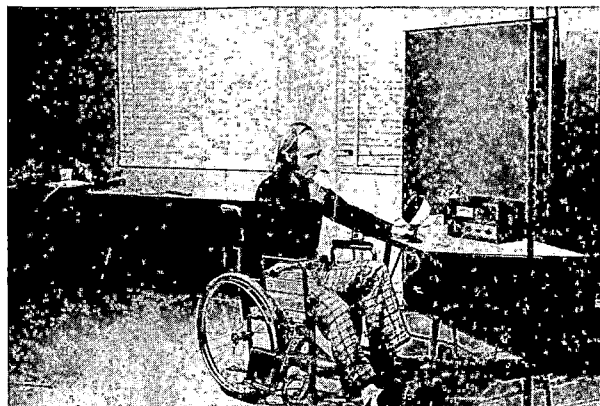

While client exercises ankle he is able to use electric razor.



A milkshake is prepared while elbow is exercised.



When knee movement stops, Synaptor's warning buzzer sounds before cutting off electricity to the record player.

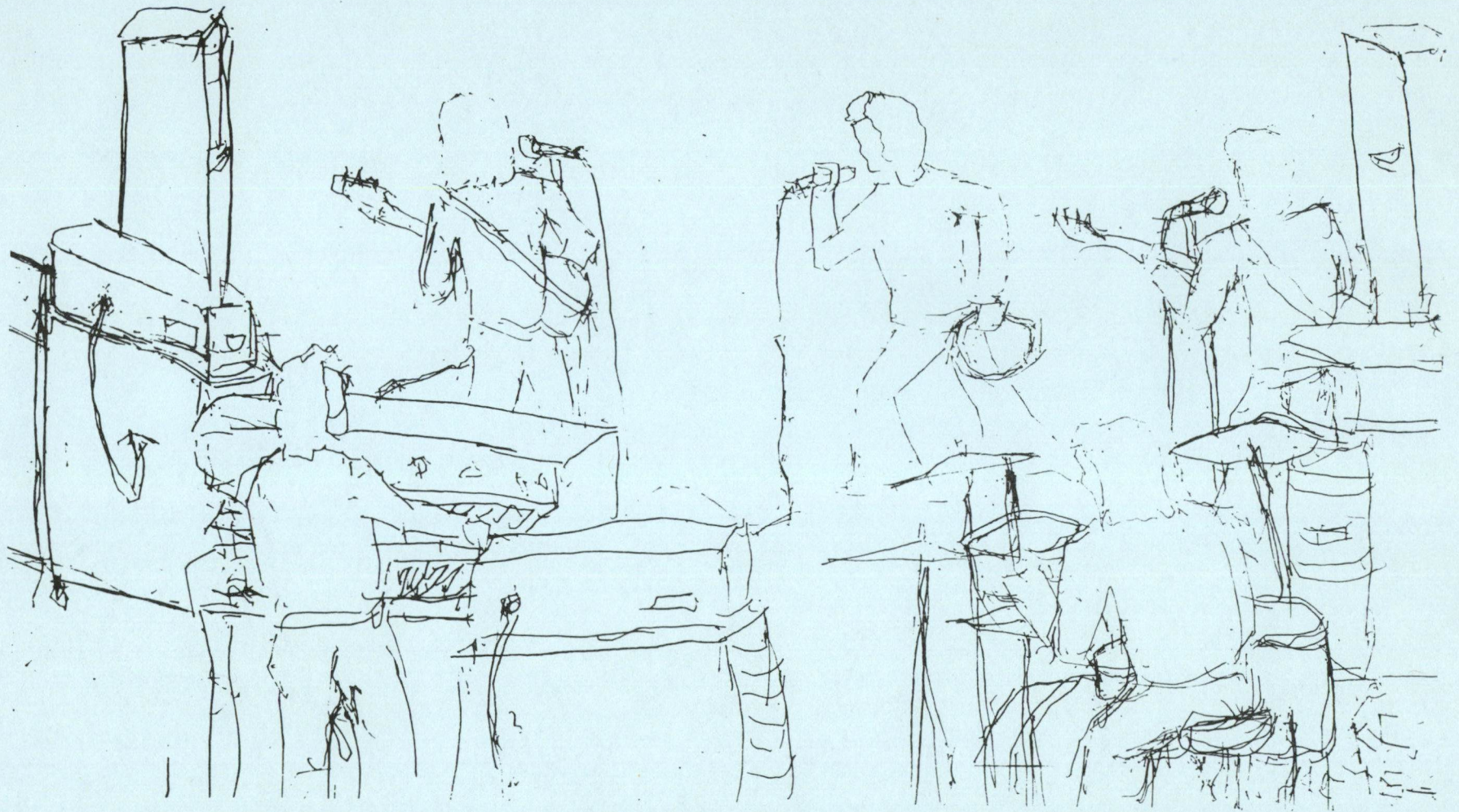

NON-VOCAL COMMUNICATION

## WHAT DO YOU DO IF YOU CAN'T TALK WITH YOUR VOICE OR HANDS?

by

Maurice A. LeBlanc, MSME, C.P.  
Rehabilitation Engineering Center  
Children's Hospital at Stanford  
Palo Alto, California

### Summary

For people who cannot speak and have inadequate use of their hands and arms for writing, typing, pointing, or sign language, some means of communication is crucial to satisfy basic physical needs and any intellectual endeavors. We at the Rehabilitation Engineering Center at Children's Hospital at Stanford are providing direct patient services and undertaking research for cerebral-palsied and other people in need of communication assistance.

### Patient

We must rely on the patient, the parents, speech therapist, occupational and or physical therapist, teacher, and any other people who know the person well to give us the necessary information to design a communication system. We need to know where the person is physically to judge what motions are available for control (Sometimes it is only head motion). We need to know where the person is intellectually to provide the proper content of information. (A person's educational level can be overestimated as well as underestimated.) And we need to know where the person is emotionally to use favorite colors and objects for maximum enjoyment. (Biofeedback can be used for reinforcement if necessary.)

### Output Devices

Visual output can be accomplished by using manual or electronic pointer boards, i.e. by pointing to a message with a finger, a powered arrow, or a moving light. Printed output can be achieved by using an electric typewriter or a strip printer. Speech output presently is not available commercially. However, our Center is in the process of exploring two methods or providing speech output at reasonable cost.

Visual output devices are good for communicating on a person-to-person basis; but the information is non-retrievable. Printed output devices obviously open up the possibility of storing and sending information. Speech output devices have the advantages of giving classroom participation, telephone conversation, and the big psychological boost of being able to "talk".

### Interface

Dizzy Dean once said that a baseball pitcher, no matter how fast, is not worth a nickel unless he can control the ball. Likewise, communication output devices are of no value unless they are interfaced with patients so they can control them. Different types of control include headsticks, mouthsticks, joysticks, sound, EMG, and any other conceivable way of using what residual motion/activity a person has.

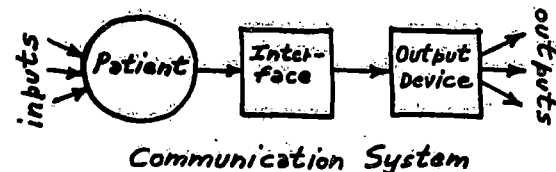

## Results

The obvious benefits of providing communication to a non-vocal person are that it allows that person to express basic needs (hunger, toileting, etc.), to pursue intellectual endeavors such as school or job, and to socialize with relatives and friends. Beyond this, it allows us to determine where a person is intellectually; by giving an information output, we can then judge how much of the information input (language) is being "processed" by the patient.

Also, it has been found that the use of communication systems has increased the limited speech that some patients have rather than substituting entirely for it. The rationale for this is that the increased activity of communicating promotes the whole mental/motor development of the person.

Other reasons which have been suggested are that a person may try to outspk communication systems which are slow, and that once a person's basic needs have been satisfied via a communication system, then he/she is more relaxed about speech and can do better.

## Conclusion

There is no doubt that the efforts in providing communication assistance are worth the results. It is too basic a need not to satisfy. And with new technology and more people becoming involved, progress should continue and breakthroughs should happen.

The field is indebted to the Rehabilitation Engineering group at Ontario Crippled Children's Centre in Toronto and to the Trace Center at the University of Wisconsin in Madison for their pioneering work, sharing of thoughts, and promoting the importance of providing communication systems for people who cannot talk.

# THE TUFTS NON-VOCAL COMMUNICATION PROGRAM

by

Richard A. Foulds                      Gregory Baletsa  
William J. Crochetiere\*              Chester Meyer  
Biomedical Engineering Center  
Tufts-New England Medical Center  
Boston, Massachusetts

Summary: This paper describes the efforts of the Biomedical Engineering Center in conducting both research and applied studies in the area of non-vocal communication for the severely physically disabled.

## Introduction

The application of technology to the field of Rehabilitation Medicine has offered the promise of restoring or assisting physical functioning of a severely physically disabled person. A major area of concentration of the Biomedical Engineering Center has been that population which is prevented from normal communication because of a profound motor dysfunction. The lack of speech and writing skills due to muscle incoordination, weakness, or paralysis is evident in disorders such as cerebral palsy, ALS, traumatic head injury, and stroke. While each of these is medically different, the resultant absence of communication is commonly devastating in terms of the person's social, educational, and vocational life.

The Biomedical Engineering Center (BMEC) has staffed its non-vocal communication project with three engineers, an occupational therapist, and a special educator. The goals of the project are to identify technological means of assisting a person to better communicate, and work within the community in the application of assistive devices.

At the present time, the BMEC is under contract to the Massachusetts Bureau of Special Education to work with special needs programs throughout the state providing this type of technical support. As of this writing, twenty-two special education classrooms have been equipped with electronic devices developed by the BMEC. At the same time, the BMEC is working with other agencies and institutions in examining the communication needs of other disabled individuals. Older people who may have been educated before an accident or the onset of a disease do not require educational support, but may require a faster, more powerful device than would a child who is disabled from birth and is learning language in spite of his disability.

A very difficult situation is the older cerebral palsied person who may have been entirely missed by the educational system. He may be extremely intelligent while lacking the formal language skills necessary for effective use of an assistive device.

In order to meet the needs of a varied population, the BMEC has begun to develop a series of

communication devices that span the entire range of communication possibilities. This effort will hopefully give the individual a choice of which machine (if any) he wishes to use. The remainder of this paper describes the developments of this program.

## The TIC and Related Devices

The Tufts Interactive Communicator<sup>1</sup> (TIC) has been designed as a single switch input typing device that can be operated by a single grossly controllable muscular movement. The need for such an easily operable unit was identified early in the project. While many non-vocal individuals can operate more complex interfaces, the single switch feature finds extensive use with the most severely disabled. The user selects the characters from a visual keyboard that offers rows of characters by successive illumination. A single switch closure chooses the illuminated row, and commands the TIC to scan the characters in that row. A second switch closure chooses a single illuminated character. Once selected, the letter or number is printed on a hardcopy medium, and is displayed electronically. In this way messages are constructed on a letter-by-letter basis.

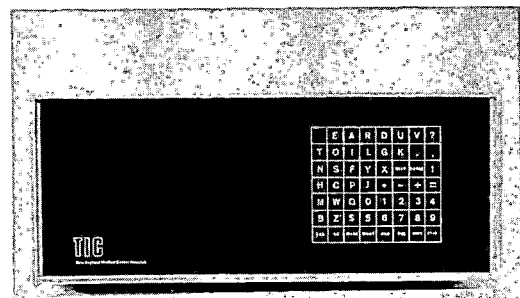

Front Panel of the TIC  
Fig. 1

The TIC that is now in use differs only slightly from that which was developed over 5 years ago. The method of letter selection has proven to be effective and hence is unaltered. The visual keyboard has been rearranged to take advantage of

\*Associate Professor of Engineering Design  
Tufts University Medford, Massachusetts

the rank order of characters in the English language. This represents an approximate 30% speed improvement over an alphabetically-ordered visual keyboard.

Recent developments in low power electronics have offered the potential for battery operation of the TIC. Since funding for redesign of this device was not readily available, the program staff proceeded cautiously, looking for an appropriate time for a design change.

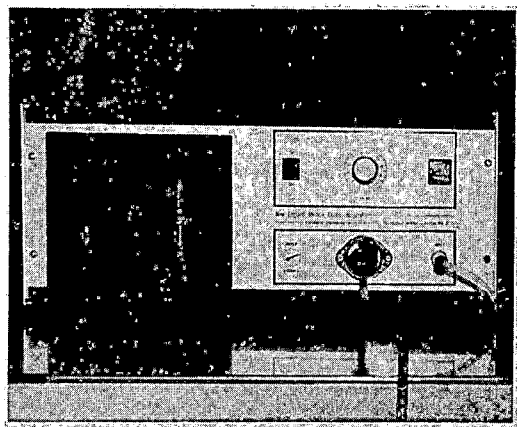

Rear Panel of the TIC  
Fig. 2

The current equipment modifications are actually taking place in two directions. The present TIC offers a 32-character electronic display, and a paper strip printer. These functions are being transferred into a smaller, portable unit with an operating life of eight hours before recharging is necessary. The existing TIC, for which a large price has been paid for tooling development, will simultaneously be upgraded into a more powerful communication tool. This device will offer a complete video display that can be edited and modified by the user. The corrected text can then be "dumped" onto a typed page. This will hopefully provide the flexibility required for academic and vocational activities.

#### The Dictionary

Each person who communicates either through written or spoken language tends to use a vocabulary that is smaller than that actually at his disposal<sup>2</sup>. This may be evident in conversational idioms, or in key words or phrases (i.e. jargon) of a geographical location, or business environment. Part of the Non-Vocal Communication Program's activities has been to identify ways of shortening the user's time involved in transmitting a message. The method chosen has been to incorporate a dictionary of 400 words or phrases that can be custom programmed into a personalized TIC. The new circuit card can accommodate 4 increments of 1000 letters. Therefore the complete dictionary will consist of no more than 400 entries whose total length is no longer than 4000 letters. While this provides an average of 10 characters per entry, the actual word or phrase lengths will be independently set.

The selection of such a large number of entries offered a challenge in the design of a

visual keyboard. The magnitude of a 456 entry keyboard (400 words + the standard TIC keyboard) would prevent efficient use due to long scanning times. An encoded method was determined to be the desirable approach. The bottom row of the TIC keyboard is designated with the numbers one through eight, indicating dictionary page numbers. Each character of the existing keyboard will represent a different word on each page. Selection of a word is accomplished by first choosing a page number, and then the appropriate keyboard character. The desired word will be taken from the dictionary memory and displayed on the output device.

#### Anticipatory Communication<sup>3</sup>

An important consideration in the application of a communication device is the speed with which its operator can make an output. The rate of output is limited by both the user's input time response, and the size of the scanned visual keyboard. Although the vocabulary and verbal skills of the user are expected to improve with training, the physical input cannot be expected to do the same. Disabilities such as cerebral palsy do not generally change dramatically and will most likely require the user to use the same grossly controlled input motion for his lifetime. ALS is a progressive disease and will result in a loss of motor control over time.

As can be understood from above, the easy solution of "speeding up" the scan rate is impractical. Improvement cannot be found in reducing the keyboard size since the TIC keyboard contains essential entries for alphabetic and numeric output as well as punctuation and arithmetic symbols.

A major effort of the BMEC has been to study the application of language redundancy to this rate problem. Results of the project have shown a theoretical improvement of approximately 50% over the standard TIC. Present studies are focusing on the display techniques that will maintain this level of improvement when the device is used by a human operator.

Based upon knowing no prior characters  $p=.19$   
 Based upon knowing 1 prior character  $p=.28$   
 Based upon knowing 2 prior characters  $p=.40$   
 Based upon knowing 3 prior characters  $p=.51$

Probability of Correctly Predicting  
 the next Character to be Typed

Fig. 3

The current state of the research has yielded a prototype device appropriately named the ANTIC (Anticipatory TIC) which predicts the six most likely letters to follow the letter most recently chosen. This prototype is being studied with the assistance of a high-level spinal cord injured client who is providing valuable information on its acceptability as a working design. In order to reach the 50% improvement, the statistics on letter frequency will be based not upon the single prior choice, but upon the three previous selections.

#### Symbol Communication

All of the above devices require that the user have the ability to spell, or at least

recognize words from the dictionary. Within the Non-Vocal Communication Project there has been identified the need for a less sophisticated device that will identify locations rather than character symbols. The solution to this need has been a small relatively inexpensive device that offers the user the choice of eight or 48 squares. Filling these squares will be symbols, letters, or pictures attached to small plastic clips. The same type of switch as is used in the TIC or ANTIC can stop the scanning at a particular symbol and cause the light to flash as an indication of choice. The Symbol TIC or SYMTIC scans the eight squares in a linear fashion, or scans the 48 in a row-column manner. There is no printout provided in the unit. The SYMTIC is envisioned as a teaching tool for early intervention with non-readers and can be used with various teaching systems such as the Peabody Rebus Reading Program<sup>4</sup>, or the alternative language programs like the Bliss Symbolics.<sup>5</sup>

### Symbol Printing

The principal difficulty encountered with the SYMTIC is its lack of a printed output. This prevents the user from communicating independently since his listener must remain within viewing distance.

The BMEC is trying to rectify this situation by developing a printing unit that will reproduce graphic symbols. The Cryptographic TIC or CRYPTIC will initially be programmed for use with the Bliss Symbols and will be assigned to the Vermont Achievement Center in Rutland, Vermont.

### Electronic Letterboard

The devices described throughout this paper have been operated by a single input switch. Many non-vocal individuals are capable of greater interaction with a machine. Letterboards have been commonly used by those clients who have some residual pointing ability or the use of a head-pointer. Letterboards<sup>6</sup> have the advantage of being inexpensive and entirely flexible since they are only paper on which a teacher or clinician writes words and letters, or draws pictures. The locations of these objects can be determined according to the physical abilities of the user. Midline crossing problems, hand preference, or varying dexterity can be minimized by the proper placement of the symbols.

Electronic conversion of these letterboards has not been able to offer the same flexibility. The use of mechanical switches and sensors presents physical limitations that prohibit total flexibility. Expanded typewriter keyboards offer a fixed arrangement that may often be unsatisfactory to a user. Varying the size of that keyboard or even changing the size of the switches becomes a major mechanical task. The Autocom<sup>7</sup> from the University of Wisconsin offers an attempt at flexibility with several optional arrangements of the magnetic proximity switches.

The BMEC has contracted with the Flex Key Corporation of Gloucester, Massachusetts for the fabrication of a flat switch panel that measures 22" x 15" and contains 4000 switch contacts arranged in a honeycombed grid. The Flex Key Corp. has graciously donated the engineering time required in the design of the switch panel.

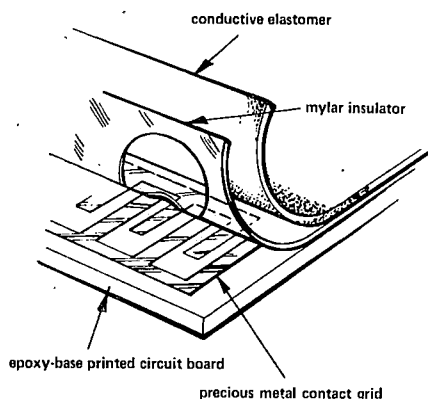

Elastomeric Switch Structure  
Fig. 4

The switching mechanism is a proprietary process owned by Flex Key<sup>8</sup> and utilizes the properties of a conductive elastomer. The entire panel consists of a large printed circuit card and a layer of elastomer separated by a mylar insulator. The entire panel is approximately 1/8" thick.

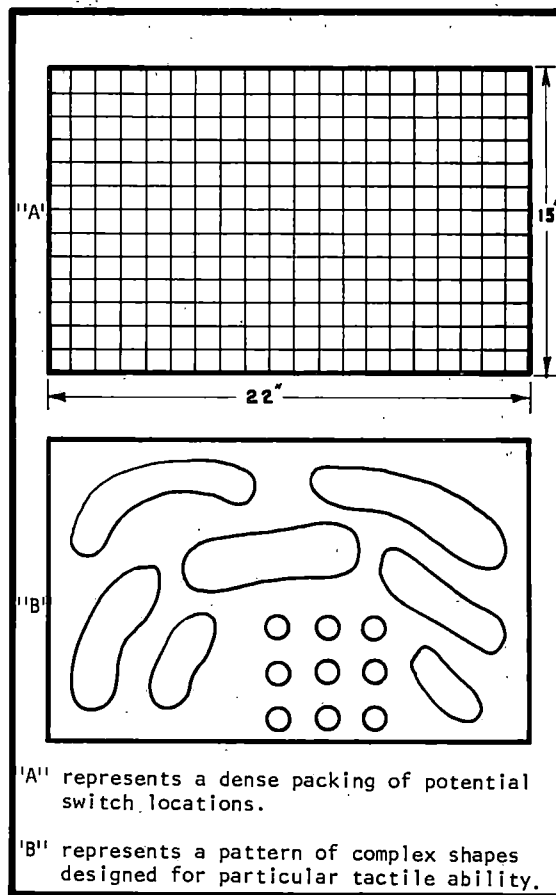

'A' represents a dense packing of potential switch locations.

'B' represents a pattern of complex shapes designed for particular tactile ability.

Samples of Complex and Custom Tactile Communicator Layout

Fig. 5

The switch contacts are .25" in diameter on .30 inch centers. Assuming that the smallest object pointing to the panel will be a human finger, at least one of the switches will be closed when the panel is touched. Once the switch closure is made, the X and Y coordinates of the contact will be detected by external circuitry. The force required to register an input is less than 10 ounces. The switch movement is .005 inches.

That external circuitry is now being developed and will allow the teacher or clinician to define clusters of switches as words or letters. In this way a totally flexible letterboard surface may be custom designed to meet the user's needs. The logic circuitry will identify the appropriate input and operate the same type of printing devices as are already in use in the TIC.



Tufts Interactive Communicator in Clinical Setting  
Fig. 6

#### Technology Utilization Project

The Biomedical Engineering Center has felt an obligation to make available the results of its research and development. This has already been evident in the project within the State of Massachusetts. Other devices have also been made available to individuals and institutions for use in their own programs. The BMEC tries to maintain contact with these sites and provide any possible assistance. All devices have been offered as a service of Tufts-New England Medical Center and are made available on a non-profit basis.

#### Acknowledgement

This work has been supported by HEW Rehabilitation Services Administration Grant 16-P-57856/1-01 and a Contract with the Massachusetts Department of Education.

#### References

1. Foulds, R.A., Gaddis, E.: "The Practical Application of an Electronic Communication Device in the Special Needs Classroom", Proceedings of the Conference on Devices and Systems for the Disabled. Krusen Center for Research and Engineering, Philadelphia, Pennsylvania. 1975, pp. 77-80.
2. Miller, G., Language and Communication, McGraw-Hill Co. c 1951, 63.
3. Foulds, R.A., Baletsa, G., Crochetiere, W.J.: "The Effectiveness of Language Redundancy in Non-Verbal Communication", Proceedings of the Conference on Devices and Systems for the Disabled. Krusen Center for Research and Engineering, Philadelphia, Pennsylvania. 1975, pp. 82-86.
4. Woodcock, R., "The Learning Disabled and the Peabody Rebus Reading Program", A Paper presented at the Annual Convention for the Council for Exceptional Children, Chicago, Illinois. April 1970.
5. Teaching Guideline - Symbol Communication Research Project, Ontario Crippled Children's Centre. Toronto, Ontario. 1974.
6. Vicker, B., Nonoral Communication System Project, University Hospital School, The University of Iowa, Iowa City, Iowa. c 1974.
7. Participant Resource Book, 1975 National Workshops on Non-Vocal Communication Techniques and Aids, The University of Wisconsin, c 1975.
8. Flex Key Brochure 10-73-FK-5K  
Flex Key Corporation, Gloucester, Massachusetts.

A SYMBOL COMMUNICATION SYSTEM FOR THE NON-VERBAL SEVERELY  
HANDICAPPED, WITH AUDIO WORD AND SENTENCE REINFORCEMENT

by

J.R. Charbonneau, O.Z. Roy, J.G. Cossalter  
A. Warrick\* and C. Cote\*

Medical Engineering Section,  
National Research Council of Canada, Ottawa  
and

\* Ottawa Crippled Children's Treatment Centre

This paper describes a communication system designed to promote language and educational development for non-verbal severely disabled children. The system uses a visual symbol display with audio whole word and sentence reinforcement. The visual display consists of a constant organization of symbols which are capable of conveying both subjective and objective life experiences. Audio reinforcement is utilized during the learning process to provide a multisensory learning experience.

### Visual Display

The display matrix shown in Fig. 1 was designed as a stand-alone, portable unit, self-contained in an attaché case. Each half of the case contains the visual display: 128 squares or addresses, giving a total number of 256. Each address contains a symbol and the written word which it represents. Selection of a particular symbol is indicated by a small red lamp within the square. These BLISS symbols (named for their inventor)<sup>1</sup> represent both subjective and objective life experiences that a non-reading child might wish to communicate.

The total capacity of the matrix can be varied from 32 to 512 addresses by means of front panel switches. During the initial learning stages, the matrix is used in the 32-address mode (8 x 4). As the subject's vocabulary and comprehension increases, the system can be expanded through 64, 256 to 512 addresses. The 512 address mode is achieved by dividing each address into two segments and indicating the desired half by having the lamp light continuously or blinking.

### Memory

The unit also has a 16-address, 9-bit memory. This storage capacity allows for whole idea development. The subject can read or erase the memory by going to a particular address or by using separate switches.

### Scanning and Interface

In the most automatic mode, a single switch is used to control the display. A scan pattern<sup>2</sup> has been developed which first scans the columns, then the rows and finally writes the selected address into the memory. With this method of operation, a time-based error correction feature has been incorporated. For example, if the subject overshoots a column, by waiting a pre-determined period (1 to 10 seconds), the system automatically resets to *home*, or the first-column, first-row address. On the other hand if an error is made in the selection of a row, then the system resets to either the top of that

particular row or to *home*.

For subjects with greater muscular control, the scanning pattern is unlocked and individual functions such as up/down, right/left scan, memory read, write and erase are added.

The flexibility of the interface enables subjects to use their abilities fully. A variety of interfaces can be used, from a mechanical switch to a light-activated joystick, thus allowing the display to be scanned in an up/down, left/right or diagonal fashion. A subject with moderate dexterity could use the joystick, while those with less dexterity could actuate an arrangement of large pushbuttons.

### Audio Reinforcement

When audio reinforcement is desired the display matrix can be coupled to a computer and speech synthesizer<sup>3</sup> which together form a speech-generating system. A block diagram of the system is shown in Fig. 2.

Upon selection of a symbol, a digital code which identifies it is sent to the computer. The computer recognizes the code and sends the information to the synthesizer to speak out the associated word. The spoken word provides immediate positive reinforcement for the choice of symbol and emphasizes the relationship between the symbol, the concept it represents and the spoken word for the concept. A sequence of symbols can be specified in this way, and the computer will remember the sequence. Upon receipt of a command from the subject, either the activation of a switch or an address on the display, the computer will articulate the whole sequence of selected concepts. This allows the subject to formulate whole thoughts or "sentences" as is done in normal written or spoken speech.

The unit is being evaluated with children and young adults at the Ottawa Children's Treatment Centre and the Rideau Regional Hospital, Smith Falls, Ontario.

References

- 1) Blissymbolics Communication Foundation, 862 Eglinton Ave., E., Toronto, Ontario, Canada: M4G 2L1
- 2) O.Z. Roy, J.R. Charbonneau, A Communication System for the Handicapped (COMHANDI) in Aids for the Severely Handicapped. K. Copeland, (Editor), p.89, 1974. Published by Sector Publishing Ltd., London, England.
- 3) Votrax-Federal Screw Works Co., Vocal Interface Division, 500 Stephenson Highway, Troy, Mich., U.S.A. 48084.

Acknowledgement

The authors wish to acknowledge the valuable help and advice of J. Arenson, Institute of Biomedical Engineering, University of Toronto and R. Paduch, McGill University, Montreal.

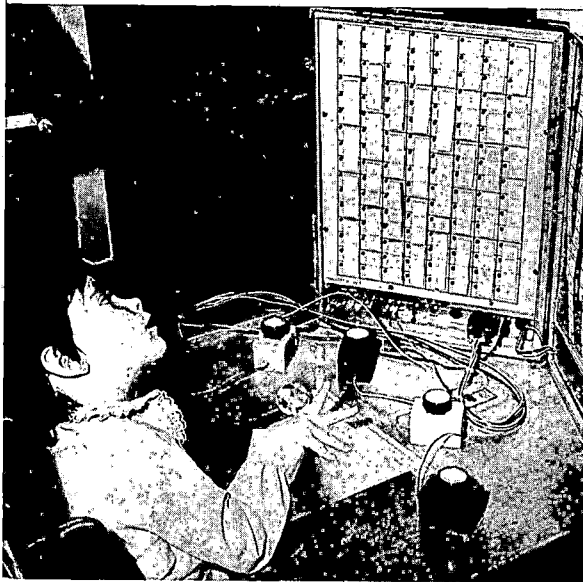

FIGURE 1

Portable Communication System

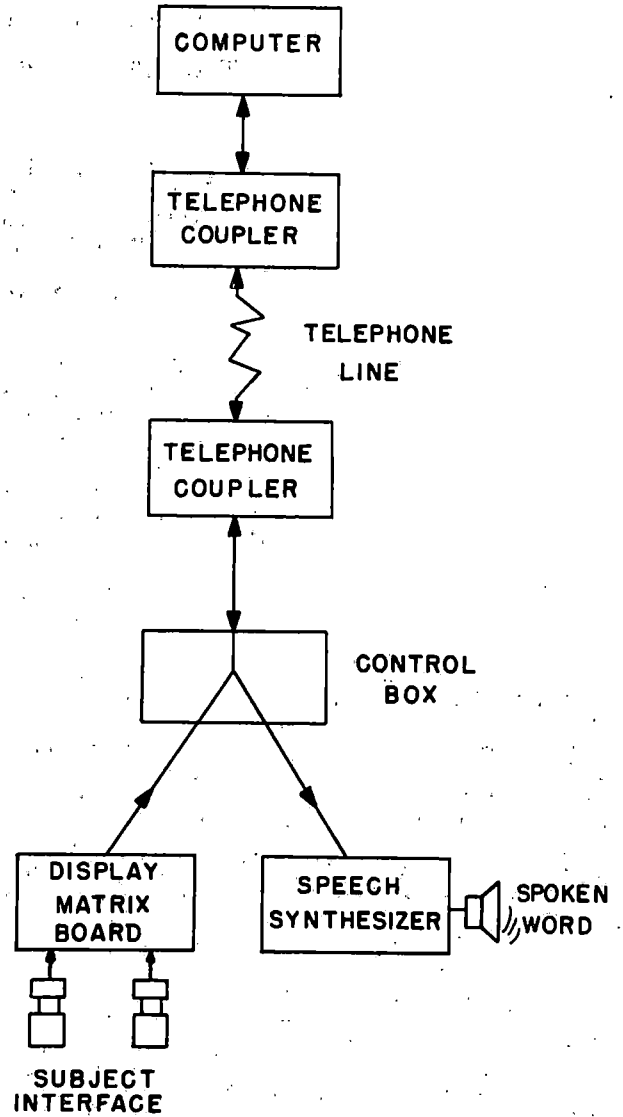

FIGURE 2

Speech Synthesizer Block Diagram.

A LEARNING EXPERIENCE

by

James L. Cockrell, Ph.D.  
Department of Physical Medicine and Rehabilitation  
University of Michigan Medical Center, Ann Arbor, Michigan

M. Claudette M. Konzen, M.D.  
Chief, Rehabilitation Medicine Service  
Veterans Administration Hospital, Ann Arbor, Michigan

Summary - A case study is presented, that of a 51 year old male, with prescription of communication assistive devices following a brain stem infarction wherein all vital centers were affected. A variety of interface transducers were employed. Several logic and output schemes were demonstrated to offer momentary and permanent communication.

Some conclusions about the general approach, the devices and the learning experience for the team involved are presented.

To initiate an action, - and then carry it through with whatever degree of completion the originator chooses are essential steps of communicating with our environment. Although deterioration of the second half of this, - carrying out - represents one kind of disability, - losing both steps is quite another state. If the initiation of no action is possible that is the end of the line. It was meeting a patient very near the end of this line that this account begins. This paper traces the activities of a small group of persons intent on providing adequate communication for a patient having a brain stem lesion. It is an account of a failure in prescription and application of devices to assist in communication for a severely disabled person. At least this is how the workers, - the physician, therapist, orthotist, and engineer felt at various times in the process. The patient seemed to feel that way too. That the experience might prove useful to you, the reader, and the group involved is why this paper is presented.

The central figure in this drama is Mr. A, a 51 year old right handed truck driver, known hypertensive, who suffered a brainstem infarction secondary to a blockage of the left vertebral and basilar arteries in May 1972. The insult resulted in complete quadriplegia with decerebrate posturing, and involvement of the IX, X and XII cranial nerves affecting the tongue and palate, thus interfering with his ability to speak and swallow. Vital body functions were carried out in early phases by tracheostomy, suprapubic cystostomy, and nasogastric tube feedings. The grave prognosis of Mr. A's initial condition, which was complicated by multiple febrile episodes, no doubt delayed his referral to Physical Medicine until January 1973. At that time Mr. A was seen in an effort to prevent contractures by passive ROM exercises and by positioning.

In February, 1973 there came a request to evaluate the possibility of a mouth stick as a means of communication. Further, Mr. A had no way of calling for assistance. During this time the occupational therapist had devised an alpha-

bet board, (Figure 1).



Figure 1  
Alphabet Board  
Communication System

The major patient responses were a raising of the eyebrows for "yes" and a slow side-to-side motion of the head, - or no motion at all for "no". Both the O.T. and Mrs. A. found the coordination of board, pointer, paper and pencil, as well as the following Mr. A's eyes and forehead for information from him an exhausting task. The general approach was to scan the board for the desired letter and when acknowledged to enter it on a pad at the side. Usually Mr. A. could not see the pad and his memory and his spelling were very poor. Part of the evolving regimen was, using the information acquired, to anticipate and ask a question directly or proceed directly to the suspected letter. As the patient and therapist improve their rapport this approach is quite efficient. The equipment is minimal, - the personal interaction is enormous. The addition of a sound producing device which the patient could operate would relieve part of the eye fatigue and coordination problem for the therapist. The first device used was a battery-operated buzzer, activated by a pressure switch. Various means for placing the switch adjacent to his head

were tried but none were consistently effective.

At about this time it was suggested that the hospital library had a couple of ceiling projectors for microfilm or book copy which might be usable by Mr. A. Plunging right into this revealed that the device indeed would project beautiful page images on the ceiling. They could be advanced by one switch closure and reversed by another, - the action continuing for as long as either switch was closed. Using an alternate action relay only one external switch was required. Another switch turned the projector on and off. The motion of Mr. A's head to either side seemed suitable for this control action and accordingly a switch set was devised using "gooseneck" fixtures to set the location of the switches. Snap switches were set in a relatively large plastic housing (Figure 2) which could be adjusted with respect to plastic paddles.

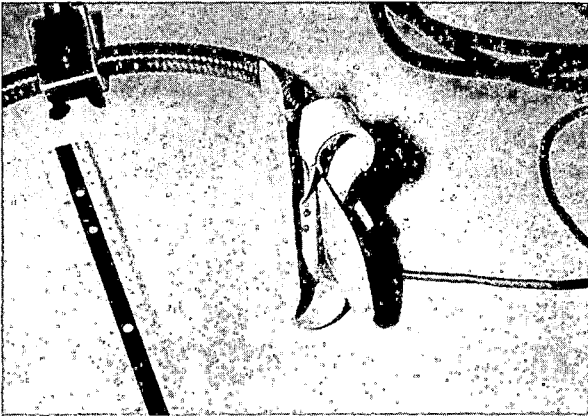

Figure 2  
Input Switches Using  
Goose-neck Hardware

This arrangement is shown in Figure 3. Mr. A. could now control devices by rotating his head from side-to-side if:

1. The device were in place
2. The paddles and switches were adjusted to his head
3. The buzzer or projector were turned on

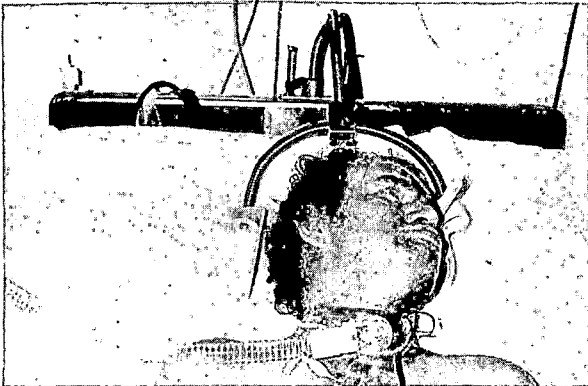

Figure 3  
Two Switch Head Rotation Input System

A typical pattern of idea, design, construction was developing without the coordination and coherence of a plan. About this time we became aware of developments in communication assists at other laboratories. With the help of Dr. Dudley Childress at the Prosthetics Research Laboratory of Northwestern University we were introduced to their comfort and control hardware, - a general output-oriented device (Figure 4). The input signals could be "puff" and "sip" pressure signals (since the display device normally positioned near the patient's face contained sensors accessed by a drinking straw) or switch closures. The device typifies a group now known generically as Environmental Control Units (ECU) and permit input signals to act systematically on a set of output devices. In general two input signals are required, one to designate the device, and the other to act on that device.

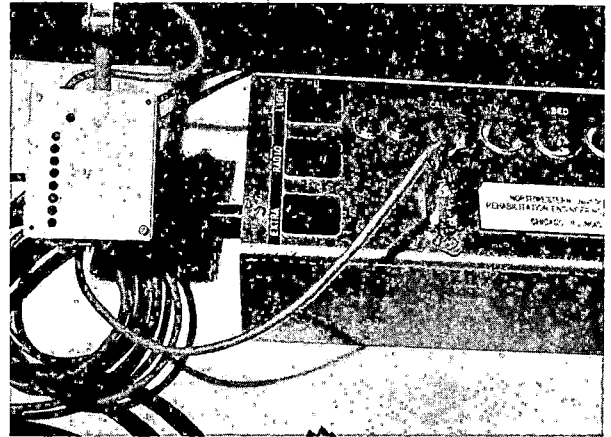

Figure 4  
Northwestern University's  
Comfort and Control Hardware

Having on hand the hardware aspects of the output devices and the logical system we were able to focus on the critical component - the patient-device interface. The interface devices actually tried and considered are listed in Table I.

Table I	
Device Actually Tried	Devices Considered
1. Single Microswitch in plastic paddle	1. NASA "Sight Switch"
2. Double microswitch, goose-neck mounting	2. U.S. Army Morse Code (not strictly an input device)
3. Double microswitch, rigid mounting	
4. Chin switch head gear	
5. Myoelectric control, dual action, frontalis source	

The ideas for patient interface hardware came from everywhere and those that are mentioned seemed the most likely to produce consistent operational success. But none did, - and this was the focus of the frustration.

The plastic paddle which carried a microswitch was the most consistent component, - but positioning the pair adequately proved to be the

flaw. Since warning or calling was one of the objectives constant availability was a goal, - and there seemed to be no position of the switch which met this goal which did not also restrict a resting position, - or from which his head would gradually slide out of the desired juxtaposition. The goosenecks seemed satisfactory in concept since the ends could be positioned quite generally, - but they lacked stiffness once located, and were generally heavy and hard to move out of the way for nursing, and then back into the optimum position. A rigid mounting for the snap switches was devised, again to operate from side-to-side head motion. This arrangement was even more restrictive of head motion and required more effort for the hospital staff to set up consistently.

A logical step was to make the device follow the patient's head to operate from changes in head position. Another possibility was to detect some change in a parameter associated with the head. One such was an almost imperceptible voluntary opening of the mouth. Another was the raising of the eyebrows. To test these a "head cage" was built which located a microswitch appropriately enclosed and buffered just under the chin (Figure 5).



Figure 5  
Head Cage and Chin Switch

Another was the location of myoelectric electrodes and a 3-state (off-level-rate) device supplied by the Northwestern Prosthetics Research Laboratory. The mechanical chin switch responded to a very marginal capability, and was also very restrictive on the head and difficult for hospital personnel to put on and take off of Mr. A. The myoelectric control operated from a single pair of electrodes on the forehead and when adjusted ideally was satisfactory temporarily. However variations in the daily installation of electrodes and poor feedback from the patient soon relegated this device to disuse.

At about this time there occurred the possibility of using and demonstrating another output device, - the display and message printer from the Cybernetics Research Corporation, called Cybercom. Since we assumed Mr. A. was excited about all these new possibilities for communicating, controlling and expressing himself the device was duly installed and placed in appropriate juxtaposition. The Cybercom uses a line and

column scanning arrangement to select the desired character and a Beckman electronic character display for building a word or phrase. The printout was via an IBM typewriter. The entire device operated via one channel of the comfort and control unit. Recall that during this time we were not able to mount the input devices satisfactorily.

Another output device was a T-V having remote channel selection along with an "off" position.

#### Outcome

Mr. A. never truly accepted any of the electronic devices, aides, or interface hardware which the attending group had devised. In retrospect the reasons for this rejection were probably many. He seemed to cherish the attention the group gave while in his presence and consequently did not work consistently alone. The inadequate interface equipment probably caused much of his frustration but he did not seem to try to make the best of a marginal situation by even brief exploration. Since the communication was by selected letters of the alphabet we assumed he could spell and would keep track of his messages. This, we found, was a gross error. Retrospectively checking into his background we discovered that the written word was not important to him, and this had never been a satisfactory means of communication. This was a critical omission on the part of the group, - that of determining the person's premorbid interests and personality, establishing in our minds his realities, and perhaps most important of all that of involving him in all goal decisions, - no matter what the difficulty. You can imagine how defeated we were to come to see him on some aspect of the developments, only to have him turn his head to the farthest extreme, and either close his eyes or look at the corner of the room. There was no doubt he was communicating, and we knew we were not welcome.

#### Conclusions

Since these encounters which ended about a year ago we find that Mr. A. is able to be home periodically, under the care of Mrs. A. but with frequent return visits to the V.A. Hospital in Ann Arbor for skirmishes with inevitable problems. From the point of view of the group we summarize our position by the following admonitions to those who find themselves in a situation similar to ours.

1. Check premorbid history of patient.
2. Set goals related to that.
3. Insure some kind of success to stimulate continuation.
4. Expect reverses during the course.
5. Bring patient into all decisions! Sooner or later he will affirm or deny the choices anyway.
6. Don't insist on success from your subjective point of view!

Mr. A. has returned to his life with the minimum of devices, - a simple alphabet board, and the loving presence of the one who was important to him. Perhaps he felt we were threatening to take that away from him, - and perhaps, unknowingly, we were.

## A PROGRAMMABLE LIGHT BOX FOR THE PHYSICALLY HANDICAPPED

by

Jon W. Eberle, Ph.D.  
Biomedical Engineering  
Southern Methodist University  
Dallas, Texas

Michael C. Romaine, Ph.D.  
Zale Foundation  
Dallas, Texas

In working with patients who are afflicted with cerebral palsy, the observation has been made that many of the patients appear to have alert and active minds, but are unable to adequately express their wants and needs. To help alleviate this problem, a portable light box has been developed to permit the patient to communicate in an effective manner. When controlled by the patient, it basically is a light point that can be directed by the patient to a variety of visual aids, such as the alphabet and numbers, pictures, words and phrases, special language designators or a variety of games for entertainment purposes.

### Introduction

On a number of occasions, it has been observed that patients in the United Cerebral Palsy day care centers have indicated frustration and sometimes anger in their inability to communicate basic messages to their teachers and therapists. Preliminary studies have indicated that many of these patients have active and alert minds, this fact being generally masked by the patients' inability to control voluntary muscle groups. On one occasion this was forcefully demonstrated by a young girl with an alphabet board and a pointer which was affixed to the girl's head by means of a helmet. With this elementary apparatus, the girl was able to communicate in a reasonably expeditious manner and could make known basic needs.

From this demonstration, it was felt that if a more effective device could be made available for a wider range of patients, a very real need would be satisfied among cerebral palsied individuals as well as other individuals afflicted with conditions that rendered verbal communication difficult and with inadequate voluntary muscle control.

### Background Information

The initial requirements for a device to permit a patient to communicate were that (1) it be inexpensive so that many patients could avail themselves of it if it were successful, (2) that it be portable so that the patient could transport the device with him on his wheelchair or other suitable mode of conveyance, (3) that it be simple so that its operation could be easily understood by a wide range of patients, (4) that it be electrically safe under a wide variety of circumstances, (5) that it be easily maintained should a malfunction develop, (6) that it accept a wide variety of inputs, thus making it adaptable to a wide variety of patient capabilities and (7) that its operation be easily adjustable to accommodate a variety of patient needs.

The basic vehicle to accomplish the above was a two-dimensional matrix that would have each

matrix position identified by a light source. The light sources could then act as an optical pointer that would be controlled by the patient. Each matrix position would contain media appropriate to the intended task. Thus letters, numbers, words, phrases, pictures, colors or symbols for games or other languages could be placed in the matrix positions in a convenient sequence or order.

Several approaches were available to implement the control of the light pointer. Serious consideration was given to the use of digital integrated circuits and to other integrated circuits that permit a television screen to be used to display the desired information. Both approaches were ruled out, at least initially, because of cost. The digital integrated circuits although in themselves are quite inexpensive, can prove to be a relatively expensive approach because of the power supply needed and the interface devices between the integrated circuit output and the light sources, which initially would have the brightness of a 25 watt incandescent lamp. The other integrated circuits used to create an alpha-numeric display on a television screen (such as used in the widely available TV ping pong game) offer an attractive alternate solution, but was decided against because of initial cost and complexity.

Because of the variety of input devices that may be required for the light box to operate with a variety of patients, it was elected to have the light pointer be actuated by means of a contact closure. The biomedical engineering department at SMU has developed a wide variety of sensory pickups that can be adapted to many patient abilities. For example, a simple EEG system can be used, with proper electrode positioning and filtering, to detect eye blinks, eye movement, mental activity and any muscle group contraction that is under voluntary control by the patient. Other sensors will detect breath control maneuvers, galvanic skin response activity, etc. These sensors can provide a switch closure when actuated. Along with straight forward mechanical switches, most any patient can be

given access to the use of the light box.

The adjustments required to make the box versatile are mainly in the speed of response and in programmed time delays. It was noted that many of the patients surveyed had some form of voluntary muscle control, but that the control was of a spastic nature. This caused the patient to take varying amounts of time to actuate mechanical controls and that where actuated, many times several actuations would occur in rapid succession. Because of this, time delay was required in the system so that after initial actuation by the patient, the system would be unresponsive to further switch closures until the system control timed out. In this way, if the patient locked onto the control or actuated the control in rapid succession, the optical pointer would not respond. This time delay must be adjustable however, because of the various degrees of control exhibited by different patients and due to the learning process of a single patient.

#### Light Box Description

The initial configuration selected was a 6 x 6 matrix of 25 watt incandescent lights back illuminating an opaque sheet of plastic for safety. The mode of control of the lights was obtained from two timer motor driven, multiple cam operated switches which are quite inexpensive and obtainable from a wide variety of sources. Various motors are available to drive the cams at any desired speed and can be easily changed to suit the needs of the patient. For the 6 x 6 matrix, one series of switches was used to drive the rows and the other was used to drive the columns. The cams were adjusted so that a switch closure was available every sixty (60) degrees of shaft rotation. In this manner when the timer motor was actuated by the patient, the timer motor would advance sixty (60) degrees and then stop until the patient again provided an actuation signal. During the time the motor was rotating, any signal from the patient was ignored until the timing sequence was completed.

Considerable flexibility is available from this configuration. As many rows and/or columns as desired can be driven with any desired timing cycle. In actual operation the patient can actuate either the row or column sensor and the light pointer will sequence across the row or down the columns to get to the desired location. When this position is reached, the patient can so indicate by an audible signal and progress to the next position.

#### Summary

To date a limited number of patients have had the opportunity to make use of the light box. However, from its limited use it is possible to draw some conclusions that will be helpful in designing the second generation device.

The adjustable time delay for sequencing the optical pointer is a valuable feature in that it permits the device to be used with a large number of patients. Some patients are able to control the system with no time delay, whereas others require time delays of up to 10 seconds. It is felt that the brightness of the display does not have to be as bright as was originally thought and hence the system can be made physically smaller.

With the smaller size and lesser brightness, the dimension of solid state control becomes more attractive and cost beneficial, due to the ability of many solid state devices to directly drive a display or light source.

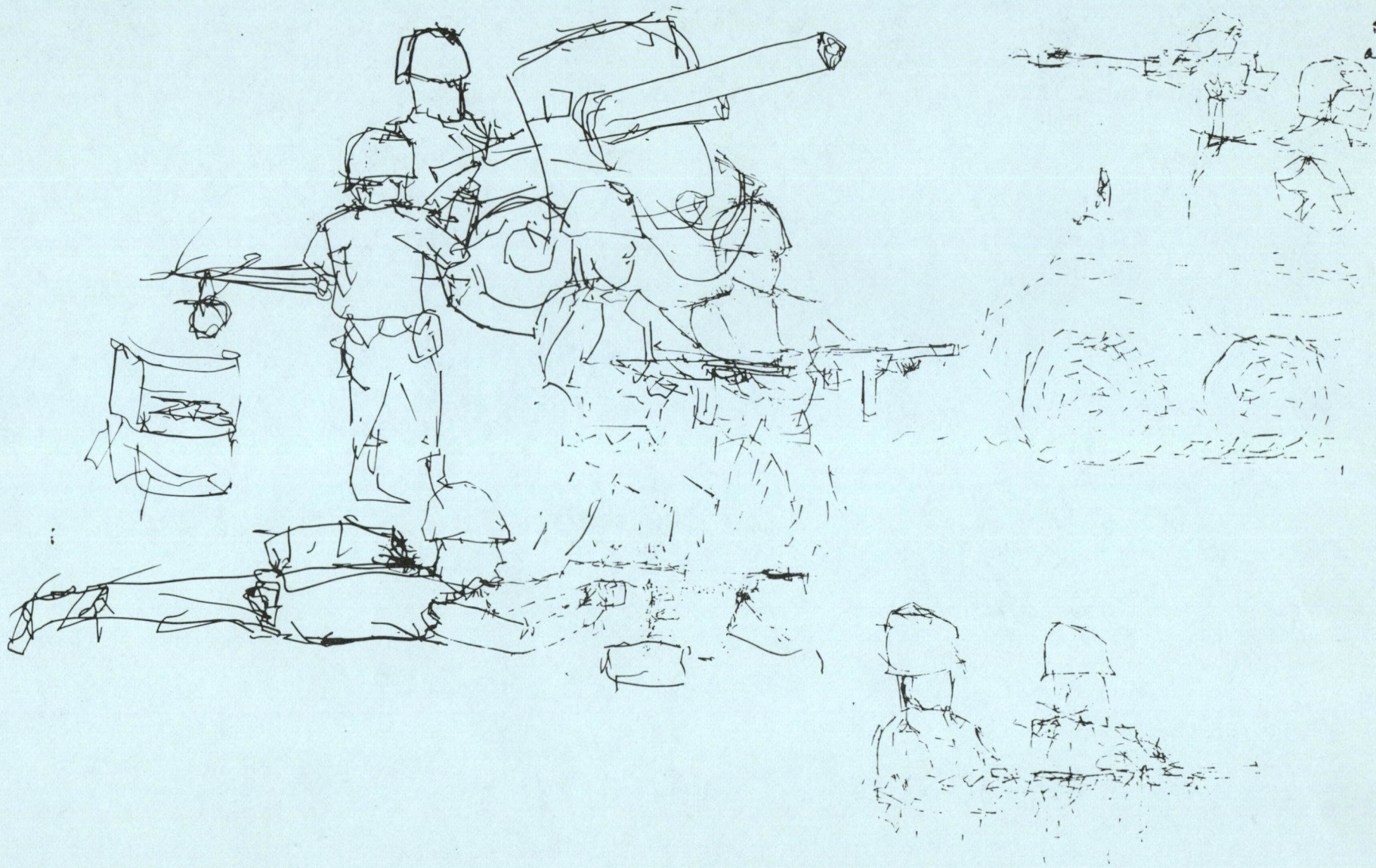

SESSION C

# SYSTEMS FOR SPINAL CORD INJURED CLIENTS

## TALKING TO COMPUTERS—POWERFUL NEW TOOLS FOR THE PHYSICALLY DISABLED

by

Kenneth H. Miller  
SCOPE Electronics Inc.  
1860 Michael Faraday Drive  
Reston, Virginia

In the next decade, computer-based systems will become a dominant factor in the lives of a large segment of the handicapped community. This dominance will be broadly based, with computers playing vital roles in vocations, education, communications, and therapy. This paper describes applications of voice-operated, telephone-linked computer terminals for persons unable to write or type. Results point to important new possibilities for intellectual and communicational development of severely disabled persons.

### Introduction

This paper submits three major concepts:

- Computer access is available anywhere.
- Voice-operated remote terminals can make computer power available to persons unable to use their limbs.
- To the bright person who is unable to write or type, voice-operated computers offer a world of opportunities for therapy, education, communication, and vocational development. Voice input diminishes the significance of physical handicaps and enhances the potential for intellectual development in the computer field.

The following sections develop these concepts, describe the VDETS speech terminal, and discuss several current applications.

It is recommended that regional groups of voice terminal computer users be formed to share ideas and facilities, develop employment opportunities, and provide training to others. These associations would evolve improved methodologies for efficient man-machine interaction.

### Access to Computers

#### Computers Are Everywhere

We are completely surrounded by computers and more are being installed every day. They are used in business, government, research and engineering, and are becoming increasingly important in medicine and education.

#### Time-Sharing Versus Minicomputers

Computers with vast capabilities can be accessed by telephone from anywhere in the United States. These systems are called time-shared computer networks. Since computers are so fast, a single computer may conduct dozens of interactive conversations with different people in different locations simultaneously. This sharing brings down the hourly cost to individual users. For experimental and demonstration purposes, government and industry could make these services available at very low cost during non-prime use hours. They are as near as your telephone.

A second force in getting computer costs down is mass production of increasingly efficient minicomputers and microcomputers. Powerful small-

business computer systems are now available at prices as low as \$12,000, while minicomputers with limited capabilities range in cost from \$1000 up. Minicomputers are currently affordable by schools, institutions, small businesses, groups, or even individuals.

#### Remote Computer Terminals

The simplest conventional terminal for remote access to a computer is a teletypewriter. For \$1200 to \$1500, a person can have a data modem and a teletypewriter installed in his home, permitting him to communicate by phone with time-shared computer services. He dials the service number and commences typing his side of the conversation to the computer, which responds by typing back to him on his teletypewriter.

#### Voice Computer Terminals

A voice-operated computer terminal is somewhat like a teletypewriter without a keyboard. You talk to it. It figures out what you said. It translates your message to codes the computer can understand, just as a keyboard would. These codes are transmitted by telephone to the computer service. The computer's responses are written back on the terminal's printer or TV screen.

It now appears that one of the most important applications for voice-operated terminals is for handicapped persons who can't use a keyboard.

Speech recognition devices are also being applied to environmental control devices for quadriplegics. At present, mechanical devices seem more appropriate for environmental control in situations involving very slow or occasional information transfer rates. The power of speech recognition devices becomes much more important in high information rate environments such as typing or interactively using a computer.

### Voice Terminals

#### Early Development of Speech Recognizers

Until the last three years, speech recognition devices recognized small vocabulary sizes (10 words) with good accuracy and large vocabulary sizes (60 to 100 words) less accurately. This performance was not good enough for a practical computer terminal. Research and development was supported by government-funded studies and tests. Recognition accuracy slowly improved in response

to these research efforts, until about two years ago SCOPE Electronics Inc. agreed with the Veterans Administration Prosthetics Center<sup>1</sup> to build and test two systems, called VOTECS and VOMECS.

#### VOMECS

VOMECS (Voice-Operated Multi-User Environmental Control System) has a vocabulary of 15 words for each of four users. The system listens to commands from any of the four users and operates electrical environmental control boxes at each person's station in response to the spoken commands. Since a single speech recognizer is able to service many stations, the cost per station can be made reasonably low. This unit was delivered to the Castle Point Veterans Administration Hospital in March 1975 and is now undergoing evaluation. It is likely that this system will evolve into practical use after further engineering and testing.

#### VOTECS

The second unit developed for the VA was delivered to the McGuire Veterans Administration Hospital, Richmond, Virginia in January 1975. This system, called VOTECS (Voice-Operated Typewriter and Environmental Control System) has sparked a new concept in man-machine interaction, spawned a new generation of commercial speech recognition systems, and set the stage for many new applications for the handicapped. VOTECS, pictured in Figure 1, controls 12 environmental devices such as lights, radio, TV, nurse call, raise or lower bed, etc., and allows control of the full keyboard of an electric typewriter. All functions are selected by spoken words. VOTECS' vocabulary of 100 words includes letters, symbols, digits, words, and phrases, as well as the necessary control words to move through various syntax levels. The major engineering achievement was attainment of high accuracy and large vocabulary through the use of a syntax tree. In any syntax level, the speech recognizer only has to select a word from among the vocabulary subset in that syntax grouping. A 16-character buffer display provides the means for verification of voice commands and text editing. The text editor allows the user to delete the latest character or to erase the entire 16-character buffer before printing, so that it is possible to obtain an error-free typewritten copy.

The only manual operation required is to have someone activate a button to initiate the

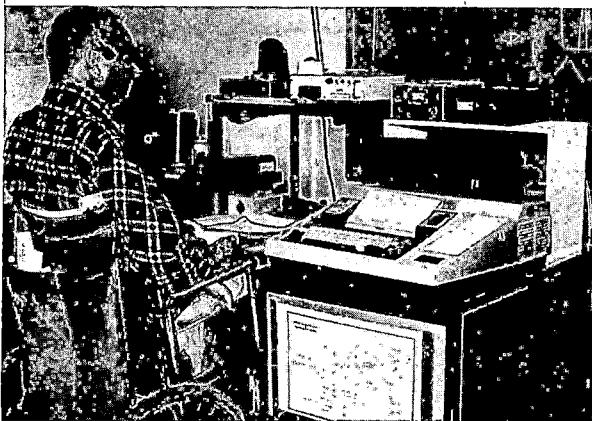

Figure 1. Voice-Operated Typewriter and Environmental Control System

process in which VOTECS is trained to understand the user's voice. Once training is started, no further manual operation is required. Individual word retraining is entirely voice operated.

Experience with VOTECS is discussed further later in this paper.

#### SPEDEM Terminals

Since the previously described VOTECS system employs an electric typewriter which is a very popular computer terminal,<sup>2</sup> only minor development effort was required to extend the VOTECS system to a full voice computer terminal.

In the late stages of VOTECS development, an internal research and development effort was funded by SCOPE to develop this computer terminal, called SPEDEM (SPEech DEModulator). See Figure 2. A SPEDEM was built and then deployed at the Woodrow Wilson Rehabilitation Center for a demonstration project.



Figure 2. SPEDEM Terminal

The SPEDEM was similar to VOTECS. The differences are listed here:

- The environmental controls were left out.
- The typewriter was replaced by a television-type (CRT) terminal to eliminate paper handling since the intended user was unable to use his limbs. Since he is on-line with an interactive computer, paper was also unnecessary. Messages are written onto and recalled from a disk memory at the central computer facility, and displayed on the CRT screen.
- The voice command system did not write directly on the CRT. Rather, it transmitted an ASCII-coded version of the spoken command via data modem over the telephone to the time-sharing computer. The computer, in turn, buffered the received message and echoed it by phone back to the user station. This echoed version of the message was displayed on the user's CRT so that he could read it and correct it if necessary. This eliminated need for the VOTECS buffer and 16-character display.
- The SPEDEM vocabulary was selected to match the BASIC programming language, the DEC-10 time-sharing system monitor commands, and algebra.

Interaction between a man and an interactive time-sharing computer service represents a high level of man-machine communication. This traffic has had the man's inputs via keyboard rather than speech, but the time-sharing protocols still offer very efficient interchange. The first hours of talking to computers did suggest some shortcuts peculiar to speech, however. The typewriter must send one character at a time while the SPEDEM is word-oriented or even phrase-oriented. For example, when the user speaks the word "LOGIN" to the SPEDEM it transmits the entire login sequence to the host computer:

```
"LOGIN 1200,500  
PASSWORD: UVA55"
```

a sequence which requires 21 keystrokes on a keyboard. A number of such shortcuts are present in the SPEDEM vocabulary.

In January 1975, the prototype SPEDEM established communication by telephone with a DEC-10 computer and an engineer conducted the first completely unrestricted conversation with a computer, each party speaking its natural language.

#### VDETS Series Systems

After the first conversation of this sort, many more followed. Many engineering improvements were made to enhance information throughput, system flexibility, and convenience in a new generation of speech systems called VDETS (Voice Data Entry Terminal System). The VDETS 1000 Series is now operational. An example is shown in Figure 3. The system is modular and standardized for communication with computers and data systems, so that new applications are easily accommodated. The terminal can be programmed to match each application. It controls displays, prompts the operator, manages training, syntax, and recognition under the rules set forth in its control program. A unique feature is the specification of the control program in a high-level language, which permits users to write their own applications software or to modify control programs. The user can specify such items as number of users, vocabulary size, I/O devices, buffers, dictionary of vocabulary items, prompt and error messages, action structure, and syntax structure. This makes VDETS an ideal experimental vehicle for research, therapy, and education.



Figure 3. CIL VDETS System

VDETS will support from one to four users simultaneously on a non-interfering basis, thus reducing cost per station. It can be trained to respond to any user, regardless of language or dialect, in a few seconds per vocabulary item. Each user's voice patterns can be stored for recall. It can support a variety of minicomputer peripherals. Synthetic speech feedback is a popular option. Error rates are greatly reduced relative to the old design.

#### Applications in Rehabilitation

This section will review several rehabilitation applications which have made significant progress to date, and trace the evolution of thinking in this area.

#### Veterans Administration's VOTECS

VOTECS' primary function is as a voice controlled typewriter (see above). VOTECS has been used and demonstrated since early 1975 by John P. Jones, a patient at McGuire VA Hospital,<sup>3</sup> shown at the console in Figure 1. The breadth of possibilities opened up by VOTECS is illustrated by a memorandum from Mr. Jones. Excerpts follow.

#### "VOTECS—USEFULNESS FOR THE HANDICAPPED"

"I have been using and testing the VOTECS for several months. I have found it to be of great value to me in many practical ways. I believe that any person who has lost the use of his hands would benefit from working with this machine, both practically and as a form of therapy.

"I was injured in an automobile accident in 1967, resulting in paralysis of my legs and arms. At that time, I was 44 years old, and had been working for about 20 years as a mathematician and actuary for the federal government. I hold a B.S. degree from Wake Forest University and maintain a membership in the Society of Actuaries as an associate. I served in the U. S. Navy Amphibious for 3 years during World War II.... I am interested in chess, tutoring students in mathematics, and of course working with the VOTECS.

"I have used the VOTECS typewriter in numerous ways, many of them at the request of other paralyzed patients. For instance, I prepared a list of station names for a patient interested in Citizens Band radio. Another patient and I wrote a short script for an 'Amateur Hour' in which he was to appear. For the PVA (Paralyzed Veterans of America) I have prepared miscellaneous items, such as an inscription for a plaque to be presented to a retiring employee, a list of employees on duty on my ward during certain hours. I wrote, at the request of a nurse, my ideas concerning the high quality of work performed by an employee being considered for a special increase in pay. (He got the increase.) Routinely, I use the VOTECS as a 'blackboard' demonstrator for students whom I am tutoring.

"In addition to helping other people, the VOTECS helps me, in many ways. I use it to write personal letters to people I have been wishing to correspond with for years. It is also useful as a memo pad on which I can jot down my ideas, reminders, etc....

"One of my computer programs is in use at Acacia Life Insurance Company, Washington, D.C., as a

part of their job control program. This program, which I wrote just for amusement, is a 'perpetual calendar,' calculating the day of the week corresponding to any given month, day and year. Acacia found it to be useful for automatically making certain that programs which are to be run every Tuesday, for instance, go through as a part of that day's routine set of computer runs.

"Any person of normal ability can learn computer programming if he or she is interested and willing to train for a few weeks. It seems to me that many handicapped persons should be able to secure useful jobs in this field using the VOTECS system...."

—John P. Jones.

Experience with VOTECS has shown three limitations which are corrected in the later VDETS systems. The most significant limitation is that it is not outfitted as a computer terminal but merely as a typewriter, so that it stops short of realizing its full potential as an educational, therapeutic, and vocational tool. While the ability to write is extremely significant for an individual who could not write before, it is only a fraction of the power which might be derived from being able to write, access huge data bases, program procedures, and communicate electronically.

A second limitation is the inability of VOTECS to record many users' voice prints and save them. Because of this, if several people share the system, each must retrain it whenever another person has used it before him. This has an inhibiting effect on the sharing of VOTECS.

Beginning in March 1976, VOTECS is being used in evaluation of a quadriplegic veteran for vocational training in programming and computer use. The ultimate objective being considered here is to develop a homebound vocation in a computer-related job, using a VDETS terminal. Hopefully, this program will be a prototype for a continuing training program.

#### SPEDEM Applications

The SPEDEM system was demonstrated in cooperation with the Woodrow Wilson Rehabilitation Center.<sup>4</sup> The project was originally proposed by Mary T. Broman of the Center, for client Mike Zaza. The history of the SPEDEM is also a history of Mike Zaza, who has worked diligently and successfully on the project since early 1975.

The client suffered extensive brain damage when he was hit by a truck at the age of 12. The diagnosis was bilateral upper motor neuron lesion causing quadriplegia, aphasia, and hydrocephalus. Hydrocephalus, quadriplegia, aphasia, seizures, mental regression, and respiratory distress with difficulty coughing and swallowing were the sequelae.

In 1967 the client was admitted to the Woodrow Wilson Rehabilitation Center (WVRC) where he received physical and occupational therapy. After a number of unsuccessful attempts to find a vocational objective, the client stated that he wanted to study computer programming. He was sent to the Business School for an extensive evaluation, and it was felt that he had the intellectual abilities to program, but was not physically able to do so. His typing ability was so limited that he required full-time assistance while operating the computer terminal. Also, it was questionable whether or not the anticipated level of individualized

instruction could be provided. There seemed to be no hope for success as a programmer unless the client could achieve the ability to work independently for extended periods of time, and that seemed unlikely.

A program was initiated to assemble and evaluate the SPEDEM computer terminal using this client as a pilot subject. He was given a BASIC programming manual, the SPEDEM, and unlimited access to a DEC-10 time-sharing computer service via telephone. Programming instruction was carried out by means of a computer-aided instruction (CAI) sequence available on the DEC-10 system. This allowed the client to pursue the course at his own pace and without an instructor. In this way, the client successfully completed a 17-lesson instruction sequence in BASIC programming, demonstrating that a severely disabled individual could learn to write, debug, and operate computer programs, strictly by voice control, operating over long distance telephone circuits. Many demonstrations were given by the client. Although this pilot effort was successful from the standpoint of the client's development (and the SPEDEM's), it could not be integrated into the Woodrow Wilson program for a variety of reasons, and the client was sent home to Waldorf, Maryland. Based upon his prior work, however, the George Washington University Job Development Laboratory<sup>5</sup> and his Maryland Rehabilitation counselor recommended further work. A SPEDEM system was purchased jointly by the client's parents and the State of Maryland and installed in his home. The State also supported a training course in advanced FORTRAN programming. The course methodology itself was novel and very successful.

The usual philosophy in accessing time-sharing computers is to do as much preparation off-line as possible, get on and off as quickly as possible, and don't make any mistakes because you are paying for the computer by the minute. This mode is not efficient in terms of program development time and expends more programmer time in order to use less computer time. A more natural communication situation is one in which the programmer can relax and use the computer's power to help him in every stage of designing the program, preparing it, testing it, and debugging it. This is absolutely necessary in the case of the handicapped programmer who is unable to write or draw flow charts off-line. It was decided in this experimental situation to give the student unlimited on-line computer time, anticipating that this advantage would partially offset the inability to write and draw.

The initial reactions of several educators to the client's prospects were that he could not type fast enough by voice to do data entry as a vocation (true) and that he could not be a successful programmer because he could not flow chart (false)!

Studies indicate that a creative programmer using voice input to a computer may compete favorably in productivity with a programmer using a keyboard, and that his typing speed is not a significant factor in productivity. For mere copying, however, voice cannot compete favorably with keyboards, since copying is primarily a mechanical task whereas programming is an intellectual and communication task.<sup>6,7</sup>

Flow charting, the conventional way of designing program logic and structure, is more difficult to bypass. Given the problem of inability

to flow chart, the approach taken was simply to start development of increasingly complex programs and let the student and teacher evolve methodologies of design. This has been successfully demonstrated to the extent that the client has completed the advanced FORTRAN course successfully and has developed and maintained large and complex programs, including 1) one which conducts an interactive test of his SPEDEM recognition accuracy, does automatic scoring and maintains an historical file of all tests to date; 2) a set of accounting programs which edit files and generate reports; and 3) a sophisticated communications management system which allows confidential electronic communications between any users of the computer center via an electronic post office system.

The teacher in this course was SCOPE's chief programmer. Communications were achieved by leaving messages in disk files on the computer. Typically, the teacher would check the disk area each afternoon for messages from the student. He then left a message answering questions, extending homework, and "lecturing." The teacher looked at the student's programs and ran them daily to keep in touch with progress. This communication was augmented by phone calls on a weekly basis and visits on a monthly basis.

Conclusions are that the unlimited access to on-line computer time and utilities did, in fact, compensate considerably for the client's inability to write and draw, and for the indirect access to his teacher.

At this time, Mike is a well qualified entry-level programmer with hundreds of hours of on-line experience. He is active as a part-time employee of SCOPE Electronics and is participating in starting a computer service company with several associates. He is also assisting in training and evaluating other quadriplegics for programming careers.

While technical competence is the most obvious measure of success of this effort, it may not be the most important. Mike's attitude, ambitions and self-confidence have improved very drastically. His physical endurance and speech have improved beyond recognition from the rigor of intense daily work. The horizons of his life are now much broader, and he is an active participant in a technological, business, and social environment.

#### VDETS Evaluation by Rehabilitation Services Administration

In November 1975, Rancho Los Amigos Hospital in Downey, California contracted for three VDETS terminals to be delivered to Northwestern University in Chicago, Moss Rehabilitation Center in Philadelphia, and Center for Independent Living in Berkeley, California. These systems were delivered in March and April 1976. The CIL system is pictured in Figure 3.

These systems have major advantages over earlier systems. A magnetic tape cassette unit is provided for storage and loading of different

programs and different users' voice patterns. Each system has a CRT, a 16-character display panel and a printer for display to the user.

The major objective of the program is to evaluate VDETS as a vocational rehabilitation tool. A wide diversity of experience is being acquired both in terms of the variety of handicaps and variety of applications now being tested by these three institutions.

#### The Next Step

It is clear that the trends will continue to make computers more economical and more accessible, and speech terminals are beginning to make computer careers reachable by persons unable to use their limbs. Speech recognition will also contribute to future training, drill, and therapy for persons with hearing and speech impairments.

In the vocational area, we must make these new opportunities available to qualified individuals. Now that the technology is demonstrable, it is time to incorporate speech systems into experimental vocational evaluation and training programs and to develop teaching methods to utilize the new capabilities. Vocational counselors should seek more awareness of the opportunities and disciplines of computer applications for handicapped persons. Beyond that, the handicapped individual must do a lot on his own to secure and maintain employment in a sophisticated job market. To develop this self-help aspect, user's groups should be formed to share knowledge, experience and facilities.

Use of speech-recognition terminals in education and therapy for the handicapped is promising but unexplored. The next year should see several pioneering efforts in these areas.

#### Footnotes and References

1. Veterans Administration Prosthetics Center, New York City, Contract 9705-R. Project Manager was Mr. Ronald Lipskin, Mobility Aids and Environmental Controls, Biengineering Research Service.
2. Texas Instruments Silent 700 typewriter.
3. VOTECS applications and demonstrations are administered by Mr. W. T. Miller, Coordinator of Rehabilitation Medicine, Rehabilitation Medicine Service, McGuire VA Hospital, Richmond, Virginia.
4. J. Ellies Moran, Director, Woodrow Wilson Rehabilitation Center, Fishersville, Virginia.
5. K. Mallik, Director of Job Development Laboratory, Division of Rehabilitation Medicine, George Washington University, Washington, D.C.
6. A. Chapanis, "Interactive Human Communications," *Scientific American*, Vol. 232, No. 3, March 1975, pp. 36-42.
7. K. Miller, "Typing Speed as a Factor in Voice Programming," SEI TM-310, 11 April 1975, SCOPE Electronics Inc., Reston, Virginia.

A SELF-CONTAINED PNEUMATICALLY OPERABLE TAPE  
RECORDER/DICTAPHONE FOR THE HIGH QUADRIPLEGIC

by

Calman Gold, M.E.  
Institute of Rehabilitation Medicine  
New York University Medical Center  
New York, New York

The design and operating features of a complete breath operable tape recorder/dictaphone for the high quadriplegic patient are described. The unit is compact, battery operable, and consists in a CMOS digital controller and audio circuitry interfaced with a commercially available cassette tape transport and control board. The recorder may be used as a stand-alone unit or an accessory to a multi-functional environmental control system.

Within the past few years, an increasing number of high quadriplegic patients (above C5 level) have appeared in rehabilitation centers. These patients are typically between 16 and 25 years of age. The increase of this patient population is attributable to early emergency treatment at the time of injury, and rapid transfer to centers prepared to deal with spinal cord trauma. As better emergency care is promulgated, it is expected that the number of such patients will continue to increase throughout the nation.

Due to the high level of injury, respiratory function is impaired to a variable degree, and functional sensation and musculature are confined to the facial and cervical areas. Notwithstanding the need for almost constant attendant care, these patients require special and innovative assist devices for mobility, and to enable them to engage in even minimal activities of daily living.

At present, there exist a number of commercially available "comfort and environmental control" systems to provide the high quadriplegic with the means to operate television sets, radios, call alarms electric bed controls, and other home appliances. Controls are typically effected by means of pneumatic ("puff and sip") switches or other switches, permitting the patient to select a specific function and to control it. A number of commercial suppliers exist, and although a number of field reliability and repair problems must be overcome, the conceptual design of such systems is well established. Future developments may include speech recognition and micro-processor controlled systems which would provide for more sophisticated functions to be controlled by the patient. However at present these systems may not be cost competitive with MSI/LSI logic implementations which even now exhibit a rather high cost, primarily as a result of the small market volume

and hence manufacturing volume of these products.

The majority of available systems are based on the concept of centrally located multi-functional support, primarily intended for home and bedside use. Some are specifically designed on the premise of a totally and permanently immobilized individual. Considering the state of the art of pneumatic and other wheelchair controls for high quadriplegics, total immobility is not only an undesirable viewpoint but also unrealistic. While recognizing the need for fixed installation environmental controls, one must also recognize their inapplicability in a number of vocational and educational situations where portability is mandatory.

Presently required are a number of vocationally oriented devices for the high quadriplegic who is a student or writer, potentially employable as an office or industrial worker, or who wishes to conduct a home business. One such tool presently needed is a pneumatically operated tape recorder/dictaphone system, suitable for use on a wheelchair lapboard and battery powered as well as suitable for use as a line-powered entertainment device or as an accessory to available multi-functional environmental control systems. The design and operating features of such a device are the subjects of this paper.

The basic objectives in the development of the tape recorder were to achieve both a reliable and a marketable end product. A primary reason for this undertaking is that while existing rehabilitation centers can provide some support via custom internal or external modification of existing cassette recorders, they cannot hope to serve as manufacturing facilities for the quadriplegic patient population on a nationwide or worldwide basis. Thus a major consideration in our

design approach was to employ an available "off the shelf" tape transport designed to be remote controlled and having a field proven reliability in industrial usage. It was also felt that the incentive to produce such a device would be considerably enhanced by providing the potential manufacturer with a completed engineering design utilizing an existing product for which development costs would not have to be incurred.

The major design features required of the tape transport were portability, wheelchair battery operation, remote control capability, dynamically controlled tape handling, a minimal number of moving and mechanical components, proven reliable operation, and a reasonable cost. To this end we chose to use a cassette tape transport and motor control board known as the Phi-Deck, manufactured by Triple-I Labs, Division of the Economy Co., Oklahoma City, Oklahoma. Several thousand units of this device are in the field and being used for language labs, teaching machines, and computer peripherals. The specific model used in our design is a fixed speed deck and a CMOS logic control board providing full remote control of all transport functions, dynamically controlled tape handling, and transport status outputs to drive indicators. Record/playback circuitry is not included in the transport however this has been designed into our interface circuitry.

The functions available to the patient using the complete tape recorder are:

- Stop-terminates all operations
- Play-initiates playback
- Rewind-fast rewind
- Forward-fast forward
- Review-fast rewind a controllable distance with automatic playback actuation upon release of Review command.
- Record-activate recording
- Playback Volume-multistep volume control incorporated into Play function.

All operations are controlled via single tube pneumatic inputs, requiring one "puff" level and one "sip" level. We have assigned "puff" for function selection and "sip" for command actuation. A six position LED indicator array is used for function select indication, while a five position array is used to indicate active transport status. The patient puffs to the desired function and then sips to activate it. The functions are arranged in a cyclical order as follows:

STOP PLAY REWIND F.FWD REVIEW RECORD

There are six positions with no homing position; access time is negligible. This is also apparent when one considers that the Review function is another means of entering playback mode. The sequence Review-Record-Stop-Play is useful for editing tape segments quite easily.

The playback volume control has been incorporated into the PLAY function in the following manner. Upon entry into playback operation, each subsequent "sip" on the PLAY command cyclically steps the volume control. Once set, the volume level is retained for all playback use until altered.

The tape recorder has a built-in speaker, and uses a button-cell powered electret microphone for recording. In its present form, the recorder uses a stereo record/playback head. In record mode, both channels are recorded together. In playback, the right and left channels are mixed into a monaural channel to preserve full sound when the device is used for playing recorded music on stereo cassettes. The head outputs are available for applications requiring connection to a home entertainment system.

While we have not taken advantage of the bi-directional playback capability of the transport to gain greatly extended single track recording and playback, the excellent tape handling characteristics of the transport permit extra long play cassettes to be used with minimal chance of snagging or tape breakage. About 90 minutes per cassette side can be obtained using a C-180 tape.

The interface controller is shown in block diagram form in Figure 1. With the exception of the audio, display, and head circuitry, all components are integrated circuit packages with each block of the diagram representing one such device. The interface is plug-to-plug compatible with the Phi-Deck control, and all operating power is derived from the regulators on the Phi-Deck board. The basic transport commands are Stop, Reverse, Forward, and Play. The interface circuitry not only provides the audio circuits but also the combinatorial logic required to provide the appropriate sequence of deck commands for each recorder function.

With specific reference to Fig. 1, the pneumatic switch closures are conditioned by the debounce circuitry. The "puff" signal is used to step a decoded counter for function selection, with the selection position and active transport status being continuously displayed. The "sip" signal is used to strobe the active function line into a programmed monolithic diode matrix, which performs the combinatorial logic necessary to translate function lines into the appropriate transport and audio commands. Activation of Review function engages rewind until "sip" is released. The trailing edge of the "sip" pulse triggers the one-shot to engage playback mode.

The volume control is enabled by entry into play mode, and disabled by exit from play mode. A tri-state CMOS analog selector is used as a digitally controlled attenuator interposed between

a single stage common emitter pre-amp and an integrated circuit power amplifier. The attenuator is only active during playback. In the record mode, it is forced into a high impedance state, thus effectively removing it from the circuit while not disturbing the volume level set by the counter. This also prevents the playback attenuator from affecting the record level, a requirement because the same pre-amp and power amp are used for both playback and recording. Record level is maintained by a logarithmic compression scheme in the head coupling networks. Record/playback switching is achieved using CMOS compatible multipole magnetic latching reed relays, which draw no current except momentarily during the switch from play to record, and vice-versa.

Operation of the recorder by other means such as by touchpad switches may be implemented readily. For example, the debounce circuitry may be removed if necessary, and the step and strobe signals brought in thru a dual-inline socket cable. Alternatively, one could remove both the debounce and decoded counter circuits, and introduce active-high decoded function signals (e.g. from a BCD source) and a strobe pulse (active low).

The physical dimensions of the complete recorder are approximately 8" x 8" x 4", compact enough for use on a wheelchair lapboard. The unit may be operated from a 12 volt wheelchair battery or from the household line via a readily available stepdown adapter.

While the recorder was designed in the RT-1 Center research laboratories, efforts are currently being made to promote interest in manufacturing the device as an available product for the high quadriplegic and other potential consumers.

This work was supported by:  
 RSA Grant # 16-P-56801/2-15 "Rehabilitation Research and Training Center" RT-1 from The Rehabilitation Services Administration, Dept. of Health, Education, and Welfare Washington, D.C.

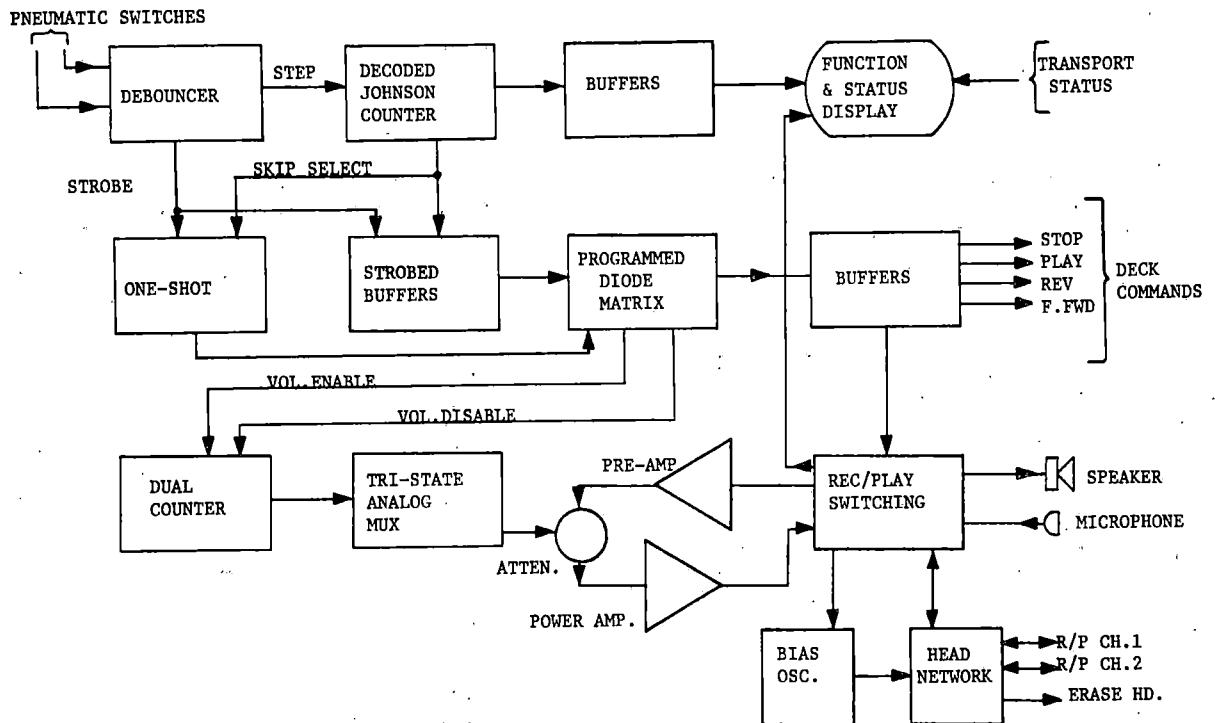

- FIGURE 1 -

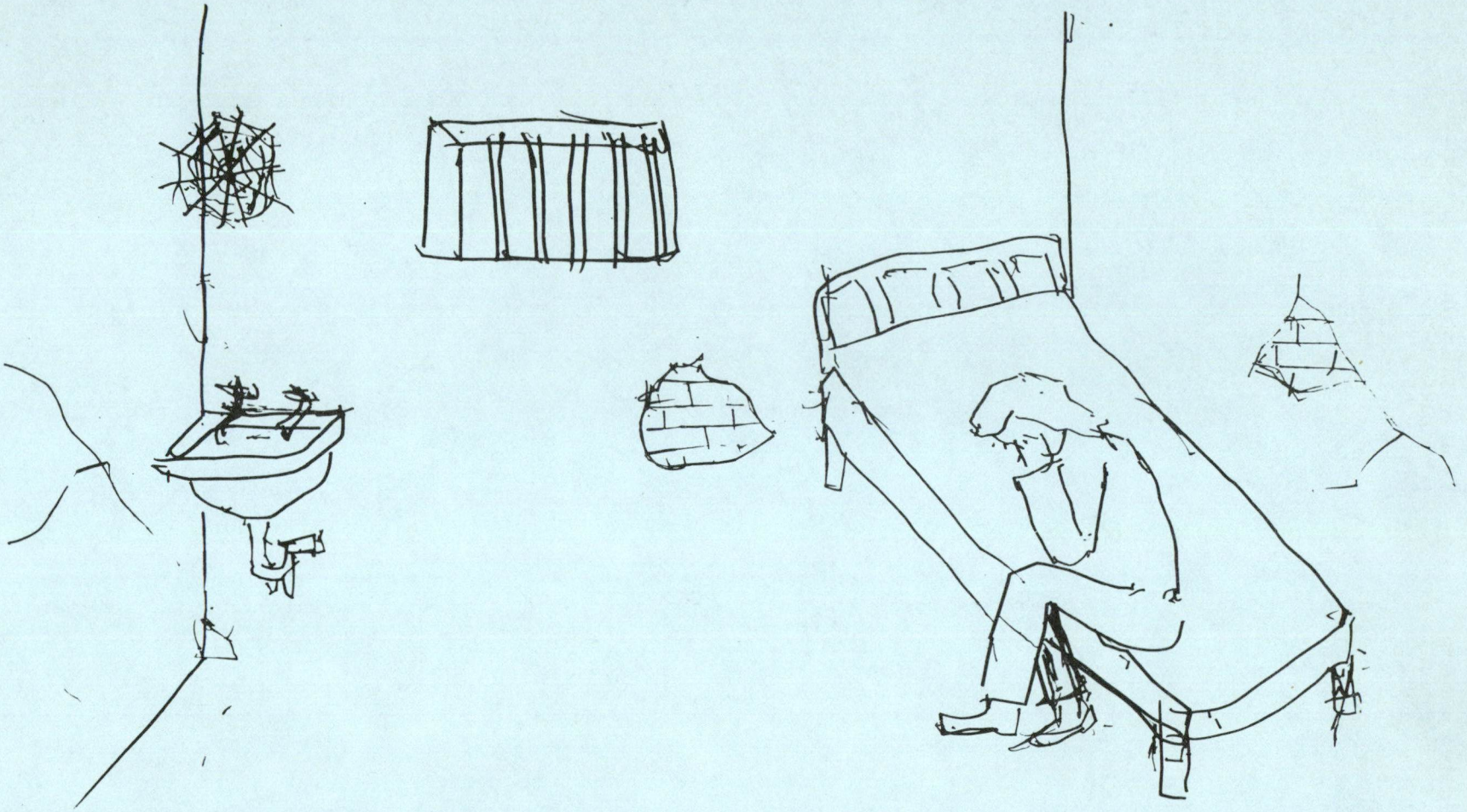

WHEELCHAIR BASED ENVIRONMENTAL CONTROL  
FOR QUADRIPLÉGICS

by

David M. Bayer, B.S.E.E.  
Dick L. Beery, B.S.E.E., P.E.  
Barry A. Romich, B.S.E., P.E.  
Romich, Beery and Bayer, Inc.  
Shreve, Ohio

Summary - An assistive devices control system has been developed for use by a quadriplegic which enables him to control a powered wheelchair as well as many other functions. Among them are remote control channels, tape recorder, powered splint, headlight, horn, siren, and powered recline. Various kinds of input devices can be used as the controller. They include joystick, chin control, shoulder position control, and controllers unique to individual requirements. A display graphically represents selected device, control scheme, and imminent activity of an output.

Introduction

High level quadriplegics and people having similarly extensive physical disabilities can be and have been assisted by various devices. Frequently the effective functioning of these people can be aided by the ready availability of multiple assistive devices. That is to say that ideally these units should be positioned for convenient use and that control of them should be continually available to the individual. Frequently, assistive devices, their utilization and/or control have been considered as one-at-a-time entities. In recent years systems involving groups of devices have been investigated, and a few such systems are being used. Fixed location environmental control packages are now available, and a few prototype wheelchair systems with limited capabilities are in operation.<sup>1,2,3,4</sup> Some have observed that properly assembled systems of these aids provide benefits greater than the sum of those resulting from the separate parts. The individual is able to attain increased independence, requires less continual attention from his attendant, is less apt to be hindered in performing some routine tasks, and can enjoy an improved attitude. These synergies are achieved when the relationship of the subject to his repertoire of assistive devices is such that he requires little or no help from other persons at the time when he chooses to change from the operation of one function to another.<sup>1</sup>

Generally assistive systems for the high level quadriplegic should include provisions for mobility (the powered wheelchair). Control of a powered wheelchair can be considered a two axis problem. One axis (y) being the forward/backward motion, and the other axis (x) being right and left turn. Simultaneous,

two axis, proportional control also represents a near maximum performance capability that quadriplegic subjects have attained utilizing state-of-the-art controllers.<sup>5</sup> Using an x/y format for the control of devices in addition to the control of a wheelchair provides a convenient means for organization and visualization of complex systems. This is shown in the diagram:

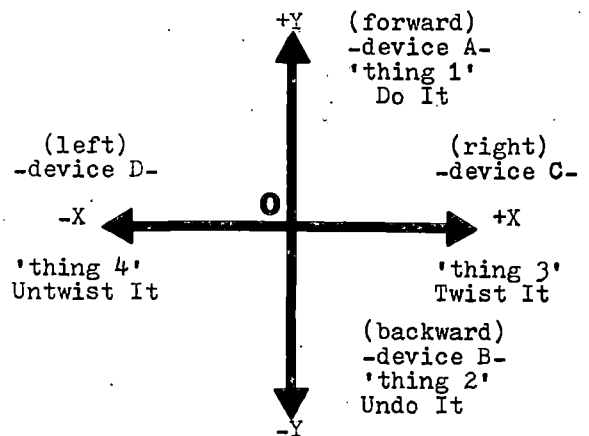

Clearly the use of multiple labels results in ever increasing confusion and clutter. As the complexity of the system increases an effective mode display should: 1) identify the devices under control, 2) the manner in which these devices can be operated, 3) when appropriate indicate that activation is about to occur, and 4) hopefully be small and non-interfering.

The apparatus which the operator manipulates to effect operation of devices will be called the controller. In order to control a variety of devices

with one controller, he must be able to direct its output to the desired device. Scanning can be used for selection of devices, and this approach has the advantage of requiring a minimum of control ability. The apparatus which activates scanning will be called the selector switch. It may be as simple as a switch closure.

Since the requirements of the individual vary (both in the devices which will provide assistance and in the means by which he is able/willing to control them), a generalized control system should provide flexibility both at the input and output ports. When the capability is available, proportion control of some devices provides the most effective functioning (powered wheelchair and possibly some types of powered hand splint), while in other cases on/off control can be an optimum solution. But in some cases the operator may be able to generate only on/off signals. The control system should therefore have a way of turning proportional signals into on/off signals, but should be able as well to accept signals from an on/off controller.

The DU-IT wheelchair control system developed by Romich, Beery & Bayer, Inc. is an approach aimed at achieving the capabilities which have been described. Its objectives are:

- 1.) to provide a control system where the controller and selector switch can be chosen to take advantage of the individual's capabilities, and the output functions (powered wheelchair, remote control, tape recorder, horn, splint, etc.) can be implemented to provide the utility he needs.
- 2.) to structure the system in a way that enables the operator to select and identify the functions under his control and to recognize the imminent activity of an output.
- 3.) to provide the prospect for complex control systems with manifold capabilities while insuring ease of operation and lack of clutter.
- 4.) to provide these capabilities economically in a package which can be tailored to the individual's needs.

The control system can be described as consisting of four main parts. They are:

- 1.) The controller/selector switch group
- 2.) The display module
- 3.) The control package-this is a weather-tight 12x10x5 inch box which mounts on the back on the wheelchair. It contains all of the control electronics but may not contain some of the electronics associated with particular assistive devices.
- 4.) The lapboard which serves conventionally the usual purpose, but also provides housing for some devices such as tape recorder, headlight, fan, etc. It can in some cases serve as a housing

or platform for the display module, controller and/or selector switch assemblies, and remote control transmitter.

The overall system is modular so that functions can be added, deleted or modified to suit the operator. Some control channels are uncommitted so that they can be utilized for specific needs.



Fig. 1- DU-IT wheelchair control system installed on a powered wheelchair.

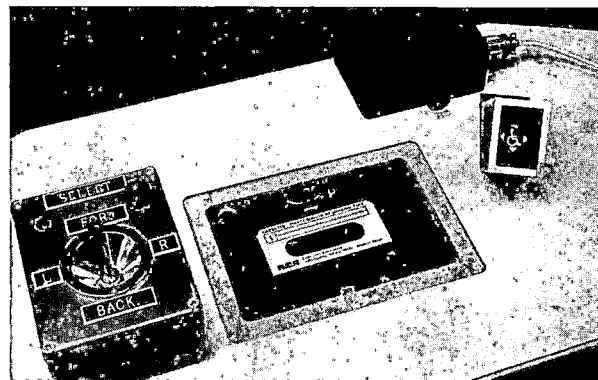
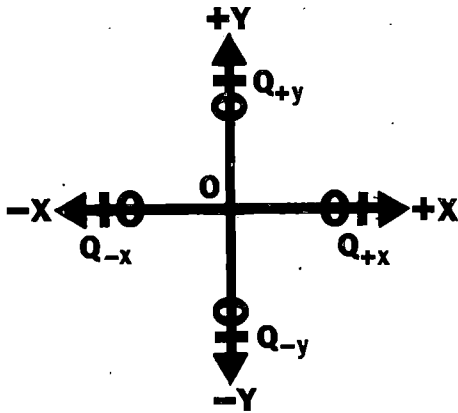

Fig. 2- Lapboard with tape deck, prototype display module, prototype remote control housing, and movable joystick controller with selector switch.

#### Multifunction Control Block (MCB)

The MCB is central to the control system. It is a single printed circuit board measuring approximately 7½ x 4 inches. It provides the functions which one would describe as general to a two axis control system. (It provides few functions which would be considered specific to a particular assistive device). MCB serves as a central switch board (controlled by the operator) for the selection of control channels (8) and the distribution of actual control signals (2 axis proportional or quadrant)

Quadrant signals (Q) act the same as switch closures. They occur as the controller produces signals above a specific amplitude along both the x and y axes.



x/y control axes showing display activity (○) followed by quadrant switch Q.

An additional signal (0) occurs before signal Q. '0' is used to announce to the operator that he is about to activate an output device.

The main functions of MCB are:

- 1.) Selection of various control channels.
- 2.) Proportional two axis control signal processing.
- 3.) Signal level and quadrant detection suitable for on/off control applications.
- 4.) Display driver functions.

Auxillary functions (utilization optional) are:

- 1.) Circuitry suitable for detection of some operator/operational malfunctions and effecting appropriate changes in the state of the system.
- 2.) Electronics for activation of brakes when wheelchair function is not in use.
- 3.) Timing signal to permit special sequencing and processing needed by some more exotic controllers.

### Display 6

Fig. 3- Display Pictures (negative)

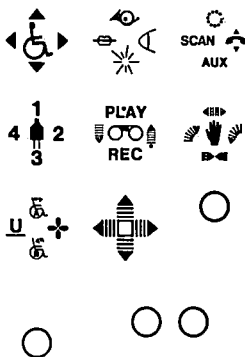

The display module is a rear projection unit which projects 12 different pictures on a ground glass screen. Since the manner in which a device is operated is somewhat apparent by the context of the picture, it helps speed the transfer of information to the operator. Only the picture representing the channel in use is displayed, thus eliminating the confusion of having many pictures in view simultaneously. The intended representations are (left to right) wheelchair; utility 1-horn, headlight, flasher, and retractible mouth stick; remote control-dial phone, phone on/off, auxillary & scan (environmental control package control); uncommitted channel- 1,2,3,4; tape recorder; two axis splint; utility 2 - power raise/recline, fan, tape underline; and uncommitted channel. One of the four circles is projected to show that a function is being activated.

Fig. 4- Tape recorder selection projected on display screen. Circle shows that 'fast backward' function has been activated.



Pictures have been selected to represent function which are either commonly used by quadriplegics or should prove to be useful at some time in the future. Since the generation of artwork is expensive, the representations were chosen so that there could be some flexibility in assignment of correspondences between the pictures and the actual assistive functions. Graphics for each channel were chosen to be distinctive from all other channels to help avoid confusion in the event of channel's being used to control devices different from those pictured.

The display module shown in Fig. 2 has the disadvantage of occupying some useful lapboard area. A new display module is being developed to eliminate this and other problems.

### Controller and Selector Switch

The operations of selection and actual control must not interfere with each other. The selector switch is chosen to meet the capabilities of the individual. Some techniques which can be used for the selection function are: head switch, myoelectric source, chin activation, eye switch, puff, sip, shrug, etc.

Ideally the controller should provide continuous, two-axis, proportion control. Some of the devices which fall into this category are joystick, shoulder transducer,<sup>5</sup> proportional chin controller, and any other arrangement where the operator can originate two signals which he is able to vary continuously. One implementation that has been built for a polio quadriplegic used left/right movement of his middle finger on one hand (x axis) and flexion/extension of his thumb (y axis) on the other hand. (Raising and lowering his palm was used for selection).

Another general approach to providing a controller is to use two axis on/off signals. In this case the on/off signal is then integrated to provide a signal which increases or decreases smoothly with time. The conventional chin switch controller is an example of this kind of a device. Since the smoothing (and variability) is produced by operating in the time domain, the operator is denied the possibility of having a fast responding system. In many cases, however, this has proven to be an entirely satisfactory approach.

Fig. 5- Chin Switch Controller-on/off x/y axis device. Selector is activated by pushing inward.

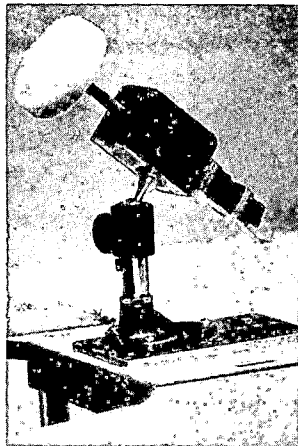

A third approach is to control by using encoded selection of quadrant or mid-quadrant activity. This method also requires integration with its accompanying reduction of response, but is also quite workable and in some cases will represent a near optimal solution. It is a technique which should lend itself well to using puff/sip sequences for control of a powered wheelchair.

Some controllers (shoulder position transducer for example) may be affixed to the operator; and since determination of a reference position is arbitrary and dependent on his situation, a means of automatically nulling the control signals is necessary. The MCB provides signals that initiate this function before a particular channel is enabled, and an automatic null printed circuit board is available for accomplishing the operation.<sup>5</sup>

## Output Functions

Wheelchair- Control of the two motors which drive the wheels of the chair is accomplished by the Powered Wheelchair Control modules (PWC-A and PWC-B). The "A" module performs axis transformation,<sup>5</sup> has velocity and turn rate sensitivity adjustments, provides the drive signals for driving the power outputs and reversing relays, and senses low battery conditions (this causes the display to flash). PWC-B handles the power which is applied to the motors. Drive is controlled by duty cycle switching which insures efficient use of battery power.

Utility 1- This channel provides control over audio alarms (horn & siren), a headlight, flashing light, and a retractable mouthstick holder. Presently the mechanism for the mouthstick holder has not been implemented.

Remote Control function is presently constructed using an ultrasonic transmitter whose output is modulated at an audio frequency. The module has the capability of transmitting 8 different signals, four of these channels are utilized presently. The receiver, which detects 4 different signals, is shown in use in figures 7 and 8. It is wired to be used in place of Prentke Romich Co. switches for the control of their many devices.

Tape Recorder- This function has been designed to approximate the performance required for note taking. The basic tape functions of record, playback, fast forward, and fast backward are available. In addition the operator may change the channel he is using by shifting rapidly between fast forward and fast backward. Since there are four tape channels available, he will be able to record for 4 hours on a C-120 cassette. This can be done without handling the cassette. On channel 7, he may introduce sub audio marks on the tape by activating the underline (U) function. During normal playback these underlines are inaudible. By pulsing rapidly the "play" quadrant, the deck will operate in playback at approximately 10 times normal speed. In this mode the recording is unintelligible but underlines sound as pulsed tones. By hitting fast backward and then activating 'playback', he will be able to hear the underlined recording. 'Fast playback' mode allows the operator to scan 4 hours of recording for annotations in about 25 minutes.

Splint- Control of a powered splint is available through the system. Generally the utility of a splint involves face oriented moves and therefore some controller configurations will interfere with its function. One or two axis, proportional or on/off devices can be controlled. The y axis was intended

to control pinch (open & close), while the x axis might be used to control either elbow flexion/extension or forearm supination/pronation. By utilizing sequential activation on this channel it would be possible to achieve 3-axis control which may be necessary for very high level quadriplegics.

Utility 2- Power recline and raise of the wheelchair back can be controlled on this channel. Operation of a small personal fan is also available here. The 'underline' (U) function is used with the tape recorder.

The fourth and eighth channels are uncommitted. This means that they may be utilized to provide special functions consistent with individual requirements. Actually most other channels are just as uncommitted except that the picture which appears on the display is in varying degrees specific to a particular function. When essential the order of the display graphics can be varied.

### Discussion

The wheelchair system has been designed to make use of functions located offboard. Through the remote control link we have been operating various Prentke Romich Co. devices. The environmental control unit (ECU-2) and the automatic dialing telephone (ADT-5) are two devices which provide a great deal of utility. It is possible to operate the ADT-5 through the ECU-2 and only use one or two channels of the 4-channel ultrasonic receiver. However, since there is so much remote control capability available, the use of independent dedicated channels is easy to visualize and provides a very fast responding system.

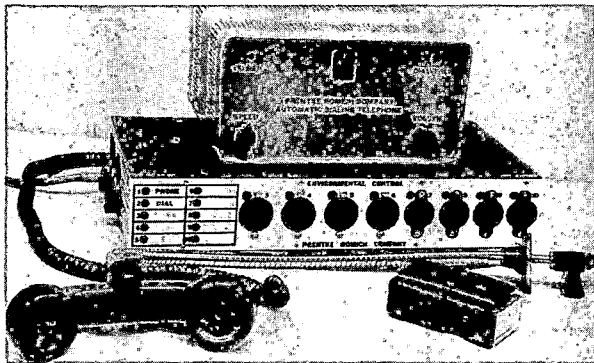

Fig. 6- Prentke Romich Co. Environmental Control Unit and Automatic Dialing Telephone.

Attending college requires considerable reading, and thus the use of either a page turner or microfilm reader is useful. The microfilm reader has the advantage of holding up to about 2000 pages on a single 35 m.m. roll, so that a great deal of study can be accomplished without the need for an attendant. The film can be moved both forward and back-

ward at speeds from very slow to quite fast.<sup>2</sup>

Our effort has been directed primarily toward handling the control aspect of the assistive device problem for quadriplegics. Our intention is to take advantage of existing devices, techniques, and mechanisms to achieve a practical system. There are some areas where appropriate work does seem to have been done. Those we consider essential to our effort we have begun work on. With the aid of G.H. Frost, industrial designer, Kent State University, we are doing work on lapboard design, display console, and a retractable mouthstick holder. A mouthstick can serve enormous utility, but if it is located available for use, it is also in the way at other times. Control of this function is contained in the utility-1 module.

The DU-IT control system is available from Romich, Beery & Bayer, Inc. A line of different types of controllers is being developed, and the repertoire of output functions is being increased.

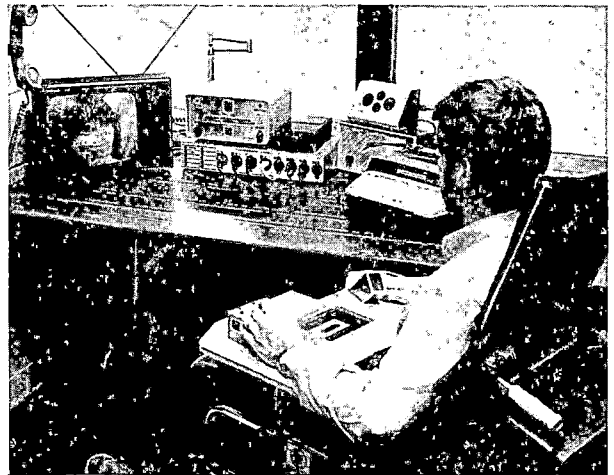

Fig. 7- DU-IT system operating environmental control unit, telephone dialer, TV, intercom and lamp through remote control link.

### References

1. Pfrommer, M. Synergism in Rehabilitation Engineering. Devices and System for the disabled. pgs. 2-5, 1975.
- 2,3. Prentke Romich Co. & Romich, Beery & Bayer, Inc. Brochures, 1976.
4. Veterans Administration, Circular 10-76-24, Environmental Control Systems for Veteran Beneficiaries, 1976.
5. Mortimer, J.T. Final Report Development of Orthotic Systems for the Quadriplegic Patient. pgs 111-145, 1973.
6. G. H. Frost, Personal communications and efforts, Much thanks, 1975-76.

## SPOON LIFTER SELF-FEEDING DEVICE

by

William H. Morewood  
Winsford Products, Inc.  
18 Laning Ave.  
Pennington, NJ 08534

The spoon lifter enables a person to feed himself without the use of his hands. An electrically powered arm moves a spoon between the plate and the mouth level. Food is pushed onto the spoon with a headband supported scoop. This scoop is then used to start a motor which swings the spoon up to the mouth level and stops. When the switch is again actuated, the spoon returns to the plate.

### Introduction

Many handicapped people are able to use a headband and wand to operate an electric typewriter. This spoon lifter utilizes that capability and enables the user to select the food he wants to eat, push it into the spoon, and control the motion of the spoon.

### Method of Operation

The first picture, Fig. 1, shows the complete assembly. The device is quite small, may be placed on a dining room table, and uses a conventional plate and spoon.

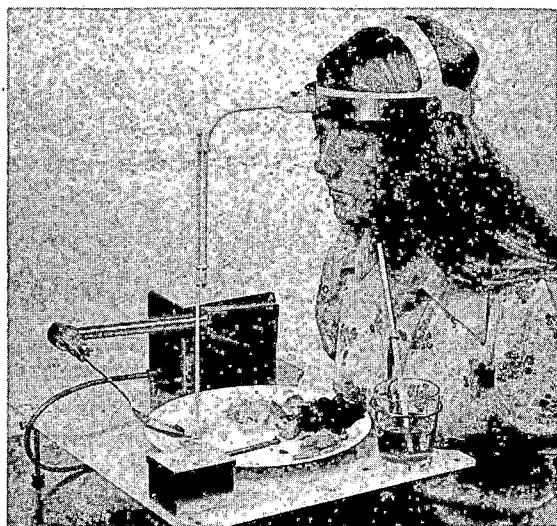

Fig. 1

The headband supports a telescoping, stainless steel, scoop assembly. In this picture, the girl is using it to push food onto the spoon. The spoon is held at an angle, as shown, so that the tip of its bowl will be close to the plate.



Fig. 2

Here, Fig. 2, the scoop is being used to push the switch rod sideways. A small electric motor then moves the lifting arm to the vertical position and stops. As the lifting arm moves upward, the mechanism swings the spoon up to a more nearly horizontal position, as shown in Fig. 3.

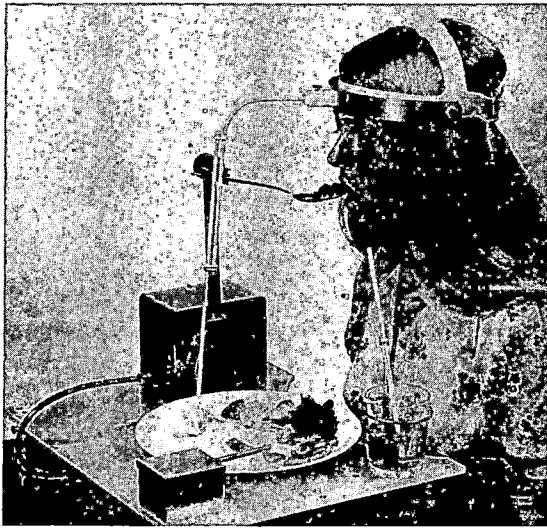

Fig. 3

When the start switch is again pushed to the left, the motor returns the lifter arm to its horizontal position and stops with the spoon adjacent to the plate ready for refilling.

The person using the device is able to eat at his own pace and to select the sequence in which he eats the various items on the plate.

With practice, a person will be able to reload the spoon while chewing the previous mouthful and, thereby, feed himself at approximately the same speed as someone who is not handicapped.

#### Height Adjustment

When at its upper position, the spoon must be at the level of the user's mouth.

Since the spoon lifter always lifts the spoon the same distance above the plate, the whole device must be raised or lowered, as necessary, to position the spoon at the correct mouth level.

This is accomplished by adjusting the height of the legs supporting the spoon lifter.

The minimum height from the bottom of the legs to the upper position of the spoon is 12" for the present design. In cases where a shorter height is required, modifications would have to be made to the mechanism.

#### Scoop Designs

The telescoping scoop assembly is shown in Fig. 4. The two sides of the scoop blade form a right angle with each other to enable the blade to push food in any direction.



Fig. 4

The telescoping design permits the user to move the scoop toward and away from himself by merely tilting his head up and down as shown in Fig. 5.

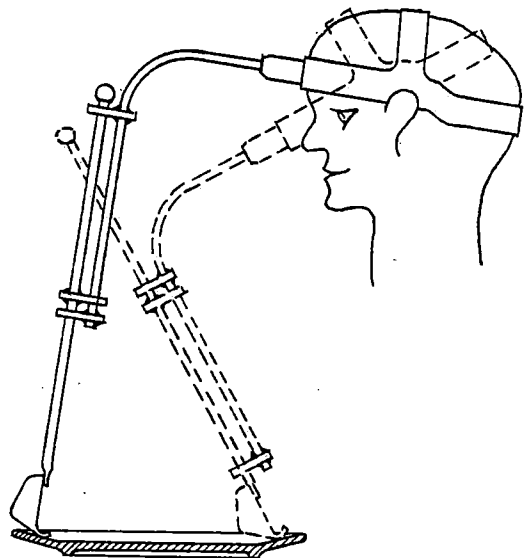

Fig. 5

It will be seen that, with the head raised, the assembly is fully extended, thus permitting the scoop to slide to the far side of the plate. When the head is tilted downward, the sliding joint allows the assembly to compress to its minimum length as the scoop approaches the near side of the plate. A total vertical head motion of about  $30^\circ$  is needed.

The right and left sides of the plate may be reached either by tilting the head sideways or by turning it approximately  $15^\circ$  to the right or to the left.

The telescoping design requires very little motion of the shoulders. It is suitable for anyone able to control the motion of his head and neck smoothly and accurately.

In some cases, where the user is unable to smoothly control the motion of his head, a rigid, non-telescoping scoop assembly may be found easier to use. This type does, however, require more effort than the telescoping type as it necessitates moving the shoulders back and forth to reach the front and back of the plate.

#### Drinking Glass

Figure 6 shows the location of the drinking glass and straw.

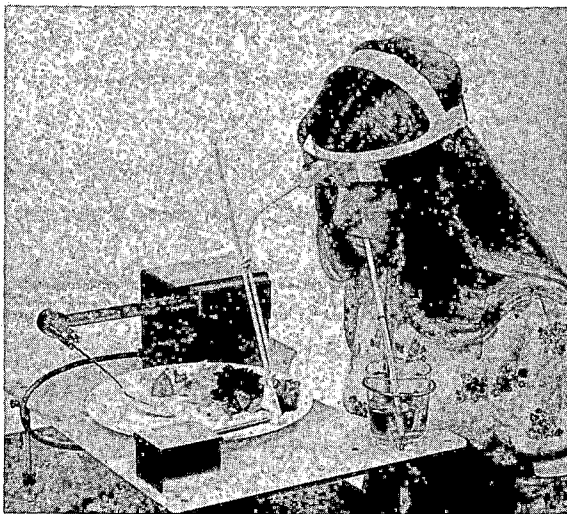

Fig. 6

The top of the straw must be so positioned that the user's mouth can reach it only when his head is tilted all the way down, with the scoop

assembly compressed solid on the front of the plate.

This is to ensure that the top of the straw will always be a safe distance below the lowest possible eye level.

Since the end of the straw must be located within reach of the mouth, it does, to some extent, get in the way when a person is eating. It is, therefore, suggested that the glass holder not be used until the person using the feeder has become confident that he can feed himself.

#### Use of the Scoop

Figure 7 is a view looking directly down on the spoon lifter showing the location of the various parts.

Food should be placed on the front left part of the plate. It is best to use only a small amount of food until the person using the spoon lifter gains experience in maneuvering the scoop.

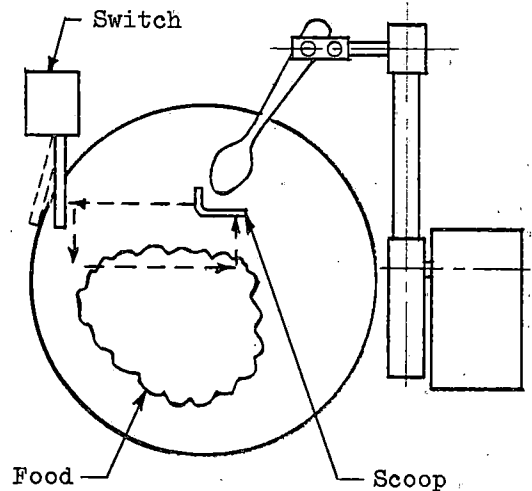

Fig. 7

The area to which the spoon descends must be kept clear of food so that the spoon can go all the way down to the plate. It will be necessary to use the scoop to clear this area from time to time.

Most common foods can be eaten with the spoon lifter although some, such as meat, French fries, or salad must be pre-cut into small enough pieces

to fit into the bowl of the spoon.

#### General

This device operates on the regular, 115 volt, 60 cycle house current and has a three conductor cord with a standard, three prong, grounding plug.

#### Conclusion

The spoon lifter enables those, with good control of their head motion, to feed themselves without the use of their arms. Some people with rather poor head control have, also, been able to use the device but not as easily.

The design of the unit permits quick removal of the scoop, plate, spoon, and switch rod for washing in a dishwasher. Since the exterior surfaces of the unit are either stainless steel or plastic, spilled food may be easily removed.

The spoon lifter gives a person the means to feed himself at his own speed and to decide for himself which item to eat first.

INTERIM REPORT: EVALUATION OF VARIOUS ELECTRONIC DEVICES TO INCREASE  
MOBILITY AND INDEPENDENCE OF VERY HIGH LEVEL QUADRIPLEGIC PATIENTS

Muriel Zimmerman, M. A., O. T. R.  
Carol Stratford, B. S., O. T. R.

**Summary:** A brief condensation of material given in the preliminary report on the project of Evaluation of Electronic Devices for the High Level Quadriplegic Patient at the American Congress of Physical Medicine, Atlanta, November, 1975, is followed by current research since that time. It deals mainly with findings relating to use of breath as an interface for various electronic equipment. Other related factors are also discussed.

Early developments in the field of electronic aids for the physically disabled, started at least as early as 1953, probably before, and there has been a rapid surge in this area during the seventies. In 1971 the Institute of Rehabilitation Medicine obtained its first four models of the POSSUM (originally developed starting in 1960). Three of these units were typewriter controls and one for control of environmental equipment.

In 1972 we became interested in and obtained a single tube breath operated control for a power driven wheelchair, to which we have since made several modifications.

In the spring of 1974 we began an intensive program of investigation and testing both within and outside our own institution, and in October we initiated research on a formal basis. Our goal was to concentrate on assessing those electronic devices which might be most suitable to the high level spinal cord injured, and in the process, to try to identify fundamental requirements for operations, acceptance and usefulness, in order to maximize usage and to offer more insights for future improvements and developments.

In November 1975, a first report on this project was presented at the 52nd annual session of the American Congress of Physical Medicine and Rehabilitation in Atlanta, Georgia.<sup>1</sup> The information covered five environmental control systems: (the POSSUM, PSU-1, the Nu-Life, the Fidelity Comfort & Communication System (FCCS), the Paratrol MK II, and the Robot); two typewriter systems, both by POSSUM; and three wheelchair controls, a 1-tube, 2-tube and 4-tube systems.

This equipment is well known and has been described in many articles and books. I would like therefore to mention only the new items included in our continued testing which have been acquired since November, 1975. They are the Prentke Romich Environmental Control Units ECU-1 (illustration No. 1) and ECU-2, and the DRS-7013 systems. This last item is not marketed and is in the beginning stages of testing. The Swedish PMV Typewriter System has just been received but is not yet tested. (A new 2-tube Breath Control for the electric wheel-

chair has been completed by IRM and is being reported on by Mr. Youdin tomorrow.) Two motorized reclining backs for the power driven chair are being readied for use.



The patient population used for testing has increased from 25 to 38. Other parameters of age, lesion levels, etc. remain much the same.

Previous testing results compared types of interfaces and modes of operation (mostly the latter), checking such factors as scanning a panel, intermittent or sustained inputs for activation, speed, length of time to learn operation and also length of time in use, levels of breath pressure, etc.

All units were rated according to findings based on patient operation, equipment set-up, and mechanical performance. Of the "Comfort" systems, Fidelity was the most popular. Since then, the ECU-1 and 2 by Prentke Romich have advanced to a very favored position. Operation by the patient is not any easier or better, but equipment reliability has been much greater, thus switching interest to these units.

Of the wheelchair systems, the one-tube continues to be successful and most favored by all. This equipment has undergone streamlining in instrument design and packaging, making it superior to previous models.

Briefly mentioned were findings regarding use of various interfaces, breath controls in particular.

At this time I should like to concentrate my remarks to additional data in this area.

Firstly, it was mentioned that sipping appeared easier than puffing. This remains the same. In the book on Aids for the Severely Handicapped, edited by Keith Copeland, Reginald Maling,<sup>2</sup> in his report on POSSUM, states that the "average" mouth produces a pressure of 60 mm of mercury and a suction of 120 mm of mercury (for isometric or no flow condition). He also stated that a volume change of  $\pm 1$  millilitre accompanied the desired pressure change--about 0.1 percent of the tidal volume. It was therefore deduced that the use of breath pressure to operate switches was suitable for a severely disabled patient, or at least that appears to be the deduction. But no maximum amount of suitable pressure, negative or positive, was ever given. Nor was the use of sustained pressure qualified. He does mention that 10 cycles in 60 seconds is possible. Also, to date, there have been no studies made comparing pressure volumes of high-level quads versus the normal population.

As a result of difficulties experienced by some of our patients, we set up a breath meter to test various factors. (Illustration No. 2)

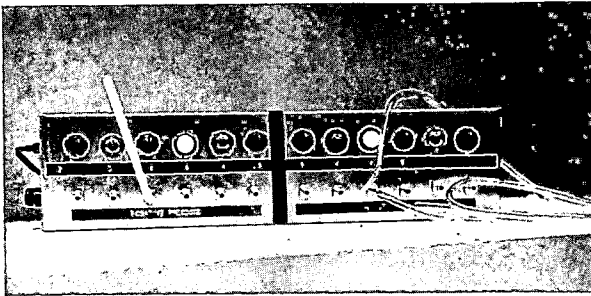

The present findings, from testing of switches ranging from 3 mm to 12 mm, show consistently that puffing and sipping amounts of pressure did reach comfort levels, both in intermittent and in sustained pressures. Sipping levels of comfort and ease were higher than puffing. Above 8 mm on positive pressure, that is, puffing, was difficult. For negative pressure, or sipping, the difficulty was experienced from 8 to 12 mm. On sustained positive and negative pressures, the difference was even more pronounced. Negative pressure could be maintained much longer than positive--the highest timing on 8 mm was 8.89 sec. for positive and 19.0 sec. for negative.

Continued use of the breath operated 1-tube wheelchair control, which necessitates ability to achieve different levels of pressure in the same tube, began to show a consistent pattern of difficulty. The pressure levels, for both negative and positive inputs, had been set at 3 mm to 8 mm. There were seldom problems in correctly managing distinction

between positive levels of pressure, but with sipping (negative pressure) the 8 mm signal was frequently obtained when only the 3 mm was desired, which put the chair in reverse instead of left turn.

Thus, on the breath meter, we next connected the #3 mm switch and each higher one (4, 6, 8, 10, 12) in succession together, testing how frequently one could obtain only the desired level with accuracy. We found that with the positive pressure levels this could be managed with a difference of 3 mm to 6 mm (occasional, but minimal, errors upon continuous puffing). With negative pressure, it required a span of 3 mm to 10 mm to keep errors to a minimum, especially, again, during sustained sipping.

Following this testing, we adjusted the pressure levels according to the tested desirability on our wheelchair control. The problem of unintentional signals (or inputs) has been considerably reduced. There has even been a definite increase in the prior good acceptance of the 1-tube system. It makes higher speeds more readily and satisfactorily achievable at a faster rate.

Our next testing involved the timing of sustained negative and positive breath pressure which is necessary to turn a wheelchair one complete revolution (with chair fully charged and batteries fully energized). In the lowest speed it required 8 to 10 seconds. In the highest speed only 2.5 to 3 seconds. This appears to be within the possibility of most quads, especially if they learn to maintain the mouth pressure during normal breathing. This is much easier with negative pressure (sipping) than positive pressure (puffing).

Although pressure switches as low as .05 mm are available, it appears undesirable to use less than 3 mm. Smaller amounts of pressure are too prone to cause accidental activation, especially when the person cannot move toward or away from the interface. For environmental controls perhaps it could be lower.

Testing to determine those microswitches best suited to the high level quadriplegic is still to be engaged in, such as finding minimal and maximal amounts of force and travel. However, from observation of current usage of these interfaces, it would appear that positioning and stability of the interface may be more important than the other factors. Holding and attaching mechanisms are not well designed. Clamps, especially, are not adequate for adapting to different beds, tables, etc. (The model shown in the next slide has proven better than most.) Movable parts, to provide proper positioning, are still somewhat of a problem. Unless they are quick and easy to adjust and require no tools, they will be discarded.

Electronic controls are also forcing additional criteria for the peripherals they operate. At present, institutional TV's are the only ones which can offer channel changing. Page turners still leave much to be desired and positioning of such equipment,

especially for the person in bed, is a problem. Battery operated equipment cannot be controlled by most systems, therefore most inexpensive radios and tape recorders are not suitable.

As the power driven wheelchair becomes used at an ever increasing rate, the present endeavors to make the wheelchair more suitable become even more urgent. Too often changes are concerned with cosmetics rather than with function and practicality. Improved performance should be the primary reason for making a change, but if that can be combined with enhancement of appearance, so much the better. One recent endeavor worthy of note is the modified Postura back on the new E & J four-post design. It offers good support, but permits freedom of arm movements and less restriction of vision. It uses the modular approach and thereby gives flexibility through quick and easy interchange of parts for varying individual needs.

Other problems of interchangeability, safety, operational criteria for interfaces, etc. will undoubtedly continue to arise. These will be our future challenges.

#### References:

<sup>1</sup>Zimmerman, Muriel E. Preliminary Report: Evaluation of Various Electronic Devices to Increase Independence of the Very High Level Quadriplegic Patient. Am. Congress of Rehabilitation Medicine, 52nd annual session, Atlanta, Georgia, Nov. 18, 1975 (unpublished).

<sup>2</sup>Copeland, Keith. Aids for the Severely Handicapped, Sector Publishing Limited, 70 Chiswick High Road, London W4, England.

This work was supported by RSA Grant #16-P-56801/2-15, "Rehabilitation Research and Training Center" RT-1 from the Rehabilitation Services Administration, Department of Health, Education, and Welfare, Washington, D. C.

A POWERED CONTROL FOR THE OPERATION OF A  
CASSETTE TAPE RECORDER WITH A MOUTH-STICK

by

Joseph French  
Arthur A. Siebens, M.D.  
and  
Frances Silverstein, OTR  
The Johns Hopkins University and  
The Good Samaritan Hospital  
Baltimore, Maryland

Summary - A device has been designed and built that enables a quadriplegic patient with a high lesion to operate a common five key cassette tape recorder using a mouth-stick. It is not an integral part of the recorder but rather a detachable interfacing device between the patient and the recorder. An important feature is that only one key must be pressed in order to record.

In the course of preparing a teenager with a high cervical lesion for return to school activity, the necessity for the patient to independently operate a tape recorder was soon realized. Because the patient was monitoring classes by telephone, a tape recorder was needed to both record the teacher's comments in class as well as the assignments. The patient could not use his hands or arms for operation of the recorder. In the meantime, however, he was becoming very proficient in the use of a mouth-stick in such activities as typing and reading. With this in mind, a study was made of the feasibility of modifying a common five-key cassette tape recorder in such a way that it could be operated with a mouth-stick.

There are two major difficulties which preclude unassisted operation of this type of recorder. Firstly, the "record" and "play" keys must be pressed simultaneously in order to record. Although this safety feature avoids accidental erasure or recording, the action required is impossible to accomplish using the tip of a mouth-stick. This problem can be solved by mechanically coupling the two keys. However, this solution would not eliminate a second problem, namely, the high force required to push any of the keys.

The reason for the high force requirement is that some keys govern several functions. When one presses the "play" key, one actually switches on both the amplifier and the motor which drives the mechanism, engages the tape drive, brings the tape in contact with the record-play back head, etc. When one presses the "record" key, one in addition switches the recorder amplifier from "play" to

"record" and brings the erase head into contact with the tape. Of course, once a key is in position it latches in, requiring no further effort. The problem, then, is to apply enough force sufficiently long to engage these keys for the several functions they control.

The other keys are essentially release keys. For example, if the "fast forward" key is pressed when the recorder is in the "play" mode, the latch which holds the mechanism in position is released, returning the mechanism to a neutral position. It then positions the motor to directly drive the take-up reel. This requires considerably less force, but can still be difficult using a mouth-stick.

Several recorders were examined before selecting one which seemed to have a relatively light touch. It had the additional advantage that it could be operated without batteries directly from the AC line and did not require the use of a separate battery eliminator.

As it turned out, the only key that the patient could easily operate was the "stop" key. Although we considered attaching long levers to the other keys, this possibility was quickly rejected for the following reason: If, for example, it were necessary to increase the applied force only four times and the key travel were three-eighths of an inch, the travel at the end of the lever would be one and one half inches. It was reasoned that the mouth-stick could not be easily kept at the end of the lever for such an excursion.

Upon examination of the tape recorder mechanism, it became clear that

some sort of additional mechanical power source under the control of the patient would be necessary in order to assure dependable and easy operation of the recorder. The idea of implementing the basic principal of the older model IBM electric typewriter showed great promise. In this typewriter, a motor-driven, continuously rotating roller supplies the power for the type to strike the paper. The low force key pressed by the operator merely brings the type driving mechanism into contact with the roller. The roller drives the mechanism forward, thereby causing the type to hit the paper with a force totally independent of the force exerted on the key. The Wollensak Company used this general principal in their "electronic keyboard" model T1600 17 years ago. Being a reel-to-reel recorder, the motor ran continuously when the power was on whether or not the recorder mechanism was in actual operation, allowing use of the motor as a power source for the light-touch keyboard. Unfortunately, the modern cassette tape recorder is designed in such a way that the motor operates only when the recorder is performing one of its functions. This, plus the general design of the recorder, makes it impractical to attempt to harness its motor. Therefore, an alternate power source is required. We elected to use a solenoid.

Rather than attempting to modify the tape recorder, we have built an interfacing device between the patient and the tape recorder, thereby avoiding damage to the recorder mechanism which could occur during the process of modification. This approach also allows easy removal of the tape recorder from the control device if normal operation is desired or repair of one of the devices is necessary. Indeed, the entire recorder could be replaced by another of the same model.

The original design goals were as follows: Only four keys would be powered. The "stop" key would be operated directly by the mouth-stick. One solenoid would be used to selectively power all four keys. Each of the keys on the control device would be directly in line with their counterpart on the tape recorder. The control device would be easily attachable to, and detachable from, the recorder.

Since the design of the control device was an evolutionary process, it is felt that the best manner in which to describe the operation of the device is to describe the operation of the individual components as they evolved from the basic concept to the completed device. The power unit and basic key driver are shown in Figure 1 in a highly simplified form. The solenoid is a Guardian #14AC continuous duty type with an initial pull of 63 ounces at a one and one-fourth inch stroke and a holding force of 17 pounds. Attached to its plunger is a stainless steel plate "C" the width of which spans the width of four keys ("record," "rewind," "fast forward," and "play"). The end is bent to form a wide hook. The plate is rigidly attached to two cylindrical bearings which ride on stabilizing rods. The rods provide both lateral and vertical stability for the plate. The springs on the rods return the plate to the resting position shown after power is removed from the solenoid. The spring which couples the plunger of the solenoid to the plate is needed in order to absorb mechanical shock caused by the sudden closing of the solenoid. This shock, if transmitted to the keys over a period of time, could cause damage to the keys and/or the recorder mechanism itself.

The basic key driver is made up of

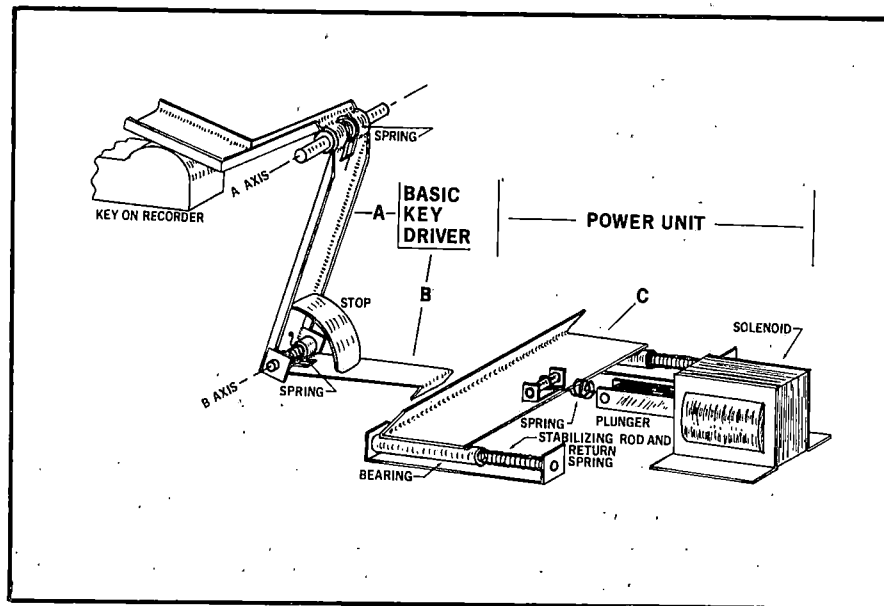

Figure 1. The power unit and basic key driver

two parts. Part "A" which rotates on fixed axis A is the part that actually presses the key on the recorder. It is shaped to insure the most efficient delivery of power from the solenoid to the key on the recorder while requiring a minimum of space in the control device. When power is removed from the key driver, a spring in the A axis (indicated) returns it to the position shown and a stop (not indicated) prevents further travel. Part "B" rotates on axis B to enable its hooked end to engage the hook on "C." A spring at axis B forces part "B" up and away from the hook on "C."

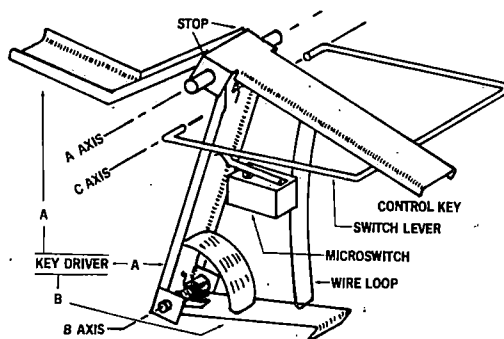

Figure 3. Control key and key driver combination.

in this axis (shown in Figure 1) keeps the control key from dropping and also determines the force which must be applied to the control key. The end of the channel on the key driver acts as a stop which keeps the control key at the proper angle. A rectangular loop of thin spring wire is fastened approximately one-third the distance between the A axis and the end of the key. The loop extends down from the key and comes just short of touching part "B" of the key driver. A "Micro Switch" for controlling the solenoid and a switch lever were also added. The lever was fashioned from a stiff stainless steel rod. It rotates on fixed axis C and spans four keys ("record," "rewind," "fast forward," and "play"). Pressing any one of these keys actuates the switch. The "Micro Switch" is rigidly mounted to the frame of the device.

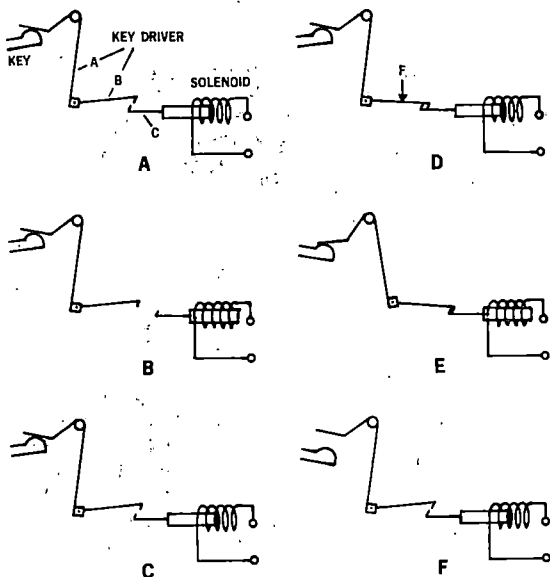

Figure 2. The operation of the key driver.

Figure 2, A thru F shows schematically the operation of the driver in its most basic form. (A) shows "C" in its unpowered position. (B) shows what would happen if for some reason power was applied to the solenoid with "B" in the up or resting position, "C" would completely miss "B" and, therefore, no action of the key driver could take place. (C) shows "C" once again in its unpowered position. (D) shows how force "F" on "B" causes the hooked end of "B" to come in line with the hooked end of "C." (E) shows the operation of the mechanism when the solenoid is powered. "C" pulls "B" causing "A" to rotate thereby pressing the associated key on the tape recorder. (F) shows the return to the unpowered state leaving the key on the recorder in the depressed position.

This first step worked well, but there remained the problem of how to enable the individual using a mouth-stick to apply force on "B" and at the same time apply power to the solenoid. As shown in Figure 3, a control key which also rotates on the A axis was added to the system. A spring which is located

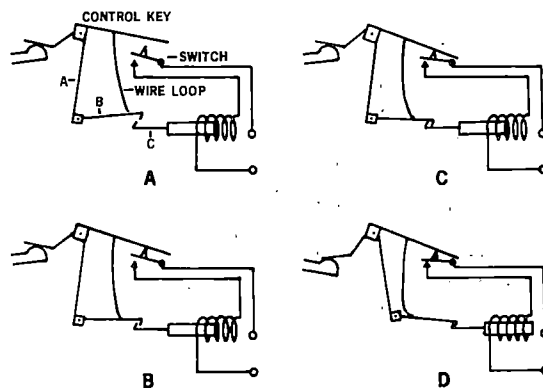

Figure 4. The operation of control key and key driver.

Figure 4, A thru D shows schematically the action of one control key and key driver combination. (A) No force is applied to the control key, therefore, the wire loop is not touching part "B" of the key driver. (B) Enough force is being applied to the control key to cause it to rotate thereby causing the wire loop to push "B" into position for engagement with "C." When the control key is in this position, it is just barely in contact with the switch lever. The switch is still open. (C) Additional

force on the control key jams "B" against "C" and therefore "B" can rotate no further. The switch is still not closed, therefore additional rotation of the control key is necessary. Since "B" can not move, the additional force needed to rotate the control key must be absorbed by the bending of the wire loop. (D) The extreme bending at the tip of the loop can be seen at the instant the switch is closed causing the solenoid to actuate the key driver.

If a rigid rod were used, the control key could not be pushed beyond the point where "B" is blocked by "C." If this were the case, the switch would have to be positioned in such a way that it would close when "B" is exactly positioned with "C." Otherwise, the switch would close too soon causing "C" to miss "B" or it would not close at all. This would be an extremely difficult adjustment to make and keep.

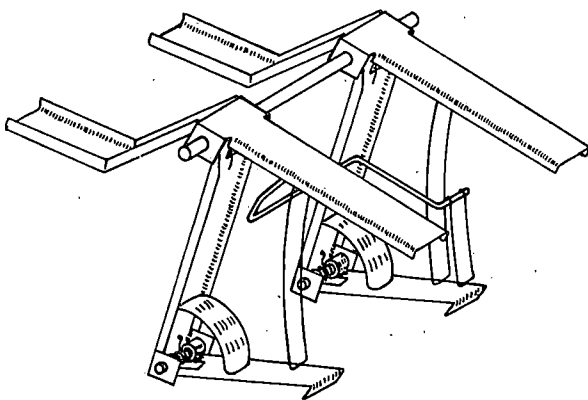

Figure 5. Detail of the record control key mechanism.

The final problem of allowing one control key to cause two keys to be pressed simultaneously on the tape recorder was solved as shown in Figure 5. (The "rewind" and "fast forward" control keys and key drivers along with the switch lever and "Micro Switch" were deleted for clarity). A rigid rod is connected to the "record" control key just behind the wire loop. It is bent so as to go behind the wire loops of the "rewind" and "fast forward" control keys, then come out between the "fast forward" and "play" control key loops and around in front of the wire loop connected to the "play" control key. At this point, a short wire loop is fastened which is just short of touching the "B" section of the "play" driver key. This rod wire loop arrangement has no effect when the "rewind," "fast forward," or "play" control keys are pressed. When the "record" control key is pressed, however, the B sections of both the "record" key and the "play" key drivers are brought into position with C, then the "Micro Switch" is closed causing both the "record" and "play" keys on the recorder to be pressed

simultaneously.

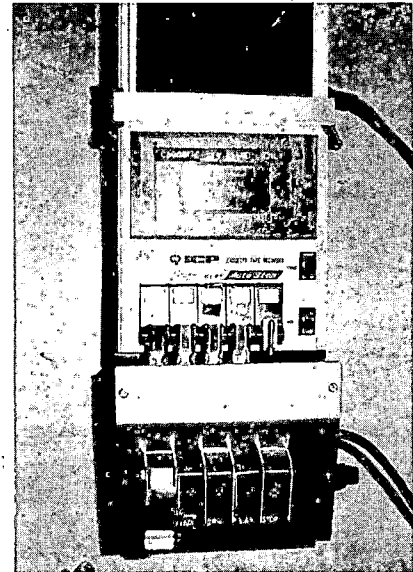

Figure 6. The device attached to the recorder.

Figure 6 shows a photo of the actual control device attached to the recorder. Several features should be noted. First of all, the lever control keys are not visible. The rectangular keys seemare rigidly connected to the levers through one inch long rods which project through holes in the case. The case protects both the operator from the mechanism and the mechanism from the operator. Next it should be noted that each key is located within a short channel. This is necessary to guide the tip of the mouth-stick to the key and also to avoid accidentally hitting two keys at once.

The final feature is a cover over the "record" control key channel. This restores the previously sacrificed safety feature which avoids accidental recording. The lid is hinged and must be lifted by the mouth-stick and held open by the edge of the stick while its tip presses the key. As soon as the stick is removed from the key and the cover, the cover will be closed by gravity. There is then no easy way that the mouth-stick can inadvertently make contact with the "record" control key.

One of the original goals was not to power the "stop" key but rather to operate it directly by the mouth-stick. In the photo, (Figure 6), it appears that the "stop" key is also powered. Actually the key on the panel is directly linked through a lever system to the "stop" key driver. No power assist is present. This was done in order to keep all the keys in line and in the same area. It was felt that ease of operation would be hampered if four keys were in one place while the fifth key was several inches

away in a totally different place.

Except for the solenoid, no major commercially manufactured mechanical parts are used; all were fabricated, for the most part from raw stock.

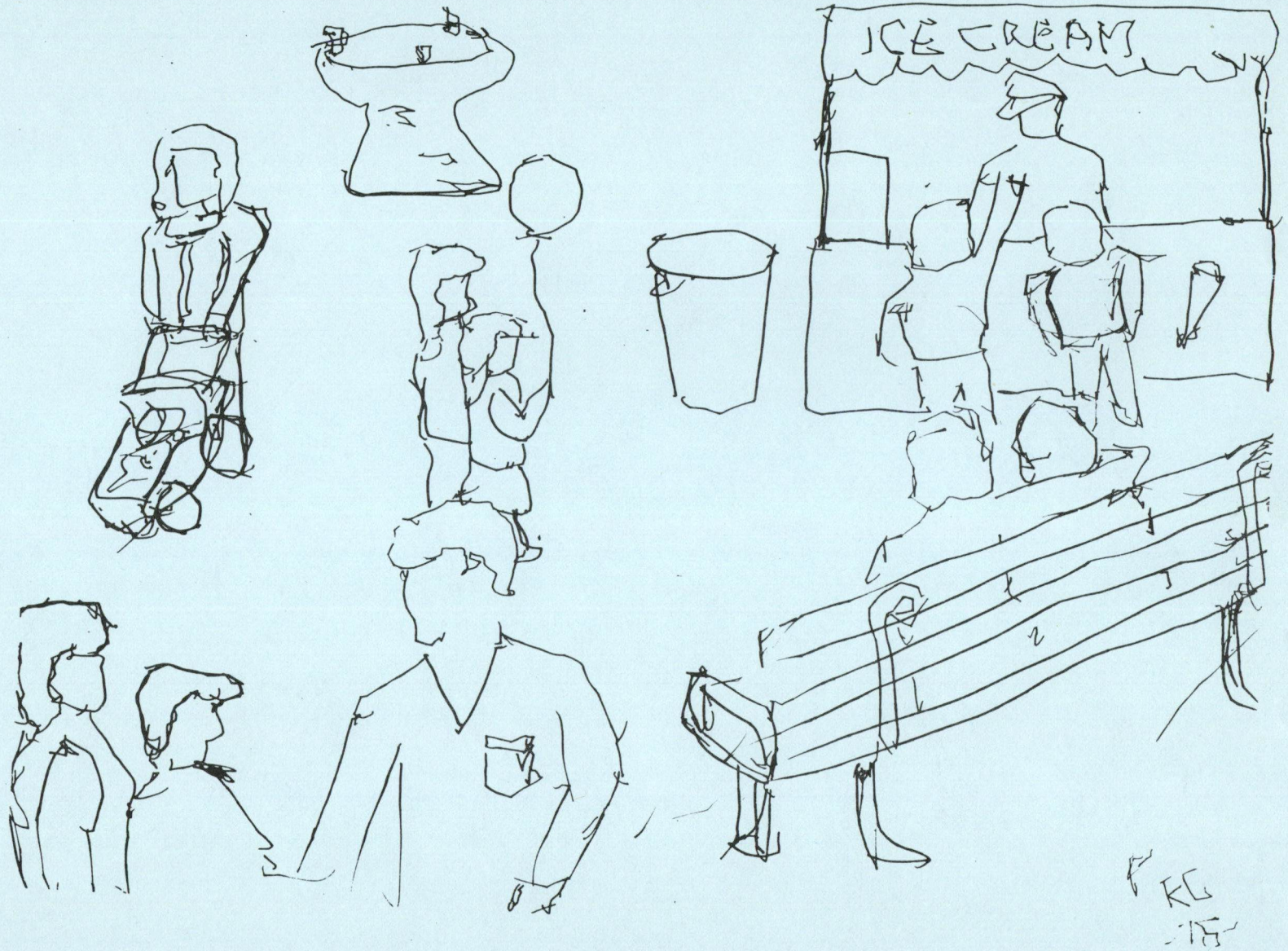

THE THREE BASIC APPROACHES TO COMMUNICATION FOR NON-VOCAL INDIVIDUALS AND THE DEVELOPMENT OF "UNIVERSAL" ADAPTABLE AIDS

Abstract

Communication aids using many different approaches have been developed to provide communication for non-vocal individuals. This paper discusses several techniques which have been successful and describes how they may be categorized into three basic approaches. A partial survey of aids developed internationally using various approaches is included. Two new communication aids are described which can be adapted to utilize the communication technique which is best suited to the individual using the aid.

Introduction

Much emphasis has been placed in recent years on providing alternate channels of communication for severely handicapped individuals who are unable to speak. An alternative to vocal communication is necessary for these individuals to obtain an education and to maintain as independent a lifestyle as possible. This problem has been recognized and addressed by a number of researchers and clinicians throughout the world, resulting in many different approaches to solving the non-vocal communication problem.

The major problem is in finding the most efficient means for the non-vocal individual to communication, i.e., applying a technique which utilizes the individual's physical and mental abilities to their fullest potential. Many of the techniques and devices developed to date have been very successful in solving the problem of non-vocal communication. The problem facing the teacher or the clinician, then, is that of finding the best existing communication technique or aids (device) for a particular individual. The application of state-of-the-art technology to communication aids has resulted in more adaptable aids which will make the task of matching the aid to the individual's abilities much easier.

Three basic approaches

Although a great many successful communication aids have been developed, their control schemes are all variations on three basic approaches. These three approaches are scanning, encoding, and direct selection. Each approach has its advantages and disadvantages, depending on the individual's abilities. It will be seen that one technique may allow greater potential speed of communication than the others, but a slower technique may be applicable to more physically involved individuals. There is thus a trade-off between the potential speed of communication which can be accomplished with a given approach and the amount of physical control required to utilize it.

The scanning approach

In order to categorize existing communication techniques and aids as scanning, encoding, or direct selection, definitions of the three

approaches have been developed by the Trace Center (University of Wisconsin-Madison). The following definition has been adopted for the scanning approach:

Any technique or aid in which the selections are offered to the user by a display and where the user selects the characters by responding to the display. Depending on the device, the user may respond by simply signalling when he sees the correct choice presented or by actively switching the indicator (e.g., light or arrow) toward the desired choice.

An example of a very simple scanning aid would be a rotating pointer aid (see Fig. 1). The individual using the aid simply closes a switch to start the arrow rotating and then closes it again to stop the arrow on his desired selection. This type of scanning is referred to as linear scanning, since the selections are presented in a linear sequence.

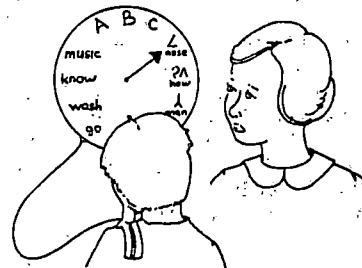

Figure 1. Rotating Pointer Aid

Another scanning technique which offers greater speed is X-Y or row-column scanning (see Fig. 2). Aids using this technique present the selections row by row until the user chooses one row by closing a switch. The selections in that row are then presented one by one until the user signals again to make his selection.

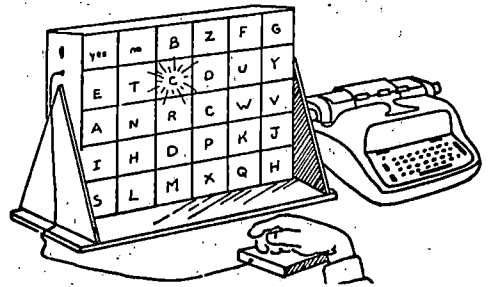

Figure 2. X-Y Scanning Aid

A third scanning technique is directed scanning. With this technique, the individual can direct the indicator (usually a light) on the aid up, down, left, or right to guide it to the desired selection.

The latest innovation in scanning type communication aids is "anticipatory scan" or computer assisted scan. In this technique, the aid

presents selections to the user based upon his previous choices. By looking at the last one or two letters chosen, the aid can present the most probable choices to the individual first, thereby speeding up the scanning process. For example, if the last two letters chosen by the user were "...TH," the aid would present the most probable subsequent choices, the letters "E," "AA," "Space," and "I," and then would present the remaining letters. Studies have shown that using this scheme with standard English text, the user's next choice is one of the first six presented by the aid about 80% of the time (Foulds, 1976, personal communication).

The scanning technique has the great advantage that it can be used by almost anyone, no matter how severely handicapped, since the operator of a scanning aid is required to operate only a single switch. This single switch can be one which is operated by any part of the body which has retained muscular control (eyes, breath, feet, etc.). The disadvantage of scanning is that it is a slow technique, since the operator must wait for the aid to scan through all the unwanted characters before he can make his selection.

#### Brief review of available scanning aids

Scanning aids are the most common type of aid presently available, using many variations of the scanning technique. Linear scanning aids are available from Adaptive Therapeutics Co. (Madison, Conn.), Prentke-Romich Co. (Shreve, Ohio), and Centre Industries (New South Wales, Australia), who offer a scanning device which can control an electronic typewriter. A dual-speed linear scanning aid is marketed by PMV (Stockholm, Sweden) which controls a standard IBM typewriter using a keyboard mounted solenoid unit.

Several row-column type scanning aids have been developed at various centers. The TIC, developed at Tufts University (Boston, Mass.) is a row-column scan aid with a built-in 32 letter display and a strip printer as output forms. Advanced versions of this aid are currently under development. Carba (Bern, Switzerland) offers an aid which can be used with one or two switches and controls a Facit page printer. POSSUM Controls, Ltd. (Aylesbury, England) and Zambette Electronics (Essex, England) produce scanning aids which control adapted typewriters and can be used with various types of switches. The Cybernetics Research Institute (Washington, D.C.) also makes a scanning aid, the Whispertype, which can control a typewriter through a large variety of switches. The Comhandi from Physiomedical Systems (Montreal, Canada) uses a teletype as its output. Prentke-Romich (Shreve, Ohio) offers two portable row-column scanning aids, the Alphabet Message Scanner, and the Strip Printer. The Strip Printer is built into an attache case and has a built-in printer. The Porta-Printer, available from Vendacom (Brooklyn, N.Y.) is also built into an attache case and controls a built-in printer plus two convenience electrical outlets.

Anticipatory, or computer assisted scanning aids, have been under development at the New England Medical Center (Tufts University, Boston, Mass.), and more recently at the Northwestern University Rehabilitation Engineering Center (Chicago, Illinois).

#### The encoding approach

The definition which has been adopted for encoding communication aids is:

Any technique or aid in which the desired characters are indicated by a pattern or a code of input signals, where the character codes must be memorized or referred to on a chart. Any number of switches may be used (e.g., 1, 2, 4, 7, 8, etc.). The code may involve activating the switch(es) sequentially, simultaneously, or in a specific time sequence.

A simple example of an encoding aid is shown in Fig. 3. In this example, a "2" and a "3" would indicate the letter "H," and a "4" and a "4" would indicate "S." A larger number of characters could be encoded by using a code longer than two digits.

	1	2	3	4	5
1	A	B	C	D	E
2	F	G	H	I	J
3	K	L	M	N	O
4	P	Q	R	S	T
5	U	V	W	X	Y

Figure 3. Encoding Chart

The greatest advantage of the encoding approach is that it allows greater potential speed of communication than the scanning technique. The disadvantage of this approach is that it requires either a greater number of switches, or more responses per letter selected, thus requiring a greater degree of motor control from the operator. Also, the coding scheme must be learned by the individual before the aid can be used to communicate.

#### Brief review of available encoding aids

Encoding aids using several different coding schemes have been developed at various centers to operate with from 1 to 14 switches. Centre Industries (Australia) produces an aid which controls a typewriter through a single switch and a two level code. The MC 6400 from Medical (South Burlington, Vt.) also uses a single switch and a Morse Code scheme to control a television monitor output. POSSUM Controls (England) offers a breath controlled unit which utilizes a three level code (sips, pauses, and puffs) to control a typewriter. POSSUM also offers a Word Store option which provides a vocabulary of up to 400 words. An aid which uses a four level code (two degrees of sips and two degrees of puffs) has been developed by Hengrove, Ltd.; (Berkshire, England - marketed by POSSUM Controls). The Electraid, J.W.F. Electraid, (Aylesbury, England) may be used with 1, 2, 4, or 8 switches. The Cybertype, from Cybernetics Research Institute (Washington, D.C.) may be used with either 7 or 14 keys to control a typewriter output.

#### The direct selection approach

The definition for direct selection is:

Any technique or aid in which the desired

output is indicated directly by the user. In direct selection aids there is a key or a sensor for each possible output selection.

An example of a direct selection aid using an expanded typewriter keyboard with recessed keys is shown in Fig. 4.

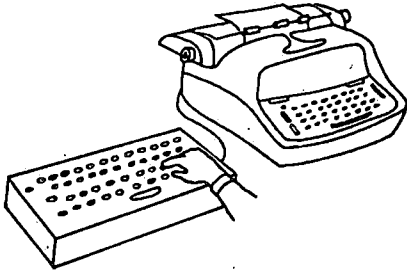

Figure 4. Direct Selection Aid

The greatest advantage of the direct selection approach is its potential for more rapid communication than the other two approaches, since the individual need only make one movement per selection and he can operate the aid at any speed he chooses. This technique is also usually easier for the individual to learn since it is more straightforward. The main disadvantage of direct selection is that the user must have greater dexterity than is required for either scanning or encoding aids.

#### Brief review of available direct selection aids

Direct selection aids have been developed with many different types of input "keyboards." Some of these aids were designed to be operated by portions of the body other than the hands.

MEFA GmbH (Bonn, Germany) makes a special expanded keyboard for use with an individual's feet. Special expanded keyboards for hand, headstick, and foot operation are available from Reva-Aids (Copenhagen, Denmark) and PMV (Sweden). Special hand and arm rests are available from IBM which allow use of the standard IBM Selectric typewriter by handicapped individuals. IBM also offers a large type "ORATOR" type ball for use with the Selectric which provides highly visible output for application with vision-impaired handicapped individuals.

The LOT (Light Operated Typewriter) developed by M. Soede and H.G. Stasses (Netherlands) uses a light pen which may be attached to the individual's head. The MCM communicator from SICO (Oakland, CA) and the TV Phone from TV Phone (Silver Spring, MD) are both keyboard aids developed for the deaf which can be modified for use by the non-vocal individual. Canon, Inc. (Japan), in cooperation with researchers in Holland, has developed the Cannon Communicator, a hand-held keyboard aid which has a built-in subminiature printer.

#### Design of "universal" adaptable aids

What is an adaptable aid?

What is meant here by an "adaptable" communication aid is an aid which can more easily be adapted to the severely handicapped individual through its ability to operate with more than one type of selection technique. The ideal adaptable

aid, of course, would be one which could be used with any of the scanning, encoding, or direct selection techniques. Through the application of present electronic technology it is possible to design an aid which can be used with any variation of the three basic communication approaches.

#### The need for advanced adaptable aids

Major advances in state-of-the-art electronic technology have prompted developers of communication aids to work toward providing portable aids which are more compact and lightweight, have self-contained printers and other output forms, and have word storage to increase communication speed. In order to allow practical application to the non-vocal handicapped population, however, these more advanced aids will have to overcome several basic problems:

- 1) Since these electronic aids are, and will continue to be, quite expensive, selecting the type of aid which is "right" for the individual becomes a financial necessity; a hit-or-miss method would be much too expensive.
- 2) As the individual uses the aid, especially in the case of children, his physical and/or mental abilities may improve to a point where the aid he is using may no longer provide an appropriate means of communication. Thus an expensive communication aid may have to be replaced with another type with a more applicable function as the individual progresses.
- 3) Advanced communication aids are typically low production volume devices, leading to higher costs on the market. If a single design could satisfy the needs of a larger segment of the non-vocal population, higher production volumes could be achieved and costs could be lowered.

What should be adaptable to provide a versatile aid

The basic requirement for a universal aid, of course, is that its selection technique must be easily adaptable to various individuals. As has been noted in the review of present communication aids, there are many variations on the basic scanning, encoding, and direct selection techniques. To provide an aid which can be utilized with these different selection techniques, certain requirements must be met:

1. To employ any variation to the scanning technique, the aid must have a panel of lights to indicate the selections to the user in time sequence. This panel must display the selections in highly visible form to the user.
2. Some variations of encoding also require a panel of lights to display the possible selections (e.g., in a successive quartering display). Other variations do not require this type of display. The use of encoding in most forms does require that the aid have the capability of operating various numbers of switches.
3. Direct selection techniques usually do not require a lighted display, but they do require that the aid be capable of operating

with a large number of switches (e.g., a keyboard) or sensors of some type.

In addition to providing the capability of operating with different selection techniques, there are other basic requirements which a "universal" aid must meet. If the aid is to provide word-at-a-time communication, the vocabulary storage should have sufficient capacity and should be easy to modify for adaptation to each individual. It is also desirable for the user to be able to select phrases and complete sentences, as well as single words.

Since the environments of handicapped individuals are very diverse and may change as the individual advances through an educational or rehabilitative program, an adaptable communication aid should allow utilization in differing environments (e.g., home, classroom, occupational and social settings). To this end the aid should be as portable and compact as possible and should require very little "setup" by another person, this allowing the non-vocal individual to initiate communication wherever he may be.

Finally, the "universal" aid should provide the capability of use with various forms of output, such as printed copy, television display, and some type of self-contained output form. It is also desirable to be able to interface the aid to a computer or telephone communications system.

A realization of the "universal" adaptable aid

A program aimed at the development of adaptable communication aids has been carried out at the Trace Center (Univ. of Wis.-Madison) during 1975-1976. The results of this development program are two fully portable aids, one of which can be used with scanning and encoding techniques, and the other which has encoding and direct selection capabilities. Two different aids were developed rather than a single unit with scanning, encoding, and direct selection capabilities, after careful consideration of the requirements for a universal adaptable aid previously discussed. The two aids, though packaged differently, share many of the same features and subassemblies.

#### The Versicom

The first aid, called the Versicom (see Fig. 5), is intended for use in scanning and encoding applications. The Versicom may be mounted to a wheelchair as a laptray unit, with the front section tilted up (the angle is adjustable) to allow the individual to see the scanning panel while remaining in a comfortable position. The Versicom may also be detached from the laptray portion and used on a table or above a bed, etc., depending on

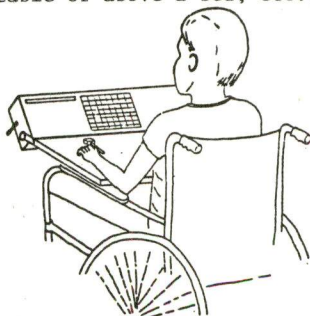

Figure 5. The Versicom

the situation of the individual using it. This aid may be adapted for use with any scanning or encoding selection technique which can be implemented with the 64 lighted segments of the display panel. The characters, words, or symbols displayed on the panel are printed on overlay sheets, which may be easily interchanged.

#### The Auto-Com

The second aid, the Auto-Com (see Fig. 6), may be used with individuals who can utilize encoding and direct selection techniques. This aid is built into a wheelchair laptray, which may also be used on a table if desired. In the direct selection mode, the user "points," using a small magnet, to a pattern of up to 128 squares on the surface of the laptray. A matrix of magnetic sensors underneath the hard, smooth surface allows the aid to automatically trace the user's pointing motions. A time-delay activation mechanism enables the aid to interpret even the pointing motions of cerebral palsied individuals, while ignoring their characteristic involuntary random motions. The Auto-Com may also be used by individuals too severely handicapped to use a direct selection pointing technique through the use of any encoding technique. In the encoding mode, any number of switches up to 8 may be operated by the user to make his selections depending on the encoding scheme being used.



Figure 6. The Auto-Com

#### Common features

Through the use of microprocessor electronic technology, the two aids have been designed so that they share many components and features. The following is a summary of the most important features common to the Versicom and the Auto-Com:

1. Portable - completely self-contained, operates on rechargeable batteries, light weight - under 15 pounds.
2. Self-contained strip printing - provides hard copy output while maintaining portability.
3. Correctable output - built-in 32 character display provides complete backspace and correction capability.
4. User control of aid adjustments - all control functions, including speed and on/off, are designed to be controlled by the user.
5. Variable selection technique - can be chosen to fit the skills of the individual. Selection mode is controlled by miniature plug-in modules which plug into sockets inside access door.

6. Variable vocabulary storage - words/phrases and their location on the selection display can be selected to suit the individual. Vocabulary is stored in same plug-in modules used to change selection technique.
7. Simplicity of setup - no setup is involved, except in positioning switches, etc.
8. Laptray enclosure - can be used as normal wheelchair laptray for eating, working, etc., or aids can be operated on table, etc.
9. Standardized output jack - allows use with external TV display, printers, etc. Also allows direct hookup to computer or telephone communication systems.
10. Applicable to non-spelling and pre-reading children - word/phrase storage allows communication without spelling. By using overlays with pictures or symbols, the aids can also be used with pre-reading children.
11. Maintainability - Modularly designed electronics allow easier troubleshooting and field maintenance. If a module fails, it can be quickly replaced with a working unit.

#### Applications of adaptable aids

Both the Versicom and the Auto-Com have been designed to provide maximum versatility in communication aid research programs as well as in direct classroom and institutional applications. Since the selection mode and vocabulary storage can be easily changed by interchanging memory modules, the teacher or clinician can begin working with a child using an uncomplicated selection technique and a very basic vocabulary, even with a non-spelling child. As the child progresses physically and mentally, the selection mode and vocabulary can be adapted to the child's needs and abilities. In this manner, a single communication aid can be applied which will "grow" with the child, and which can even provide the potential for eventual employment.

Communication aid researchers will be able to carry out research programs utilizing one aid which can be used with a large number of individuals or which can be used with one individual in various modes. This versatility will greatly aid in the development of new variations of scanning, encoding, and direct selection techniques. The large vocabulary capacity of these aids (approximately 800 words) will also be helpful to researchers studying vocabulary applications. Since the electronics of both the Versicom and the Auto-Com have been modularly designed around a central microprocessor module, research centers will also have the option of designing new aids themselves by repackaging the electronic modules and programming the aid with the functions they desire. This process would require less time and expense than designing new electronics and would result in an aid in a custom package with the same versatility as the Auto-Com and the Versicom.

#### Summary and conclusions

Communication aids have been developed at many centers around the world, utilizing various

techniques which have been successful in providing communication for non-vocal severely handicapped individuals. The selection techniques used in these aids can be categorized as scanning, encoding, and direct selection, or combinations of these basic techniques.

Two new communication aids have been developed, which, through the use of microprocessor electronic technology, provide much greater versatility in application to non-vocal individuals. Both the Auto-Com and the Versicom can be adapted to utilize a selection technique which is most efficient for a particular individual. These aids are presently in production prototype form. The Auto-Com is being released for commercial production, while the Versicom is currently undergoing field testing in several educational centers.

Teachers, clinicians and researchers will for the first time have the opportunity to use adaptable communication aids for development and evaluation of selection techniques and vocabulary systems in the field without incurring the high costs of re-developing aids each time a change is desired. In addition, communication aid programs can now be implemented with a wide range of non-vocal individuals, from pre-spelling children to those individuals who require a large, personalized vocabulary.

#### Reference Bibliography

- Copeland, Kieth. Aids for the Severely Handicapped. London: Spector Publishing Co., Ltd. 1974.
- Foulds, Richard A. Personal Communication, 1976.
- Luster, Mary Jo. Annotated Bibliography of Communication Aids. Trace Center, 922 ERB, University of Wisconsin-Madison, Wis. 53706, 1975.
- Vanderheiden, G.C., and Mary Jo Luster. Non-vocal Techniques and Aids as Aids to the Education of the Severely Physically Handicapped: A State of the Art Review, 1975. (In preparation) Trace Center, University of Wisconsin-Madison, Madison, Wis. 53706.
- Vanderheiden, G.C., and Harris-Vanderheiden, D. "Communication Techniques and Aids for the Non-Vocal Severely Handicapped," Communication Assessment and Intervention Strategies, ed. Lyle L. Lloyd. (Baltimore: University Park Press, 1976).

Due to space limitations, a complete bibliography has not been included. For a complete bibliography, please write the author at:

Trace Center.  
922 ERB  
1500 Johnson Drive  
Madison, WI 53706

## TYPING FOR NONVERBAL MULTIHANDICAPPED CHILDREN

Ann Bullock, OTR.

Occupational Therapy Department  
Kennedy Memorial Hospital  
Brighton, Massachusetts

Typing is a method of communication for nonverbal children with moderate to severe cerebral palsy. With adequate training, they are able to effectively and efficiently express their feelings, ideas, and frustrations.

### Introduction

Typewriters are the most accessible form of output device for communication and academic skills for nonverbal cerebral palsied children in the hospital/school setting. Their communication using the device gradually becomes more natural as the children increase their vocabulary and gain grammatic sentence structure. This is a slow process because of their limitations in past experiences of being able to voluntarily express themselves. With an increase in the children's ability to use the typewriter, more is learned about their personality and emotional development.

### Psychological Implications

Nonverbal physically handicapped children are limited in their ability to express concerns, emotions, desires and frustrations. If they are severely physically involved, they have limited or no means for independence in any activities of daily living: eating, dressing, playing, talking, etc. A communication device such as a typewriter gives the dependent children a useful and important skill for independence, possibly one of the few they have.

When given a typewriter, a number of problems occur. First, children must be taught to be independent not only in the use of the device but in thinking and problem solving. Second, the parents must be prepared for their child's independence and assertiveness. After relating to a dependent person for years, many parents have a tendency to overprotect and make all decisions for the child. The children find that it is easier to remain passive. Therefore the parents have to realize that they can give their child a choice-- "Do you want an apple or banana?". In turn, the child has to learn to assert himself-- "I don't like apples!".

A communication device gives children an outlet to express their emotions and feelings. The advantage of this is

most obvious when they reach adolescence. Some of the concerns expressed by the children are their role and place in their families. They see other children who leave their families to become partially or fully institutionalized. Many of their doubts for their future are expressed. Awareness of sexual changes and feelings are growing concerns for these children. Parts of the body relating to sexual functions appear in academic work and informal conversations. Through the use of the typewriter they are able to compete with their classmates more easily both for attention and personal academic achievement.

### Training

The Day School at the Kennedy Memorial Hospital enrolls several cerebral palsied and traumatic physically handicapped nonverbal children. The most available form of communication both for financial means and efficiency is the guarded electric typewriter. A certified occupational therapy assistant set up and ran a typing program for these children. Groups of three children, ages 7 to 9 years, were formed. The children were selected for each group by their ability to understand letters of the alphabet and physically locate them on the typewriter. Each child was thoroughly evaluated before beginning the program. In order for the groups to be functional, it was necessary for the children to have letter recognition and to be able to point to all keys on the typewriter. Next, correct positioning of the children and typewriters and appropriate adaptations of the typewriters were made.

The groups also included objectives other than learning to type. First, the children had to learn to respect the electronic device: not to play with the keys, etc. Second, they had to learn how to function within a group: taking turns and waiting. Development of social skills was also a factor.

When the groups began, the children needed immediate reinforcement and rewards. They were given stickers, stars, and verbal cheers. They also were given responsibility in leading the group. For instance, the therapist would have one child be the "Professor" and he would hold up the letter, word, or sentence to be typed. Games and races were held to increase involvement. The competition really motivated them and usually everyone won for something. At first the races were for speed and as their skills improved, for accuracy. The children's participation varied from day to day. Gradually though the need for tangible reinforcement decreased and they learned to wait for praise, help and reassurance.

The processes of learning the functions of the typewriter were slow, but steady progress was made. First, it was attempted to help the children become independent by teaching them to use the return button. They were simultaneously learning the location of letters on the typewriter. Next, they were taught one syllable words, their names, and to discriminate between capital and lower case letters. As the skills became more academically oriented, the teacher was consulted for appropriate words and grammatical structure. The use of the space bar was taught prior to simple sentences. Color coding of the space between the words on the page to be copied was necessary initially and gradually the emphasis was decreased. Eventually the children learned combinations of two words and functional sentences such as "I am \_\_\_\_\_", and punctuation.

There are advantages and disadvantages of teaching children to type and learn in a group setting. First, typing is beneficial because it allows a child to be independent and also relieves the teacher of one to one teaching. The negative aspects of typing are: the breakdown of typewriters is great, the children can not see over the top of the machines to read what they have typed, and mistakes are difficult to correct.

In regard to group teaching versus one to one teaching of typing, it is felt that group learning seems slower but is more fun and motivating. Group teaching was also necessary in order to involve all of the children who were ready to learn typing. Although the children were screened, they learned at different rates and typed at different speeds. Their motivation varied also. Some days, if a child did not feel well or motivated, he would play or turn off the machine.

In summary, the best method for teaching typing to the group was for them to be taught as a structured class while learning respect for the typewriter. Most important was that typing be pleasurable and successful.

### Vocabulary

Once the students received the basics in the mechanical use of the typewriter and grammatical structure, it was necessary to give them vocabulary which would allow them to converse functionally. This was accomplished by teachers, families, therapists, and other children in the class. When a child was unable to spell the words from memory, communication boards were used. They consisted of words placed in categorical lists within view of the child. When he wanted a certain word, he looked at the list, found the word by sight, and then typed it.

### Conclusion

A nonverbal physically handicapped child is able to communicate effectively using an electric typewriter with modifications and positioning. Input of vocabulary and grammar is necessary for the child to be able to express himself functionally and provide independence in one area of life. A child's emotions mature at a more adequate rate and level when he is able to express his fears, concerns, and desires.

### Acknowledgements

The author wishes to thank the following people for their assistance and advice: Sandy Storrie, COTA, Ellen S. Smith, M.Ed., and Bonnie Wolf, OTR.

## RETA - REMOTE ELECTRONIC TYPING AID

by

K. A. Stromsmoe,<sup>†</sup> P. J. R. Harding,<sup>†</sup> A. J. Kozak\* and J. F. Vaneldik<sup>†</sup>

<sup>†</sup>Electrical Engineering Department  
University of Alberta,  
Edmonton, Alberta, Canada

\*Kingma Harding & Associates Ltd  
96 33-62 Avenue  
Edmonton, Alberta, Canada  
T6E 0E1

The two versions of RETA - Remote Electronic Typing Aid are designed to allow handicapped persons to operate a typewriter by executing only very simple actions. Both systems can use either a standard IBM Selectric typewriter or an IBM Model 751 Selectric correcting typewriter. RETA 1 is designed to be operated with either a scanning or joystick type of control. Included in RETA 1 is a display board that duplicates the characters and control functions of the typewriter. Both visual and audio signals provide feedback to the typist. In RETA 2 the typing is actuated by an oversized keyboard with finger size openings above the touch sensitive keys.

### Introduction

RETA 1 and RETA 2 are systems designed to permit a handicapped person to use a standard typewriter. The RETA 1 can be used in a scanning type mode of operation, similar in concept to that used in Possum [1] and other systems [2,3,4]. The joystick mode of operation, which is also possible with RETA 1 was introduced in [5]. The overall concept of this system is similar to a previously reported system [5], however it has a more rugged construction and a simpler printed circuit board layout. In addition commercially available solenoid boards are used which were not available for the earlier system.

RETA 2 has an enlarged keyboard with touch sensitive keys. This system is designed for a handicapped person who does not possess the fine control necessary for using a standard typewriter.

### RETA 1

#### A. System Description

The block diagram of the RETA 1 system is shown in Figure 1. The five blocks shown represent the IBM Selectric typewriter, the solenoid board, the display board, the control unit and the typist controlled switch. The photograph in Figure 2 shows the units associated with both RETA 1 and RETA 2, with the exception of the solenoid board.

1. *IBM Selectric typewriter* - The choice of this typewriter was based on considerations of cost, delivery time and the fact that a solenoid board was commercially available for this typewriter. The correcting feature on these typewriters was also considered to be highly desirable. The possibility of interchanging type balls provides additional flexibility, and also makes it relatively easy to convert the system to another language.

2. *Solenoid board* - The choice of a commercially available solenoid board<sup>1</sup> eliminated

<sup>1</sup>The solenoid boards were obtained from Graphic Product Corp., Bloomfield, Conn.

the mechanical problems associated with modifying and mounting individual solenoids. The solenoid board fits over the typewriter keys. The individual solenoids require a 50 ms current pulse of 800 mA in order to actuate the typewriter keys. To deliver this amount of current a 28 volt power supply is required.

3. *Display board* - The display board arrangement was selected to duplicate the typewriter keyboard. When operated in a scanning mode this does not provide the fastest possible typing speed [3], but it does provide a simpler circuit arrangement. The display board contains 58 light emitting diodes (LED's), 44 are associated with the typewriter symbols and eight with the control

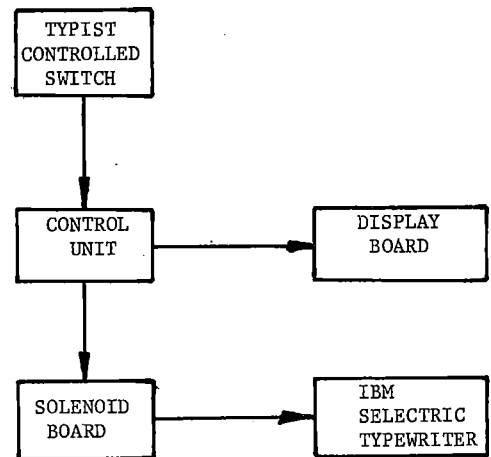

Figure 1. Block diagram of the RETA 1 system.

functions of back space, shift, lock, space (SP), carriage return (CR), erase (ER), and indent (IN). The front panel of the display board is a silked screened laminated plastic. Back lighting LED's illuminate a 1/4" red dot below the typewriter symbols. This dot is a diffused light visible, in a normally lit room, for a distance of up to ten feet and at an angle of up to 45 degrees off center. A photograph of the display board is shown in Figure 3. All LED's are mounted on a printed circuit board located in the enclosure behind the front panel of the display board.

The display board is connected electrically to the control unit by a flexible cord. This physical separation permits the display board and the typewriter to be positioned independently and to provide easy viewing for the operator.

4. *Control unit* - The typewriter sits on the control unit enclosure as shown in Figure 2. The control unit contains a single printed circuit board as shown in Figure 4. All the control logic, power supplies and driver circuits for both LED's and solenoids are located on this board. CMOS logic is used and operates at an 8 volt level.

5. *Typist control switch* - The typist controlled switch is the unit which the typist uses to control the typing operation. It must be designed to best utilize the physical abilities of the typist. Three switches have been developed, a simple mechanical switch, a photo-electric switch and a pressure operated mouth switch.

## B. Controls

The operating controls associated with RETA 1 consist of five switches and two connector plugs. The purposes of the switches and connector plugs is described in this section.

1. *On-off switch* - The on-off switch is

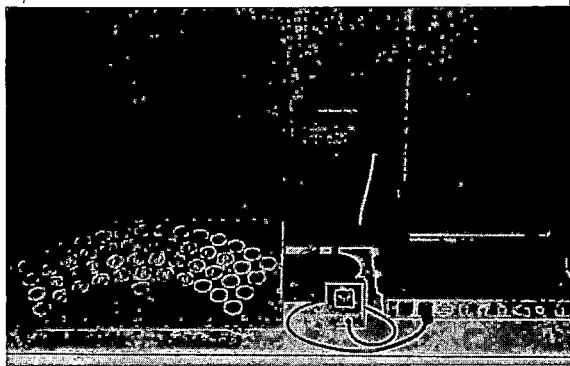

Figure 2. Components of RETA 1 and RETA 2.

used to control the power to both the control unit and the electric typewriter. The typewriter plugs into an AC outlet located in the back of the control unit. A red light located adjacent to the switch indicates when the power is turned on.

2. *Rate select switch* - The rate at which the light on the display board moves is controlled by the six position rate select switch. The setting can be in either the off position or any one of five numbered positions that varies the movement rate from 1/8 second (position 5) up to 2 seconds (position 1).

3. *SA-DA switch* - When the JS-SCAN switch is in the SCAN position the typist controlled switch can be either single acting (SA) or double acting (DA). In the DA position the control action responds to both the closing and opening of this switch, while in the SA position the control action responds only to the closing of the switch. The SA-DA switch has no effect when joystick control is used.

4. *JS-SCAN switch* - Typing can be carried out in either one of two basic methods, joystick (JS) type of control or a scanning (SCAN) method. These operating schemes are described in Section C.

5. *Speaker switch* - With the speaker switch on, short audio tones are produced with each step of light across the display board. One tone is used to indicate vertical movement and a second tone is used to indicate horizontal movement. These tone bursts provide an audio aid to the typist.

6. *Joystick connector* - When operated in JS mode, the joystick control is connected to the controller unit through this connector plug.

7. *Type switch connector* - In the SCAN/DA mode the typist actuated switch is connected to the controller unit through this connector plug, and all control action is initiated by this switch. In joystick operation this same switch connection provides the type command only.

## C. Operating Modes

The controller can be operated in three possible modes, which are described below.

1. *SCAN/SA* - In this mode, with the JS-SCAN switch in the SCAN position and the SA-DA switch in the SA position, the keyboard is automatically scanned and the position of the scan is indicated on the display board. The following steps are required in order to type a single character.

a) The starting point for the light indicator is the most upper left position on the display board. This is referred to as the 'home' position.

b) The scan operation is initiated by closing the typist controlled switch (TCS). The first closure of this switch causes the light to scan down the left most vertical column at a speed determined by the rate select switch. Releasing the TCS does not have any control function in this mode.

c) When the TCS is closed a second time,

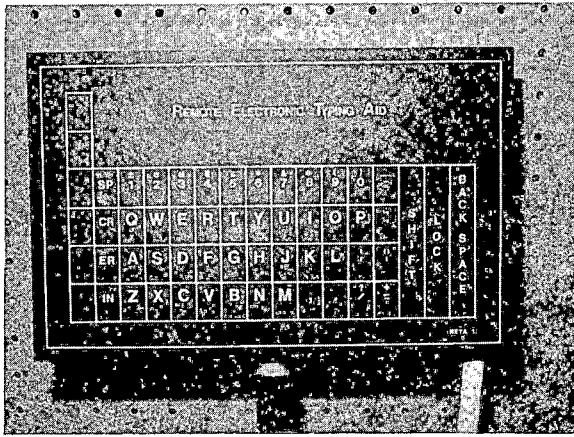

Figure 3. Display board of RETA 1 .

the light moves across the display board on the row indicated by the light at the time of switching.

d) As the light moves horizontally across the display board the light can be stopped by closing the TCS a third time.

e) Once the light has been stopped, a TYPE command may be initiated by closing the TCS a fourth time. Upon the typing of a character the light indicator will automatically return to the 'home' position. If the light is stopped on the wrong character, the mistake can be nullified by waiting three clock periods. When the TCS is closed after three clock periods the light will return to the 'home' position but no character will be typed.

f) If the operator does not initiate a TSC closure while the control is scanning the first column it will continue to cycle through this column's lower four positions. Similarly if the control is scanning a horizontal row it will continue to cycle in that row until a switching action is initiated. In this way, if the

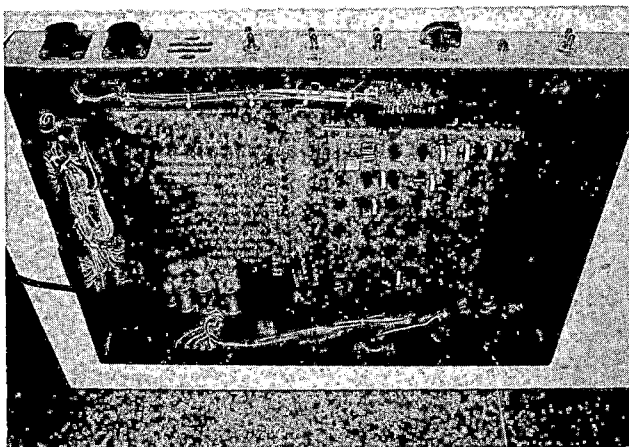

Figure 4. Printed circuit board arrangement of the control unit for RETA 1.

typist's reaction is slow initially, he can simply wait for the row or column to recycle without starting the sequence over again.

2. *SCAN/DA* - For this operating mode the JS-SCAN switch must be set to the SCAN position, while the SA-DA switch is set in the DA position. The operation in this mode is identical to the SCAN/SA mode except that the TCS is double acting. That is; when the switch is closed the vertical scan is initiated, and when it is released the horizontal scan begins. When the switch is closed a second time the scan stops and when released the character indicated on the display board will be typed.

3. *Joystick* - For this mode the JS-SCAN switch is set in the JS position while the SA-DA switch may be in either position. The TCS is always single acting in this mode. In the JOYSTICK mode, a control lever (joystick) causes the light to move up/down or right/left at a rate determined by the rate select switch.

When the control lever is released or returned to the center position the light will remain at its present location on the display board. The character indicated may be typed by actuating the TCS. The light will remain in its present position after typing, allowing the same character to be typed any number of times by repeated closing of this switch. It is possible to move the light diagonally as well as either vertically or horizontally.

The JOYSTICK mode is only useful for a person with a reasonable degree of control.

#### D. Special Functions

All letters, symbols and functions that may be performed by the typewriter are shown on the display board panel, SP stands for space and CR for carriage return. To type upper case characters it is first necessary to engage LOCK. When the LOCK is 'typed' the upper light in the lock column will go on. As long as this light is turned on the typewriter will type only the upper case characters. When the typist wishes to return to the lower case characters, the SHIFT must be 'typed'. The 'typing' of SHIFT will cause the

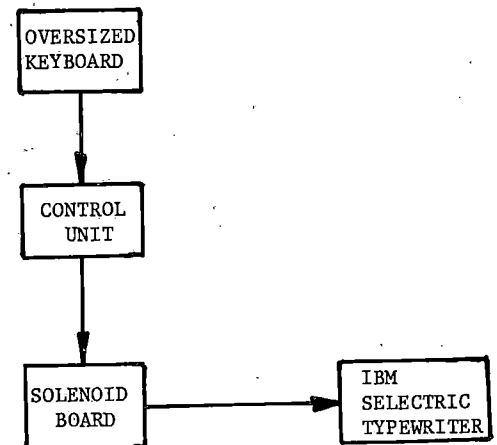

Figure 5. Block diagram of the RETA 2 system.

upper light in the LOCK column to turn off.

On the IBM Selectric typewriters with the erase feature, the operator must first backspace, select the erase function ER, and operate the TCS. The typewriter may be indexed by selecting IN and operating the TCS.

### RETA 2

#### A. System Description

The block diagram of RETA 2 is shown in Figure 5. The four blocks shown correspond to the electric typewriter, the solenoid board, the control unit and the oversized keyboard. The typewriter and solenoid board are the same as used in RETA 1.

1. *Oversized keyboard* - The individual keys of the oversized keyboard are Amphenol keyboard switches mounted on a PC board. A flexible mylar plastic, with the typewriter characters printed on it, is located above the keyboard switches and next to holes cut in the metal front plate. A light touch on the mylar plastic will activate a key.

2. *Control unit* - The control unit is housed in a metal enclosure, the same size as that used for the RETA 1. It contains a single PC board which includes the power supplies as well as the solenoid driver units. The inputs from the switches are filtered so that the key must be depressed a certain length of time before it will actuate the corresponding typewriter key.

#### Conclusions

The two systems described have been developed basically as teaching aids for physically handicapped children. Two previous systems [2,5] have been used successfully for a number of years. The present system is lighter, more compact and should give an even higher degree of reliability.

#### References

- [1] Mailing, R.G and Clarkson, D.C., "Electronic controls for the tetraplegic (possum)" Paraplegia, 1, 3, 1963, pp. 162-174.
- [2] Kildaw, R., A Multi-terminal Interface Allowing Typewriter Operation by Paraplegics (MINTOP), EE Dept., University of Alberta; M.Sc. Thesis, 1968.
- [3] Englehart, T.W., A Computerized Typing System for the Handicapped, EE Dept., University of Alberta, M.Sc. Thesis, 1971.
- [4] Foulds, R.A., "The Tufts Interactive Communicator," Proceedings 1972 Carnahan Conference on Electronic Prosthetics, Dec. 1972, pp. 16-24.
- [5] Harding, P.J.R., Kingma, Y.J., Kozak, A.J., Stromsmoe, K.A. and Vaneldik, J.F., "Typewriter for Teaching Severely Handicapped Children," Proceedings of the 1973 Carnahan Conference on Electronic Prosthetics, Nov. 1973, pp. 43-46.

## COMPUTER ASSISTED COMMUNICATION SYSTEM

by

Travis M. Tallman, M.S.  
United Cerebral Palsy Association  
of Middlesex County  
Roosevelt Park  
Edison, New Jersey

Severe social, educational, and vocational limitations are imposed on the cerebral palsied individual who lacks a means of communication. The Computer Assisted Communication System (CAC) is a specialized word processing and retrieval system allowing interactive communication at various compatible levels of performance through the use of a computer. The CAC system not only resulted in the expansion of communication, but also contributed directly to other factors influencing the communication of the cerebral palsied individual.

### Introduction

The impact of cerebral palsy goes beyond that of the purely physical condition. Perhaps the most devastating aspect for many is the inability to communicate. This means isolation from those experiences which foster the development of an individual's personality, and his social and educational skills.

Alternate modes of communications are available, but they are usually considered only as a last alternative. Although individually constructed according to physical, social and educational levels, limitations are always imposed on vocabulary and linguistic usage. The individual is not only limited verbally, but in all other language modalities. This paper will describe a communication aid which through the utilization of various computer capabilities attempts to develop the full communicative potential of the cerebral palsied individual. It will also discuss considerations in the development of communication aids and further research needs.

### History

Research into the use of electronic communication aids is documented as early as 1957 (LaVoy 1957). Within the past five years there has been increased research into the development of electronic aids. This research covers various levels of technical sophistication. (Lywood and Vasa 1974; Rahimi and Eulenberg 1974; Vanderheiden, Volk and Geisler 1973). These electronic aids were designed primarily for use by individual adult trauma patients.

With the continued advancement in technology, it is not surprising that computers would be utilized in the development of electronic aids for the handicapped. Rahimi and Eulenberg (1974) initially described the use of a man-computer communication station incorporating a Votrax Voice Synthesizer for computer aided instruction

to the blind. Dr. Dudley Childress of Northwestern University is employing the use of a computer to assist electronic devices. A Multi-Access Interface for the Disabled (MAID)<sup>1</sup> employs a computer which not only assists communication, but environmental controls and daily living activities. Vanderheiden, Volk and Geisler (1974) postulated the use of a computer designed system with their Auto-Com Board. However, most systems employing computer technology have utilized them in a limited capacity. The most common disadvantage of conventional communication systems has been in the amount and flexibility of available information for quick message retrieval (Hagen, Porter, Brink 1973). State of the Art technology in computer word processing systems lends itself to the development of more effective and efficient communication aids. The question then arises as to whether a direct computer assisted communication system would be a feasible alternate means of communication.

It was with these ideas in mind, and a desire to improve the communicative efficiency of the cerebral palsied individual, that initial design for the MOD I version of the Computer Assisted Communication System (CAC) was developed. Objectives of the CAC System were:

1. to explore a means of developing full communicative potential by utilizing various computer capabilities;
2. to provide techniques for reducing the physical burden of entering text information;
3. to provide an efficient and effective means of text storage and retrieval;
4. to provide an efficient editing system; and
5. to provide a means of assembling pieces of constructed information into concatenated messages.

### Description of the System

To achieve these objectives, the following system was designed. Although the initial design of the study was primarily to evaluate the computer supported capability, considerations were given to adapting a man-machine interface.

### Hardware

The hardware components of the CAC consists of an oversized typewriter-like keyboard; standard television display unit, and telephone hook-up. A direct key input selection method was employed for controlling the man-machine interface. Although various other control techniques are available, such as scanning and encoding, the direct selection method appeared adaptable enough to fit the remedial needs of the majority of cerebral palsied individuals. The CAC keyboard is similar in its layout to that of a standard typewriter; but with several significant differences. These differences deal primarily with keys designated for specific control operations. This keyboard layout is shown in Figure 1. The keys and controls are slightly recessed to eliminate random errors caused by involuntary movements or loss of control. The keyboard stands slanted on short collapsible legs. The keys are activated by a slight, but sustained pressure.

### C. The Message File

When more than a phrase is required to express thoughts, a message storage file is available. Sentences can be constructed in the scratch pad by direct key input or by the retrieval of phrases from the phrase book file. Sentences and messages can be stored by a single key command Am. These messages are then retrievable from the message file by activating the key control Dm. Messages may be erased by the key function Em. At present three message storage files are available.

In addition to the computers capabilities for information storage and retrieval, the computer affords the handicapped individual a means of economizing on the number of key operations.

### D. Frequently Used Word File

Frequently used words such as: "the", "for", "you", "which", and short strings of words..."Thank you", "I would like"... can be called into the scratch pad by typing previously coded abbreviations. Examples are "tt...that"; "u...you"; and "IW...I would like".

### E. Word Ending Abbreviations

More frequently used word endings can be shortened by: 1) ending words with a single letter abbreviation, and 2) using the Word Ending Space key (WES) instead of the normal space key. Examples are "d...ed"; "G...ing"; and "y...ly".

### F. Text Editing

A text editing system is available at the scratch pad, phrase book and message file levels. The erase key (EK) can be utilized to correct a mistake prior to its storage either temporarily or permanently in the computer. However, once the text has been entered, the editing system must be utilized in order to correct errors. Editing is accomplished by operating the Ew key.

A summary of the computer control functions is shown in Figure 2.

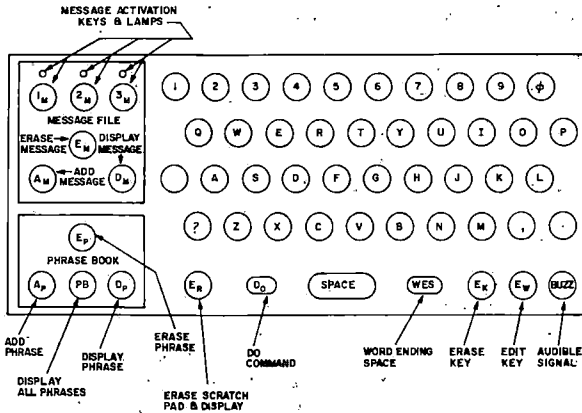

Figure 1

A standard television set has been employed as the principal display unit. The television unit was utilized due to its easy accessibility, good visual display and general freedom from technical problems.

### Software

The CAC system has three basic overall functions:

1. Letter and control keys which function to construct information into a work area termed scratch pad (SP);
2. Editing controls which allow for the correction, addition and/or deletion of text information; and
3. Controls which allow for the quick storage and retrieval of information for display.

These overall functions are programmed into several upward and compatible levels of capabilities. These capabilities are described in their ascending order of complexity.

#### A. The Scratch Pad

By direct key input words can be constructed by the user and temporarily stored in a file termed scratch pad (SP). Scratch pad allows erasures of key mistakes by a single key operation (EK). The entire scratch pad may then be added to permanent storage under either the phrase or message files by actuating the appropriate controls. It can also be erased by a single key function (ER).

#### B. The modifiable Phrase Book

Through the use of a scratch pad function, the user is able to construct phrases, sentences, and sentence carriers. This information may then be entered into the Phrase Book file (PB). The phrase is entered into the phrase book file by activating the key control (Ap) and then signifying a 1 or 2 character code. At a later time specific phrases can be quickly recalled and displayed or added to other text being developed in the Scratch Pad. This is done by activating the key control Dp and then the specific 1 or 2 character code (example Dp HI). Individual phrases may also be erased from the memory file by activating the control Ep and then the 1 or 2 character code.

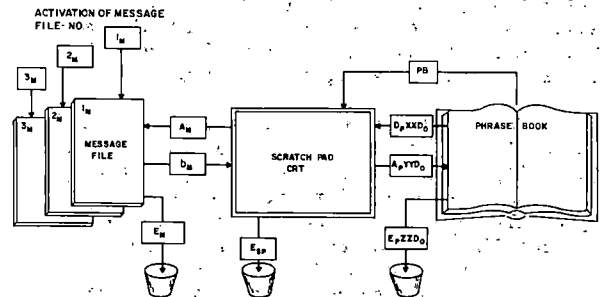

Figure 2

## Utilization and results of the study

In order to move these ideas as quickly as possible it was felt that further development of the concept would occur through direct interaction with the users. Six individuals were selected for the initial study, ages ranged from seven to twenty-four. All were classified severely involved spastic or athetoid quadriplegics and exhibit either non-vocal or unintelligible speech production. All possessed at least basic spelling and word recognition skills. However, none were functioning at an educational level commensurate with their chronological age.

No specific teaching programs were developed prior to the onset of direct interaction. Teaching followed what appeared to be the most logical process; teaching the computer capabilities as they ascended in complexity. New features were added as the individual developed specific skills. Each individual has a separate memory file identified by a unique letter.

Three of the individuals are now able to utilize all levels independently with less than significant errors. One of the individuals is now successfully able to intermix all capabilities with assistance. One of the users is at the message level and one has not been able to proceed beyond the basic level. The editing system feature appeared to be the most difficult function for all users to learn. Three of the users are presently utilizing the frequently used word list and word ending space techniques. The frequently used word list has been employed more consistently than the word ending space capability. Presently both of these features are visually displayed for the users.

The computer allowed a great deal of individual diversification. Unlike humans it had no specific time requirements. It was able to perform as rapidly or slowly as required by the individual's physical or educational needs. It also provided various levels of communication functioning. The individuals were using words (orangutangs, chimpanzees) which would never have been available to them on traditional communication boards. Vocabularies were much more extensive than we had imagined. Individuals have started writing stories, legislative bills, essays and letters to friends. Things they had never attempted before. They have gone beyond basic communication. All of the individuals using the computer are employing it in a different way. The computer assisted communication aid took into account individual differences physically, educationally, and emotionally.

The oversized keyboard, with its special key controls, served the needs of the individuals presently utilizing the system. Special adaptations such as head pointers, dowel stick and specially designed gloves were utilized however, to facilitate better control. The users felt that the specially coded keys simplified their understanding of the computer controls. This specialized keyboard reduced the physical burden of entering, storing, and retrieving text information.

The television display unit proved to be a very effective output system. In trials utilizing a teletypewriter a great deal of difficulty was experienced in reading the standard print out. It is felt that the lightness and size of the print was a contributing factor. The television display unit, with its contrastive dark background and white print, made letter recognition easier. Errors were easier to identify. This may have eliminated some of the perceptual difficulties frequently experienced by the cerebral palsied. The present market of small portable televisions makes this output mode a viable method of display. It also lends itself applicably to the development of a portable system. It has been recognized however that the option for a hard copy permanent print-out is necessary for the system to become effective in educational and vocational settings.

The total effectiveness of the CAC goes beyond the actual computer design. It has provided us with an effective evaluation tool. Specific linguistic and morphologic patterns were noted. Irregular verbs were frequently coded with the regular past tense form - "ed". Conjunctions were placed both at the beginning and throughout sentences and were employed to connect sentences even after a period mark was designated. Spacing, which is specific to the written language modality, was frequently missing. One young girl wrote five lines of continuous text with no spaces. Punctuation was another area of weakness discovered through employing the CAC. Question marks were most frequently omitted. However, the users were able to construct question sentences. Articles were frequently missing forms. The copula "is" and auxiliary forms were rarely coded. In addition, the CAC demonstrated the development of surprisingly good phonic skills. The CAC will soon be utilized by Child Study Teams in evaluating the cerebral palsied child's educational development.

Parents have been more receptive of the CAC communication system than they have been of other communication aids. Traditional boards were looked upon as exemplifying both physical and mental inadequacy. They were considered inflexible and restrictive. The CAC system has been somewhat accepted due to the mystique which surrounds its technology. And most parents have accepted it because of their children's enthusiasm and motivation to communicate.

The CAC system not only resulted in the expansion of communication, but also contributed directly to other factors influencing the communication of the cerebral palsied individual. For many cerebral palsied individuals the desire for independence tends to fade as they grow older. This is due in part to the failure to achieve any form of independence, even in man's most basic modality--communication. The CAC system promotes and allows a means by which the cerebral palsied individual can work and communicate independently. It encourages not only freedom of expression, but allows the cerebral palsied individual to do his own interpretation.

Motivation plays a vital role in the use of a communication aid. The CAC has proven to be extremely motivating. This statement is based on the fact that most of the users have asked for more time to work on the computer. Aside from their regular sessions, children are now coming in at lunch, during free periods and after school. This new motivation to communication is being demonstrated in their total personalities.

#### Further considerations

Although the designs for the initial CAC system were developed from a technological viewpoint, the study aspect was to review it from a total therapeutic and technological point of view. With this in mind, considerations were given to individual positioning and equipment placement. It must be realized by those using and developing communication aids for the cerebral palsied that the positioning of the child is vital to increased hand function. Chair inserts can be utilized to eliminate sliding and poor wheelchair position. Leg, feet and hand stabilization can help specific individuals decrease tightness and reduce involuntary movements. For young cerebral palsied children, abnormal reflex patterns should not be encouraged in order to enable direct hand typing. It may be better to temporarily employ a head pointer and give stabilization with the hands. One hand typing may be utilized to decrease athetoid movements.

The placement of the keyboard and television unit is another important consideration. The keyboard was found to be most accessible when placed in an upward slanting position. The television display unit should be in direct alignment with the keyboard, but slightly above it. This not only provides good visual feedback for the user, but also aids in other therapeutic functions. It eliminates quick rapid changes of head positions which causes trunk instability and a reduction in smooth efficient key operation. Proper equipment positioning also encourages good eye contact. Eye contact is not only vital for equipment efficiency, but also for social involvement. Too frequently these individuals, especially the wheelchair bound, tend to slump into their chairs, and maintain minimal eye contact. This not only encourages social isolation, but also prevents an erroneous picture of mental ineffectiveness. Many communication aids have encouraged this head down position. The development of a communication aid must employ all the disciplines that deal with these individuals--physical, speech, occupational therapies, education, engineering, and computer technology.

#### Further Research

The CAC system has proven to be an extremely flexible and viable solution to the total communicative needs of the cerebral palsied. However, its present form (letter input) restricts its usage to those who have spelling and word recognition skills. Further research is needed to assess the computer's feasibility at more basic levels. Attempts are being made to utilize the features of a graphic display unit for picture-concept formation. With today's advanced programming technology, computer assisted communication for the non-reader and speller is a

very real possibility.

No one specific man-machine interface may be applicable when dealing with the physically handicapped. However, we have recognized that man-machine interfaces do play as vital a role as the computer supported capabilities. Each by itself will not answer the total needs of the cerebral palsied.

The present CAC system is stationary. This is a limitation. Those involved in the area of computer technology predict that within several years portable computers and compact mini-computers will be priced within reach of many organizations and individuals. Computers could be made an integral part of a specialized laptray board. This opens up numerous educational, social and vocational opportunities never before available.

A second phase of the CAC study is now being planned. Continued emphasis will be on computer programming. Research will be done in more accurately evaluating skills necessary to achieve successful functioning at the various computer capability levels. It is recognized that at some point, coding stored phrases, sentences and messages may reach a maximum. These boundaries will be studied further. Word processing and retrieval will be assessed as to its advantages in increasing the speed and the proficiency of communication. Work will continue on the development of a versatile man-machine interface. The study will now be utilizing an on-site PDP8 mini computer which will allow a greater amount of storage capacity.

#### Conclusions

The CAC has demonstrated that a direct computer assisted communication system is a feasible alternate means of communication for the cerebral palsied individual. It has provided the physically handicapped individual with more than just a means of developing their full communicative potential. It has given these individuals a feeling of independence which has never before been available to them.

<sup>1</sup>MATD The Multi-Access Interface for the Disabled. Dept. of Medical Physics; The Prince Henry Hospital, Matraville, New South Wales, Australia.

#### Acknowledgement

I would like to thank all those members of The Frank B. Jewett Chapter, #54, of the Telephone Pioneers of America, Whippany Council, who together developed the CAC system and afforded me much personal support. I would also like to thank Digital Equipment Corporation, and in particular, Bernie Toth for his technical support.

Particular thanks also to The United Cerebral Palsy Treatment Center in Edison, New Jersey, and Miss Winifred Parker, Staff Occupational Therapist at The Center for her help and guidance.

## References

Hagen, Chris, Porter, Wayne and Brink, Joyce. "Nonverbal Communication: An Alternate Mode of Communication for the Child With Severe Cerebral Palsy." Journal of Speech and Hearing Disorders, Vol. 38, No. 4, p. 448-455 (1973).

LaVoy, R.W. "Ricks Communicator." Exceptional Child. Vol. 23, p. 338-340, (1957).

Lywood, D.W. and Vasa, J.J. "Computer Terminal Operating and Communication Aid for the Severely Handicapped." Medical and Biological Engineering, Vol. 12, p. 693, (1974).

Rahimi, M.A. and Eylenberg, John B. "A Computer Terminal with Synthetic Speech Output." Paper presented at The National Conference on the Use of On-Line Computers in Psychology, St. Louis, Missouri, 31 October, 1973.

Vanderheiden, G.C., Volk, A. and Giesler, C. Daniel. "An Alternate Interface to Computers for the Physically Handicapped." AFIPS Conference, Vol. 43, p. 115-121.

## THE ELECTRONIC VISUAL COMMUNICATOR

by

Cheryl A. Rogers, C.C.C.-Sp.  
Senior Speech Pathologist  
United Cerebral Palsy Association  
Of Western New York  
Buffalo, New York

Joseph Bruder - M.S.E.  
Principal Electronics Engineer

The EVC in this, its primitive state already adapted and readapted as of this printing to fit individual needs, is considered applicable with a variety of disabilities: cerebral palsy, stroke with associated aphasia, learning disabilities, post-laryngectomies, burn victims, and speakers who are unintelligible due to emotional or organic reasons. It is applicable as a support or alternate form of communication. The EVC can be utilized as a teaching, diagnostic, recreational, or basically communicative instrument.

### THE ELECTRONIC VISUAL COMMUNICATOR

#### Description Of The EVC

The Symtronics EVC consists of an upright board which provides a display for the symbolic characters (i.e. Bliss symbols, words, pictures) and a control unit for electronically selecting the light which designates the desired symbol. The EVC communication board can be directly connected to a variety of switch sensors to facilitate mating the interface to the handicap and the abilities of the individual.

The EVC is the first electronic unit to be developed at UCPA of WNY by Joseph Bruder on a voluntary basis and funded by donations from private individuals and organizations.

The severely handicapped who can only depress a single contact switch via touch (hand, foot, chin, lateral hand movements, etc.) the light designating the symbol will progress from left to right, and step down to the next lowest row once the right hand edge is reached, in a much the same manner as one reads a page of printed matter. For those with greater manipulation control, an addition of a second contact switch will enable the symbol light to move from right to left (and thus back up). For those who have sufficient manual dexterity to control a four-position joystick, moving

the joystick lever in the appropriate direction will move the light on the symbol board up, down, to the left or to the right. In this mode the light will stop whenever it reaches the edge of the board. All of these external interfaces can be attached directly to a connector on the control unit, and no wiring changes are required when switching interfaces. In addition to the interfaces external to the control unit there is a joystick mounted on the control unit. This joystick can be utilized either by the handicapped individual or an instructor, and can be used even when an external interface of any type is connected to the control unit. Should both the control unit joystick and the external interface be activated, the symbol light will be controlled by the control unit joystick. This multi-mode interface capability greatly simplifies adaption of the communicator to the individual handicap and permits the same board to be used by a number of individuals with completely different handicaps.

Two models of EVC have presently been produced, a sixteen symbol board with large (three inch by three inch) symbol squares in which the symbol selected is backlighted through a translucent panel, and a more advanced one-hundred symbol board featuring a small red indicator lamp adjacent to each symbol. Both feature readily

interchangeable symbol panels so that a different set of symbols can be presented on the communicator. Both units also include an interface connector to provide easy interchangeability of the various interfaces, and a variable stop-time control to set the time between symbol stepping to individual's capabilities. Both 16 and 100 symbol EVC's portable and could fit into a case about the size of a large attache case. The combined weight of the symbol board and control unit is approximately ten pounds. The units are battery operated off a single 6 volt lantern battery. Alternately the units could include a rechargeable battery, or a power convertor for operation off 117 VAC.

The sixteen symbol communicator contains a symbol board 13" by 15" by  $3\frac{1}{4}$ " deep with a four by four grid of 16 large squares. Recessed in each square is a low voltage incandescent bulb which is illuminated upon command by the control unit. A translucent plastic sheet is inserted in a track and slides in front of the square grid of lights. The symbols can be either drawn or painted on the translucent sheet, and the entire square containing the symbol is illuminated by the light when that symbol is selected by the control unit. This 16 symbol board with its large symbols is particularly suited for introducing new students to symbolic communications. The symbol board also includes a cable which connects it to the control unit.

The control unit for the 16 symbol board consists of an enclosure 3" by 7" by 12" and contains the control electronics, a battery, a joystick, controls, and the interface connector. On the top of the control unit is a power switch, intensity control, stop-time control and joystick. Associated with the power (on-off) switch is a small indicator lamp to show when the control unit is on. The intensity control adjusts the brightness of the symbol lamps. The stop-time control adjusts the stop time between stepping of the symbol light and is calibrated from 0.2 to 1.8 seconds per step. The joystick provides primary control of the light on the symbol board and enables the operator to move the light up, down, to the right or to the left. The light will continue to move as long as the joystick is held in one of these four positions or until the light reaches the edge of the board. The electronics which is the "brain" of the control unit

primarily consists of approximately 20 integrated circuits, and transistor lamp drivers. The integrated circuits which each contain the equivalent of dozens of transistors, diodes, and resistors were primarily developed over the last fifteen years for the missile and space industry and are now readily available, highly reliable, and reasonably priced. The battery for this particular unit is a standard 6 volt lantern battery which is reached through a door in the bottom of the control unit.

Picture One

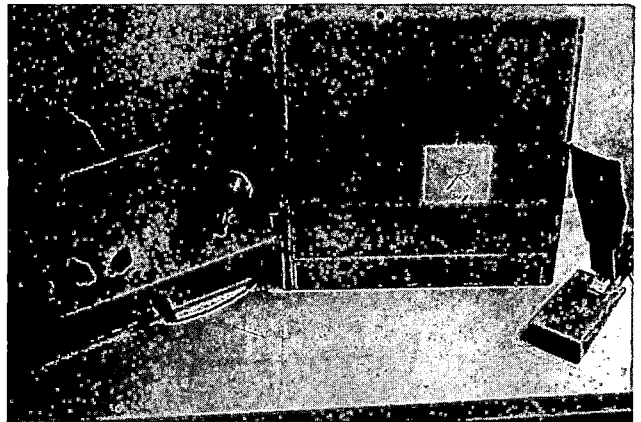

The one hundred symbol board features smaller symbol squares (approximately 1.5 inches by 1.5 inches) with a light-emitting diode (LED) lamps in the corner of each symbol square. These LED lamps have extremely long life and result in a symbol board which is more portable and lower in cost than that possible with incandescent lamps. The symbol board has a symbol overlay which is readily exchanged with another symbol overlay. (not pictured)

The control unit for the 100 symbol board is quite similar to the 16 symbol control unit and the operation is virtually identical.

## THE ELECTRONIC VISUAL COMMUNICATOR

### Application Of The EVC

The EVC is able to serve multiple purposes. In its present design, it is used as a teaching aid to encourage learning and to keep the non-vocal neurologically handicapped child motivated to learn via the "magic light" and built-in expressive success as they "talk" in either pictures, words, and/or Bliss symbolics to others. Symbol characters used to express one's wants, needs, desires can be placed on the interface for flexibility of teaching methods by grease pencils, photographic negatives, and/or acetate overlays. With multiple interchangeable interfaces language expression and intellectual curiosity has been recorded to expand with certain populations at UCPA. An individual once thought to be severely "mentally" retarded has been cited recently to have as her main deficit, basic "communicative" retardation due to one's lack of expressive outlets.

A teacher-therapist could use such a unit to teach vocabulary, develop visual closure and perceptual skills in the areas of figure-ground, sequencing, directionality, body parts, shapes, numbers, days of the week, and/or space perception skills. This unit is particularly good because the individual is able to see the teacher-therapist as a model in their communicative interaction, due to the double switches explained above.

One child at UCPA who showed little motivation to attend to stories or make shape or picture associations within the classroom setting, with the help of seeing her response "light up," attention span has increased and more frequent smiles are noted on her face. Since an educational program has been set up in the past without a separate classroom for non-vocals, often times there would be one child mentally alert yet so physically handicapped to end up unable to participate socially related activities and if so be more "in the way" than "way into" the activities with classmates. With the EVC non-vocals, vocals, and even staff members interact differently - in a more positive way with the non-vocal. All the children in L's class want to learn symbols so as to use her talking machine. It's great for her self-image for she now has something to share with them; to be able to

interact with them rather than only to react to them.

The EVC can also be utilized as a diagnostic tool to assess visual tracking, sequential memory, learning potential for use of different contact switches and interfaces, attention span and ocular focusing, for what length of time and for what size character.

Below is a picture of R being assessed for the 16 character EVC. Prior to this unit, she utilized a cardboard symbol board propped upright on her lap table which she touched each character with the makeshift headhelper, alias plastic straw and hockey helmet you see her wearing. Little did I know, that all the head-pointer work that I questioned because of the severity of her mixed CP which encouraged only scanning rather than pressure by her head-pointer, during her reassessment on the EVC I found she used the head-pointer as a guide. A guide used to show gross functional left extremity usage for her to be able to work the contact switch with her left hand. So after this we observed R to rapidly retain introduced symbols and show an eagerness to put more on the interface board.

Picture Two

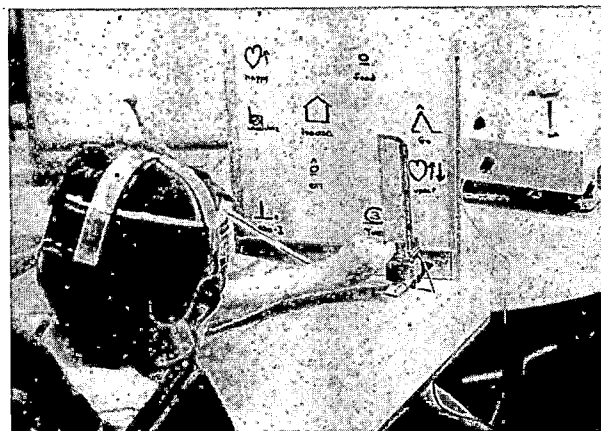

As a recreational play instrument, games, with adaptive overlays or by using

different colored grease pencils on one plexiglass board, could be the following: tic-tac-toe, checkers, chess, concentration, Bingo, Hang-man, cards, storytelling or even singing a song along with the others only graphically. All these and more if done, aids that individual in relating more effectively and more confidently with not only the non-vocal but also the vocal population.

It can also be used as an alternate form of communication for severely physically handicapped individuals with no other purpose but to express ADL needs. Consider also it being used in a sheltered workshop to request different supplies needed from a supervisor to continue job flow.

It might also be used as a support system by individuals in various treatment centers, cardiac care units and burn treatment centers where the individuals may be unable to vocalize or have enough strength to support a pencil to spell out words to hospital personnel to express their needs and/or questions. Consider too, the persons who are acute post-laryngectomies who have a great need to express themselves but feel hindered. The universality of symbol/pictures should also via a communication unit like the EVC be used in multi-lingual Emergency Room Care facilities to reduce the amount of anxieties in the staff as well as the patients due to lack of misinterpretations.

In conclusion then, we have hoped to begin by this EVC to open up new avenues of alternate forms of communication with often times neglected populations, encourage more sophisticated diagnostic measures for the non-vocal population by language, educational, perceptual, and psychologically geared personnel, and for Buffalo, New York make the area populous more aware of the need for further adaptive equipment particularly in the area of education, recreation, and communication.

For further information contact Cheryl A. Rogers; United Cerebral Palsy Association of Western New York, Inc.; 100 Leroy Avenue; Buffalo, New York 14214 (716) 833-3231.

This Project Has Been Supported By:

- Parent Teachers Association  
Of United Cerebral Palsy Association  
Of Western New York
- D'Youville Alumni Association
- Master Masons Clowns Association  
Of Buffalo
- Private donations
- United Cerebral Palsy Association  
Of Western New York  
Edgar J. Schiller, Executive Director  
Maxine Conway, Clinical Director

A DISPLAY BOARD FOR NON-VOCAL COMMUNICATION  
ENCODED AS EYE MOVEMENTS

M. Rosen\*, P. Drinker\*\*, G. Dalrymple\*

\*Rehab. Eng. Center, M.I.T., Cambridge, MA. 02139

\*\*Bioeng. Div., Dept. Surgery, Peter Bent Brigham Hosp., Roxbury, MA.

Summary - There is a clinical need for communication devices useable by non-vocal individuals who have also suffered complete loss of limb function. We have developed a display board which permits communication coded as eye movements. It has the additional advantage of being simple and inexpensive to construct, maintain and modify. Our experience with the board shows that it is rapidly learned and advantageously used by a wide range of people from diverse backgrounds.

Clinical Need

The need commonly arises in the hospital setting to provide a means of communication for patients who have lost the power of speech. This deficit may be a direct result of the condition for which such a patient is hospitalized - e.g. stroke or brain injury - or due to the insertion of a tracheal tube for management of respiratory problems. The availability of a mode of communication is critical acutely for the expression of pressing medical needs and chronically for the preservation of emotional health and progress in rehabilitation. The problem of developing an alternative to speech is doubly compounded if the patient's condition deprives him of the ability to articulate words with lips and tongue - precluding the use of an artificial larynx - and, more severely, renders him quadriplegic. The permanently non-vocal person who is further incapable of voluntary use of the limbs confronts the practical obstacle and emotional horror of being trapped in a body which has become unresponsive as an information output device. This state of affairs is aptly described in clinical parlance as "locked-in syndrome". It was with a stroke victim in precisely this situation that we became involved in the problem.

A considerable array of non-vocal communication systems and devices has been developed and many of these are clinically available.<sup>1</sup> Those methods which require direct selection of entries in a displayed array using residual motor ability are ruled out for use by the multiply-handicapped population described above. Scanning devices are conceptually appropriate in that they only require a simple binary movement (a blink or jaw movement, for example) to interrupt the automatic sequencing of array items. Our patient was provided with such a device in the form of a clockface which displayed letters and numbers selected in sequence by a sweep hand.<sup>2</sup> He found that in order to use it with reliable accuracy of mouth switch closure, he had to be content with a frustratingly low communication rate. Finally, several devices which might be appropriate for such a patient require care in use, sophistication of maintenance support, and initial expenditure which may be difficult to achieve in many hospitals.

A Solution

Our response to the multiple constraints on a communication mode for our patient was a modification of the "Etran" display strategy developed by J. Eichler.<sup>3</sup> This technique permits encoding of communication as a sequence of eye movements and requires construction of only a trivially simple display board. The code depends upon the arrangement of "entries" (letters, words, numbers and other symbols) on the board. As shown in the figure, there are eight groups of eight entries displayed and the pattern of groups on the board is identical to the pattern of entries in each group. The non-vocal individual communicates an entry by directing his gaze first to the group containing it and then to the group which has the same position on the board as the entry has in its group. It may be seen, for example, that the word "TURN" may be encoded by directing the eyes first at the lower right group and then at the middle left group. Note that the "receiver" who is observing the "sender's" eye position need only resolve eight directions of gaze. In effect, entries are communicated as two-digit octal numbers.

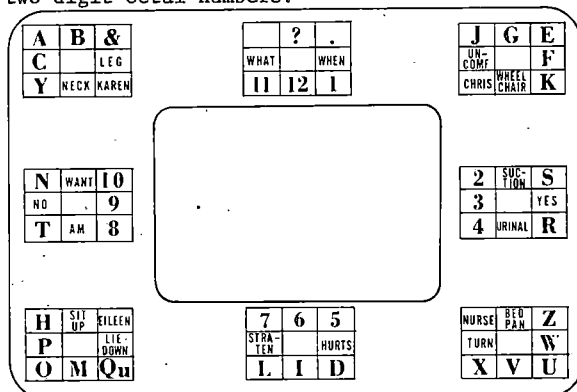

Figure - Typical choice and arrangement of board entries. Board is 24 in. by 16 in. and should be about 3 ft. from sender.

In use, the board is placed between the sender and receiver who face each other through it. The receiver's side displays a back-to-back duplicate of the sender's. The practical rules of use may specify that the sender direct his gaze back to the receiver between the two gaze

directions required for communicating an entry. While this slows communication, it may be valuable for new users by permitting the receiver to point to the first group indicated to verify his understanding. Similarly, communication of each entry is terminated by the re-direction of the sender's gaze to the receiver and vocal repetition by the receiver of the communication as decoded. Note that there are eight "special" locations on the board for which the second gaze direction is the same as the first. (If the intermediate return of the sender's eyes to the receiver suggested above is omitted, entries in these special locations may be communicated by only a single shift of gaze from the receiver.)

The particular locations of entries shown in the figure represent a compromise between use of obvious or standard patterns to facilitate initial learning of the board and choice of locations for efficiency of use by correlating frequency of use with ease of the required eye movements. Note, for example, that learning is facilitated by the clockface arrangement of the numbers and by the segregation of entries according to type. On our board, the latter scheme is reinforced by coloring the entries according to type (e.g. blue for numbers). On the other hand, efficiency of use dictated the location of vowels, "YES", "NO" and "?" in the special locations defined above, since the particular ease of encoding these positions is consistent with the frequent use of these entries.

Physically, the board may be cut from any reasonably stiff, light material such as cardboard, plastic, thin fiberboard or plywood. Clear plastic has the advantage that it does not impede the users' view of their surroundings. It is desirable to avoid a permanent application of entries to the board (unless it is truly disposable), particularly of whole words, since their choice and location may change with the sender's needs, surroundings and communication skills. Ease of modification may be achieved if lettering is applied via self-adhesive labels. Robust adjustable fixation of the board with respect to the sender may be achieved, for example, with a jointed, spring-loaded, lockable stand such as the type used for desk lamps or microphones.

#### Clinical Experience

Our clinical experience teaching and using the board with our patient and those attending him has generated several practical conclusions. 1) A simple scanning communication device should remain accessible to the patient for situations where immediate communication is necessary with an attendant unfamiliar with the encoding board. 2) Presentation of the device to the patient should take place after those who will be using it with him and instructing him in its use are thoroughly familiar with it. Such familiarity may be gained only through trial-and-error use of the board in the role of receiver and sender. Subtleties of use are otherwise difficult to anticipate and failure to understand them may cause initial rejection by the patient. 3) Pre-existence of this demonstrably competent group of receivers will allay the patient's fear that few people will be able to learn to use the board with him. 4) A variety of individuals with no special prior qualifications can rapidly become competent receivers and instructors of other receivers. 5) The initial investment of

time and effort by the patient required to learn the locations of board entries does pay off in a communication speed which increases with users' skill and may considerably exceed that obtainable with scanning devices. It is theoretically possible for a very accomplished receiver and sender to employ the gaze direction code without the board.

#### References

1. Participant Resourcebook, 1975 National Workshops on Non-Vocal Communication Techniques and Aids, Trace Center, U. of Wisconsin, Madison.
2. Bryan Mfg. Company, Inc., 71 Leonard St., Norton, MA.
3. Same as (1).

#### Acknowledgment

This investigation has been carried out as part of the Harvard-MIT Rehab. Eng. Center Project, supported in part by Research Grant No. 23P 55854/1-03 from the Rehab. Services Admin., Dept. of H.E.W., Washington, D.C. 20201

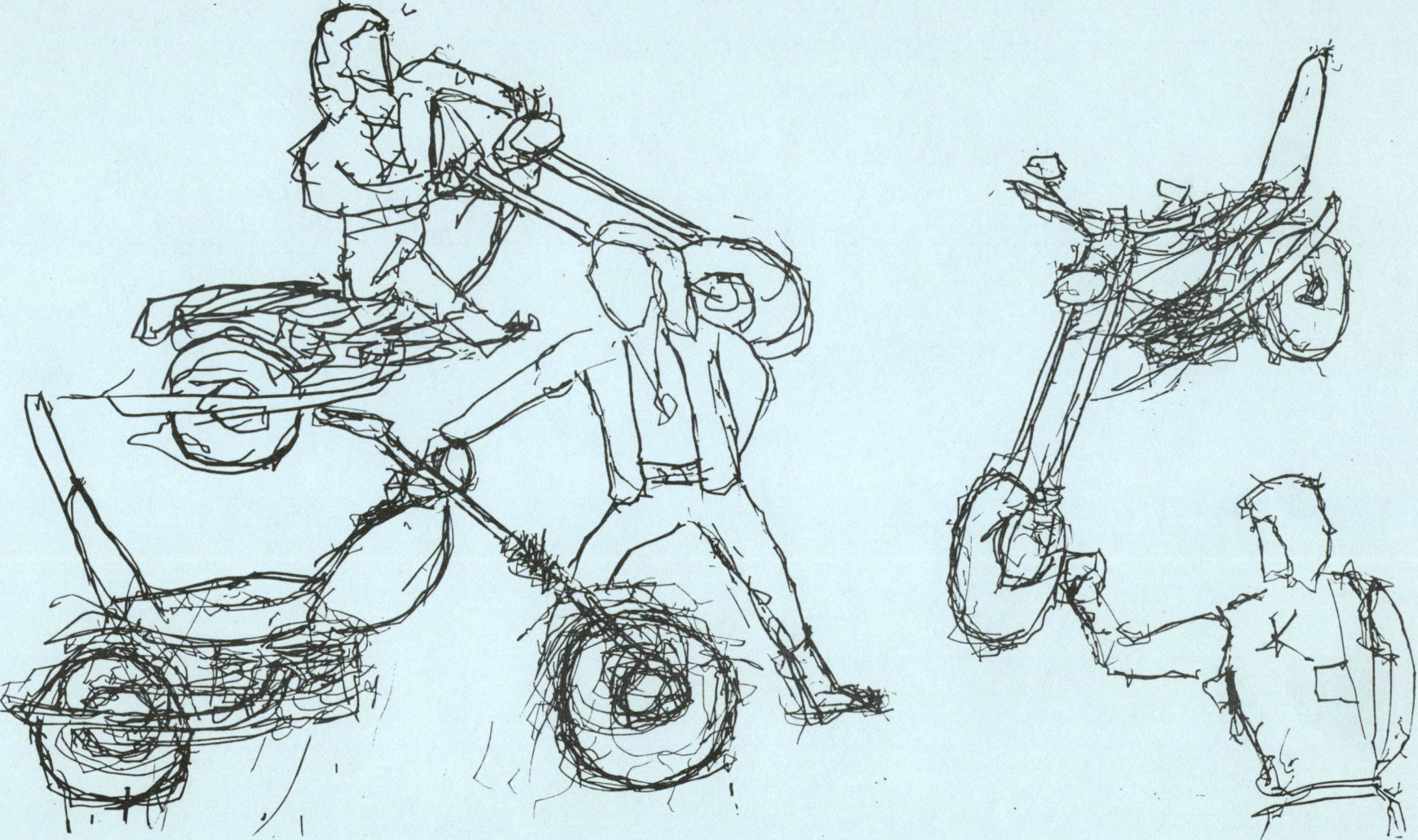

SESSION F

MOBILITY AIDS AND WHEELCHAIR CONTROLS

# AN ELECTRONIC CONTROLLER FOR A POWERED WHEELCHAIR

by

Dudley S. Childress, Ph.D.

Jay M. Kaplan, M.S.

John S. Strysik

Rehabilitation Engineering Program  
Northwestern University Medical School  
Chicago, Illinois

Summary - The design of an electronic controller which converts the E & J, Type 33, electric wheelchair from manipulandum control to pneumatic control or to head or gross hand control is discussed. The modular modification is considered a cost-effective way to interface severely disabled persons with a powered wheelchair.

## Introduction

Traditional control of a powered wheelchair with a manipulandum (joy-stick) is not possible for many severely disabled persons who either lack motor control of the upper limb or who lack limb coordination. Consequently, various types of controls which utilize head movements (including chin motion), breath pressure (sip and puff), tongue movement, voice utterances, humming patterns, eye movements, and gross hand placement have been investigated for use by these persons. Head motion, breath pressure, and gross hand movement appear to have practical advantages over the other approaches.

An electronic controller which converts the E & J, Type 33, powered wheelchair from manipulandum control to pneumatic (breath) control or to head or gross hand control is described in this paper. Most experience with the controller has accrued from persons who have used it with pneumatic input and this input mode is emphasized here. Nevertheless, the system is also adaptable to any arrangement of four switches which can be momentarily activated by gross movements of the head or hand.

## The "modular" concept

The E & J, Type 33, powered wheelchair is readily adaptable to the modular approach. Its own controller, which converts potentiometer inputs into pulse-width modulation of the motor drive currents, is modular. Consequently, it may easily be replaced (only a screwdriver is required) by an alternate electronic controller.

The modular approach is considered cost-effective. A chair can be converted in the field merely by removing the existing control panel and substituting the controller described herein. Mod-

## Acknowledgement

This project was supported by Rehabilitation Services Administration Grant 23P55898.

ification requires only a few minutes. Also, the existing chair is of proven reliability and can be purchased at reduced cost by distributors who do not wish the standard control module. The motor drive transistors and control relays of the Type 33 chair are not altered in the modification process and are used with the new controller.

The picture shown in figure 1 illustrates the modular modification of the Type 33 chair. The electronic controllers, attached to the back side of the panels, are shown in figure 2.

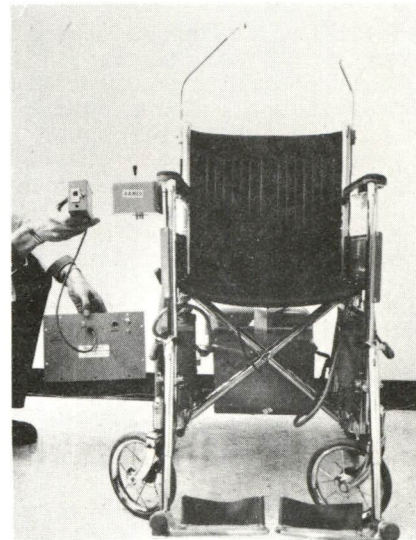

Figure 1. Replacement controller

## General description of operation

The power unit of the "33" chair contains four relays, two for each permanent magnet drive motor. One relay in each set controls the polarity of the motor voltage and this determines the direction of motor rotation. The second relay turns the motor "on" and "off". Drive transistors are in series with each motor-relay combination and these control armature current by pulse-width modulation (400 Hz.).

## N.U. POWERED CHAIR CONTROLLER

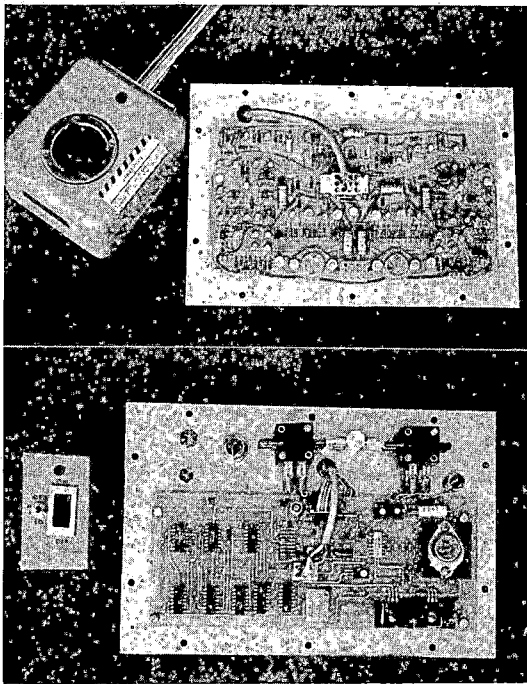

Figure 2. (A) Manipulandum and standard electronic control circuit for "33" chair, (B) Control box and replacement controller

The controller described here is shown diagrammatically in figure 3. The electronic logic decodes the input signals from the switches and drives the appropriate four relays in the power unit. An acceleration limiter circuit increases the pulse-width of the motor drive currents according to a profile which accelerates the chair at a prescribed rate. This may be adjusted by an external potentiometer. Limiters within the acceleration circuit can be set by an external switch to limit the terminal velocity to which the chair accelerates. Three terminal velocities are possible; low, medium and high.

Acceleration limiting, discussed later in more detail, is important in wheelchair control systems for severely disabled persons. These people frequently have poor control of body position and this may make rapid starts and stops hazardous for them. Separate wheelchair acceleration control devices are available but the incorporation of acceleration limiting as a permanent part of the system has several advantages. (1) It assures that all users will have acceleration limiting available, without separate purchase. (2) Appearance is improved by elimination of the need for a separate package. (3) The limiter may be designed to match the "33" chair only and does not need to be "universal".

(A)

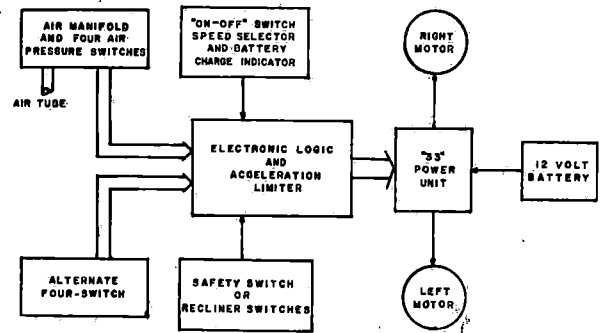

Figure 3. Diagram of controller

### Specifics of control function

For purposes of description let it be assumed that relay #1 turns the motor on the right wheel "on" and "off". Relay #3 controls the direction of motor rotation so that the right wheel may be driven to produce forward motion if #3 is energized and backward if #3 is not energized. The left wheel is driven in a similar manner with relay #2 turning the motor "on" and "off" and relay #4 controlling direction of motion (forward if #4 energized, backward if #4 not energized).

With pneumatic control four pressure switches are used having activation pressures of 10 in. H<sub>2</sub>O (hard puff), 0.5 in. H<sub>2</sub>O (soft puff), 6.5 in. H<sub>2</sub>O (soft sip, and 15 in. H<sub>2</sub>O (hard sip). A momentary puff above 10 in. H<sub>2</sub>O activates the hard puff (HP) switch which turns a "forward" flip-flop "on", initiating energization of all four relays. This produces forward progression of the chair with a controlled acceleration. A momentary hard sip, 15 in. of H<sub>2</sub>O below atmospheric pressure, activates the hard sip (HS) switch and this resets the flip-flops. From the stationary state activation of the HS switch activates the "backward" flip-flop. Relays #1 and #2 are activated and the chair goes into reverse. A hard puff stops the chair. Activation of HS or HP also activates the soft sip (SS) and soft puff (SP) switches respectively. However, activation of HP nullifies the effect of SP and likewise HS nullifies the effect of SS. A soft puff turns the chair to the right and a soft sip turns the chair to the left by activation of both motors in opposite directions. Turns, while the chair is advancing, are made with the same control action but the turn is accomplished by shutting one motor off and pivoting on the wheel it normally drives. The operating states are shown in figure 4 for the various conditions of the chair. A "one" indicates energization of the relay while "zero" indicates no energization. The logic to accomplish this is straight forward and not described here.

A safety switch resets the flip-flops and removes voltage from the drive relays. The system may be reset with a hard puff. Normally this switch is mounted where it can be reached by head movement. When head motion is used to operate a powered recliner mechanism the two switches employed to activate the recliner can also serve as safety switches. This secondary method of stopping the chair protects against possible electronic failure in the controller or loss of ability to initiate inputs.

Quiescent current for the controller is 66 ma. when the chair is stationary. Under driving condition the controller current is 121 ma.

		RELAY				
		#1	#2	#3	#4	
Switch	HP	1	1	1	1	Forward progression of chair
	SP	1	1	0	1	Right turn on center of chair
	SS	1	1	1	0	Left turn on center of chair
	HS	1	1	0	0	Backward progression of chair
(a) CHAIR STATIONARY						
		RELAY				
		#1	#2	#3	#4	
Switch	HP	1	1	1	1	Continued progression forward
	SP	0	1	1	1	Pivot on rt. wheel(rt. turn)
	SS	1	0	1	1	Pivot on left wheel(left turn)
	HS	0	0	0	0	Stops chair
(b) CHAIR PROGRESSING FORWARD						
		RELAY				
		#1	#2	#3	#4	
Switch	HP	0	0	0	0	Stops chair
	SP	0	1	0	0	Pivot on rt. wheel
	SS	1	0	0	0	Pivot on left wheel
	HS	1	1	1	1	Continued progression backward
(c) CHAIR PROGRESSING BACKWARD						

Figure 4. Drive relay states for various switch inputs and chair states. HP and HS may be momentary. SS and SP must be held for continued turning.

#### Acceleration limiting

As already mentioned the manner in which the chair accelerates is very important. Ideally the acceleration should be based upon actual movement of the chair (i.e. rotation on the wheels). This would give the system uniform starting characteristics on all floor surfaces. This approach is not cost-effective at the present time but should be considered in future designs.

Acceleration limiting was accomplished by controlling the width of the motor drive pulses. It was considered advantageous for this width to increase smoothly, with the rate of increase being initially low. The circuit finally selected is shown in figure 5.

The left part of the circuit is a sawtooth generator. Adjustment of  $R_{23}$  (not shown) sets  $I$ , the current source. This determines the frequency of the sawtooth. If the sawtooth output, as seen by the comparator, exceeds the threshold voltage reference determined by  $R_{24}$  the comparator turns "on". Positive feedback through an RC filter causes the output pulses to increase in width in a "bootstrap" fashion. The pulses increase until full saturation is achieved or until the feedback voltage limitation is reached. The value of the voltage limit determines the final pulse width and final chair speed. Each time the chair stops capacitor  $C_4$  is reset and held at zero voltage.

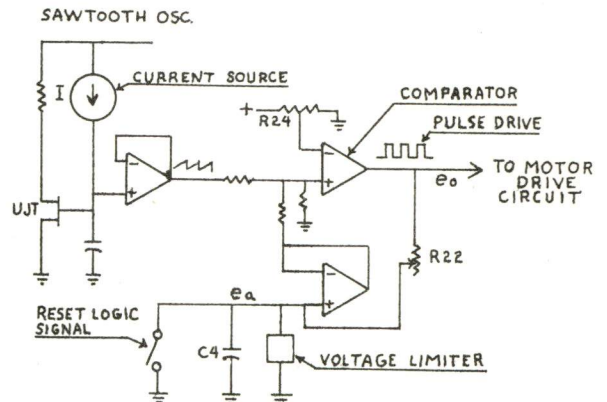

Figure 5. Diagram, acceleration limiter circuit

The positive feedback system requires an initial output upon which to get started. This requirement is commensurate with the need for initial motor torque to break the chair away from its static position. With an average-weight person and the chair on a hard surface, the pulse drive needs to be "on" approximately 22% of the time to initiate chair movement.  $R_{24}$  is set so the starting torque is appropriate for the person's weight, wheel type and normal driving surface.

The positive feedback circuit may be simply analyzed if one assumes the pulse-width output may be modeled by an analog signal having a value equal to the mean value of the pulsed signal. This is a valid assumption if the time-constant ( $R_{22}C_4$ ) is very long compared with the period of the pulses. The average value of the drive voltage is defined as:

$$\bar{e}_d(t) = E + \bar{e}_o(t) \quad E = \text{average of initial output}$$

$$\bar{e}_d(s) = E/s + \bar{e}_o(s)$$

$$\text{Now } \bar{e}_o(s) = K\bar{e}_d(s)$$

$$\text{And } \bar{e}_d(s) = \{E/s + \bar{e}_o(s)\} \cdot 1/(1 + RCs)$$

$$\text{Solving for } \bar{e}_o(s)$$

$$\bar{e}_o(s) = \left\{ 1/s [s + (1-K)/RC] \right\} KE/RC$$

If  $K = 1$ ,  $\bar{e}_o(t) = t(E/RC) \quad 0 \leq t \leq T_1$

$T_1$  = Time of saturation of pulse drive

If  $K \neq 1$ ,  $\bar{e}_o(t) = \left\{ 1 - \text{EXP}^{-(K-1)t/RC} \right\} KE/(1-K)$

Typically  $K = 2.7$ ,  $RC = 6.8$ ,  $E = 2.0\text{v}$

Then  $\bar{e}_d(t) = 2.0 - 3.18(1 - \text{EXP}^{-0.25t})$

$\bar{e}_d(T_1) = 9.0\text{v}$  at saturation

Therefore,  $T_1 = 4.64$  sec. (acceleration time) This agrees with measured values.

$K$  can be set for various voltage profiles. If  $K=1$ , the pulse width will increase in a linear fashion. If  $K>1$  the increase will be according to a positive exponential. A positive exponential was considered desirable based upon subjective tests.

### Powered recliner

Severely disabled persons who use a powered wheelchair experience fatigue from sitting for long periods of time. Pressure on body tissue may be excessive as well. Provision for powered reclining permits the person to independently recline for rest. It also shifts the pressure distribution on the body and this may help prevent tissue damage. Many severely disabled persons who are employed point out that it would be impossible for them to work all day without the aid of a reclining chair. It is also interesting to note that a recliner permits body motion, otherwise restricted, and this is frequently used for gesticulation or for relief of mental tension.

The powered reclining mechanism has been integrated with the chair controller. Figure 6 shows the mechanism on a chair. Control of elevation and depression are effected by two switches mounted laterally on each side of the head. Figure 7 illustrates this principle diagrammatically.

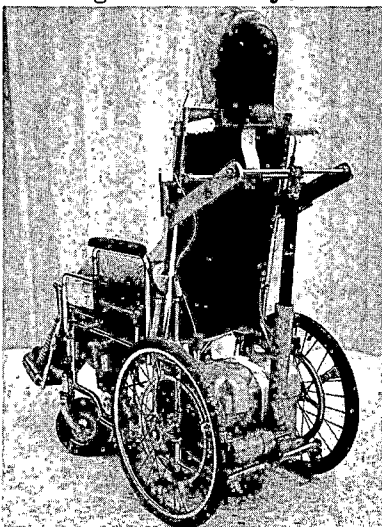

Figure 6. Photograph of recliner unit

### N.U. POWER RECLINER CONTROL

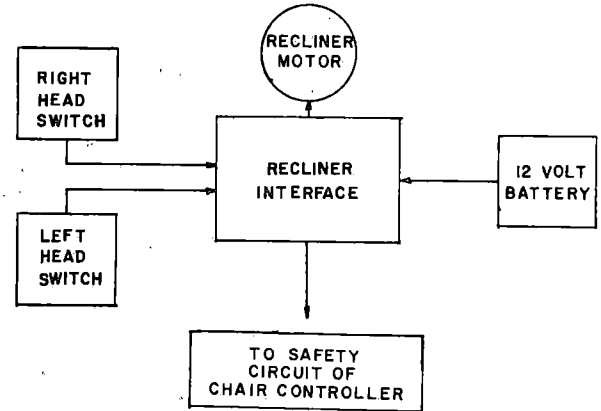

Figure 7. Diagram of recliner control unit

When the switches are not activated they provide a current pathway for the safety circuit. Upon activation of either switch the chair control is deactivated. Consequently, both recliner control switches are also safety switches. This means reclining can only be brought about while the chair is stationary.

The switches may carry inductive starting currents of up to 15 amperes to the reclining motor. To avoid large switches or large and possibly expensive relay interfaces the hybrid drive circuit shown in figure 8 was devised. In this configuration the starting current is handled by the drive transistor. Switch current is low (1 ampere, non-inductive) and voltage impulses which can result because of contact bounce are minimized. The normally-closed contact does handle the full motor current but not under "bounce" conditions. The two switches provide dynamic braking of the recliner motor and a bounce condition exists when the switch turns "off". However, the dynamic braking current is much less than starting current and arcing is minimal.

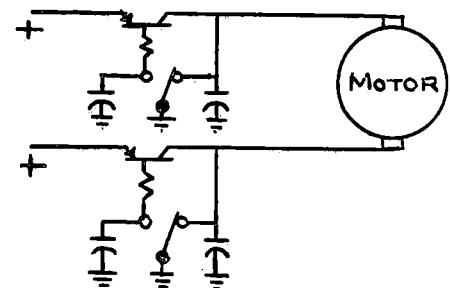

Figure 8. Diagram of recliner motor interface

### Clinical results

Two severely disabled persons have been using the system described for six months. Preliminary results have been excellent and wider use of this controller is anticipated.

AN OCULAR CONTROL DEVICE  
FOR USE BY THE SEVERELY HANDICAPPED

.by

George Rinard, Ph.D.  
Donald Rugg, Ph.D.  
Research Engineers  
Electronics Division  
Denver Research Institute  
University of Denver

Summary

A transducer designed to monitor eye position and produce coherent signals for control purposes has been developed. The method of eye tracking which has been selected is detection of the corneal reflection of an infrared source. The infrared optical transducer is mounted on regular eyeglasses, but does not interfere with normal vision. Possible applications of the ocular transducer, including the control of a proportionally powered wheelchair, are discussed.

Introduction

Ocular transducers, which sense eye position relative to the head, and produce output signals which are related to the horizontal and vertical position of the eye have been investigated as a possible source of control signals for use by the severely handicapped. For at least ten years, using eye position has been discussed as a means of control. Schwartz [1] made a preliminary evaluation of the equipment available in 1968. An attempt to develop an eye position control for wheelchairs was made by Hayes [2] prior to 1972. Since the concept of controlling devices by eye motion is not new, a brief review of some methods of sensing eye position will be described [3].

One method of sensing eye position is called electro-oculography. The position of the eye is determined by placing skin electrodes around the eye and measuring potential differences between electrodes. Although both horizontal and vertical eye motions can be detected, there is cross coupling between the two axes of motion. A preliminary evaluation of electro-oculography was made, but it was not considered a practical method of deriving control signals for the handicapped. The major problems were cross coupling between the axis of motion, the use of skin electrodes and maintaining good contact for an extended period of time, plus muscle action potential artifacts and external electrical interference.

Another method of sensing eye position is tracking the iris-sclera boundary, or limbus, to determine horizontal position and tracking the eyelid to determine the vertical position. The entire unit is mounted on eyeglasses and senses eye position relative to the head. The eyes are illuminated by infrared light emitting diode (LED) sources. The limbus can be tracked by measuring the gross difference in reflection from the iris and sclera by photodetectors located adjacent to the sources. The eyelid is tracked by detecting the difference in reflec-

ted infrared illumination as its position, relative to the photodetector, changes. The detection of horizontal eye movements is limited by the eyelids obscuring the limbus, and vertical movement detection is limited by the effects of horizontal eye position upon the eyelid tracking photodetector.

Hayes eye position control for wheelchairs, which used limbus and eyelid tracking, was considered inadequate for general patient use because users could not master the required eye motions. The initial ocular transducer developed at the University of Denver also determined eye position by tracking the iris-sclera boundaries and the eyelid. Three infrared LED's and three photodetectors were mounted on eyeglasses out of the user's field of view. The LED's were modulated to minimize the effects of external light sources.

In the evaluation of the limbus-eyelid tracking transducer in its initial application as a control for a proportionally powered wheelchair, the following were determined:

- 1) The eyeglass mounted transducer functioned reasonably well when properly adjusted to the individual user but the transducer was easily put out of adjustment by small movements of the user.
- 2) Adjustment of the three light emitting diode (LED) sources and the three photo-diode sensors was a time consuming procedure.
- 3) Although the electrical interference between horizontal and vertical channels was minimized, the separation of signals due to horizontal and vertical eye motions remained a major problem.

To correct these problems, the transducer was redesigned to sense eye position by corneal

reflections. New technology, in the form of miniature image sensing devices has made this method of sensing eye position practical. The cornea approximates a spherical section over about 25 degrees of the eye. As with a convex mirror, reflection of a bright object from the surface forms a virtual image behind the surface which can be detected by forming an image of the eye. Since the radius of curvature of the cornea is less than that of the eye, the corneal reflection moves in the direction of the eye movement relative to the head. The corneal reflection moves about half as far as the pupil. The range of the reflection is limited by the size of the cornea and interference of the eyelids.

The eyeglass mounted image sensing device has also made another method of sensing eye position possible. This method, which is pupil tracking, has advantages over limbus tracking because the pupil is smaller than the iris and not obscured by the eyelid for a larger range of motion.



Figure 1. Eyeglasses with Optics to Monitor Eye Position



Figure 2. Ocular Transducer on User

The ocular transducer configuration which uses corneal reflection to determine eye position is shown in Figure 1. The simple design and cosmetically acceptable features of the new transducer are apparent in Figure 2. Initial testing indicates that the major problems of the original transducer, which tracked the limbus and eyelid, have been eliminated. Figure 3 is a sketch of the optical system. The LED emits infrared radiation with wavelength 0.93 micrometer. The infrared or hot mirror is in the position normally occupied by the prescription lens of the eyeglasses. In this unit a flat hot mirror was used, however, a regular prescription lens can be coated to produce hot mirror qualities. The hot mirror is essentially transparent to all light in the spectral response of the human eye and normal vision is not impaired. At the same time it is a good mirror in the spectral range of the light emitting diode source. Thus, the eye is illuminated by the infrared source reflecting from the hot mirror. Since the hot mirror also serves to reduce the infrared reaching the eye from external sources, the total infrared radiation is less than that which would normally reach the unprotected eye from natural sources. The image sensor array detects an image of the eye via another reflection from the hot mirror. This image array consists of a 32 x 32 matrix or a total of 1024 individual light sensing elements. This provides an extremely large amount of information compared with a total of three light sensing elements in the limbus-eyelid tracking configuration. The combined spectral responses of the visible light absorbing filter and the hot mirror reduces the light radiation from external sources that reach the image sensor.

The image sensor is a single integrated circuit approximately 1/8" square and 0.015" thick as shown in Figure 4. It is mounted on a header that fits inside a 0.28" O.D. tube approximately 1/2" long. Figure 5 shows the header before image sensor is mounted, image sensor, tube, filter and lens.

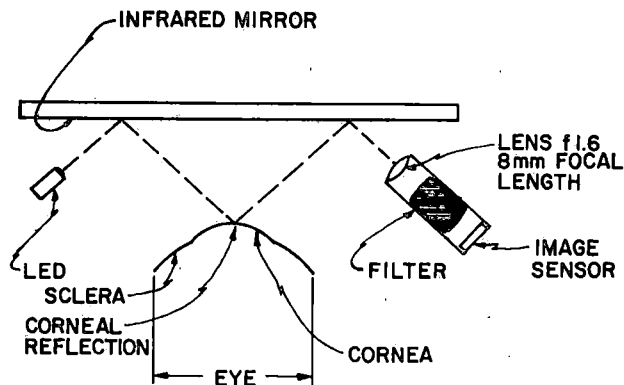

Figure 3. Sketch of Optics Used in Ocular Transducer.

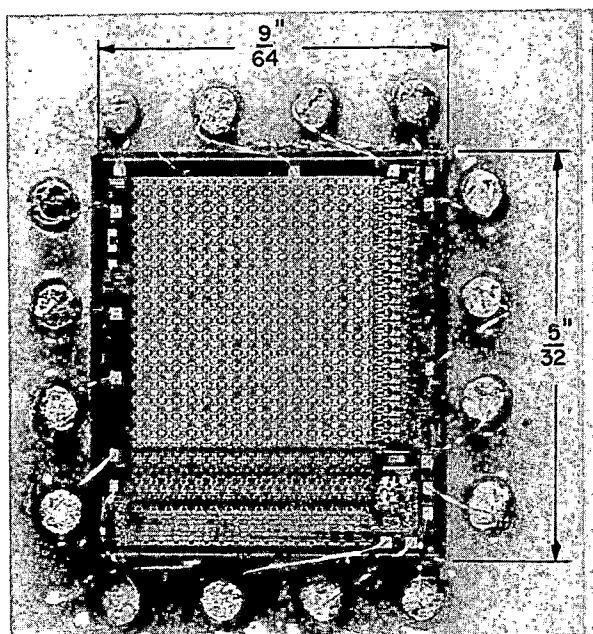

Figure 4. Image Sensor

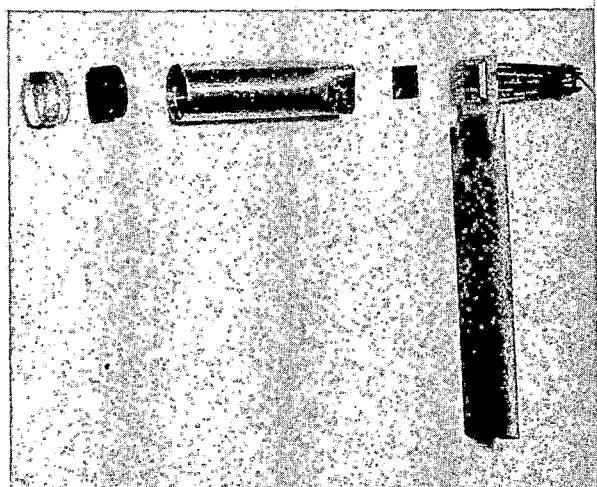

Figure 5. Components of Image Sensor Unit

Figure 6 shows the output of the 32 x 32 element array of the image sensor displayed on an oscilloscope, when supplementary illumination is used on the eye. The iris, pupil and corneal reflection of the LED are apparent in the oscilloscope display. This makes adjustment of the transducer to an individual a straightforward process. Without the additional illumination, only the corneal reflection of the LED appears in the output of the image sensor as shown in Figure 7. This bright spot, which moves at about half the rate of motion of the pupil, is used to determine eye position.

Control signals are produced which are proportional to the eye position above, below, right or left of the central gaze position. The vertical and horizontal addresses of the illuminated elements determine the relative eye position. Since the image sensor signal is processed digitally, high accuracy can be attained.

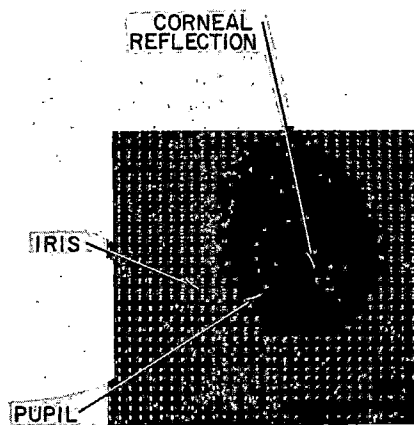

Figure 6.  
Image of Iris, Pupil and  
Infrared Corneal Reflection



Figure 7. Image of Corneal Reflection

#### Use of Ocular Transducer for Control of Wheelchair

The operation of an electrically powered wheelchair requires six states of control signals. The six states are the forward, reverse, right and left proportional control signals plus the off and on control.

The digital signals from the image sensor array are converted to analog signals which are interfaced to the proportional control unit of an Everest and Jennings powered wheelchair. To change from normal operation to ocular control the cable from the proportional control unit is disconnected from the "joy stick" box and connected to the box containing the ocular transducer circuitry. Although the wheelchair stops when the eyes are in the central gaze position, additional signals for off-on are required. A momentary contact oral pressure switch (sip for on) is being used. Other methods such as head operated switches, eye blinks or other eye motions are being considered. At the present time, the most practical type of off-on control has not been determined.

The initial testing of the ocular transducer for wheelchair control is being made by non-handicapped individuals in order to identify and correct technical problems. The evaluation of the ocular controlled wheelchair by high level quadriplegics will start in the near future. Two aspects of the evaluation are of interest. The

most important aspect is to determine if eye motion is an acceptable means of device control for the high level quadriplegic. The second aspect is to determine if the ocular transducer is a practical means of wheelchair control for some of the severely handicapped.

#### Concluding Remarks

The initial application of the ocular transducer has been for wheelchair control. When the present system is proved successful in providing useful control signals for patients with no arm motion and limited head motion, then the control of other devices such as powered upper extremity orthotics will be attempted. The objective of this work is to provide the high level quadriplegic the maximum volitional control of equipment which will enable the individual to become less dependent on others in the performance of many activities. Although problems still exist in deriving control signals from eye position, recent technological advances may at last make the development of a practical ocular control device possible.

#### References

- [1] Schwartz, J.T., Control System for an Upper Extremity Orthotic Device, Master Degree Thesis, University of Denver, Denver, Colo., April 1968.
- [2] Bulletin of Prosthetics Research, Spring 1972.
- [3] Report of the Conference on Visual Information Processing Research and Technology, National Institute of Education, Columbia, Md., June 1974.

## AUTOMOTIVE CONTROLS FOR THE HANDICAPPED

by

Anton J. Reichenberger  
Project Manager, Component Development  
Bioengineering Research Service  
VA Prosthetics Center, New York, N.Y.

The "state of the art" of available adaptive automotive equipment is examined to define minimally acceptable levels of safety, quality, and performance. An overview of the recently developed VA standard for adaptive automotive equipment is presented, and some examples are given of the continuing VA effort to provide the severely handicapped with increased mobility.

Handicapped drivers operate motor vehicles for reasons similar to non-handicapped drivers, they want to drive because they need to drive. For many handicapped individuals the availability of adequate mobility makes the difference between doing and not doing. The current standard for adaptive automotive control systems resulted through earlier Congressional legislation, when the Veterans Administration was asked to develop a workable document applicable to the wide range of adaptive automotive equipment used by its many beneficiaries. The current VA document, i.e., VA Standard Design and Test Criteria For Safety and Quality of Special Automotive Driving Aids (Adaptive Equipment) For Standard Passenger Automobiles, clearly defines minimally acceptable levels of safety, quality, and performance. It also provides general guidance to adaptive equipment manufacturers and installers. Currently there are fifteen (15) adaptive automotive equipment manufacturers selling devices in compliance with the requirements set forth in VA document VAPC-A-7505-8, i.e.:

1. Blatnik Precision Controls, Inc.  
1523 Cota Avenue  
Long Beach, California 90813  
(213) 436-3275
  2. Drive-Master Corp.  
61 North Mountain Avenue  
Montclair, New Jersey  
(201) 744-1998
  3. Ferguson Auto Service  
1112 North Sheppard Street  
Richmond, Virginia 23230  
(804) 358-0800
  4. Gresham Driving Aids  
P.O. Box 405  
Wixom, Michigan 48096  
(313) 624-1533
  5. Handicaps, Inc.  
4345 South Santa Fe Drive  
Englewood, Colorado 80110  
(303) 781-2062
  6. Hughes Hand Driving Controls, Inc.  
Tevis Bridge Road  
Lexington, Missouri 64067  
(816) 259-3681
  7. Kroepke Kontrols, Inc.  
104 Hawkins Street  
Bronx, New York 10464  
(212) 885-1547
  8. Manufacturing & Production Services  
2932 National Avenue  
San Diego, California 92113  
(714) 292-1423
  9. Moss Inc.  
Star Route Box 42  
Elizabeth, Colorado 80107  
(303) 646-4096
  10. Nelson Products  
5690-A Sarah Avenue  
Sarasota, Florida 33577  
(813) 924-2058
  11. Smith's Hand Control  
1472 Brookhaven Drive  
Southaven, Mississippi 38671  
(901) 743-5959
  12. Thompson Hand Control  
4333 N.W. 30th Street  
Oklahoma City, Oklahoma 73112  
(405) 946-9517
  13. Trujillo Industries  
5726 W. Washington Blvd.  
Los Angeles, California 90016  
(213) 933-7469
- (MANUFACTURERS STEERING ASSISTS ONLY)
14. Wells-Engberg Co.  
P.O. Box 6388  
Rockford, Illinois 61125  
(815) 874-6400
  15. Wright-Way Inc.  
P.O. Box 907  
Garland, Texas 75040  
(214) 278-2676

## Conventional hand-control systems

Commercially available hand-control systems generally consist of mechanical linkages, a control handle, and associated hardware. With the exception of mechanical advantage, no form of power augmentation is provided for any of these devices, leaving it to the judgement of the handicapped driver to determine the usefulness of a particular hand-control system. Often an experienced driver-training instructor can be extremely helpful in guiding a driver-student in the selection of optimum equipment.

We classify currently available adaptive hand-control systems into three types, i.e., push-pull, push-right angle pull, and the push-twist type.

### 1. Push-Pull Type Control System (Fig. 1)

Actuation of the brakes requires a force applied to the control handle in the direction away from the driver and parallel to the steering column, whereas the accelerator pedal is operated by pulling the control handle toward the driver.

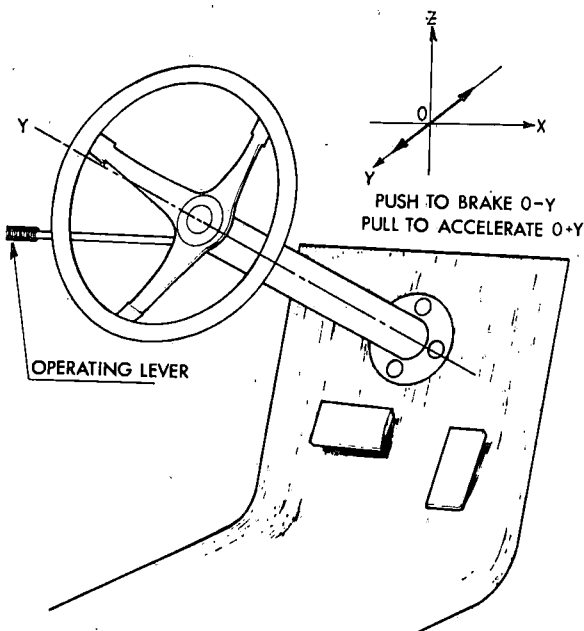

Fig. 1 Push-pull type control system

### 2. Push-Right Angle Pull Type Control System (Fig. 2)

The brakes are actuated in the same manner as the first type, but the accelerator pedal is operated by pulling the control handle towards the driver's lap.

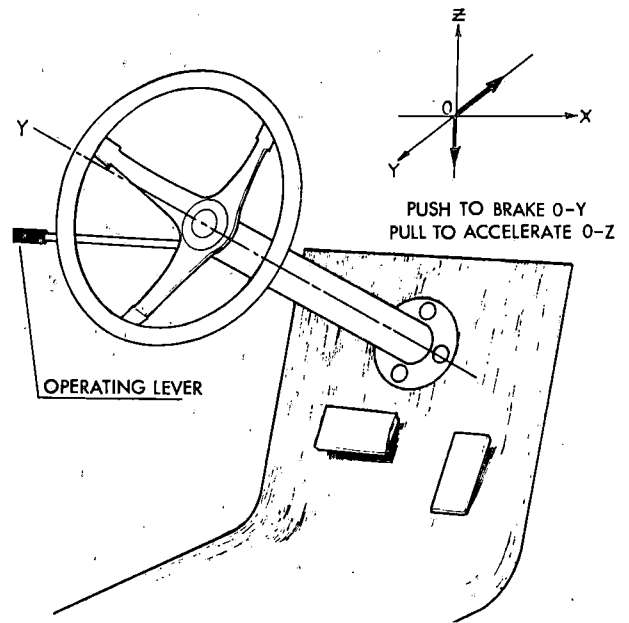

Fig. 2 Push-right angle pull type control system

### 3. Push-Twist Type Control System (Fig. 3)

Again, the brakes are actuated in the same manner as the first type, however, operation of the accelerator is achieved by twisting the control handle (similar to a motorcycle throttle).

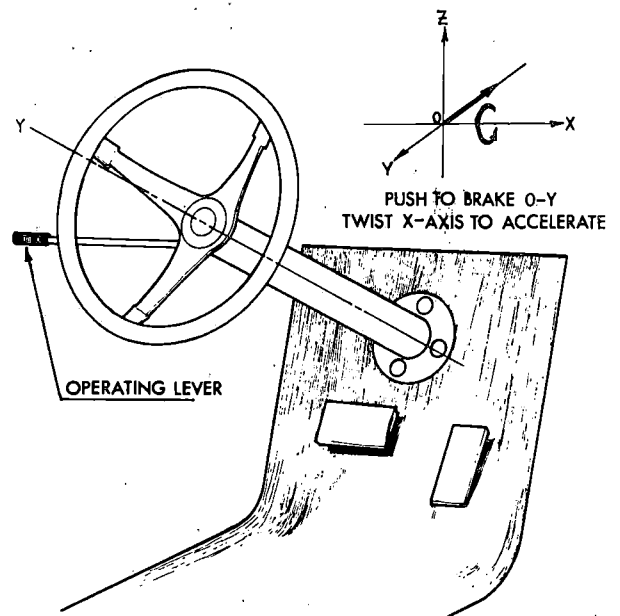

Fig. 3 Push-twist type control system

Without an attempt to present the actual version of the current VA standard here, there are a number of key questions related to the general level of acceptability of all adaptive automotive hand-control systems.

1. Are driving aids within reach of handicapped driver when lap and shoulder belts are securely fastened?
2. Are there reflective surfaces on the installed equipment that tend to reflect sunlight into the driver's eyes?
3. Are there sharp edges or projections on the equipment that might cause undue injury in the event of impact?
4. Does any part of the equipment deform permanently when it is used in simulating normal driving conditions?
5. Is rust or corrosion found on any part of the assembled and installed equipment?
6. Are all fasteners used in assembly and installation of the driving aid securely tightened?
7. Are all electrical components safe from accidental shock, short circuit, sparks, etc.?
8. Does the installation permit conventional use of the vehicle by normal drivers?
9. If the installed driving aid is a brake and accelerator hand-control system, does it remain in the neutral position in the hands-off mode?
10. Are the motions required to actuate brake and accelerator controls distinctly different?
11. Can the accelerator be actuated by applying a force in the direction forward and away from the driver?
12. Has the driving aid manufacturer provided adequate instructions to permit proper installation of the equipment to the motor vehicle?
13. Does the installed equipment interfere with the collapsible feature of the automotive steering column?
14. Did the source of the driving aid provide instructions on its proper use in the motor vehicle?
15. Did the installation of the driving aid result in unnecessary modifications of the vehicle?
16. Was the driving aid inspected for quality and proper functioning by the manufacturer?

17. Is a statement of warranty included in the purchase of the driving aid?

There are a number of steering assists for handicapped drivers with nearly normal strength and mobility of the upper extremities, but requiring some assistance in steering the motor vehicle. The devices shown in fig. 4 can be simply adapted to most any standard-sized automotive steering wheel.

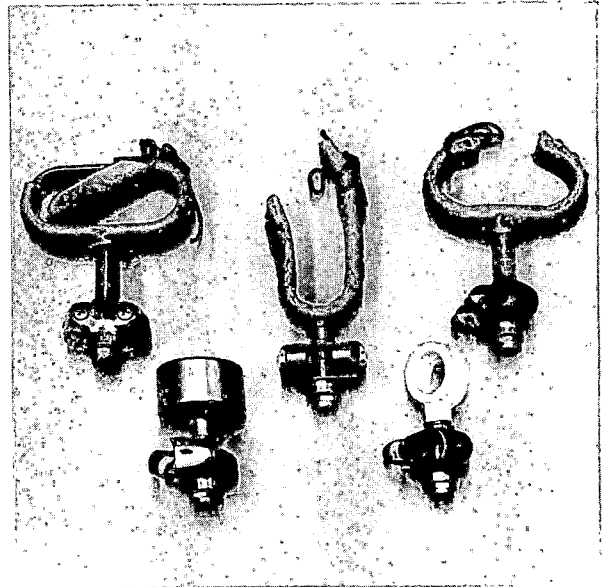

Fig. 4 Assortment of steering assists

Many severely handicapped individuals unable to work with purely mechanical systems could probably be trained to become self-sufficient motor vehicle operators with the aid of power augmented automotive control systems. To this extent, the VA Prosthetics Center is actively involved in the development of a second generation of motor vehicle control systems for the severely handicapped. An example shown in Fig. 5 and 6 is the VAPC Double-Wheel Automotive Hand Control System installed to an ADS-71 Aetna Driver Trainer Simulator for laboratory experimentation. An electrohydraulic servo system controls motor vehicle brakes and accelerator by displacement of the inner control wheel. The driver applies pressure of one or both thumbs to the rim of the brake-accelerator control wheel to inject a command signal for brake actuation, whereas finger pressure of one or both hands in the reverse direction injects the command signal for acceleration. Both the conventional steering wheel and the brake-accelerator control wheel rotate together, making placement of one or both hands in a particular position on the periphery of the double-wheel assembly unimportant.

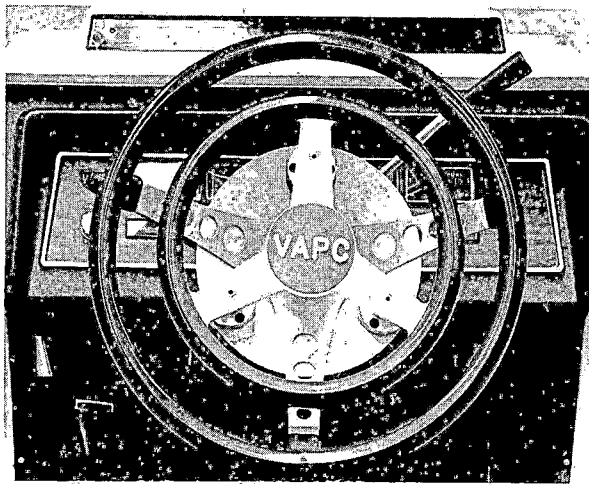

Fig. 5 VAPC double-wheel automotive hand control

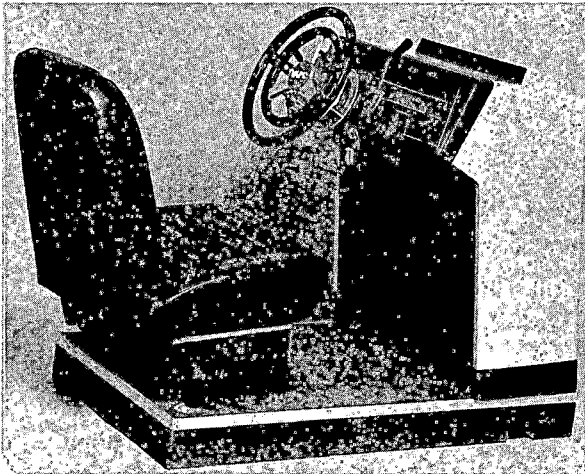

Fig. 6 VAPC double-wheel automotive hand control installed to a ADS-71 driver-trainer simulator

#### Vans for the handicapped

Modifications of van-type vehicles are usually made to give access to handicapped individuals without the usual wheelchair transfer. Powered wheelchair lifts operate at either the right side or the rear doors of the van. They all use an electric motor as either a direct source of power for the lift or as a source of power for a hydraulic pump, which is in turn used to power the lift. There are also some lift configurations for operation by an attendant, simply providing a device for transferring wheelchair-bound individuals in and out of the van. When the van is to be operated independently by a handicapped driver,

additional equipment is required for opening and closing doors, controlling the operation of the lift, positioning and securing the wheelchair in the van, etc.. The VA Prosthetics Center is currently evaluating a variety of van configurations for the development of standards for powered wheelchair lifts, and consequently other special systems associated with the operation of van-type vehicles by the handicapped. To indicate some of the basic differences in a variety of current van modifications, three (3) commercially available vehicles are shown. The van in fig. 7 is equipped with a side-loading wheelchair entry-exit system, automatic opening and closing of sliding right-side door, and hand controls. Although a Chevrolet Sportsvan was used for this particular adaption, some other standardized vans can be modified to meet individual preferences. The vehicle shown in Fig. 8 utilizes the automotive right-side door as a means of wheelchair entry and exit. Once the driver has entered the van, transfer is made to a specially designed driver chair that provides some adjustments to bring the driver into the desired position. The driver chair fastens to the automotive structure, protecting the driver against problems arising through sudden inertial changes of the motor vehicles. To operate both vehicles shown in Fig. 7 and 8, the handicapped driver must have enough upper-limb strength and mobility to work with conventional mechanical hand-control systems.

The van shown in Fig. 9 is under evaluation for drivers unable to control a motor vehicle with the variety of purely mechanical hand-control systems currently available. The Ford Econoline 100 Super Van is equipped with a rear-loading lift, a special wheelchair (Fig. 10), and a specially designed control system (Fig. 11). The standard automotive steering mechanism and brake-accelerator control systems were removed from the vehicle and replaced by a hydraulic servo-system to permit operation in a joystick-like manner. The magnitude of forces required to actuate brakes or accelerator is in the order of a few ounces, whereas steering can be controlled with limited wrist motion of either the right or left hand. A touch type of pushbutton control module places all required functions of automobile driving within easy reach of the handicapped driver, such as starting and stopping the engine, gear selection, signal lights, opening and closing rear doors, operation of wheelchair lift, and opening and closing windows.



Fig. 7 Chevrolet Sportsvan, equipped with side-loading wheelchair lift (Helper Industries, Ft. Lauderdale, Florida)

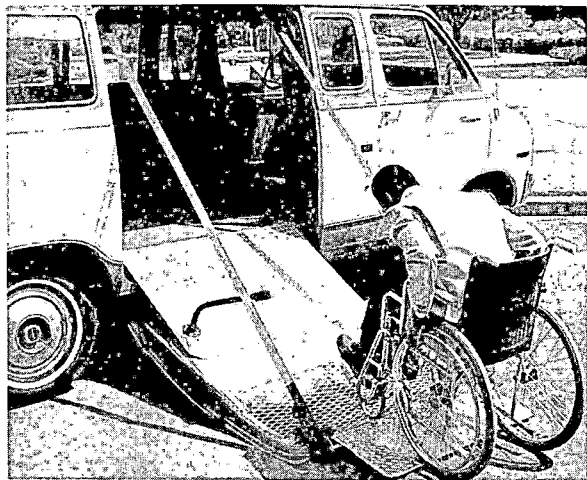

Fig. 8 Dodge Sportsman van, including integral wheelchair entry-exit system (Royce International, Englewood, Colorado)

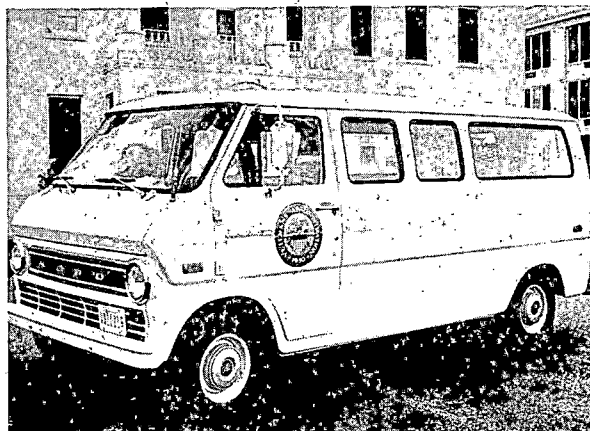

Fig. 9 Scott van (Mobility Engineering & Development Inc. Van Nuys, Calif.)

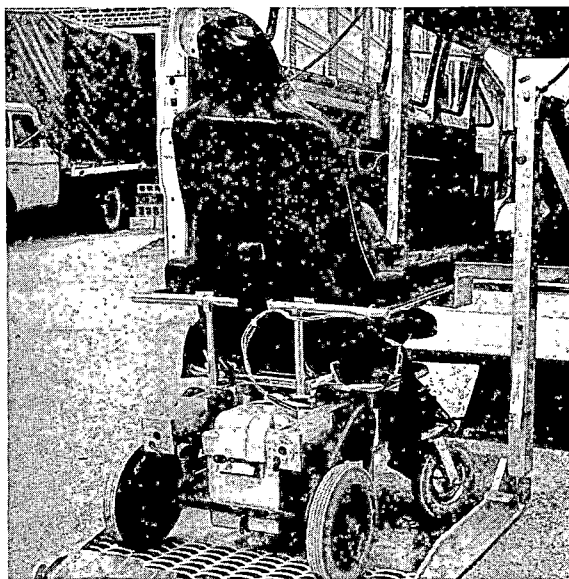

Fig. 10 Scott van, special wheelchair and rear-loading entry-exit system

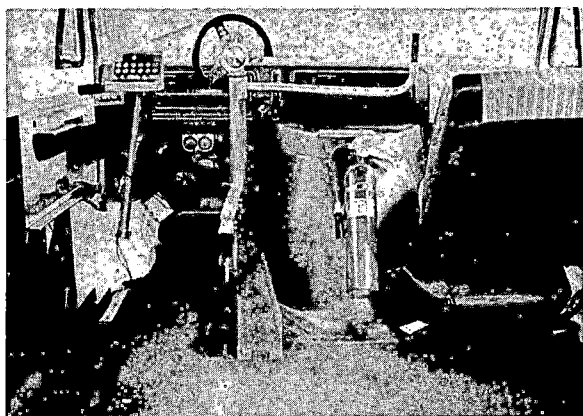

Fig. 11 Scott van, view of specially designed control system

Future expectations are to develop and implement standards and specifications for adaptive automotive systems that protect the handicapped in the same manner the non-handicapped are protected by Federal Motor Vehicle Safety Standards (FMVSS). At the present, Federal Motor Vehicle Safety Standards do not apply to vehicle modifications that occur after the original sale.

#### REFERENCES

1. VA Standard Design and Test Criteria for Safety and Quality of Special Automotive Driving Aids (Adaptive Equipment) for Standard Passenger Automobiles, VAPC-A-7505-8, U.S. Veterans Administration
2. Reichenberger A., and Newell P.: Adaptive devices for automobiles, Chapter 28, Atlas of Orthotics, Mosby Co. (1976)
3. Reichenberger A.: Licensed motor vehicles for handicapped drivers, Krusen Center for Research and Engineering, Temple University, Philadelphia, Pa. (April 1975)

A PROPORTIONAL-SPEED BREATH OPERATED MOTORIZED WHEELCHAIR  
CONTROL FOR QUADRIPLEGIC AND OTHER SEVERELY DISABLED PATIENTS

M. Youdin, M.E.E.  
H. Louie  
G. H. Sell, M.D.

Institute of Rehabilitation Medicine  
New York University Medical Center  
New York, New York 10016

Summary

The results of an extensive evaluation program indicate that quadriplegic patients with high level lesions prefer pneumatic (breath operated) systems for powered wheelchairs to all others. Proportional speed one and two tube breath operated controls which can be used without rewiring on standard motorized wheelchairs are described. Since many of the quadriplegics are college students, a breath controlled cassette dictator-transcriber which operates from the chair battery through an inverter is also described.

+++

We have been greatly concerned with the problem of providing means of locomotion for quadriplegic patients with relatively high-level spinal cord lesions. Most of our quadriplegic patients have been 15-20 year old students who, after hospitalization, have returned to the schooling interrupted by their injury. After an extensive evaluation of the many experimental and commercially available control systems for powered wheelchairs, we have found that these patients prefer pneumatic controls to all of the others.

Tongue switches are inconvenient to manipulate; sight switches are affected by changes in ambient lighting; chin controls are difficult to maintain in proper position relative to the chin; and even breath (pneumatic) controls are not usable if the patient must continuously maintain pressure in the air tube or if there are too many air tubes required for control.

We have, therefore, concentrated on the development of a single tube breath control which can be attached to a commonly used electric wheelchair (such as the E&J Model 34) without rewiring. This has been accomplished utilizing four Fairchild ultra low pressure sensors, a solid state logic system, and a system of power relays. The pressure sensors are actuated either by positive pressure (puff) or by negative pressure (sip), and are preset at the factory at nominal actuation pressures of 3, 4, 6, 8, 10, 12 inches of water  $\pm$  20%. We utilize two different positive pressures and two different negative pressures. Our control system operates in the following manner: A high level (6-10 inches of H<sub>2</sub>O) positive pres-



Figure 1. The IRM/NYU Proportional Speed Breath Operated Motorized Wheelchair

sure pulse causes the chair to move in the forward direction; a similar negative pulse causes the chair to move in the backward direction. Forward or backward motion cease upon application of an additional positive pressure pulse. A sustained low level (3-4 inches H<sub>2</sub>O) positive pressure causes the chair to turn to the right; a similar negative pressure causes the chair to turn to the left. An instantaneous stop occurs when the patient presses his head lightly against a momentary contact switch mounted at head level from an adjustable gooseneck tube. This switch interrupts all power to the motors and resets the entire control system.

There are available pressure sensors that are adjustable over a wide pressure range. However, we have found that it is best to determine the optimum pressure levels and pressure differences for each patient, and to utilize fixed pres-

sure sensors.

In our system both wheelchair motors are operated in parallel from a single power relay. Continuous steering is accomplished by weak sustained positive or negative pressures while the chair is in forward or backward motion. Two fixed speeds are available depending on whether the motors are operated from 6 volts or 12 volts. This selection is made from a manually operated toggle switch and is not part of the breath control.

We have built and evaluated 10 prototype units and they have provided continuous, safe, reliable and trouble-free operation. We have not found it necessary to match the right and left wheel motor speeds. It should also be pointed out that the pneumatic control system is compatible with the manual joy-stick control provided by E&J. When equipped with our pneumatic controls, our hospital chairs can be used in either mode.

Since these chairs are utilized by students in travelling to and from classes they are used to cross streets and negotiate sloping walks. It is, therefore, important to have a pneumatic control which will permit operation over the entire speed range. We have been able to extend the previously described control system to accomplish this and a prototype chair embodying the proportional control is shown in Figure 1. A schematic diagram of the proportional control system is shown in Figure 2.

In this prototype we have, for convenience, changed from an E&J Model 34 chair which utilizes wound field motors to a Model 33 chair which has permanent magnet motors. Both motors are operated from a single 12V. nominal, 90 ampere DC motor speed control (Model M32 manufactured by Power Technology, Inc., of Little Rock, Arkansas, 72204). The output of this unit is controlled from a motor driven potentiometer which is in turn controlled from two Fairchild pressure sensors. In this particular prototype the proportional control feature has been incorporated into a separate tube - see right side of chair in Figure 1. A velocity indicator (a meter indicating the power setting of the motor speed control-right arm of chair in Figure 1) has also been provided to enable the patient to always know the speed setting. Thus, the speed can be adjusted before starting or after the chair has "locked" into forward or backward motion. Increased velocity is accomplished by applying a sustained positive pressure; decreased velocity by application of negative pressure. The potentiometer motor is a Globe Model C5A-1103, 2AVDC, 15 RPM permanent magnet reversible gearhead motor. It is possible to accelerate from low to high speed (or decelerate from high to low speed) in 4 seconds.

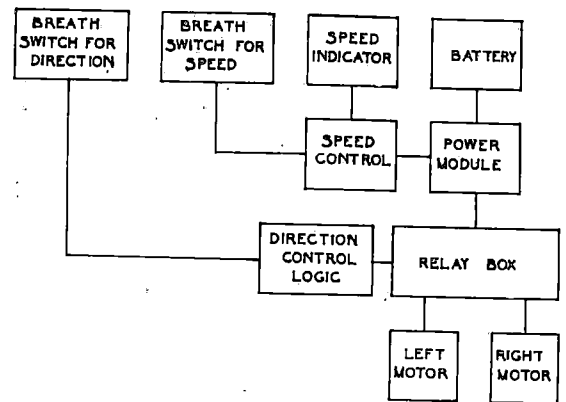

FIGURE 2. Schematic Diagram of Breath Operated Controls for Proportional Speed Motorized Chair.

This prototype chair has by now been evaluated by a number of patients, and they have found it to perform in a very satisfactory manner. The tendency is always to drive the chair at near maximum speed and they soon become aware that steering and slowing prior to stopping require a more conscious effort than that required of a paraplegic who, utilizing a drive stick, steers and slows down almost unconsciously.

By combining the proportional speed feature into a single tube with the direction control it will be necessary for the patient to produce three distinctly different forward pressures and three distinctly different negative pressures. Although patient evaluation of this chair is not completed, the preference appears to be for two separate tubes. On this prototype unit it seemed desirable to match the two motor speeds. This was accomplished through the use of a small resistor in series with the armature of the faster motor.

One of the peripheral devices which would be of great value to a quadriplegic student is a tape recorder that can be taken to class to record lectures. An inexpensive cassette dictator-transcriber whose principal functions are solenoid operated is now available (Model 2706A Dictator-Transcriber manufactured by Craig Corp., Compton, Cal. 90220). This unit, shown on the lap board in Figure 1, is an all solid state device requiring a 120V, 50/60 hertz, 20 watt supply. In order to operate the tape recorder from the wheelchair battery, we have added a small inverter (Model 12DME, manufactured by ATR Mfg. Co., St. Paul, Minnesota, 55101). Utilizing the previously described pressure sensors we have reduced the ON-OFF functions to one tube; the PLAY and REWIND to another; and RECORD to a third. The three stem breath control for the tape recorder is seen on the left side of the chair in Figure 1. We are

now designing a scanning system that will permit all of these functions to be combined into a single tube system. (Further development of tape recorders is described in another paper from this Institute.

This work was supported by RSA Grant No. 16-P-56801/2-15, "Rehabilitation Research and Training Center" RT-1 from the Rehabilitation Services Administration, Department of Health, Education, and Welfare, Washington, D.C.

# MASS TRANSPORTATION FOR THE PHYSICALLY DISABLED AND ELDERLY

## MYTH, DAYDREAM OR IMPENDING REALITY

### SUMMARY

This paper reports the attitudes that make mass transportation for all appear to be a myth, a daydream or a reality.

Recent projects completed by the Franklin Institute under Grant No. PA 06-0031 for the Urban Mass Transportation Administration are discussed. A classification scheme for stations, a classification scheme for vertical circulation devices and a technique for comparing hardware solutions are detailed. The schemes are designed for computer storage and analysis.

The subject of mass transportation for the physically disabled and elderly has occupied *center stage* in recent years when it comes to talking about what is *going to happen*. We have advanced this far because lobbyists have become vocal, Congress has acknowledged the problem and politicians have constructed strong planks in their platforms with the issue. A number of studies have been funded, including a few by this author; but I need not ask how many wheelchair users came to this conference by subway today.

I'm sure we all have our preconceived notions about why mass transportation remains virtually inaccessible to the physically disabled and elderly. As we talk to one another, some of us mutter, "No one is really interested in doing a damn thing—they don't want to spend the money nor the effort necessary to solve the problems." If this viewpoint is true, then indeed, Mass Transportation for the physically disabled and elderly is a MYTH.

Other comments I've heard over the past few years go something like "Sure, I'm in favor of providing transportation for everyone but lets be realistic, you can't get an iron lung on a bus." If this viewpoint is true, then indeed, mass transportation for the physically disabled and elderly is a DAYDREAM.

The third general comment I hear from time to time goes something like "I know there are technological and psychological problems, but we have short range and long range alternatives, lets do what we can as soon as we can". If this thought materializes into fact then mass transportation for the physically disabled and elderly is indeed, an IMPENDING REALITY.

This paper reports the results of two studies conducted by the Franklin Institute Research Laboratories for the Urban Mass Transportation Administration, Department of Transportation. I will discuss what the real problems are which must be solved to transform *efforts to date into reality*. I will also discuss the array of possible solutions and what techniques are most applicable. Interspersed with these discussions will be general comments from various special interest individuals which reflect the lingering prejudices which still stand in the path of progress.

I do not pretend that the comments I will discuss were the result of a scientific study nor do I accuse a particular group of a general attitude. On the contrary, the comments reflect

my personal interpretations of real concerns. Their validity; that is whether or not they are justifiable, is irrelevant. For example, racial prejudices are not justifiable, yet they continue to stand in the way of progress.

First, the real problems facing integrated mass transportation service for all. By real problems, I mean those very basic problems which, if unresolved, will continue to hamper full service no matter what other efforts are put forth. They are:

- Crash worthiness of wheelchairs
- Vertical circulation in terminals
- Affect on service
- Retrofit of existing facilities
- External accessibility

#### Crash Worthy Wheelchairs

In general, passenger seats in all mass transportation systems meet very stringent structural integrity problems. The typical wheelchair does not. In fact, I have heard reports that an occupied wheelchair, subjected to typical accelerations and decelerations encountered on urban subway trains would collapse as a result of their spokes "popping" out if the wheels of the chair were oriented perpendicular to the direction of motion. Clearly the answer is not transferral of the wheelchair user to a passenger seat. This would require an attendant to help transfer the patron from his wheelchair to the seat (and vice versa), an intricate seat belt system to secure the rider, no matter what his disability might be, and an unoccupied wheelchair to store. Obviously, the answer to the problem of wheelchair crashworthiness is the engineering challenge of making the wheelchair itself crash worthy. The lone alternative appears to be to accept the risks of riding in a structurally weak seat. Legislation allowing the wheelchair to be used as a seat may be necessary.

I've also heard comments that wheelchair users shouldn't be allowed on mass transportation because if a breakdown occurred underground, for instance, they would require assistance to escape. I trust the perpetrators of this attitude are not the people I have to rely upon if I am incapacitated during a breakdown. Let us trust that reasonable men will not accept that rationalization but let us also recognize that that attitude does, in fact, exist.

### Vertical Circulation in Terminals

The vertical circulation problem is the problem which probably carried the greatest financial burden. Elevators are a potential answer. However, they are expensive, relatively slow and subject to vandalism. Escalators and stairs are an excellent solution for the able bodied. Obviously, the disabled need an engineering device to allow them to ride an escalator, an escalator that can carry their wheelchair or a device that can either negotiate stairs or carry the wheelchair and occupant over the stairs. Vertical circulation is strictly an engineering challenge.

What guidelines should the developer follow in evaluating potential solutions to the vertical circulation problem? First, classify all stations for comparison and analysis purposes. A viable classification scheme is as follows:

*Table 1  
(See attached)*

Next, classify all devices for comparison and analysis purposes. A viable classification scheme for this purpose is as follows:

*Table 2  
(See attached)*

Next rate the particular device against the "ideal" device. A viable scheme for this purpose is as follows:

*Table 3  
(See attached)*

The result is a method designed for computer assistant analysis and selection of optimum solutions for specific problems. One system may not be the best alternative for all applications. The proposed method also allows a comprehensive cost analysis.

### Affect of Service

What will be the affect on service of accommodating the physically disabled? Adverse affects include forcing the rolling stock to wait longer at stations, dwell time, eliminating seats aboard the rolling stock to provide room for wheelchairs and interfering with the able bodied while travelling through the stations.

Positive affects include making the system more easily accessible and safer for all. In most cases, provisions for people with physical impairments are helpful to the able bodied as well.

Imaginative engineering approaches could eliminate possible adverse affects through planning and such engineering solutions as fold down seats to be used when no wheelchairs are aboard and vertical circulation devices which utilize the same passageways as the able bodied in a unobstrusive manner.

### Retrofit

Most people agree that before new systems go to the drawing boards, special accommodations

are feasible. But we cannot adequately retrofit existing stations because of special problems like rights of way for emplacement of elevators, limited potentials for space utilization (such as underground power cables and sewer lines in the path) and private ownership of land tracts. Yes, retrofitting is a special problem. However, with the classification scheme I have mentioned and a similar scheme to classify the problem, we can more readily fit a solution to a specific problem. In some cases, a hybrid transportation scheme could provide a reasonable solution.

### External Accessibility

Some authorities have been known to mutter "Lets assume our system is totally accessible. How are they to get to our station and where are they going at the end of the ride?" Clearly, this is not a justification for not providing mass transportation facilities. External accessibility is a problem for architects to provide accessibility in all buildings and physical structures. External accessibility is a problem for you and I to provide consumer demands wherever and whenever we have an opportunity.

Mass transportation for all need not be a MYTH. Mass transportation for all need not be a DAYDREAM. Continued efforts can and must make mass transportation a REALITY.

Table 1. Classification System for Stations

GRADE LEVEL	ELEVATED	0	GENERAL STATION CLASSIFICATION
	AT GRADE	1	
	SUBWAY	2	
OWNERSHIP (ABOVE/BELOW) TRACKS	PUBLIC	0	
	PRIVATE	1	
	TRANSIT Co.	2	
OWNERSHIP AT ENTRANCES	PUBLIC	0	
	PRIVATE	1	
	TRANSIT Co.	2	
CONSTRUCTION	STEEL STRUCTURE	0	
	CONCRETE STRUCTURE	1	
	OTHER STRUCTURE	2	
DEPTH/HEIGHT	LESS THAN 10 ft.	0	
	GREATER THAN 10 ft. BUT LESS THAN 30	1	
	GREATER THAN 30 ft. BUT LESS THAN 50	2	
	GREATER THAN 50 ft. BUT LESS THAN 75	3	
	GREATER THAN 75 ft. BUT LESS THAN 100	4	
	GREATER THAN 100 ft.	5	
CONSTRUCTION DIFFICULTIES	WATER	0	
	UTILITY LINES	1	
	ROCK	2	
	OTHER	3	
	NONE	4	
FARE COLLECTION	AT STREET	0	
	AT MEZZANINE	1	
	AT PLATFORM	2	
	ON BOARD	3	
	OTHER	4	
ENTRANCES FROM STREET	1	0	
	2	1	
	3	2	
	4	3	
	MORE THAN 4	4	
PLATFORM ACCESS	DIRECT FROM STREET	0	CLASSIFICATION OF INDIVIDUAL PLATFORMS
	MEZZANINE	1	
ENTRANCES TO PLATFORM	1	0	
	2	1	
	3	2	
	4	3	
	MORE THAN 4	4	
PLATFORM TYPE	SIDE	0	
	ISLAND	1	
	PIGGYBACK	2	
	OTHER	3	
TYPE OF INTRA PLATFORM ACCESS	OVERHEAD BRIDGE/MEZZANINE	0	
	SEPERATE ENTRANCE	1	
	UNDER WALKWAY/MEZZANINE	2	

Table 2. Classification System for Vertical Circulation Devices

Ownership	Transit Authority	0
	User	1
	Both	2
User	All Except Wheelchairs	0
	All	1
	All H&E	2
	Wheelchair Only	3
	All H&E Except Wheelchair	4
Direction of Travel	Up Only	0
	Down Only	1
	One Device Travels Up & Down	2
	Two Devices Required for Up & Down	3
Operation	Attendant Required	0
	H&E Operable	1
	Fully Automatic	2
Mode	Continuous	0
	Discrete	1
Power	On Board Power	0
	External Power	1
	User Power	2
	Manual	3
Entrance	Existing	0
	New	1
Availability of Entrance	Dedicated	0
	Temporarily Dedicated	1
	Shared	1
Availability of Device	Dedicated	0
	Temporarily Dedicated	1
	Shared	2
Construction	Remove Existing Steps	0
	Modify Steps	1
	Does Not Involve Steps	2

	Elevator	Escalator	Ramp	Steps	Moving Belt Ramp	Shaftless Elevator	Vertical W/Chair Elevator	Inclined Stairway W/Chair Elevator	Chair Lift	Stairclimbing W/Chair
Vertical Circulation Shared with Able-Bodied	hatched	hatched	hatched	hatched	hatched	hatched	hatched	hatched	hatched	hatched
Accommodate All Types Of H&E	hatched	hatched	hatched	hatched	hatched	hatched	hatched	hatched	hatched	hatched
Serves All H&E Equally Well	hatched	hatched	hatched	hatched	hatched	hatched	hatched	hatched	hatched	hatched
No Inconvenience To Able-Bodied	hatched	hatched	hatched	hatched	hatched	hatched	hatched	hatched	hatched	hatched
Crowd Flow Not Affect Service	hatched	hatched	hatched	hatched	hatched	hatched	hatched	hatched	hatched	hatched
Minimum Standby Time	hatched	hatched	hatched	hatched	hatched	hatched	hatched	hatched	hatched	hatched
Easy To Operate	hatched	hatched	hatched	hatched	hatched	hatched	hatched	hatched	hatched	hatched
Inexpensive To Install Existing	hatched	hatched	hatched	hatched	hatched	hatched	hatched	hatched	hatched	hatched
Inexpensive To Install New	hatched	hatched	hatched	hatched	hatched	hatched	hatched	hatched	hatched	hatched
Safe For All	hatched	hatched	hatched	hatched	hatched	hatched	hatched	hatched	hatched	hatched
100% Reliability	hatched	hatched	hatched	hatched	hatched	hatched	hatched	hatched	hatched	hatched
Operate In All Environments	hatched	hatched	hatched	hatched	hatched	hatched	hatched	hatched	hatched	hatched
Inexpensive To Maintain & Operate	hatched	hatched	hatched	hatched	hatched	hatched	hatched	hatched	hatched	hatched

Table 3. Existing Vertical Circulation Device Vs. The Ideal.

ON THE ROAD AND OUT OF THE MUD  
(A Handicapped Person's Cart)

by  
J.W. Stryker,\* R.M. Glorioso,\*\*  
D.L. Blanchard,\*\* and J. DiGiorgis+

There has been a continuing need for a small, lightweight, reliable means of transportation for the handicapped. While wheelchairs and crutches have the advantages of extreme portability, they restrict the distance a person may travel, especially out of doors. Powered wheelchairs have been a partial answer but they lack ruggedness for extended sidewalk and roadway conditions. Specially adapted automobiles are ideal for medium and long distance driving, but are a problem in urban areas in terms of finding parking spaces. Another problem can be, for those on very limited incomes, the high cost of operating a car. Handicapped person's vans can act as "private transport" door to door, but crutches or a wheelchair must be used beyond the curb. These vans suffer the scheduling problems familiar to public transportation patrons, or the delays familiar to those who telephone for a taxi, only to wait and wait and wait....

We have built a handicapped person's conveyance which combines the advantages of a wheelchair with those of a small electrically powered automobile. It is rugged enough to cope with the New England winter driving extremes (salty and sandy water, rough roadways, and poor traction). It provides the in-building mobility associated with a wheelchair with the comfort of a wheelchair while affording the range and versatility of a small automobile.

Heretofore, a solution to this problem chosen by disabled people who can not use public transportation is to use battery powered golf-carts or industrial in-plant mail delivery vehicles. A golf-cart is not really practical because it is too big, thus it cannot fit through doorways and so be used inside buildings. The smaller in-plant mail or warehouse inspection type of vehicle which can go through doorways is also impractical for adequate year-round indoor/outdoor transportation as these carts were designed for use on a smooth surface. Some of the specific problems encountered using this type of vehicle are: low ground clearance, difficult steering, rough ride, no weather protection, corrosion and abrasion from salt and sand on winter roads, short brake lining life and frequent brake adjustments, limited range due to battery electrical energy capacity, low battery output in winter resulting in slow speed and dim lights, frequency battery recharging, and lack of standard (automotive) fittings resulting in costly repairs with long waits for parts.

The cart which has been constructed and is presently being tested has solved these problems. It is a rugged vehicle, with high ground clearance, good riding characteristics, and an enclosed driver's compartment. It has a 25 mile range and performs well in winter cold. It can be adapted to many types of handicaps with

choices of hand or foot operated controls or any combination desired.

The frame design is one which gives maximum strength and crash protection with a minimum of weight. It is one inch diameter "EMT" (electrical conduit) steel tubing brazed together. It protects the "power cube" equipment, while placing most of the weight of the cart over the rear wheels, giving good traction and easy steering. The roof is high enough to accommodate a tall person (a six footer fits comfortably), and is the location for the running lights, giving good visibility for drivers of following and oncoming automobiles. A DOT triangular "slow moving vehicle sign" is mounted on the rear of the roof. The cart has a six inch ground clearance which enables it to negotiate very rough ground. The steering is by tiller bar to a wheel assembly patterned after that of the BMW motorcycle. Adjustable motorcycle type shock absorber-spring combinations are used on the suspension system. The "skin" is sheet aluminum, fabricated using aircraft techniques. Special attention has been paid to making the underside corrosion and abrasion free by using stainless steel and plywood for covering the frame bottom.

The "power cube" consists of a 24 volt electric motor, planetary differential gearbox and rear axle, two twelve volt automotive batteries, and the control system. The speed control device uses an oscillator driving power transistors. By increasing the frequency and duty cycle of the oscillator, the percentage of time that the transistors are on increases, thereby increasing the power applied to the motor and hence the speed. This gives stepless speed control from stop to medium speed which is especially important when driving the cart on a crowded sidewalk. There is an "over-drive" switch which bypasses the transistors with a relay which gives full power and a top speed on the level of about 11 miles per hour. Automotive drum type hydraulic brakes are used. These have much larger surface than the brakes on the existing carts and the parts are cheap and readily available. They can be serviced by any automotive mechanic. A motorcycle type hand operated master cylinder is mounted on the tiller bar (although a floor mounted foot operated cylinder could be fitted). We are adding an "inboard" disc brake to the planetary differential to determine if this will reduce the maintenance requirements for the drum brakes. The brake lights are operated through a pressure activated switch on the hydraulic line. The parking brake is mechanical. All controls in this vehicle are operable with the right hand although other configurations could be easily made.

The lights consist of a motorcycle headlight mounted to turn with the front wheel, marker or parking lights, emergency flasher, turn signals, and brake lights mounted at the roof.

The original objectives were to:

1. Make a cart that is as light and as small as possible.
2. Have sufficient ground clearance (6-10") so as not to get hung up in snow, rough ground, etc.
3. Be geared so as to have a top speed less.

than 10 miles per hour.

4. Improve the suspension system to obtain a better ride than from the warehouse inspection type cart.
5. Have the ability to be used in all kinds of weather.
6. Make the control mountings adaptable to a variety of handicaps, possibly even to the extent of using a joy stick which could be operated by people who only have full mouth control.
7. Use automotive type brakes since these units are waterproof and should be completely maintenance free on a light cart.
8. Have some sort of emergency warning system operated by a single switch which would cause a light to blink and/or a horn to sound if the operator needed help.
9. To meet all Registry of Motor Vehicles requirements as a "street machine."
10. Have a carrier for crutches and possibly even a folding wheelchair.
11. Increase the operating range by using a small gasoline powered alternator that could be switched on when outdoors. This would provide enough electrical power to run the carts electric motor as well as supplying power to recharge the batteries. (This has been removed from the cart as we found the range of 25 miles did not require frequent charging of the batteries.)

In meeting these objectives we have produced a cart which has been in (more or less) daily use for four years. After a number of bouts of controller failure (due to using "scrounged" parts) the controller has evolved into a highly satisfactory form. It has screwdriver adjustments to compensate for component aging, modular circuit subassemblies, and excellent temperature stability. The battery life using "Die Hard" batteries commercially available is about one year, but the cost is less than the heavy duty batteries used in the in-plant carts. Tire wear is minimal, estimated as ten years before replacement. The major maintenance problems are with grit getting into the brake drums causing excessive wear, and drive belt slippage. Routine maintenance consists of topping up battery water, oiling and greasing fittings, and replacing light bulbs.

We wish to acknowledge the valuable assistance of Mr. J. Terrell of the Geology Shop for his cheerful advice and patience, the Physical Plant staff which so generously donated time and skill, and Messrs. D. Scott and K. Williams of the Mechanical Engineering Shop for their practical expertise. Ms. Marie Desmond has been our patient test driver and source of practical advice.



#### SPECIFICATIONS

- SIZE: 70" long, 30" wide 80" high (including DOT sign)
- FRAME: welded tubular steel (incl. drivers' safety cage), aluminum skin, safety-glass windshield
- SUSPENSION: shock absorbers & coil-spring combination, motorcycle-type front-end, 14" inflated tires
- POWER: 24 volt, 2/3 HP electric motor
- "FUEL": two 12 volt automotive batteries, recharged from "house" current via built-in charger, charge-indicator lamp on dash
- TRANSMISSION: belt-driven, single-speed gear-reducer & planetary gear differential
- BRAKING: hydraulically-actuated automotive service brakes, mechanical parking brake
- CONTROLS: optional configurations for differing disabilities (Cart One has one-hand-only controls), easy "tiller bar" steering, "throttle" by trigger-actuated oscillator, a neutral-forward-reverse switch, service brake lever, ratcheting park-brake lever, key-operated power switch
- ACCESSORIES: windshield wiper, horn, turn signals, brake lights, running lights, headbeam
- LUBRICATION: automotive grease fittings, gear oil in gearbox (all accessible from above)
- WEIGHT: approx. 375 lbs
- SPEED: 12 MPH maximum

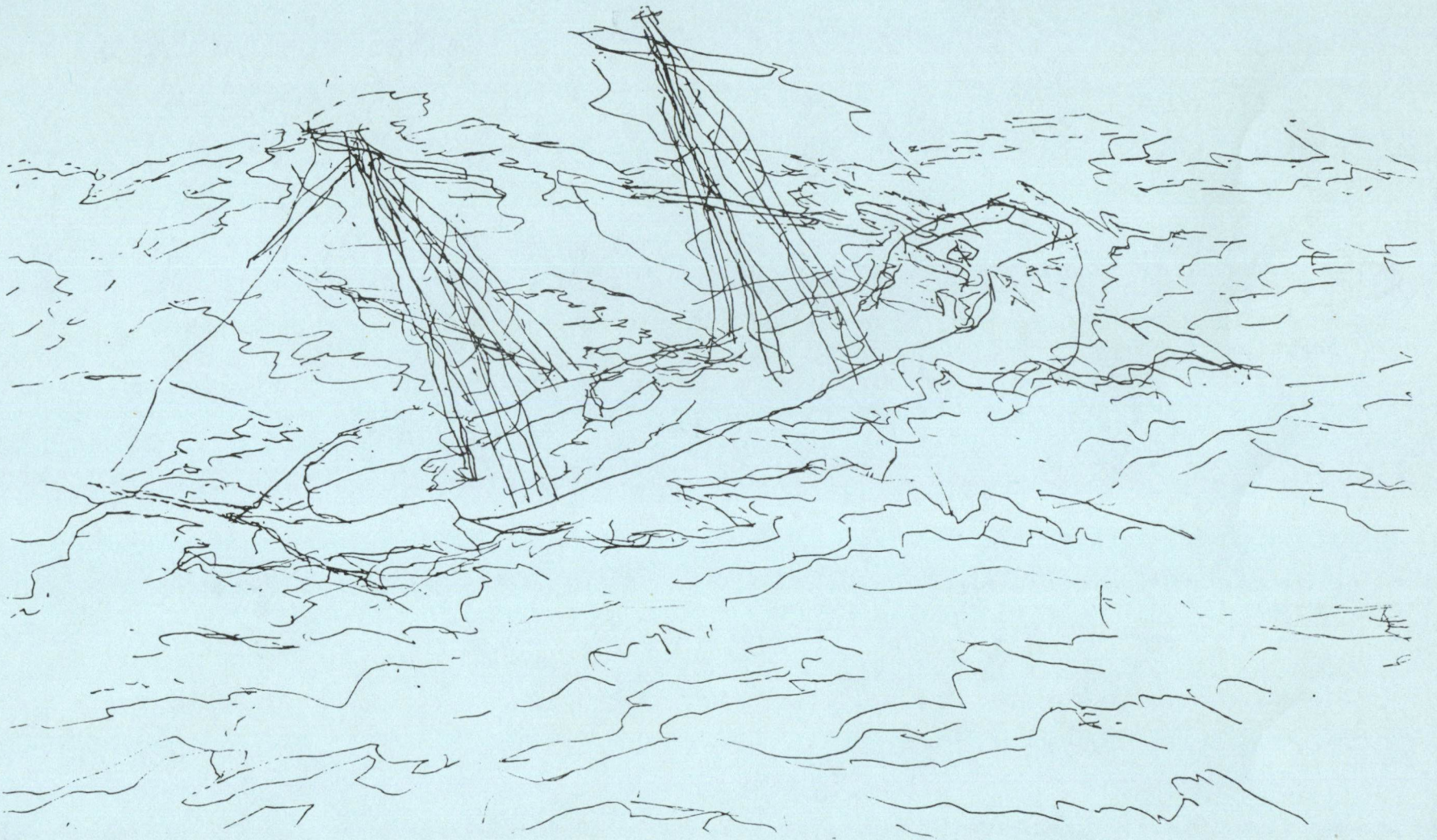

SESSION G

# SENSORY MOTOR MEASUREMENT AND CONTROL

A SINGLE SYSTEM FOR DISPLAYING EMG ACTIVITY DESIGNED FOR THERAPY,  
DOCUMENTATION OF RESULTS AND ANALYSIS OF RESEARCH.

by

Joseph Brudny, M.D.  
Marvin Weisinger  
Gordon Silverman, Ph.D.

ICD Rehabilitation and Research Center, New York City.

**Summary** - The EMG Bioconditioner provides an alternative to inexpensive but inferior "biofeedback devices" as well as to sophisticated but costly laboratory computers. The system is based on digital integration of EMG signals, measuring and recording them in units of microvolt-seconds. Sensory motor learning is enhanced by oscilloscopic display of continuous traces of processed information from one or two EMG channels. Coupling the auditory and oscilloscopic displays allows for operant shaping of motor response. The results of retraining patients with disorders of voluntary movement with aid of this system attest to its therapeutic value.

INTRODUCTION

In the rapidly expanding area of EMG feedback therapy there was need for therapeutic equipment that could enhance sensory motor learning and could allow wider application of such therapy. Feedback, or knowledge of results, represents a most important variable controlling learning and performance. During ontogeny, visual feedback which systematically accompanies self produced movements, is indispensable to the development of certain motor skills. Sensory motor learning is defined as a closed loop system requiring immediate and precise feedback from activity taking place and as being cumulative, non reversible and resulting in establishment of memory records for future performance.<sup>1</sup> Parallels have been drawn between the process of recovery from CNS insult and the process of motor skill acquisition,<sup>2</sup> pointing to the paramount importance of sensory feedback from self produced movement during therapy.

It seems therefore essential for therapeutic EMG equipment to contain, on one hand, features that facilitate optimal sensory motor learning, as determined by physiological research data on the subject, and on the other hand features of computer technology that facilitate information processing and offer logic, memory and versatility of available therapeutic programs.

Such a device, in our opinion, is the EMG Bioconditioner (Figure 1) developed for the clinical study of EMG feedback in treatment of disorders of voluntary movement, presently being conducted in the ICD Rehabilitation and Research Center, New York City.

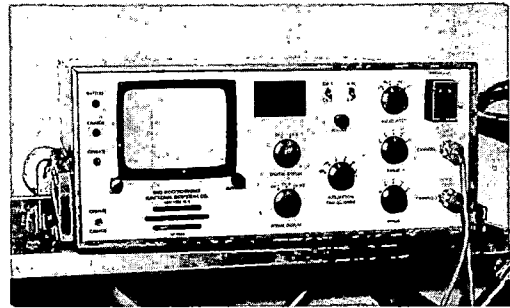

Figure 1

The need for such a device became evident in 1971 when this study was initiated in the Department of Rehabilitation Medicine, NYU-Bellevue Medical Center. The search for adequate therapeutic EMG equipment revealed that none was readily available.

The several "biofeedback devices" that were tested all had drawbacks that made their use objectionable, e.g.

1. Excessive delay in EMG signal display, stemming from various forms of analog integration of EMG (smoothing filters, averaging, etc.)
2. The parameters of visual feedback display were hardly contributing to the development of visually guided motor tasks. The use of a meter to indicate level of EMG activity was too slow, too complex or too inaccurate.



and are coupled to the computer by means of an optoisolator. The subject is thus isolated from the line driven computer, eliminating possible shock hazard.

The pulses coming from the opto isolator are divided in frequency (scaled) in a digital scaler. This allows the data to be scaled so that the displays may be adjusted to meet different environments assuring high resolution over the entire input range. A range switch selects the appropriate pulse train from the digital scaler. These pulses from the scaler are then counted (summed) in the 3 decade digital integrator for a fixed period of time. The resultant count in this digital counter is the integral of the EMG signal (summation being the means of integration). At the end of the fixed interval of time, the contents of the digital integrator are stored and the integrator is reset to make it ready to receive the pulses for the next time interval. The storage buffer at all times stores the integral for the most recent time period. The desired time interval is generated by a time base generator and is selected by the operator. A time epoch of 100 milliseconds is usually selected, although other time bases are also available (25 msec, 50 msec, 200 msec, 1000 msec). The digital data stored in the integrator can be displayed on an LED numerical display. This allows the subject to respond to a numerical measure of an integrated activity. The digital data stored in the integrator buffers are converted to an analog voltage by means of a digital to analog converter element. This permits the integrated data to be displayed on an oscilloscope and allows the signals to be further processed for presentation in a variety of audio modes.

A two-channel oscilloscope is employed. This oscilloscope allows the display of both instantaneous activity and past activity, presenting the patient with a continuous "history" of the mechanical events in the monitored muscle (degree and rate of contraction or relaxation). The scope has 3 selectable electron beam sweep rates with instantaneous retrace. On one channel the scope can display the integrated data of either EMG source. On the other channel a reference line (criterion level) is displayed which can be adjusted to any position on the scope face and is representative of a desired activity level. This permits the "shaping" of motor responses. Additionally, the two channels of the scope can display the activity of both EMG sources (with the loss of the criterion). This mode allows the display of antagonistic or synergistic muscle activity simultaneously with the agonist muscle.

A wide variety of presentations of the integrated activity by audio means is possible. Either channel may be selected to drive audio presentation. This signal can be heard as a series of "clicks" when the click rate is proportional to the amplitude of the signal. Click rates from 1/2 to 40 pps (pulses per second) are used from zero to full scale (frequency modulation or FM mode). The selected channel can also be used to modulate the intensity of a tone (a sinusoid of approxi-

mately 1 KHz). The sound thus produced is a tone whose intensity varies with the amplitude of the signal. (Amplitude modulation or AM).

In addition, two other modes are possible. A Schmitt trigger circuit is used to compare relative amplitudes of the reference and the integrated EMG signal from either one of the channels; it produces two signals. One signal is produced when the channel information exceeds the reference. The resultant presentation to the subject is silence until the integrated activity exceeds criterion. At that point tone is heard (AM) or the clicks will be heard (FM). This mode is called INCREASE (INC), and is used to shape responses when little integrated activity is present initially in the monitored muscle. The second signal produced by the Schmitt trigger acts exactly opposite to the one just described. It will occur only when the integrated activity is less than the reference. This mode, called DECREASE (DEC) is used to shape responses when much integrated activity is present initially in the monitored muscle.

The digital count stored in the buffers of the integrators can be used to drive digital computers where more elaborate studies are desired, can also be recorded on magnetic tape or they can be used to record the results on a digital printer, yielding a measure of integrated activity in microvolt seconds of rectified EMG signal. The analog equivalents of the digital numbers stored in the buffers are available to be recorded on polygraphs, magnetic tape or other graphic recorders

The digital printer provides data every second either automatically or on command. Time of recording, mode of operation, reaching and/or exceeding the desired threshold and data in microvolt seconds are digitally printed on a strip chart (see Figure 3).

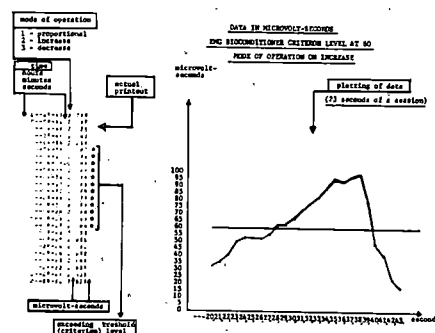

Figure 3

The same data can be plotted graphically as seen to the right of the actual strip chart segment.

For the printers only, average of the integrated microvolt seconds is computed and printed once per second. That is, the activity in each time epoch is summed across epochs and

divided by the number of epochs in one second. Thus, for a 100 msec epoch the ten integrations are summed and divided by ten - for a 200 msec epoch five integrations are summed and divided by five, etc.

#### PROCEDURE

As an example of procedure, the treatment of a hemiparetic-spastic arm is presented in detail. A similar approach with necessary modifications based on kinesiology of a particular functional movement is applied to treatment of other areas.

The basic approach is the analysis of deficient functions and setting of goals for simple tasks performed by the primary movers. The paretic muscles are trained for increase of voluntary contraction, strength and speed of contraction. The spastic or spasmodic muscles are trained for voluntary decrease of undesired activity during movement or stretch and also for speed of relaxation.

The patient sits erect in a chair facing EMG Bioconditioner placed at eye level approximately 4 feet away. Position of the affected limb is at the patient's side, free of support.

The surface electrodes are attached to the biceps muscle in a standardized manner (recording electrodes placed over the mid-point of the muscle belly and the tendinous distal end, the ground electrode over the middle portion of the inner surface of the forearm).

The technique of muscle contraction and muscle relaxation is first demonstrated on the contralateral biceps brachii muscle, so the patient may understand the relation between oscillographic and auditory signals and corresponding mechanical events in the monitored muscle; contraction and relaxation. (see Figure 4)

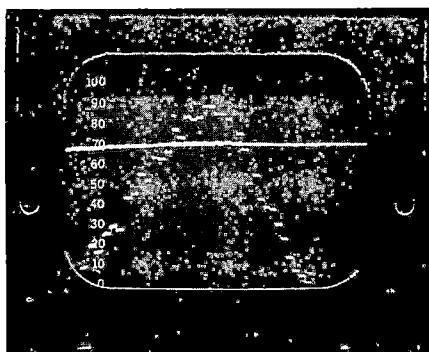

Figure 4

Initially the auditory feedback signal is set on "proportional" mode with frequency modulation output (clicks) to allow the patient to relate the changes in auditory signal (increase in rate of clicks) to the changes in the amplitude of the oscillographic trace (vertical displacement). (see Figure 5)



Figure 5

Both reflect muscle contraction (degree and rate). Conversely the decreasing rate of clicks and lower amplitude of the oscillographic traces (vertical displacement) are observed during muscle relaxation.

Once the patient understands the relationship between the state of muscle activity (contraction, relaxation) and the oscillographic and auditory displays, the "shaping" technique is introduced: A voltage reference line representing the therapeutic oscillographic goals is introduced (threshold line) and placed 2-3 mm above the trace line representing maximal contraction effort of the patient. (see Figure 6)

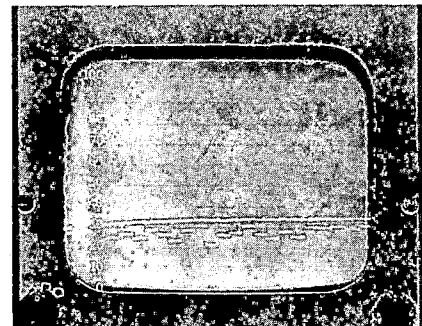

Figure 6

The auditory feedback signal is set on "increased" mode so that a tone will be emitted, as a reward, should the patient be able to reach the oscillographic goal by increased effort of contracting the muscle. (see Figure 7)

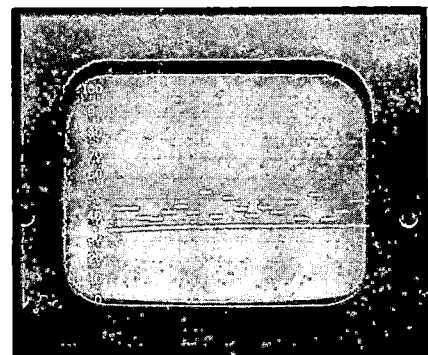

Figure 7

In the beginning of the treatment, the sensitivity range (calibration) of oscilloscopic display is set usually at the lower selectable levels and then changed accordingly with the patient's progressive increase of performance, making the completion of the oscilloscopic task more difficult on successive sessions. Thus, in training the patient for an increased degree and rate of muscle contraction, a positive reinforcement technique is used (presence of sound).

Spasticity of the biceps which is induced by application of intermittently sustained stretch, by gravity or the contraction of the antagonist muscle is treated with a negative reinforcement technique (absence of sound). The auditory feedback signal is set on "increased" mode and a shaping paradigm is employed for decreasing the electrical activity of the muscle. This is done so that the oscilloscope trace reflecting electrical activity will be displaced downward, below the reference line and at this point rewarded by absence of sound. The patient is instructed to keep sound off, while the challenge to the monitored muscle persists (stretch by therapist or use of antagonistic muscle).

As the patient decreases the electrical activity of the muscle, the threshold line is gradually lowered by the therapist to maintain negative reinforcement (absence of sound) at lower levels of myoelectric activity. This "shaping" is continued over 6 to 12 sessions until the patient can maintain as low levels of myoelectric activity as physiologically possible.

In some patients a positive reinforcing shaping paradigm is more effective i.e., auditory feedback signal set on "decrease." When the oscilloscopic trace reflecting the myoelectric activity of the monitored muscle is displaced voluntarily downward below the reference line, a reward signal (tone) will be sounded and will persist as long as the patient maintains the decreased level of myoelectric activity.

The choice of shaping paradigm is decided upon jointly by the therapist and the patient after a trial series.

Initially, the patient's effort is directed toward minimal volitional changes of the audiovisual displays of integrated EMG activity derived from a functionally deficient muscle. Such changes are accomplished by maintaining a sustained state of voluntary contraction or voluntary relaxation of the muscle for 10 to 20 seconds. In the next stage of training emphasis is placed on alternating the voluntary contraction and the voluntary relaxation of the trained muscle in increasingly shorter time periods. Following this, the actual motor task (e.g., flexion of the forearm) is attempted.

Once this point is reached the retraining of usually paretic triceps muscle begins; The therapist stabilizes the patient's elbow at 90 degrees flexion with shoulder abducted 45 degrees. The positive reinforcement shaping paradigm is used for retraining of the triceps

muscle (extension of forearm). Use of a powder board may be indicated in some cases to decrease gravitational effects. Often, simultaneous monitoring of the biceps muscle is of help to the patient in suppressing and controlling sporadic spasticity during the attempt at elbow extension.

When the patient repeatedly responds with closer approximations of the muscle activity to the optimal therapeutic goals, the visual feedback is withdrawn. Further functional return is facilitated by continuing auditory feedback with concomitant direct visual observation of the limb displacement. As the return of functional components of a desired task occurs, and the speed and accuracy of performance improves, all feedback is gradually withdrawn.

## RESULTS

Since inception of the study of efficacy of EMG feedback therapy, over 150 patients with a variety of disorders of voluntary movement were treated. The majority of these patients were in two groups; one group of hemiparetic-spastic syndrome patients, resulting from cerebral insult and the other group with focal dystonic syndrome, related to dysfunction of the basal ganglia. All of these patients had received conventional physical therapy for extended periods of time with inadequate functional return. The results of EMG feedback therapy with aid of the EMG Bioconditioner generally conform to those that had been previously published or are in press,<sup>5-9</sup> that is, approximately 50% of treated patients have achieved and retained meaningful improvement derived from ability to learn voluntary control of previously dysfunctional muscles. For details the reader is referred to pertinent bibliography.

## CONCLUSION

EMG feedback therapy (sensory feedback therapy) appears to be a useful therapeutic modality demonstrating varying degrees of success in some cases of disturbed neuromotor control. The technique is non surgical and is free of side effects often seen in drug therapy.

Introduction of the EMG Bioconditioner offers a clinical tool of considerable usefulness to the clinician and the therapist. As a research device it can also be applied to the study of neuro-motor control in healthy subjects.

## BIBLIOGRAPHY

1. Smith, K.U. and Sussman, H.: *Cybernetic Theory and Analysis of Motor Learning and Memory*, in *Principals of Skill Acquisition*, Bilodeau, E.A. (Ed.), Academic Press, Inc., New York, 1969.
2. Ruch, T.C., *Motor systems*, in *Handbook of Experimental Psychology*, S.S. Stevens (Ed.) John Wiley & Sons, New York, 1962.
3. Connolly K., Jones B.: *Developmental study of afferent-reafferent integration*. *Br. J. Psychol.* 61:259-266, 1970.

4. Gans, B.M., Noordergraaf, A., Voluntary skeletal muscles: A Unifying theory on the relationship of their electrical and mechanical activities. Arch Phys Med Rehabil 56. May, 1975.
5. Brudny, J., Korein, J., Levidow, et al: Sensory feedback therapy as modality of treatment in central nervous system disorders of voluntary movement. Neurol. 24: 925-932, 1974.
6. Brudny, J., Korein, J., Grynbaum, B.B., et al: EMG Feedback Therapy: Review of Treatment of 114 Patients. Arch Phys Med Rehab. 57: 55-61, 1976.
7. Grynbaum, B.B., Brudny, J., Korein, J., The Sensory Feedback Therapy for Stroke Patients, Geriatrics 1976 (in press).
8. Korein, J., Brudny, J., Grynbaum, B.B., et al: Sensory feedback therapy in spasmodic torticollis and dystonia: results in treatment of 55 patients. In Eldridge R., Fahn S. (Eds.): Advances in Neurology, Vol. 14, New York Raven Press, 1976 (in press).
9. Korein, J., Brudny, J.: Integrated EMG Feedback in the Management of Spasmodic Torticollis and Focal Dystonia, A Prospective Study of 80 Patients, Proceedings of 56th Meeting, Association Research Mental and Nervous Diseases, New York 1975, Raven Press, New York 1976 (in press).

# BIOMEDICAL ENGINEERING EXPERIENCE AND DEVELOPMENTS IN

## FUNCTIONAL ELECTRICAL STIMULATION

by

Joseph Canzoneri, P.E., D.Sc.  
Donald E. Koenig  
Joe P. Jameson, P.E., B.S.  
Biomedical Engineering Department  
TIRR/Baylor College of Medicine  
Houston, Texas

Summary - The Biomedical Engineering program of the Texas Institute for Rehabilitation and Research is actively engaged in seven projects which utilize Functional Electrical Stimulation. The projects include assistive and corrective devices for hemiplegics and the spinal cord injured, a biofeedback system for the spinal cord injured, and a clinical evaluation device for the Chronic Pain Program.

The Texas Institute for Rehabilitation and Research has been engaged in the evaluation, design, and maintenance of functional electrical stimulation (FES) systems for the past seven years. Our experience began with the evaluation of the Ljubljana Type P08 electronic peroneal brace. It was with this project that we learned about the many application problems associated with FES<sup>1</sup>. At the present time, our program is concerned with seven FES projects of which our Biomedical Engineering Department has contributed to the design, development, modification, fabrication, and manufacture. The projects will be discussed individually.

Our FES team consists of physicians, physical and occupational therapists, electronic engineers, and electronic technicians. Working in close cooperation and in close proximity, the team members are able to quickly identify problems, and provide immediate feedback to attempted problem solutions.

### Projects

1) Correction of foot drop in hemiplegia. People who have had a cardiovascular accident or who have sustained a head injury are unable to sufficiently dorsiflex the foot of the affected side. To overcome the so-called foot drop, electronic peroneal stimulators have been developed which can produce active dorsal flexion of the foot in the ambulatory swing phase of gait (Figure 1)<sup>2</sup>. This is achieved by percutaneous application of electrical stimulation to the common peroneal nerve via a pair of gauze covered button electrodes. The cathode is located in the popliteal space and the anode is placed below and slightly posterior to the head of the fibula (Figure 2). Stimulation is initiated upon heel release and ceases at heel strike of the ipsilateral foot (Figure 3) by respective opening and closing of a footswitch located in the user's innersole.



Figure 1. Active dorsiflexion produced by electrically stimulating common peroneal nerve

A great demand for the electronic peroneal braces existed in 1970 because good results were being achieved. However, at that time, many components of the Ljubljana system were unreliable and replacement parts were unavailable. This prompted our team to develop our own system. Many features of the Ljubljana system were incorporated into our electronic nerve activator (ENA-2) system design, such as stimulator operation on rechargeable batteries, fixation of electrodes with knee stockings, and the use of miniature connectors between the major sub-system components. The complete ENA-2 system consists of six major components, namely, electronic stimulator, cable assembly, electrode assembly,

footswitch, knee stocking, and battery charger (Figure 4).



Figure 2.. Location of electrodes

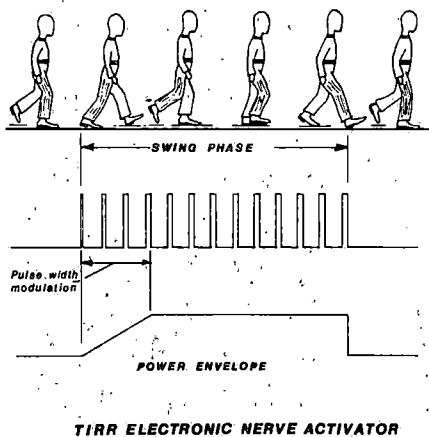

Figure 3. Application of stimulus during swing phase

**Salient Features.** To avoid breakage due to inevitable dropping by the one good-handed person, the electronic stimulator was packaged in a high impact ABS plastic case and to this date, none of these cases has been broken or cracked.

Heating effects from the patient's skin and agitation of the electrodes against the skin promotes drying of the wetted gauze button electrodes, thus increasing the skin-electrode resistance as the electrode dries. To provide longer wearing time of electrodes without re-wetting, a constant current source is used which is capable of delivering 15 ma into load resistances ranging from 0 to 7K ohms.

In life testing the footswitch, over a million actuations without failure were recorded. High reliability was achieved by using a short section of a Tapeswitch<sup>®</sup> strip as the switch

element and enclosing it in a heat sealed vinyl envelope.

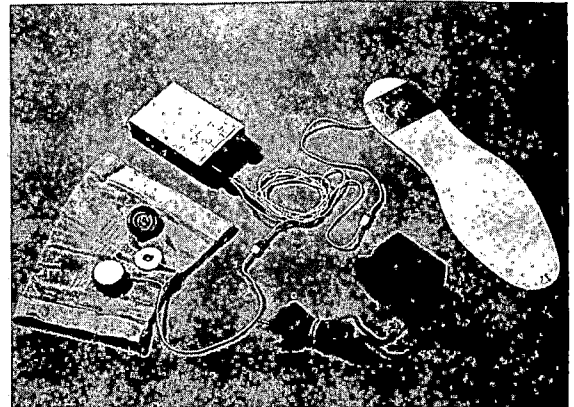

Figure 4. Components of ENA-2 system

Breakage of interconnecting cables is virtually non-existing with the use of high tensile strength hearing aid wire.

A short circuit proof feature designed into the output circuit has held maintenance of the electronic circuits to a minimum.

Smooth graded dorsal flexion of the foot is produced by employment of pulse width modulation during the first .1 second of stimulation (Figure 3).

It is possible to obtain good foot dorsal flexion, free of stimulation dropouts during the entire swing phase of gait at cadences ranging from 25 to 90 steps/minute without making special adjustments for walking rates. This has been accomplished with a simple delay circuit which can be independently turned on and off, or allowed to time out.

Internal controls can be adjusted to provide a wide range of prescriptions for pulse width, pulse repetition rate, and pulse train duration.

**Outstanding Problems.** The time required for a hemiparetic person to find the proper electrode locations varies from ten to thirty minutes depending on his skill and intelligence. This time, plus that required to connect the cable, footswitch, etc. is too long and discourages usage. After locating the electrodes, he is faced with the problem of maintaining this placement, for as he ambulates, the electrodes migrate. Predominantly, Bauer and Black<sup>®</sup> knee socks, and less often, Velcro<sup>®</sup> elastic straps are used as fixation devices. Flexible conductive rubber electrodes, especially for the popliteal space, have been tried with only moderate success. We are currently investigating the merits of some systems in use which provide implantable electrodes.

2) Correction of foot drop and the stabilization of the foot-ankle complex for the head injured. We observed that some of our head injured people, who were either good candidates for the ENA-2 system or who were using the system had an unstable foot-ankle complex during the stance phase of gait. The explanation for this

instability is that when stimulation ceases after the swing phase, the hyperactivity, primarily, of the tibialis anterior muscle causes the foot to be inverted throughout the stance phase. This inversion is extremely dangerous as it sometimes causes the user to stumble.

Normal peroneal stimulation produces foot eversion, therefore it was necessary to extend the stimulation, but with increased amplitude, into and throughout the stance phase. However, in some patients, the extended train action resulted in "quick fatigue" of the peroneal nerve. To alleviate this undesirable secondary effect, a method of selectively dropping pulses from the train was developed. An ENA-2 was modified to provide both of these features. The extended train ENA-2 or ET/ENA-2 can be programmed to omit none, one, or more, in any order of the second, third, or fourth decade of pulses in the train (Figure 5). Further, upon heel strike, it will automatically increase or decrease the pulse amplitude in the stance phase. Pulse amplitude, in both the stance and swing phase, is independently adjustable.

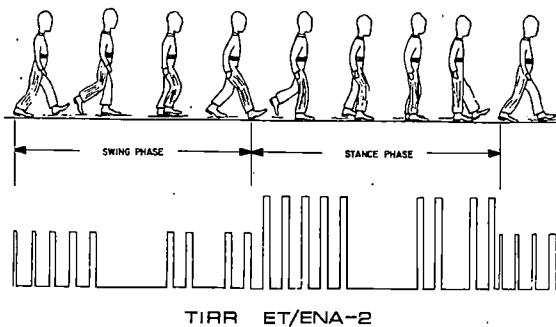

Figure 5. Programmed stimulus produced by ET/ENA-2

3) Modification of upper extremity hypertonia in hemiplegia. Another residual problem associated with stroke patients is that of hypertonia of the wrist, hand, and fingers. Electrical stimulation of certain muscle groups in the forearm can produce opening and closing of the hand, and extension and flexion of the fingers. A few minutes of repeated alternate stimulation of the extensor and flexor muscles markedly reduces spasticity<sup>3</sup>.

The stimulus parameters of the ENA-2 stimulator are ideally suited for this application, but an additional device is necessary to alternately switch the stimulus between the flexor and extensor pairs of electrodes. A unit, the SES-1, was designed to switch the electrical stimulus from one electrode site to the other every two seconds with complete electrical isolation between each electrode pair.

The same stimulation system used by the patient to correct his foot drop is used for home therapy to reduce spasticity. For hand therapy, the ENA-2 is connected to an SES-1 by a cable, and one cable from the SES-1 feeds two pairs of electrodes. Each electrode is secured in place with a Velcro elastic strap. The intensity control on the ENA-2 is used to adjust the intensity of the extensors, and the control on the SES-1 is used for the intensity of the

flexors.

4) Modification of pathological outward rotation of the hip in hemiplegic patients using time sequenced multi-site FES. Besides foot drop, instability of the foot-ankle complex, and upper extremity hypertonia, another problem often exists in the hemiparetic person, and that is impairment of outward or inward rotation of the hip<sup>4</sup>. We have learned that stimulation of certain cutaneous sensory nerves which belong to the same spinal segments, i.e., L1, L2, L3, and L4, as the outward or inward muscle group hip rotators produce significant hip rotation (Figure 6).

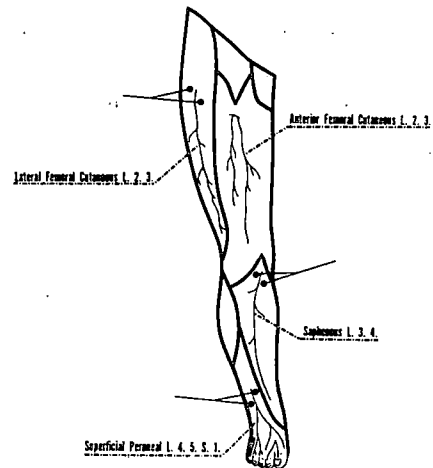

Figure 6. Stimulation sites for cutaneous sensory nerves

The optimal rotator stimulus site was found by stimulating each of these rotators, and measuring the integral of the absolute value of the associated EMG, then using the site which corresponded to the largest response.

Interestingly and fortunately, the stimulus electrical parameters required for these cutaneous sensory nerves are identical to those required for conventional functional peroneal nerve stimulation, except that the current required is less.

The stimulator is activated by the conventional ENA-2 system's innersole switch, except that the stimulus is delayed until near the end of the swing phase. This time delay is determined only after numerous observations during actual walking (this time delay was in the range of .6 to 1.2 seconds).

This technique of producing inward rotation in conjunction with conventional peroneal nerve stimulation enabled us to discover that several combinations and degrees of correction were possible. With two independent delays and three ENA-2 stimulators, maximum effect of dorsal flexion and hip rotation was achieved. The following combinations were used in different patients, and all produced encouraging results: (a) conventional stimulation of the peroneal nerve for foot drop correction only, (b) cutaneous sensory stimulation of superficial peroneal nerve for foot drop correction and

slight hip rotation, (c) conventional stimulation of the peroneal nerve plus one or two sites of cutaneous sensory stimulation for foot drop correction plus slight hip rotation, and (d) cutaneous sensory stimulation of cutaneous nerve for hip rotation only. One patient is actively using only one cutaneous stimulation site for hip rotation alone.

Outstand problems which limit the further development of this technology include: (a) physical size of system is too large, and (b) determination of time delays and proper site(s) of stimulation requires extensive time.

5) Substitute sensory stimulation for prevention of decubital ulcers. Persons with paralyzed extremities are exposed to long periods of stationary sitting or lying. This often results in occlusion of the capillaries thus producing necrosis of the underlying tissue and the formation of decubital ulcers. Individuals with no paralysis and who have adequate sensation in the lumbar, sacral, and ischial regions shift their weight or position periodically and almost unconsciously, thereby avoiding this problem.

The general conclusion of many investigators is that periodic shifting of one's weight is one of the best methods to prevent ulcer formation<sup>5</sup>. Even though the majority of paralyzed persons can move sufficiently to relieve this pressure, they don't, because their sensory feedback system is inoperative. With this in mind, a system was developed which monitors the stationary sitting or lying time and reminds the user when he must relieve the pressure from the area of concern.

Since the decubital ulcer problem is a serious one, it is necessary that the spinal cord injured person pay attention to the given warning. Therefore, it was decided to remind him by providing both a slight electrical stimulus and a visual stimulus. The electrical stimulus is applied above the region of sensory loss, such as behind the shoulders or on the forearms.

The system developed was designed primarily as a training/learning instrument (a) to train the SCI patient to periodically shift his weight, etc., and (b) to study and evaluate the respective problems and solutions associated with decubital ulcers resulting from excessive stationary sitting<sup>6</sup>. Dubbed the REP, for "reminder of excessive pressure," the system (Figure 7) provides two independent channels of biofeedback in the form of visual and percutaneously applied electrical stimuli. Two ENA-2 stimulators were utilized to provide the electrical stimulation.

The prototype system has two timers, one is a long interval timer which measures the time that pressure is exceeded (the duration of time is adjustable in minutes), and the other is a short interval timer which measures the time that pressure is relieved (this duration is adjustable in seconds).

If the pre-adjusted pressure threshold is exceeded, a warning light will glow. After an interval of some preset time, e.g., 5 minutes,

of sustained pressure above the threshold value, the patient receives a continuous electrical stimulus. Each time the patient relieves the pressure below the threshold value, the stimulation is stopped. He must relieve the pressure for an accumulated period of 15 seconds in order to be awarded a 5 minute interval free of electrical stimulation.



Figure 7. Patient shown relieving pressure after being "reminded" by REP

Reports from the Occupational Therapy Department inform us that the REP system appears to be an effective method of biofeedback training. It is easily adjusted to various seat dimensions, threshold pressures, and intensity of stimulation.

The REP training/learning device is quite large and over-sophisticated for other than institutional use. A one-channel take-home system is planned which will be the size of an ENA-2 stimulator.

6) Generation of stimuli to measure pain tolerance levels of patients enrolled in the Chronic Pain Program. A program has been initiated to develop a clinical means of evaluating the pain tolerance level of patients with intractable pain, neuroma, etc. This is achieved by inducing pain with known levels and parameters of electrical stimulation. The results of these tests will be evaluated in conjunction with other neurophysiological studies to determine what pain suppression treatment(s) should be prescribed.

For the most repeatable subjective sensation, it is desirable to deliver constant current stimulation at graduated levels of .1 ma, from 0 to 25 ma. This was achieved by modifying the output stage of an ENA-2 stimulator to include three constant current sources (one each for .1, 1, and 10 ma increments), which are summed into a common load. The other parameters provided are: 1 second train duration, 100 Hz. frequency, and 1 millisecond pulse width. The output drives an annular-disc cellulose sponge shock electrode saturated with saline solution. The resistance

at the site of stimulation must be reduced to 5000 ohms or less, as this insures the best repeatable subjective evaluation to electrical stimulus amplitude<sup>7</sup>.

7) Bilateral electrophrenic respiration in high cervical cord lesions. Some quadriplegic patients are unable to breathe without assistance from rather large and cumbersome external artificial ventilation systems.

In 1970 we became interested in the clinical use of an implantable stimulation system for diaphragm pacing which was developed at Yale University<sup>8</sup>. The Yale electrophrenic respiration (EPR) system uses a radio frequency induction technique for transferring the energy to the implant.

Bilateral application requires two independent EPR pacing systems. Each EPR system consists of four major components: (a) a battery-powered external radio frequency (RF) transmitter, (b) a chest implantable receiver, (c) an external flat donut-shaped antenna, and (d) a phrenic nerve electrode cuff. The receiver inductively couples from the RF energy transmitted through the skin, the necessary power and information to convert the radiated signal into the prescribed phrenic nerve stimulation parameters.

Three of our quadriplegic patients have had bilateral EPR implants. One patient has progressed so well that she now uses the EPR system as the primary ventilatory support system on a 24-hour basis. Because she can tolerate long term EPR pacing, she was able to sit for longer periods of time. Consequently, it was learned that partly because of a scoliotic condition and partly because of a greater ventilation demand when sitting, she requires synchronous bilateral stimulation. Also, because of 24-hour usage, the original internal battery was inadequate.

The first inadequacy was overcome by the design of an EPR programmer unit to provide respiration rate control in one of the following selectable modes: (a) left side only, (b) right side only, (c) both sides synchronously, and (d) both sides, alternately.

Only a slight modification was made to the RF transmitter to receive the respiration rate signal under programmer control. All other prescribed stimulating parameters remain under control of the transmitter. In case of programmer malfunction, the RF transmitter selector can be returned to normal (non-programmed) pacing.

The second limitation for a 24-hour a day operation was removed with the incorporation of an external rechargeable battery pack consisting of four Gel-cells<sup>®</sup>. Two four volt, 1 amp-hour cells are used for each transmitter.

Two separate battery packs were constructed so that the patient has a fully charged spare available, and are changed at two week intervals. A clamp-carrier to carry the Gel-cell packs, the programmer, and the two RF transmitters was built which enables easy attachment of the carrier to the wheelchair or bed.

Programmers are now being used by two of our patients, and one patient is doing so well that attendance of university classes in a wheelchair is now possible.

In conclusion, it is our opinion that our team has gained considerable experience in the field of FES. Also, we realize that many spin-off projects have developed from the original Ljubljana P08 project and anticipate many new and exciting FES projects for the future.

#### References

1. Vodovnik, L. Final Report - Electrical Stimulation as a Rehabilitation Method to Improve Abnormal Locomotion and Manipulation, Univ. of Ljubljana, Yugoslavia, August 1975.
2. Gracanin, F., Prevec, R., Trontelj, J. Evaluation of use of functional electronic peroneal brace in hemiplegic patients. Proc. of Symp. on Ext. Control of Human Extremities, p. 198-205, Dubrovnik, 1966.
3. Vodovnik, L. and Rebersek, S. Myoelectrical and myomechanical prehension systems using functional electrical stimulation. The Control of Upper-Extremity Prostheses and Orthoses. Edited by P. Herberts; Charles C. Thomas, Publisher, Springfield, Illinois.
4. Kralj, A., Trnkoczy, A., and Acimovic, R. Improvement of locomotion in hemiplegic patients with multichannel electrical stimulation. Human Locomotor Engineering - Based on papers presented at the University of Sussex, London, September 1971.
5. Houle, R.J. Evaluation of seat devices designed to prevent ischemic ulcers in paraplegic patients. Archives of Physical Medicine, 50, October 1969.
6. Canzoneri, J., Koenig, D.E., and Leavitt, L.A. Sensory substitution stimulation for prevention of decubital ulcers. Paper presented at the Devices and Systems for the Disabled conference, Philadelphia, April 1975.
7. Smith, G.M., Parry, W.L., Denton, J.E., and Beecher, H.K. Effect of morphine on pain produced in man by electric shock delivered through an annular-disc cellulose sponge electrode. Proceedings, 78th Annual Convention, APA, 1970.
8. Glenn, W.W.L., Holcomb, W.G., Gee, J.B.L., and Rath, R. Central hypoventilation: Long-term ventilatory assistance by radio frequency electrophrenic respiration. Ann. of Surg. 172:755, 1970.

#### Acknowledgements

These projects were supported by RSA Grant #16-P-56813/6-13 and REC Grant #23-P-55823/6-04.

We gratefully acknowledge the members of the team in their support of this paper.

## A SYSTEM FOR THE MEASUREMENT OF VERTICAL FOOT FORCES

by

Richard C. Levin, M.S.\*  
John I. Molinder, Ph.D.  
Sedat S. Serdengeçti, Ph.D.  
Harvey Mudd College  
Claremont, California

A foot-to-ground vertical force measuring system is developed for diagnosis and correction of lower extremity defects in orthopedic patients. The system is portable and consists of four strain gage type transducers embedded into a sandal that can be worn over the patient's shoe. The system has been tested to illustrate usefulness for the patients under consideration.

### Introduction

Diagnosis and correction of lower extremity defects in orthopedic patients is greatly facilitated by being able to measure the actual static and dynamic forces exerted by the feet while the patient is walking. In addition, such information would be useful for evaluating past treatment, either surgical or therapeutic, and for providing information for future treatment.

Presently, the most commonly used foot-force measuring devices are instrumented force plates<sup>1,2</sup> which are embedded in a limited region of the walking surface. Force plates measure the total foot-to-ground forces in the vertical plane, two horizontal shear planes, and torsional loads about a vertical axis. Although very accurate, force plates are very expensive and only large enough to measure the forces occurring during a single step, so the patient is usually required to walk over the plate several times, a process which is not only time consuming, but may well be painful to the patient.

Recently, shoe-mounted load cells to measure the orthogonal components of total foot-to-ground forces and moments have been developed<sup>3</sup>. Load cells are attached directly to a shoe at both the toe and heel to completely replace all floor-contacting surfaces of shoes. Such an arrangement of the foot-to-ground force measuring system is expected to alter customary walking style of the patient and thus will be ineffective for the present intended usage of the system.

For the effective diagnosis and correction of lower extremity defects of a patient, a foot-to-ground force measuring system must indicate the foot forces at the following four areas of the foot: the great toe, the first and fifth metatarsals and the heel. Such transducers must not be so thick as to interfere with the patient's customary walking style and they must be easily attached to the shoes of any patient. Needless to say, they must measure time varying forces associated with walking.

In September 1973 the Engineering Clinic of Harvey Mudd College, under the sponsorship of Rancho Los Amigos Hospital,\*\* began the development of a system for measuring vertical foot forces. The development was carried out over a period of three years by three student teams<sup>4-6</sup>. A working system was delivered to Rancho in May 1975 and is described in this paper.

The Kinesiology Laboratory of Rancho Los Amigos Hospital has been active in the analysis and correction of gait disorders for a number of years. To evaluate the effectiveness of physical therapy and surgical procedures the laboratory developed a system for measuring the time sequence in which various parts of the foot contact the floor as a patient walks. Contact sequences of persons without gait disorders can thus be used as a benchmark for determining the effectiveness of treatment. The system consists of several thin pressure switches mounted in an insole which can be slipped into the patient's shoe. This allows the patient to wear his normal, perhaps corrective, shoes. It also eliminates the gait distortion that results when a, perhaps severely handicapped, patient is required to accurately strike a device such as a force plate while walking.

Although this system has been highly successful, Rancho Los Amigos Hospital felt that the measurement of the force-time history of various parts of the foot during walking would provide additional valuable information. The transducers for this purpose were required to match the constraints of the contact switches namely (a) be suitable for mounting on a sandal or the patient's own shoes, (b) be thin enough so that they would not significantly affect the patient's gait, (c) give a repeatable output that could be easily calibrated in terms of force, and (d) be relatively inexpensive. A detailed description of a device that meets these requirements is given in the sections that follow.

\* Currently with C F Braun & Company, Alhambra, California.

\*\* 7601 East Imperial Highway, Downey, California.

### Description of Transducer

The transducer, in its final configuration, is circular, 1.159 inches in diameter, and 0.136 inches thick as shown in Figure 1(a). It consists of a machined bottom plate with a conical steel washer called a Belleville spring fitted into the top face. A matched pair of high sensitivity semiconductor strain gages are affixed to the bottom plate, one on each side as indicated in Figure 1(b). The slots cut in the bottom plate serve to increase the strain seen by the gages while the top and bottom rims constrain the Belleville spring and protect the bottom gage respectively.

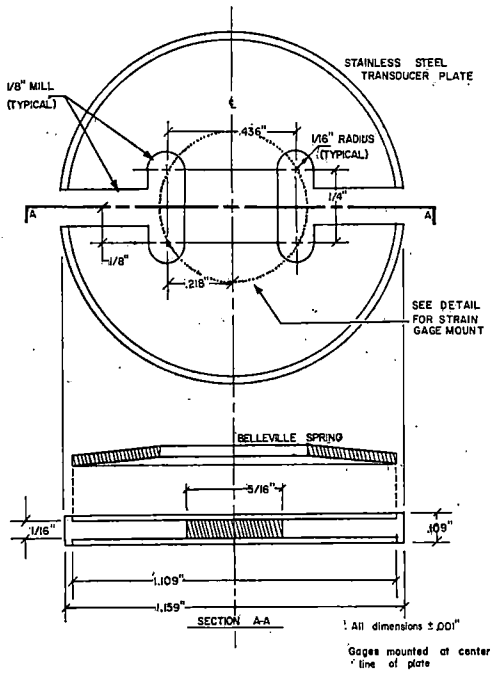

Figure 1(a)

Transducer Plate and Belleville Spring

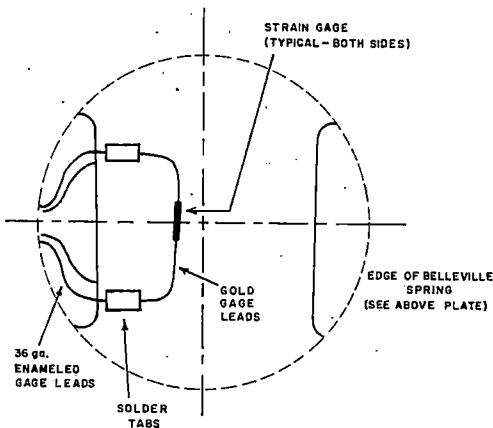

Figure 1(b)

Strain Gage Mounting Detail

Force applied to the top edge of the Belleville spring causes the bottom plate to bend in a convex upward fashion as shown in Figure 2. A typical plot of the variation of gage resistances versus applied force appears in Figure 3. In this configuration the gages measure the axial strain component of the bottom plate's bending motion. To transform the varying gage resistances into an electrical signal, the gages are arranged as two legs of a Wheatstone bridge as indicated in Figure 4. If the gages are connected such that bending motion tends to be cancelled out, the output voltage of the bridge tracks the applied force in a nearly linear fashion as shown in Figure 5. Temperature compensation is easily provided by replacing the fixed bridge resistors with two unstrained gages mounted on the essentially strain-free milled slots of the bottom plate as shown in Figure 6. This requires that all four gages making up the bridge be matched. Since the transducers vary in no-load gage resistances and in sensitivity, the signal processing circuitry must provide for null-voltage and gain adjustments. An operational amplifier circuit used for this purpose is also depicted in Figure 4.

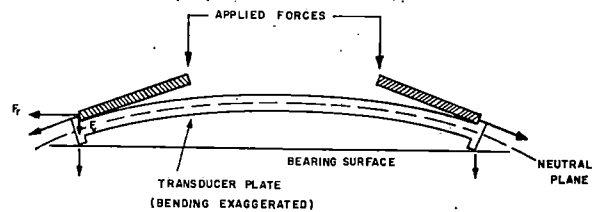

Figure 2

Transducer Bending Under Normal Loading

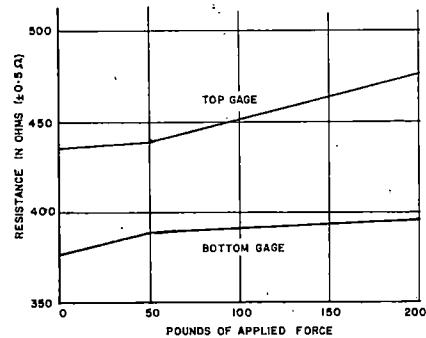

Figure 3

Transducer Strain Gage Resistance Variation with Applied Force

## Construction of Transducer

Once the bottom plate is machined, the strain gages and their lead assemblies are installed. Matched p-type semiconductor gages are used because of their superior sensitivity as compared to standard gages (the gages used have an unstrained resistance of roughly four hundred ohms). A piece of "spaghetti" is glued to one of the milled slots to provide strain relief for the gage leads. The gages and solder tabs are then covered with a protective coating such as Dow-Corning "Silastic." It is essential that the Belleville spring fit into the top rim of the bottom plate tightly enough to assure linear response at low force levels. This is achieved most easily by trial-and-error fitting of springs to either side of the bottom plate until a spring is found which provides sufficient pre-loading of the plate as indicated by changes in the gage resistances.

The completed unit must be broken-in to stabilize its characteristics. Five hundred to one thousand loading cycles between twenty and two hundred pounds force is normally sufficient to achieve maximum repeatability and linearity as well as minimum hysteresis.

## Transducer Performance

Transducer hysteresis, linearity, and repeatability are usually within five percent of ideal (see Figure 5). Calibration is accomplished by statically loading each unit with a known weight and adjusting the gain of the bridge signal processing circuitry to a convenient value (ten millivolts per pound was used with the circuit of Figure 4).

Transducers have been cycled as many as thirty thousand times without a single fatigue failure. Though the device is non-linear above approximately three hundred pounds of applied force, it will not be damaged until at least five hundred pounds of force is applied. Care must be taken, however, to prevent foreign matter from coming into contact with the strain gages themselves since they are extremely delicate.

## Force Measuring System

The measurement system consists of eight transducer units, sandals to position them under the shoes of the subject, and processing circuitry. The transducers are located at the great toe, the first and fifth metatarsals and the heel of each foot - the major points of contact between the foot and the walking surface. The position and number of transducers can of course be changed to suit specific needs.

The sandals used are built of separate heel and insole segments, to minimize interference with the subject's natural gait, with the two pieces connected by a flexible strap so the strain gage leads can all be brought to a single connector. Both segments of the sandals consist of a one-eighth inch thick rubber sheet, with holes punched for placement of the transducers, a leather layer for strength, next to the

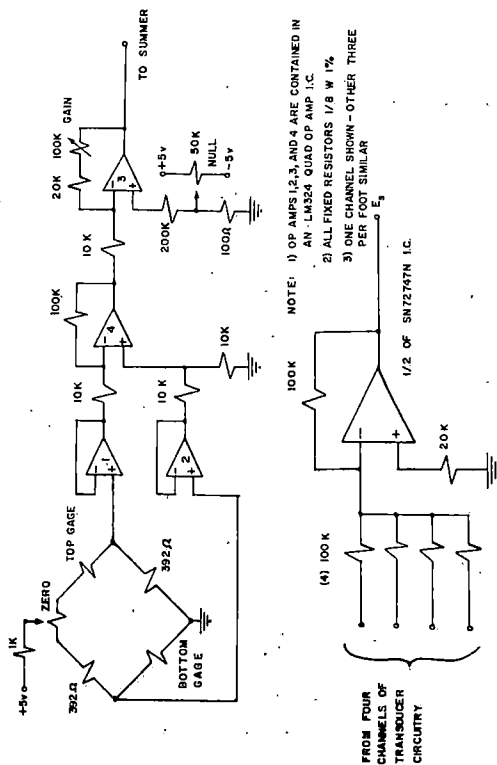

Figure 4

Foot Force Measuring System  
Signal Processing Circuit

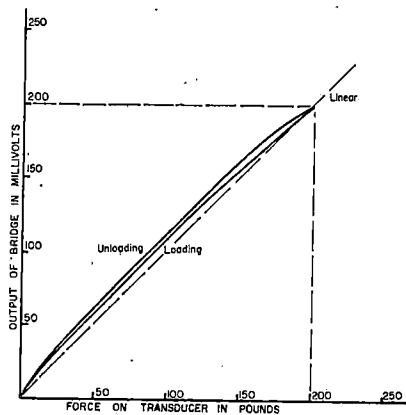

Figure 5

Typical Variation of Transducer Output  
with Applied Force

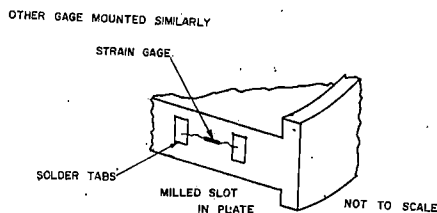

Figure 6

Details of Compensating Strain Gage Arrangement

patient's shoes, and straps to hold the sandals in place. The transducers are held in place, as well as protected from direct contact with the walking surface, by a layer of duct tape. Though such a covering is impermanent and rather easily damaged, it was found superior to rubber, plastic or leather coverings because it allows firm contact between the transducers and the walking surface. This contact is essential for minimum damping of the transducers' response. A detail of the transducer mounting is shown in Figure 7; the protective plate illustrated is a hard disc provided to assure that the transducer is loaded at its rim, and that no damage occurs to the upper strain gage.

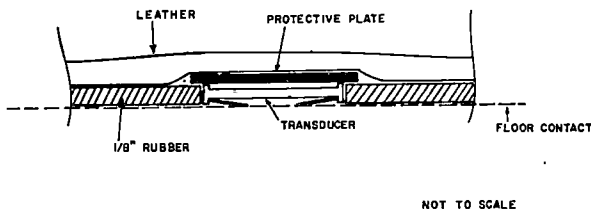

Figure 7  
Sandal Mounting Arrangement of Transducer

The strain gage leads (16 per foot) are soldered to a connector mounted on each sandal, and flexible cables run up the subject's legs to the signal processing circuitry contained in a box fastened about the waist. The box contains eight identical circuits as shown in Figure 4, and summing circuits to show the total force exerted by each foot. The box has provisions for self-contained batteries and telemetry circuitry, to make the system totally self-contained, but as presently used it is connected to recording equipment and power supplies by an overhead cable.

### Results

Figure 8 illustrates typical system outputs of total foot force from four "normal" subjects, each wearing an instrumented sandal of the type commonly worn on bare feet. The first subject walked with a fairly average gait, and the feet of the second subject were too small for the sandals, so scuffing of the feet is apparent. The third and fourth traces are from subjects of similar weight and shoe size, but the third had flat feet, while the fourth had extremely high arches and consequently a definite difference in force patterns is apparent. It is important to note that these force-time histories are remarkably similar to the well-known pattern of total foot force as measured with a force plate<sup>7</sup>, despite the inaccuracy introduced by approximating the total force by measurement at four points.

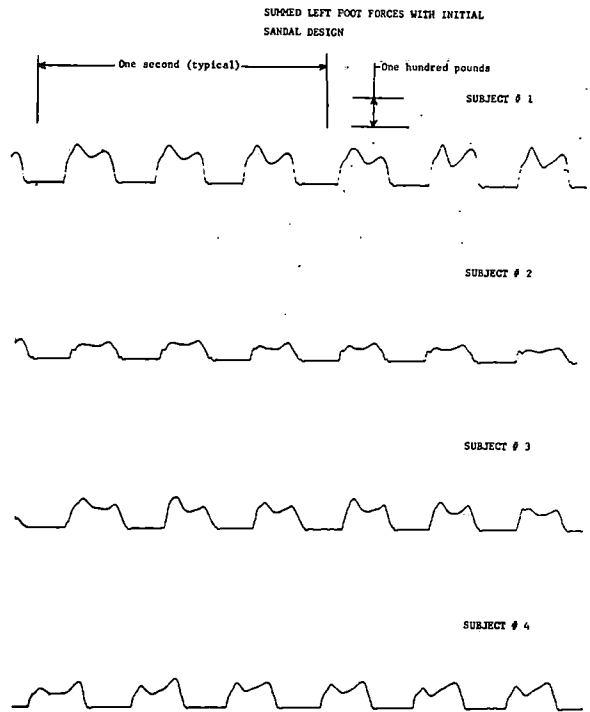

Figure 8  
Typical Total Foot Force Variation During Walking of Various Subjects

Figure 9 shows force-time outputs of all four transducers on a normal subject's right foot; trace #1 is from the great toe, trace #2 from the first metatarsal, trace #3 from the fifth metatarsal, and trace #4 from the heel. The fifth trace (inverted) is the sum of the first four. Its sharp cut-off at both heel-strike and

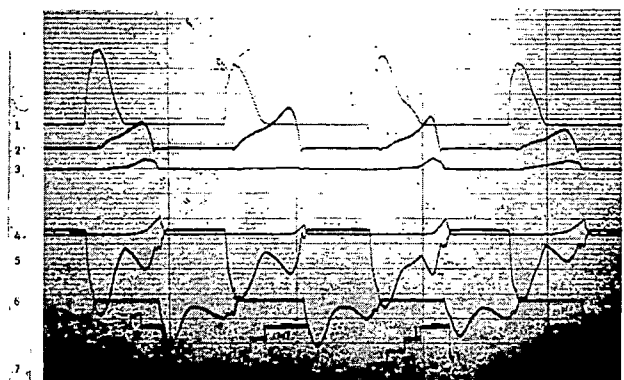

Figure 9  
Typical Foot Force Variation During Walking as Measured by Various Transducers of the System

toe-off is caused by the system's inability to precisely measure forces at the extreme ends of the sandal, away from the transducers. Trace #6 (also inverted) is of total force from the left foot, and trace #7 is the output from the hospital's own foot switch system. At this time, little interpretation has been made of this force data taken from individual parts of the foot, since such information was not previously available. It is hoped, with continued use by hospital personnel, that new and highly detailed diagnostic data can be gleaned from observation of localized walking forces in orthopedic patients.

#### Acknowledgements

The authors are indebted to Messrs. J. P. Patkay and W. H. Lang for their significant contribution to this work, and to Messrs. D. Antonelli and K. House of Rancho Los Amigos Hospital for their constant encouragement, and wish to extend their sincere thanks to Mrs. J. Dimit who rendered efficient help in the preparation of this manuscript.

#### References

1. Cunningham, D. M. and Brown, G. W., "Two Devices for Measuring the Forces Acting on the Human Body During Walking," Proc. SESA, 14 (2), 75-90 (1952).
2. Bresler, B. and Frankel, J. P., "The Forces and Moments in the Leg During Level Walking," Trans. ASME, 72, 27-36 (1950).
3. Spolek, G. A., Day, E. E., Lippert, F. G. and Kirkpatrick, G. S., "Ambulatory-Force Measurement Using an Instrumented-Shoe System," Experimental Mechanics, Journal of SESA, 15, 271-274 (July 1975).
4. Patkay, J. P., Drinkward, W. A., Halas, J., Lang, W. H., Ogren, J. A., and Strohbahn, E., "The Design of a Transducer to Measure Static and Dynamic Normal Foot Forces," Harvey Mudd College Engineering Clinic Report, 1973.
5. Lang, W. H., DeCarvalho, F., Flower, T., Hornsby, J. J., and Ogren, J. A., "Design of a System to Measure Foot Forces of a Walking Patient," Harvey Mudd College Engineering Clinic Report, 1974.
6. Levin, R. C., Armstrong, A., Dacey, E. J., Gumaer, P., and Le, K., "Foot Force Transducer System," Harvey Mudd College Engineering Clinic Report, 1975.
7. Normal Angular and Force Measurement Data, Gait Analysis Laboratory, Shriner's Hospital for Crippled Children, 1701 19th Avenue, San Francisco, California.

## CLINICAL APPLICATION OF THE IMPROVED BOSTON ARM

by

T. Walley Williams, III, Project Director, Mechanical Development  
Liberty Mutual Research Center, Hopkinton, Massachusetts 01748

The Improved Boston Arm is an EMG controlled prosthesis for the above elbow or shoulder amputee. Twenty-five units have been built and eleven fitted to patients for periods up to three years. The success of this device depends equally upon the engineering reported earlier and upon the team used to evaluate and train the patient. Of eight AE patients one has severe scarring and several detached biceps and triceps muscles. Three high level amputees operate the arm in a "natural" way using muscle areas whose contraction is associated with contraction of biceps and triceps in the intact individual.

### Introduction

For those who have not seen the previous detailed technical report presented at this conference in 1974, a brief description of the Improved Boston Arm is in order. The arm is for an above elbow amputee with intact biceps and triceps muscles or for a higher level amputee with appropriate muscle sites for EMG control. The socket is conventional except for the electrodes and attaches to the elbow housing with a humeral rotation friction joint. The elbow housing contains a motor, reverse locking clutch and speed reduction gearing while the forearm frame contains batteries, electronics, an on-off switch and a recharge connector. The terminal device is operated by a Bowden cable located as if the amputation were below elbow. Further technical specifications can be found in the appendix of the written report.

When the redesigned Boston Arm was reported it existed only in prototype form. Since then twenty-five pre-production units have been fabricated and eleven have been fitted to amputees.

A small number of arms was selected for the initial run so that any weaknesses in the system could be readily corrected on all units. This was a good decision, since a number of mechanical problems which occurred at first have been eliminated by reworking a few parts on all units. The basic design has proven excellent and an additional twenty-five units are now being fabricated so that larger numbers of patients may be fitted.

### Team for Fitting of Patients

The proper fitting of a patient with a conventional or an EMG controlled elbow prosthesis requires a clinical team. Preliminary evaluation of the patient must be in the hands of a physician trained to recognize the full range of medical and psychological problems met by the amputee. He is assisted by a physical therapist, an occupational therapist and a prosthetist.

### Initial Evaluation

The easiest patient to fit is one with well

developed biceps and triceps muscles tied down at the distal end of the stump. The skin covering the muscles should be free of fibrous tissue. This ideal patient can readily contract either muscle independently. Such an ideal patient is a rarity.

In the typical patient one or more of the following problems exist.

1. The humerus is internally rotated to place the biceps medially just under the axilla and the triceps laterally.
2. The muscles are tied in place either poorly or not at all so that the muscle bellies retract under the deltoid to some degree during contraction.
3. The patient has difficulty isolating the contraction of the two muscles.
4. Adipose or fibrous tissue attenuates the EMG signal.

For all these reasons the physician may not be able to guarantee a successful fitting upon initial examination. Thus in almost every case training and evaluation by a physical therapist are required.

### The Role of the Physical Therapist

A physical therapist is the most qualified person to train and evaluate the amputee, however, some clinical teams assign this role to an occupational therapist. In either case the procedure is the same. Initially the patient is trained by having him contract the muscles of the intact and amputated limbs simultaneously. It is easiest to use an EMG tester if the patient achieves some ability to control and isolate his muscle contractions prior to the use of the electrodes.

For the EMG evaluation, the therapist is equipped with a movable electrode pair for each of the two muscles selected and a ground or reference electrode. These electrodes are coated lightly with conductive jelly and held in place with tape or with an elastic bandage. The electrode cable is attached to a connector on the

prosthetic arm which will later be fitted to the patient. The therapist then has a choice of having the patient operate the actual arm assembly clamped to a board or a set of test meters, which is plugged into the arm. Generally, the procedure starts with the meters because both the therapist and the patient can judge how well the activity of the two muscles is being isolated. The meters also serve to tell quantitatively whether good electrode sites have been selected. Once some degree of isolation has been achieved, most patients are more motivated to practice if they are allowed to control the captive arm clamped to the table.

#### High Level Amputations

Three high level amputees have been fitted successfully with the arm. Two are amputated within one inch of the gleno-humeral joint and one is such a high AE that no biceps or triceps muscle remains. In all three cases the same general procedure has been followed to guarantee "natural" control of the prosthesis.

In the intact human being, certain stabilizing muscle activity is normally associated with biceps and triceps contraction; however, this associated activity varies considerably

with the position of the upper arm. In general, the high level amputee will have no useful abduction or flexion about the shoulder, so that all training can be done with the phantom upper arm held vertical.

Training is begun by asking the amputee to place his good forearm flat on a table while seated in a chair of appropriate height. He is then given a weight to lift by "pure" elbow flexion. After he has lifted the weight several times, he is asked to lift the weight and to try to do the exact same motion with his phantom arm. Within a short time the amputee will usually be contracting those portions of his remaining muscles on the amputated side in a way that is approximately the same as on the intact side. For instance there is considerable contraction of the pectoralis major and of the anterior deltoid.

Similar contralateral stimulation is used to elicit muscle response in extension. In either case no attempt is made to select final electrode sites until a period of training has been completed by the physical therapist.

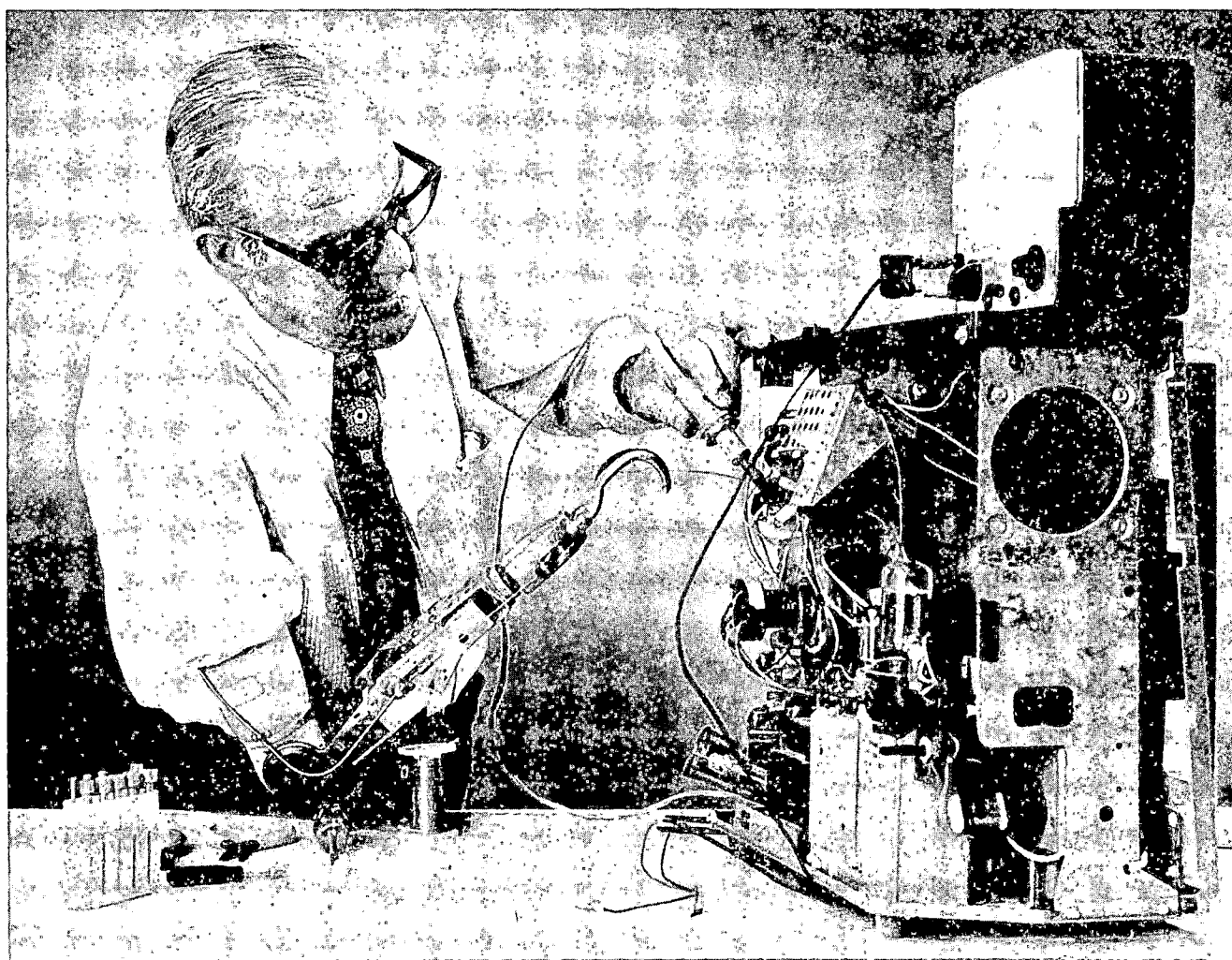

Fig. 1. Precision work can be done with the Improved Boston Arm. (Unit shown without foam cover)

## Electrode Placement: High Level Amputee

No hard and fast rules can be made as to which sites will be best for a given level of amputation. We simply report on the successful fitting of three persons using the technique described above. In these cases the final electrode sites were selected electrically after palpating the most probable sites. Unless there is underlying scar tissue, the best site will be where the therapist can feel the greatest subcutaneous muscle activity.

One patient who has a very short AE stump and no detectable biceps and triceps activity is operating well and "naturally" with electrodes placed over the anterior fibers of the deltoid for flexion and the posterior fibers for extension. Both patients who have been amputated so high that only a small piece of humeral head remains, use the pectoralis major for flexion and an area posterior to the joint for extension. Since it is difficult to tell what muscle mass goes where in an amputation at this level, we can only guess what muscle is giving the signal for extension. In one of the cases we believe that it is the long head of the triceps, while in the other we are not sure. The important point is that this knowledge is not needed if the activity is well correlated with the amputee's attempt to extend his arm in a natural way.

## Appealing Features of the Current Design

Slow Speed Controllability. It is important to note that an EMG controlled elbow does not make an above elbow amputee into a below elbow. The AE amputee is normally fitted in such a way that he cannot exercise volitional control over humeral rotation which is passively controlled by friction between the elbow housing and upper arm socket. In addition to this loss of one degree of freedom, the amputee loses all proprioceptive joint feedback. Thus, he must rely on sight, sound or limited tactile feedback for determining the location or speed of motion of the prosthesis. Thus the most important feature for the amputees we have studied has been controllability at low speed. This important feature is present on the improved arm, and a typical amputee can position his terminal device within a few millimeters without having it jump or overshoot.

Proportional Control. Control of speed is fully proportional with the current arm. After the amputee has made sufficient muscle effort to just activate the arm, further effort increased speed up to the maximum rate of full flexion in one second.

Quick Battery Charge. The quick charger supplied with each arm can recharge the battery to within 85% of the last quick charge in 15



Fig. 2. With electrodes held by an elastic bandage the amputee operates the test meters

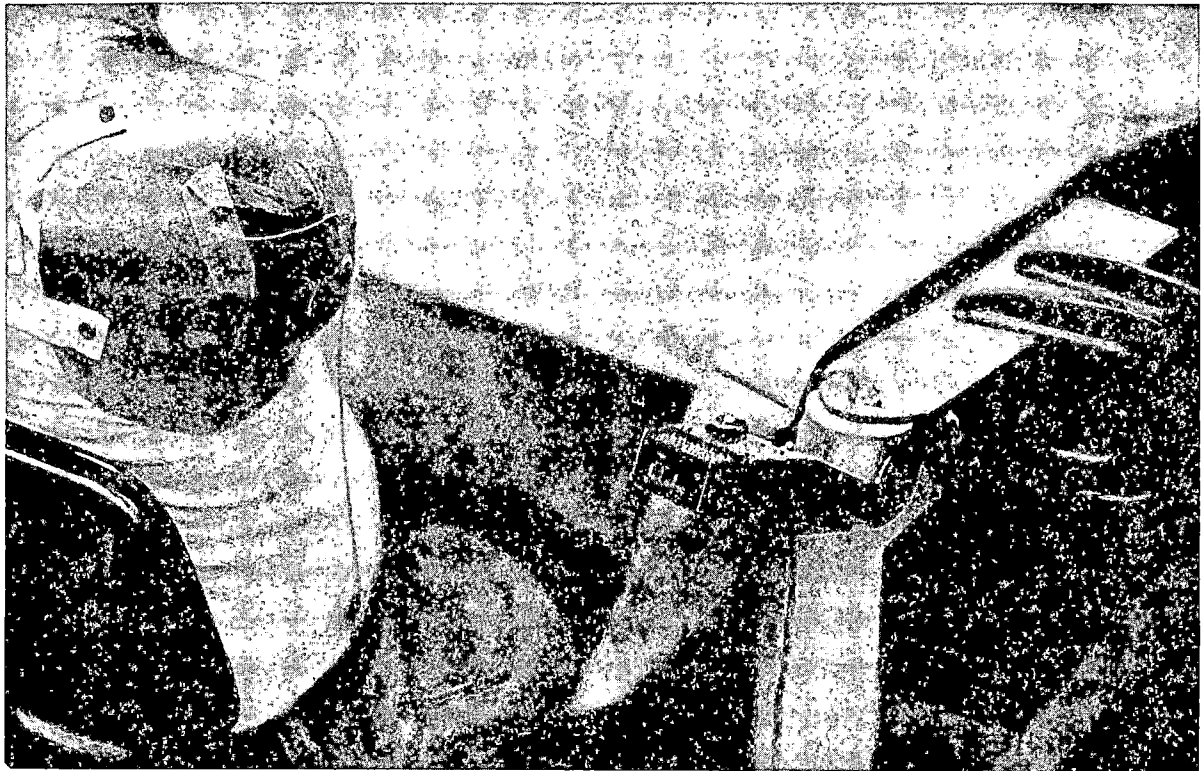

Fig. 3. Spare inner socket used as a training cap while amputee operates captive arm

minutes. If left connected, it then continues to charge at the 14 hour rate until the battery is fully charged. At least once a day the amputee must use this charger or a light weight trickle charger also supplied to bring the battery to full charge. One active user has requested two quick chargers, one for work and one for home. All other users have found a single charger satisfactory.

Free Swing Mechanism. All amputees have stated that they would not like to lose the 30° free swing capability nor would they like to lose the ability to lock the arm directly to the motor for some tasks. The lock is engaged when the forearm is at the extended end of the free swing range; this is the position that gravitational force returns it to under most circumstances.

Tough Soft Cover. The urethane foam cover has a tough skin which shows little wear even after a year of continuous use. It is easy to clean with soap or cleansing powder.

Socket Easy to Construct. The upper arm socket requires almost no new technical expertise on the part of the prosthetist. He must remove a little more material from the positive cast in the areas selected by the therapist for the electrodes, but otherwise the modifications are conventional. The inner socket is fabricated with a relatively flexible layup and is left separate from the outer rigid socket. The electrodes themselves are specially plated speed rivets which are already used extensively in the

profession for fastening. Only the soldering of 5 lead wires is new.

Lift Heavy Weights. Weights in the 5-10 pound category are a real challenge to the conventional prosthesis, but easy for this arm to handle. The high figure is for fully charged battery and the low for near discharge. With the Boston Arm elbow flexion is completely divorced from terminal device operation so that a hook can be selected which can handle a relatively heavy weight.

Arm Operates Tester. All of the expensive electronics for testing and evaluating a patient are contained in the arm which will be fitted. The tester contains only three meters, a few switches and a potentiometer. Thus a low cost tester can be loaned to any team planning to treat an amputee. The loan package also contains electrodes, connectors and a mounting board so that the arm can be operated for practice before the prosthesis is completed.

#### Immediate Improvements

Twenty five additional arms are being fabricated with those design changes which were desirable and easy to make without setting the schedule back.

Reduced Noise. We have evaluated noise as a source of feedback and have found that amputees do not perform as well if they try to operate without visual feedback when the motor noise is completely masked by white noise.

Table 1. Design Specifications of the Improved Boston Arm

Total weight from elbow stud to wrist unit with cover	2.7 pounds (1.22 kg)
Time to recharge battery to within 85% of full charge	15 minutes
Operation on one full battery charge	300-425 flexions in 8 hours
Weight lifted at 90° flexion at 12 inches (300 mm) - with motor with clutch in	5-10 pounds (2.2-4.5 kg) 50 pounds (22 kg)
Degree of free swing upward from last position of motor	30°
Range of motion from full extension to full flexion	145°
Maintenance cycle: Time before replacing battery brushes and half of housing	Greater than one year
Service life: Time until failure of a major subassembly	Greater than five years
Forearm lengths from elbow axis to end of wrist unit	9-1/8-11-1/4 in 3/8-inch steps (231-286 mm in 9.5 mm steps)

Nonetheless, the present noise level is higher than required for this feedback and is about 45 dBA. This level can be reduced 5 to 7 dBA by incorporating damping and absorbing layers to isolate bearing and motor brush noise. In addition, 4 ball bearings have been replaced by sintered bronze bushings which are less subject to damage during assembly. These changes are now being made.

Protection of Drive Components. A slip clutch was incorporated in the first 25 units to protect the drive mechanism. Unfortunately, it is part of the clutch assembly and there is too much inertia between it and the forearm. The greatest probability of catastrophic failure occurs during a fall when forces are not only high but suddenly applied. The second lot of 25 arms will be designed so that the free swing lock and stop pins will shear during sudden high loads. Such a failure can be repaired by replacing three pins and two major components.

Tester Accessibility. The original circuit boards have all been modified to accept the 8-pin plug on the testing unit used by the clinical team. The next 25 units will have the appropriate plug receptacle mounted on the board.

Battery Clamp and Cable Retainer Mount. The retainer base plate was added to the first arms as an afterthought. A new battery clamp will eliminate a separate piece for mounting the retainer and will shift the location of the retainer itself 5/8-inch (16 mm) more proximal which will make terminal device operation easier for short forearm amputees.

Limit Switch Relocation. The limit switches now interrupt the entire motor current path requiring large diameter wires. Further a large base current can continue in the power transistors even after the switch has apparently stopped the arm. New microswitch circuitry will work at a point further back in the amplifier where only 3 mA of current flow.

#### Long Term Improvements

Several commercial organizations have expressed interest in marketing the Improved Arm

as soon as further clinical evaluations are complete. Experience has shown that a design once commercialized tends to remain unchanged for a substantial period of time. Thus it seems appropriate to make every possible improvement before commercialization occurs. The following are some of the changes desired.

Reduction of Deadband. The present electronic circuit uses diodes in a full wave rectifier in such a way that the amputee must produce a contraction about 50% of maximum to activate the arm. Tests on two amputees using a precision rectifier show that less mental effort is required for operation with only a 10% deadband. It further seems that it would be useful for the amputee to be able to reduce the deadband to the smallest value which does not introduce unwanted activity.

Braking of Motor. At high speed the motor can coast past the limit switches even though power has been turned off. To prevent jamming in full flexion, the switch must be made to engage early thereby depriving the amputee of some of the 145° of flexion unless done at high speed. The coasting problem can be solved by making the limit switches part of the feedback system so that the motor control servo tries to achieve zero speed immediately upon closing of a limit switch.

Wrist Units. At present only a Hosmer WE-200 wrist is available. In the future the wrist holder will be modified to accommodate a greater variety of wrist units.

#### References

1. Jerard, R., Williams, T.W., III and Ohltenbusch, C.W., Practical Design of an EMG Controlled Above Elbow Prosthesis. Proceedings: 1974 Conference on Engineering Devices in Rehabilitation, p. 73
2. Williams, T.W., III, et al. Fabrication and Fitting of an EMG controlled Elbow Prosthesis. A 32-page report available upon request from T.W. Williams, III, Liberty Mutual Research Center, 71 Frankland Road, Hopkinton, MA 01748.

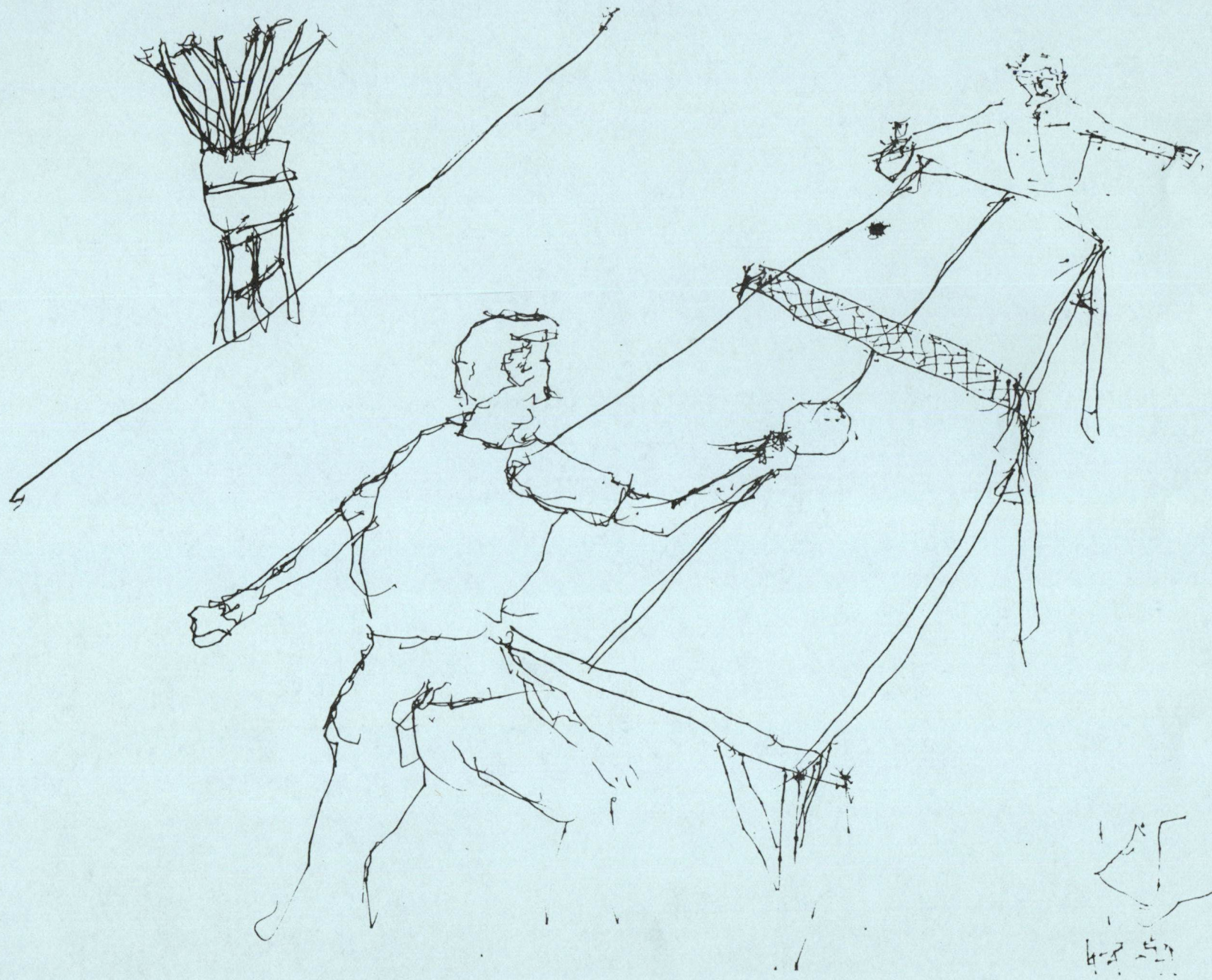

SESSION H

INNOVATIVE PROGRAMS

THERAPY PROJECTS IN MECHANICAL ENGINEERING DESIGN  
J. David Pfeiffer  
Associate Professor  
Department of Mechanical Engineering  
McGill University, Montreal, P.Q.

Summary

Undergraduate design projects have been conducted co-operatively with therapists in local hospitals for three years. The devices built by the students have assisted communication in non-verbal children and allowed quadraplegics to perform self-feeding. Current projects make use of the BASIC alphabet, an extension of the 7-segment displays seen in calculators to include letters, punctuation, and control characters. Project supervision requires planning, technical support, and use of the Engineering Design Process.

Hospitals and therapists often find it difficult to locate the proper technical assistance in developing aids and building therapeutic appliances. Instructors in university-level design courses frequently require project ideas to supply their students with new and interesting devices to design and build. Bringing these two groups together can result in some very beneficial developments if the resulting projects have the right kind of support, supervision and planning. Our experience over the past three years suggests a number of ways in which this cooperation may be enhanced.

A single project in 1973 introduced us to the range of problems facing therapists. This was a page-turning device, undertaken at the suggestion of one of our professors. The three students working on the project consulted with Madeline Shaw and Barbara Hah, O.T.'s at the Royal Victoria Hospital, and found that a dependable page turner was only one area in which design and construction help was required. They built a moderately successful page turner, but it was of limited use because of its size and the fact that it would not handle books with a stiff binding.

The next time a group of students were in need of a project they were directed back to the same place. This time, in January 1974, the students found a member of their own age group as a patient in the Montreal Neurological Institute, where Ms. Shaw and Ha also serve, who was frustrated at not being able to feed himself following paralysis due to a spinal cord injury suffered in football. They became totally interested in his case and endeavoured to build a mechanical feeder for him. By properly defining the functions required of a feeding apparatus,

they were able to come up with a mechanical spoon feeder that would mount on a bed tray or wheelchair, follow a cam-programmed course through a normal plate or soup bowl, and deliver the spoon of food to a point where the patient with his limited range of head and neck movement can take the food into his mouth. The students earned warm praise from the youth, the therapists, and the head nurse, Ms. Lucy Dalicandro. We also received widespread newspaper and magazine coverage from the device and a three-minute filmed report on TV news programs.

The device, Fig.1, requires only limited motion of the neck or chin to contact switch devices to cause it to begin another cycle or to rotate the plate of food on a turntable mounted in the base. Motors and cams are hidden below the top plate, so the only parts seen on



Fig.1 - Feeding device for quadraplegics, demonstrated by Douglas Kennedy, one of the three students.

top are the food plate and a cylindrical column which supports the linkage to the spoon. It handles a wide range of foods including soup, soft foods and casseroles, fruit salad, sandwiches cut into bite-size pieces, and roasted nuts or other snacks. We are still working on improving the feeder, and intend to produce several prototypes this summer.

Our plans to increase the number of aids-to-the-handicapped projects in the mechanical engineering design course were accelerated by a call from Carol Abelson to bring half of the class, 23 students, to the Shriners Childrens Hospital of Montreal, where she is Director of Occupational Therapy. Here the class was able to observe the behaviour of children with athetoid and spastic cerebral palsy and form their own definitions of the problems faced in teaching and training them.

Some of the projects they designed and build in response to the apparent needs will be described later, but first the design methodology is discussed, since it is followed as a guide to ensure that the problems are correctly defined and that the greatest possible number of potential solutions are considered before narrowing to a single approach.

#### Engineering Design Process

The Engineering Design Process (Fig. 2) consists of five basic steps which are essentially the same ones followed in solving any day-to-day problem, in searching for alternatives and weighing the consequences of the decisions made. This chart has been kept simple to help the students apply it effectively, rather than to add phases and flow lines which would be followed only occasionally.

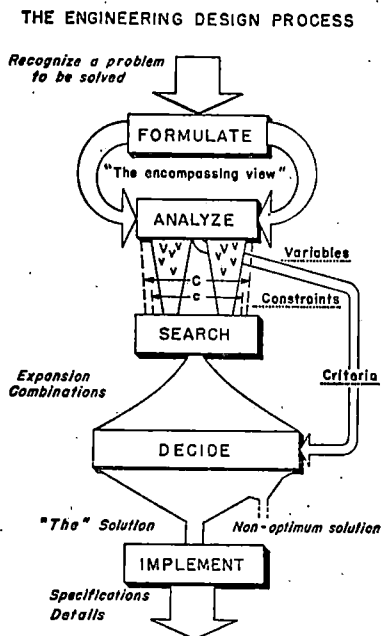

Fig.2 - The Engineering Design Process

Once the problem has been recognized, it is worthwhile to spend time trying to formulate it in a manner that seeks to uncover unstated aspects of the problem and reveal the true state of affairs before and after the solution has been implemented. We try to make the formal statement of the problem independent of any preconceived solution methods which might prejudice the outcome to solve only immediate difficulties and miss the larger implications. When the students observed the cerebral palsy patients they first saw limited fine motor abilities as the key part of the problem. Later they redefined it as the inability of the child to communicate and enjoy self-expression.

At this stage the incubation of ideas with later illumination at some unsuspecting moment should be allowed to occur naturally, another reason not to hurry through the design process. We encourage the input of information at this point through library research in engineering and medical texts and periodicals, at the same time cautioning the students that they may be misled by finding that previous workers have followed one well-worn path without being aware of other alternatives.

The width of the diagram indicates when the breadth of ideas is to be maximum; in both the formulation stage where an encompassing view is encouraged, and in the expansion of ideas that is part of the search for alternative solutions. Here we want to be sure that we have not missed any of the combinations, permutations, and inversions of variables that may be the key part of the invention. In the analysis phase the important constraints on the design are established to be sure it will meet given specifications, but attempts to over-constrain the design are resisted. The variables are also identified as those parameters which may be adjusted or combined to affect the solution.

The criteria are generated by this analysis phase. They are factors by which the merit of a given solution is judged. User safety, reliability, ease of maintenance and cost are almost always included in the criteria list.

At the time of decision, one best solution must be selected. If all possible solutions have been considered, the best will be the optimum. But knowing that time limits the search, we settle for the optimal solution, the best under the circumstances. Next the mechanics of specifying and producing the design must be carried out. If the criteria are wisely and justly applied, there should emerge one decisive solution, however, the chart indicates that the next best or non-optimum solution should be given close attention as well.

There are always a number of pit-

falls that the students discover in implementing a new design, and, for this reason, it is highly desirable to have a good back-up plan of a more conservative design which might be provided by the second alternative solution.

#### Student motivation in design courses

Therapy projects score very highly on motivating the students. They answer two needs that most students have: to do something useful for others and to create something new and different by themselves. As a matter of fact, one of our problems is to make the students aware of how time will escape them if they become deeply involved in the project, making it difficult for them to finish on time. Then it becomes hard to find volunteers in the next term to pick up someone else's uncompleted project and finish it, because it lacks originality.

Another factor that keeps the students working with enthusiasm is the feedback available from consultation with the therapist and sometimes from the patient as well when new ideas are tried out. Instead of working with textbook cases, they have a relevant situation involving human interest and judgement, and they react with heightened interest when told why some of their approaches are better than others. This is much better than hearing it from their professor, where they suspect that an arbitrary judgement has been levelled against them.

#### Scheduling the project

With such enthusiasm and interest on the part of the students, we have to guard against their putting so much time on the design projects that they neglect other course work and miss lectures. The students are mainly from the U-2 year at McGill, meaning that most have one more year of work before graduating. They have had one introductory course in design, one term in length, which is on the conceptual design level and serves to loosen up some of the entrenched thought patterns. This second course in design introduces the practical side of designing, with attention to materials, hardware, manufacturing processes, and design analysis. In each 13-week term the students should apply up to 10 hours per week to laboratory and outside preparation. They are told that this is roughly the same amount of time that they would spend on a project during a two-week vacation if they had nothing else to do. Also, they must realize that some of their time will be spent chasing around the city for materials and cleaning up after themselves in workshops.

We encourage them to manage their project time through the use of PERT critical path scheduling and we have computer programs to solve the networks and print out the estimated project schedule.

The exercise of defining and diagramming the activities that they must complete for the total project is also a help in organizing the project and planning for more than one activity to take place at the same time. Because of unforeseen delays and other changes, the data should be updated and the programs run several times during the course of the project to see what these changes imply.

#### Supporting the project

Some of the resources required by the students in addition to time are funding, machine tool facilities, and experienced practical advice. Most of the project budgets are supplied from the operating funds of the department, up to a level of about \$50 per project. When a project requires a key component costing more than this and it cannot be borrowed or paid for by other means, we utilize a special design engineering account, which is replenished by proceeds from other successful projects or from operating a Value Engineering course with student participation in projects sponsored by various industries.

The machine tool laboratory offers a wide range of modern machine tools with consultation and assistance by the staff in setting up and machining difficult parts. We also have a numerically-controlled lathe and milling machine which offer speed and flexibility in making parts with intricate contours or those required in multiple quantities.

To give the students the best available advice on the design of the parts and the selection of materials, we hire professional demonstrators with years of practical experience instead of the usual practice of using graduate students. With the combined experience of four consultants in diverse fields such as aerospace, hydraulics, process machinery, and instrument design, the students can find numerous suggestions to improve and augment their own designs.

Recent developments in therapy have shown increasing utilization of electronic devices. Integrated circuits provide complex functions at prices from 20 cents to a few dollars each and complete microcomputers cost only a few hundred dollars. This trend is bound to continue, and university programs in design should recognize that the best efforts will result from a blending of the electronic and mechanical capabilities. At McGill we have two ways of dealing with the situation. One is through interdepartmental cooperation with the Department of Electrical Engineering and shared supervision of projects. The other is through our own capacity within the Department of Mechanical Engineering, with two electronic technicians and several staff members with electronic backgrounds. The students appreciate the chance to augment their electronic courses by building

and debugging their own circuits, and help is usually available if they should run into trouble.

Projects completed or under way

The most successful projects were those in which the students availed themselves most of consultation with the therapists. Three of the most valuable aids, from the point of view of the therapists at the Shriners Childrens Hospital dealt with communications problems of the non-verbal child.<sup>1</sup>

The Wheel Selection Typing Aid, Fig. 3, allows the child to enjoy learning while playing at the motions of driving a car or bus. The padded steering wheel is turned easily at the rim or by bumping it with the forearm or any part of the hand, or by pulling on the spokes with the fingers. It moves a pointer across a high legibility alphabet chart and when the desired character is reached, pushing or pulling the gearshift lever causes the letter to be typed. The typewriter is a reconditioned business machine which was converted to electrical solenoid operation by one of the original three members of the team as part of a third elective design course.

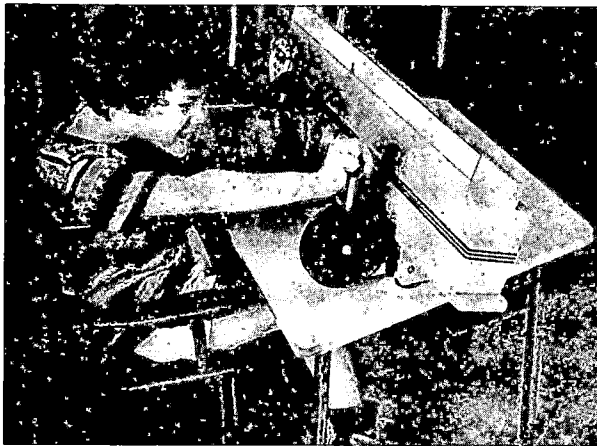

Fig.3 - The Wheel Selection Typing Aid

The Drum Selection Typing Aid is one of only a few projects which was totally mechanical. It has six levers which provide the column selection at a spacing which accomodates poor coordination of hand movements and reduces actuation of the wrong key by accidental touching. It mounts over the keyboard of a standard electric typewriter and pushes one key on the keyboard by a mechanical linkage that is selected by the rotation of the drum and the particular lever pulled. To change the six characters on the drum the child pushes or pulls the lever at the top of the device, exposing a new row of characters and setting up six other keys to be linked with the knobs.

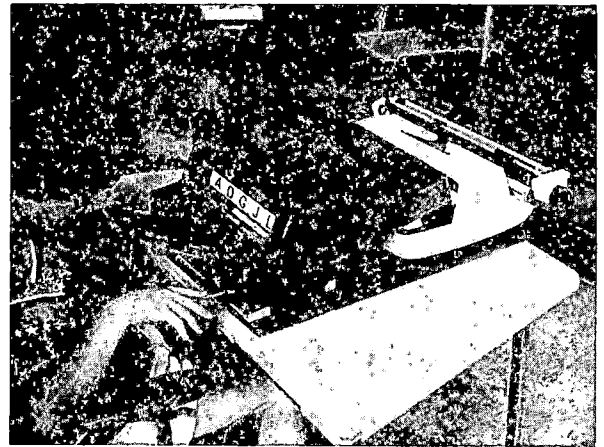

Fig.4 - The Drum Selection Typing Aid

The Seven-Segment Selector, Fig.5, allows the child to turn on or off seven lighted segments which are arranged in the familiar format of the number displays on digital calculators. The illuminated blocks are ruggedly built of plastic and may be hammered with the fist or open hand or pushed with the fingers.

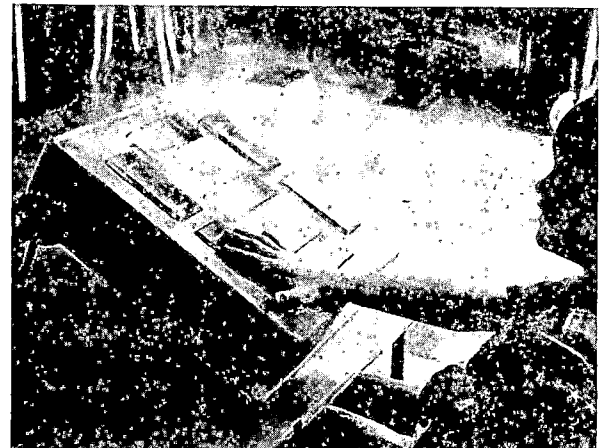

Fig.5 - The Seven-Segment Selector

Electrical outputs from these switches may be connected to a standard 0.6-inch high light-emitting diode display to light up the same bar pattern on this monitor, in a form that more closely approaches a large printed letter. Then by using the BASIC alphabet, a version of 7-bar codes first suggested by Jay Doblin<sup>2</sup> of the Design Planning Group, Chicago, letters may be represented.

A b c d e f g h i j k l n o p q r s t u v w x y z  
1 2 3 4 5 6 7 8 9 0

I have taken this concept a bit further and seven-segment-coded all the positions in the ASCII, or American Standards Committee for Information Interchange, code chart, Fig.6. ASCII is a standard form of intercommunication between teletypes, computers and graphic displays.

	0	20	40	60	100	120	140	160
0	NUL	DLE	SP	0	@	P	·	P
1	SOH	DC1	!	1	A	Q	A	Q
2	STX	DC2	"	2	B	R	b	r
3	ETX	DC3	#	3	C	S	c	s
4	EOT	DC4	\$	4	D	T	d	t
5	ENQ	NAK	%	5	E	U	e	u
6	ACK	SYN	&	6	F	V	f	v
7	REL	ETB	'	7	G	W	g	w
10	BS	CAN	(	8	H	X	h	x
11	HT	EM	)	9	I	Y	i	y
12	IF	SUB	*	,	J	Z	j	z
13	VT	ESC	+	-	K	[	k	[
14	FF	FS	,	<	L	\	l	~
15	CR	GS	-	=	M	]	m	}
16	SO	RS	.	>	N	^	n	!
17	SI	US	/	?	O	←	o	DEL

SAMPLE PhrAsE In the bASic ALPhAbEt.  
 thErE ArE 128 cOmBInAtIonS of the  
 7 SEGMENT bArS. 99 ArE uSEd In the  
 AbCzZ chArEt; the othEr 29 ArE AvAIL-  
 ABLE for SpECiAL control FunctIonS.

Fig.6 - ASCII Seven-segment conversion chart. ASCII character number (octal) is found by adding the row number to the column number. Dotted symbols print a blank.

This opens up a world of possibilities to the user. Computer programs may be written and executed, teletype messages may be sent, all by pushing combinations of seven switches. A "print" switch alongside the Seven-Segment Selector (not shown in Fig.6) will command the output of the selected character onto a teletype or video screen, and a "cancel" button will erase bars already lit.

Another project using this same idea has just reached prototype stage this May. A very small array of sensitive switches in the 7-segment pattern, with print and cancel, has been developed to be operated by tongue pressure by a quadraplegic. With this device, people who have been unable to communicate

except by blinking the eyelids will now be able to form messages, and with the 29 additional control codes turn on signal lights and ring bells for assistance. The function codes of ASCII, characters 1 through 37, may be assigned to operate devices in the patient's room, the TV, radio, lights, draperies, and changes in the position of the bed.

We have also considered the case of patients with normal motor abilities, who, being confined to a hospital ward, would like to use a typewriter, but cannot because of the noise and disturbance to other patients. Our class designed and developed a portable, battery-operated silent typewriter in a single term this spring. It uses a thermal print head in the 7-segment pattern to write from the back side of specially-treated paper in BASIC characters. This typewriter should see many more uses when it is coupled with a simple optical reader which scans the printed page and converts the symbols to any other type style, or transmits them at high speed to a distant terminal.

#### References

1. Abelson, Pfeiffer "Communication Aids for the Non-Verbal Severely Handicapped Child, A Multidisciplinary Challenge", Canadian Journal of Occupational Therapy, 42/4 Winter 1975.
2. Doblin, "Simplifying the ABC's", Industrial Design, 21/1 Jan./Feb. 1974

## DO-IT-YOURSELF KITS FOR THE HANDICAPPED

In order to combat the problems of high cost and complexity of aids for the physically handicapped, it is suggested that a course in practical engineering could be developed for the physically handicapped at the high school level, in which simple basic concepts in engineering are introduced along with "hands-on" experience in design and assembly through the use of simple "do-it-yourself" kits designed both to illustrate engineering principles and to serve as practical aids for the handicapped.

### I INTRODUCTION

This paper discusses some of the important issues arising out of a research effort to explore new ways of delivering rehabilitation technology to the handicapped community. This effort began with the perception that aids for the physically handicapped are often needlessly expensive and complicated. A major part of the expense is attributable to the labor costs of a highly trained specialist who assembles these devices. These aids could be made simpler and cheaper and therefore available to a wider marketplace if somehow the handicapped themselves were to become more involved in the design, building, and maintenance of their own aids. What follows is a discussion of a possible approach to this problem, which involves of teaching the handicapped some simple basic concepts in engineering technology and providing them with simple devices, in kit form, which they can build and maintain themselves.

In this approach, the designs are kept quite simple so that an average individual with a high school education can understand and deal with all the important mechanisms. Instead of investing a highly sophisticated technology in the devices themselves, the sophistication is invested in the tools, materials, and instructional techniques that allow the handicapped to design and create their own aids.

It is worth noting that this approach involves a combination of research in two areas that are not normally linked together into a single program. One area is the design and instrumentation of hardware for simple build-it-yourself kits and the development of tools for the handicapped to construct these kits. The other area is the development of classroom materials, texts, and methods which will make possible a course in practical engineering for the handicapped which provides hands-on experience in the design and maintenance of aids for the handicapped.

This program was undertaken as a joint effort of the Charles Stark Draper Laboratory and the Cotting School for Handicapped Children (formerly known as the Industrial School for Crippled Children).

### II BACKGROUND: THE PROBLEMS OF THE HANDICAPPED

The physically handicapped have a low visibility in our culture. One is often surprised to learn that the number of physically handicapped individuals in the United States is greater than 1% of the total population. Some estimates have been as high as 10%, or even higher when individuals over 65 or 70 are included in the tabulation. Although estimates vary, as one might

expect given various definitions of "handicapped", a conservative estimate is that approximately 3% to 4% of the population has some form of motor control or mobility problem that limits their employability. This figure is exclusive of individuals with perceptual problems and it does not count those of advanced age paralyzed for example by a recent thrombosis or myocardial infarction. This figure includes paraplegics, spastics, amputees, and the like, who have suffered either some neurological disease (e.g., cerebral palsy, muscular dystrophy) or a severe trauma (e.g., war wounds).

An ultra-conservative figure of 3% represents a population of about 6 million individuals in their early or middle years of life. This is a population one almost never hears about. It is a mark of our culture's fixation upon the so-called "beautiful person" that the problems of the handicapped are almost never discussed openly. The result is that the problem-solvers of the world, that is the scientists and engineers with the technology and the materials to solve these problems, are often unaware that a problem exists at all.

Moreover, those few scientists and engineers, who do take up the challenge of investing their technology in solutions to problems for the handicapped, typically approach those solutions with a perspective that is systematically inappropriate.

Engineers, almost unconsciously sometimes, strive for a design that in some sense "does everything", that hands one a world on a "silver platter". For example, engineers generally prefer to design a Cadillac rather than a Ford; the Cadillac is likely to incorporate more interesting gadgets. If it were possible for the Cadillac to serve one breakfast in bed, the designer would at least be tempted to include that concept in his design. The result is that engineers tend to create devices which in some way insulate the user from the process he is performing, just as a Cadillac insulates the driver from the road more than a Ford does.

In the case of the handicapped, this approach is precisely the opposite of what is wanted; the handicapped are already insulated from their world in too many respects. Ultimately this kind of approach turns what might otherwise be a widely accessible technology into an elite science understood only by a few; it promotes dependence, high costs, and even makes hidden mobility demands. In the end it serves to alienate the handicapped from a technology that they need most. The purchase price of a motorized wheel chair, for example, is higher than an expensive sports car.

Maintenance is even more expensive, since only a few are qualified to repair it. This means that the handicapped will probably travel some distance for maintenance and repairs. This seems like a poor solution for someone whose mobility is already less than adequate. The successful consumers of an elite technology require a high degree of mobility.

### III BASIC GOALS: SIMPLICITY AND INDEPENDENCE

1. An obvious solution to these problems is the design and development aids for the handicapped that insulate them less from the world by making them less dependent upon an elite technology. Devices that are simpler and easier to understand are devices whose maintenance does not make serious demands upon mobility.

Mobility constraints are becoming increasingly important, not only for the handicapped, but for the world as a whole, especially as the world's energy resources continue to be depleted. This suggests a need to transform the way engineering is taught in educational institutions so that the delivery of engineering technology to the community is more in keeping with the mobility and energy constraints on that community.

2. Another solution is to make engineering technology available to a wider audience. Engineering would be less likely to become an elite technology if it were to become part of one's normal high school education. Traditionally high school students have been exposed to science rather than technology. Although a few high schools have experimented with engineering courses, at present it is not one of the disciplines normally available in secondary education. Some high school administrators have expressed a concern that teaching engineering at the high school level would require an enormous facility because there are so many different forms of engineering (e.g., mechanical, electrical, aeronautical, civil, etc). Our experience, conducting classes covering a general introduction to the engineering sciences as part of the M.I.T. freshman seminar program, is that there is a wide set of perspectives and methodologies common to all the engineering sciences that could be taught at the secondary level. Indeed, if more high school students had had some exposure to the engineering sciences, they would be better able to decide upon an engineering major without a general introductory course in their freshman year.

3. The goal of every handicapped individual is independence and the freedom to participate in the world at all levels, in short to control their own destiny. This means independence in economic terms as well as psychological terms. The less an individual has to rely upon others for simple everyday tasks, the more productive that individual becomes in his community. The physically handicapped represent an enormous untapped labor resource. Many spend their whole lives at home idle. This resource has been difficult to tap in a systematic way because one individual's handicap is so different from that of another. Our approach to this problem is to teach each individual how to specify his own "kit" and to do his own custom fitting. This need not demand a great deal of expertise. Almost any device or

aid for the handicapped that promotes independence, however inefficient by ordinary standards, is bound to represent an increase in total economic productivity. A special tool, like a soldering iron or a wrench, that a spastic could use to design and build his own aids, is bound to result in some increase in productivity, especially if the alternative is remaining idle at home.

### IV TRADE-OFFS IN RELIABILITY AND MAINTAINABILITY

Engineering is as much an art as it is a science; it is not simply the practice of applying a theory or a series of equations to the solution of a given problem. As in the field of medicine, or any applied science, the engineer, first as a student, then later as a practitioner, forms a set of values which are not strictly quantifiable, nor even in some contexts rational. These values are the result of a slow evolutionary process, a kind of cultural development, based upon the accumulated experience of many years of many individuals practicing the "art" of engineering.

These values may play a more important role in determining the design of a particular device than do the theories, equations, and apparent tools of the trade. The possibility that present engineering practices are somehow systematically inappropriate for the handicapped makes it important to examine some of these values more explicitly than one might otherwise think necessary in an ordinary engineering program.

Among engineers, at least in this country, reliability has an unquestioned stature in the hierarchy of design values. There is a kind of tacit assumption that the consumers of today's technology are not smart enough to fix or maintain anything. This assumption may indeed be valid for the population as a whole; however, it need not be equally valid for selected sub-groups of that population. An uncritical acceptance of this assumption, and its corollary that the great mass of people are probably uneducatable and intransigent, understandably encourages engineers to design devices which require infrequent maintenance and that are failure proof within some specifiable and predictable lifetime. As a result the products of our technology fall into one of two extreme categories. Either devices have a long trouble-free life expectancy, are relatively sophisticated and therefore expensive to buy and costly to maintain when failures do occur (fail eventually), or else they are relatively cheap but have short expected lifetimes, requiring no maintenance and making use of throw-away materials like plastic and no-lube bearings. In either case, ease of maintenance is sacrificed in the interests of reliability.

Another related factor which affects the design of engineering devices is the cost and time of assembly. For all but the simplest devices, the costs of manufacture far and away outrun the costs of materials. Labor costs associated with manufacture represent a particularly sensitive area in which non-quantitative and irrational elements enter into decision making processes. For example, it is well-known that plant managers will opt for an automated assembly line over an "old-fashioned" manual assembly line even in cases where it is shown that the manual system is less

expensive. Reasons given for this choice include claims of higher quality control with automated systems, or the security that comes from being able to avoid unanticipated strikes. Enough subliminal elements of class-consciousness lurk in us all that it is doubtful whether any labor-management dispute has ever been settled totally within the calm and quiet dictates of reason. For similar reasons, our ability to evaluate the costs of labor in unfamiliar contexts (e.g., the handicapped community) is perhaps clouded with preconceptions and emotional bias.

It is interesting and instructive to imagine what the products of our technology would look like if we were to remove from the design decision all consideration of the labor costs of assembly, and substitute instead ease of maintenance. Suppose, for example, that simple mechanisms were constructed in such a way that a paper clip, rubber band, or other common household article, could hold a bolt or shaft in place. One might think that the do-it-yourself kit industry has had some motivation to do just this, since the labor costs here from the manufacturer's point of view are essentially free. However, there is very little indication that anyone is thinking along these lines. Perhaps this is because to elevate the value of maintainability over reliability is to violate our intuitive suspicion that everyone is too stupid to learn how to fix anything.

While this may be an appropriate attitude for the world at large, it makes sense at least to consider alternative policies for small parts of the world, and in particular for the handicapped who are not severely mentally retarded and can in fact be trained to maintain their own aids. The handicapped often have a lot of free time on their hands and so it seems to make particularly good sense to consider designs for this population that can take advantage of this free labor and time. This leads us to a consideration of designs that are not only less sophisticated in the sense that less education is required to understand the basic mechanisms, but also are less complicated in the sense that they can be assembled by someone with only gross motor control.

#### V THREE YEARS OF CLASSROOM EXPERIENCE

In the fall of 1972, the Draper Laboratory began an experimental class in introductory engineering, given to second year high school students from the Industrial School for Crippled Children. This class was sponsored by Project CITY (Community Interaction Through Youth, Erna Ballantine, Director).

Four students attended this class. Three had cerebral palsy and one suffered a congenital spinal injury paralyzing him below the waist. One student with cerebral palsy was a severely spastic quadraplegic.

Although the class began as a general introduction to engineering science, similar in format to the course given by the Draper Lab. to M.I.T. freshmen, it soon became clear that the students' own particular set of handicaps represented a much more interesting set of engineering problems than those presented in the usual introductory engineering course. Here was a case in which the engineering problems, if well

presented in class, would be clearly and immediately relevant to the students' own lives.

As a result, the course structure was redesigned, the original goals were reoriented, and the course became known as "Practical Engineering for the Handicapped". The class was continued in the 1973-74 school year with seven students from the Cotting School.

A variety of aids for the handicapped were designed and built in class. The students developed, for example, a mechanism whereby crutches could be made to fold to pocket size; they also developed a method for installing snow tire studs in crutch tips for use on ice and hard snow. A simple device, consisting of a few relay flip-flops, for decoding voice commands, was designed so that a motorized wheel chair could be voice controlled.

The most interesting device however was a machine which allows a spastic to type on an electric typewriter by actuating a few (in this case 6) micro-switches attached to various parts of his body, specifically those parts that the individual finds easiest to control. These switches, in various combinations, select and actuate, via a binary decoding network, solenoids which in turn drive keys on an ordinary electric typewriter. This device was designed and built in class at a cost of less than \$150. A comparable device sold as a ready made aid for the handicapped would cost between \$2000 to \$4000.

This device made it possible for the spastic in the class to increase his typing rate by a factor of three. Originally he could type no faster than 1 character every 3 seconds. After more experience with this device it is expected that his typing speed will increase by a factor of 10 or more. The success of this approach in this particular case was particularly heart-warming. This spastic has less than adequate speech control, so that a typewriter is his primary vehicle for communication with the rest of the world.

This is one example of a wide range of devices which could be used in a similar way as part of a course in practical engineering for the physically handicapped.

#### VI PROGRAM OUTLINE

##### (a) HARDWARE DEVELOPMENT: KITS, TOOLS & MODELS

The problem of designing aids for the handicapped that can be made in kit form for classroom assembly is a fairly straight-forward, although not trivial, problem. In the case of the handicapped the problems of safety from electrical shock, for example, are most important and are not always easy to solve cheaply. An important strategy, which we have been following, and plan to continue, is to keep things simple and to rely, whenever possible, upon "off-the-shelf" components with simple electrical interfaces that are available in sufficient volume to keep the unit price down.

In cases where cheap and simple components are not readily available, we attempt to devise simple tools to facilitate construction and maintenance of the aids. For example, the

solenoids in the electric typewriter driver mentioned above could have been rather expensive (i.e., \$2.00 to \$3.00 each, and 48 to 50 are required, one for each key). We have developed a technique which makes use of a bobbin winder on an ordinary home sewing machine, so that one may wind coils and assemble solenoids oneself. It turns out to be fairly easy to make or modify coil spools to fit the bobbin shaft. The central core of commercially made coils is often a flat piece of brass rolled into a cylinder with an open seam; it is therefore easy to expand this spool to fit snugly over the bobbin shaft.

Many of the devices in kit form require no special tools for assembly. For example, we are now working on a simple motor driven wheelchair, and we plan to develop a do-it-yourself hand control kit for an automobile for someone paralysed below the waist. Both of these devices are assembled with ordinary tools.

Although many devices will require no special tools, some undoubtedly will. Devices for spastics and quadraplegics represent a special class of assembly problems that will certainly require the development of special tools. In exploring solutions to this class of problems, we have been considering several designs for a device similar to a prosthetic training arm.

A training arm is a device that a nurse or physical therapist wears to demonstrate to a recent amputee the use of a prosthetic arm and hook. It sometimes takes the form of a gauntlet, into which a normal hand fits; a hook is attached to the gauntlet and is driven by straps attached to the shoulder or torso in the usual way for prosthetic devices.

Our experience is that many spastics suffer the greatest loss of control in the hands and extremities, and that torso control is often quite good. This fact suggests the possibility that a severely handicapped quadraplegic could regain a substantial amount of control by making use of a training arm whose extremity is actuated by the torso or shoulders. Special tools (e.g., wrenches and soldering irons) could then be adapted for easy operation with a hook.

Existing training arms are undoubtedly too heavy and in general unsuited for this kind of application. We have begun already, with the help of one of our mechanical engineers, who happens to be an amputee with an prosthetic arm, to explore new approaches to this problem. With careful consideration of the problems of stability, damping, and related dynamic control factors, for at least some tasks, it may be possible to achieve almost normal control. Although some experimentation has been done in the area of orthoses in past years, it is questionable whether the feasibility of this approach (i.e., linking orthoses with active control systems) has even been fully demonstrated. At this point however we feel that the concept appears promising enough to be worth exploring in some depth.

The problems of architectural barriers and the design of devices to improve mobility within an urban center is certainly an area that ought to be included in a general engineering curriculum. Practical "hands-on" experience in a classroom,

however, is usually not possible except through the use of scale models. As a result we expect also to explore the design of modular kits to study the problems, for example, of escalator design, ice-free wheelchair ramps, and a wide range of similar problems.

#### (b) DEVELOPMENT OF INSTRUCTIONAL METHODS AND MATERIALS

Films are an important vehicle, not only for documenting and evaluating an effort such as this, but also for teacher training by showing how these new tools and methods are used in a classroom situation. At present we have some 20 hours of unedited film of our classroom experiments, and we are always generating more footage with the help of the M.I.T. Film Department. We plan to produce about 3 half-hour training and documentary films of this effort.

The development of new classroom techniques and methods in some ways implies the development of new methods of evaluation as well. In any genuinely innovative effort, the possibility of failure is always imminent. One is therefore strongly tempted to establish weak criteria for success so that one may be said to succeed no matter what. In addition, the kind of criteria for success one chooses reflect one's level of understanding of the process to be evaluated. That level of understanding is bound to change as one proceeds through a new process. As a result, we recommend that researchers undertaking efforts like this one do not waste time trying to establish overly explicit evaluation criteria, at least in the early stages of the effort.

#### (c) EVALUATION METHODS

We have experimented with one evaluation method that looks promising enough to pursue in some depth. We approached a local high school for a list of recent school drop-outs (especially those who felt that school was irrelevant). As part of a "work-study program", we asked one of these students to attend one of our classes on a weekly basis, and to keep a journal or diary of all the things that seemed worth commenting upon for whatever reason. This "disinterested observer" is interesting in that we required no particular background in education or experience with the handicapped.

It is well known that outside observers are often helpful in program evaluation. Most instructors, and especially those working with the handicapped, become so emotionally involved with their students that objective evaluation is virtually impossible. An instructor, who spends most of his time encouraging, cajoling, and evaluating responses in terms of a student's potential, is not always in a good position to evaluate that student's actual performance. This is one of the reasons good educators often make bad administrators; a good administrator organizes his group or department in terms of the actual performance of his people, not in terms of their potential. Outside evaluators of programs like this are often themselves educators, and as a result have their own particular axes to grind and bring their own set of biases to the evaluation process.

What we are trying to do in this program is to respond to the needs of the handicapped on

their own terms, and with new perspectives that we hope transcend previous approaches in special education. This "disinterested observer" method appears to offer a broader range of perspectives, so that we can act both as an educator in responding to the student in terms of his potential, as as an administrator in evaluating the effectiveness of tools and educational materials that are developed in this program.

#### VII LONG-RANGE IMPACT OF THIS PROGRAM

It is often instructive, in evaluating proposals that promise somehow to improve the world or promote the betterment of mankind, to ask the author how he perceives the world would be different, say in five or ten years, assuming that the program succeeds in achieving most of its intended goals. The question really has two components: 1. What are the long-term effects on individuals both handicapped and normal? 2. What will be the impact upon the agencies and institutions that administer and deliver this new technology to the handicapped community?

1. Individual impact. A defect of many programs, which promise to improve performance or modify behavior, is that although they are able to show impressive changes on the short run, in the long run a kind of "Hawthorne effect" sets in, in which there is a slow return to former behavior patterns. Motivational background music in a clerical office is a well documented example of this effect; in the first month background music usually produces a dramatic improvement in the performance of clerical office staff; after the novelty wears off, there is a slow return to the previous output level. One may well ask whether there is any reason to believe that the initial performance improvements described in this report will not also in time suffer a kind of slow return to status quo.

An important key to the process of making permanent changes in an individual's behavior is somehow to transform the way that individual perceives the world around him and his place in that world. It is our conviction that giving a handicapped individual a tool, with which he can interact with the world in a new way, is bound to open up new horizons, and this is one of the surest methods of bringing about a change in perception at this level.

Developing engineering skills not only opens up new job possibilities, but also it affects ones vocational expectations in more subtle ways because it gives one a deeper insight into a wide variety of mechanisms in the world, and this in turn gives one more control over one's own destiny. For example, in this program a great deal of effort is expended in developing communication skills relating to engineering technology. In the case of the extremely and severely handicapped individual, whose motor skills may be too inadequate to solve even the simplest assembly problems, it is crucial that this person be able at least to explain to a technician, or perhaps just a friend, how to repair a broken electronic aid in a logical and easily comprehended manner. To the extent that one is able to master the technology that one depends upon, along with the attendant communication skills, one has less

mobility constraints; one is no longer tied to that rare technician specialist who happens to know how to repair one's crutch, wheelchair, or electronic device. Equally important is the fact that these communication skills prepare one for a wider range of vocational possibilities including administrative positions.

The promotion of less sophisticated technology and "do it yourself" kits could have a significant impact on the non-handicapped individual. Household appliances, for example, are prime candidates for improvement in this area. If dishwashers or washing machines were sold in kit form, and were simple enough to be put together by the average high school graduate, the costs of maintenance and repair would be dramatically reduced. The rising costs of energy have made us all more aware of the hidden costs of service. If energy costs continue to soar, it is clear that our present way of distributing and servicing the instruments of our technology will have to change.

2a. Institutional impact (education). An important implication of what has been said thus far is that growth in specialization need not continue in the future as it has in the past. This is particularly true of specialization in areas of technology that are widely used and are not therefore at the frontiers of development. As a given technology becomes commonplace, it is natural that that technology be introduced into the educational process at lower levels. Our present broad scale dependence upon technology makes it highly desirable to introduce some of the basic principles of engineering and systems design at the high school level. The handicapped community has an even deeper dependence upon this technology, which makes it even more important to introduce this technology to its consumers as early in their education as possible, and to link the educational system with research organizations so that ever developing new technology can get out into the field faster, without promoting over-specialization.

If this program is successful, the style of engineering education at the college level will also change. Engineers are now trained to take into consideration the time and cost of manufacture in evaluating potential designs. These time and cost considerations are typically in the context of present automation and assembly line techniques. Many good and useful designs are rejected out of hand because of time-consuming assembly requirements. However, if one considers the possibility of the handicapped assembling their devices themselves, the equations for determining cost-effectiveness are entirely different. The typical handicapped individual often has nothing, but free time on his hands.

Exposure to the problems of the handicapped could have an interesting effect on the way engineers approach wide range of engineering problems beyond those of the handicapped. Over-specialization in technology tends to promote highly sophisticated devices, which not only insulate the user from the process he is performing, but also makes the user more dependant upon that specialized, quasi-elite, technology. The sense of frustration that comes from not having complete control over one's life, a feeling

that every handicapped person knows well, is now shared more and more by everyone.

2b. Institutional impact (self-supported funding). It is the long-range goal of this program to achieve the same kind of independence at the institutional level that was promised at the individual level. With an economy that appears to be reaching the limits of growth, it is becoming increasingly clear that new programs, which require continuing support from federal or state tax funds, will have minimal chances for survival. This is no less true for new programs that aid the handicapped.

A good program, if it is widely perceived to be worthwhile, can often stand on its own feet, without additional support beyond an initial seeding phase. Our long-range plans include exploring the feasibility of creating non-profit organizations that compete in the commercial market-place with profit organizations, manufacturing and distributing do-it-yourself kits, and generating funds that can be used to support research and development of aids for the handicapped.

If one takes the energy crisis seriously, and begins to evaluate the energy and mobility requirements, not only of the handicapped, but of the world at large, it becomes increasingly clear that the technician-specialist, who is required by many widely used appliances and devices, is a very costly component in the overall system. The handicapped have always had to face the high costs of mobility. It is interesting that now, with the promise of ever increasing energy costs that affect everyone, the concerns of the handicapped and the non-handicapped are beginning to merge.

The return of cottage industry and the development of less energy intensive production methods is bound to have a decentralizing effect upon a broad range of institutions and funding groups. This in turn means that we can expect some erosion in the economies of scale achieved by large centralized institutions. Therefore it will be extremely important to study the trade-offs between the economies of scale and the costs of energy in order to identify organizations and institutions that can remain large and centralized and achieve some economy of scale without incurring increased energy costs.

However, the most important effect of a program like this at the institutional level, at least in the author's view, is that it requires a change in the institutions whose primary responsibility is the delivery of rehabilitation technology to the handicapped community. At present, this technology is delivered by physical therapists and prosthetists working within a hospital institution. The danger of this present approach is that the hospital environment can, and often does, foster an attitude of complete submission on the part of the patient. In this context, the patient makes very few decisions on his own but relies instead upon the suggestions of the medical staff even in such simple matters as the question of which wheelchair to select. In short, the hospital environment sets up attitudes which tend to inhibit one's taking command of one's own destiny. The approach outlined here suggests that educational institutions should become a primary focal point for the delivery of rehabilitation technology. In the Commonwealth of Massachusetts, Chapter 766 already represents a trend in this direction, although the full impact of this law, with all its implications for educational institutions, will not be understood for some years to come.

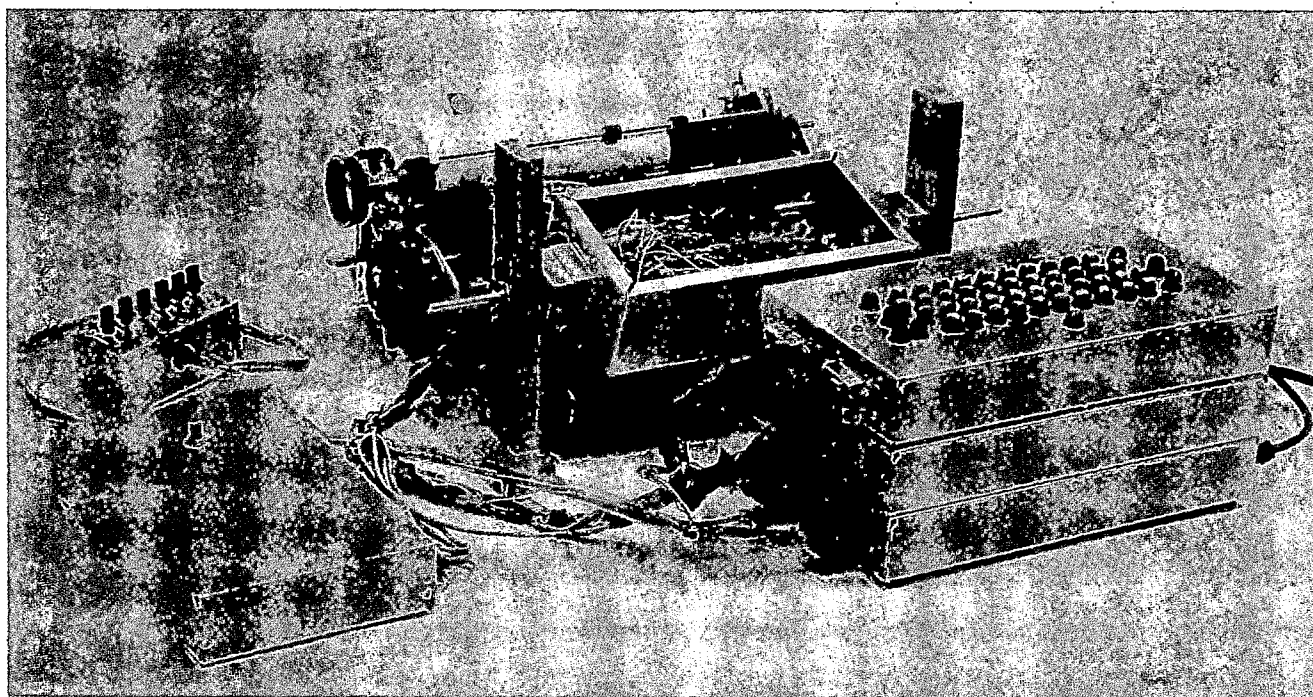

DO-IT-YOURSELF TYPING KIT FOR QUADRAPLEGICS

## TOYS AS LEARNING MATERIALS AND SENSORY ENHANCERS FOR HEARING IMPAIRED CHILDREN

by

Ronald Kemnitzer, MA  
Assistant Professor, Industrial Design  
Department of Art  
Michigan State University  
East Lansing, Michigan

The summation of a study to design toys for hearing impaired children that help provide the sensorial experiences necessary for successful language development and help develop the physical skills necessary for natural sounding speech. Research material is summarized and six toys of original design are described.

For many centuries play was regarded as a childhood diversion from the more important job of learning. Recently, we have begun to realize that play and learning are synonymous. Successful play, in fact, is a necessary prerequisite to the learning process. A healthy child will play for 10,000 hours before attaining the physical and mental skills that are necessary to begin formal education.<sup>1</sup>

Because of the tremendous importance of play, great attention has recently been directed towards the design of toys. Many toy companies have devoted significant effort and funds towards designing toys that are educationally enriching. These toys have greatly enhanced the play experience for many children by increasing the sensorial stimulation level. Sensorial stimulation of a child creates an awareness and understanding of himself and the world around him. Relationships, both physical and emotional, are established and a foundation of understanding is developed on which the learning process grows.<sup>2</sup>

Unfortunately, not all children are able to derive equal benefit from these toys. Hearing impaired children don't enjoy most of the audio stimulations of sound toys. Because of this, certain skills developed through sound play are retarded or non-existent. Their sense of rhythm tends to be undeveloped, resulting in awkward, un-rhythmic walking. Breath rhythm and control are undeveloped, resulting in poor speech rhythm with frequent gasps for breath. Since there is little auditory incentive in speech play, voices tend to be high pitched and un-rhythmic. There is little control over sounds, subsequently very little speech.<sup>3</sup> These problems represent a few of the complications generated by a lack of sound play.

A study of the relationship between hearing impaired children and play has revealed several important factors to consider in the design of their toys. Sensorial stimulation and training not only sharpens the intact senses of hearing impaired children, but contributes to their developing more normal speech. Sight exercises in infancy and childhood will later have a beneficial effect on the person's ability to lip-read. Active touch is essential for perceptual development.<sup>4</sup> The development of tactile sensitivity is essential to learning speech and rhythm. The children must be able to 'feel' the difference between words while holding their hands to the teacher's throat. It is most important to utilize the sense of hearing. Total deafness is very rare. In residential schools for the deaf in the United States, only three to four per cent of the children are totally deaf.<sup>5</sup> When this residual hearing is utilized to its fullest potential, its incredible value can be applied very effectively to speech development.

Research has indicated a strong relationship between sound play and the educational benefits of voice control, sense enrichment, speech rhythm, sense discrimination, and breath control. These relationships, in turn, indicate the potentially strong value of sound producing toys for hearing impaired children. The complications, however, are obvious. On the basis of four years of active design and evaluation of such toys, the Author is convinced of their play value to hearing impaired children as well as normal children. All of the toys have been designed with the premise that if sound could be reinforced by another simultaneous sensorial stimulation in an intact mode, the beneficial effects of music and sound play could be enhanced. This premise serves as the basis of rationale for the toys described in the remainder of this paper.

### Light-Sound Crib Toy

The Light-Sound Crib Toy hangs on the side of a baby's crib with the arm of the toy extending above the reclining child. Exposed to the baby's view on the underside of this arm is a series of six lights and an oblong shaped object which is suspended within touching distance. The oblong object contains a bell which rings when the object is touched. The object also contains a momentary switch which illuminates the lights in reinforcement of the sound. A crib toy of this nature is often the first play experience of a new born child. After repeated activations of the bell and lights, the infant comes to learn that it is his actions that are causing these sensorial stimulations to occur. The subsequent development of a self awareness is one of the first and most important of all play experiences.

### Light Rattle

The Light Rattle consists of a small battery suspended between two springs which are attached to light bulbs. As the rattle is shaken, the momentum of the battery initiates contact with one or the other of the light bulbs, creating a tactile and audio sensation accompanied by a colored light. The mechanism is sensitive enough that only a slight movement is necessary for activation of the lights, thus permitting visual tracking. The toy helps to develop eye-hand co-ordination and fine motor control. Free play with the toy encourages an appreciation and understanding of visual, audio and tactile rhythm.

### Tactile Turtle

The Tactile Turtle is a sound toy in the shape of that most familiar member of the animal kingdom. The Tactile Turtle has a large shell (approximately one meter long) through which sound is amplified. The shell vibrates with the same frequency as the sound being played. The eyes are made of light bulbs which are illuminated in synchronization with the sound. In a play situation, children can sit on or around the Tactile Turtle as they feel its vibrations, watch its blinking eyes, and listen to sound. With simultaneous tactile and visual reinforcements of the sound, a greater comprehension of the 'unheard' sound is established. Feeling the vibrations of the Tactile Turtle over a period of time will develop an increased sensitivity to tactile sensations. A common method of teaching hearing impaired children to speak is for the teacher to say a word while the child feels the vibrations of the teacher's voice box. The child then recreates this tactile sensation in his own voice box and consequently the correct sound.

### Light Whistle

The Light Whistle is similar to a conventional whistle with the addition of a very sensitive pressure switch, battery and light bulb. When the whistle is blown, a sound is created and the light bulb is illuminated. The light acts as a reinforcement for the whistle sound that might not be heard by a hearing impaired child. Free play with the whistle by groups of children will inevitably lead to contests of matching visual rhythms and keeping the whistle lit for the longest period of time. These games help develop the breath control and duration that so many hearing impaired children lack. By recreating the visual rhythm of a teacher's Light Whistle, students can be directed in exercises that induce the breath rhythm necessary for more normal speech intonation and duration. The Light Whistle is in the preliminary stages of manufacturing by Designs For Learning Corporation, Hinsdale, Illinois.

### Color Flute

The Color Flute is similar to existing toy flutes with the addition of color coded keys and a display panel on which the appropriate color is illuminated when a note is sounded. The lights are illuminated only when a key is depressed and the flute is blown sufficiently hard to produce a sound. The lights reinforce that sound which a hearing impaired child might not hear. The two rows of lights on the display panel are separately controlled. One row responds to the sounds being created by the flute while the other row is activated by a punched tape or similar control mechanism. This second row of lights is used to create a visual depiction of a particular song so that a child can learn the proper rhythm and note duration by matching the induced visual pattern. Breathing control and rhythm can be greatly refined using an exercise such as this.

### Tactile Light Show

The Tactile Light Show is a music appreciation toy for young adults. The toy consists of a display of red, yellow, and blue lights surrounded by four plastic panels. These panels function similarly to the Tactile Turtle's shell in that they vibrate at the same frequency as sound played through the unit. The panels are situated in such a way as to allow a person's knees to touch them when sitting next to the

unit. The sound is split into three frequency ranges and each is presented as a colored visual display in synchronization with the sound. Presentation on the sound in three frequency ranges allows for a more discriminating and exciting appreciation of sound than the Tactile Turtle. By playing a person's voice through the unit, a better understanding of speech can be developed and voice experimentation and control will be encouraged.

### Conclusion

The toys designed during the course of this project were directed specifically towards hearing impaired children and are therefore considered to be 'specialized' toys. Every effort was made to avoid making them so specialized that their play value decreased for other children. Although they provide certain experiences that are especially important for hearing impaired children, their educational and play value is at least equally beneficial for normal children.

It would be a serious mistake to view these toys as a solution to the many problems of hearing impaired children. The designs address specific problems such as the development of breathing rhythm, but it remains for educators to integrate the toys into the teaching process in a manner that will maximize their value. The design of the toys is but a humble contribution towards helping these children. A far more important factor is love. The love of a parent is essential for successful play. Without it there is no reason for play. There is only existence in a world that is confusing cold and silent.

### Footnotes

- 1 Creative Playthings, Guide to Good Toys (Princeton, New Jersey: Creative Playthings, 1973 ), p.7.
- 2 Irving S Fufeld, A Handbook of Readings in Education of the Deaf and Postschool Implications ( Springfield, Illinois: Charles C. Thomas, 1967 ), p.254.
- 3 Ibid., p.64.
- 4 Kenneth Bayes, The Therapeutic Effect of Environment on Emotionally Disturbed and Mentally Subnormal Children ( London: Gresham Press, 1967 ), p.41.
- 5 Fufeld, op. cit., p.56.

## BRIDGING THE HUMANIST-MECHANIST GAP: CREATIVE TECHNOLOGICAL AIDS FOR THE DISABLED

by

George F. Dalrymple  
Roger E. Kaufman  
Mechanical Engineering Department  
Massachusetts Institute of Technology  
Cambridge, Mass.

and

Mary C. Driscoll, O.T.R.  
Nancy Kamil, O.T.R.  
Occupational Therapy Department  
Kennedy Memorial Hospital  
Brighton, Mass.

### Summary

Electromechanical aids for developmentally and physically disabled children and adults are being developed by an interdisciplinary group of volunteers. Students, faculty, and professional staff from M.I.T., together with occupational therapists from Kennedy Hospital have been designing and building teaching and testing machines and developing associated learning materials.

This paper describes five of the 15 or so innovative devices that have come out of this project. Success of the prototype devices has led to the formation of a non-profit corporation, CTA. CTA's goal is to design, evaluate, and manufacture selected therapeutic devices and to make them available to other clinical centers and schools.

### Introduction

Children with learning disabilities or multiple handicaps are further disadvantaged in that relatively little engineering effort has been devoted to their unique therapy needs. This is unfortunate, because engineers could make a unique contribution. Flashing lights, colors, sounds, and motions could all be used to catch a child's interest, to motivate, to reward, and to turn what might otherwise be a dull and uninspiring drill exercise into a challenging and exciting game. Working together, therapists and engineers can come up with new electromechanical devices to reinforce specific therapy needs. Knowledge of LED's, digital logic, magnetic reed switches, gear-motors, and the like could be contributed by the engineer. The therapist could provide complementary insight into the perceptual, muscular, and cognitive interface with the patient.

This has been the philosophy of a joint project between Kennedy Memorial Hospital and M.I.T. This project started out in 1973, funded that first summer by the Student Summer Projects in Community Affairs Program and by the Undergraduate Research Opportunities Program at M.I.T. Students, faculty, and staff from MIT's Mechanical Engineering Department and Sensory Aids Center have been working with occupational therapists at Kennedy on devices for the following clinical problems: 1) Kinesthetic reinforcement for children with minimal brain dysfunction. 2) Perceptual motor communications (interactive electromechanical displays, patient

controlled projections, and sequential visual memory systems). 3) Eye hand coordination (electromechanical toys for severely handicapped and learning-disabled children). 4) Language communications (adaptive typewriter and keyboard for physically handicapped children).

Since that first summer, the project has mainly been carried out by students working on individual thesis projects, undergraduate research projects, or seminar projects under the direction of Professor Roger Kaufman. George Dalrymple has provided long term technical support for the project and has re-engineered several of the devices for manufacture. At Kennedy Hospital, Mary Driscoll has overseen the CTA project, while Nancy Kamil has supervised the field-test evaluations of the CTA devices.

Typically, what happens is the students spend some time observing patients at Kennedy and getting an intensive overview of different aspects of the Kennedy occupational therapy program. They then meet in brainstorming sessions at M.I.T., and each student carries out the design and construction of a different device. If possible, they try to carry the design from concept through to completion and early evaluation. Hopefully, the testing will prove to be non destructive, but several of the devices have proven to be inadequate to meet the stresses and strains imposed by a busy children's hospital.

Happily, a number of the devices have proven to be very successful. Some fifteen devices have been built or are under construction, but this paper will only describe a few of the devices which have had heavy clinical use.

### Magic Light Pen

Magic Light Pen consists of a pencil-like probe and a metal working surface. The probe contains an internal light and a metal point. Plexiglas paths or forms, designed by occupational therapists, are placed on the metal working surface. The child uses the pen and tries to keep it on the Plexiglas paths. The pen stays lighted as long as it remains on the Plexiglas path. When it strays onto the metal surface, the light goes off. Tracing is from left to right and at the end of the path a buzzer sounds to signal completion. Sequences

of Plexiglas patterns can be graded for simple coordination tasks, motor planning, and solving mazes.

Magic Lightpen has been field tested with 130 children, ranging in age from 4 to 12, whose diagnoses include learning disabilities, developmental delay, emotional disturbance and cerebral palsy. It has been used to facilitate development of eye-hand coordination and control, motor planning abilities and visual tracking abilities. Therapists have also seen improvement in the ability to cross the midline of the body without body rotation and improvement in the ability to approach Magic Lightpen tasks in a left to right manner. Increased attention span and involvement with Magic Lightpen has been seen with a number of children who were previously anxious and negative toward eye-hand coordination tasks. Due to the effective reinforcement which Magic Light Pen provides, impulsivity has been seen to decrease in a notable number of cases.

Skills developed through the use of Magic Lightpen are important in primary school performance. Eye-hand coordination and motor planning abilities are necessary pre-writing skills. Therapists have observed tracing and printing being done more neatly and more accurately, which would certainly increase a child's self-esteem. The development of visual tracking and a left-to-right task orientation are necessary for a multitude of academic tasks, including reading and all paper/pencil work done in the classroom.

#### Space Control

Space control is an eye-hand coordination training device. The child sits in front of a television screen covered with an overlay mask. By manipulating a joystick, the child can remotely position a small bright circle of light on the television screen. He can move this cursor either up or down, left or right, or at any angle.

The therapists have developed a set of overlays which allow various types of maze tracing and path following drills. These overlays consist of opaque masks with translucent or transparent paths. When the beam is properly positioned, the spot of light shows through the mask, signaling the child that he is "on target."

Typical masks consist of large letters of the alphabet, words, pictures, and figures on worksheets. The joystick's range of motion can be readily adapted to the motor capabilities of a severely impaired cerebral palsied child.

Space Control has been field tested in a clinical setting with 20 multiply-handicapped and learning disabled children, ranging in age from 5 to 11 years. Space Control has been assessed both an effective evaluative and therapeutic aid. Therapists have particularly commented on the flexibility of Space Control through use of simple overlays, as well as on its high interest level for children.

Space Control has aided in the evaluation of a number of physically-handicapped children whose disability prevented the effective use of standardized testing methods. Utilizing a variety of overlays, it has been possible to more accurately assess such a child's level of cognitive development

and to allow him to communicate his knowledge to us.

For both the physically handicapped and learning disabled child, Space Control has been an effective therapeutic tool. It has proven helpful in the development of fine motor control, motor planning abilities and visual motor integration utilizing shape, letter, number and maze overlays. In one case, a child was noted to develop some degree of compensation for a tremor through use of Space Control.

Space Control has been effectively used as well for the development of directionality and left-right concepts. By moving the joystick and therefore moving the lighted dot on the screen, children have been able to develop more complex spatial concepts, including direction, speed and distance. Children have also developed the concept of transferring movement in three-dimensional space (joystick) to movement in two-dimensional space (lighted dot on screen).

Through use of Space Control in all its flexibility, a child can further develop his fine motor and perceptual motor skills which are the foundation for successful primary school performance.

#### Secret Code

Secret Code is a sequential visual memory aid. It consists of a row of eight lighted push buttons - seven white ones and a red one which is separated slightly from the others. A sequence is loaded into the Secret Code and the child is expected to repeat the sequence.

To load a sequence, the LOAD/USE switch is turned to the LOAD position. Then the therapist presses the white push buttons in the desired sequence. After the sequence is stored, the therapist turns the LOAD/USE switch to USE.

The child now needs to reproduce the sequence, either working from a written list or from memory. If he pushes the correct pushbutton, it lights up. If he gets the wrong button, nothing happens and he can search around for the correct next button. When he finishes the whole sequence, the red button lights up, indicating completion of the task.

The red button also serves as a playback button. Pushing this button causes all the buttons in the desired sequence to flash on in order. This feature is useful for reinforcing the learning of a sequence. Overlays over the buttons allow one to store sequences of numbers, shapes, or letters. The heart of secret code is a shift register memory.

Secret Code has been clinically field tested by 10 therapists with 110 learning disabled and physically handicapped children, ranging in age from 4 to 14 years. It has been assessed as a highly valuable therapeutic aid by all therapists, due to its flexibility in use with children of varying skill level, its flexibility for use with the same child as skill increases, as well as for its notable motivational value.

Behaviorally, therapists have observed increased visual scanning and attending skills,

decreased impulsivity for typically impulsive children and increased motivation for a number of typically unmotivated children. Specific skill development, as reported by therapists, has included increased visual discrimination for shape, color, letter and number, increased short-term visual memory, visual sequencing and visual sequential memory for these same parameters of shape, color, letter and number. Secret Code has been used as well to teach a number of children to sequence segments of the alphabet. It has also been valuable as a diagnostic aid to assess whether a child is able to visually process information or whether he needs additional auditory cues as well.

Skills developed through use of Secret Code are highly related to academic tasks. Secret Code enhances the ability to attend to visual stimuli, a requisite for academic performance. Secret Code facilitates skill development on varying levels, ranging from visual discrimination to sequential memory. The ability to visually discriminate letters and numbers and then to sequence from memory is necessary for development of reading, spelling and arithmetic skills.

#### Bright Blocks

Bright blocks is an alphabetical teaching aid requiring eye-hand coordination. The child places letter blocks into holes in alphabetical sequence. The device consists of 3 rows of 9 holes. Associated with each hole is a brightly colored lamp.

Each letter block has a set of encoded contacts on its back. The coding is unique for each letter and is symmetrical for the symmetrical letters (H, I, O, S, and Z). When a block is placed in its correct hole, an electrical circuit is completed through the contacts and the corresponding lamp is lighted.

Each hole is independent of the others. If any block is placed into its correct position, its light goes on. It is not necessary for the previous letters in the alphabet to be in place.

Bright Blocks has been clinically evaluated with 35 learning disabled and physically handicapped children, ranging in age from 4 to 12 years.

Bright Blocks has been assessed by therapists to be a motivational learning device. Increased involvement with letters has been observed through use of this device with a number of children who had previously been anxious and resistant toward activities involving letters. Its flexibility as a therapeutic aid has been seen in its application with children of varying skill levels.

Specific skills development has included visual discrimination of letters, visual memory for letter forms and the ability to sequence the alphabet, in parts or in its entirety. Due to the effective reinforcement provided by Bright Blocks, children have also been seen to increase their perception of the correct spatial orientation of individual letters, including the concepts of right-side-up and laterality.

Involvement with letters and the ability to

discriminate and identify letters and to then sequence the alphabet are requisite kindergarten and first grade skills.

The device is not necessarily limited to letters. Numbers may be used instead of letters of the alphabet, or a larger device may be made which incorporates both letters and numbers.

#### Flash Word

Flash word is an eye-hand coordination and sequence training device. The child spells the name of the object pictured on a display card inserted into the device. He uses encoded letter blocks similar to those used by Bright Blocks. When a correct letter is placed in the correct location, the lamp below that block lights. When the entire word is spelled correctly the lights flash, signalling successful completion of the task. The present model has spaces for words having five letters or less.

The display cards are made of heavy paper stock. The bottom edge of the card fits through a slot over the series of contacts in the bottom of each pocket. Holes are punched to permit the contacts on the rear of the correct letter block to complete the circuit. Displayed on some of the present cards are pictures for the words "car, dog, house" and "clown." Other cards may be made as the therapist desires.

Flash word has been clinically evaluated by 10 therapists with 20 learning disabled children, ranging in age from 5 to 12 years, as well as within a public school system in Central Massachusetts with 6 learning disabled children in grades kindergarten through third. The school field test was coordinated by the Regional Reading Coordinator and was implemented by the Learning Disability Specialist and the learning disability technician.

Both clinical therapists and educators assessed Flash Word as being a motivational device, and were impressed with the children's high degree of interest in Flash Word activities. Skill development has included visual discrimination, visual sequencing, and visual sequential memory. More specifically, Flash Word has been seen as a valuable aid in developing the concept of sequencing letters to spell words. It has also been utilized for reinforcing memory of letter sequences for specific words. With further development of software, a cohesive developmental spelling program is envisioned.

Flash Word has been further adapted to include programs for part-whole relationships, as well as for use with functional signs in mathematical operations.

The skills developed through use of Flash Word are directly related to academic performance expected of the primary school child.

#### Program Summary and Projections

Since 1973, students, faculty, and professional staff from the Massachusetts Institute of Technology have been working with occupational therapists from Kennedy Memorial Hospital in a "Creative Technological Aids" (CTA) project. Brainstorming between the engineers and

therapists has sensitized each group to the problems and talents of the other. The engineers have learned of the needs of neuromuscularly impaired children and of the limitations of traditional therapeutic equipment. The therapists have been exposed to new ideas for teaching and training devices and they have learned something of the difficulties of engineering even the simplest electromechanical device to make it a practical reality.

About a dozen innovative new devices for therapeutic use have come out of this project to date. Several of these prototypes have been successfully used in actual clinical, diagnostic and therapeutic applications at Kennedy Memorial Hospital for Children. The Engineers have designed and built the hardware and the therapists have developed associated learning materials. Success of the prototype devices led to the formation of a non-profit corporation, CTA. CTA has recently received a grant from United Cerebral Palsy to develop a number of prototypes of "Magic Light Pen", an eye-hand coordination trainer. Eventually, CTA hopes to design, evaluate and manufacture selected therapeutic devices so they will be available to other clinical centers and schools.

The CTA Program is currently moving into a field test prototype development phase. For example, 30 field test prototype Magic Lightpens and associated developmental learning materials packages will be tested and evaluated in a wide range of clinical and special-educational settings. These field test prototypes will adhere to the original CTA formula: innovative electromechanical simplicity integrated with therapy-directed design to help the multi-handicapped, dysfunctioning person reach his own highest levels of performance. The CTA formula represents a new direction in economical machine augmentations of human performance. It fills a real need for closing the gap that exists today between what technology can economically offer and what therapy can creatively use, whether in enhancing the adaptive learning performance of children or rehabilitating adults with developmental or cardio-vascular accident disabilities.

#### Acknowledgements

The authors would like to thank the numerous students who worked on this project and helped to make it a success. They regret that it is not possible to name them all individually and give them the credit they deserve.

They also are particularly grateful to Robert W. Mann, Whittaker Professor of Biomedical Engineering for his continuing encouragement and for financial support through his professorship.

They are also indebted to the Clapp and Poliak Foundation for their vision in providing support for this and other creative engineering design projects.

Support from the Undergraduate Research Opportunities Program at M.I.T., the Student Summer Projects in Community Affairs Program at M.I.T., and United Cerebral Palsy is also deeply appreciated.

Mr. Dalrymple would like to thank the Rehabilitation Services Administration for partial

support of his work on this project under Grant No. 23 P555854/1.

#### References

1. Driscoll, Mary Cook, "Creative Technological Aids for the Learning Disabled Child: An Interdisciplinary Project," The American Journal of Occupational Therapy, Vol. 29, No. 2, Feb. 1975, pp. 102-105.
2. Bernstein, Marjorie H., "Toys for the Handicapped," Sunday Herald Advertiser, Pictorial Living Section, August 11, 1974, pp. 14, 18.
3. "Mechanical Aids for Occupational Therapy", Strides, Kennedy Memorial Hospital, Fall-Winter, 1973-74, p. 2.
4. Bullock, Ann, George F. Dalrymple and Janice M. Dana, "Communication and the Nonverbal, Multi-handicapped Child," The American Journal of Occupational Therapy, Vol. 29, No. 3, March 1975, pp. 150-152.
5. Kaufman, Roger E., "Electromechanical Aids for Handicapped Children," Proc. 28th Annual Conference on Engineering in Medicine and Biology, Sept. 1975, p. 194.

SESSION |



# SYSTEMS OF TECHNICAL SERVICE DELIVERY

DELIVERY OF TECHNICAL SERVICES  
TO THE HANDICAPPED CHILD

by

Erika von Kampen, M.C.P.A.  
Physiotherapist

Shriners Hospital for Crippled Children  
Winnipeg, Manitoba

Reinhard Daher, M.Sc.

Director of Rehabilitation Engineering  
Shriners Hospital for Crippled Children  
Winnipeg, Manitoba

Summary - This paper describes the Special Devices Program at Shriners Hospital, Winnipeg, Manitoba. One case history illustrates how technical aids were developed and fabricated to enable a severely handicapped child with osteogenesis imperfecta to become mobile and make it possible for him to attend a special school. Several other Special Devices which were developed or adapted for specific patients are described and shown.

#### Case History

K.R. was first seen at Shriners Hospital in March 1964, age 19 months. The diagnosis was "Osteogenesis imperfecta, severe type". His parents carried him in a carry-cot. The history revealed that he was born with multiple fractures. He never moved very much and had spent nearly all the time lying on his back. Kenny was admitted to the hospital for investigation and splinting.

On admission it was seen that the little patient was severely deformed in both arms and legs. His skull was flattened posteriorly, his chest was also flattened. He could only lie on his back. Nursing care was difficult as he was extremely irritable and afraid of being touched or moved. He did not even attempt to move his head, and he moved his limbs very little. His parents had brought a baby-tender in which they tried to prop him up for feeding. A splint was fabricated to hold Kenny's legs. This made nursing care and lifting him a little easier. He could go home using the baby-tender and the splint. (Figure 1)

When Kenny was 3 years old he had rodding of his right femur done. After spending quite some time in hip spica casts, a plastic posterior shell was fabricated supporting him from the mid-thoracic region to his toes. This made moving him around much easier and he was discharged home.

A year later rodding of the left femur was carried out and again Kenny spent many months in hip spica casts. Immediately after removal of casts anterior and posterior shells were fabricated. The shells were fabricated from Prenal and extended from head to toes. Very gentle physiotherapy was started to encourage active, purposeful movements in his limbs. Kenny started to spend some time lying on his stomach supported by the anterior shell. Much time and effort was

spent working on his head control. However, Kenny was very timid and afraid, and very little, if any, progress was made at this time. He was now 5 years old. On discharge from the hospital his parents were instructed in his care and in an exercise program.



Figure 1, baby-tender with splint.

In 1968 Kenny was admitted to the hospital again. He had outgrown the baby-tender and it was our aim to slowly bring him into a more upright position. A hammock type seat was constructed in the Rehabilitation Engineering Department. After some trials and errors a satisfactory seat was built for Kenny. He could now spend some time in a semi-sitting position and view the world around him from a more normal angle. It made watching T.V. much easier; and, using a bed-table, Kenny started some pre-school activities (colouring) and feeding himself. Attempts were made to straighten out his arms with splinting, but these were unsuccessful. (Fig 2)

The anterior and posterior shells were still used for turning and moving Kenny around. Physiotherapy and occupational therapy continued while Kenny was in the hospital and after discharge his mother worked with him at home. Progress was extremely slow, and by 1969 (age 7 years) Kenny was still not able to raise his head or hold it unsupported.

In 1970, Kenny was now 8 years old, plans were started to send him to a school for handicapped children. He was still not very mobile and this presented a great challenge to the Rehabilitation Engineering Department. He needed a seating device, possibly on a wheelchair base, which was also safe enough to allow transportation in a special school bus. There still was no bending at the hips possible. A special tilting

frame, which supported a custom made orthoplast body mold was constructed. A wheelchair base was adapted so the frame could be fastened to it securely. The frame on the wheelchair base could be tilted from horizontal to upright. A head band was used when Kenny was brought towards the upright position. This head band was also used for transportation in the bus. (Figure 3)



Figure 2, hammock seat.



Figure 3, wheelchair with tilting frame.

Kenny started school in Shriners Hospital. A special tray was made to attach to his wheelchair. (Figure 4) Very slowly Kenny's endurance and co-ordination improved. He could be up

in his chair a little longer every day and got used to the upright position. He learned to catch a soft ball and to hold his head unsupported for a few seconds.



Figure 4, tray for school work on wheelchair with tilting frame.

At this time a bath frame was also made for him. It consisted of an oval steel frame which held a plastezote board. This board was cut out for drainage and Kenny was lifted with this board into the bath tub. He used this bath frame for several years.

Consultations regarding Kenny's schooling were held with the School Board. Therapists from a School for Handicapped Children visited Kenny in Shriners Hospital and observed his activities. The driver of the special school bus came and inspected Kenny's equipment regarding safety for transporting him to school.

May 1, 1970 Kenny started at Ellen Douglass School. This was a great day in Kenny's life. He enjoyed school from the first day on and started to develop a more positive attitude towards life. He became less timid and got along well with the other children in school. Kenny was now getting an education and was able to socialize with children his own age. It also gave the parents a break from the continuous daily care of Kenny.

Intensive occupational therapy and physical therapy were continued in school with emphasis on head control and hip flexion. A more normal sitting position was the next aim. Slowly more head control was gained and the hips began to flex. In the fall of 1970 hip flexion was possible to 45°. Kenny learned to use an electric typewriter. A special table was made for him to hold the typewriter at a 30° angle, as this was the best functional position. He used his right hand for typing. Efforts continued to bring him into a sitting position. A new seating device with an adjustable tilting back support, flexing at the hips was made mounted on a wheelchair frame. (Figure 5) Kenny used this wheelchair in school only for as long as he could tolerate sitting in it. The design had to be improved to make it

safe for transportation. Kenny still used the wheelchair with the tilting frame for the rest of the time.



Figure 5, seating device allowing hip flexion.

In the spring of 1972 Kenny was able to sit for a reasonable length of time with some support. He could also get out of the posterior shell by himself and started to turn himself onto his abdomen. Kenny had never worn shoes, as he could not tolerate them. Some light shoes were made for him out of plastezote. After weeks of coaxing and training he started to wear these shoes. Since Kenny now showed the ability to sit for a while, the surgeons at Shriners Hospital decided to bring his legs into better alignment. Bilateral Sofield rodding of femur and tibia was carried out successfully. By the fall of 1972 Kenny was ready for a new seating device. The casts had been removed and knee mobilization started. For moving and carrying him around a polypropylene posterior shell was used, extending from the pelvis to the feet. New plastezote shoes were supplied at this time. A seating body mold with commode facility to be used for bathing and toileting was considered. However Kenny's parents indicated that they would not use this seat.

A home visit was made at this time by the Occupational Therapist. Kenny's parents were very reluctant to use technical aids in their home. The situation remains the same and they prefer to look after Kenny's daily needs without many special devices.

Our Rehabilitation Engineering Department had been working continually on plans for better seating for Kenny. In 1973 he received a new chair. The vacuum forming technique was used and the seat consisted of a fiberglass mold, padded and covered with vinyl. A special footrest, holding the ankles at 90° was made. The seat was mounted on a wheelchair base and could be detached for use as a car seat or floor seat (Figure 6)



Figure 6, wheelchair with molded seat.

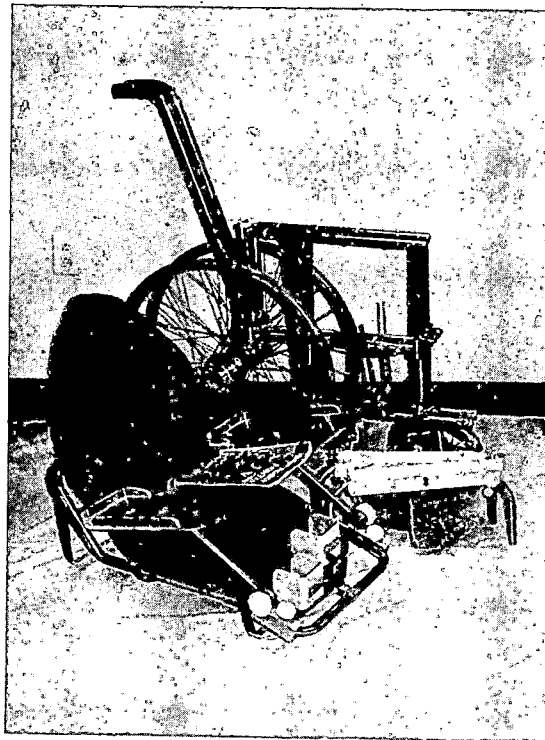

Figure 7, molded seat detached from wheelchair base.

Kenny was comfortable in his new chair, he only had one complaint: the seat got too hot. A terry towel cover was made and several holes were drilled in the seat to allow some circulation of air. This helped to a certain degree. Kenny used this wheelchair for approximately two years.

He learned to wheel it for short distances. His head and trunk control improved and by 1975 Kenny could sit unsupported for 8 minutes. As he spends a great deal of time at home on the floor, a small floor table was constructed for him.

In 1975 Kenny received an Everest and Jennings electric wheelchair. Again his special seating requirements had to be met and the electric control boxes had to be placed in a position that Kenny could operate them well. For the seating the vacuum forming method was used, taking into consideration that he was accustomed to a more upright position now. The leg rest was adjustable and elevated allowing some knee flexion. Kenny's electric wheelchair had two controls, one for driving the chair and another one to tilt the seat. It did not take Kenny long to learn how to operate the chair safely. Driving it gives him a great sense of freedom. (Figure 8) For home use and transportation Kenny has an ordinary wheelchair adapted for him.



Figure 8, Kenny in his electric wheelchair.

In summary this case demonstrates well the importance of a team approach to the many problems of a severely handicapped child. Over a period of 12 years this boy has needed a lot of medical attention, extremely good nursing care, many evaluations and re-evaluations of his physical and functional status, occupational therapy, physiotherapy, and the ingenuity and technical expertise of the Biomechanical Engineer and his department. His parents needed counselling and teaching. In combining all these efforts, this boy, who up to the age of 5 years hardly moved at all, now (age 14 years) is able to drive his own electric wheelchair and attends a school for handicapped children full time. At the present time he uses the following technical aids:

1. an electric wheelchair with special seat and special tray
2. ordinary wheelchair with a custom made seat

3. a reacher to turn water taps on and off
4. a pillow wedge for positioning (used at home)
5. floor table for home use.

Kenny uses an electric typewriter for his schoolwork and is a star pupil in the computer assisted learning program. Since he developed deafness during the latter years he wears a hearing aid.

#### Special Devices Clinic

When Kenny started attending Shriners Hospital in 1964 it was through our regular orthopedic outpatient clinic. In working with him and many other children who could benefit from the provision of a special device, it became obvious that better service to these patients could be given if they were seen at a special clinic. It took some time to coordinate the following disciplines into a team for the delivery of technical services to the handicapped child: Chief Medical Clinician, Biomedical Engineer, Occupational Therapist, Physiotherapist, Social Worker, Nursing-staff and Secretary. The Medical Clinician serves as the Director of the Clinic.

The Special Devices Clinic at Shriners Hospital started in the fall of 1972. Since then 2 clinics are held per month. After the clinics were in operation for about one year's time, we observed that we received many referrals from a school for handicapped children and from a hospital for mentally and physically handicapped children. We re-evaluated the scope of our clinic and it was suggested that we should hold a few clinics per year at these centres. After consulting with all people concerned we reserved three clinics for St. Amant Centre (a hospital for mentally and physically handicapped children), two clinics for Ellen Douglass School (a school for handicapped children) and one or two clinics per year for a pre-school centre. This means some travelling time for the members of the Special Devices Team from Shriners Hospital, however, it eliminates a lot of transportation for these severely handicapped children and their equipment.

In 1975 twenty-three Special Devices Clinics were held at Shriners Hospital, three at St. Amant Centre, two at Ellen Douglass School, and two at a pre-school centre.

The following routine is used at all of our clinics. The therapist assesses the child prior to the clinic to determine disability and remaining function. Time permitting, the biomechanical engineer is consulted at this time about special problems. The parents are encouraged to explain the difficulties they and their child are having in the activities of daily living and to make suggestions.

At the clinic the therapist presents the result of the assessment with comments and recommendations to the clinic team. A report about the child's home situation, schooling, etc., is given by the social worker. If the clinic is held at the school for handicapped children the teacher is present in most cases. He or she often has a special request or suggestion of what could be done to improve the child's physical function in the classroom. A discussion follows and the child is then examined by the chief medical clinician and the medical diagnosis is

reviewed. At this time the biomechanical engineer provides technical expertise regarding the design and application of a specialized device to meet the specific requirement of the child.

On the basis of the entire assessment medical prescription of the device is carried out by the chief medical clinician. This includes follow up and therapy if applicable. In most cases the child is measured on the clinic day for the technical aid ordered. At a later date the patient will be called for a fitting. The therapist involved with the patient should be present at fitting as evaluation, re-education and therapy are his (her) responsibility.

In some cases, e.g. if a very special custom made device for a multiply handicapped child, has been requested, he is admitted to the hospital. In this way the patient can be observed on a 24 hour basis and the best possible device can be designed, manufactured and assessed. Therapy and parent education go hand in hand with the delivery of all technical aids. A regular follow up and periodic re-evaluation is mandatory. All children grow and in some cases very frequent changes and adaptations to a device are necessary. Some children develop more functional abilities and after a time may require different technical aids.

#### Conclusion

The Special Devices Clinics at Shriners Hospital meet a genuine need for the delivery of technical services to the handicapped child in Manitoba and neighbouring provinces. The first and foremost objective of the clinic team is to give the best possible service to all patients referred to the clinic who could benefit from the provision of a special technical aid. Education of both parents and the public, is also a goal of the clinic. Research compliments the role of the Special Devices Program. Clinical and biomechanical theory and practice are co-ordinated in the design and development of improved special devices for handicapped children.

## THE REHABILITATION ENGINEERING CLINIC

by

Earl L. Gaddis  
Biomedical Engineering Center  
Tufts-New England Medical Center  
Boston, Massachusetts

Summary: The Rehabilitation Engineering Clinic is a client-service program for the New England region. It provides comprehensive engineering assistance to counselors and severely physically disabled clients. Services include a clearinghouse of detailed information on commercially available aids, and complete facilities for design, construction and modification of assistive devices. During the first year the Clinic has provided a variety of services to forty severely disabled clients, most of whom have spinal cord injuries. Most clients during this year were Massachusetts residents; in the future the Clinic will be expanding to serve more of New England.

### WHAT IS THE CLINIC?

The Rehabilitation Engineering Clinic is a client-service program of the Biomedical Engineering Center--part of the Rehabilitation Institute at Tufts-New England Medical Center in Boston.

The goal of the Clinic is to provide comprehensive engineering assistance to severely physically disabled clients.

Services include consultation with counselors, detailed information on the availability and suitability of adaptive devices, adaptation of existing equipment, and the design and development of special devices that cannot be obtained commercially.

### WHY WAS IT CREATED?

#### Problem: Lack of Information

Serving the individual vocational needs of severely disabled persons frequently requires that assistive devices or equipment be provided.

But it is often difficult for counselors, disabled persons and their families, therapists, or doctors to make the most effective choice of such devices. New products are constantly being developed; many old ones are being improved or discontinued; few counselors have the time to keep up with all the changes.

There are a number of information services available to disabled people and rehabilitation workers, such as ISAARE<sup>1</sup>, Accent on Information<sup>2</sup>, and the Green Pages<sup>3</sup>. These services can be extremely useful in locating the suppliers of commercially-available assistive devices.

But the counselor or consumer is still left with the task of comparing manufacturer's claims and trying to select the most appropriate device. This can be difficult and misleading: catalog descriptions rarely provide enough information about the applicability, reliability, and safety of a particular device to permit proper evaluation.

#### Solution: A Clearinghouse for Information

Counselors and disabled clients in New England needed a central clearinghouse that would give them simultaneous access to these and many other sources of information with a single inquiry. This clearinghouse had to include technical people on its staff whose engineering background and direct contact with equipment designers and manufacturers would permit realistic evaluation of the safety and reliability of each device.

But experience in rehabilitation and clinical background were equally essential. And it was important that each client be able to work person-to-person with someone on the staff who could talk things over in non-technical language, bringing out the practical questions and personal preferences that can play an important part in selecting the most appropriate device.

#### Problem: Custom Devices Needed

Standard assistive devices frequently have to be modified to meet the client's exact needs. And severely disabled persons may require special equipment that isn't commercially available. Facilities for designing and construction of such equipment are not usually readily available to disabled people.

In many cases a disabled person--with or without assistance--can invent devices or suggest modifications that could help increase his or her independence. Under certain conditions a do-it-yourself approach can be quite successful.

But even a seemingly uncomplicated device usually turns out to be a good deal more difficult to design and build than one might expect--particularly when one doesn't have access to the right combination of tools, parts, materials, and experience.

For a severely disabled person (such as a "high-level" quadriplegic with little or no use of the arms or hands) it becomes necessary to rely on someone else for the entire process of construction, fitting, and modification--even if the disabled person is able to carry out the entire design process independently. This can be

dangerous if the person responsible for building the device is not skilled and experienced enough to insure that the equipment will be safe and reliable, or if "make-do" compromises result from the limitations of someone's home workshop.

It has been proposed that "the most cost-effective adaptations are simple, low-cost modifications with implications for use by many disabled people in a variety of occupations."<sup>4</sup> This is a very useful design philosophy, but one whose limitations must not be overlooked. For someone with a very severe physical disability --such as paralysis from the neck down--complex and expensive devices may be required in order to provide independent mobility, control over the environment, and other functions that can be made much more easily available to a person who has some use of the hands. The Rehabilitation Act of 1973 requires that VR counselors provide needed assistance to severely disabled clients as well as to those with lesser disabilities.

#### Solution: Comprehensive Engineering Service

Disabled residents of New England needed access to a comprehensive engineering facility that could meet the requirements of counselors and clients for the design, construction, and modification of adaptive devices. This resource center would have the capability, the experience, and the facilities needed to produce complex and sophisticated devices when needed, but would concentrate on providing the simplest and most cost-effective solution to each problem.

Such a resource center would ideally house, and share staff with, the clearinghouse mentioned earlier. This would provide the equipment designers with detailed up-to-the-minute knowledge of the devices that are already available, enabling them to make the most intelligent make/buy/modify decisions for each client.

The Massachusetts Rehabilitation Commission, recognizing these two problems, granted funds in the summer of 1975 to the Biomedical Engineering Center to provide a comprehensive Rehabilitation Engineering Resource service for counselors and clients. The Clinic serves as both a clearinghouse for device and equipment information, and a facility for designing, building and modifying adaptive devices for the severely physically disabled.

#### WHOM DOES THE CLINIC SERVE?

During its first year, the Clinic has provided services primarily to severely physically disabled residents of Massachusetts: past and present clients of the Massachusetts Rehabilitation Commission, and others who meet MRC's eligibility requirements. Services are generally requested by an MRC counselor--but we have also responded to requests from hospitals, rehabilitation centers, schools, and consumer groups; from doctors and therapists; from out-of-state VR agencies; and directly from disabled individuals and their families.

In the future, as the Clinic expands, we expect to extend our services further into the six-state New England region.

This year most of our forty clients have been persons with spinal cord injuries; muscular dystrophy, cerebral palsy, and birth defects have also been represented. Of our SCI clients, the great majority are high-level quadriplegics.

#### WHAT DOES THE CLINIC DO?

Our primary responsibility is to locate or develop practical solutions to a wide range of problems experienced by counselors and their disabled clients.

Sometimes information or advice is all that's needed. For example, we were able to tell a spinal-cord injured girl in Massachusetts--who loved plants but was afraid she'd never be able to work with them after her accident--about a community college in Maryland that offers a new program in horticulture for the handicapped, complete with a greenhouse designed for wheelchair use.

In many cases we are able to locate a ready-made, commercially-available device that meets a client's needs without any modification. If the item is a relatively expensive one, we recommend that it be purchased by the client's local VR office. If it is inexpensive, we buy it directly and furnish it to the client immediately. This saves a great deal of time for everyone.

Often we are called upon to modify equipment already owned by a disabled person. One of our clients was a boy with muscular dystrophy who owned a Citizen's Band radio that he was unable to operate without a great deal of difficulty. We were able to solve his problem by designing a special knob with a long paddle and a one-way clutch, equipping the set with a feather-touch remote push-to-talk switch, and building a slanted mounting base that included a gooseneck microphone holder.

Sometimes the only practical solution to the problem is to design and custom-make a special piece of equipment. For example, we wanted to help a young man whose spinal-cord injury had completely paralyzed his arms and hands. He was an artist and had taught himself to paint and draw with a mouthstick. But he was only able to move his head enough to reach a few square inches of the paper. We developed an electric easel that allowed him to freely reach any part of the drawing paper (see Figure 1). By touching a convenient array of microswitches with the tip of his mouthstick, he controls a pair of motors that move the sheet of paper smoothly to any desired location.

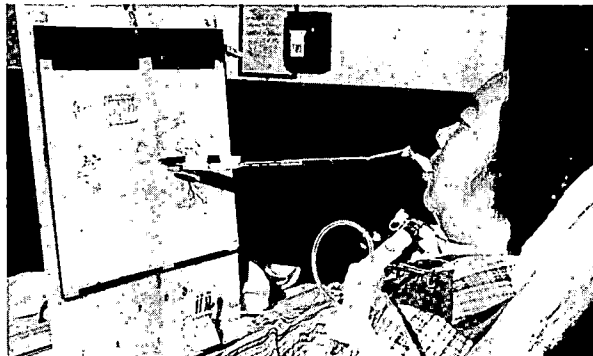

Fig. 1: Electric Easel

Some of the devices, equipment and services provided by the Clinic are:

- Electric wheelchair controls & modifications.
- Evaluation & selection of electric wheelchairs.
- Wheelchair accessories.
- Environmental control units.
- Appliance modifications.
- Hands-free telephone equipment.
- Automobile driving controls.
- Remote-control cassette recorders.
- Van lifts and modifications.
- Intercom, signalling and security systems.
- Non-Vocal communications equipment.
- Ramps.
- Feeding devices.
- Posture/support systems.
- ADL aids and accessories.
- Page turners.
- Housing modifications.
- Vocational assistance.

Although complex and sophisticated devices are sometimes required, we consider it important to make each piece of equipment as inconspicuous and unintrusive as possible. It must function, insofar as possible, as a natural extension of the person--not an additional barrier between him or her and the rest of the world.

Our aim is to provide ways of modifying the environment so that it interferes as little as possible with, and maximizes the individual strengths and assets of, the disabled person--rather than expecting the disabled person to modify himself to suit the characteristics of available devices.

For this reason, we involve the client as much as possible in the process of selecting, designing and developing equipment. This gives the disabled person maximum control over the characteristics of the device that he or she will be living with for a long time. It also helps us in our efforts to "de-mystify" technology and make it as comfortable, accessible, and understandable as we can. Technology should be at the service of the disabled person, not the other way around.

For example, a piece of equipment in a plain metal box, covered with dials and flashing lights, may be a cherished addition to a disabled gadgeteer's apartment, but the same device may clash so violently with another client's Louis XIV furniture that it will be a constant source of embarrassment and irritation.

However flawlessly any assistive device may operate, its design must also meet the psychological needs of the client--or it may very well wind up gathering dust in the back of a closet.

The importance of this factor cannot be overlooked, and one of the best ways to avoid such problems is to work with the client as much as possible at all stages of the development process. This also saves the disabled person the great frustration of waiting and waiting, while a mysterious device is being developed in an ivory tower somewhere by people who think that "professionals" must keep the details of their work secret from the clients they are supposed to be serving. We find that close involvement of the client usually makes it easier, not harder, to do

a truly professional job of device development.

## OTHER FACETS OF THE CLINIC

### Connection with Rehabilitation Institute

The BMEC is the research and development unit of the Rehabilitation Institute at Tufts-New England Medical Center. Clinic staff participate in rounds, interact with patients, and work with doctors and therapists as part of a rehabilitation-services team.

The concept of clinical engineering (proposed by the Veteran's Administration<sup>2</sup>, who will be telling you more about it later in this session) is a useful definition that describes this aspect of the Clinic's role.

### R&T Involvement

The BMEC is also a part of Medical Rehabilitation Research and Training Center #7--one of a nationwide network of about twenty R&T Centers established by HEW. Our work in such areas as communication aids for the non-vocal severely disabled population, vacuum-forming techniques for plastic orthoses, and clinical applications of biofeedback overlaps the other activities of the Clinic and provides many useful spinoffs.

An example is the Tufts Interactive Communicator (TIC) shown in Fig. 2, a device that allows a non-vocal severely physically disabled person who has only a single controllable muscle movement to type words and sentences at will.

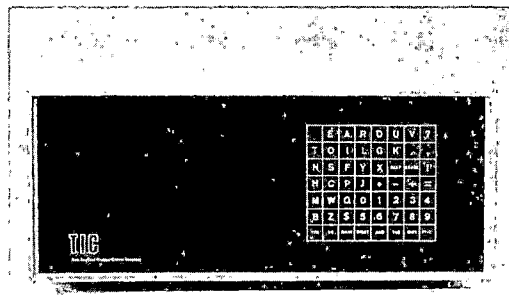

Fig. 2: Tufts Interactive Communicator

Our direct access to the projects being carried out by the other Rehabilitation R&T Centers allows us to make use in the Clinic of the latest research results and of new devices that are still in the development stage.

### Manufacture of Standard Devices

The BMEC's research, development and manufacturing facilities make it possible for the

Clinic to respond to the widespread need for certain devices that may not be commercially available in an inexpensive and reliable form that is suited to the needs of many of our clients.

The Clinic has been able to develop standardized versions of such devices that are designed to meet a wide variety of individual client requirements by the use of modular construction and the incorporation of multiple options that can be readily rearranged. We are then able to manufacture these items on a small scale, saving the final set-up step until the individual requirements of each client have been determined. This combines the advantages of off-the-shelf "standard" items (low cost, quick availability) with the "custom-tailored" features usually found only in one-of-a-kind special designs.

An example of this capability is the remote-control cassette recorder shown in Fig. 3. The one-switch scanning device that controls all the functions of the tape recorder can also control several appliances and generate an audio alarm signal. During final setup the modular circuitry can be easily arranged to provide eight environmental-control channels without a tape recorder, seven channels and the self-contained alarm, or any other combination desired by a particular client. The scanner can also function as a self-contained symbol communicator that allows a non-vocal person to select from an array of messages.

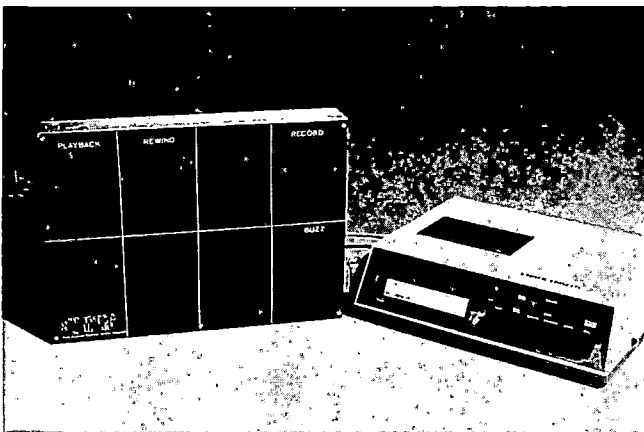

Fig. 3 Remote-Control Tape Recorder

### Conclusion

During its first year the Rehabilitation Engineering Clinic has developed into a useful and valuable resource for severely physically disabled persons and their families, counselors, doctors, therapists, and institutions. We are looking forward to its continued progress and expansion, which will include its transition to a self-supporting operation that will no longer depend on MRC for total grant support.

To take advantage of the services of the Clinic, write to:

Earl Gaddis, Project Director  
Rehabilitation Engineering Project  
Biomedical Engineering Center  
T-NEMC, Box 1014  
171 Harrison Avenue  
Boston, Massachusetts 02111  
Phone: (617) 956-5036 or 5037.

### Acknowledgement

This project was supported by an Innovation and Expansion grant from the Massachusetts Rehabilitation Commission.

### References

1. "ISAARE: Information System on Adaptive and Assistive and Recreational Equipment." Adaptive Systems Corp., 1975. Published by United Cerebral Palsy Assn., 7117 S.E. Harold St., Portland, Oregon 97206.
2. Accent on Information: Computerized Retrieval System. Accent on Living, Inc. P.O. Box 700, Gillum Road & High Drive, Bloomington, Ill. 61701.
3. The Green Pages, Inc. Directory of Products and Services for the Handicapped. 641 West Fairbanks Ave., Winter Park, Florida 32789.
4. Vocational Aids and Enhanced Productivity of the Severely Disabled, K. Mallik and J. Mueller, George Washington University; Proceedings of Devices and Systems for the Disabled, Krusen Center for Research and Engineering, Temple University, April 1975.
5. "The Clinical Engineer", A. Staros and E. Peizer, Veteran's Administration Prosthetics Center. Presented at the Winter Annual Meeting of Am. Soc. Mech. Eng., November 1973.

## TECHNICAL AIDS - SERVICE DELIVERY

by

Margret Perry, M.B.A.O.T., O.T. Reg.,  
Director Program Services  
Kinsmen Rehabilitation Foundation of British Columbia

The delivery of service in the field of electronic technical aids is in essence simply an additional tool for use by the rehabilitation team. In order for this tool to be used effectively an awareness of the potential of technical aids by all team members is essential. Assessment for technical aids, as in all pre-program planning assessment seeks to build a composite picture of the current status and future objectives of the disabled individual in question.

Many of the technologies at last being harnessed for use by those whose need is greatest, have been in existence for a long time. The need of the severely physically disabled to replace or assist functional activity is so very evident; why has there been this time lag?

Why, when new time and energy saving devices for the able-bodied appear in rapid succession, has there been so little available for the disabled? The reasons are many and all warrant investigation, in particular the most familiar one of high production costs and small market, when considering the comparative production techniques.

Rehabilitation personnel, Occupational Therapists in particular, place varying degrees of emphasis on the role of special devices when assessing and program planning for a severely disabled individual. The very human tendency to protect a disabled client may increase in relation to the degree of disability and possibly influence consideration of the total range of available options including electronic media, technical aids and devices for any of the following reasons:

- costs involved would probably be inhibitive,
- no knowledge of what is available,
- apprehension re lack of technical expertise/resources to confidently utilize seemingly complex equipment,
- client appears negatively biased toward any special devices,
- desired functions may be achieved by simpler means,
- technical aids may discourage client from maximizing physical function and in the long term reduce activity capacity.

The relevance of each of the above requires indepth analysis in every case, but to inadvertently relegate any feasible channel for improvement to the 'last resort' category is to render that channel grossly disadvantaged. Presentation by the rehabilitation team to the disabled individual of all the options, including those which appear negatively loaded is highly desirable in the majority of cases. A choice made from a comprehensive range of options is more likely to result in a positive action plan and a sense of

commitment.

### Service Delivery

The delivery of service in the field of electronic technical aids is in essence simply an additional tool for use by the rehabilitation team.

In order to use this tool effectively an awareness of the potential of technical aids by the entire team is essential. Initial assessment does not require extensive knowledge on the part of the assessor as to available systems and their mode of operation.

Assessment for technical aids as in all pre-program planning assessment seeks to build a composite picture of the current status and future objectives of the disabled individual in question. In addition to the standard personal and medical data, an indepth description is required of the physical environment in which the individual spends the greater percentage of time.

A functional assessment of all residual ability serves as a guide to the selection of the most appropriate and efficient interface. Of greatest significance is the statement outlining the functions desired by the disabled individual in order of preference.

The following four areas:

- personal and medical background,
- description of living environment,
- analysis of residual ability, and
- functional control requested, provide the structure for a relevant data search.

From this composite assessment the selection of the most appropriate control system is initiated and simultaneously consideration of the mode of control system operation or interface.

Ideally this second phase of assessment management should be the responsibility of an electronics engineer working in close cooperation with the assessing therapist. The time and effort gap between assessment and efficient utilization of the chosen system will vary with the complexity of the functional control requirements

and the degree of disability.

Any rehabilitation technique introduced to a client constitutes a form of intervention, which presumably will result in a change of the present status. Placing the emphasis on the clients expressed desire for change to improved functional capacity as a pre-requisite for eligibility for technical aids, reduces the possibilities of any resulting changes posing unforeseen problems. However it is essential that the potential for change offered by technical aids is thoroughly understood and all aspects negotiated by the client, the assessor, the engineer and those most closely associated with the client i.e. family or care personnel. The importance of the total involvement of the family or whoever is responsible for the personal care of the disabled individual in the assessment and orientation procedures cannot be overstated. They constitute vital elements in the environment and life style of the client and will therefore be equally subject to the effects of any changes which might occur as a result of any intervention including the application of technical aids.

The success of technical aids utilization is perhaps more dependent upon follow up than other procedures. Equipment problems essentially demand immediate diagnosis by an appropriately qualified technician - transmission of the diagnosis to the program coordinator and problem solving at the earliest possible point in time. Only if the client has reasonable confidence in the reliability of technical aids and the support services in the event of problems, can they realistically become an integral and meaningful part of his/her life style. The overall effects of service delivery in technical aids, like all other rehabilitation programs should be evaluated primarily by frequent measurement of client response.

Coordination of Canadian national awareness of the role of Technology in Rehabilitation, began in earnest in 1971 when through the determined efforts of the Honorable Walter Dinsdale, Q.C.M.P., an extensive demonstration tour by the Possum and Pilot groups from England took place, sponsored by the Federal Government and provincial agencies.

Following these tours the National Technical Aids Committee under the auspices of the Canadian Rehabilitation Council for the Disabled (C.R.C.D.) was formed. Chaired by Mr. Dinsdale, it consists of concerned personnel with a variety of relevant expertise and represents the interests of a number of provincial institutions, agencies and governing bodies.

The major phases of development in Canadian Service Delivery in the field of Technical Aids to date have been as follows:

- The formation of a Standards Sub-Committee and the acceptance of the resulting guidelines.
- The initiation of a comprehensive service delivery program by the Kinsmen Rehabilitation Foundation of British Columbia, a C.R.C.D. affiliate.
- The organization of an International Seminar on Electronic Controls for the Severely Physically Handicapped, by the Kinsmen Rehabilitation Foundation of British Columbia on behalf of C.R.C.D. aided by the Federal Government.

- The submission of 2 requests to the Federal Government, 1) for funds to organize a standardized procedure for cataloguing and evaluating Technical Aids (recently granted) and 2) for funds to provide a National Coordinator of Technical Aids and develop national program objectives under the Canadian Rehabilitation Council for the Disabled.
- Formation of four sub-committees to study the following areas of concern: Education  
Engineering  
Evaluation  
Service Delivery

Presently, in the area of Service Delivery, a national investigation is underway to facilitate the design and implementation of an information and service delivery program based on the needs of each province.

Those provinces having a service delivery agency are able to prioritize subsequent and essential needs. Those not having a service delivery agency obviously see education and centralization of information services as primary. Provinces where there exists a provincial service for prosthetic and orthopedic devices appear to have the expertise and the facilities to add Technical Aids to their scope. It is evident that in Ontario there exists a large amount of valuable experience and data that, if gathered and analyzed, would provide an inestimable resource for future programming.

The technology which has the potential to improve the level of independence of the severely physically disabled is available. The expertise to effect meaningful application is available. Undoubtedly disabled citizens are looking for options, and so the responsibility, desirability and need to coordinate effective service delivery procedures in the area of Technical Aids can no longer be overlooked.

THE CLINICAL ENGINEER:  
NEWEST MEMBER OF THE SPINAL CORD INJURY REHABILITATION TEAM

by

SALEEM J. SHEREDOS, B.E.E.  
CLINICAL ENGINEER

VETERANS ADMINISTRATION PROSTHETICS CENTER  
CLINICAL EVALUATION SERVICE  
VETERANS ADMINISTRATION HOSPITAL  
CASTLE POINT, NEW YORK 12511

ABSTRACT

The clinical engineer demonstrates the value of fulltime engineering support in the rehabilitation of patients within a hospital or clinical setting. This paper describes the various functions of a Clinical Engineering Service in support of the Spinal Cord Injury Service. It is divided into three sections, the first two separate direct patient care from other associated duties, while the third describes the array of equipment and devices the clinical engineer works with in the clinic. The Clinical Engineering Service, VA Prosthetics Center and the Spinal Cord Injury Service, Castle Point VA Hospital combined their efforts to improve the delivery of technology to the Spinal Cord Injured patient.

The Clinical Engineer, the newest member of the clinic team concept, is demonstrating the value of the engineering profession within a hospital or the clinical setting. The tremendous amount of sophisticated technical devices, aids and equipment being marketed and developed for use by the severely physically disabled necessitated the presence of an engineer on the rehabilitation staff. This paper describes the participation of a clinical engineer in the total rehabilitation program of the spinal cord injured person. The various clinical responsibilities and support programs described have evolved over the last several years as the result of the combined efforts of the Spinal Cord Injury Service (SCI), Castle Point VA Hospital and the Clinical Engineering Service (CES), VA Prosthetics Center (VAPC). It should be mentioned that the Clinical Engineering Service is organizationally responsible to the hospital's Chief of Staff. This paper is divided into three sections: the first two attempt to separate direct patient care responsibilities from other associated duties, while the third section mentions the array of special equipment and aids under the auspices of the clinical engineer.

#### Patient Care

The direct patient care responsibilities and duties of the Clinical Engineer include:

#### Monthly

The clinical engineer participates in monthly meetings of the Hand Clinic. The Hand Clinic Team is under the leadership of the Chief, Rehabilitation Medicine Service (RMS) and includes physicians from both the SCI and RMS services, an orthopedic surgeon, representatives from all RMS disciplines (Physical Therapy, Corrective Therapy, Occupational Therapy), a certified orthotist and the clinical engineer. Only a limited number of hospital patients and/or outpatients are scheduled, so as to allow sufficient time for each. The patient's physician gives a short pertinent history, diagnosis, motor and sensory level, and psychological status. The Occupational Therapist then describes the patient's functional use of his upper extremities plus any pertinent social and vocational goals achieved including the use of specific adaptive devices and aids, if any. Next the team evaluates the present condition of the patient's upper extremities and discusses with him his future goals. After the evaluation has been completed, the team discusses possible specific solutions to improve the function of the patient's upper extremity, e.g., a passive orthosis, a wrist-driven flexor hinge splint, an extremity-powered orthosis, a myo-electric controlled orthosis, or in some cases, surgical procedures. A prescription is written and the patient is scheduled for a follow-up evaluation. All during the evaluation, the discussion, and in the actual prescription writing, the clinical engineer participates as an integral part of the Hand Clinic team and brings to it his technical knowledge in the use of externally powered orthosis and modifications of currently available systems. In addition, he feeds back clinic information to the developers of advanced technical systems, such as electrical stimulation, and when they become available, introduces the use of such systems into the clinic.

The clinical engineer participates in the following weekly events: The Grand Rounds for the SCI and RMS Services takes place every Monday morning. A meeting presided over by the Chief, SCI, is the first order of business. The meeting and the following rounds include the Chief, RMS, ward physicians, SCI clinical coordinator, head nurses, and the clinical engineer. During this meeting any problems, findings, solutions or other matters of interest on SCI-RMS patient care are discussed. After this half-hour meeting, rounds of all patients on the SCI-RMS wards begins and lasts approximately 2 hours. Each patient's present condition and progress is reviewed by all present. The clinical engineer has the opportunity to review patients who are using devices and equipment introduced by his service with the team. The clinical engineer derives feedback from the patient and other members of the team during these rounds. He becomes familiar with the patients and their various conditions and learns of medical complications and patient limitations which otherwise might not be apparent. From these rounds a direction for a portion of the week's work schedule originates. This might include initiating, modifying, or changing special devices, according to the patient's progress, e.g., a recently injured quadriplegic patient may require pneumatic interface for his environmental control system or electric wheelchair, etc. As he progresses, this may change to a hand interface, or even the complete elimination of any special interface.

The Multi-Disciplinary Committee on Prosthetic Appliances and Accessories meets every Wednesday morning from 8:00 to 9:00 A.M. The Committee's purpose is to establish and monitor protocols for consultation, evaluation, prescription, and purchasing of prosthetic appliances and accessories. A second continuing goal is to screen all requests for prosthetic appliances and other devices, to insure that the patient will get the best, the most functional, and currently available equipment, aids and devices to suit his particular needs. The Committee, chaired by the Chief, RMS, includes physicians, therapists, nurses, an orthotist, and the clinical engineer. The clinical engineer serves as the technical advisor to the committee on the various appliances, and keeps the members abreast of the latest available devices, aids and equipment.

The Spinal Cord Injury Conference convenes every Wednesday morning from 9:00 to 11:00 A.M. Generally, selected patients are presented for review at this time, but one conference each month is set aside for each of the respective services to describe and discuss its particular function. The conference is attended by representatives from all of the medical and paramedical services involved in caring for SCI patients. The patients are presented either for initial evaluation, re-evaluation, discharge planning, or placement. All team members discuss the patient's present status, progress, and future goals. Discharge planning or placement may take several directions. It may apply to the patient's own home, where he may be attended by the Home Care Unit for a time, or to some extended care facility. The clinical

engineer, as do the other team members, discusses the patient's progress toward that service's goals, which must be integrated with the total goals for the patient. The patient and his family may be present during this discussion, or they join the conference immediately following the team's individual reports. A discussion by all present on the patient's current condition and future goals follows. At a later date the clinical engineer, together with the occupational therapist and the corrective therapist, may be required to make a home visit to evaluate "accessibility" in the home and to determine what special equipment will be needed, e.g., a porch lift or security system.

#### On Call Daily

The clinical engineer is on call daily for the following:

Evaluation for the prescription, ordering, installation and modification of special devices for SCI patients in the hospital.

Active participation with the Home Care Unit. The clinical engineer must help evaluate the needs and requirements of the patient living at home. This usually involves making an analysis with specific recommendations for accessibility in and around the home, and the evaluation for special equipment and devices to give the patient increased independence and/or security, e.g., a security system or an environmental control system. Purchasing information, device check-out, installation, follow-up, and maintenance constitute the clinical engineer's total responsibility.

Working with Social Service and other Services on the special needs of the SCI individuals for his vocation, e.g., modified vans or special telephones.

The complete preventive maintenance and repair of all special equipment and devices on the SCI wards and in the home.

#### Associated Duties

Proper planning, scheduling and follow-up procedures; file system and inventory; integration with other Services; keeping abreast in the field on new products and developments; continuing education, both formal and informal; documentation; record keeping; entering pertinent information into the patients' medical record; communication channels with peers in the field locally, nationally and internationally are all a part of the total responsibilities of a clinical engineer.

Technical support is given to the Hospital Director, the Chief of Staff and the professional services in reference to special equipment and devices for the severely physically handicapped.

A wheelchair repair service operated by paraplegic and quadriplegic persons was initiated. Several wheelchair patients were trained to repair and service conventional wheelchairs. A work bench and ramped work platform were designed and built for their use. The trainee patients are instructed on inventory; ordering

replacement parts, the use of company wheelchair manuals to identify parts, and the complete servicing of the various types of chairs.

Instructional and training sessions are held as needed for patients and their families and/or hospital staff on these special devices and aids.

Several one week courses were held in the past for V.A. Clinical Engineers whose hospitals care for severely physically disabled persons.

Evaluation of special devices, which includes an engineering analysis, safety checks and clinical trials is conducted. This may involve writing a protocol, integrating the device into the clinic, monitoring the clinical trials, documentation, and reporting the results to the hospital's appropriate committee.

The clinical engineer is often involved in clinical studies which involve advanced design devices and/or new concepts, e.g., a study on functional electrical stimulation of paralyzed muscles is presently being conducted by the CES.

A complete inventory, distribution record and evaluation reports on devices and equipment deployed by the V.A. Prosthetics Center Technological Utilization Program are maintained by the CES.

Community involvement to aid the mainstreaming of the physically disabled living in the community. This clinical engineer initiated a program of community awareness on architectural barriers. This included newspaper articles, talks to concerned groups and the local town planning boards, and distribution of pamphlets on accessibility standards and specifications.

The CES supplies technical information and services for the hospital's medical and professional services aside from those mentioned above, e.g., designing and specifying closed circuit television for nursing, staff and patient education; proximity switch deactivation of electrical power to motorized doors to avoid accidental use when the door is locked. (The manufacturer does not offer anything to prevent this problem!)

#### Equipment, Devices, Aids

Mentioned below are examples of typical types of equipment, devices and aids which are presently available for the clinical engineer's use in the clinic. This is by no means an exhaustive list, but rather a selected list to illustrate the range of equipment that the Clinical Engineer must be thoroughly familiar with.

Mobility Aids: Hand, chin, vocal, pneumatic, etc., controlled indoor and/or outdoor wheelchairs or powered standing ambulators.

Driving Systems: Adaptive equipment, aids and modifications to automobile and vans, e.g., mechanical or servo hand controls, wheelchair lifts or powered doors. The clinical engineer has to establish a working relationship with a local mechanic to supervise and advise him in the installation, maintenance and repair of these systems on patient vehicles.

Body Support Systems: Special beds, mattresses, wheelchair cushions such as air, water, foam and mud support medium for the prevention and care of decubitus ulcers. Devices to support the patient while sitting in a wheelchair.

Lifts/Transfer Aids: Hydraulic, mechanical or electrical lifts for transferring patients into/out of beds/wheelchairs, baths or vehicles.

Environmental Controls: These systems in varying degrees allow severely disabled patients through a single input control (such as hand, sip-n-puff, eye movement, vocal or chin control) to operate the nurse call, alarms, a telephone, bed controls, television/radios, etc. Security systems consist of a closed circuit television, intercom, electric door release and a telephone. And the latest development, which is bringing remote manipulators closer to clinical use.

Prosthetics/Orthotics/Orthopedics: This includes myo-electric, electromechanical or pneumatically controlled externally powered orthotic systems, as well as pneumatic orthoses for the lower extremities. Just beginning is functional electrical stimulation of paralyzed muscles to obtain function. This will need much clinical engineering support to start gaining the needed experience and information for the refinement of these systems, advancing them from the research stage to clinical use.

Communication Aids: This category includes telephones, typewriters, emergency telephone dialers, message communicators as well as a voice synthesizer for those with impaired speech.

Activities of Daily Living: Feeding aids and other devices, and special bathing devices.

Recreation: Modified pin ball and other electronic games which can be operated pneumatically and/or by hand. It allows the handicapped individual to compete with other handicapped persons or non-handicapped persons.

#### Conclusion

This description of the responsibilities, duties and work load of the Clinical Engineering Service in the Castle Point VAH Spinal Cord Injury Service clearly demonstrates that the clinical engineer must devote his full attention and time in the clinic in order to give proper and needed support in the total rehabilitation of the patient. The author's experiences thru the above mentioned program prompts him to say that if an engineer is to practice his profession in the clinical setting, he must remember to always consider the human element when working with patients and the medical staff. He must be understanding and patient; ready to explain in non-technical terms the purpose and functions of the technical devices; ready to try again the next day; and to realize that patients, families and medical staff all have a "gadget tolerance" beyond which you can not go.

## DEVICE - AIDED FAMILY CARE OF A SEVERELY HANDICAPPED PERSON

by

Victor A. J. van Lint, Ph.D.  
Mission Research Corporation  
7650 Convoy Court  
San Diego, CA 92111

We report on nine year's experience with a quadriplegic with speech deficiency in the family environment, assisted by non-professional aides, in using devices to improve her comfort, mobility, function and communication. Devices used include alternating pressure air pads, electric wheel-chair, mobile left arm support with electric typewriter, NIRE speech amplifier, hydraulic lifts, AUTOCOM communication board and wheel-chair lift for a van. June functions at home, shops, travels and has authored a book.

### Introduction

Advances in medical treatment have enabled persons with severe physical disabilities to continue to live. One of the prime functions of systems and devices for the disabled should be the improvement of the quality of that life. We can form a hierarchy of needs to be satisfied for the severely handicapped person as follows:

1. Basic life functions (e.g., nourishment, breathing, elimination).
2. Prevention of severe discomfort (e.g., decubitus).
3. Communication (i.e., ability to affect one's environment).
4. Mission (e.g., raison d'etre).
5. Mobility.

Traditional medical care deals with life function and the prevention of complications resulting from ancillary insults to the body (items 1 and 2 above). At step 3 and beyond, the relationships between the disabled person and people outside the medical community becomes important. The members of the outside community who can have the most beneficial effects on these "quality-of-life" needs are the disabled person's family. Their reaction and support influences strongly whether the disabled person remains in protected seclusion or exposes himself to the risks and rewards of outside encounters.

The function of aiding devices must be evaluated in terms of their benefits to both the disabled person and those with whom he interacts. For example, a communication aid that requires the observer to pay attention while a severely disabled person slowly transmits a message (e.g., a plain letter/word board) is much less likely to be used for longer messages than one which allows the observer to do something else until the message is complete (e.g., a letter/word board with typewriter output).

This paper summarizes the experience of one disabled person, June van Lint. Ten years ago, at age 38, she was subjected to midbrain damage, probably due to a blood clot in the basilar

artery, which left her almost totally paralyzed. During ten months in various hospitals she recovered a small amount of motion in her left hand and arm, and re-acquired reasonably good control of her head and face. Her breathing remains totally involuntary. The bulbar functions (e.g., swallowing, coughing) are by reflex only. Speech is almost soundless (until an emotion deepens the breathing), but understanding is aided for those familiar with her by lip reading.

June's immediate family consists of four children, who ranged in ages from 2 to 9 at the time of the accident, and a husband, who as an experimental physicist is not too hesitant to try new things or to deal with electronic gadgetry. As it turns out, his training has not been needed to use or maintain most of the useful devices. She has had a 40 hr/wk aide, generally one with no medical training, or, at most, a nursing aide background.

We now present June's experiences in the areas listed above. We will then indicate the types of improvements that we now recognize to be desirable. It should be noted that many desirable device features are unsophisticated, but it is very difficult to anticipate the need without experiencing the life of the disabled person.

### Meeting the Needs

#### Basic Life Functions

June's breathing is autonomous. It deepens only when she becomes emotional - angry, empathetic, joyous, laughing, etc. She cannot voluntarily clear her throat. A serious obstruction produces a reflexive cough. A minor one is best cleared by inducing laughter. Otherwise, the discomfort will eventually be cleared by involuntary crying.

June can eat blended foods. She can chew, but her tongue doesn't have the skill to sort out food particles to be chewed from those to be swallowed. Swallowing is also reflexive, depending on chewing and food approaching the esophagus. June's adaptation to eating away from home was materially improved when a friend discovered a

small baby-food grinder that can be operated with only two hands (Fig. 1).



Fig. 1 - Eating aids - straw clip, blender, portable grinder

June can suck liquids through a straw, preferably slightly thick liquids (e.g., tomato juice, milk, etc.). Again, the sucking-swallowing process is primarily reflexive. Since June's teeth may involuntarily clamp down on the straw, she cannot safely use glass straws and rapidly chews up paper ones. The marketing a few years ago of flexible, plastic straws was another marked improvement.

June has just enough bladder control to escape from her former enemy - the in-dwelling catheter. Her bowel movements must be programmed by stool softeners and suppositories.

The awkwardness of bed baths has been overcome by a relatively inexpensive bathroom modification. A floor drain was installed, together with tile on walls and sloping floor. Then a wooden platform was mounted on hinges, so that it could serve both as a bath table and, with straps as a tilt board to provide the relief of standing erect for a while (Fig. 2).



Fig. 2 - Hydraulic lift and tilt board

## Prevention of Severe Discomfort

Decubitus (bed sores) is a major risk for immobilized persons. In June's case, her sensory nerves are intact to provide warning and physical agony if the warning is not responded to. In persons with spinal cord injuries that destroy sensation as well, the warning may be absent.<sup>1</sup> The most effective aid is an alternating pressure air mattress, one with two interleaved sets of air cells. It requires an air pump and electrical power. When used with a battery-powered wheelchair, the pump and an inverter had to be mounted on the chair (Fig. 3). The smallest reliable (transistorized) commercial inverter found for this application is still very bulky and inefficient for such a low-power application.

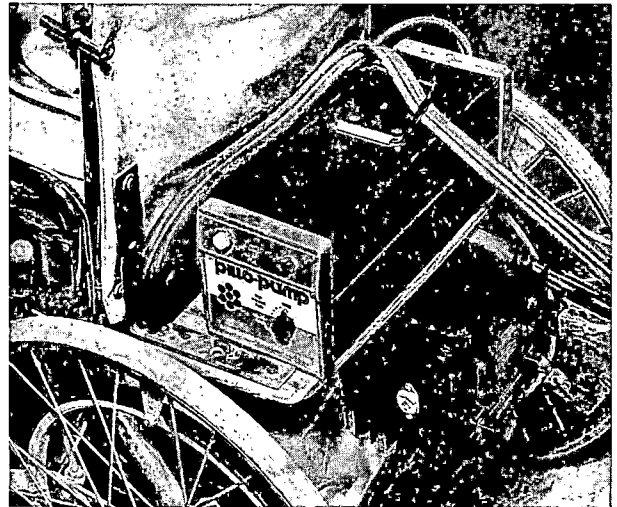

Fig. 3 - Inverter and pressure pump on wheel-chair

The second-best support is a partially inflated pneumatic pad for a wheel-chair, or an ordinary camping-type air mattress for a bed. June uses these when traveling. The pneumatic pad is also used when June is moved into a chair at the theatre, in an airplane, etc.

Liquid-gel-type seat pads have not been satisfactory, except with an alternating pressure air mattress on top.

Foam rubber pads are very handy for special comfort adjustments. They can be cut into rings for relief of sore pressure points. Pads can be encased in a cloth cover and fastened in place. For example, June uses a pad with a pair of socks attached under her heels at night, so that involuntary spasticity of her legs doesn't pull them off the support.

The second major discomfort risk is soreness in stiffened (calcified), immobile joints. In June's case, her aide regularly administers range-of-motion exercises. At times the children have helped. Our small, 3-yr-old girl took delight in helping with the arms and hands for a while. Such assistance can even be given without any loss of information while watching television. June also has a special Jacuzzi tub in which she receives some treatment, and is able to perform some motions herself without having to overcome gravity.

Temperature is another discomfort area. Inactivity makes a person very susceptible to cold. This problem is not serious indoors or in vehicles and can be dealt with elsewhere by proper planning of clothing and carrying along a small, warm comforter for fine adjustments.

### Communication

Communication is placed next after the physical-health needs, because without some form of communication a person is unable to have any effect on his environment.

The simplest form of communication is a call for attention. In June's home a few 12-volt buzzers were installed throughout the house. They can be selectively activated by push buttons on a cord placed within her reach. When her hand was weaker, she used a microswitch. Even a tongue- or eyebrow-activated switch would serve. She also has a buzzer button next to the control stick on her electric wheel-chair.

The next level of communication is a binary (yes/no) response to a question, or selection of an item from a list presented serially. Early in June's rehabilitation she had partial control of her eyelids. This was used to assess the state of her awareness, which was considerably clearer than would be inferred from her appearance. It was then used to enable June to formulate phrases by having someone recite the alphabet until June indicated a letter with her eyelids. This technique only requires a simple binary control, but its speed and effectiveness depends on the handicapped person's response time and inadvertent response (i.e., signal-to-noise ratio). A similar method is automated in scanning-type letter and word boards. The time to accomplish a selection can be decreased by performing a multi-dimensional matrix scan (e.g., select a row and column on a two-dimensional page; add the selection of a page for a three-dimensional scan; this extension of this principle to any number of dimensions is limited primarily by the information display capabilities).

When June regained some control over her left arm and hand, she was able to use an Autocom<sup>2</sup> communication aid (Fig. 4). This provides a 2+ demensional scan (the third dimension is a selection of one of four levels of letters/words/symbols) by moving a hand-piece over a smooth, flat surface. The selected characters are printed out on a paper tape. This releases the observer during the time the message is being composed.

The Autocom is essentially a portable and more versatile version of a typewriter (the shift key provides the third dimension). June is able to use an electric typewriter with her arm, assisted by a ball-bearing/rubber-band type arm support (Fig. 5). With this arrangement, June composed a 100,000-word book<sup>3</sup> describing some of her rehabilitation experiences.

Sometimes June is also able to vocalize very softly. People who are familiar with her can understand letters, words, and some phrases from a combination of sound and lip reading. A speech amplifier and high-pass filter<sup>4</sup> significantly increases the understandability of her speech (also shown in Fig. 5).



Fig. 4.- Autocom and speech amplifier



Fig. 5 - Electric typewriter and arm support

### Mission

In our preoccupation with meeting the obvious physical needs of the disabled person, we tend to neglect the compelling need to be needed, to have a *raison d'etre* or purpose in life. This need is all the more important for the disabled, because many of them develop a sense of guilt for the resources (time, money, talents, equipment) that they consume just to meet their physical needs. Family life provides the most immediate opportunity for satisfaction. For many, the ability to be financially self-sufficient (i.e., to earn a living) is also important.

For June, the key element has been family-life. After an initial home adjustment period, she has continuously directed the rearing of four children and supervised the household. She provides advice, encouragement, and companionship to her husband. There are practically no phases of family-life in which she doesn't participate. But even this was not enough for her. For four years she worked at the typewriter to compose a book. Its purpose is to encourage the handicapped to live fully, and to advise those who encounter and assist the handicapped, particularly those with communication problems.

If it were necessary, June could probably earn a living. Examples of jobs she could undertake are proofreading and computer programming. June reads using a commercial page turner<sup>5</sup> (Fig. 6). Her ability to concentrate and care for detail has been enhanced by her injury. The most serious impediment to proofreading would be her inability to consult a dictionary. Perhaps a rapid-scan page turner will some day be developed; in the meanwhile, it is completely practical for June to flag her questions for later resolution with an assistant. She is well motivated to retain what is learned each time.



Fig. 6 - Page turner

Computer programming is an excellent example of a task requiring a high ratio of thinking-to-output. The output is strictly serial, so it can be easily produced on a typewriter. It is even possible to make corrections out of order by flagging them. June would have to be trained; again, reading is essential. It would be difficult for her to produce a program flow chart, but her ability to thoughtfully formulate the result in her head, which was developed during her book writing, will easily compensate. If computer programmers were forced to think more before writing, there would be fewer program bugs.

### Mobility

This discussion on mobility will focus on the means by which the disabled person is moved, as distinguished from conscious movements of a portion of the body used to actuate devices (e.g., the electric typewriter, Autocom, and page turner discussed above).

An electrically powered wheel-chair is the basic means of local mobility for the severely disabled person. It can be controlled by a few binary functions (e.g., forward, backward, stop, left, right), with possibly some analog overlay (faster, slower, more or less turn). June's wheel-chair has a control stick in her lap that activates four microswitches<sup>6</sup> (Fig. 5).

A fundamental need is a device to transfer the disabled person between bed, wheel-chair, and other facilities. A hydraulic lift with sling<sup>7</sup> has the advantage of easy operation by anyone with normal strength (Fig. 2).

The basic disadvantage of both the electric wheel-chair and hydraulic lift is that they are too heavy and bulky for convenient use outside the home. June also has a light-weight wheel-chair<sup>8</sup> for traveling and a hydraulic lift<sup>9</sup> to move her into a Dodge van (Fig. 7). Since June is rather tall, it was necessary to lower the floor by 4 inches in the portion of the van next to the side door to provide headroom. This modification is not difficult, as long as the drive shaft is not toward the right of the vehicle.



Fig. 7 - Portable wheel-chair and van lift.

This still doesn't solve the problem of transfers away from home and the family vehicle. June's transfers between wheel-chair, bed, toilet, chairs, etc., are now accomplished by a bear-hug method (Fig. 8). Note in the figure how the aide's knees are used to lock June's legs in place.



Fig. 8 - Bear-hug transfer

A more hazardous method is used to transfer June from a wheel-chair into a sedan (Fig. 9). This is not recommended for weak backs.



Fig. 9 - Lifting June into sedan front seat

#### Improvements

The discussion above points the way to improvements in devices and systems that would enhance the quality of June's life.

The most obvious needs were illustrated by Figs. 8 and 9. Such manual lifting runs the continual risk of a back injury, after which June's mobility away from home would be curtailed. Important design criteria for devices to assume this transfer function are compactness and lightness, such that they can accompany an airline passenger.

There are detectable, controllable electromyographic signals in June's right arm. An important improvement in her function would be achieved by enabling them to control some arm functions.

June's most severe impediment to speech is the inability to control the expulsion of air from the lungs. Perhaps a device under external control (e.g., by a facial muscle), that would apply pressure to her diaphragm could clarify her speech.

The electric wheel-chair, inverter, and air pump are very useful at home, but the total weight and bulk is very inconvenient for travel. Proper design can materially decrease the weight and volume of all portions except the battery. One way of ameliorating the battery problem is to use two batteries - a large, all-day unit for home, and a smaller, 2-hour unit for travel, the latter with a compact charger that could be plugged in whenever the wheel-chair is parked near a 110 V a.c. outlet or a 12 V d.c. cigarette lighter socket in a motor vehicle.

#### Comments

Although June is severely disabled, her mind is clear. In this she has a great advantage over those whose perception and logic has been affected by injury or age. However, a very important lesson from June's experiences is that the disabled person who has lost the ability to communicate may yet have much greater clarity of

mind than the observer assumes. When we appreciate the frustration of being incommunicative, and the psychoses that can easily result, we must conclude that providing the means to communicate may help clarify many apparently befuddled minds.

June's life is less safe than the experiences of the nonhandicapped person. She is continually exposed to the probability of minor injury (e.g., slipping out of the sling, the wheel-chair tipping over), and the possibility of serious accidents (e.g., escape from a building on fire or airplane accident) is translated into potential restrictions on his mobility. This would be a terrible disservice. We must accept not only the responsibility to make his life as safe as practical, but also the obligation to allow him to live his life as fully as he can, accepting the extra risks.

With the exception of June's wheel-chairs, arm support, and hydraulic lift, the devices that June uses were adapted or discovered by family and friends during many years. As a minimum, the handicapped deserve to have available an up-to-date catalog of gadgets and techniques to assist them.

#### Footnotes

- 1 When Jill Kinmont, the subject of The Other Side of the Mountain, was asked if she had any indication of potential injury, she said, "My hair stands on end!"
- 2 Developed by Cerebral Palsy Communication Group, University of Wisconsin, Madison, Wisc.
- 3 My New Life, published by June van Lint, La Jolla, CA.
- 4 Developed by NIRE, Pompton Lakes, N.J.
- 5 Manufactured by Lakeland Products, Minneapolis, Minn.
- 6 Manufactured by Everst & Jennings, Los Angeles, CA.
- 7 Manufactured by Ted Hoyer & Co., Inc., Oshkosh, Wisc.
- 8 Manufactured by Stainless Specialties, Los Angeles, CA.
- 9 Manufactured by Maxon Industries, Los Angeles, CA.

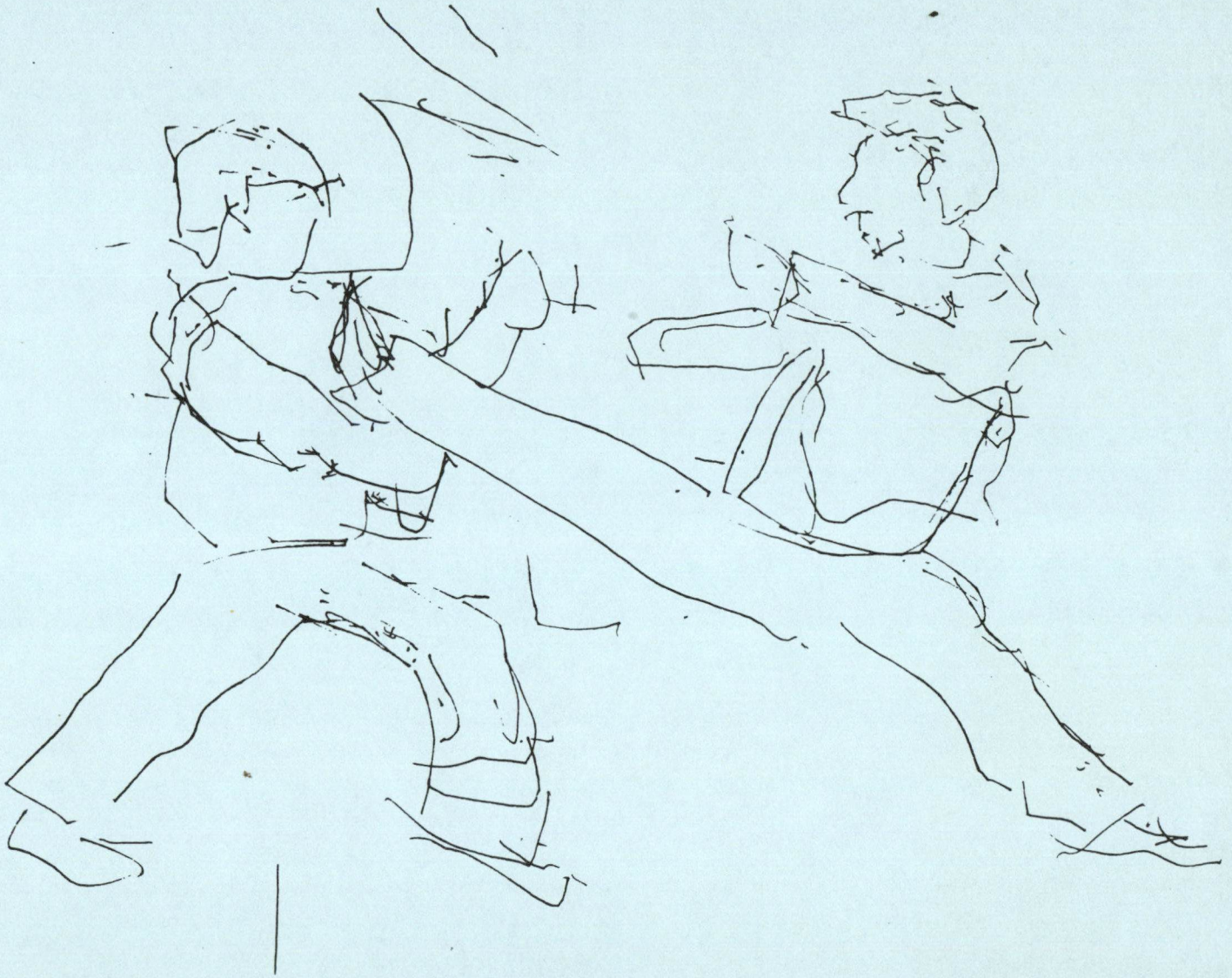

# VOCATIONAL REHABILITATION

SESSION J

# INDUSTRIAL ENGINEERING APPLICATIONS

IN A

## SHELTERED WORKSHOP ENVIRONMENT

BY

DR. DONALD R. SMITH, P.E.

ALBERT E. SWARTS, P.E.

With increasing emphasis upon vocational assistance through engineering applications, especially in the sheltered workshop environment, a typical set of industrial engineering problems have surfaced. Since the functions of operating a sheltered workshop consist of rehabilitation, training, and counseling, in addition to vocational assistance, the industrial engineer discovers that "classical" approaches have to be modified in order to accommodate the classes of workers commonly found in a sheltered workshop. This paper will outline the role of an industrial engineer functioning in such an environment.

### Introduction

The purpose of this paper is to discuss the role of the industrial engineer functioning within the environment of a sheltered workshop. Specific engineering problems will be reviewed with the emphasis placed upon the application of industrial engineering technology. In addition, research areas that are currently being investigated will be discussed.

### The Sheltered Workshop Concept

The concept of sheltered workshops is not necessarily new. History has recorded that the first workshop in the United States was the Perkins Institute for the Blind, located near Boston. The Institute was initiated in 1838 as a vocational education facility serving segments of the blind population. Subsequently, workshops developed into institutions providing vocational training, special education, spiritual rehabilitation, special education and assistance to individuals possessing marginal work potential. In many ways, workshops have undertaken medical and social services that other groups were either unable or unwilling to assume.

The history of the sheltered workshop movement in the United States has been moving in the direction of functioning primarily as a business enterprise. The results have led to a diminishing number of severely impaired employees with a concomitant increase in less physically disabled or non-physically disabled employees.

By contrast, European workshops, because of centralized government powers and economic systems, have been able to maintain focus on those individuals with severe disabilities. Through innovative techniques and methods, these workshops have demonstrated that those with severe impairments can become productive. These results have given new hopes and exciting possibilities for further development among the severely disabled in workshop settings in the United States. (The interested reader is referred to Nelson [6], who provides a complete

discussion of the workshop concept in the United States.)

### The Definition of a Sheltered Workshop

A definition of a sheltered workshop as provided by the National Association of Sheltered Workshops and Homebound Programs is as follows:

"A sheltered workshop is a nonprofit rehabilitation facility utilizing individual work goals, wages, supportive services, and a controlled work environment to help vocationally handicapped persons achieve or maintain their maximum potential as workers."

Two basic types of workshops have developed; the transitional workshop and the terminal workshop. A transitional workshop provides the client<sup>1</sup> with a temporary work environment for the purpose of placement in outside employment. The terminal workshop generally involves clients with very low work potential who normally stay in the workshop for sustained periods of time as employees of that workshop.

### Governmental Recognition of Sheltered Workshops

In 1920, the passage of Public Law 236 provided formal recognition of the utility of the workshop concept by Congress. Additional legislation has been passed providing assistance to sheltered workshops. This assistance is in the form of research grants, governmental sub-contract work, and support through the Small Business Administration of the Department of Commerce.

In conjunction with direct assistance, the Federal Government through the Wage and Hour Division of the Department of Labor licenses workshops. The effect of the licensing is to allow the payment of wages below the minimum wage to handicapped workers whose output is sub-productive, so long as documentation exists to support the output. The effect of such licensing is to allow workshops to basically survive.

When client production increases, the wage level increases proportionally and serves as an incentive for the client.

Federal and state agencies are becoming more aware of the importance of sheltered workshops and the services provided to the handicapped.

#### The Texas Institute of Rehabilitation and Research

The basis for this paper is the examination of the function of industrial engineering in a sheltered workshop environment. Before discussing aspects of the industrial engineering services, mention will be made concerning the specific workshop that this effort addresses.

The workshop in question is designated as the Work Activities Program (WAP) affiliated with the Vocational Unit of the Texas Institute for Rehabilitation and Research (TIRR), located in the Texas Medical Center at Houston, Texas. TIRR is associated with the U.S. Rehabilitation Services Administration Sponsored Research and Training Center through the Department of Rehabilitation at the Baylor College of Medicine in Houston, Texas.

The Vocational Unit is accredited in the area of "Vocational Adjustment" by the Commission on Accreditation for Rehabilitation Facilities (CARF). Additionally, the Vocational Unit is surveyed annually by the Texas Rehabilitation Commission and is certified for providing services at the "highest possible level."

#### Goals of the Vocational Unit

The Vocational Unit is governed by the basic philosophy that regardless of circumstances, every person possesses inherent import and is worthy of receiving assistance toward optimal functioning, including economic productivity, in a dignified manner.

In support of this philosophy, the Vocational Unit of TIRR has organized into the following units; Vocational Evaluation, Work Adjustment and Training, Selective Placement, Work Activity Program, Micrographics Program, Driver Training Program, Professional Training, and Research and Development.

#### Work Activity Program

The Vocational Unit's Work Activity Program (WAP) is both a business enterprise and a rehabilitation effort. This dual nature has created conflicts as the interplay between functioning as a business on the one hand and providing rehabilitation services on the other hand have often clashed in opposition. Balance is difficult! When there is a strong financial accountability factor, production and capable manpower become paramount and can force sacrificing the more noble goals of providing significant services to the severely physically disabled. Conversely, when greater focus and attention are given to the severely physically disabled, financial solvency can approach recessive and marginal proportions.

WAP officially began in May, 1972. Until 1974, this development was generally unstable. It was not until the acquisition of space in the Rice University Village in October 1973, that a more stable foundation was established. Examination of WAP's objective encompasses two attributes; as a business and as a rehabilitation service.

#### WAP as a Business

In order to provide employment for the severely disabled, subcontracts have been solicited from surrounding industry. During the year of 1974, WAP procured 40 subcontracts from 36 firms, companies and institutions. Table 1 provides a general description, the number and types of subcontracts procured.

<u>Subcontract Description</u>	<u>Number</u>
Packaging Operation	5
Multiple Step Assembly	4
Simple 2-3 Step Assembly	4
Inspection	3
Product Manufacturing	3
Drill Press Operations	3
Deburring Operations	1
Specialized Machine Operations	1
Arts and Crafts	1
Collating	1
Micrographics Service Operations	14
Total	40

Table 1  
Subcontract Distribution of WAC  
for 1974

Table 2 illustrates the continuity status of the 40 subcontract jobs as of December 31, 1974.

<u>Contract Status</u>	<u>Number</u>
Consistent long-term and continuing	6
Continuing on an interval basis	17
Short term with no future involvement	4
Exploratory	6
Discontinued as unsatisfactory	7
Total	40

Table 2  
Distribution of Subcontracts  
as of December 31, 1974

Experience has shown that to date the contracts providing the most work are micrographic, product manufacturing, and multiple step assembly operations. The least consistent subcontract types are inspection, arts and crafts and collating operations.

The present objective of management is the procurement of long-term subcontracts which will offer satisfactory profits while providing continuous work suitable for the disabled population. In this regard, considerable effort is expended in the search and selection of such work.

During 1974 WAP acquired three major long-term subcontracts which help to provide stability to the workshop. The three jobs are:

1. The manufacturing of flange protectors: The owner has phased this operation out of its plant and installed all of its flange protector equipment in the workshop.
2. The manufacturing of continuous message signs: The WAP is responsible for assembly and inventory of the product while the owner company provides the materials.
3. The acquisition of document micrographics services: The owner company has donated the equipment and provided WAP with its previous customers in the area.

#### WAP as a Rehabilitation Facility

Basically stated, WAP's rehabilitation goals are to employ the severely disabled, train them, upgrade their skills and productive capabilities and when possible, to place them in competitive industry.

During 1974, rehabilitation services were provided to 40 clients. Table 3 summarizes the client disability categories.

<u>Disability</u>	<u>Number</u>
Birth defects	8
Spinal cord injuries	6
Neurological diseases	4
Brain injuries	3
CVA	3
Skeletal systems deformities	3
Amputation	2
Multiple Schleosis	1
Muscular Dystrophy	1
Severe Arthritis	1
Diseases of circulatory systems	1
Others	7
Total	40

Table 3  
Distribution of Client Disability  
Categories

Table 4 reviews the categories of functional impairments in upper and lower extremities.

<u>Impairment</u>	<u>Number</u>
Both upper and lower	15
Lower only	5
One upper and one lower	4
Both upper only	1
One upper only	1
One lower only	1
No impairment in upper or lower	12
Total	40

Table 4  
Functional Impairments of  
Clients for 1974

Specific impairments in upper extremities varied in severity and in residual functioning: paralysis, spasticity, amputation, weakness, limited range of motions, limited prehension and rotation. Of those with lower extremity

impairments, 10 were confined to wheelchairs plus another 10 were restricted to sedentary work.

#### Organization of WAP

The managerial and staff supporting services required to fulfill the stated objectives are: a workshop director, contract procurement supervisor, fulltime staff industrial engineer, micrographics coordinator, micrographics supervisor, workshop supervisor and one full time secretary.

Supporting the WAP personnel are elements of the Vocational Unit staff which include a director and assistant director, staff counselor, psychometrist, senior work evaluator, placement counselor and other supporting and clerical staff. Also, the data processing unit of TIRR provides computer services as needed.

#### Industrial Engineering Research

WAP is involved in a joint engineering research effort funded by the Department of Health, Education, and Welfare. Cooperating in this venture are the Baylor College of Medicine, TIRR, and the Industrial Engineering Department of Texas A&M University. A specific area of the funded research is concerned with the applications of industrial engineering technology as applied to the sheltered workshop environment.

Since 1974, the divisions of Bioengineering, Industrial Engineering, and Industrial Hygiene and Safety of the Industrial Engineering Department have been involved in specific research activities.

The remainder of this paper will review aspects of this research as it relates to industrial engineering.

#### Industrial Engineering Research Objectives

The objective of the industrial engineering research is the application of industrial engineering technology to the improvement of the employment potential of the moderate to severely handicapped person. Assisting in the achievement of this goal is the application of "traditional" industrial engineering tools with required modifications. Experience has demonstrated that the traditional tools may not be applied in the same manner as expected in the industrial environment. The major consideration is flexibility. Due to the nature of the disabled workforce, standardization of designs may be detrimental in that clients are not all alike. Because of the wide range of disabilities, the engineering applications have to maintain flexibility. Supporting this criteria is the objective of assigning clients to a wide variety of tasks in order to support the training efforts.

#### The Definition of Industrial Engineering

The American Institute of Industrial Engineers (AIIE) has adapted the following definition of industrial engineering.

"Industrial engineering is concerned with the design, improvement and installation of integrated systems of men, materials and equipment. It draws on specialized knowledge and skill in the mathematical, physical, and social sciences together with the principles and methods of engineering analysis and design, to specify, predict and evaluate the results to be obtained from such systems."

Examination of this statement indicates that industrial engineers may possess the specialized knowledge to assist in providing solutions to the types of problems encountered in the sheltered workshop.

The applications of some of the common industrial engineering methods applicable to workshops will follow. Specifically, the application of methods engineering, time study, workplace design and systems engineering will be examined.

#### Methods Engineering

Niebel [ 7 ] defines methods engineering as: "...the systematic procedure for subjecting all direct and indirect operations to close scrutiny to introduce improvements resulting in making work easier to perform and allowing work to be done in less time and with less investment per unit. Thus, the real objective of methods engineering is profit improvement."

Within the workshop, considerable time and effort is devoted to the application of this definition. While profit improvement is indeed important, the primary objective lies in making the work easier to perform for the handicapped.

It is generally accepted industrial practice, to examine a job, define the basic elements of that job, then seek ways to eliminate or reduce inefficient motions and effort such that maximum efficiency can be approached. In a workshop environment, care must be exercised in that stripping the task to its "barest" elements may reduce the training aspect of the work. In practice, subjective judgement has to be used in order to maintain a degree of job content consistent with the vocational training goals.

#### Example of Methods Engineering

Numerous clients in the workshop possess limited grasping abilities that serve to hinder their performance on certain tasks. One specific task common to the micrographics is the operation of handles or nobs associated with photographing documents. Analysis of the motion requirements for such tasks indicated that opening and closing the hand takes time, especially for a quadriplegic. As a result of methods engineering, the nobs on the micro-filming devices were modified to include spokes such that clients possessing grasping difficulties could operate these devices. Successful operation was accomplished by having the client push or pull the modified nob rather

than having to grasp and twist the nob.

A second application was the design of a tray for feeding documents into a microfilming camera. With the assistance of TIRR's orthotist, a tray design was implemented to assist a specific client possessing severe disabilities. Prior to the design, the client was performing at a level approaching 5 percent of the established workshop standard. After installing the feed tray and providing training, the productive level approached 30 percent of the established workshop standard. (The established standard is the output per unit of time expected of clients that have previously performed on the task in question with allowances made that accommodate their disabilities.)

Although 30 percent of the established standard is still very low, emphasis was placed upon the client's improvement. The client's morale was boosted considerably, in addition to the feelings of accomplishment felt by the staff.

#### Time Study

A close association exists between the functions of methods engineering and time study applications. In essence, methods engineering provides the core of time study. An accepted definition of time study as advanced by Niebel [ 7 ] is "...the technique of establishing an allowed time standard to perform a given task, based upon the measurement of work content of the prescribed method, with due allowance for fatigue and personal and unavoidable delays." Examination of the definition reveals that the establishment of the prescribed method is consistent with methods engineering.

In practice, three techniques have been developed to establish time standards: estimates, historical records, and work measurement procedures. Within the workshop, work measurement procedures have been almost universally used.

#### Work Measurement Procedures

Work measurement techniques consist of stopwatch study and predetermined time systems. Both techniques are applied in the WAP with emphasis placed upon predetermined time systems.

Stopwatch study is a technique whereby a timing mechanism (stopwatch, digital clock, etc.) is used by the analyst to record the elemental times of the task under consideration. A good deal of skill and experience is required to establish fair job standards. In addition to recording accurate time observations, the analyst is required to "level" or provide a somewhat subjective evaluation of the skill and effort of the worker.

Predetermined time systems (sometimes referred to as synthetic time systems) represent a collection of time standards that have been assigned to fundamental motions and groups of motions. The application of such systems require the analyst to closely observe the sequence and type of motion and associate a predetermined time with each class of motion. (This is accomplished by tabulated values based

upon prior research.) The predetermined times are then added to yield a time value which is adjusted to account for certain allowances. The resultant time is referred to as the "standard time."

One advantage of utilizing predetermined time systems is that elemental times are generally prelevelled. Thus, the analyst is relieved of the leveling chore. Another advantage is the fact that only the motions required to perform the task be identified. However, as with stopwatch techniques, the analyst must be properly trained in the application of such systems.

#### Examples of Predetermined Time Systems

A number of predetermined time systems are in use in industry. Among the more popular ones are Master Standard Data (MSD) [2], Methods-Time-Measurement (MTM) [5], and Modular Arrangement of Predetermined Time Standards (MODAPTS) [4]. WAP currently employs MSD and is examining the applications of MODAPTS for future use.

The standards established by MSD compare favorably with stopwatch checks performed by the staff. However, experience has demonstrated that the predetermined time standards must be further adjusted when applied to the workshop clients. Predetermined standards assume a trained, nonhandicapped worker. In order to reflect the capabilities of the handicapped individual, the standards must further be adjusted.

A rule of thumb presently being used is that approximately 50% of the predetermined standard is used for contract bidding. With greater experience in the use of these standards it is felt that a more accurate percentage (if one exists) can be developed. By installing a computerized management information system, it is anticipated that relevant data will be available for this purpose.

Assuming the shop is successful in securing the contract, the standard is further refined based upon the work experience of those clients assigned to the work. In this manner, a more accurate estimate of the standard is realized. It is extremely important that a fair standard is developed from this process since client wages are proportional to output.

#### Workplace Design

Work stations and supporting devices (jigs, fixtures, chutes, etc.) are constantly examined to provide maximum flexibility and comfort for the client. This is an absolute consideration since the WAP serves a wide range of client disabilities. Thus, design constraints vary according to the ranges of disabilities served. For example, a paraplegic is unable to use foot controls while hemiplegics may require them. As such, generalizations yielding standard designs are difficult. The problem is compounded by the objective of the management to provide an environment which maximizes the number of clients performing a given task.

An example of workplace design and tool design is an operation of placing set screws in small brass blocks. The blocks are less than 1/2" square and the set screws are 1/4" long and less than 3/16" diameter. To reduce the dexterity required, a jig has been designed to hold the blocks while the set screws are guided into their tapped holes. When the set screws are in place, the client secures them by the use of a "yankee-type" screwdriver. The jig has permitted quadriplegics to perform on the task. The jig was designed to require only gross motions, thus improving the performance of clients possessing upper extremity limitations.

#### Systems Engineering

The growth and expansion of the WAP as a business entity has resulted in an increasing importance for accurate information within a reasonable amount of time. It has been stated that "information is the raw material of management." In effect, the quality of decision making is directly affected by the relevancy of the information provided to the decision maker.

Examination of the previously stated definition reveals the fact that the industrial engineer is trained in the aspects of the systems approach. Many definitions of the systems approach, systems engineering exist. For simplicity, systems engineering may be considered the philosophy of using an integrated approach in problem solving whereby the defined subsystems of the organization are considered as a unified whole.

A current engineering effort in WAP is the design and implementation of a management information system (MIS) suited to the needs of the workshop. A longer term objective is the development of a flexible MIS that may be shared with other workshops. Such a system would be designed to operate on small to medium size computer systems utilizing terminals.

The basis of the MIS will be a master file that maintains client data. Accessing this file will be other modules that will generate reports relevant to client evaluation, managerial decision making, and job standards. It is anticipated that the essential elements of this system will be operational by the end of 1976.

#### Other Research Functions

Supporting the industrial engineering functions in the workshop are the efforts of the Industrial Hygiene and Safety Division of the Industrial Engineering Department at Texas A&M. This effort is specifically directed to safety aspects of the workshop. Periodic safety inspections of the workshop are conducted by experienced members of the Industrial Hygiene and Safety Division's faculty. A safety report is prepared and circulated. The report outlines areas of potential hazards and suggests ways of alleviating three hazards. Current OSHA standards provide the reference frame for the inspections. Future research in this area will attempt to identify hazards to which groups of handicapped workers might be exposed.

Currently, a research proposal has been prepared for consideration by the Technical Assistance Division of the U.S. Department of Commerce. The purpose of the proposed research effort is the examination of government-owned patents currently on file with NASA. The effort will consist of researching available patents, determining the potential marketability requirements consistent with the workshop's abilities. It is the objective of the proposed research effort to attract products to the workshop for the purpose of manufacturing and distribution. If successful, the workshop will have attained a greater degree of stability and offer expanded employment possibilities.

#### Summary

This paper has reviewed the industrial engineering applications currently applied in a specific workshop environment. Hopefully, the joint efforts of the parties involved have resulted in its improvement of the employment potential of the handicapped.

#### Footnotes

- [1] The term "client" will be used herein to denote a handicapped individual working in a sheltered workshop.

#### References

- [1] Barnes, R. M., Motion and Time Study - Design of Measurement of Work. 6th Edition. New York: John Wiley and Sons, 1968.
- [2] Crossman, R. M. and Nance, H. W., Master Standard Data. Revised Edition. New York: McGraw Hill Company, 1972.
- [3] Deane, Richard H., "The IE's Role in Accommodating the Handicapped," Industrial Engineering, Volume 7, No. 7, July, 1975, pp. 14-19.
- [4] Gortner, Robert V., "IE's Help Handicapped Workers Raise Productivity," Industrial Engineering, Volume 5, No. 4, April, 1973, pp. 10-15.
- [5] Karger, D. W. and Bayha, F. H., Engineered Work Measurement. Second Edition. New York: The Industrial Press, 1966.
- [6] Nelson, Nathan. Workshops for the Handicapped in the United States. Springfield, Illinois: Charles C. Thomas Publishing Company, 1971.
- [7] Niebel, B. W., Motion and Time Study. 4th Edition. Homewood, Illinois: Richard D. Irwin, Inc., 1967.
- [8] Poor, Charles. "Vocational Unit Summary of the Texas Institute for Rehabilitation and Research - 1974." Houston, Texas: Texas Institute for Rehabilitation and Research, 1974.

#### Acknowledgements

The basis for this research effort is supported from a research grant sponsored by the Department of Health, Education, and Welfare (Grant No. 23-P-57888/6-02) assigned to the Cooperative Rehabilitation Engineering Center, Houston, Texas.

Grateful appreciation is extended to Mr. Charles Poor, for permission to utilize excerpts from the 1974 Vocational Unit Summary of TIRR. Without his contribution, this effort would have been diminished.

In addition, appreciation is extended to Dr. Don Spencer and Mr. Bruce Mills for laying the foundations that have contributed heavily to the industrial engineering research effort in the WAP. Special consideration is extended to Dr. M. J. Fox, Jr. for his efforts in encouraging and guiding this research effort. Finally, special thanks is extended to Mrs. Barbara McCulloch for preparation of the final manuscript.

---

Donald R. Smith is an Assistant Professor of Industrial Engineering at Texas A&M University, College Station, Texas. He holds a BS, MS, and Ph.D. in Industrial Engineering from the University of Arkansas-Fayetteville. His research interests are in the areas of vocational rehabilitation, Bayesian Reliability, and systems engineering. He is a senior member of AIIE and Alpha Pi Mu and is a registered professional engineer.

Albert E. Swarts is a staff industrial engineer employed by the Work Activities Program, TIRR, in Houston, Texas. Mr. Swarts holds a BS and MS in Industrial Engineering from Texas A&M University, College Station, Texas. His professional interests are in the areas of Human Factors, Systems Design for the Disabled, and Methods Engineering. He is a member of Alpha Pi Mu, Phi Eta Sigma, AIIE, and the Human Factors Society and is a registered professional engineer.

TENNESSEE VALLEY AUTHORITY:  
AN EVALUATION PROJECT IN VOCATIONAL REHABILITATION AND BIOMEDICAL ENGINEERING

by

William B. Campbell, Ph.D.  
Edward F. Hilton, M.S.  
Robert L. Craig, M.D.

Summary

Selectively applying the knowledge inherent in the fields of ergonomics and biomedical engineering to the identification, assessment, and modification of jobs suitable for specific handicapped persons, and by providing field-directed placement services to injured workers within the context of a team approach to job reentry, TVA is conducting a program to facilitate the reemployment of former workers injured on the job, following maximum recovery from their impairment. An evaluation program encompassing the preceding features was initiated in 1975 in the Tennessee Valley Authority's Eastern Division. Selected procedures and early trends are presented in view of program goals.

Introduction

The active development of the Tennessee River Valley began over forty years ago with the concept that inexpensive and abundant electric power could serve as a basis for regional development as well as provide much-needed flood control. Pursuit of these objectives has led the Tennessee Valley Authority (TVA) to become one of the largest construction trades employers in the world. A full spectrum of skills and trades are required at each construction site. The TVA must depend on local labor markets for the majority of craftsmen and workers, as well as a well-planned apprentice program. All of the problems intrinsic to heavy construction have been experienced many times by TVA project managers; their ability to cope has become legend. Change has become a common event in the areas of power generation (water, steam and nuclear), management and planning, working limitations and conditions, and response to human needs. The success of TVA operations depends on three basic natural resources: coal, water and labor. Conservation and economics must be combined in the management of these critical resources to meet the demands established by the recent energy crisis. Procedures for the conservation of both coal and water have greatly outnumbered most concerns and consideration for human skills conservation.

In view of TVA's existing and anticipated skilled manpower shortages, it is imperative, both to the economy of TVA's power service area and to the successful accomplishment of affirmative action goals, to reconsider and to increase the role of the handicapped worker in its labor force. Early in 1975, an evaluation of the long term disabilities and their rates of occurrence indicated that the end of the decade would find at least a ten-fold increase in the cost of total disability compensation. Increasing living costs, increasing construction at new sites, inflation, and increasing fringe benefits were among the

items indicating the dramatic rise in compensation costs and recipients. The present rate of on-the-job accidents was used although one can anticipate a decreased incidence if new regulations prove effective.

Background

For a number of years, the Medical Division of TVA has maintained an active rehabilitation program through its staff of rehabilitation nurses who assist the injured employee during his course of recovery and return to work. For many short term and acute cases, this activity has proven invaluable in serving the patient and minimizing lost time. It helps to insure adequate medical direction of the patient from the time of injury until he can return to work. Chronic disabilities with permanent status assigned under Federal Workers Compensation have not proven as successful in many rehabilitation attempts.

The limitations in serving the chronic disability stem mainly from the limitations of activities assigned to the Medical Division. Medical has the primary responsibility for medical matters and is limited in its knowledge of construction activities, personnel needs, or a myriad of other management parameters. No single group was charged with the total management of the returning injured employee and the typical process ensued as follows: medical contacted construction to inform them that the employee was ready to return to work; the supervisor inquired about any work restrictions to be placed on the individual; when informed of minimal restrictions, the supervisor indicated that the job requirements called for higher capabilities and refused to re-employ the employee. In most cases, it became obvious that the supervisor was attempting to maintain a physically perfect work force so that he could concentrate on his job goal, construction. Thus, Medical had no alternative but to follow the medical progress of the employee and urge him to

seek jobs as they became available. Similarly, the Personnel Division was obligated to fill positions according to job descriptions and requirements set by the operating and construction supervisors.

As a quasi-public agency, the Tennessee Valley Authority employees are covered by Federal Workman's Compensation which differs in many ways from the better-known state programs. The most graphic difference is the absence of any time limit for a given disability; in other words, benefits continue as long as the disability persists. Some may cite this feature as a good basis to anticipate abuses and extended recovery periods. Be that as it may, any payment under this compensation plan is charged directly to the agency, TVA, and passed on to the consumer.

Thus, we have the background leading to the increased interest in rehabilitation and the realization that early treatment and therapy in the case of injury, disease, or congenital physical impairments can minimize the handicapping effects of these conditions. The tendency exists, however, for those engaged in the task of selective placement and re-employment of the injured workers to concentrate mainly on finding jobs which, on the basis of their knowledge of job requirements and the residual physical and mental capabilities of the particular disabled person, appear most suitable for the handicapped. This process of "fitting the worker to the job" is disadvantageous in that it restricts the range of jobs which a disabled person can perform. Consequently, many disabled persons with skill, knowledge, or experience may be condemned to perform overly simple, unproductive work with the inevitable loss to the community of the training effort invested in them.

Easily effected modification of the work position or machine controls has enabled some private organizations and companies to re-employ disabled workers. In addition, the relatively recent development of the sciences of ergonomics and biomedical engineering have created other avenues of approach to securing jobs for the disabled. These areas of scientific study seek to apply information about human performance to problems of work design, reducing demands made by the jobs by removing difficult or potentially stressful elements; in doing so, improving overall productivity. Applying the knowledge of ergonomics and biomedical engineering to the identification, assessment, and modification of jobs suitable for specific handicapped persons, and by providing field-directed placement services to injured workers within the context of the team approach to job re-entry, TVA expects to facilitate the re-employment of former workers injured on the job, following maximum recovery from their impairment.

#### Program Operations

An evaluation program was initiated in 1975 in the TVA's Eastern Division and centered around approximately 200 long term disability cases. The project was undertaken as a joint venture between the Medical Division and the Personnel Division's Rehabilitation Services Unit. A field service team was composed of a Vocational Rehabilitation Counselor, and Occupational Therapist and, when indicated, a Biomedical Engineer. The function of

the team was to make initial contact with the former employee, determine his general health status, evaluate his environment and solicit his living or employment goals. In many cases, the employee had not been seen medically for a number of years because TVA's medical program is designed for active cases only. Although the employee has been terminated by TVA, he remains on their "payroll" because his disability payments are charged directly to the agency.

In many cases, a re-evaluation of the original medical problem has indicated sufficient improvement to warrant job retraining or subsequently developed technology can be directed to benefit the patient. Consideration of each employee's disability is relegated to one of three activity spheres; namely home, transportation, or job. All three of these areas are considered to identify those activities that limit the function of the patient. Each activity sphere must be functionally independent for the employer to be assured a dependable worker. At the time of the first home visit, an extensive questionnaire is completed by the interviewer and covers medical history, present functional status, adaptive living status, communication skills, ambulatory status, prostheses and orthoses, level of independence, attitude, motivation, home and environment, transportation, and job placement details such as work history, hobbies, skills, and goals.

The Rehabilitation Services Evaluation in conjunction with the medical history and work (personnel) records provides the team with a very comprehensive profile of the patient. The initial appraisal stemming from these data has led to action resulting in re-employment for a large number of the interviewees; in other words, the updating and collection of additional data provides the necessary information for training or re-employment. More serious or complicated cases require further measurement of the work site to determine the ability of the patient and to mediate any differences between the approving physician and the accepting supervisor as to the abilities of the worker.

Attention shifts to the more complex features of job modification and job analysis in the case of the worker whose disability is not accommodated by the first phase evaluation. Specific functional measurements and task objectives may be determined to identify those positions matching the anticipated level of function. Such activities require on-the-job observations and direct measurements, as well as training sessions for supervisors and prospective coworkers, design of devices and machine modifications, and medical evaluation of the worker's response to the job stress. Thus, the goal of this phase is matching the device or modification to the disability to perform an assigned task under realistic working conditions.

#### Acknowledgements

The authors wish to acknowledge the contributions and support of the Medical and Personnel Divisions of TVA, as well as the encouragement and assistance of the Tennessee Division of Vocational Rehabilitation. This paper is intended to identify our area of endeavor; other professional papers will follow and describe the findings and conclusions of this activity, and the work of our colleagues.

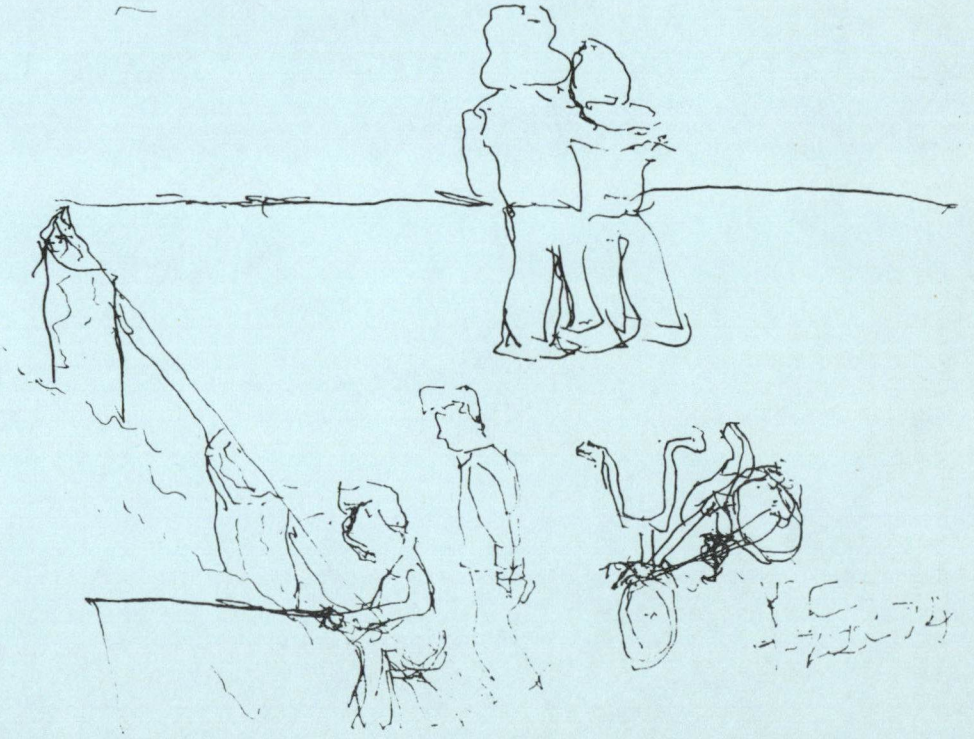
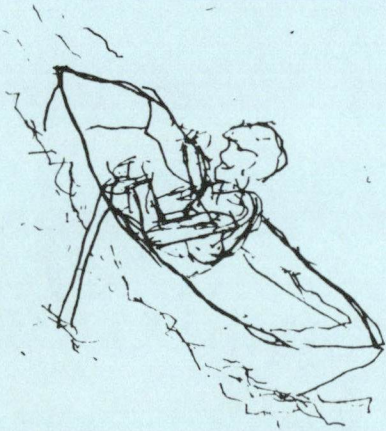
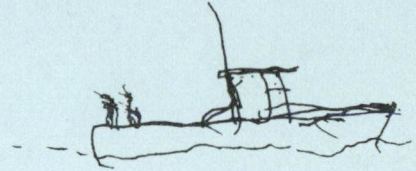
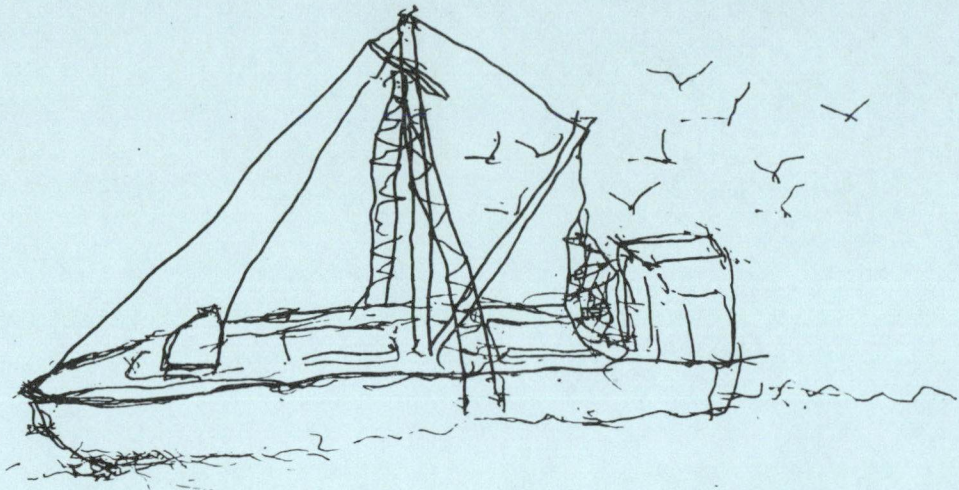

SESSION K

SENSORY IMPAIRMENT

## WHAT'S NEW IN RECORDING EQUIPMENT FOR THE BLIND

June E. Morris  
Department of Educational Research  
American Printing House for the Blind  
Louisville, Kentucky

---

### Summary

Three new recording devices designed especially for use by the visually handicapped are described. Two of these, a portable cassette recorder/player and a variable speech control module, are currently in use and are available from the American Printing House for the Blind. The third device is a prototype of a special indexing cassette recorder being developed for use with a recorded encyclopedia.

---

The American Printing House for the Blind is a private nonprofit corporation that provides materials and services to persons who are blind. In addition to being the oldest national agency for the blind, private or public, in the United States, it is the largest publishing house for the blind in the world and the nation's official schoolbook printery for the blind. The Printing House's products include recorded books and magazines, braille books and magazines, large type books, and a wide array of educational aids of which there are over 300. Probably nowhere else in the world are such a variety of products manufactured under any one roof. During the 1975 fiscal year, \$6 million worth of these products were distributed.

Two laws passed by the U.S. Congress have shaped the destiny of the American Printing House. The first, in 1879, was the act "To Promote the Education of the Blind," the purpose of which was to provide a permanent source of supply for special materials needed in the education of blind children; materials which cannot be obtained from commercial sources. Through this Act, the Printing House became the nation's central source of educational materials for the blind. The second law, in 1930, was the Pratt-Smoot law. Its purpose was to provide literature for the adult blind. It is administered through the Library of Congress and provides for the Talking Book program. In effect, this law expanded the Printing House's market to include blind adults. Subsequently, this market has been expanded still further to make all persons unable to use regular print materials, because of any physical handicap, eligible to use Talking Books.

Talking Books are books that are recorded under contract to the Library of Congress and distributed through the Library's 54 regional libraries for the blind. Those made at the American Printing House are professionally recorded in high quality sound studios and, subsequently, mass produced. In addition to being on loan through the libraries, they may be purchased outright from the Printing House. The Printing House has been recording these books and other materials as well

since 1936. During the forties a companion program was initiated to provide playback equipment to accompany the recordings.

Persons who are visually handicapped normally are far more dependent on the spoken word than are those who are sighted. Recreationally speaking, listening provides a primary mode for entertainment for the visually handicapped. Professionally speaking, listening provides a primary means for obtaining information. Student use falls into this latter category and, as students advance through the grades, they progressively become more and more dependent on aural study. Recognizing the importance of listening to the visually handicapped, the American Printing House undertook research designed to ascertain needs for and uses of recording equipment so that such equipment could be designed specifically to meet the needs of the visually handicapped. Through task analyses and interviews with blind students (Morris & Nolan, 1970a, 1970b; Nolan, 1966), specifications for such equipment were drawn up. It is about some of the recent playback equipment that I wish to talk today. The equipment I am going to show you represents the "state of the art" as of today.

With me, I have three new recording devices. Two of these, a portable cassette recorder/player and a variable speech control module, are currently in use and are available from the American Printing House for the Blind. The third device is a prototype of a special cassette recorder being developed for use with a recorded encyclopedia.

First, let's look at the new cassette recorder/player. This recorder (APH-Modified GE 3-5192 Portable Cassette Recorder/Player) was especially designed for use by the visually handicapped, and built by GE for the American Printing House. It is an excellent recorder that is simple and convenient to use. Basically, it is a playback and recording device that operates on either 120 AC current or off its own rechargeable nickel cadmium battery. It will play either 2-track or 4-track cassettes and will record on two tracks. In addition to those features normally found on cassette recorders of our time, it has a number of unique features. One of its special features is that it operates at two speeds: 1 7/8 inches per second (ips) and 15/16 ips. This slower speed enables twice as much to be recorded on a tape as is normally possible. Another of its special features is that it has a variable speed capability which allows the user to increase the set speed by 50% or more, or decrease it by 20%. As the speed is changed mechanically, the output becomes increasingly distorted as the speed varies from normal. However, intelligibility generally remains reasonably good up to a 50% increase.

To digress slightly, let me say that rate of listening is a most important feature for persons who are visually handicapped. The problem for these people is rate of input of information. Blind persons find themselves at a decided disadvantage to their sighted peers in the area of communication because of their relatively slow reading rates. For example, sighted high school students normally read at about 250 words per minute (wpm) (Harris, 1970, p. 485) while their blind counterparts read braille and large type at the very much slower rates of 89 and 94 wpm, respectively (Nolan, 1966). Quite a discrepancy! However, by using professionally recorded material

played at the normal rate of approximately 160-175 wpm, this discrepancy can be substantially reduced. And, by increasing the playback rate, it can be still further reduced or even eliminated altogether. It has been noted that blind students and professionals who are dependent on recorded materials generally listen to them at a faster than normal rate. Consequently, it can be seen that the variable speed capability is a critical feature for any playback device designed especially for the visually handicapped.

Another special feature of this recorder is a modification through which the playback head remains in contact with the tape at all times. This makes possible a number of useful functions. One is that it provides for "cueing." Actually, this is an audible signal heard when either the fast forward or rewind is engaged which lets a user know when the tape is in operation and also where recorded material on the tape starts and ends. Another useful function of this feature is that it makes possible previewing and reviewing, with an audible signal, without the necessity of pushing a lot of buttons. These functions are achieved, respectively, by momentarily depressing the fast forward and rewind controls while leaving the player in the play mode. Last but far from least, this feature enables auditory indexing; either tonal or vocal. Index cues recorded on the tape that are virtually inaudible when the tape is played at its normal rate can be heard clearly when in the fast forward or rewind modes. Needless to say, words used in vocal indexing are heard backwards when rewind is engaged. However, merely by briefly engaging fast forward they can be heard intelligibly.

Although persons recording their own materials are not able to index them vocally, another special feature of this recorder makes it possible for users to index their own materials with tones for which innumerable codes can be devised. The recorders are equipped with a special index button. When the record mode is engaged, a 60 Hz tone is recorded on the tape when the button is depressed. The length of the tone or the pattern of tones recorded are controlled through the index button. This tone is of such a low frequency that it is not heard at the normal play speeds; however, when tape speed is increased, as in fast forward and rewind, the frequency is raised to be within the audible range.

Other special features for the visually handicapped included on this player are a special window opening above the takeup hub which allows for finger tip sensing of tape motion, tactile coding of controls, storage compartments within the case, and a remote speed control jack. This latter introduces the second device which I want to show you today.

This device is the APH Variable Speech Control Module. It utilizes a chip developed by the Cambridge Research and Development Group to enable the rate of recorded speech to be increased or decreased from that at which it was reproduced without pitch distortion. This provides for far more pleasant listening than when the speech is altered mechanically as by a variable speed mechanism. The range possible with this device is from about 70% of normal up to, in some cases, 250% of normal. The module is a plug in device that comes with a patchcord and adaptor plug. It has been

designed to work with any APH variable speed playback machine. These include the new cassette player/recorder just described, an older model cassette recorder no longer being sold but widely in use, the APH-Modified Sony 105 Tape Recorder which uses open reel tape, and the APH Talking Book Reproducer which is a disc player. Actually, the module will work with any machine with variable speed capability. The module utilizes integrated circuits and operates on 120 AC current. It contains a power amplifier and speaker, provides for control of both rate and volume, and offers an earphone or speaker option.

The third device I want to show you today is a prototype of an indexing cassette player which is being developed by the American Printing House for use initially with a recorded encyclopedia. This is one of three components of a cassette reference system under development. The other components are 4-track, C-60, indexed cassettes on which all four tracks are recorded in the same direction at 15/16 ips; and a written index corresponding to the cassettes. The basic unit of the player is a cassette deck manufactured by the Economy Company of Oklahoma City. This deck differs from other available decks in that all functions are accomplished electronically rather than mechanically. These include normal play, stop, rewind, skip-back, skip-forward, and fast forward. This deck has been modified to provide for two-speed operation: 15/16 ips and 60 ips. To accommodate this shift, a belt switching mechanism has been designed and incorporated. The slow speed is used for play and the fast speed for search.

Electronics have been designed for use with the deck that will enable a user to locate up to 99 index points on a track (1-hour of recording). These index points are located through response by the equipment to a series of 50 Hz tones placed as desired on the tape. To find any given point on the tape, the user must first determine the ordinal position of the desired place, which he does through reference to the written index. To find the desired entry point on the cassette, the user sets the number indicating the ordinal position into the player. He then activates the player's search control, the motor goes into high speed, the tape drive engages, and a pulse counting network counts index tone signals on the tape until their accumulated number matches that entered into the player through the selector switch. At this time the tape drive disengages, normal speed of play is engaged, the tape drive engages again, and the audio content of the tape is played. Theoretically, average search time to locate any index point on the tape is 30 seconds. Rewind requires only about half as much time as search.

What's new in recording equipment for the blind? Quite a bit! The three devices demonstrated today represent where we are today. They are not the ultimate of tomorrow, but they go far beyond our dreams of yesterday. And, as our technology in this field continues to expand, we know that the future will bring even more exciting developments; developments that go beyond our dreams of today.

## References

- Harris, A. J. How to increase reading ability (5th ed.). New York: McKay, 1970.
- Morris, J. E., & Nolan, C. Y. Aural study systems for the visually handicapped: Recorded text-book formats and aural study methods: A summary of user opinions: Interim progress report no. 2 [Project No. 8-0046; Grant No. OEG-0-8-080046-2670(032)]. Louisville, Ky.: American Printing House for the Blind, 1970. (ERIC Document Reproduction Service No. ED 047 486) (a)
- Morris, J. E., & Nolan, C. Y. Aural study systems for the visually handicapped: A task analysis: Interim progress report no. 1 [Project No. 8-0046; Grant No. OEG-0-8-080046-2670(032)]. Louisville, Ky.: American Printing House for the Blind, 1970. (ERIC Document Reproduction Service No. ED 047 486) (b)
- Nolan, C. Y. Reading and listening in learning by the blind: Progress report (PHS Grant No. NB-04870-04). Louisville, Ky.: American Printing House for the Blind, 1966.

1962

Audiometric Determination of Urinary Glucose Concentration  
for the Visually Impaired Diabetic Patient

by

Joseph French, Arthur A. Siebens, M.D.,  
and Charlotte Seltzer, COTA, The Johns  
Hopkins University and The Good  
Samaritan Hospital, Baltimore, Maryland

**Summary** - A relatively simple system has been built to enable the blind diabetic patient to collect a sample of urine, to wet Tes-Tape<sup>3</sup> reliably, and to use that tape to measure the concentration of sugar in urine. Change in color of the Tes-Tape is converted to an audible signal which guides the blind individual in using a readout dial the calibrations of which can be made out with the finger tips. Each of the components of the system can be assessed independently of the other.

### Introduction

This project was stimulated by the observation that some blind patients with diabetes mellitus because they are unable to test for the presence of sugar in their urine are dependent on someone else for regulating their diabetes. An effort was made, therefore, to create a means whereby the non-sighted diabetic patient could monitor urinary glucose concentrations despite the inability to read any of the common color coded systems.

### Current Color Systems

Three popular systems used by sighted diabetic persons to determine the concentration of sugar in urine are Clinitest<sup>1</sup> reagent tablets, Diastix<sup>2</sup> reagent strips, and Tes-Tape<sup>3</sup> urine sugar analysis paper.

A Clinitest tablet is dissolved in a test tube containing a precisely measured solution of water diluted urine. The resulting color of the solution indicates the percentage of sugar present in the urine when compared to a color chart supplied by the manufacturer. Because the preparation of the urine-water solution could be quite cumbersome for a blind person and because the tablets contain caustic soda and require careful handling, this system was not given serious consideration.

A Diastix strip is a strip of clear plastic (approximately 7/32 x 2 1/4 inches) incorporating a chemically treated square on one end. The treated end is dipped into a urine sample for one second and removed. After 30 seconds, the color of the treated square is compared with the color chart supplied with the strips. The color change varies from light blue for zero sugar concentration through green for .25% through brown for 2%.

The Tes-Tape is supplied in dispensers which contain 150 inches of approximately 7/32 inches wide tape. The tape is treated with enzymes which react to the presence of glucose. A 1 1/2 inch strip of tape is torn from the dispenser. One end of this strip is dipped 1/4 inch into a sample of urine and immediately removed. One minute is allowed to elapse before the tape is read. As with the previous system, the color of the tape, which depends upon the percentage of sugar in the urine, is compared to a chart on the label of the dispenser. This color changes from yellow for 0% sugar to shades of green for 1/10 % through 1/2 % to dark blue for 2% or higher.

### Choice of Color System

Each of these three systems relies on color as an indicator of sugar concentration. However, when a photograph using panchromatic film is taken of the color charts of Diastix and Tes-Tape, distinct shades of gray appear in place of the colors. The intensity of gray is directly proportional to the concentration of urine sugar; i.e., the darker the gray the higher the sugar concentration. This "gray scale phenomenon" permits the design of a fairly simple device.

A choice had to be made between using Diastix and Tes-Tape. Two important factors that had to be taken into consideration were the ease of handling and the range of the gray scales. With respect to the ease of handling, the Diastix was found to be definitely preferable; the design of any supplemental mechanical device would probably have been relatively simple. With respect to gray scale, the Tes-Tape was found to have a slightly wider range of grays

(very light to almost black) than the Diastix (very light to dark gray). This difference was not, however, sufficient to be considered highly significant. The Tes-Tape was found to have an additional significant advantage, however, namely its property of self standardization. This property, which is described below in greater detail, outweighed the disadvantages of its handling difficulties in our view and persuaded us to work with it rather than the Diastix.

Conversion of Visual System  
To Auditory Signal

The basic concept that is used in converting the visual information of the Tes-Tape into a form that is useful to a blind person is quite simple. The various shades of gray of the tape that are associated with various concentrations of sugar are converted into equivalent values of resistance by reflecting light from the tape into a photo conductive cell. The resistance of the cell is inversely proportional to the intensity of the light entering it. The photocell is used as the unknown resistance in a Wheatstone bridge. The known variable resistance is calibrated in percent of sugar rather than in resistance. A 1000 Hertz tone is used to excite the bridge and an audio amplifier with a speaker is connected to its output. The variable resistance is then adjusted to the point at which minimum sound is heard in the speaker. This is, of course, the point of bridge balance at which the values of the two resistances are equal. Since the variable resistance is calibrated in a code made up of raised dots, the blind individual is enabled to directly read his urine sugar concentration.

Implementation

The implementation of this concept involves four basic steps each of which requires a component unit: 1) collecting urine (Urine Collecting Unit), 2) handling the tape (Tape Handling Unit), 3) Wetting the tape (Tape Wetting Unit), and 4) reading the tape (Tape Reading Unit). All components that come into contact with urine have been designed for ease of cleaning in order to avoid contamination of fresh urine and/or fresh tape by urine residue. Each of the components can be assessed independently of the others.

1. Urine Collecting Unit: The basic design of the unit for collecting and measuring urine without wetting ones fingers is shown in Figure 1A. "1" is an inverted pocket which measures out the proper amount of urine needed for the test. "2" is an open spout for emptying surplus urine. "3" is a funnel spout used for pouring the measured urine into the sample cup.

Figure 1 B thru E shows the principle of collecting and measuring urine

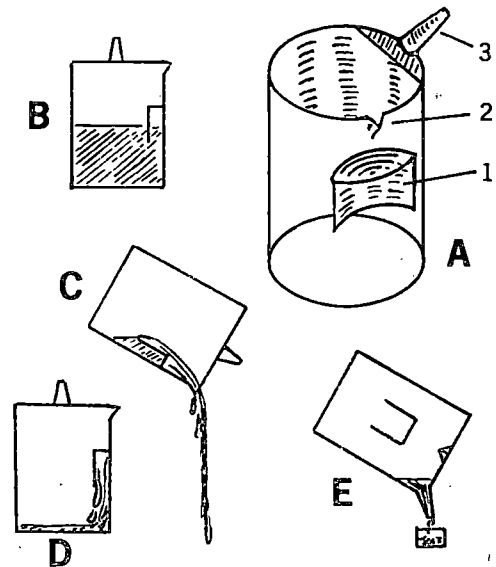

Figure 1.

using this device. (B) shows urine in the container immediately after collection. (C) The surplus urine is emptied through the open spout leaving a small amount in the measuring pocket. (D) When the container is returned to the upright position, the urine sample flows to the bottom. (E) The measured amount of urine is emptied through the funnel spout into the sample cup.

2. Tape Handling Unit: A strip of Tes-Tape is mounted on an aluminum slide in order to facilitate handling during the procedures of wetting and reading. A holder has been designed for the tape dispenser such that a sufficient length of tape is easily guided onto a small shuttle which positions the tape on the slide. The shuttle is the only component which comes into contact with the urine; it is easily removed for cleaning.

3. Tape Wetting Unit: When the Tes-Tape was used per manufacturer's instructions, the following observations were made. When the end of the tape was dipped into the urine it soaked up the urine like a blotter. After the tape had been removed, the urine continued to propagate along the length of the tape until its concentration had become more or less equalized. With some urine samples, the color was fairly uniform along the wetted tape. With other samples, however, the color was not uniform, a relatively dark band of color being formed in the wet area adjacent to the dry area. This dark band is the color which, according to the manufacturer's instructions, should be compared with the chart of standards. The difficulty in applying this method to a photoelectric reader was found to be the difficulty of predicting where the band would settle on the tape. This in turn depended on how far and how long the tape had been dipped

into the urine as well as on the composition of the urine itself. For these reasons, it would have been very difficult for a blind person to properly wet the tape unassisted.

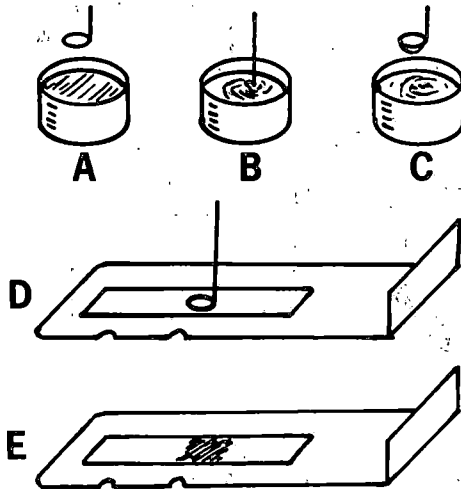

Figure 2.

This problem is solved in the Wetting Unit by placing a small measured drop of urine at precisely the same spot on the slide and, therefore, on the tape each time. The drop is measured by using a .145 inch O.D. loop of .020 inch O.D. stainless steel wire as shown in Figure 2-A. The loop is placed in the urine (Figure 2-B) and then rapidly pulled out (Figure 2-C). If it is pulled out too slowly, surface tension will reduce the amount of urine picked up by the loop. The loop is then brought into contact with the tape (Figure 2-D). A pattern will form similar to that in Figure 2-E. When the loop makes contact with the tape and saturates it with urine, an electric current will pass through the tape thereby completing a circuit causing a tone to be heard. This indicates to the operator that proper wetting has taken place and that the switch on the reading unit should be thrown. This switch starts an electronic timer which will turn the reading unit on in 55 seconds.

4. Tape Reading Unit: The opening for introducing the slide is covered by a door which serves to keep out most of the ambient light. Behind the door is a track to guide the slide to the proper lateral position for reading the tape. The slide has two notches along its left edge (Figure 3) which act as detents for positioning it in the forward direction. Immediately after the tape has been wetted and the switch has been thrown, the slide is removed from the wetting unit, the door is slid up and the slide is pushed forward into the track until the first

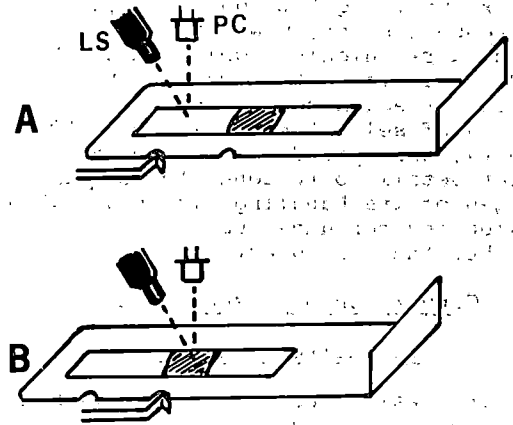

Figure 3.

detent is engaged. The door is then allowed to slide closed.

As shown in Figure 3-A only a small portion of the tape is wetted. The first detent position places the unwetted portion of the tape directly below a Clairex<sup>4</sup> CL 909L Photoconductive Cell "PC" as in Figure 3-A. This photocell is the unknown resistance of the Wheatstone bridge (Figure 4). After 55 seconds, the electronic circuits in the reader are turned on and a beam of light from the light source "LS" strikes the tape at an angle of approximately 45 degrees directly below the photocell (Figure 3-A).

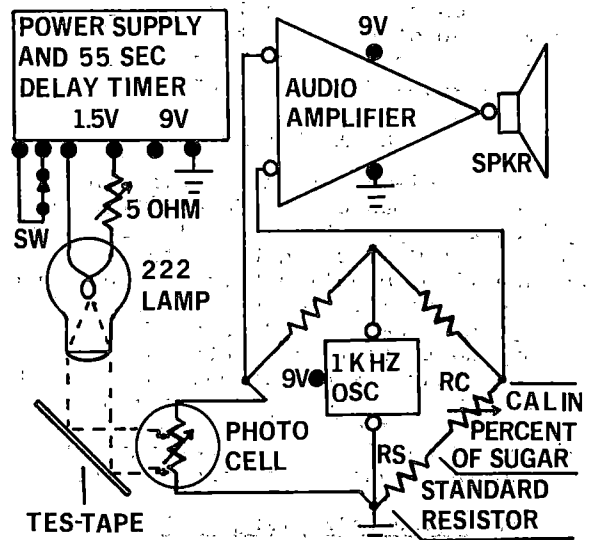

Figure 4.

The light source is a number 222 penlight bulb with a built-in lens (Figure 4). The bulb is completely covered except for a small portion at the center of the lens. This is to assure that the beam of light is confined to the tape and does not fall on any part of the

slide. If light were to fall on the slide, it would be reflected (even if the slide were painted black) and some of this stray light would enter the photocell. This would somewhat mask the effect of sugar on the tape particularly at high concentrations when the tape becomes very dark.

The output of the light source must be kept constant for at least the time it takes to make a reading and from reading to reading. A change in light level has the same effect as a change in the grayness of the tape associated with a change in sugar concentration. The power source for the bulb is a size D flashlight cell. The voltage of the cell drops, of course, as the cell ages and if not compensated for reduces the light output of the bulb. A voltage regulator could have been designed to compensate for this, but would have been costly and also would waste considerable power. Moreover, the flashlight bulb itself is subject to aging effects, such as darkening of the bulb, which would not be compensated for by the regulator. This problem is overcome by making the bridge self standardizing.

Self standardization is incorporated in the initial calibration procedure. The intensity of the light source needed for reading the tape through the range of 0% to 2% sugar is experimentally determined. This light is then reflected off the surface of a non-wetted piece of Tes-Tape into the photoconductive cell. The resulting resistance of the photocell is peculiar to that light level. This resistance (as mentioned above) forms the unknown resistance arm of the Wheatstone bridge (Figure 4). A fixed resistance (standard resistor) "RS" having the same value is placed in the other arm thereby balancing the bridge. The fixed resistance is in series with the calibrated (in percentage of sugar) variable resistance "RC." Therefore, the variable resistance must be in its zero resistance position, e.g., completely counter clockwise, when the fixed resistance is chosen and thereafter when the bridge is standardized. This is the standardize position.

When the slide is in the first detent position, the clear part of the tape reflects light into the photocell. The knob must be in the standardize position. The light intensity is adjusted through a 5 ohm rheostat which is in series with the bulb (Figure 4). The knob on the rheostat is adjusted until minimum sound is heard, at which point the bridge is balanced and the light intensity is at its proper level for reading the tape.

As mentioned above, the critical advantage of the Tes-Tape is its property of self standardization. If Diastix were used, a portion of the slide would require a standard test area of the same color and surface as an unwetted sample of

Diastix. This area would fall under the photocell in the standardize detent position. This would be disadvantageous in that the color of the surface and test area would change with age and soiling. The Tes-Tape, on the other hand, always presents a fresh surface for comparisons with the wetted portion of the tape.

The slide is now pushed to the second detent position (Figure 3-B). This position places the wetted area of Tes-Tape under the photocell. The bridge must now be re-balanced using the calibrated variable resistance RC (Figure 4). This resistance is increased until the bridge is once again balanced, at which point the control knob indicates the percent of sugar in the urine. It takes approximately five seconds to standardize the reading unit and make a reading. These five seconds plus the 55 second delay of the timer yields the proper waiting period of 60 seconds before a reading is made.

The dial is divided into six designations as follows: standardize :, then 0% ::, 1/10 % (+) ·, 1/4 % (++) ··, 1/2 % (+++) ···, and 2% (++++) ···· sugar. The zero percent sugar position is slightly above the standardize position. The zero percent designation is necessary because the wetted area of Tes-Tape is slightly darker than the dry area of the tape used to standardize the unit. The dots are raised points which the operator can read with his finger tips, but they are not coded in Braille. The plus signs (+) are the symbols the manufacturer uses in addition to percent to designate the various sugar concentrations. Each dot represents one plus sign. The standardize and zero percent symbols are arbitrary.

Originally it was intended to use the color chart on the Tes-Tape label in order to calibrate the device. The chart, however, has a very glossy surface. This in itself would not be a problem if the surface were perfectly flat because the light source and photocell are positioned as in Figure 3 and, therefore, the photocell cannot pick up light reflected by surface refraction. Unfortunately, the surface is not flat and there is a possibility that some of the light reflected because of refraction will be picked up by the photocell, thereby, invalidating the calibration. For this reason actual strips of Tes-Tape which have been wetted with standard sugar solutions must be used to calibrate the reading unit.

#### Final Development

In the final form the Tape Wetting Unit, the Tape Reading Unit and possibly the Tape Handling Unit will be combined into a single compact device.

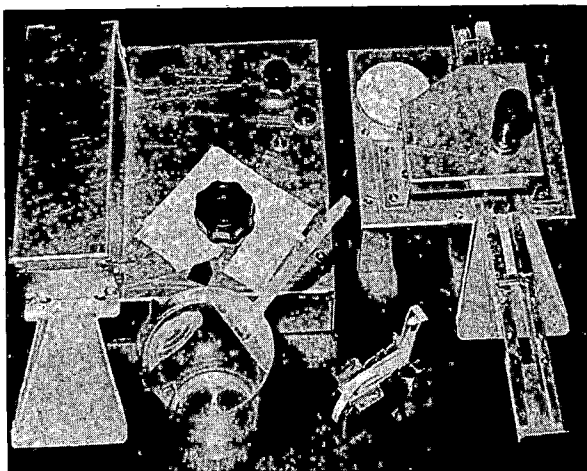

Figure 5,

The Tape Reading Unit is on the left in the preliminary stage of calibration. In front of this is the Urine Collecting Unit. The Tape Wetting Unit with the Tape Handling Unit is shown on the right. In front of this is the Test-Tape Holder.

#### References

1. Ames Company
2. Ibid.
3. Eli Lilly and Company
4. Clairex Corporation

#### Acknowledgement

The authors wish to thank Mr. Robert Adams, Phar. B., Assistant Director of Pharmacy-Medical Supply, at the Good Samaritan Hospital for his aid in preparing the standards used in testing the device.

# PSYCHOLOGICAL FACTORS HAVING A BEARING ON SUCCESSFUL UTILIZATION OF PROSTHETICS AND SENSORY AIDS

by

William De l'Aune and Walter Needham  
Eastern Blind Rehabilitation Center and Psychology Service  
Veterans Administration Hospital  
West Haven, Connecticut 06516

Summary - In previous studies successful emotional and behavioral adjustment, as measured by Minnesota Multiphasic Personality Inventory (MMPI) and California Psychological Inventory (CPI), has appeared to covary with the success blinded veterans attain in acquiring skill in the use of various prosthetic devices or in the interpretation of "natural" environmental stimuli. Normative personality data obtained from the EBRC population is presented with a statistical analysis of different subgroups of the blinded veterans. The findings have possible implications in predicting the success of providing meaningful assistance to similar subgroups of other disabled populations.

## Introduction

It is generally acknowledged that the successful utilization of a sensory aid or prosthetic device is dependant both on the qualities of the device and the qualities of the potential user. However, because most devices are successfully used by some clients and not by others (and we would like to think that the devices remain constant) we are forced to conclude that individual differences on the part of the clients determine, to a considerable degree, the quality of the device/user interaction.

Researchers involved with the evaluation of individual differences and aids for the blind have attempted to clarify the presence of many, often highly intuitive relationships and have provided their readers with some very interesting results, often contrary to armchair speculation. Success of a blinded client in the comprehension of time compressed speech would seem to be strongly linked to both verbal IQ and lack of auditory impairment, but De l'Aune et al (1975) were able to find no such relationships. The ability of a blinded veteran to use acoustic cues to analyze the opened or closed nature of a segment of hospital corridor would seem to be highly related to the results of standard audiometric assessment of auditory thresholds, but De l'Aune et al (1974) found no such results. It should be "obvious" to all that skill in the use of a reading machine such as Optacon or Stereotoner would be very dependant on the verbal IQ of the potential user, since the task involved is basically a verbal one. However, data from Weisgerber et al. (1974, 1975), Schoof (1974), and Gadbaw et al. (1976) have indicated no very consistent relationship. Negative findings such as these are presented to illustrate the complexity of the man-machine relationship, in which intuitively linked variables may play a part and yet still have their relationship with the eventual success or failure of the client masked by other more powerful factors involved with the overall interaction.

Another variable commonly thought to have an effect on the successful utilization of a device would be the psychological health of the potential user. Unfortunately, quantification of something as difficult to define as psychological health has kept most researchers from delving too deeply into this aspect of the client. At the Eastern Blind Rehabilitation Center data from the Minnesota Multi-

phasic Personality Inventory (MMPI) and the California Psychological Inventory (CPI) is obtained from almost all patients enrolled in the regular and special device programs and a substantial number of the patients involved with the low vision program. Because this data is stored, along with demographic, intellectual, and physical data about each client, in a form accessible by computer, it has been possible to use these psychological test results as an estimate of the degree of psychological health and to relate them to success in the utilization and acceptance of devices or sensory information in general. It has also been possible to generate descriptive statistics about the psychological results obtained from this blinded veteran population and compare these with similar data obtained from another group, disabled by pulmonary problems rather than blindness. It has also proved useful to divide the population into subgroups by attending to other variables and to analyse them for possible differences in psychological health.

It is believed that by viewing the compilation of these results a general model of functional or "dysfunctional" overflow can be discerned, in which an individual with substantial psychological problems cannot attend to sensory input or adapt to new devices as readily as one with greater psychological health.

## The Psychological Tests Used

The patients are required to take the MMPI and the CPI as part of their initial assessment upon admission to the blind center. The MMPI consists of 566 true-false statements covering a wide range of subject matter from the physical condition to the morale and social attitudes and is designed to assay those traits that are commonly characteristic of disabling psychological abnormality. The scale scores obtained from this test consist of three validity scales: Lie (L), frequency (F) and correction (K); and ten clinical scales: Hypochondriasis (Hs), depression (D), hysteria (Hy), psychopathic deviate (Pd), masculinity/femininity (Mf), paranoia (Pa), psychoasthenia (Pt), schizophrenia (Sc), hypomania (Ma), and social introversion (Si). The CPI is also an objective personality measure but consists of 480 statements intended for use with non-psychiatrically disturbed subjects and its scales are addressed to personality characteristics important

for social living and social interaction. The results of this test are presented in 18 scales: Dominance (Do), capacity for status (Gs), sociability (Sy), social presence (Sp), self-acceptance (Sa), well-being (Wb), responsibility (Re) socialization (So), self-control (Sc), tolerance (To), good impression (Gi), communality (Cm), achievement via conformity (Ac), achievement via independence (Ai), intellectual efficiency (Ie), psychological mindedness (Py), flexibility (Fx), and femininity (Fe). The inventories are presented to the patients on tape or in their printed version if low vision devices can be utilized in taking them. Responses are recorded on a note pad in the case of persons whose vision is not sufficient to utilize a regular answer sheet. Once on answer sheets the tests are either hand-scored by means of templates in the case of the CPI or machine scored and given preliminary computer analysis for presence or absence of psychiatric diagnosis.

#### Trends between Psychological Test Results and Performance

Speech Compression - Linear regression of performance on a speech compression task and the available (n=68) veterans scores from the CPI revealed statistically significant ( $p \leq .05$ ) positive correlations between performance and dominance (Do), tolerance (To), psychological mindedness (Py), and flexibility (Fx). It should be noted that all of the 18 CPI scales, which measure positive traits, were positively correlated with performance. When the sample was divided into those subjects not able to meet criteria at the 2.5 compression rate (n = 21) and those subjects successfully meeting criteria at this level (n = 45) with t-tests used to determine if the CPI scale scores were different for the two groups, it was found that the scales of dominance (Do), capacity for status (Gs), sociability (Sy), social presence (Sp), reliability (Re), tolerance (To), communality (Cm), achievement via independence (Ai), intellectual efficiency (Ie), and psychological mindedness had significantly different means for the two groups.

Linear regression of performance in this task and the available (n = 63) veterans' scores from the MMPI revealed a significant positive relationship with the K (correction) scale, which is often considered a measure of ego strength, and a significant negative relationship with the depression (D) scale. Eight of the ten clinical scales of the MMPI, which measure negative traits, were negatively correlated with performance. When this group was divided by the performance criterion level (high, n = 42; low, n = 19), it was found that the K scale, depression, and social introversion were significantly different, once again with the successful group showing signs of greater psychological health.

Wechsler Adult Intelligence Scale IQ (n = 65) and educational level (n = 79) were not found to be linked in any significant way to performance in this task (De l'Aune et al, 1975).

Optacon - Although the sample sizes are currently too small to have much confidence in the statistics it was found that nine out of the ten clinical scales of the MMPI were negatively correlated (none to a significant degree) with both teacher ranking of skill and reading rate at the end of the initial three week training period (n = 7)(Gadbaw et al, 1976).

Analysis of Ambient Acoustic Cues - The MMPI scales which correlated significantly with auditory perform-

ance in this environmental assessment task were hypochondriasis (Hs), depression (D), hysteria (Hy), psychopathic deviate (Pd) and schizophrenia (Sc), all of which were correlated in a negative manner. CPI scales of well being (Wb), achievement via conformance (Ac), and intellectual efficiency (Ie) were significantly correlated with performance in a positive fashion. When the groups were divided into high and low scorers in the task, the relationships noted above again emerged as well as significant differences in dominance (Do) and communality (Cm). Again the overall trend for psychological health to be related in success in the task was evident in that nine of the ten MMPI scales were negatively related and sixteen of the eighteen CPI scales were positively related to performance (De l'Aune et al, 1974).

Velocity and Veer - When the speed at which a veteran walked a straight path bordered by waist high ropes was correlated with personality data for ten blinded veterans, it was found that all of the ten clinical scales of the MMPI were negatively correlated with speed (eight to a significant degree: Hs, D, Hy, Pd, Pa, Pt, Sc, and Si). MMPI clinical scales were all positively correlated with the number of rope touchings (an index of veterans tendency to veer from a straight path) with two at a significant level (Sc and Si). Speed of travel was positively correlated with 15 of the 18 CPI scales (two at a significant level: Sp and Cm), and number of rope touchings was negatively correlated with 15 of the 18 CPI scales (seven at a significant level: Sy, Sp, Wb, To, Ie, Py, and Fe). This data was reported by De l'Aune et al (1975) and Needham et al (1975).

While specific scales of these psychological tests lack consistency in their relationship with these tasks, it should be evident that the trends shown by the broad category of psychological health and success in these endeavors can provide the researcher with access to a very powerful factor in the evaluation of the less than apparent reasons for a client's acceptance of a device or his acquisition of skill in processing the information presented to him by the sensory aid (or his environment). It would appear that psychological health is an important quality to consider not only when an individual client is being considered for a sophisticated sensory aid, but also when the device is being developed in terms of selecting a sample population of users. Part of the all too common problem of a device appearing very satisfactory in its developmental and research phases but unsatisfactory in the field may be due to the psychological states of the different groups of users. It is almost axiomatic that the people who display the initiative and talent for volunteering for this type of testing or who have developed ties with the companies or agencies which produce these kinds of items are psychologically different from the balance of the disabled population who would use these items.

#### Normative Psychological Data

The results of the personality testing for blinded veterans at the EBRC (1969-73) are shown in Figures 1 and 2. Especially on the MMPI one finds a shift in the direction of disturbed feelings and behavioral limitations. The scales most strongly associated with a neurotic adjustment, e.g. the "neurotic triad," consisting of the hypochondriasis (Hs), depression (D), and hysteria (Hy) scales, are most elevated. At or approaching T scores of 60 are the psychopathic deviate (Pd) and mania (Ma) scales,

elevations on the former associated with nonconformance with a traditional social role which emphasizes personal responsibility and on the latter, impulsivity and hyperactivity. On the California Psychological Inventory, low scores (standard scores of 40 or less) were found on the tolerance (To) index, which attempts to identify persons with permissive, accepting, and non-judgemental social beliefs and attitudes, and on the intellectual efficiency (Ie) scale, which is felt to be an indicator of the degree of personal and intellectual efficiency which the individual has obtained. Accordingly, blinded veterans acknowledge fewer of the characteristics associated with these two positively regarded traits. It should be noted that the 50 level on both tests refers to mean scores of non-psychiatric populations.

When the MMPI data from the blind center is compared with analogous data from chronic pulmonary patients (Kass, 1971) strong similarities emerge. While the pulmonary patients appear to score higher than blinded veterans on most of the scales denoting psychopathology, the most striking thing about the comparison is the similarity of pattern with the neurotic triad being especially elevated. Possibly this similarity of psychological profile for such diverse groups could reflect the same pervasive aspects of psychological health (or its absence) as found in blinded veterans. If such a phenomenon as "dysfunctional overflow" occurs in other disability groups and affects adaptability of the patient to successfully employ a prosthetic device or a sensory aid, then many implications, both for product research and clinical use, for these other groups emerge.

#### Factors Effecting Personality Traits in the Blind Center Population

**Age** - Correlations run between the age of the veteran at the time of his stay and the blind center and the psychological test results indicated seven of the ten MMPI clinical scales were positively correlated with age (four to a significant degree: Hs, D, and Hy in a positive fashion; Ma in a negative fashion). Eleven of the CPI scales were negatively correlated but only one (Sa) to a significant degree. When the population was divided into those veterans who were forty-six or younger and those who were forty seven or older (split determined by the median age of the veterans), significant differences were found in the MMPI scales of hypochondriasis (Hs) and hysteria (Hy) with the older group manifesting higher scores. No significant differences were found between CPI scale scores for the two groups.

**Extent of Visual Impairment** - Although all patients in the blind center meet the legal criteria for blindness there is a considerable range of visual defects from total blindness to vision approaching the legal limits of blindness. Seven of the MMPI scales are negatively correlated with amount of vision (none to a significant degree) and ten of the CPI scales are positively correlated (none to a significant degree). When the population was divided into those veterans who had no useful vision and those who had some remaining useful vision, no significant differences were found in either the MMPI or CPI scale scores. From this data one can conclude that extent of visual impairment has little discernable effect on psychological factors measured by these tests.

**Speed of Onset of Blindness** - In some cases such as trauma, the onset of blindness is very rapid, while in other cases such as retinitis pigmentosa, the onset of blindness is very slow. Speed of onset was negatively correlated with nine of the MMPI clinical scales (five to a significant degree: Hs, D, Hy, Pt, and Sc) and positively correlated with thirteen of the CPI scales (two to a significant degree: To and Cm). When the population was divided into those veterans who lost their vision in a rapid manner and those who had lost their vision through a slow process, significant differences were found in the MMPI scales of hypochondriasis (Hs), depression (D), hysteria (Hy), psychoasthenia (Pt), and schizophrenia (Sc) with the gradual loss group scoring higher in all cases. The computer classified 77.3% of the veterans losing their sight in a gradual manner as warranting a psychiatric diagnosis, while only 25.0% of the

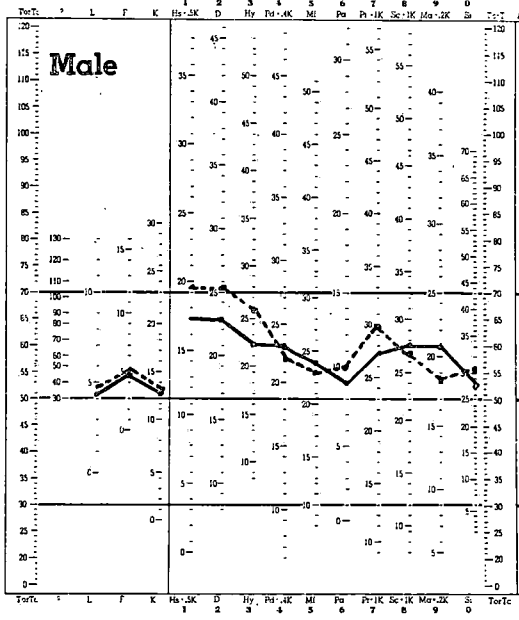

Figure 1. Minnesota Multiphasic Personality Inventory profiles of blinded veterans (n = 89; solid line) and chronic obstructive pulmonary patients (n = 60; broken line).

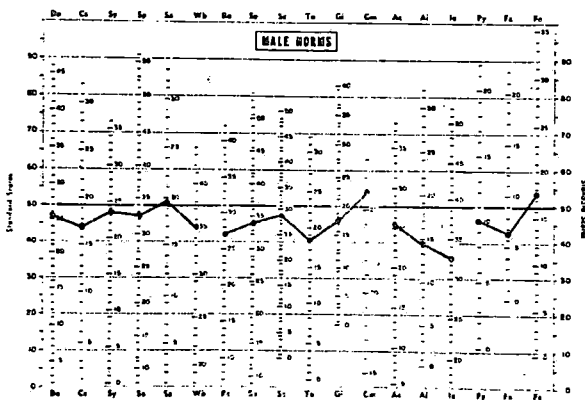

Figure 2. California Psychological Inventory profiles of blinded veterans (n = 92).

acute onset blinded veterans were given such a classification (significant at the .05 level). Significant differences were also found in the GPI scales of tolerance (To) and communality (Cm).

#### Conclusions

While the findings of the present series of studies fail to support what appear to be obvious relationships between cognitive and demographic factors, such as Verbal IQ and sensory impairment with performance, they document the feelings of some investigators in this field in that they underscore the importance of psychological considerations in what seem to be primarily sensory-motor tasks. However, the results, in addition, highlight the apparently pervasive nature of negative psychological state in groups with physical disability.

Whether what the authors term as "dysfunctional overflow" is unique to a physical disability group or is merely an illustration of response set and reflects social desirability (Edwards, 1957), acquiescence (Jackson and Messick, 1962), or the deviation hypothesis (Berg, 1967) remains to be determined. Similar studies need to be done with a variety of control populations to determine whether the pattern of relationships is similar to or different from the blinded veteran group.

An attempt to identify more specifically the test variables which relate to poor performance is needed. An increase in sample size should provide this information. The effect of specialized training in environmental analysis or in the use of a sensory aid upon psychological state is also in need of investigation. Whether psychological state provides definite and certain limits upon this training or the degree to which it can be affected in a positive manner should be considered as well. On the other hand, the question of whether or not an improvement in psychological state as a result of therapy will result in an immediate improvement in aid use or expand the limits of sensory function needs to be answered too.

The immediate implications of the findings are that psychological state, possibly reflected most accurately by scores on psychological tests, should be considered in both the procedures for the development of aids and in the evaluations leading up to the prescription of a device for the individual client. Possibly their application in product development is most important, since the decision to continue or discontinue work on a specific aid potentially affects greater numbers of people. Accordingly, if one wants to get the best user population, he should make certain that he uses not only people who are intellectually able and with few sensory losses but who are also in good psychological health. In retrospect, if a presumably valuable aid is not living up to what is considered its potential, then it would be worthwhile to evaluate the psychological adjustment of its user population, which might mask its true value. It should be emphasized, however, that we do not advocate denial of a device to a particular client who is not functioning well psychologically. While our data on the close relationship between these variables suggests he would not use it as well as an emotionally stable individual, it may be that aid use, along with training, or these procedures combined with psychological therapy might produce a plethora of positive changes in both prosthetic utilization and behavioral adjustment.

#### References

- Berg, I.A. The deviation hypothesis: A broad statement of its assumptions and postulates. In I.A. Berg (Ed.), Response Set in Personality Assessment, Chicago: Aldine, 1967.
- De l'Aune, W.R., Lewis, C., Needham, W.E., and Nelson, J. Correlates of successful speech compression use by blinded veterans. Third Louisville Conference on Rate-Controlled Speech, Louisville; November, 1975.
- De l'Aune, W.R., Needham, W.E., and Kevorkian, G.A. Relationship between indices of mobility and personality factors in the blind: I. Minnesota Multiphasic Personality Inventory. Journal of the International Research Communications System, 3, 1975, 80.
- De l'Aune, W.R., Needham, W.E., Scheel, P., and Gillispie, G.M. Evaluation of a methodology for training indoor acoustic environmental analysis in blinded veterans. Proceedings of the 1974 Conference on Engineering Devices in Rehabilitation, Tufts University, 1974, 26-30.
- Edwards, A. L. The social desirability variable in personality assessment and research. New York: Dryden, 1957.
- Gadbaw, P.D., Dolan, M.T., and De l'Aune, W.R. A Study of the Use of Optacon in a Blinded Veteran Population, research in progress, 1976.
- Jackson, D.N. and Messick, S.J. Response styles and the assessment of psychopathology. In S.J. Messick and J. Ross (Eds.), Measurement in Personality and Cognition. New York: John Wiley, 1962.
- Needham, W.E., De l'Aune, W.R., and Kevorkian, G.A. Relationship between indices of mobility and personality factors in the blind: II. California Psychological Inventory. Journal of the International Research Communications System, 3, 1975, 81.
- Schoof, L.T. An analysis of Optacon usage. AFB Research Bulletin, 29, 1975, 33-50.
- Weisgerber, R.A., Everett, B.E., Rodabaugh, B.J., Shanner, W.M., and Crawford, J.J. Educational evaluation of the Optacon as a reading aid to blind elementary and secondary students. Final report (Contract # OEC-0-72-5180) to Bureau of Education for the Handicapped, U.S. Office of Education, Washington, 1974.
- Weisgerber, R.A., Everett, B.E., and Smith, C.A. Evaluation of an ink print reading aid for the blind: The Stereotoner. Final Report (Contract # V101(134)P-163) to Research Center for Prosthetics, Veterans Administration, New York, 1975.

## THE ARTS COMPUTER

BY

Peter Duran, M.S.  
Philip E. Kucinski, M.S.  
Arts Service Bureau  
The Protestant Guild For The Blind, Inc.  
Watertown, Massachusetts 02172

### Introduction

A handicapped person often cannot compete effectively for many educational and vocational opportunities. In many cases, this is not because he lacks the necessary skills, but because he is burdened by many difficulties in the utilization of his skills. These difficulties arise from a simple truth: the commonly used systems, mechanisms, and tools for the application of these skills were not designed with the handicapped community in mind. For example, most academic work and many kinds of jobs require skills in the written communication of ideas. Yet the available tools for the production of written information (such as pencil and paper or a typewriter) are usually not adequately adapted for use by a handicapped person.

In his search for the means to utilize his skills, the handicapped person is forced to turn to two alternate resources. He can rely on the services and assistance of other people, or he can rely on aids and appliances specifically adapted for his use. To be competitive, a special aid or appliance must prove itself effective, practical, and more useful than the services of other people. This means that any special aid or appliance must offer efficiency, economy, and independence.

Modern computers are flexible, efficient, and highly adaptable and have recently become economical. Consequently, they are the kind of tool that can be effectively adapted to a handicapped person's skills in the areas of information processing and written communication.

### The ARTS Service Bureau

The ARTS Service Bureau is a facility established by the Protestant Guild for the Blind, Inc., to provide computer-aided vocational and educational services to the handicapped. These services are made possible by the ARTS computer, a "talking" computer developed jointly by the Protestant Guild for the Blind, Inc., and American Systems, Inc.

The name ARTS is an acronym for Audio Response Time Sharing. The "audio-response" feature makes using a computer system as convenient for the visually

handicapped as for other persons. The accuracy and high speed of operation inherent in a modern computer permit it to serve a number of people simultaneously without any one person interfering with another's work. This "time-sharing" feature allows many people to "share" the computer at the same time.

The user-oriented computer services were designed so that any individual might make use of them. Persons from a broad spectrum of educational backgrounds are able to gain a practical mastery of these services after a few short lessons. Such services are an immediate advantage to anyone. It is like having a secretary, calculator, teacher, and filing cabinet at one's fingertips. The Protestant Guild for the Blind, Inc., feels, however, that these services offer particular advantages to the handicapped. They will open up new areas of employment, improve productivity in present areas of employment, make the individual more self-reliant by offering an unprecedented degree of independence, and promote self-respect and respect from others. The ARTS facility at the Guild will, therefore, be devoted to serving the handicapped community.

The ARTS computer is contacted through any ordinary telephone by attaching the receiver to a special, portable keyboard which works like the keyboard of any ordinary electric typewriter. A user types his communications to the computer and the computer responds with spoken words which come through a keyboard speaker. The speech quality is quite clear and easily understood. At present, the computer has a vocabulary of over twelve thousand words and the ability to spell any word it does not recognize.

A user can call the computer from any telephone, at any hour, day or night, seven days a week. After using his own special password as identification, a user can request any one of the available services.

### Types of Services

The ARTS Service Bureau provides three major types of service to the handicapped.

- I. user-oriented, computer services providing handicapped

persons with the means to compete in school and in vocational endeavors

- II. a rapid-response, top quality, competitively priced braille transcription service
- III. computer-aided instruction designed for repetitive, skill-building subjects such as typing or spelling

#### I. User-oriented Computer Services

The user services now available are EDIT (for typing and editing), JUST (for production of printed copy), BRL (for production of braille copy), SORT (for alphabetization), MATH (a talking desk calculator for arithmetic), and BASIC (for computation). These services may be applied to a project either individually or in combination.

##### Typing and Editing

Using the EDIT service, a person "opens a file" (the same as inserting and aligning the paper) and begins typing his material. A user may have the computer "echo" each key as he types, i.e., tell him which character has been typed after he strikes a key. Typing errors can be "erased" using a "rubout" key or can be edited later. While typing in material, a user may pause and have any portion of the text read back to him. To proofread and edit the initial draft, a user has the computer read back his text a little at a time and types any corrections and alterations as he proofreads. When he is finished, a user "closes" the file (the same as removing the finished sheet of paper) and it is stored away. Any file created in this manner can be printed, brailled, or reopened for alterations or review.

##### Production of Printed Copy

When composing at a typewriter, a person both types and formats the material. "Formatting" is simply setting up the appearance of a text, i.e., its general "form", so that it is neat and pleasing to the senses. This can be a laborious task even for those without handicaps. For example, margins must be made even, titles must be centered, tables must be carefully constructed, spacing for footnotes must be made adequate, and so on.

When composing at an ARTS keyboard, a user may type his material without formatting it. Using the JUST service, he can have his text subsequently formatted according to a set of standard conventions (double spaced, five spaces for each paragraph, etc.). JUST automatically sets up the appearance of a text, places it on the requisite number of pages, and automatically tells the printer at the ARTS Service Bureau to print a copy of the formatted text. This printed copy is mailed to

the user the same day.

If special formats or changes in the standard format conventions are desired, formatting "commands" may be inserted in the text while it is being typed. These commands are set up in such a way that they can be easily distinguished from the text itself. JUST views these commands as instructions for altering the standard conventions or for treating portions of the text in special ways. JUST formats and prints the text according to these instructions.

If errors are found in the format of the printed text, the whole text does not have to be retyped. A user simply alters the formatting commands. JUST can then reformat and print the corrected text.

##### Production of Braille Copy

Using the BRL service, a user can have any text he produces conveniently transcribed into excellent Grade II braille (Grade I and elementary Nemeth optional). A user does not need a knowledge of braille to produce transcriptions. The BRL service is the braille equivalent of the JUST service. BRL automatically formats the text according to standard braille format conventions (single spaced, two spaces for each paragraph, etc.). If non-standard or special formats are desired, BRL will obey the same formatting commands that are obeyed by the JUST service. After translating and formatting the text, it automatically tells the braille embosser at the ARTS Service Bureau to emboss a copy of the formatted text. This embossed copy is then mailed to the user the same day.

##### Alphabetization

There are many instances when a person wants to sort information alphabetically. The SORT service automatically takes material created by a user and puts it in alphabetical order.

##### Arithmetic

Using the MATH service, a user can do arithmetic (add, subtract, multiply, and divide) and algebraic operations (square roots, cube roots, exponentials, logarithms, and trigonometry tables). A user merely types the calculation to be done and then listens for the answer from the ARTS computer.

##### Computation

Many persons need a sophisticated calculation method for use in such areas as equation solving, business math, statistics, and calculus. The BASIC service offers the flexibility of doing most numerical problems in these areas. BASIC uses an easy-to-learn language which is natural, grammatically simple, and quickly mastered. By making simple statements in

this language, a user can tell the BASIC service how to solve complex problems. The answers are spoken when the calculations are complete.

### Applications

The service described above allow great flexibility, utility, and simplicity in the production of written material. The potential applications for such an array of services in academic, vocational, or personal activities are innumerable. Things as simple as a letter or as complex as a scientific dissertation are within the capacity of these services.

A recent example of the application of these services may illustrate their ability to handle complicated tasks. Using the EDIT, JUST, and SORT services, a user wrote a doctoral thesis in biochemistry complete with tables and diagrams. Redrafting, proofreading, and editing were made quite easy using the EDIT service. JUST was used to generate copies of material as the work progressed and was eventually used to produce the final copies. SORT was used in the creation of the bibliography. The final copies were printed using high quality paper. These copies were accepted and approved by the graduate school awarding the degree.

### II. Computer Braille Transcription Service

The ARTS Service Bureau will do braille transcriptions for anyone who wishes printed matter converted to braille. The text to be transcribed is submitted to the ARTS Service Bureau along with any relevant instructions. The text is given to a fast, accurate typist who initiates the transcription by typing the text into the computer on a typewriter keyboard. The typist inserts simple format instructions in the text which alert the computer so that it can provide for such things as centered headings. Once the text has been entered in the computer, the typist immediately has the computer print out a copy and turns it over to a proofreader.

The proofreader then carefully reads the material and annotates any typing or formatting errors. Texts requiring a high degree of accuracy are proofread aloud against the original text. The proofreader then employs the EDIT service to make the necessary corrections.

The text is now translated using the BRL service. Texts translated by this service meet the Library of Congress standards for certification of transcribers. Normally, no further proofreading is necessary.

There are infrequent occasions when a word or phrase may have more than one possible translation. The BRL service makes a "best" selection in these cases.

If a review of such ambiguous situations is desired, an optional proofreading of the translated text may be done at this point.

Copies are then embossed by a device which embosses braille on good quality braille paper at the rate of six pages every minute. There is no provision for embossing the paper on both sides. If binding has been requested, the embossing is done on paper which has been pre-punched to accommodate 19-hole spiral binders. Completed copies are collated, bound, and packed. The customer is notified of completion and the finished braille texts are then picked up, shipped, or mailed.

### Applications

An active imagination quickly comes up with hundreds of potential needs for braille which can now be satisfied. Only a few of significant impact will be mentioned here.

The visually handicapped student will benefit greatly. Public schools, private schools, colleges and universities can now provide braille copies of the current texts at the start of the student's courses. He will be able to use the same text as his classmates and will not be forced to wait for braille transcriptions. Class notes can be quickly converted to braille. Course instructors can have hand-outs, problem sets, homework assignments, examinations (even final examinations), and questionnaires converted to braille so that the visually handicapped student can be an active and simultaneous participant in his classes.

Blind teachers can now have their lecture notes and other course-related material put into braille on a daily basis.

Corporations employing visually handicapped individuals who read braille can make more efficient use of these employees. Company manuals, directories, other reference materials, clerical forms, reports, questionnaires, and many other types of communications can be made available in braille.

The visually handicapped employee can have daily notes, addresses, letters, and any other material of vocational value converted to braille. This will foster creativity and improve his level of productivity.

Personal items that sighted people take for granted can now benefit the visually handicapped. Imagine a sighted person sending a braille letter to a blind friend or relative. Other common examples might be telephone numbers, address books, recipes, poetry, essays, personal notes, and memoranda.

Organizations with braille readers on their mailing lists or within their scope of interest can provide braille copies of such things as schedules, convention or concert programs, newsletters, catalogues, announcements, chapter reports, minutes of meetings, solicitations, and so on. Political candidates and committees can provide braille circulars to visually handicapped voters.

### III. Computer-aided Instruction

At present the ARTS computer aids in teaching touch-typing to visually handicapped students. This course is available for use in both public and private education of handicapped students. Since typing is necessary for the user services, this course will allow persons who have no typing skills to acquire them before using the ARTS system.



SESSION L

SENSORY IMPAIRMENT

SPELLEX - A SYSTEM OF SPEECH AIDS FOR THE  
VISUALLY HANDICAPPED IN VOCATIONAL TRAINING

by

Ching Y. Suen

Department of Computer Science  
Concordia University  
Montreal, Canada H3G 1M8

and

Michael P. Beddoes

Department of Electrical Engineering  
University of British Columbia  
Vancouver, Canada V6T 1W5

Interfaced by digital electronic circuits, Spellex is the first comprehensive system to provide voice output for a wide variety of office and computer equipment. We believe this system will not only open up better job opportunities for the blind people, but will also facilitate their vocational training and enable them to be easily integrated with the sighted world.

Introduction

In the recent few years, an increasing number of blind people are holding professional and technical jobs working in the same environment as their sighted colleagues. The rapid progress and development in modern office equipment have also imposed more stringent training requirements for the blind. Fortunately, the field of sensory aids for the blind has made significant advancement and is now entering the "Talking Age". This is a very important stage in the history of sensory aid development because, unlike Braille which is good for only about 15% of the blind population, speech is understood by almost everyone. We envision that talking aids will become more and more popular replacing tactile ones because they are much easier to use.

In this paper, we describe a relatively inexpensive system designed to aid the visually handicapped in their vocational training and daily usage of office and computer equipment. We will describe the functional operations of the different components and their applications. We will also present our views on the implications of this new system in the practical environment.

The Spellex System

A block diagram of the Spellex system is shown in Fig. 1. It consists of a voice box which generates spelled speech and an electronic interface to service both office and computer equipment. Descriptions are as follows.

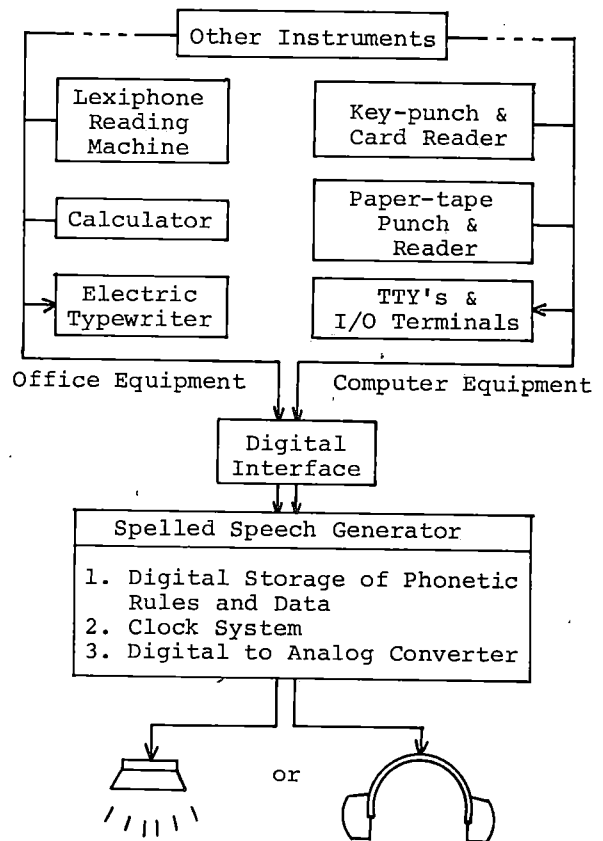

Fig. 1 Block diagram of the Spellex system.

## Voice Box and the Digital Interface

The digital interface converts the electronic output signals of the various machines into ASCII codes. Upon receipt of an ASCII code, its address is found and the sound corresponding to this code is synthesized in the voice box by rules stored in memory. Thus, one hears the sound A (phonemes /e/ followed by /i/) when the ASCII code 301 reaches the machine. The voice box is equivalent to a miniaturized computer which is capable of generating the spoken sounds of all the 64 ASCII characters.

## Office Equipment

Typewriter and calculator are the two machines which are made to 'talk' by the spelled speech generator. The Lexiphone is a machine which 'reads' out in spelled speech, typewritten characters on books or reports. This machine exists in computer simulated version and we are currently implementing it in portable form.

## Talking Typewriter

Blind students are taught to type in schools or in rehabilitation centers. Though normally they are competent typists, it seems practically impossible to achieve a high degree of accuracy without the ability to proofread. With the talking typewriter, a blind individual can hear and correct mistakes in typing. In addition, a call-back feature in the typewriter enables the typist to retrieve the last few words to indicate where she stopped typing in case she was interrupted by other tasks such as a telephone call. Experiments with blind typists indicate that it takes only 1 to 3 hours to get used to the device and that spelled speech can be understood up to 80 words a minute. A primary benefit is that the rate of mistakes drops by a factor of three and the presentation looks clean and neat.

In Vancouver, Spellex has been used since 1972 in centers for the blind. In particular it has been incorporated in a program teaching children how to type. Many advantages accrue from this approach. They learn to type quickly and accurately. Auditory memory for the spelling of words is reinforced. Blind and spastic children especially benefit from this system, for their lack of muscular control is compensated by their ability to hear their mistakes and erase them.

## Talking Calculator

The talking calculator is built from a calculator chip. Digital circuits have been built to convert the outputs of the function keys, digits and decimal point into ASCII codes. Five functions

are available from the calculator, namely addition, subtraction, multiplication, division and percentage operations on positive or negative eight digit, floating point numbers. It is capable of doing chain or constant problems while retaining another number in an independent memory register. Upon receipt of the ASCII codes of the functions and digits keyed in, the corresponding sounds will be generated.

## Lexiphone Reading Machine

Fig. 2 shows a block diagram of the Lexiphone reading machine. It consists of the optical character recognizer (OCR) and a spelled speech generator shown in Fig. 1. It can provide a blind person with an easy means of accessing printed information.

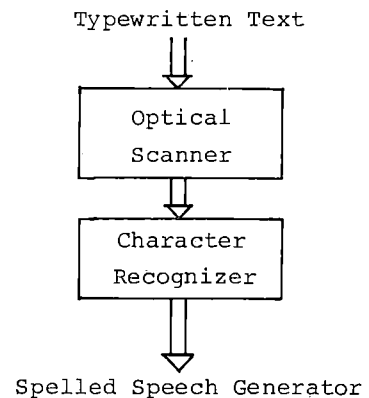

Fig. 2 Schematic of the Lexiphone.

As the scanner moves along the line of print, binary signals representing the black and white portions of characters are generated by the photocells. The recognizer processes these digital signals from which topological and geometrical features of the characters are extracted. A printed symbol is recognized when its feature matrix matches one of those stored in memory. Since the required functional reading speed of such a machine is not high (up to 100 words/minute), a large portion of the processing time can be devoted to the recognition process to achieve a reliable recognition rate between 95 - 100%. Most errors were due to print and paper quality. Presently it can read several type fonts and experiments indicate that this machine can be mastered in a short time.

## Computer Equipment

Several hundred visually handicapped people have taken up jobs in computer programming. However, high precision is

required in this field and there has been no easy way for a blind programmer to proofread programs or output, be they in card form or in print. Some Braille embossers have been installed at some computing centers, but they have their drawbacks. With a voice output, the Spellex system is specially designed to facilitate the work of blind computer users and thus reducing their dependence on sighted help in various I/O situations.

Through the digital interface, one hears the sound of a symbol as it is punched either on card or on paper-tape. For verifications and corrections, the card-reader and the paper-tape reader produce sounds of the characters punched. By the same token, a blind programmer hears the input statements/data and the output results/data when communicating with the computer. With these machines talking, a blind programmer can easily control and monitor his programs. He can command the computer, be it large or small, to spell out any line of the program or output. The rate can be varied to suit the individual programmer. In this way, he can check for bugs and make the necessary changes. More details are described in [3].

#### Conclusion

Interfaced to a fair number of different types of machines, the Spellex system is capable of filling many of the current needs of the blind. They hear what they do. The voice box is very versatile and it can make any machine talk as long as ASCII outputs are available. It can be manufactured quite cheaply if sufficiently large quantities are requested. Right now, the Spellex system speaks English and French, but it can be modified easily to become multi-lingual.

#### Acknowledgements

This work was supported by the Education Department of Quebec, the Medical Research Council and the National Research Council of Canada.

#### References

1. Beddoes, M. P. and Suen, C. Y. "Some Figures of Performance and the Apparatus for a Digital Talking Typewriter for the Blind - Spellex" IEEE Trans. Biomedical Engineering, vol. BME-23, 73-75, Jan. 1976.
2. Suen, C. Y. and Beddoes, M. P. "Development of a digital spelled speech reading machine for the blind" IEEE Trans. Biomedical Engineering, vol. BME-20, 452-459, Nov. 1973.
3. Suen, C. Y., Beddoes, M. P. and Swail, J. C. "The Spellex System of Speech Aids for the Blind" Proc. National Computer Conference, New York, June 1976.

## THE ROLE OF TECHNOLOGY IN DEAF-BLIND COMMUNICATION

by

Frederick M. Kruger, Ph.D.

and

Jill Rosenfeld, M.S.

National Center for Deaf-Blind Youths and Adults  
Sands Point, N.Y.

In this period of rapid technological advancement, there is no reason for the deaf-blind person to be deprived of independent means to communicate for safety, survival, or social purposes. We have been developing special "high technology" devices to partially meet these needs. The Telebraille and the Wrist-Com are two such devices: the former sends and receives braille over the telephone; the latter provides an environmental signaling system featuring a vibrotactile receiver worn entirely on the wrist.

Deaf-blindness is a fact of life for 10-15 thousand people in the United States. With no means of distinguishing between day and night, no radio or T.V., and minimal access to magazines or newspapers, most of these people live a very lonely, isolated life. Because of the relatively small number of such persons, and the circumstances surrounding their lives, deaf-blind individuals belong to an all but invisible minority. Even though some of these people have some sight or hearing, their use of it is, at best, quite limited. This paper will give emphasis to the problems of the deaf-blind person with no usable vision or hearing.

Deaf-blind people are like everyone else in most respects. They too have needs and desires, and they too like to communicate. Intellect is not a function of visual or auditory ability. Most deaf-blind people can learn to communicate - some quite well - using other channels. Persons who are deaf and persons who are deaf-blind have many communication problems in common. When close together, persons with either handicap communicate through various combinations of touch and gesture. The deaf person may have someone attract his attention through a touch on the shoulder. He would then look at the other person and carry on a conversation through sign language or finger spelling (One Hand Manual Alphabet). The two might even write messages to each other. In contrast, the deaf-blind person would receive the signs or spelled messages tactually: that is, by holding on to the other person's hands and following the signs or gestures; or by having words finger spelled into his hand. Writing messages back and forth is not possible.

One could, however, communicate with a deaf-blind person using one of a number of techniques involving single letters of the alphabet. More specifically, capital letters could be block printed into the palm of the deaf-blind person and he could respond either by speaking, or possibly, by printing letters back. He might also use a plate with raised alphabet letters and request that his fingers be touched to different letters in sequence to spell words. He could then point to the appropriate letters to spell

back. Another method involves raised braille characters on a card, each next to, or immediately under, the corresponding printed letter. Sometimes, a push or other contact gesture is sufficient for communication. For example, a deaf-blind person might learn that a large "X" written across his back is an emergency signal meaning "go to the emergency exit immediately." Although this last technique is used, it leaves much to be desired. Think for a moment of the problem that would exist if you wished to tell the deaf-blind person that there was a fire and he should go to the exit, but the fire separated you from the deaf-blind person - and each had a clear path to different assigned exits. If he could see, a signal might not be needed, or brightly flashing alarm lights might accomplish the desired goal. If he could hear, alarm bells would be sufficient. Unfortunately, without vision or hearing, the deaf-blind person would be totally alone - even in a crowded room - if no one were near enough to touch him!

Beyond the span of three feet, a distance approximating the span of two outstretched arms, the problems of communication for the deaf-blind individual become immense. Every communication activity is, for the deaf-blind person, a specialized activity requiring special equipment.

With little or no sight or hearing, information about the environment must be conveyed via the remaining senses: touch, smell, and taste. Of these, only smell can be considered a distance sense. Food burning on a stove can be smelled - sometimes at quite a distance! Thus, the deaf-blind person can receive a communication, via the sense of smell, that he forgot to watch what he was cooking and that it requires his immediate attention. Smoke and gas smells can also indicate emergency conditions. It is only the sense of touch, however, which has the capacity for the fine resolution so necessary for communication. Actually, one should say vibrotactile, since it is this combination of touch and vibration that is most used when communicating beyond direct personal touch.

What are the special requirements to be considered when defining the "beyond three feet" com-

munication needs of the deaf-blind person? What are the various communication devices a deaf-blind person might need or want to use? What devices are necessary so as not to deprive deaf-blind persons of the everyday conveniences we inevitably take for granted? Consider the basic problems of survival confronting the deaf-blind person at home. The telephone is a prime example of an emergency "distance" communication device - the doorbell can also be considered an emergency signal, as can a fire alarm bell.

The first of these requirements is the need for special input-output conversion. What specific provisions must be made to convert a standard device output (e.g., sound from a telephone) so that it can be adequately inputted to (i.e., perceived by) the deaf-blind person? Also, what specific provisions must be made to convert a potentially non-standard output from the deaf-blind person to the standard input that may be required by a device (e.g., sound to vibration, button presses to sound, etc.)?

The second requirement is ease of operation. Any special communication device must be designed for use by average people - not geniuses! Moreover, under emergency conditions even a genius may become confused and not be able to properly operate an overly complex unit. With ease of operation comes the requirement that the device not intrude on other normal activities. It should not require special handling or attention when it is not in use. Also, most deaf-blind people would prefer that all such devices be small and sufficiently inconspicuous to not call attention to them - especially when not in use. Obviously, this isn't always possible.

The third requirement is reliability. Any aid or device designed for deaf-blind people, no matter what its specific application, must be reliable. It must always operate when called upon to do its job, it must be sufficiently rugged to survive falls from shelves or table tops and, where at all possible, it should be very water resistant. Also, if it uses a battery, it should not be ruined if the battery is inserted backwards. (Where possible, it might be advisable to connect a diode bridge circuit to the battery so that the device will work normally no matter which way the battery is inserted.)

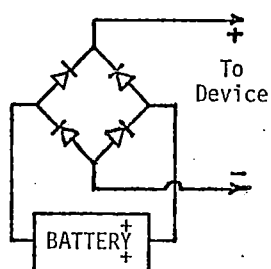

ACTUAL CIRCUIT

Device will receive correct polarity voltage no matter how the battery is inserted. (Better yet, make it impossible to insert the battery backwards!)

Note: If this circuit is used, the 1.2 volt drop through the two silicon diodes must be considered when specifying the required battery voltage.

DIODES MAY BE USED IN THE POWER SUPPLY TO ELECTRONICALLY SWITCH BATTERY POLARITY

Two additional desirable considerations are that the user be able to test the device for proper operation and that the device itself, where possible, monitor its own operation and indicate in some unique manner when future reliable operation is questionable. For example, a child's hearing aid might be considered more valuable if it began to flash a small indicator light a few hours before its batteries died. This would indicate to a parent or instructor that the battery needed replacement and would avoid the problem of a child wearing a "dead" aid for some period of time.

In similar fashion, any electronic communication aid for a deaf-blind person should indicate imminent failure. Since the user may not be able to see or hear at all, a unique vibratory signal might be triggered to indicate a low power condition, etc.

#### Communication beyond three feet

So far, some of the problems of communication beyond three feet by deaf-blind persons have been described. Where personal contact is not possible, communication can frequently require very advanced technology.

Until recently, the use of a telephone by a deaf-blind person required quite a bit of ingenuity. If he could speak intelligibly, for example, he could call a person, explain that he could not hear and instruct the distant individual to respond to various questions by operating the rotary telephone dial to make one click for "no" and 4 clicks for "yes." (Obviously, this technique could not be used with Touch-Tone telephones.) The caller would place his finger on the earpiece, or on the output transducer of a device designed to amplify these clicks so that he could feel the coded replies to his questions. (A hearing aid with a telephone pick-up coil and a bone conduction transducer could be used.) Thus, through a series of questions, similar to the game of Twenty Questions, the deaf-blind person could converse. If the deaf-blind person and the distant individual both knew Morse Code, they could converse more normally. The distant person would dial either a "1" for a dot and a "4" for a dash (one click and four clicks) or, say "dit" for a dot and "da-a" for a dash. The different vibrations would be felt on the output transducer.

For the person who couldn't feel the vibrations from the telephone earpiece (receiver) and who didn't own a hearing aid with the telephone coil and bone vibrator, a special portable electronic device was designed. It is called the Tactile Speech Indicator, and works quite like the hearing aid with an "induction pick-up" telephone coil and a bone vibrator. A similar device which is directly attached to the telephone provides for sending and receiving Morse Code more easily. It is called the Code-Com and is available through most Bell Telephone System business offices.

With these beginnings, the use of the telephone by many deaf-blind persons as a "communication-at-a-distance" device became a reality. But what about the deaf-blind person who could not speak intelligibly, or did not know Morse Code? What could he do? Unfortunately, until

recently the answer was, "not too much!" The fact is that it is rarely, if ever, profitable for a manufacturer to make devices for so small a group of potential users. With partial or even total government support for the development of special communication devices, the cost to commercially manufacture and sell them - including parts, labor, overhead, profits, etc. - usually puts the purchase price beyond the reach of most deaf-blind people. This discourages technological innovation and many good ideas are never developed because of the lack of adequate support. A new approach is needed to solve this problem of cost.

If we consider only survival communications, we can list at least these requirements:

1. Some device to indicate the ring of a doorbell - preferably having provision for indicating different types of ring "signals."
2. A telephone ring indicator to indicate there is an incoming call.
3. Some means to communicate over the telephone. There should be a means to call and indicate an emergency even if the deaf-blind caller cannot speak and even if the distant party cannot send Morse Code.

Until quite recently, there were very few devices available to help the deaf-blind person meet these needs. Moreover, most of the early signaling aids were primarily designed to assist people who were only deaf. To indicate to a deaf person that the doorbell had rung, a device was developed to turn special room lights on and off. A related device was connected to the telephone and made a lamp blink on and off as the phone rang. To enable a deaf-blind person to use such devices, modifications were made so that an electric fan, or several fans, were turned on when the doorbell or telephone bell rang. Unfortunately, most of these devices were built by well intentioned individuals, many of whom did not fully consider the implications of using attachments which placed 117 volts across the contacts of a doorbell button or which, with certain component failures, could connect 117 volts to the telephone. Clearly, any of these particular devices presents survival problems of its own!

Furthermore, even without consideration of possible risks of electric shocks or worse, the deaf-blind person would always have to be near a fan to receive the ring signal. More recently, heavy duty vibrators have replaced fans for some people, but the problem is still the same. For the signal to do its job, one would have to be close enough to feel it. The third requirement, that of emergency telephone communications, has been met in several ways. A deaf-blind person who can speak might use one of the techniques described earlier. He might, for example, follow this sequence:

The Tactile Speech Indicator would be coupled to the telephone earpiece and one finger would be placed on the "tactile finger pad" or vibratory button. A steady vibration would indicate a dial tone. After dialing, a rapid puls-

ing of the finger pad would indicate a busy signal; while a more steady on-off vibratory sequence would represent the ring signal. Obviously, the termination of this signal followed by aperiodic vibrations would indicate that the phone had been answered and someone was speaking. He could then say, "I am deaf and cannot hear you. We can communicate in the following way - I will ask you questions and you can answer them by saying either "no" or "yes-yes." It is something like the game of Twenty Questions. Is that clear?" If it is, the caller will feel two vibrations on the finger pad and can continue; if not, he can try to explain further. Similar sequences would be followed when both parties know Morse Code.

If speech were not possible, only a two-way tactile system, such as Morse Code, could be used - but only when the called party knew what to expect and could respond appropriately.

With the recent advances in solid state electronic technology and the development of integrated circuits and ultra-miniaturized components, it has become possible to build devices which previously would have been quite impractical, if not impossible.

In the last 10-15 years, it has become possible for deaf people to send and receive type-written messages over the telephone using specially designed acoustic coupler/modems connected to a modified, usually surplus, teleprinter machine (phone TTY). Most recently, such machines have been installed in a number of police department emergency centers with special telephone numbers, thereby partially satisfying, within their service area, the need of deaf persons for emergency communications.

Some deaf and deaf-blind persons have even purchased and adapted different wireless paging devices to partially serve their needs for distance signaling. The National Center's research staff, in conjunction with the New York University Deafness Research and Training Center, reported on a field evaluation of devices for maintaining contact with mobile deaf and deaf-blind persons (Electronic Communication with Deaf and Deaf-Blind Persons, 1973). The study clearly indicated that wireless signaling devices could be used to great advantage as pagers and doorbell or telephone ring indicators. It also pointed out the shortcomings of the then available devices and made recommendations for a future device which would incorporate the best features of each unit studied as well as new features specifically designed to meet the unique needs of deaf-blind and deaf persons.

Several projects have been initiated at the National Center for Deaf-Blind Youths and Adults which have as primary goals the development of good communication aids for survival purposes. Obviously, it is our implicit intention to provide the ability for better social communication as well - even if still only on a one-to-one basis.

The following is a somewhat detailed discussion of the devices we are presently developing, followed by an outline of some of our plans for the future. First, however, let me indicate that technical designs for and information about

any devices we have developed or are developing will be made available to any responsible individual or group wishing to produce them for deaf-blind persons. We only insist that our quality standards be maintained and that the selling price to the ultimate consumer be as low as reasonably possible, and consistent with our guidelines. We also provide consulting services without charge when requested to do so. As a matter of fact, such consultation services based upon one of the devices we are currently developing, the Telebraille, led to the production of a special telecommunications unit which has a typewriter input, an embossed braille paper tape output, and which is compatible with the various teleprinters being used in the deaf phone TTY networks. Unfortunately, this particular device, which is being manufactured privately, costs more than \$2,300. Still, it is available now and for the newly blinded deaf person, as well as some other deaf-blind persons, it does fulfill some of the requirements discussed earlier.

Presently, three devices are being developed at the National Center. They are the Telebraille, the residential model of the Wrist-Com, and the institutional model of the Wrist-Com. There is one more item which we are making - the Telephone Ring Indicator - but it is neither new in concept nor in its applications. As mentioned before, devices have been available for some time to turn on lamps, fans, etc., in response to telephone rings. The National Center's Telephone Ring Indicator is a solid state device which has the following special features:

1. It is acoustically coupled to a telephone. Since there are no direct connections to the telephone, no monthly fee is added to a phone bill, and a potential source of electric shock is avoided.
2. It can operate with an internal nine volt battery or the more desirable external low voltage power supply.
3. It has a sensitivity adjustment and can be easily set to respond to the ring of a telephone placed on it and not to room noise or conversation.
4. The control circuit is available with either solid state logic output to connect to the environmental monitor microprocessor input, or 1.5 amp. relay contacts (as would be used to safely control lamps, fans, etc.).

#### Telebraille

The telebraille was developed to enable two deaf-blind people to communicate over the telephone using braille. There is no need for third party intervention; thus, the same privacy most of us take for granted is assured. The "speaker" sends braille using a keyboard quite similar to that on the Perkins Brailier (a standard typewriter keyboard will be available in the future). The "listener" reads the message from a single braille cell.

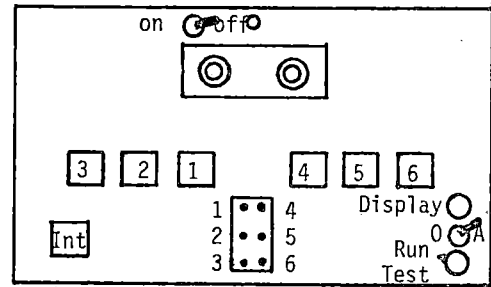

TELEBRAILLE

As each braille character is typed, it is converted into a corresponding audio frequency-shifted binary data string which is acoustically coupled to a telephone handset. On the receiving end, the handset is acoustically coupled to an identical unit which converts the binary frequency-shifted string to signals that raise the appropriate pins in the braille cell. Both Grade I and contracted forms of braille can be transmitted via the Telebraille.

It is possible to transmit data in both directions simultaneously - a feature which may be more fully utilized at a later time. Right now, however, this ability is utilized to make it possible for one user to send an interrupt signal to the other. In illustration, if User #1 is transmitting too fast, User #2 can press a seventh pushbutton (at the lower left of the Telebraille's panel) and thereby cause User #1's Telebraille to vibrate. Thus, User #1 is made aware that User #2 wants to transmit and can prepare to "receive" the interrupting message.

The Telebraille offers the deaf-blind person a new level of communication. It is packaged in an attache case and can be used with almost any standard telephone handset. It is compatible with "100 series" data sets and, with a minimum of special programming, it can be used as a very special computer terminal.

In the future, after field testing is complete and production has begun, a number of options will be made available. These will most probably include embossed paper tape output, the above mentioned standard typewriter keyboard, and another, perhaps even more important "addon" - an electronic converter and coupler to enable the deaf-blind user to contact and communicate with deaf people using the deaf phone TTY (Teleprinter) network. Braille will be sent and received with the electronic circuits converting to and from the teleprinter code.

We are currently working on these designs and may make some improvements and/or alterations in the design after our research with the field test models.

#### Wrist-Com

Based upon the results of the recent joint study with the N.Y.U. Deafness Research and Training Center, a list of essential characteristics

for wireless vibratory signaling devices was drawn up. It included such features as 1) shock resistance, 2) reasonable range, 3) water resistance, 4) ease of wearing (carrying), 5) limited or no licensing requirements, 6) no antenna or transmitter tuning or adjustments, 7) easy procurement of batteries, 8) ability to send "pre-coded" signals, and 9) reliability.

These features, then, became the design criteria for a new wireless vibratory signaling device - the Wrist-Com. For maximum efficiency and economy two designs evolved in our research department - one for residential use and one for use in schools or institutions. The former is being developed and prototyped by the National Center's research department, while the latter is being developed with the cooperation and assistance of the National Aeronautics and Space Administration - Ames Research Center.

The residential model will be able to replicate - in vibrations from a receiver worn on the wrist - any signal transmitted to it. The transmitter is plugged into a standard A.C. wall outlet and uses the household wiring as an antenna. In case of a power failure, back-up battery will take over and the transmitter signals will still be radiated via household wiring. No Federal Communications Commission (F.C.C.) license is required, and the transmitter requires no installation other than plugging it into a wall outlet. No field tuning is required, either. Production receivers will be water and shock resistant.

The institutional model is far more complex. The system, using one master transmitter console, enables the operator to select an individual, group, or all Wrist-Com receivers for a message. The receivers are quite sophisticated - having circuits which decode transmitted impulses, signal the wearer that a message has been transmitted (the entire unit vibrates) and then repeatedly send a Morse Code letter to a vibratory "finger pad" on the top of the Wrist-Com until the unit is reset by the wearer. It will have a range of one-half mile. If licensing permits, it will be possible to transmit complete Morse Code messages to a given individual or group. If this is not possible, single Morse letters (vibratory pattern) will represent different messages.

When the residential system is connected to the environmental monitoring system, it will be able to send different signals to the receiver for doorbell, telephone, burglar alarm and fire signals. Furthermore, a Morse Code key can be directly connected to the transmitter. This is especially desirable in a household with two deaf-blind persons, where one will be able to call or signal the other without both having to go to a specific location to meet when a simple alert signal is received.

The first residential Wrist-Com receivers and transmitters will be built during the next 12-18 months. These first units will be put to temporary use at our new permanent facility, thereby enabling us to evaluate them and make any necessary improvements before distribution to other users. Unfortunately, the institutional Wrist-Com is still several years from completion. When it is completed, however, it will replace

the more basic units at our permanent facility.

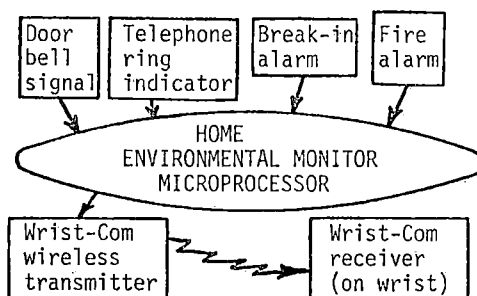

1. Coded doorbell signals possible
2. Telephone--cyclic on/off vibration
3. .... Break-in
4. .... Fire

### WRIST-COM SIGNAL SYSTEM

#### Environmental Monitor

The environmental monitor is actually a major component of the Wrist-Com transmitter package. It is a special processing system having a number of inputs: doorbell, telephone, burglar alarm, and fire alarm, which it senses in a priority order. This is done so that the most important message is always transmitted first. While the breadboard model makes use of CMOS medium scale integrated components, it is anticipated that the production units will make use of a low power, large scale integrated microprocessor to enhance utility as well as increase reliability.

A visiting individual can use a special signal to indicate that it is he who is at the door. He might, for example, press the button to ring two long rings followed by one short ring. The deaf-blind person would feel two long and one short vibrations on his wrist. He would then know who was at the door without opening it. At least, he could establish a few unique signals to indicate friends, merchants making deliveries, or strangers. If the telephone rang, the ringing sound would be sensed by the Telephone Ring Indicator and converted to on-off pulse sequences which would then activate the environmental monitor and the Wrist-Com transmitter. If the phone were to ring while someone was continuously pressing the doorbell button, its signal would still be transmitted to the receiver as an on-off vibration sequence identical to the bell ring-silence sequence we hear. If a window or door is now opened, even during the telephone ring, the monitor will alter the transmitted signal to a long signal followed by three short ones, i.e., Morse Code for the letter "B" for burglar alarm. If something in the apartment were to begin to burn, a combustion detector would send that message to the environmental monitor and the Morse Code for the letter "F" (dot-dot-dash-dot) would be transmitted. Thus, each higher priority signal is transmitted even though other signals were in progress.

The monitor is being designed so that the type and priority of signals transmitted can be easily customized to suit individual needs. Even the speed of signal transmission will be adjust-

able. These last items lead to a very important point.

No matter what aid or device is being developed, it is imperative that a number of deaf-blind consumers be involved in the project as early as possible. By doing this, the likelihood is very great that the end product will actually be usable by deaf-blind persons. Moreover, if there is some need for individual modifications of the device, provision to facilitate customizing changes can be designed into the unit. This cannot be emphasized too strongly! Any aid or device intended for use by a handicapped individual or group of individuals must be developed with consumer consultation throughout the project. Otherwise, there is a great risk that the well intentioned designer will produce what may be a technological marvel to most people, but a useless novelty to the desired consumers!

What about the future?

We have not yet provided solutions to all problems of survival communications for deaf-blind people. We are presently developing or testing a number of devices intended to accomplish this goal, but the units are still not available to the consumer. Also, our designs will not meet the needs of all, or even most, deaf-blind persons, but we feel we are making a good start.

It was mentioned earlier that Morse Code is a useful means of distant communication by deaf-blind people. We know from a preliminary survey that many more deaf-blind consumers would: a) learn, and/or b) use, Morse Code if they had a small, portable, reliable, battery operated, sending and receiving unit that could be used with most telephones and which cost less than \$100 or \$150. We have some design ideas and will share them with interested parties.

Because many deaf-blind persons can speak intelligibly, we have plans for a future modified Telebraille which will enable a deaf-blind person to telephone a hearing person and speak to him. The only sending device the hearing person will require to respond is a push button-tone type telephone or a small portable unit with a self contained push button dial that can be held over the telephone mouthpiece to send tones back to the caller. For each letter he wished to send he would have to press two buttons. The first button pressed would indicate the number of the button containing the desired letter and the second would designate the position of the letter on that button. For example, the letter "K" would be sent by pressing button "5" and then button "2," because the "K" is on the 5th button and is in the second position. The letter "Y" would be sent by pressing button "9" and then button "3." That Telebraille model will electronically translate the two button sequence to the appropriate braille character, which is then displayed to the deaf-blind person as described earlier. Clearly, this means that emergency calls, or even social calls, can be made more easily and to more people by a number of deaf-blind persons. Also, both parties needn't own Telebrailles! This approach is being adapted from a similar device being designed for communicating with deaf persons, where the "read

out" is a single, or multiple letter visual display.

As good as these ideas and designs are, they are not adequate to serve the numbers of deaf-blind people who, due to other handicaps and lack of formal education, have limited or no formal language. If these people are to have the types of survival communication currently under discussion, special systems must be designed to fit their needs. While it is true that a Wrist-Com system may provide adequate signaling and alarm monitoring, no current device can call for help and indicate the nature of the problem. Here, too, however, modern electronic technology can provide the solution!

There now exists a specially designed security system. A break-in, a fire, or a malfunction not only summons help, but also indicates the nature of the problem. The system is monitored by a trained person 24 hours a day. This approach can be easily adapted for emergency signaling by any deaf-blind person, or for that matter, any other handicapped person. We have already provided information to one interested company on Long Island about the types of signals required and the appropriate responses that might be needed, such as: "Help! Fire!", "Call the police", "I have a medical emergency", or "Have someone who can send Morse Code call me!". (There would be one labeled button for each type of emergency.) The all electronic system is quite sophisticated and actually dials the telephone, determines that it is connected to the emergency monitoring center, identifies the caller, and then signals the type of emergency - all from a single button press!

As more individuals and organizations - private or public - become aware of the problems and needs of deaf-blind persons, we are confident that we will find others to develop these ideas into actual hardware. Moreover, they will find ways to produce the small, sometimes custom modified, quantities needed at reasonable cost.

It is our hope that, in the near future, we will be able to provide the deaf-blind person with greater freedom to communicate with other people - to even make possible communication with strangers.

# A REAL TIME SOUND SPECTROGRAPH WITH IMPLICATIONS FOR SPEECH TRAINING FOR THE DEAF

L. C. Stewart, Wilbur D. Larkin, and Robert A. Houde

Center for Communications Research  
50 West Main Street  
Rochester, New York 14614

A real-time speech spectrograph has been developed which is practical for clinical use. It produces and stores a frequency-time-intensity display on a video monitor while the sound is being spoken. The display closely resembles a conventional, broad-band spectrogram in time, frequency and grey scale resolution. Preliminary evaluations have been made to show its usefulness 1. as an aid to the therapist in diagnosis and communication of concepts, and 2. for student drill relatively independent from the therapist. These results suggest that the instrument has considerable potential for training speech production with deaf.

## The Problem

Most prelingually deaf children never achieve speech intelligible to the average listener. In spite of a considerable amount of speech training by skilled and dedicated teachers, the typical deaf child completes his education still unable to communicate verbally with the sales clerk, the bus driver, the supervisor on the job, or the teacher at the community college. The lack of verbal communication skills makes it extremely difficult for the individual to participate in the mainstream cultural, social and economic activities of society. The majority of the prelingually deaf restrict most of their social contacts to within the deaf community, and also find their employment opportunities severely reduced.<sup>18</sup> The lack of verbal communication skills makes it very difficult for the deaf to realize their full potential in a hearing society.

The significance of this problem at the personal level is obvious. At the national level the importance of the problem can be measured in terms of the cost to society of the special education programs, and the loss to society of the unfulfilled potential of the deaf. Based on the recent demographic studies of Schein and Delk the number of victims of early profound deafness in the U. S. is estimated to be greater than 400,000 with more than 50,000 of these in special education programs at a yearly cost of more than 100 million dollars.

## The Speech Training Problem

It is generally agreed that the deaf child can learn speech if he is provided with a sufficiently large amount of individual instruction by very skilled teachers. Thus, the failure to teach speech to the majority of the deaf may be viewed as a failure to provide a sufficient quantity of individual speech training to all the deaf. This problem would be obviously solved by a suitable increase in the quantity of speech training efforts now being provided to the 50,000 students currently in deaf special education. This inelegant solution, however, is ruled out of consideration because it would require a significant increase (approximately five-to-ten-fold) in the resources which society allocates to the problem.

The main thrust of the research devoted to this problem has been in search of new approaches which might dramatically increase the effectiveness of training efforts. This search has been long, intense and imaginative and has resulted in a large number of varied techniques.

The second possible direction for research in this problem, that of developing techniques which might provide a significant increase in the quantity of individual instruction delivered by the current level of training effort, has received very little attention.

Speech is first a set of complex, coarticulated motor skills (features, phonemes, syllables, words, prosodics . . .) which are learned to the automatic or overlearned state, and secondly, the usage of these skills, gestures, or sounds in an organized manner dictated by the language. Actually, both the skills (the speech sounds) and the use of the skills (the language) may be learned simultaneously. However, the acquisition of the motor skills remains primary to the process. The principal objective of individual speech instruction is the development of speech motor skills to the overlearned state.

Speech motor skills are learned only through individual instruction. The essential process of acquiring the skill is repeated, individual attempts with feedback. A judgment must be made on each individual attempt, as to its satisfactoriness, and this judgment must be fed back to the speaker to modify the probability of success of the next attempt. The judgment of each trial effort must be carried out by the teacher (the student's substitute auditory process). This judgment requires individual attention by the therapist teacher. There is no way that a teacher can provide phonetic judgments to a group simultaneously. Group speech training is in reality individual speech training taking turns-- a time shared teacher. (This applies only to the teaching of speech motor skills. The language component of speech training may very well be taught in groups.)

The development of a particular skill to the overlearned state is viewed as proceeding through two distinct phases:

1. The instruction phase, during which the trial attempts by the student are consciously directed (and most are unsatisfactory). The teacher critically judges each individual trial effort, estimates the articulatory causes of the sound deficiency, and directs the student to modify his production in the next attempt. This phase requires from the teacher a maximum of expertise, experience, insight, and art. As instruction progresses, the student's production gradually shifts from a consciously directed basis to a more automatic response. The sound is stimulative, i. e. a reasonable proportion of the attempts are satisfactory (five-ten percent). Performance appears to be probabilistic rather than deterministic.

2. The drill phase, in which the probability of successful production can be modified by a simple indication of satisfactoriness, without diagnostic analysis and redirection of the articulatory effort. The drill phase--unlike the instruction phase--draws very little on the expertise of the teacher, and tends to be tedious to both the teacher and the student.

Indications are that the drill component involved in achieving an adequate skill level is considerably larger than the instruction component. Recent studies of instrumental training by Houde<sup>4</sup> and Boothroyd,<sup>1</sup> suggest that the quantity of drill required may be as large as ten times the quantity of instruction. Thus, an instrument that can satisfy economically the requirements of the long and tedious drill phase of speech sound production training offers considerable promise of solving the speech training problem.

#### Other Instrumental Aids

The use of a speech spectrographic display in speech training for the deaf is not new. The "Visible Speech" work begun over thirty years ago at the Bell Telephone Laboratories, and continued at the Detroit Day School for the Deaf, showed considerable promise. (See Potter<sup>14</sup>; Potter, Kopp and Green<sup>15</sup>; Kopp and Kopp<sup>7</sup>; and Kopp, Kopp, and Angelocci<sup>8</sup>.) However, these past attempts at real-time spectrographic displays suffered from very limited resolution in frequency, time, and intensity.

The original Visible Speech Cathode Ray Translator described by Riesz and Schott<sup>17</sup>, which had the best resolution and was the most promising of the group, never progressed beyond the prototype stage, apparently because of its complexity and cost. It is interesting to note, however, that it is still in use by Harriet Green Kopp at the California State University at San Diego.

Other versions, described by Dudley and Gruenz<sup>2</sup> (1946) House, et al<sup>5</sup> (1968); Stark<sup>18</sup> (1971); and Kisner and Weed (1972), sacrificed resolution to reduce complexity. However, none of these displays has come into widespread usage, and the early promise of spectrographic displays has not been fulfilled because of the difficulties in realizing a practical instrument.

Many other speech feedback devices have been developed as aids to speech training for the deaf. These devices cover a wide range of techniques and sophistication and reflect the maturity of speech signal

analysis and displays. Examples of these devices are contained, among others, in the papers of Pronovost<sup>16</sup> and Pickett<sup>13</sup>, given at the 1967 Gallaudet Conference on Speech Analyzing Aids for the Deaf, and in the papers of Levitt<sup>9</sup> and Nickerson and Stevens<sup>12</sup>, presented at the 1972 Boston Conference on Speech Communication and Processing.

Our own motivation for the development of a spectrographic display derived from the need for articulatory information in the speech training of deaf children. Our earlier study of speech training using a parametric display<sup>4,20</sup> of pitch, intensity, nasality, and laryngeal activity emphasized the need for articulatory training as more fundamental than the suprasegmentals. However, the reliable extraction of parameters describing place of articulation (and manner, in the case of voiced fricatives) is very difficult. Doing so, in real-time, and within cost constraints imposed by a desired price range of clinical audio meters, seemed impractical.

The need for a display of articulation is satisfied by a broad-band, sound spectrographic type of display, because it has adequate frequency resolution to display formants and fricatives in speech, and the time resolution is sufficient to display stops and to show vocal fold periodicity during voiced sounds.

#### The Speech Spectrographic Display (SSD)

Our objective was the development of a real-time Speech Spectrographic Display with frequency, time and intensity resolution comparable to that of a conventional sound spectrograph in the broad band mode. Particular attention was paid to the resolution of speech characteristics and the ease of its use: aspects which are important in clinical speech training.

A picture of the prototype SSD is shown in Figure 1. The Display device shown is a conventional, large screen video monitor. The console on the left contains the analyzer circuitry and the controls. The two controls on the right-hand side of the console control the background grey level and the blackness of the speech patterns. Two toggle switches in the center of the panel provide control of the time scale of the full screen display and the bandwidth of the analyzing filters. The two pushbuttons in the center of the control panel provide for recording on the screen and for erasing the screen. At the left are microphone and auxiliary input jacks, an input level control, and an

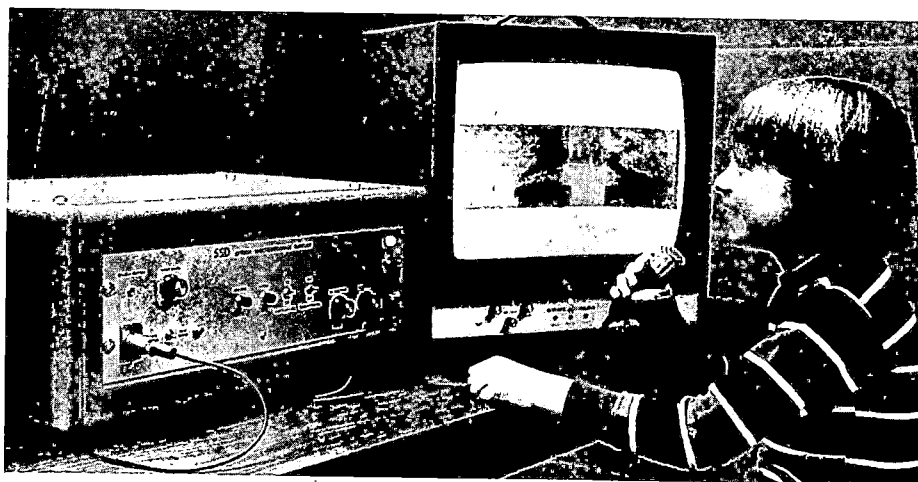

Figure 1. The Speech Spectrographic Display (SSD).

output jack for feeding headphones or an auditory trainer.

The SSD prototype displays a frequency range from approximately 100-5000 Hz, logarithmically scaled to give a more similar display between men, women, and children. Resolution of speech characteristics is achieved in the analyzer by means of a single-filter frequency-multiplication technique. The frequency scale has a resolution of 85 lines on a logarithmic scale. At the low end of the scale, lines are spaced at about 38 Hz intervals, while at the high frequency end the spacing is about 76 Hz. Two switch-selectable analyzing filters are provided in the prototype SSD, 450 Hz and 600 Hz. Thus, there is great overlap of the filters. This overlap serves to decrease the influence of individual pitch harmonics on the display. This contributes to the definition of formants, as is the case with the conventional broad-band sound spectrograph display. The filter selectivity is Butterworth 4-pole low-pass prototype.

Two switch-selectable time scales, 0.75 seconds and 1.5 seconds, are provided for the full screen display. Time resolution is limited mainly by the video display. The best resolution occurs on the 0.75 second scale and is about 2-3 milliseconds. This is adequate to resolve individual vocal fold periods for all male and some female voices.

Intensity is displayed using the grey scale of the video monitor. Greater than 30 dB of dynamic range can be displayed by means of a logarithmic compression circuit. Use of compression circuitry to match the dynamic range of speech to that of the grey scale range of the monitor is perhaps the most fundamental difference between the display of the SSD and the conventional sound spectrograph, which uses an AGC. This preserves changes in amplitude over time which is important in glides and liquids, for example. An example of this is seen in the photograph of the SSD's video monitor output of the word 'wearily', shown in Figure 1.

The complete acoustic representation of the speech signal, as shown in the figures, is displayed on the screen in real-time, by pressing the Record Button and speaking into the microphone. The output appears on the screen, from left to right, as the speech occurs in time. The picture can be viewed and analyzed for many minutes before the image deteriorates noticeably. The Record Button may be released after a brief utterance, and the analysis and recording cease; if desired, analysis and display of another utterance can proceed, until the screen is filled, by depressing the Record Button. The picture can be erased by pressing the Erase Button, and the system is then ready for display of another utterance.

Broken black lines appear along the bottom of the speech spectrograms. This line is used as an intensity overload indicator. A broken line is analogous to a VU meter needle peaking in the red area. A solid line throughout an utterance corresponds to a VU meter being 'pegged' and warns of possible spectral distortion.

Other examples of articulatory features shown by display are seen in Figures 3 and 4. In Figure 3, vocal fold periodicity is evident throughout the /z/ portion of the words 'Sue-zoo', clearly indicating the manner of articulation of this voiced fricative. Differing formant transitions for /b/, /d/, and /t/ are shown in Figure 4 for the words 'bay'-'day'-'take'.

## Implications for Speech Training for the Deaf

There are several characteristics which recommend the broadband spectrogram of speech to the task of speech training for the deaf. The spectrogram is a rather complete substitutory display of speech. Thirty years of research has failed to develop an alternate representation which better preserves the identity of those aspects of the speech signal which are distinctive to the auditory sense.

One objection sometimes raised to the use of spectrographic displays is that a spectrogram presents too much information, and simplification by parametric representations, such as formants, is suggested. This simplification, however, usually involves abstraction from the acoustic signal which is more reliably performed by human perception than by electronic signal processing. On this matter, we ascribe to the view presented by White, et al: <sup>21</sup>

"The perceptual systems of living organisms are the most remarkable information-reduction machines known...not seriously embarrassed where an enormous proportion of the input must be ignored, but invariably handicapped when the input is drastically curtailed."

Serious questions concerning the readability of spectrograms were raised by Liberman, et al, <sup>10</sup> and Goldberg <sup>3</sup>. These authors argue that the decoding of continuous speech is an ability which is specialized to the auditory sense alone. This note of caution, however, does not apply directly to the case of speech training, where the objective is not continuous decoding of speech, but is rather the display of the auditorily distinctive aspects of speech to provide feedback to reinforce, or to inhibit, the causal articulatory activities.

The acoustic spectrogram is in a sense more relevant to speech training than is the articulatory representation, since it represents the information in a mode (acoustic-auditory) within which adequacy of performance is to be judged.

The Speech Spectrographic Display (SSD) is expected to serve speech training in two ways,

1. As an aid to the teacher in diagnosing the speech deficiencies of a student, and in describing the training objectives.
2. As an independent drill facility in those cases where the student has developed the ability to distinguish satisfactory and unsatisfactory productions and has sufficient attention span to work without the teacher's continuous attention.

It is in this latter mode that the SSD is expected to significantly affect the delivery of speech training services for the deaf.

## Evaluation

Two preliminary evaluation studies have been carried out. In one, a single adult male deaf student was provided with three training sessions over a one week period. The initial session consisted principally of recording reference utterances, explaining the equipment and the experiment, and analyzing utterances to identify a suitable training objective. The objective selected was the production of a satisfactory front vowel. The student achieved the ability to monitor and evaluate his own production, and carried out approxi-

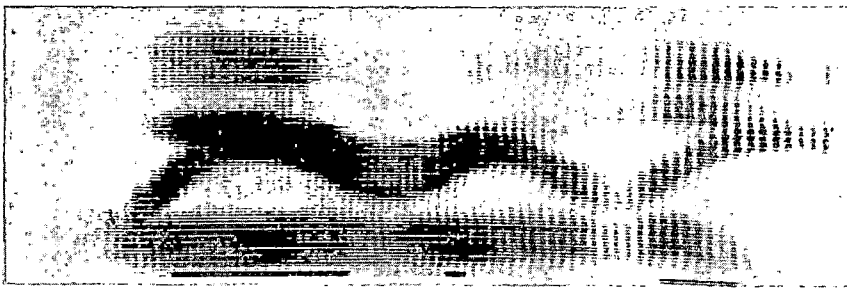

Figure 2. Photograph of the SSD monitor screen for the word 'wearily'.

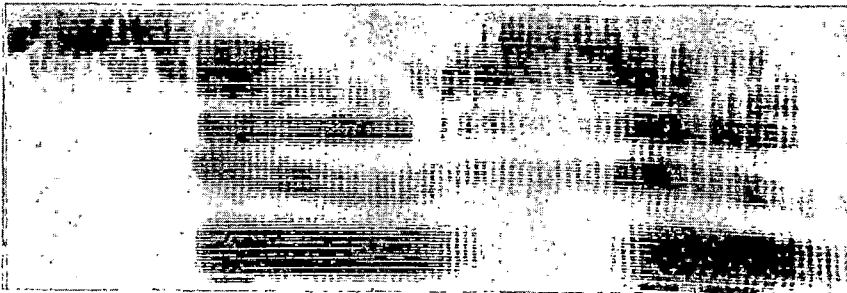

Figure 3. Photograph of the SSD monitor screen for the words 'sue-zoo'.

mately 15 minutes of drill during the first training session. The drill consisted of repeated attempts at the production of one-syllable words using the front vowels /i/ or /I/. The student received approximately one-half hour of similar drill during each of the following two sessions. Through the three drill periods, the teacher progressively withdrew from the training situation so that by the end of the second session the student was drilling independently for intervals of ten minutes duration. The results of the drill was an improvement from one successful production in twenty attempts at the beginning of training to more than half at the end of the third session.

The aspects of this experiment which are particularly noteworthy are

1. the student readily acquired the ability to interpret the display and compare the target utterances (teacher generated) to his own, and
2. the student was comfortable in functioning relatively independently. Similar success in independent work with a computer-based display was recently reported by Arthur Boothroyd, and we are encouraged to expect that independent drill will be possible.

Experiments are now being developed to ascertain if younger students can also interpret the display and drill independently.

Another study currently in progress at the National Institute for the Deaf is exploring the effectiveness of the display as a direct aid to the therapist in the instructional phase of training. This study does not involve independent drill. At the end of the first phase of training (three hours) the students were polled for their view and receptiveness in training with the spectrographic display. All reported a clear preference for the SSD. The reason given by one student

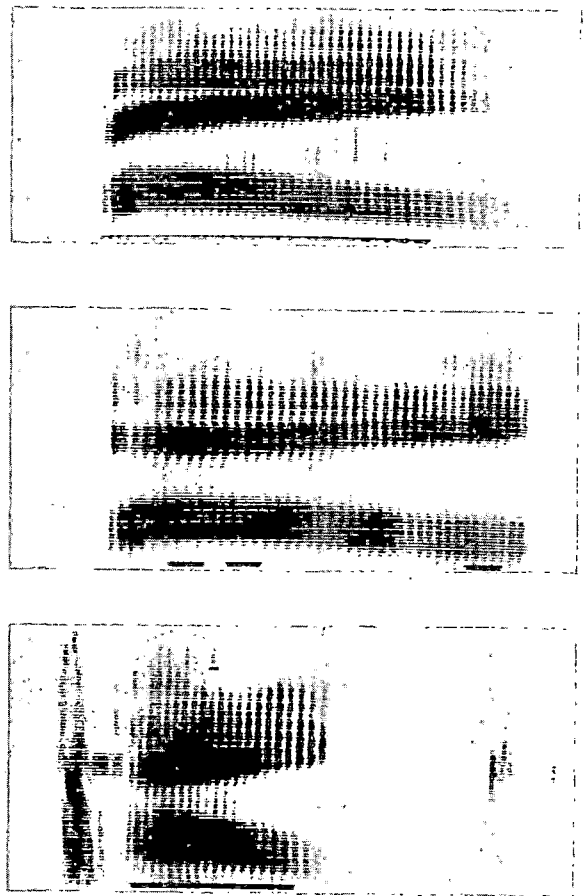

Figure 4. Photographs of the SSD monitor screen for the words 'bay', 'day', and 'take'.

seems worthy of note--he said he preferred the instrument because he could trust it to tell him the truth at first hand, as opposed to second-hand reports from the therapist.

### Conclusions

These results suggest that the Speech Spectrographic Display (SSD) has considerable potential for training speech production with the deaf. Research is now required to establish its applicability to the whole range of speech, and to develop the procedures necessary to carry its utility to the classroom and the clinic.

### References

1. A. Boothroyd, et al, "Temporal Patterns in the Speech of the Deaf - An Experiment in Remedial Training," S. A. R. P. No. 15, September, 1974. Clarke School for the Deaf.
2. H. Dudley, O. O. Gruenz, Jr., "Visible Speech Translators with External Phosphors," JASA, July, 1946, 14, No. 1, pp. 62-73.
3. A. J. Goldberg, "A Visible Feature Indicator for the Severely Hard of Hearing," I. E. E. Transactions on Audio and Electroacoustics, 1972, AU-20, pp. 16-23.
4. R. A. Houde, "The Role of Speech Display Instruments in Speech Training for the Deaf", paper presented at the 1974 ASHA Meetings, November, 1974.
5. A. S. House, D. P. Goldstein, G. W. Hughes, "Perception of Visual Transforms of Speech Stimuli; Learning Simple Syllables," Amer. Ann. Deaf, 1968, 113, pp. 215-221,
6. J. L. Kisner, H. R. Weed, "The Design of the Visual Vocoder," Conf. Record 1972 Conference on Sp. Communication and Processing, April 1972, Air Force Systems Command, L. G. Hanscomb Field, Bedford, Mass.
7. G. Kopp, H. Kopp, "Visible Speech Manual, Final Report, Vocational Rehabilitation Agency (SRS), Grant RD-526, 1963.
8. G. Kopp, H. Kopp, A. Angelocci, "Visible Speech Manual, Wayne State University Press, Detroit, 1967.
9. H. Levitt, "Speech Processing Aids for the Deaf: An Overview" IEEE Trans. on Audio and Electroacoustics, 1973, AU-21, pp. 269-273.
10. A. M. Liberman, F. S. Cooper, D. P. Shankweiler, and M. Studdert-Kennedy, "Why are Spectrograms Hard to Read?" American Annals of the Deaf, 1968, 113, pp. 127-133.
11. Jean E. Maki, "The Speech Spectrographic Display: A Preliminary Investigation," Paper presented at the New York State Speech and Hearing Association Meetings, April 1976.
12. R. A. Nickerson, K. N. Stevens, "Teaching Speech to the Deaf; Can a Computer Help?" Proc. Nat. Conv. ACM, 1972, pp. 240-250.
13. J. M. Pickett, Ed., "Proc. Conf. on Speech Analyzing Aids for the Deaf," Amer. Ann. Deaf, 1968, 113, pp. 116-330.
14. R. K. Potter, "Visible Patterns of Sound," Science, 102, p. 463 (1945).
15. R. K. Patter, G. Kopp, H. Green, Visible Speech Van Nostrand, New York 1947.
16. W. Pronovost, "Developments in Visual Displays of Speech Information," The Volta Review, June, 1967, pp. 365-373.
17. R. R. Riesz, L. Schott, "Visible Speech Cathode Ray Translator," JASA, July, 1946, 18, No. 1, pp. 50-61.
18. J. D. Schein, M. T. Delk, The Deaf Population of the United States, National Assoc. of the Deaf, Silver Spring, Md. 20910
19. R. E. Stark, "The Use of Real-time Visual Displays of Speech in the Training of a Profoundly Deaf, Nonspeaking Child: A Case Report," JSHD, August, 1971, 36, No. 3, pp. 397-409.
20. L. C. Stewart, R. A. Houde, W. D. Larkin, "The VSTA: An Approach to the Speech Training Problem," Conf. Record of 1973 Carnahan Conference on Electronic Prosthetics, Lexington, Ky. pp. 10-14. (also, in press, Sensory Aids for the Hearing Impaired, IEEE Press, New York ).
21. B. W. White, F. A. Saunders, L. Scadden, P. Bach-y-Rita, and C. C. Collins, "Seeing with the Skin", Perception and Psychophysics , 1970, 7, p. 27.

## AUDITORY AID TO DEAF SPEAKERS IN MONITORING FUNDAMENTAL VOICE FREQUENCIES

Edgar Villochur  
Foundation for Hearing Aid Research\*, Woodstock, New York 12498

Mead C. Killion  
Industrial Research Products, Inc., a Knowles Co.\*, Elk Grove Village, Ill. 60007

A wearable auditory pitch-monitor device is described, for use by the deaf who have some residual hearing but who cannot distinguish voice pitch and must be trained in pitch control. Fundamental voice frequencies are transposed to low-frequency square waves that modulate the speech. The deaf person does not have to integrate signals from his visual or tactile sense into his perception of pitch.

### Introduction -- The Problem

The speech of those who have been profoundly deaf from infancy is sometimes close to unintelligible to inexperienced listeners. Assuming that the deaf person has a normal vocal mechanism, this poor speech quality results from the inability of the speaker to monitor his own voice properly. Even with sufficient amplification, his perceptive distortions prevent him from hearing his own mistakes.

One of the most damaging of these perceptive distortions is the reduction or loss of frequency-discriminating ability. This impairment, in addition to blurring or erasing speech-formant cues, prevents the deaf person from learning to speak with the normal inflections of fundamental voice frequencies. The pitch of his voice may vary, sometimes to an exaggerated degree, but the variations are typically associated with the ways in which he forms particular speech sounds rather than with the conventions of language.

This is the recording of the voice of a profoundly deaf teen-age girl. She has had speech therapy, and I would judge that she has above-average intelligence. She is reading the following sentences, which are from a standard IEEE speech test: "The long journey home took a year," and "She saw a cat in the neighbor's house."

While the improper pitch intonation of this speaker is certainly not her only defect, nor even the most important one, there would be a considerable improvement in the intelligibility of her speech if she could control her voice pitch to conform to the intonation of frequencies that we expect. Intonation contributes to meaning. This girl's family understands her speech fairly easily: One of the things that they have learned to do is to ignore the false leads provided by her incorrect use of pitch.

### 1. Previous Devices

Visual and tactile devices have been designed to enable the deaf speaker to monitor the pitch of his own voice, and thereby to control it. Boothroyd (1973) reported that deaf students learned to control voice pitch while using a visual-monitor device, but that the effectiveness of the device was limited -- especially for those in the test group with the most severe deafness -- by the difficulty of teaching abstract rules of language intonation, and by the problem of carry-over to speech unaided by the frequency display. He also reported that the traditional technique of correction by an instructor was almost as effective as the visual-instrument technique.

The difficulties encountered by Boothroyd might be overcome if a frequency-indicating device were incorporated into a wearable hearing aid, making it possible for the deaf person to perceive the indices of voice pitch in everyday communication. Upton (1968) has developed an experimental visual-display unit that is attached to a pair of eyeglasses, but the features that it extracts from speech do not include the fundamental frequency of the voice. Willemain and Lee (1972) designed a tactile pitch-detector system that they describe as potentially applicable to a wearable device.

### 2. The Present Device

This paper describes an auditory pitch-detection device that has been built, first as a bench model and then as a wearable hearing aid, for use by the deaf who have some residual hearing but who cannot distinguish voice pitch. The device transposes fundamental voice-frequency differences to differences in pulsation rates. The speech signal is subjected to amplitude modulation by a square wave whose fundamental frequency, usually in the range between 8 Hz and 20 Hz, is proportional to the fundamental frequency of the voice: It tracks voice-pitch changes. The effect is something like that of rolling an "r". The listener needs the ability

to distinguish between different rates of pulsation, but not between different voice frequencies, in order to monitor voice-pitch variations.

With this device the deaf listener does not have to integrate signals from more than one sense into his perception of speech. It is not a self-evident proposition that auditory pitch cues, even when transformed, will have an advantage over non-auditory cues, but it is a reasonable hypothesis.

A block diagram of the original bench-model processor is shown in Slide 1. My co-author Mead Killion is primarily responsible for the actual circuit design, including a proprietary design used in the pitch extractor. The bench-model processor, which is only wearable if the subject travels with a wheelbarrow, was built by Daniel Queen Associates.

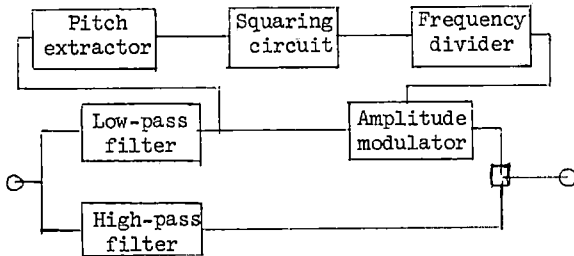

The low-frequency band of speech is processed by the pitch extractor to produce a sine-wave signal at the momentary fundamental voice frequency. This signal is converted to a square wave and sent through a frequency divider, whose output is then used to amplitude-modulate the low-frequency band of the original voice signal. After modulation the low-frequency speech band is recombined with the high-frequency band:

The fundamental frequency of a single speaking voice usually varies over a range of about an octave. The total range of fundamental voice frequencies likely to appear at the input to the processor, including the variation in the average pitch of different speakers, is about 75 Hz to 450 Hz. A control is provided to adjust the frequency-dividing factor for voices of different average pitch, so that the modulating square waves will remain in the 8 Hz to 20 Hz range.

The later, wearable model is simplified: The entire speech band is modulated, but the subject can control the percent of modulation. The unit is meant to be used in one ear only, while the other ear receives an unmodulated signal.

Here is the same recording of the deaf girl's speech, processed by the bench model.

### 3. Initial Test Results

Someone described the processed sound as having a "bubbling" quality, and so the device has been nicknamed a "burbler". I have tried the device with only one deaf subject -- the teenager whose voice you have heard. After two hour-long sessions with the bench model, the following results can be reported:

- 1) In a very short time the subject was able to recognize the indices of the pitch of her own voice. She would pronounce a two-syllable word and turn to me and tell me whether her voice pitch had remained the same, had changed in the right direction, or had changed in the wrong direction. She was even able to tell me if the change had been in the right direction but was not great enough.
- 2) It was one thing to be able to monitor pitch differences, and quite another to learn to control pitch. The problem is like that of learning to wiggle your ears: Even after you are presented with a mirror, you have to learn how to contract the proper muscles. The large amount of training required in learning to control voice pitch has often been reported, and this electronic instrument was no panacea that would eliminate the need for training. We hoped, however, that a device that the subject could wear and use constantly would allow a closer relationship between speech-therapy sessions and everyday communication. I therefore suspended the work until such time as a wearable "burbler" would be available. The wearable model has now been completed, thanks to Mead Killion, and initial testing has just begun.

This device is not meant to replace the speech therapist, but to make it easier for the deaf person to continue to work on pitch control outside of the clinic. If the ability of the burbler to provide voice-pitch feedback turns out to be neither greater nor less than that of previous devices, it will have served its main purpose, because the subject can take this device home with him. Houde and Johnson (1976) have written:

The 'problem' of speech training for the prelingually deaf is that the quantity of formal individual training required to achieve functional speech is greater than that which can be provided within the resources allocated by society.

This device represents an attempt to alleviate part of that problem, by bridging the intervals between speech-therapy sessions.

\*\*\*

The term "voice pitch" is commonly used, as here, to refer to fundamental voice frequency, although the American National Standards Institute defines pitch as an attribute of sensation.

\*The only relationship between the Foundation for Hearing Aid Research and Industrial Research Products is that of voluntary scientific cooperation.

### References

Boothroyd, A. (1973). "Some Experiments on the Control of Voice in the Profoundly Deaf Using a Pitch Extractor and Storage Oscilloscope Display". IEEE Trans. on Audio and Electroacoustics, 274-278. June, 1973.

Houde, R.A. and Johnson, D.D. (1976). "New Directions in Sensory Aids Research for Speech

Training". Corti's Organ N. 1, p. 7. (A)

Upton, H.W. (1968). "Wearable Eyeglass Speech-reading Aid". Amer. Ann. Deaf, 222-229. V. 113 No. 2, March 1968.

Willemain, T.R. and Lee, F.F. (1972). "Tactile Pitch Displays for the Deaf". IEEE Trans. on Audio and Electroacoustics, 9-16. March 1972.

## A NEW APPROACH TO AURAL PROSTHETICS

by

Sylvan J. Hotch  
Wayland, Massachusetts

It is now technically possible to produce a device which will present a real time visual analog of speech. Such a device might be used to alleviate the social and learning problems of the congenitally deaf child. Prior to the initiation of any experimental program, questions of acceptability and feasibility must be answered.

The writer is seeking support for organization of an initial program to evaluate the concepts described.

### Introduction

Loss or congenital absence of hearing presents a unique disability, since the major result of deafness is psychosocial rather than physical dysfunction. We interact with inanimate things with all our senses equally, but we communicate with people primarily with our ears. As deafness increases, social communication becomes increasingly difficult until finally, in the total absence of hearing, information exchange becomes possible only as the result of continuing and directed effort by both the communicator and the communicant. Most cruelly, as deafness becomes more profound, less can be gained from existing hearing aids, and the deafening individual begins to lose contact with his own body by the loss of essential aural feedback. As this occurs, he feels himself increasingly rejected by his society, and indeed he may be. Humans are noisy animals. We grunt and burp and groan and shuffle. Our activities are equally noisy. When we read, we rattle paper; when we walk, we stamp. Since we are always aware of the sounds we are making, we are able to suppress them. The deaf are not aware and, as a result, soon find themselves socially rejected. Also, most warnings of direct personal danger arrive through the ears. The deaf individual is continually forced to be aware of potential danger; hence, he becomes suspicious and adopts maneuvers often confused with paranoia. Finally, his sense of privacy is continually violated since, to obtain his attention, he must continually be touched. In summary, it is only by continual effort that the deaf individual is not completely desocialized. More difficult still is the task of the deaf child.

### The Deaf Child

Until 75 years ago it was thought that the congenitally deaf were also mentally incapacitated. As a result, efforts to rehabilitate the deaf had been left to the church, which undertook to teach the deaf to pray. In recent years we have accepted that speech is needed for neither prayer nor communication. In fact, we recognize that sign language has become the normal communication media of the deaf and that aural speech is not required at all. Such logic has proven most helpful in educating the deaf child but has not greatly contributed to his socialization.

Speech is the sine qua non of human behavior.

Learning to speak is synonymous with learning to be a member of the human family or society. Whether one accepts the cognitive psycholinguistic theory or the SR theory of speech development, the importance of aural feedback in speech development cannot be disputed. The child continually hears sound around him and soon realizes that he, too, can make noise. Out of curiosity perhaps, or enjoyment, he makes these sounds until he can do so at will. He soon realizes that certain sounds bring pleasant responses from others -- a touch, the sight of his caretaker, etc. Slowly the child begins to form a total communication pattern and learns to speak. The congenitally deaf child is denied all such opportunity due to the absence of appropriate feedback; he never learns to communicate in a natural manner.

### Hearing Aids

The use of mechanical devices to augment impaired hearing probably dates back to the first man who cupped his hand over his ear. Later, all sorts of ear trumpets and other devices were developed which, though interesting and sometimes artistic, were not very effective. The first meaningful improvement arrived with the invention of the electronic amplifier. One of the earliest uses of the "audion" was as a hearing aid. Equipped with microphone, headphones, and A and B batteries and tied to one location, the partially deaf were still sufficiently appreciative of the new world opened to them by electronic amplification that such devices essentially "sold like hotcakes". The first such hearing aid was built around 1911. Since then, aids have become smaller and less noisy, but generally there have been few basic improvements of recognized value during the intervening years; and hearing aids have never developed into aural prosthetics.

### Aural Prostheses

It should not be imagined that no attempts have been made to develop an aural prosthesis. In fact, several devices have been built and tested which try to use other senses to replace hearing. Equipment has been built which delivers mild electric shock to various parts of the body<sup>1</sup>, and mechanical vibrators have been used to stimulate tactile areas to produce sensory feedback.<sup>2</sup>

Most interesting in terms of the work proposed in this paper was the experience of

Mr. Hubert W. Upton with a device of his own design. In 1968, with the invention of the sub-miniature incandescent light, Hubert W. Upton, an engineer who was congenitally near-deaf, attached several sub-miniature lamps to the rims of his eyeglasses. These lamps were connected to the output of a modified version of his hearing aid and flashed in response to nearby voices. Mr. Upton claims<sup>3</sup> that the use of this device vastly improved his social adaptability and his capability to function in a world of hearing people. He found that he was able to understand many words by the flashes alone. Perhaps most significant, he was able to direct his attention to sounds which occurred behind his back and became able to suppress his own body sounds, since he was now conscious of them. With lip reading, at which he was quite proficient, he could communicate in a much more efficient manner than before, since he no longer was dependent on non-audible cues to direct his attention.

But even this device had very limited practical value since the vocabulary achievable by the totally deaf seemed to be very limited indeed.

### The Physics of Sound Communication

Understanding of the following material requires some knowledge of rudimentary sound theory. Since none has been assumed of the reader, the following brief discussion of the physics of sound is offered.

Sound is perceived when air pressure is caused to vary periodically at a rate between approximately 20 and 15,000 times each second. If air pressure variations are great, we perceive the sound as loud, and conversely. If the vibration is smooth and proceeds sinusoidally the tone is said to be pure. For example, if something caused the air in an enclosed area to vibrate smoothly 440 times each second, the pure tone "A" would be heard. When groups of individual pure tones are examined, some will be seen to be harmonically related. Harmonically related tones are those whose frequencies stand in exactly even multiples. For example, a tone of 800 Hertz (Hz) or cycles per second is the fourth harmonic of one at 200 Hz and is also the second harmonic of one at 400 Hz, etc.

In communication theory, intelligence\* is conveyed by creating variations in frequency (pitch), intensity and the duration of specific combinations of these. Emotional impact is carried by sound quality, or timbre. Hence a violin, which produces nearly sinusoidal pressure variations sounds entirely different from a trumpet, which produces a triangular pressure variation. The characteristic shape of the pressure variations are all determined by the complex addition of a series of harmonically related pure tones. The tone of the violin is a single sinusoidal vibration, while the trumpet simultaneously produces a series of harmonically related sine waves which, when added together, produce its characteristic triangular wave.

In summary, sound is perceived when air pressure changes periodically between 20 and 15,000 times each second. The rapidity of the

\* Intelligence is used here in its technical sense and is in no way related to psychometrics (IQ).

change is called the frequency and is measured in Hertz (Hz). Differences in frequency are sensed as differences in pitch. The amount of pressure change, or amplitude, is sensed as loudness. The characteristic shape of the change, determined by the presence or absence of harmonically related tones occurring simultaneously, is sensed as timbre, or sound quality.

Figure 1 is a geometric representation of sound structure as a three dimensional plot of the total air vibrational energy available at some location, at any time. Each plane shown in the x-z field represents the geometric sum of all vibrational energy present at any instant.

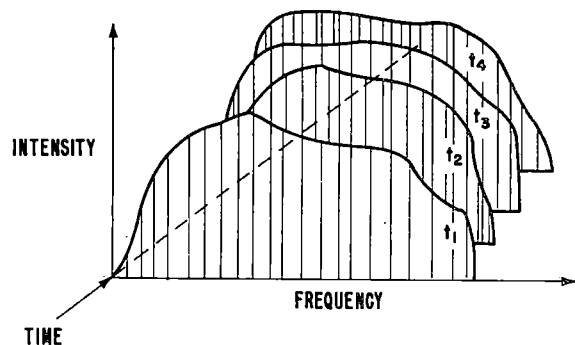

Figure 1  
Geometric Representation of Sound Structure

The extraction of intelligence from sound seems to involve both physical and psychological processes and is much more complicated than immediately apparent. When all the sounds present at any location, at any time, are recorded and visually displayed on an oscilloscope, the resulting pattern is visually undecipherable. Background interference competing for the observer's attention, as well as interference from other conversation taking place at the same time, have consistently defeated any simple mechanical approach to reducing displayed patterns to intelligence. With little reflection, it becomes obvious that some pattern recognition procedure is at work by which harmonically related sounds are separated and distinguished from non-related sounds. Also, it seems that competing sounds are suppressed so that intelligence can be recorded under the most adverse conditions. Casual observation of animals and their distractibility leads this writer to believe that this capability of instantaneous pattern recognition is as distinctively human as speech itself.

### Acceptance Bandwidth

It became clear that before any progress could be made in the design of a replacement prosthesis some method of evaluation and prediction had to be developed. The concept of acceptance bandwidth developed by the writer seems to fit this need.

The relative importance of any single sensual stimuli in the perception of intelligence

is extremely difficult to quantify; however, a statistically untested but still interesting relation between perception and stimuli was noted by the writer and his associates while attempting to equate measured performance with the usefulness of specific hearing aids designed for the profoundly deaf. The characteristic has been named Acceptance Bandwidth and is expressed in dB above unity. The unit is derived by adding, logarithmically, the sensual extent of each stimuli. For example: A normal person can sense sound levels between  $10^{-10}$  microwatts/cm<sup>2</sup> to 1000 microwatts/cm<sup>2</sup>, or 130 dB. He can also recognize sound frequencies from approximately 15 to 15,000 Hz, or 30 dB; hence, the Acceptance Bandwidth of normal hearing is said to be about 160 dB. The extension of the concept to the visual was attempted by the writer when he consulted in electroretinography at the Massachusetts Eye and Ear Infirmary. Attempts to apply this concept to visual stimuli were disappointing but still useful in quantifying the amount of vision left to those patients who were nearly blind. Despite the limitations and imprecision of the tool, it still seems to be useful in evaluating the amount of sensual stimuli which can be made available by a mechanical device and the amount which can be accepted by the remaining sensory equipment of a particular individual. When the concept is used to predict the usefulness of the proposed methods of implementing an aural prosthetic, several interesting results are obtained. For example, the tactile to sound analog concept described above, when calculated, is found to have an acceptance bandwidth of about 5 dB. Mr. Upton's hearing glasses have approximately the same acceptance bandwidth, a figure which seems much too low for the communication of more than the most rudimentary intelligence. Several calculations have been made of various communication devices to form a standard of comparison. These are listed in Table I.

TABLE I

<u>Device</u>	<u>Calculation Acceptance Bandwidth</u>
Total Human Aural Response	160 dB
Total Human Visual Response	80 dB
Total Human Tactile Response	8 dB
Model 500 Telephone Handset (New England)	40 dB
Hearing Glasses (Upton)	5 dB
* Ear Trumpet	25 dB
* Hearing Aid	75 dB
Required for Minimum Aural Communication	20 dB

\* The assumption here is that the amplification of these devices is sufficient that it alone determines what is heard.

Clearly, any successful aural prosthetic must have sufficient acceptance bandwidth to convey meaningful intelligence, though for the profoundly deaf even a small increment is meaningful, for example, Mr. Upton's invention.

#### Visible Speech

During the second world war the need to identify a speaker's voice with certainty led to the development of the voice print machine now being used by telephone companies to identify nuisance callers. Shortly after its development,

a series of experiments were conducted by Potter, Kopp and Kopp<sup>4</sup> which have directly contributed to the ideas and designs presented here.

Using the Voice Print Machine, Potter, Kopp and Kopp built and evaluated a rudimentary aural prosthetic and conducted early experiments in training a deaf subject in its use. The device they evaluated used a bank of filters to divide the spoken voice into a series of frequency bands. The bands were then recorded side by side on thermal-sensitive paper tape. The tape was moved at approximately one inch per second and viewed in motion, so that the information recorded was consistently representative of the words and phrases used. According to Potter, Kopp and Kopp, the most useful speech analogs were obtained when speech sounds between 500 and 3500 Hz were divided into eight equal segments, each 300 Hz wide.

Most interesting in the context of this paper is Chapter 4 of Visible Speech, where a training program is described during which a class of both deaf and non-deaf subjects was established. Attempts were made to train these people to read, or better yet, to understand the recordings in lieu of audible speech. After 220 hours of training, a congenitally deaf engineer was consistently able to recognize 800 words. From the data collected, it is to be anticipated that the learning rate would have been maintained at a continual level until at least double the end point indicated was reached.

The disadvantages of the device, however, were numerous. The equipment occupied several cubic feet in volume and weighed many pounds. The display was not attention-getting, and the general visibility was poor. To use this device, the deaf person had to concentrate on what he was "hearing", and it was never possible to separate two competing voices. However, a basic premise seems to have been proven by this experiment. A person, even a deaf person, could be trained to interpret voice-derived visual stimuli as language. In 1967, work on this aspect of the voice print machine was discontinued, and the writer has found no evidence that additional effort has since been expended on visible speech as a teaching device for the deaf.

#### Improved Visual Speech

Modern technology has made feasible a sound visualizer system much different from the visible speech devices just described. It would combine the techniques developed in the building of a voice-print machine and the experience gained by Mr. Upton in his use of his "hearing glasses".

The maintenance of repeatability and stability are the major problems to be overcome in creating a useful sound/sight analogue. Until recently all attempts have made use of linear devices -- that is, devices which linearly convert sound pressure into electrical impulses and then into perceptive stimuli. The impreciseness inherent in such devices seemed to be the ultimate limitation. Recent advances in microprocessors have made it possible to digitally analyze sound structure and produce a reliable, repeatable, electrical analogue of sound which can be used to stimulate alternate sensory reception. Using these techniques, it is now possible to build a sound/sight exchange device in a package small

enough to be incorporated into a pair of eyeglasses as shown in Figure 2. So equipped, a deaf individual would be presented with a continual flow of visual sound. What remains to be evaluated is if one can be trained to translate these signals into a continual flow of intelligence.

## The Uses of Visual Speech

If a visual speech device were built, the obvious thought is that one could equip deaf persons with it and let them hear by way of their eyes. Such initial experiments could, of course, be attempted, but in the opinion of this writer, it is highly doubtful that any such program would meet with much success. Work with feral children seems to indicate that, if speech is not learned within a specific period of childhood, it will never be learned. It is probable that the pattern recognition skills described previously cannot be learned late in life. Hence, it seems entirely possible that a deaf person, even a child, could not use the amount of information which would be introduced. In fact, many unexpected adaptive problems might develop. A simple device such as Mr. Upton's "Hearing Glasses", or one of the tactile sensors, would probably present all the additional information an adult could be expected to handle, but certainly one of the most exciting aspects of the concept of speech visualization is the possibility that a profoundly deaf child might develop useful speech patterns if exposed to a visualizer at an early age.

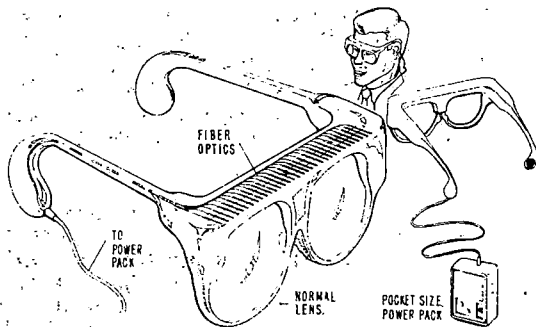

Figure 2  
Aural Prosthetic Incorporated Into Eyeglasses

In the proposed visualizer, harmonic sum intensity (loudness) will be recorded as sum color intensity; frequency is recorded as hue and structural change as color change. From Figure 3, the visualizer operates in the following manner. Sound is received from a microphone and is analyzed and coded by the sensor. It is then divided into eight bands according to frequency. Each frequency band is assigned a primary or secondary color, and the intensity of that color is varied in accordance with the instantaneous amplitude within that band. The colors are then combined by sampling them electrically at about forty times each second. Thus, the color and intensity of the display changes approximately every 4 milliseconds. Because of the brain's capability to sum visual information changing too fast to be followed, discrete hues and intensities will be sensed corresponding to the particular sound state existing at any time.

Let us assume that at the earliest possible moment after a child is recognized as being completely and congenitally deaf, s/he is placed in a nursery equipped with a sound visualizer activated from microphones strategically located around the room as shown in Figure 4. The design will be such that the child can see the display from a large acceptance angle and recognize visual activity even in the absence of direct visual attention. This child then has the visual equivalent of all aural stimulation. When s/he makes sounds, s/he sees flashing colored light; will the child now begin to play with his voice? A parent enters the room and speaks; the lights flash in a repeatable color-brightness pattern; will s/he try to duplicate this pattern? In other words will the brain, in the absence of normal aural input, accept and use a visual substitute? It is to seek answers to this and other related questions that the work to be described in the balance of this paper is proposed.

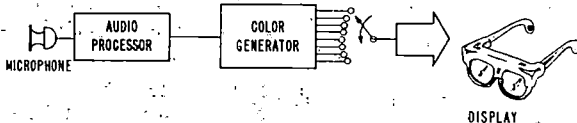

Figure 3  
Sight/Sound Exchange Block Diagram

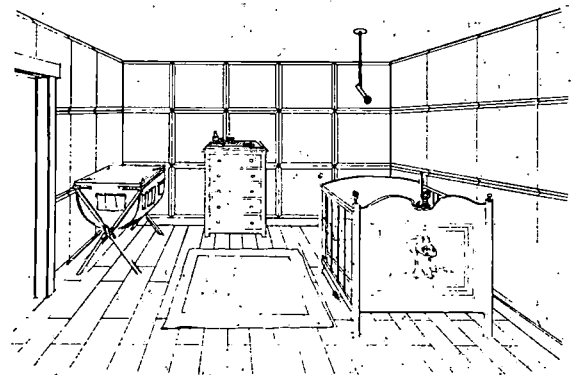

Figure 4  
Aural Prosthetic Evaluation Setting

Before describing an experimental program, it may be worthwhile to digress to consider

several immediately apparent objections and questions.

Considering each in turn:

What are the possible psychological effects on the development of a child so "treated"?

Brown and Hopkins<sup>5</sup> have done several studies and recorded their observations of the long range psychological and physical effect of continual visual stimuli. The results reported, though far from conclusive, are encouraging, since no adverse long-lasting effects have been noted.

Wouldn't the flashing light interfere with normal vision?

The presence of the lights should not interfere with normal vision any more than would the presence of a phonograph or radio interfere with normal hearing. If the experiment is successful, the subject should be able to learn to use visual stimuli in much the same manner as a person with normal hearing uses his ears and should be able to separate voices and suppress unwanted sounds. The average intensity of the light would probably have to be varied with the ambient light, but this constitutes a small problem.

Is the Acceptance Bandwidth wide enough to admit useful information?

The calculation of Acceptance Bandwidth for such a system is difficult, since the response of the eye to color and color changes is not completely understood. Also, the range of illumination and available hue depends upon the device chosen. However, if we assume that the device to be used will be no worse than a three color cathode ray tube, the Acceptance Bandwidth should be about 30 dB. As a means of comparison, it should be remembered that the telephone handset used in conjunction with New England Telephone Company lines has an Acceptance Bandwidth of about 40 dB.

Why not use touch, by way of electric shock or tactile stimulation, instead of light?

There are several unsigned reports (previously noted) of limited progress with tactile sound analog equipment. However, the Acceptance Bandwidth of such devices is limited by the narrow amplitude and frequency response range of the tactile sense.

Why not use pattern and location in addition to intensity and color, thus increasing the available Acceptance Bandwidth?

It cannot be denied that more information could be made available by patterns of light and/or movement of light within the field of view. However, the simple intensity/color analog seems to have sufficient Acceptance Bandwidth for voice communication. The additional complication which would be necessary to implement a more complex system does not seem warranted.

#### The Experimental Program

Approximately five years have been spent by

the writer in part-time exploration of problems of the deaf. However, although the concept of visual speech appeared quite early, it is only within the last year that the physical arts and sciences have produced equipment e.g., microprocessors and high intensity light sources, which makes an experimental system viable. It can be built, but will it work? The answer to this question will have to be determined by experiment.

The writer's purpose in exposing the work done so far, inconclusive though it is, is to attempt to stimulate sufficient interest in the rehabilitation community so that the community would develop, organize and support an experimental program leading to definitive evaluation of the technique described.

As a point of departure, a two phased program is described below. It is the purpose of this program to determine if it is possible to replace the audible feedback obtained by a hearing child with visual feedback, which can be reinforced in the same way as aural, thus causing speech development in the profoundly deaf.

#### The First Phase

The objective of the first phase of the program is the validation and evaluation of basic premises.

The concept of the use of visual speech and the conclusion that speech visualization in color and intensity might indeed replace the ear as the communication device is based on direct observations by the writer, when acting as a consultant in electroretinography. These observations have subsequently been reinforced by reported observations of D. W. J. Corcoran<sup>6</sup>, R. S. Karlovich<sup>7</sup>, Schubert and West<sup>8</sup>, and E. M. Glaser<sup>9</sup>. This writer's work terminated in 1967, and no further investigation has been undertaken by him since then, due mostly to the absence of technology needed to realize a practical visualization device. If the work is to be re-instituted, it must begin with an exhaustive literature search to identify any work of a similar nature which might indicate that the program is either redundant or unworkable. Once such a study is completed, the design of an experimental program and the supporting hardware would begin.

#### The Second Phase

Determination of the details of the specific experimental method to be used to evaluate the basic concepts, identification of the essential technical and operational parameters to be used to specify an experimental visualizer, selection of suitable subjects, data collection and reduction, and the preparation of a report will be accomplished during the second phase of the program.

For the reasons stated before, the writer believes that the earliest experiments should be directed toward ascertaining the value of sound visualization in speech pattern formation. To test this hypothesis, several congenitally, profoundly deaf infants will be selected as subjects and placed in nursery rooms prepared in their homes, as previously described and shown in Figure 4. These children will be spoken to, cuddled, diapered and fed as would normal children; the only difference is that they will not leave

the test room and that their activities will be continually recorded and monitored. Their behavior will be compared with established norms and with that of a group of similarly handicapped children treated in exactly the same way except that they will have been denied visual feedback.

The identification and selection of the children at a sufficiently young age represents a major problem, and this phase will begin with an extensive screening program to locate suitable subjects. Criteria will include profoundness of deafness, age at recognition of the disability and physical condition. Several methods will be used to identify early deafness. Genetic surveys will be conducted to locate expectant parents who have a high probability of producing a deaf child and to enlist them in the experiment. Galvanic response of the fetus to external sound stimuli has produced high preliminary successes in determining fetal deafness. Where high genetic probability of potential deafness exists, such measurements will be made to confirm its existence. A program of routine post-natal electro-encephalographic evaluation can also be expected to produce several subjects. Proceeding concurrently, several possible sound/visual analogs will be analyzed, and a specification will be produced from which contractors will be engaged to produce the required test materials.

The initial evaluation of the approach can be expected shortly after the experimental work is begun. Work completed by Gesell<sup>10</sup> and others indicates that patterns of speech and voice development are sufficiently well established after six months that norms can be established. For this reason, it is probable that the experiment need not be continued longer than six months with each subject to establish baseline data.

The second phase will conclude with result analysis and evaluation. A positive indication will lead to implementation of portable equipment and a useful prosthesis. Early negative results will lead to reevaluation of the entire premise.

#### References

1. "Handling Words; System That Transforms the Sounds of Speech into a Pattern of Tickles on the Palm of the Hand." Electronics, 41:208, June 1968.
2. "Sound Waves Turned Into Tactile Vibrations Help the Deaf to Talk". Product Engineering, 41:17-18, April 7, 1969.
3. Upton, Hubert W., "Wearable Eyeglass Speech-reading Aid", American Annals of the Deaf, Vol. 113, No. 2, March, 1968, pp 222-229.
4. Visible Speech, Ralph K. Potter, George A. Kopp and Harriet G. Kopp, Dover Publications, Inc., New York, Chapters 1 and 2.
5. Brown, A. E. and Hopkins, H. K., "Interaction of the Auditory and Visual Sensory Modalities". Journal of the Acoustical Society of America. 41:1-6.
6. Corcoran, D. W. J. and others: "Comparison of Training Techniques for Complex Sound Identification". Journal of the Acoustical Society of America. 44:157-67, July, 1968.

7. Karlovich, R. S.: "Sensory Interaction: Perception of Loudness during Visual Stimulation". Journal of the Acoustical Society of America. 44:570-5, August 1968.
8. Schubert, E. D., and West, R. A.: "Recognition of Repeated Patterns; A Study of Short Term Auditory Storage". Journal of the Acoustical Society of America. 46:1493-501, December 1969.
9. Glaser, E. M.: "Some Promising New Techniques in Hearing Research". Journal of the Audio Engineering Society. 17:292-7, June 1969.
10. Gesell, Arnold and Amatruda, Catherine S. Developmental Diagnosis: Normal and Abnormal Child Development. 1969 Harper-Row, New York, N. Y.

#### Non-Specific References

1. Devoe, D. B.: "Human Integration of Concurrent Audio and Visual Messages". Journal of the Audio Engineering Society of America, 14:225-32, July 1966. This article was basic in the formulation of the original concept of visual sound.
2. Montgomery, G. W. G.: "Analysis of Pure Tone Audiometric Responses in Relation to Speech Development". Journal of the Acoustical Society of America. 41:53-9, January 1965. Contains valuable information which can be extrapolated to relate speech development to Acceptance Bandwidth.
3. Rudmore, W.: "Audiometric Screening of the Newborn". Journal of the Acoustical Society of America, 41:868, April 1967. Information applicable to the selection of suitable subjects for the experiment.
4. Nelson, Katherine: "Concept, Word and Sentence". Psychological Review, 81:4, July 1974. A review of speech acquisition theories.

#### Acknowledgement

The writer wishes to thank Ms. Janet Cote and Ms. Deborah Hotch for their careful review of the presentation and their valuable organizational and technical help. The writer also wishes to thank Prof. Robert Redden of the Dept. of Speech Pathology of Northeastern University for his review of the technical material and his valuable comments.

A COMPARISON OF FREQUENCY SPECTRAL SHIFTING AND FREQUENCY  
DIVISION AS A POSSIBLE HEARING AID

by

Richard M. Campbell  
David C. Shultheis  
John M. Barton

The Ohio State University Bio-Medical Engineering Center  
and Department of Electrical Engineering  
Columbus, Ohio

Summary - A preliminary investigation of the possibility of using either speech spectral shifting or speech spectral division to move the important high frequency information in speech to some lower frequencies for the benefit of those hearing impaired with residual low frequency hearing has been performed. The results indicate that some improvement in understanding can be gained with either of these techniques. This investigation indicates, however, that the technique of spectral shifting gives the most improvement with a maximum gain of about two to one in understanding when the residual hearing is restricted to the range of 0 to 500 Hz.

The possibilities of providing speech information to persons who are classified as deaf but still have some residual low frequency hearing has been enhanced greatly in recent years by the development of many types of miniature integrated circuits and memories. These miniature components allow one to perform many types of signal processing in order to shift the important high frequency speech information to the low frequencies available to many hearing impaired persons. Preliminary investigations of frequency spectral shifting and frequency division as a possible hearing aid for these persons has been carried out at The Ohio State University. This paper presents some of the basic data on the measured intelligibility of speech which has been filtered and frequency shifted as well as that which has been filtered and frequency divided. In both cases the output signals are low pass filtered in the range of 500 Hz to 1500 Hz to simulate impaired hearing response. The preliminary results indicate that some improvement in intelligibility should be possible for persons with residual low frequency hearing using both of these techniques.

It has been known for many years that the speech information density spectrum peaks near 1 KHz while the speech power density spectrum peaks near 400 Hz (1). This fact has been used many times to improve the actual signal to noise ratio in both telephone systems and radio communication systems by the filtering out of the high energy, low information portion of the speech spectrum and increasing the signal intensity of the high information, low power portion.

It seems only natural that one should at least attempt to move this high frequency, high information portion of the speech signal to a part of the spectrum where it can be heard by this group of hearing impaired persons.

The spectral shifting experiments are done by moving a piece of the spectrum such as 1 KHz to 2 KHz down to the range of 0 to 1 KHz. It is necessary to filter out the original portion of the spectrum from 0 to 1 KHz before this is done to prevent the generation of spurious signals which do not add to the information being heard. The actual technique used is the standard communication system for generating a single sideband amplitude modulation signal about a carrier at approximately 450 KHz. The carrier signal used in the detection process is shifted from the original carrier frequency to provide the spectral shifting of the information.

The results of the spectral shifting were evaluated by using a group of 36 words containing most of the vowel and consonant sounds. This list was derived from the Rhyme Test given on page 488 of Davis and Silverman (2). The list was divided into 12 groups of three words each and the persons listening to the shifted speech were asked to indicate the order in each group as they heard it. They were requested not to guess the results. The results of this study are shown in Figure 1. It can be seen in this figure that there is some improvement in the understanding when the speech is shifted lower in the spectrum. This is particularly true here at the lower bandwidth of 500 Hz. With no shifting, the recognition

was only 25 percent but it increased to 45 percent when the lower 500 Hz of the signal was removed and the speech was shifted down by 500 Hz.

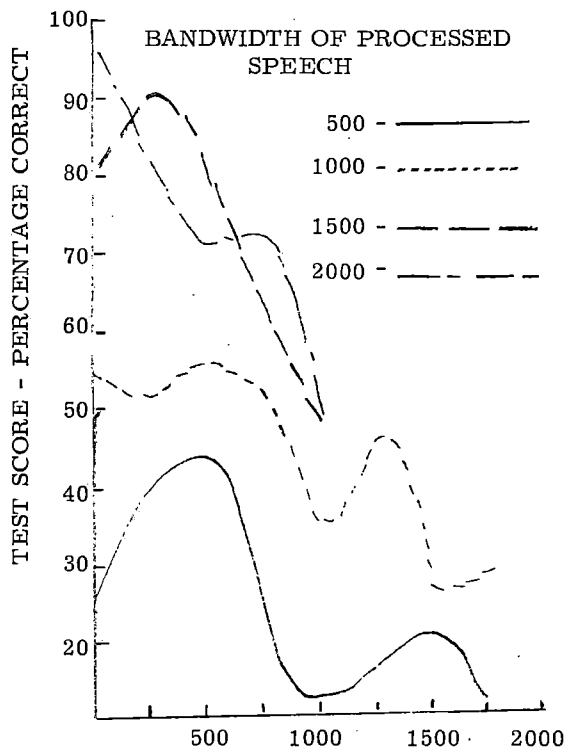

Figure 1 Audio Spectrum Shift in Hertz and Lower Frequency Cutoff of Filter

In the frequency division of the speech, all frequencies in the speech are divided by an equal amount so that the original relative harmonic relations are preserved. The actual technique used is one in which the signal is sampled for a period of time (about 50 milliseconds) and then played back at a slower rate. This requires that some of the time information be thrown away if the signal is to be returned in real time. For instance, if division by two is performed every other 50 millisecond piece of signal is discarded and the original 50 millisecond blocks are played back in 100 milliseconds each. The actual equipment used in this preliminary test is a PDP 11/45 digital computer.

The results of the spectral division were evaluated using the same word list and the same technique for scoring the results as was done in the spectral shifting experiment. The preliminary results are shown in Figure 2. Here it can be seen that when the upper cutoff frequency of the listener was restricted to about 1 KHz, there was an improvement in the understanding with frequency division. For a frequency division of 1.50, the understanding went from 77 percent for no division to 84 percent with the division.

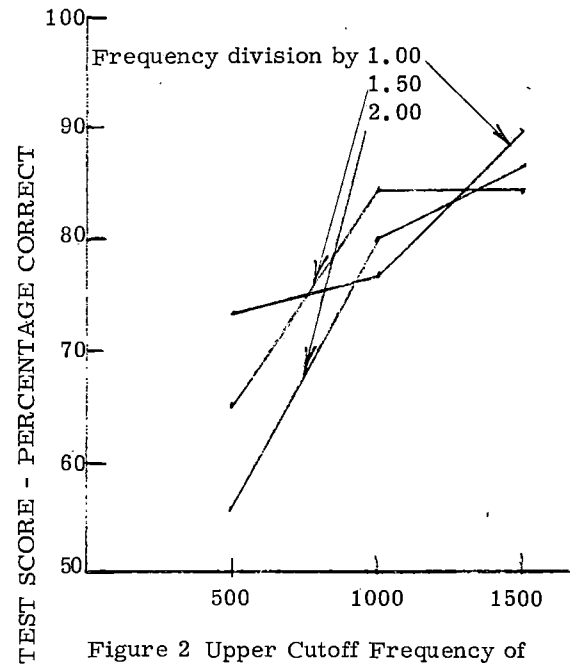

Figure 2 Upper Cutoff Frequency of Listener's Filter

From the preliminary tests using these two techniques, it appears that the speech spectral shifting would be the most useful. It should be pointed out, however, that two different groups were used in these tests since they were performed some time apart. It also should be mentioned that no learning was involved in these tests and that area needs to be investigated. It is possible that with some training and experience persons could learn to listen to either spectrally shifted or divided speech and improve their listening ability from that indicated here.

Finally, while the test setups used in these tests involved some physically large pieces of equipment, the technology is here today for performing either of these techniques inside of a small box which could be carried in a shirt or coat pocket. It really only remains for us to determine what should be done and design and construct the miniature processing unit accordingly.

#### References

1. Fletcher, H. Speech and Hearing, D. VanNostrand Co., Inc., New York, 1929.
2. Davis, H. and S. R. Silverman. Hearing and Deafness, Third Edition, Holt, Rinehart and Winston, New York, 1970.

The material contained within this publication  
has been edited for typographical and gram-  
matical errors by the individual authors only.

*The Biomedical Engineering Center—  
a unit of the Rehabilitation Institute  
at Tufts-New England Medical Center—  
is devoted to conducting research  
and client service projects  
that make the benefits of technology  
available to meet the needs  
of physically disabled persons.*



This project is funded under a grant from the  
Massachusetts Rehabilitation Commission.

*The Rehabilitation Institute  
Tufts-New England Medical Center  
Carl V. Granger, M.D.—Physiatrist-in-Chief*

Tufts-New England Medical Center  
Biomedical Engineering, Box 1014  
171 Harrison Avenue  
Boston, Massachusetts 02111

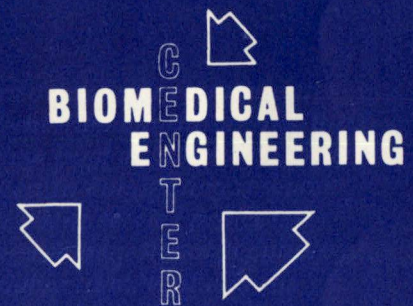

REHABILITATION  
ENGINEERING  
PROJECT

## WHAT IS THE PROJECT?

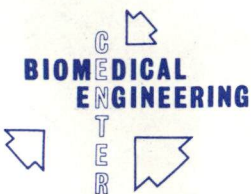

The Rehabilitation Engineering Project is a client-service program of the Biomedical Engineering Center— part of the Rehabilitation Institute at Tufts-New England Medical Center in Boston.

The goal of the Project is to provide comprehensive engineering assistance to severely physically disabled clients.

Services may include consultation with counselors, detailed information on the availability and suitability of adaptive devices, and in some cases, the design and development of special devices that cannot be obtained commercially.

## WHY IS IT NEEDED?

Serving the individual vocational needs of severely disabled persons frequently requires that assistive devices or equipment be provided.

But it is often difficult for counselors to make the most effective choice of such devices.

New products are constantly being developed; many old ones are being improved or discontinued; few counselors have the time to keep up with all the changes.

Catalog descriptions rarely provide enough information about the applicability, reliability, and safety of a particular device to permit proper evaluation.

Standard devices frequently have to be modified to meet the client's individual needs.

And sometimes a client requires a special device that isn't commercially available.

The Massachusetts Rehabilitation Commission, recognizing these problems, has granted funds to the Biomedical Engineering Center to provide a comprehensive Rehabilitation Engineering resource service for counselors and clients. The Project serves as both a clearinghouse for device and equipment information, and a facility for designing, building and modifying adaptive devices for the severely physically disabled.

## WHO IS ELIGIBLE?

The services of the Project may be available to you and your client if

- he or she has a severe physical disability that constitutes (or results in) a substantial handicap to employment, and
- there is a reasonable expectation that vocational rehabilitation services may benefit him or her in terms of employability.

During the first year of the Project we will be serving the people of Massachusetts— past and present clients of MRC, as well as others who meet MRC's eligibility standards. In the summer of 1976 we will be expanding the program to include clients throughout the six New England states.

If you are a severely physically disabled person who is not already a client of your state's Vocational Rehabilitation agency, you may still be eligible for the services of the Project. We will contact your local VR office and refer you as a potential client. If you qualify, they will be able to provide you with a full range of services and assist you with various rehabilitation needs.

## HOW CAN THE PROJECT HELP YOU AND YOUR CLIENT?

By *talking* with you about the needs of your client and deciding exactly what sort of device would be most helpful.

By *showing* you and your client what's commercially available.

By *recommending* the right device, and telling you where to buy it, if somebody already makes what you need.

By *modifying* the device— or any piece of equipment you already have— to make it suit your client's precise needs as effectively as possible.

By *designing and building* what's needed if it's not commercially available.

By *keeping you up to date* on what's new in adaptive devices, and on what solutions we've been providing for other VR counselors whose problems are similar to yours.

By *being available* whenever you have a problem that you think we might be able to help you solve.

*IT'S YOUR MOVE.* Phone or write:

Earl Gaddis, *Project Director*  
Rehabilitation Engineering Project  
Biomedical Engineering Center  
T-NEMC, Box 1014  
171 Harrison Avenue  
Boston, Massachusetts 02111

Phone (617) 956-5036 or 956-5037

Tell us about your client, and give us any information you think might be useful. We'll get back to you, exchange ideas, and see what we can do to help.

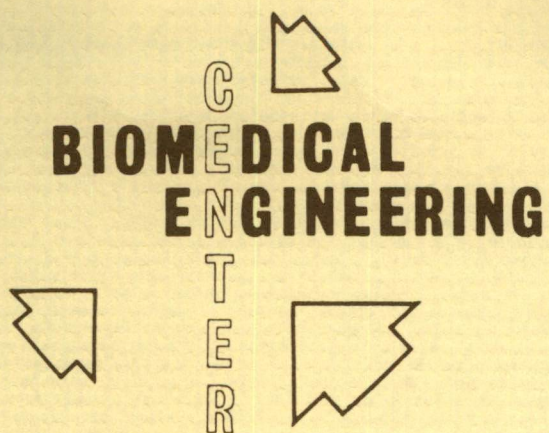

**TUFTS - NEW ENGLAND MEDICAL CENTER**

The Department of Physical and Rehabilitation Medicine,  
Tufts University School of Medicine

The Rehabilitation Institute, New England Medical  
Center Hospital

**185 HARRISON AVENUE BOX 372  
BOSTON, MASSACHUSETTS**

**TECHNICAL REPORT**

# THE TUFTS NON-VOCAL COMMUNICATION PROGRAM

by

Richard A. Foulds                    Gregory Baletsa  
William J. Crochetiere\*        Chester Meyer  
Biomedical Engineering Center  
Tufts-New England Medical Center  
Boston, Massachusetts

Summary: This paper describes the efforts of the Biomedical Engineering Center in conducting both research and applied studies in the area of non-vocal communication for the severely physically disabled.

## Introduction

The application of technology to the field of Rehabilitation Medicine has offered the promise of restoring or assisting physical functioning of a severely physically disabled person. A major area of concentration of the Biomedical Engineering Center has been that population which is prevented from normal communication because of a profound motor dysfunction. The lack of speech and writing skills due to muscle incoordination, weakness, or paralysis is evident in disorders such as cerebral palsy, ALS, traumatic head injury, and stroke. While each of these is medically different, the resultant absence of communication is commonly devastating in terms of the person's social, educational, and vocational life.

The Biomedical Engineering Center (BMEC) has staffed its non-vocal communication project with three engineers, an occupational therapist, and a special educator. The goals of the project are to identify technological means of assisting a person to better communicate, and work within the community in the application of assistive devices.

At the present time, the BMEC is under contract to the Massachusetts Bureau of Special Education to work with special needs programs throughout the state providing this type of technical support. As of this writing, twenty-two special education classrooms have been equipped with electronic devices developed by the BMEC. At the same time, the BMEC is working with other agencies and institutions in examining the communication needs of other disabled individuals. Older people who may have been educated before an accident or the onset of a disease do not require educational support, but may require a faster, more powerful device than would a child who is disabled from birth and is learning language in spite of his disability.

A very difficult situation is the older cerebral palsied person who may have been entirely missed by the educational system. He may be extremely intelligent while lacking the formal language skills necessary for effective use of an assistive device.

In order to meet the needs of a varied population, the BMEC has begun to develop a series of

\*Associate Professor of Engineering Design  
Tufts University    Medford, Massachusetts

communication devices that span the entire range of communication possibilities. This effort will hopefully give the individual a choice of which machine (if any) he wishes to use. The remainder of this paper describes the developments of this program.

## The TIC and Related Devices

The Tufts Interactive Communicator<sup>1</sup> (TIC) has been designed as a single switch input typing device that can be operated by a single grossly controllable muscular movement. The need for such an easily operable unit was identified early in the project. While many non-vocal individuals can operate more complex interfaces, the single switch feature finds extensive use with the most severely disabled. The user selects the characters from a visual keyboard that offers rows of characters by successive illumination. A single switch closure chooses the illuminated row, and commands the TIC to scan the characters in that row. A second switch closure chooses a single illuminated character. Once selected, the letter or number is printed on a hardcopy medium, and is displayed electronically. In this way messages are constructed on a letter-by-letter basis.

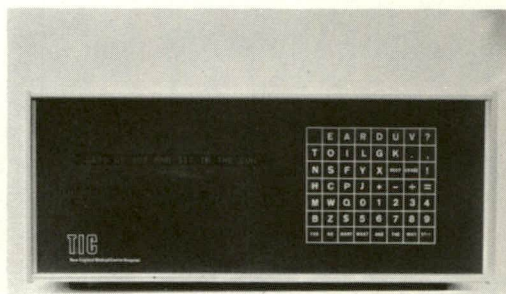

Front Panel of the TIC  
Fig. 1

The TIC that is now in use differs only slightly from that which was developed over 5 years ago. The method of letter selection has proven to be effective and hence is unaltered. The visual keyboard has been rearranged to take advantage of

the rank order of characters in the English language. This represents an approximate 30% speed improvement over an alphabetically-ordered visual keyboard.

Recent developments in low power electronics have offered the potential for battery operation of the TIC. Since funding for redesign of this device was not readily available, the program staff proceeded cautiously, looking for an appropriate time for a design change.

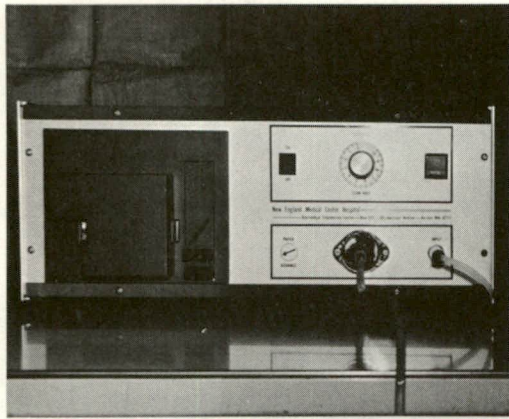

Rear Panel of the TIC  
Fig. 2

The current equipment modifications are actually taking place in two directions. The present TIC offers a 32-character electronic display, and a paper strip printer. These functions are being transferred into a smaller, portable unit with an operating life of eight hours before recharging is necessary. The existing TIC, for which a large price has been paid for tooling development, will simultaneously be upgraded into a more powerful communication tool. This device will offer a complete video display that can be edited and modified by the user. The corrected text can then be "dumped" onto a typed page. This will hopefully provide the flexibility required for academic and vocational activities.

#### The Dictionary

Each person who communicates either through written or spoken language tends to use a vocabulary that is smaller than that actually at his disposal<sup>2</sup>. This may be evident in conversational idioms, or in key words or phrases (i.e. jargon) of a geographical location, or business environment. Part of the Non-Vocal Communication Program's activities has been to identify ways of shortening the user's time involved in transmitting a message. The method chosen has been to incorporate a dictionary of 400 words or phrases that can be custom programmed into a personalized TIC. The new circuit card can accommodate 4 increments of 1000 letters. Therefore the complete dictionary will consist of no more than 400 entries whose total length is no longer than 4000 letters. While this provides an average of 10 characters per entry, the actual word or phrase lengths will be independently set.

The selection of such a large number of entries offered a challenge in the design of a

visual keyboard. The magnitude of a 456 entry keyboard (400 words + the standard TIC keyboard) would prevent efficient use due to long scanning times. An encoded method was determined to be the desirable approach. The bottom row of the TIC keyboard is designated with the numbers one through eight, indicating dictionary page numbers. Each character of the existing keyboard will represent a different word on each page. Selection of a word is accomplished by first choosing a page number, and then the appropriate keyboard character. The desired word will be taken from the dictionary memory and displayed on the output device.

#### Anticipatory Communication<sup>3</sup>

An important consideration in the application of a communication device is the speed with which its operator can make an output. The rate of output is limited by both the user's input time response, and the size of the scanned visual keyboard. Although the vocabulary and verbal skills of the user are expected to improve with training, the physical input cannot be expected to do the same. Disabilities such as cerebral palsy do not generally change dramatically and will most likely require the user to use the same grossly controlled input motion for his lifetime. ALS is a progressive disease and will result in a loss of motor control over time.

As can be understood from above, the easy solution of "speeding up" the scan rate is impractical. Improvement cannot be found in reducing the keyboard size since the TIC keyboard contains essential entries for alphabetic and numeric output as well as punctuation and arithmetic symbols.

A major effort of the BMEC has been to study the application of language redundancy to this rate problem. Results of the project have shown a theoretical improvement of approximately 50% over the standard TIC. Present studies are focusing on the display techniques that will maintain this level of improvement when the device is used by a human operator.

Based upon knowing no prior characters p=.19  
Based upon knowing 1 prior character p=.28  
Based upon knowing 2 prior characters p=.40  
Based upon knowing 3 prior characters p=.51

Probability of Correctly Predicting  
the next Character to be Typed

Fig. 3

The current state of the research has yielded a prototype device appropriately named the ANTIC (Anticipatory TIC) which predicts the six most likely letters to follow the letter most recently chosen. This prototype is being studied with the assistance of a high-level spinal cord injured client who is providing valuable information on its acceptability as a working design. In order to reach the 50% improvement, the statistics on letter frequency will be based not upon the single prior choice, but upon the three previous selections.

#### Symbol Communication

All of the above devices require that the user have the ability to spell, or at least

recognize words from the dictionary. Within the Non-Vocal Communication Project there has been identified the need for a less sophisticated device that will identify locations rather than character symbols. The solution to this need has been a small relatively inexpensive device that offers the user the choice of eight or 48 squares. Filling these squares will be symbols, letters, or pictures attached to small plastic clips. The same type of switch as is used in the TIC or ANTIC can stop the scanning at a particular symbol and cause the light to flash as an indication of choice. The Symbol TIC or SYMTIC scans the eight squares in a linear fashion, or scans the 48 in a row-column manner. There is no printout provided in the unit. The SYMTIC is envisioned as a teaching tool for early intervention with non-readers and can be used with various teaching systems such as the Peabody Rebus Reading Program<sup>4</sup>, or the alternative language programs like the Bliss Symbolics.<sup>5</sup>

### Symbol Printing

The principal difficulty encountered with the SYMTIC is its lack of a printed output. This prevents the user from communicating independently since his listener must remain within viewing distance.

The BMEC is trying to rectify this situation by developing a printing unit that will reproduce graphic symbols. The Cryptographic TIC or CRYPTIC will initially be programmed for use with the Bliss Symbols and will be assigned to the Vermont Achievement Center in Rutland, Vermont.

### Electronic Letterboard

The devices described throughout this paper have been operated by a single input switch. Many non-vocal individuals are capable of greater interaction with a machine. Letterboards have been commonly used by those clients who have some residual pointing ability or the use of a head-pointer. Letterboards<sup>6</sup> have the advantage of being inexpensive and entirely flexible since they are only paper on which a teacher or clinician writes words and letters, or draws pictures. The locations of these objects can be determined according to the physical abilities of the user. Midline crossing problems, hand preference, or varying dexterity can be minimized by the proper placement of the symbols.

Electronic conversion of these letterboards has not been able to offer the same flexibility. The use of mechanical switches and sensors presents physical limitations that prohibit total flexibility. Expanded typewriter keyboards offer a fixed arrangement that may often be unsatisfactory to a user. Varying the size of that keyboard or even changing the size of the switches becomes a major mechanical task. The Autocon<sup>7</sup> from the University of Wisconsin offers an attempt at flexibility with several optional arrangements of the magnetic proximity switches.

The BMEC has contracted with the Flex Key Corporation of Gloucester, Massachusetts for the fabrication of a flat switch panel that measures 22" x 15" and contains 4000 switch contacts arranged in a honeycombed grid. The Flex Key Corp. has graciously donated the engineering time required in the design of the switch panel.

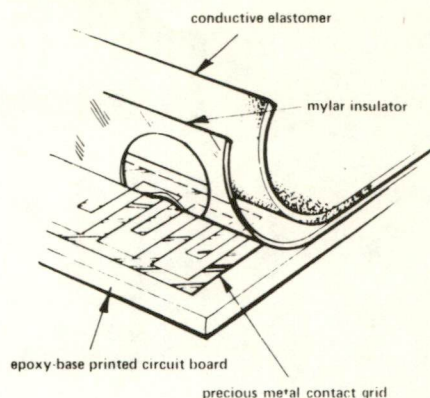

Elastomeric Switch Structure  
Fig. 4

The switching mechanism is a proprietary process owned by Flex Key<sup>8</sup> and utilizes the properties of a conductive elastomer. The entire panel consists of a large printed circuit card and a layer of elastomer separated by a mylar insulator. The entire panel is approximately 1/8" thick.

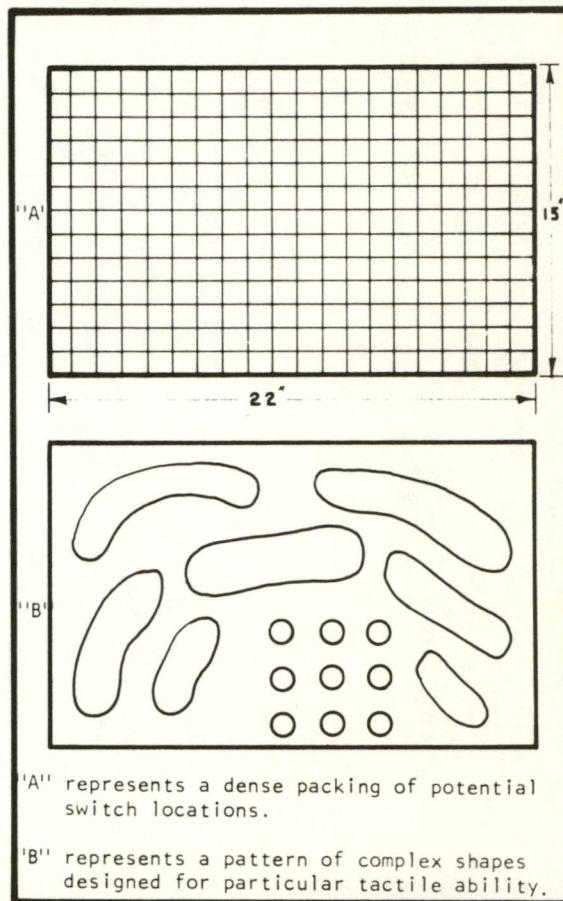

Samples of Complex and Custom Tactile Communicator Layout  
Fig. 5

The switch contacts are .25" in diameter on .30 inch centers. Assuming that the smallest object pointing to the panel will be a human finger, at least one of the switches will be closed when the panel is touched. Once the switch closure is made, the X and Y coordinates of the contact will be detected by external circuitry. The force required to register an input is less than 10 ounces. The switch movement is .005 inches.

That external circuitry is now being developed and will allow the teacher or clinician to define clusters of switches as words or letters. In this way a totally flexible letterboard surface may be custom designed to meet the user's needs. The logic circuitry will identify the appropriate input and operate the same type of printing devices as are already in use in the TIC.

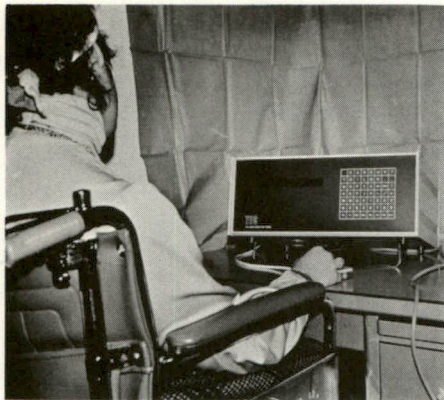

Tufts Interactive Communicator in Clinical Setting  
Fig. 6

#### Technology Utilization Project

The Biomedical Engineering Center has felt an obligation to make available the results of its research and development. This has already been evident in the project within the State of Massachusetts. Other devices have also been made available to individuals and institutions for use in their own programs. The BMEC tries to maintain contact with these sites and provide any possible assistance. All devices have been offered as a service of Tufts-New England Medical Center and are made available on a non-profit basis.

#### Acknowledgement

This work has been supported by HEW Rehabilitation Services Administration Grant 16-P-57856/1-01 and a Contract with the Massachusetts Department of Education.

#### References

1. Foulds, R.A., Gaddis, E.: "The Practical Application of an Electronic Communication Device in the Special Needs Classroom", Proceedings of the Conference on Devices and Systems for the Disabled. Krusen Center for Research and Engineering, Philadelphia, Pennsylvania. 1975, pp. 77-80.
2. Miller, G., Language and Communication, McGraw-Hill Co. c 1951, 63.
3. Foulds, R.A., Baletsa, G., Crochetiere, W.J.: "The Effectiveness of Language Redundancy in Non-Verbal Communication", Proceedings of the Conference on Devices and Systems for the Disabled. Krusen Center for Research and Engineering, Philadelphia, Pennsylvania. 1975, pp. 82-86.
4. Woodcock, R., "The Learning Disabled and the Peabody Rebus Reading Program", A Paper presented at the Annual Convention for the Council for Exceptional Children, Chicago, Illinois. April 1970.
5. Teaching Guideline - Symbol Communication Research Project, Ontario Crippled Children's Centre. Toronto, Ontario. 1974.
6. Vicker, B., Nonoral Communication System Project, University Hospital School, The University of Iowa, Iowa City, Iowa. c 1974.
7. Participant Resource Book, 1975 National Workshops on Non-Vocal Communication Techniques and Aids, The University of Wisconsin, c 1975.
8. Flex Key Brochure 10-73-FK-5K  
Flex Key Corporation, Gloucester, Massachusetts.

## THE REHABILITATION ENGINEERING CLINIC

by

Earl L. Gaddis  
Biomedical Engineering Center  
Tufts-New England Medical Center  
Boston, Massachusetts

Summary: The Rehabilitation Engineering Clinic is a client-service program for the New England region. It provides comprehensive engineering assistance to counselors and severely physically disabled clients. Services include a clearinghouse of detailed information on commercially available aids, and complete facilities for design, construction and modification of assistive devices.

During the first year the Clinic has provided a variety of services to forty severely disabled clients, most of whom have spinal cord injuries. Most clients during this year were Massachusetts residents; in the future the Clinic will be expanding to serve more of New England.

### WHAT IS THE CLINIC?

The Rehabilitation Engineering Clinic is a client-service program of the Biomedical Engineering Center--part of the Rehabilitation Institute at Tufts-New England Medical Center in Boston.

The goal of the Clinic is to provide comprehensive engineering assistance to severely physically disabled clients.

Services include consultation with counselors, detailed information on the availability and suitability of adaptive devices, adaptation of existing equipment, and the design and development of special devices that cannot be obtained commercially.

### WHY WAS IT CREATED?

#### Problem: Lack of Information

Serving the individual vocational needs of severely disabled persons frequently requires that assistive devices or equipment be provided.

But it is often difficult for counselors, disabled persons and their families, therapists, or doctors to make the most effective choice of such devices. New products are constantly being developed; many old ones are being improved or discontinued; few counselors have the time to keep up with all the changes.

There are a number of information services available to disabled people and rehabilitation workers, such as ISAARE<sup>1</sup>, Accent on Information<sup>2</sup>, and the Green Pages<sup>3</sup>. These services can be extremely useful in locating the suppliers of commercially-available assistive devices.

But the counselor or consumer is still left with the task of comparing manufacturer's claims and trying to select the most appropriate device. This can be difficult and misleading: catalog descriptions rarely provide enough information about the applicability, reliability, and safety of a particular device to permit proper evaluation.

### Solution: A Clearinghouse for Information

Counselors and disabled clients in New England needed a central clearinghouse that would give them simultaneous access to these and many other sources of information with a single inquiry. This clearinghouse had to include technical people on its staff whose engineering background and direct contact with equipment designers and manufacturers would permit realistic evaluation of the safety and reliability of each device.

But experience in rehabilitation and clinical background were equally essential. And it was important that each client be able to work person-to-person with someone on the staff who could talk things over in non-technical language, bringing out the practical questions and personal preferences that can play an important part in selecting the most appropriate device.

#### Problem: Custom Devices Needed

Standard assistive devices frequently have to be modified to meet the client's exact needs. And severely disabled persons may require special equipment that isn't commercially available. Facilities for designing and construction of such equipment are not usually readily available to disabled people.

In many cases a disabled person--with or without assistance--can invent devices or suggest modifications that could help increase his or her independence. Under certain conditions a do-it-yourself approach can be quite successful.

But even a seemingly uncomplicated device usually turns out to be a good deal more difficult to design and build than one might expect--particularly when one doesn't have access to the right combination of tools, parts, materials, and experience.

For a severely disabled person (such as a "high-level" quadriplegic with little or no use of the arms or hands) it becomes necessary to rely on someone else for the entire process of construction, fitting, and modification--even if the disabled person is able to carry out the entire design process independently. This can be

dangerous if the person responsible for building the device is not skilled and experienced enough to insure that the equipment will be safe and reliable, or if "make-do" compromises result from the limitations of someone's home workshop.

It has been proposed that "the most cost-effective adaptations are simple, low-cost modifications with implications for use by many disabled people in a variety of occupations."<sup>4</sup> This is a very useful design philosophy, but one whose limitations must not be overlooked. For someone with a very severe physical disability --such as paralysis from the neck down--complex and expensive devices may be required in order to provide independent mobility, control over the environment, and other functions that can be made much more easily available to a person who has some use of the hands. The Rehabilitation Act of 1973 requires that VR counselors provide needed assistance to severely disabled clients as well as to those with lesser disabilities.

#### Solution: Comprehensive Engineering Service

Disabled residents of New England needed access to a comprehensive engineering facility that could meet the requirements of counselors and clients for the design, construction, and modification of adaptive devices. This resource center would have the capability, the experience, and the facilities needed to produce complex and sophisticated devices when needed, but would concentrate on providing the simplest and most cost-effective solution to each problem.

Such a resource center would ideally house, and share staff with, the clearinghouse mentioned earlier. This would provide the equipment designers with detailed up-to-the-minute knowledge of the devices that are already available, enabling them to make the most intelligent make/buy/modify decisions for each client.

The Massachusetts Rehabilitation Commission, recognizing these two problems, granted funds in the summer of 1975 to the Biomedical Engineering Center to provide a comprehensive Rehabilitation Engineering Resource service for counselors and clients. The Clinic serves as both a clearinghouse for device and equipment information, and a facility for designing, building and modifying adaptive devices for the severely physically disabled.

#### WHOM DOES THE CLINIC SERVE?

During its first year, the Clinic has provided services primarily to severely physically disabled residents of Massachusetts: past and present clients of the Massachusetts Rehabilitation Commission, and others who meet MRC's eligibility requirements. Services are generally requested by an MRC counselor--but we have also responded to requests from hospitals, rehabilitation centers, schools, and consumer groups; from doctors and therapists; from out-of-state VR agencies; and directly from disabled individuals and their families.

In the future, as the Clinic expands, we expect to extend our services further into the six-state New England region.

This year most of our forty clients have been persons with spinal cord injuries; muscular dystrophy, cerebral palsy, and birth defects have also been represented. Of our SCI clients, the great majority are high-level quadriplegics.

#### WHAT DOES THE CLINIC DO?

Our primary responsibility is to locate or develop practical solutions to a wide range of problems experienced by counselors and their disabled clients.

Sometimes information or advice is all that's needed. For example, we were able to tell a spinal-cord injured girl in Massachusetts--who loved plants but was afraid she'd never be able to work with them after her accident--about a community college in Maryland that offers a new program in horticulture for the handicapped, complete with a greenhouse designed for wheelchair use.

In many cases we are able to locate a ready-made, commercially-available device that meets a client's needs without any modification. If the item is a relatively expensive one, we recommend that it be purchased by the client's local VR office. If it is inexpensive, we buy it directly and furnish it to the client immediately. This saves a great deal of time for everyone.

Often we are called upon to modify equipment already owned by a disabled person. One of our clients was a boy with muscular dystrophy who owned a Citizen's Band radio that he was unable to operate without a great deal of difficulty. We were able to solve his problem by designing a special knob with a long paddle and a one-way clutch, equipping the set with a feather-touch remote push-to-talk switch, and building a slanted mounting base that included a gooseneck microphone holder.

Sometimes the only practical solution to the problem is to design and custom-make a special piece of equipment. For example, we wanted to help a young man whose spinal-cord injury had completely paralyzed his arms and hands. He was an artist and had taught himself to paint and draw with a mouthstick. But he was only able to move his head enough to reach a few square inches of the paper. We developed an electric easel that allowed him to freely reach any part of the drawing paper (see Figure 1). By touching a convenient array of microswitches with the tip of his mouthstick, he controls a pair of motors that move the sheet of paper smoothly to any desired location.



Fig. 1: Electric Easel

Some of the devices, equipment and services provided by the Clinic are:

- Electric wheelchair controls & modifications.
- Evaluation & selection of electric wheelchairs.
- Wheelchair accessories.
- Environmental control units.
- Appliance modifications.
- Hands-free telephone equipment.
- Automobile driving controls.
- Remote-control cassette recorders.
- Van lifts and modifications.
- Intercom, signalling and security systems.
- Non-Vocal communications equipment.
- Ramps.
- Feeding devices.
- Posture/support systems.
- ADL aids and accessories.
- Page turners.
- Housing modifications.
- Vocational assistance.

Although complex and sophisticated devices are sometimes required, we consider it important to make each piece of equipment as inconspicuous and unintrusive as possible. It must function, insofar as possible, as a natural extension of the person--not an additional barrier between him or her and the rest of the world.

Our aim is to provide ways of modifying the environment so that it interferes as little as possible with, and maximizes the individual strengths and assets of, the disabled person--rather than expecting the disabled person to modify himself to suit the characteristics of available devices.

For this reason, we involve the client as much as possible in the process of selecting, designing and developing equipment. This gives the disabled person maximum control over the characteristics of the device that he or she will be living with for a long time. It also helps us in our efforts to "de-mystify" technology and make it as comfortable, accessible, and understandable as we can. Technology should be at the service of the disabled person, not the other way around.

For example, a piece of equipment in a plain metal box, covered with dials and flashing lights, may be a cherished addition to a disabled gadgeteer's apartment, but the same device may clash so violently with another client's Louis XIV furniture that it will be a constant source of embarrassment and irritation.

However flawlessly any assistive device may operate, its design must also meet the psychological needs of the client--or it may very well wind up gathering dust in the back of a closet.

The importance of this factor cannot be overlooked, and one of the best ways to avoid such problems is to work with the client as much as possible at all stages of the development process. This also saves the disabled person the great frustration of waiting and waiting, while a mysterious device is being developed in an ivory tower somewhere by people who think that "professionals" must keep the details of their work secret from the clients they are supposed to be serving. We find that close involvement of the client usually makes it easier, not harder, to do

a truly professional job of device development.

## OTHER FACETS OF THE CLINIC

### Connection with Rehabilitation Institute

The BMEC is the research and development unit of the Rehabilitation Institute at Tufts-New England Medical Center. Clinic staff participate in rounds, interact with patients, and work with doctors and therapists as part of a rehabilitation-services team.

The concept of clinical engineering (proposed by the Veteran's Administration<sup>2</sup>, who will be telling you more about it later in this session) is a useful definition that describes this aspect of the Clinic's role.

### R&T Involvement

The BMEC is also a part of Medical Rehabilitation Research and Training Center #7--one of a nationwide network of about twenty R&T Centers established by HEW. Our work in such areas as communication aids for the non-vocal severely disabled population, vacuum-forming techniques for plastic orthoses, and clinical applications of biofeedback overlaps the other activities of the Clinic and provides many useful spinoffs.

An example is the Tufts Interactive Communicator (TIC) shown in Fig. 2, a device that allows a non-vocal severely physically disabled person who has only a single controllable muscle movement to type words and sentences at will.

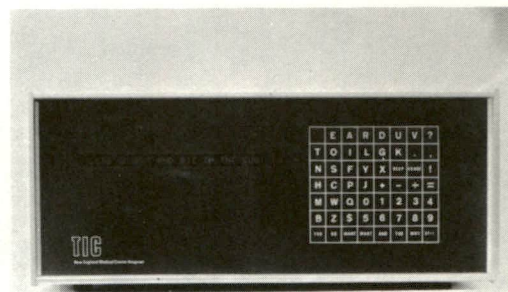

Fig. 2: Tufts Interactive Communicator

Our direct access to the projects being carried out by the other Rehabilitation R&T Centers allows us to make use in the Clinic of the latest research results and of new devices that are still in the development stage.

### Manufacture of Standard Devices

The BMEC's research, development and manufacturing facilities make it possible for the

Clinic to respond to the widespread need for certain devices that may not be commercially available in an inexpensive and reliable form that is suited to the needs of many of our clients.

The Clinic has been able to develop standardized versions of such devices that are designed to meet a wide variety of individual client requirements by the use of modular construction and the incorporation of multiple options that can be readily rearranged. We are then able to manufacture these items on a small scale, saving the final set-up step until the individual requirements of each client have been determined. This combines the advantages of off-the-shelf "standard" items (low cost, quick availability) with the "custom-tailored" features usually found only in one-of-a-kind special designs.

An example of this capability is the remote-control cassette recorder shown in Fig. 3. The one-switch scanning device that controls all the functions of the tape recorder can also control several appliances and generate an audio alarm signal. During final setup the modular circuitry can be easily arranged to provide eight environmental-control channels without a tape recorder, seven channels and the self-contained alarm, or any other combination desired by a particular client. The scanner can also function as a self-contained symbol communicator that allows a non-vocal person to select from an array of messages.

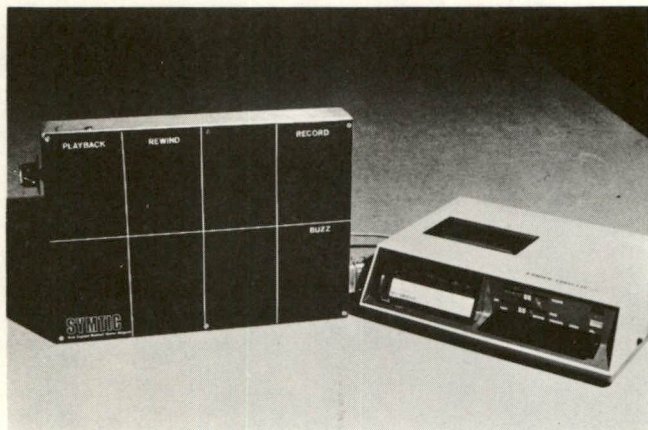

Fig. 3 Remote-Control Tape Recorder

#### Conclusion

During its first year the Rehabilitation Engineering Clinic has developed into a useful and valuable resource for severely physically disabled persons and their families, counselors, doctors, therapists, and institutions. We are looking forward to its continued progress and expansion, which will include its transition to a self-supporting operation that will no longer depend on MRC for total grant support.

To take advantage of the services of the Clinic, write to:

Earl Gaddis, Project Director  
Rehabilitation Engineering Project  
Biomedical Engineering Center  
T-NEMC, Box 1014  
171 Harrison Avenue  
Boston, Massachusetts 02111  
Phone: (617) 956-5036 or 5037.

#### Acknowledgement

This project was supported by an Innovation and Expansion grant from the Massachusetts Rehabilitation Commission.

#### References

1. "ISAARE: Information System on Adaptive and Assistive and Recreational Equipment." Adaptive Systems Corp., 1975. Published by United Cerebral Palsy Assn., 7117 S.E. Harold St., Portland, Oregon 97206.
2. Accent on Information: Computerized Retrieval System. Accent on Living, Inc. P.O. Box 700, Gillum Road & High Drive, Bloomington, Ill. 61701.
3. The Green Pages, Inc. Directory of Products and Services for the Handicapped. 641 West Fairbanks Ave., Winter Park, Florida 32789.
4. Vocational Aids and Enhanced Productivity of the Severely Disabled, K. Mallik and J. Mueller, George Washington University; Proceedings of Devices and Systems for the Disabled, Krusen Center for Research and Engineering, Temple University, April 1975.
5. "The Clinical Engineer", A. Staros and E. Peizer, Veteran's Administration Prosthetics Center. Presented at the Winter Annual Meeting of Am. Soc. Mech. Eng., November 1973.

A Communicative Assist for the  
Non-Verbal Severely Handicapped

TIC

---

The Tufts Interactive Communicator (T.I.C.) is an electronic device which allows a severely disabled, non-verbal person to communicate his thoughts through the medium of spelled words. The T.I.C. is designed to be operated by a person who is too disabled to successfully control an electric typewriter or any communication device requiring considerable motor coordination.

Prerequisites for patient use of the T.I.C. are:

1. Unimpaired eyesight
2. One residual controllable muscular movement
3. The mental ability to express thoughts in spelled words

Given that the user possesses all of these, the T.I.C. will transform his muscular movements into printed letters which can be organized into words.

PHYSICAL DATA

Dimensions	17 inches wide x 8 inches high x 12 inches deep
Weight	Approximately 20 pounds
Power	120VAC 60HZ Approximately 50 watts
Printing Medium (1)	Pressure sensitive paper tape - 1/2" wide
Character Size	1/8" high x 1/10" wide Black on White
Characters Per Roll of Paper Tape	Approximately 20,000
Printing Medium (2)	Electronic Display
Character Size	1/4" high x 3/16" wide Orange on Black
Characters Visible at Any One Time	32

## PHYSICAL DESCRIPTION

Figure 1 indicates the important components of the T.I.C. The entire unit is self contained. The only necessary interconnections are the patient input (made through a phono-plug in the rear) and the power cord. The system controls; ON-OFF, and Rate control, are mounted on the rear to avoid unnecessary visual clutter on the front panel.

On the front panel are the visual keyboard, and the two output devices. These, along with his input switch, are all the patient needs to spell. Characters are presented by an interactive sequencing arrangement (to be more fully explained later) on the visual keyboard. The user directs the sequencing and makes his selections using his one muscular movement to depress a switch. The chosen characters are printed on the paper tape, which moves to the left after each new character. Each character is visible immediately after it is printed.

The frequency of repair of the T.I.C. is expected to be low due to the use of digital integrated circuits throughout. These require little maintenance, and have an extremely long life expectancy. Minor details such as replacement of paper tape and fuses can be handled easily since the paper tray and fuse holders are conveniently located on the outside of the T.I.C.

## PATIENT INPUT

The man-machine interface is perhaps the most crucial detail concerning the T.I.C. As was stated earlier, the patient need only have control of one muscular movement. The restrictions on the word "controllable" are that the user be able to make that motion in order to depress a switch, and not make that movement when no input is desired. The patient's response time can be in the range of one

to ten seconds per input. This variation is accounted for by an appropriate change in the T.I.C.'s sequencing rate.

The location of the input switch is entirely dependent upon the patient. Various switches have been devised to allow maximum control by the patient. These utilize certain body motions, such as head-turn, knee-jerk, kick, and finger motion. Regardless of the means of making an input, the operation of the T.I.C. remains the same.

#### OPERATION OF THE T.I.C.

The T.I.C. features an interactive visual keyboard which contains 56 squares in which are printed alpha-numeric characters and short words. (The words may be of up to 4 characters and in the bottom row only.) When the T.I.C. is in the idle state, each row of squares is sequentially illuminated. The user must make a switch input to choose the row in which his desired character resides. The T.I.C. will then scan the individual squares in that row. When the desired character is illuminated, the user makes a second input on his switch. Upon receiving the choice signal, the T.I.C. will flash the chosen square to indicate the choice. On the sixth flash the character is printed, and the sequencing immediately returns to the idle mode, beginning at the top row again.

#### ERROR DETECTION

The user may experience a common difficulty in making an input. The input may occur early or late, thus choosing the wrong row or character. A high frequency of such errors indicates an improper sequencing rate, or an incorrectly placed switch. However if this type of error occurs infrequently, it can be at-

	E	A	R	D	U	V	?
T	O	I	L	G	K	.	,
N	S	F	Y	X	BEEP	ERASE	!
H	C	P	J	+	-	/	=
M	W	Q	Ø	1	2	3	4
B	Z	\$	5	6	7	8	9
YES	NO	WANT	WHAT	AND	THE	WHY	\$!?\$

VISUAL KEYBOARD

tributed to a temporary lack of control that may be caused by spasms, distractions, or some other spurious disturbance.

The T.I.C. accounts for these random errors by allowing the user to negate his choice. Once a character is chosen, it flashes for a period of time. In order to confirm that character, the operator simply waits until the letter is printed. If he recognizes the flashing letter to be incorrect, he can make a third input on the switch. The T.I.C. will not print the character, but will return to the beginning of the row and resequence it.

#### THE VISUAL KEYBOARD

Since the patient must interact with the visual keyboard, it is essential that the keyboard contain information that best suits his needs. The keyboard may have any combination of letters, numbers and symbols displayed in the 48 squares of the first 6 rows. In the 7th row, short words of up to 4 characters may be offered.

The keyboard for children is arranged in alphabetical order. This is for the reason that their educational world is structured alphabetically. For an educated patient, the keyboard is arranged in order of frequency of use of the individual characters.

The arrangement according to frequency yields approximately a 1/3 reduction in spelling time.

The words commonly used fall into a number of categories:

Short Words:       THE, AND, BUT

Responses:        YES, NO

Names:            RICK, JANE

Emotion:         \* ! ? %

### OUTPUT MEDIUM STORAGE

The principal medium of output is 1/2 inch wide paper tape. The tape printer was chosen as an economical trade-off. The T.I.C. has need of output that is both visible and hard copy. Electronic displays offer excellent visibility, but no hard copy. Electronic typewriters, or teletypes offer nicely paged printout, but their size and construction prohibit the user from conveniently viewing the output.

While many adults could use the paper strip printer as the sole output medium, many children have experienced difficulty in reading the small type. Because of this, the electronic display has been incorporated into the design. The display prints 1/4 inch high orange letters on black background. This is extremely visible output. A chosen character is printed simultaneously on both the printer and the display.

TIC

New England Medical Center Hospital

	E	A	R	D	U	V	?
T	O	I	L	G	K	.	,
N	S	F	Y	X	BEEP	ERASE	!
H	C	P	J	+	-	÷	=
M	W	Q	0	1	2	3	4
B	Z	\$	5	6	7	8	9
YES	NO	WANT	WHAT	AND	THE	WHY	\$7.1

THE PRACTICAL APPLICATION OF AN ELECTRONIC COMMUNICATION  
DEVICE IN THE SPECIAL NEEDS CLASSROOM

by

Richard A. Foulds, M.S.  
Earl Gaddis, M.A.  
Biomedical Engineering Center  
Tufts-New England Medical Center  
Boston, Massachusetts

Summary - This paper discusses a cooperative effort between an engineering research laboratory and two state service agencies. The joint project involves the installation of eleven communication devices in special needs classrooms.

Possibly the most pleasing and satisfying outcome of a research project is the practical application of the research efforts. The sometimes laborious process of removing a device from the prototype stage to a level of clinical usefulness is certainly as important as the initial concept development. Without this practical effort, those for whom the research was intended may not receive their proper benefits.

The Biomedical Engineering Center has spent the past four years developing a communicative assist for the non-verbal severely motor disabled. The TIC, as the device is called, allows such a person to type using one residual muscular movement. It has been demonstrated that the TIC offers the opportunity for an individual to communicate in an original and possibly abstract manner. This is contrasted with the only available alternative of "twenty questions."

During the first three of the four years of development, only three TIC's were produced. This was partially due to the research emphasis placed on the project. Another major drawback was the inability of the Biomedical Engineering Center to fund additional units with research money.

The need for a device such as the TIC made it essential to find a way of making the device available. While the relatively small market and high component cost virtually eliminated the possibilities of a commercial venture, the B.M.E.C. found that the service could be provided by a close cooperation between non-profit and public agencies.

Acknowledgement

In addition to funding from the two state agencies, the Medical Rehabilitation Research and Training Center of Tufts-New England Medical Center (RT-7, DHEW) has funded much of the development of the electronic hardware.

The Biomedical Engineering Center feels that it has an obligation, as well as the technical capabilities, to produce TIC's on a regular basis, even if only in a limited quantity at first. Production of ten to twenty units per year is a reasonable goal that is within the economic means available and will not obstruct the research efforts of the B.M.E.C. The B.M.E.C. is a portion of the Tufts-New England Medical Center. The New England Medical Center Hospital has sanctioned non-profit sale of TIC's as a service of the Hospital, and the Hospital administration has waived overhead charges during the initial stages of the project. In late 1974 the first two units of the latest-model TIC were shipped. Two additional TIC's are now on order.

In a major cooperative effort, the Massachusetts Developmental Disabilities Commission and the Massachusetts Department of Education have funded the construction and installation of eleven more TIC's in special needs classrooms in Massachusetts. In addition to building these communicators, the B.M.E.C. has been given the responsibility of developing appropriate training materials, providing in-service training to teachers and clinicians, and assembling curriculum materials.

The TIC and Related Devices

Before continuing with a description of the project, it is important to describe the TIC and its relationship to similar devices. The TIC is essentially a one-key typewriter with a scanning visual keyboard. The characters are selected from the keyboard by appropriate switch closures.

The TIC offers one row at a time, by lighting all the characters within the row; the scanning moves steadily down the keyboard from top to bottom. Choice of a row is made by depressing the switch when the desired row lights up. The TIC then offers

each character within the row by illuminating them from left to right. Selection of the desired character is made by pressing the switch again. The chosen character flashes four times, and then is printed on the output devices. Scanning then resumes with the top row, and the user repeats the process to select his next letter.

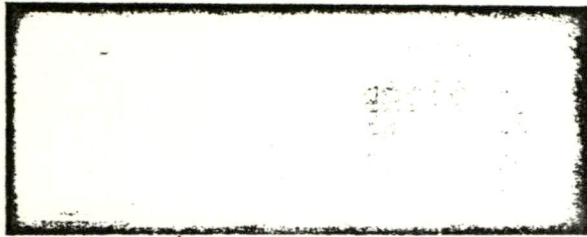

Front View of the TIC

Figure 1

Two output devices are provided in the basic TIC. The front panel contains a 32-character gas discharge display which presents the user's message in softly glowing letters. This provides easily readable feedback to the user. The output is simultaneously printed on a strip printer in the rear of the unit. This allows for hardcopy storage which can be used for homework assignments, correspondence, or long messages.

The TIC will print all alphabetic and numeric characters, punctuation, and arithmetic symbols. In addition to these, it has a vocabulary of eight short, commonly used words that can each be printed with a single actuation, such as "WANT", "AND", "THE", or--when circumstances occasionally require it--"#?!".<sup>1</sup>

The TIC is not alone in the area of communication devices. An early predecessor is the "Elcode"<sup>2</sup> which was developed by the Telephone Pioneers of America (Bell System). This offered no printing capability. The Possum<sup>3</sup> is an English device that prints characters on an IBM typewriter by means of a scanned keyboard or coded input. The AutoCom<sup>4</sup> is a relatively new device that is under development at the University of Wisconsin. It requires more hand control than do the scanning units, but offers a faster

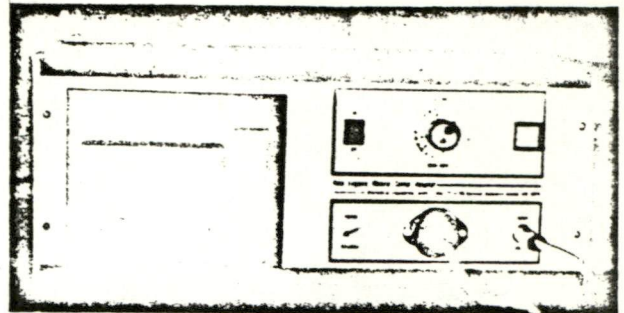

Rear View of the TIC

Figure 2

rate of output. There are a number of other devices that have also been well received by the clinical community. The Cybernetics Research Institute of Washington, D.C.<sup>5</sup> and Bush Electric Company of San Francisco<sup>6</sup> have probably produced the largest number of communicative assists. Only recently has Bush Electric Company suspended its involvement in this area. Their difficulties do not give encouragement to the possibilities of commercial success. This is by no means an attempt to survey the entire field. It is meant to put the TIC in its proper perspective. The B.M.E.C. does not operate in a vacuum, but makes all possible effort to maintain a thorough knowledge of the state of the art.

#### Chapter 766

The interest that has been generated in aiding the non-verbal population in Massachusetts can be related to recent legislation passed by the State Legislature. Chapter 766 was passed in July 1972, and became effective in September 1974. This addition to the laws of the Commonwealth guarantees every child the right to free and public education regardless of handicaps. The result of this has been an emphasis upon education rather than custodial care. New classrooms have been opened. State schools are being re-examined. A major effort is underway to provide the necessary facilities and equipment to implement the law. Since the severely handicapped have most often been neglected, they are being given considerable attention. Educators and clinicians are aware that they can not be totally effective without technical assistance, just as the B.M.E.C. is aware that it can not adequately demonstrate the usefulness of its equipment without input from those dealing

directly with the disabled individuals. Through the statewide effort to provide the best possible service, the cooperation between the three agencies has flourished.

### The Cooperative Project

The potential population involved in the project includes any person who lacks conventional communication skills (both spoken and written) due to a motor disability. These include cerebral palsy and traumatic brain injury. The B.M.E.C. staff for the project includes engineering, occupational therapy, and educational personnel. Candidates were first identified by their respective school systems and were referred to the State Department of Education. After an initial screening, a modified list was submitted to the B.M.E.C. whose staff members interviewed each candidate. From that list were chosen the eleven users. The decision was based upon the child's need for a TIC, his willingness to cooperate, and permission from his parents.

Once the initial commitments were made, each candidate was fitted with a custom designed switch. Since each child is afflicted in a different way, his switch must be personal. A training kit was then provided so that the user could master the operation of his switch while the construction of the TIC's proceeded. The training kit does not assume any particular intellectual development. It is designed to provide training in the physical movement necessary to operate the TIC. (It must be remembered that most of these children have never operated any electronic device, radio and television included.) The training procedure begins with very simple steps and progresses to a simulation of TIC operation using a manual scan keyboard and an instructor. Exercise material to be included is provided by the classroom teachers so as to insure compatibility with current educational experiences of the individual.

Originally, it was planned to deliver a TIC to a student once he had reached a level in the training where he could make use of it. However, difficulties in obtaining some of the components delayed shipment of all units until early March of 1975. As of this writing it is too early to assess the impact of the TIC upon the classroom. One teenager who was educated before a brain injury is now able to spell quite well and operate the TIC at the maximum scan rate. The opposite end of the range is a 7 year old cerebral palsy girl who has had no previous schooling and is just now learning the alphabet. Her problem is compounded by the noise and confusion of her classroom, which has a tendency to distract her. This will be improved with the arrival of a language specialist and a small acoustical partition.



R.H., 12 years old, is a severely involved spastic-athetoid, male child with basically spastic lower extremities, and an athetoid component in the upper extremities. He has some head control, but no meaningful speech. Physically, he has developed to a 6-month level. Intellectually, he has been tested by psychologists at Children's Hospital, Boston, and in language development by our Speech Therapists; and has been found to have intellectual development comparable to his chronological age. He is enrolled at the Special Educational Classroom at our Clinic and attends classes five days a week, five hours a day.

\*\*\*

J.P., 13 years old, is a severely involved basically athetoid, male child who has good sitting balance and head control, but no meaningful speech. Physically, he has reached the developmental level of 9 months. His intellectual level, although not adequately tested, is felt to be near his chronological age. He attends the Special Class at the Clinic five days a week, five hours a day.

Figure 3

The project will continue with both monitoring of the existing devices and provision of additional TIC's in later years. The Department of Education will retain ownership of the units through its "Resource Center for Devices of Exceptional Expense." The TIC's will, however, be on permanent loan to the users for as long as they remain in the state of Massachusetts and have need for them.

The cooperation has extended beyond the B.M.E.C. and the two state agencies. Each school system has committed time and effort to the project. In many cases the introduction of the TIC has brought about an increase in the interest shown in the user. More time of both teacher and specialist is being brought to bear on the child's problem.

#### The Future

The Biomedical Engineering Center is continuing to pursue the effective design and development of communication devices. The most recent prototypes have been an anticipatory communicator (described elsewhere in these Proceedings) and a battery-powered device. The battery-powered TIC is approximately one-third the size of the existing TIC; it can run for an excess of four hours without recharge.

Alternatives to the single switch input will be a two-switch system and a placemat-thin 56-switch keyboard. These will make the TIC a more versatile device suitable for use with various levels and types of disability. Optional outputs will be a video display, a page printer, and a voice synthesizer that produces spoken words. Other features currently being developed and evaluated include a built-in calculator, a "dictionary" mode, and dual speed scanning.

#### References

1. TIC Operating Manual. Tufts-New England Medical Center, Boston, Mass., 1975.
2. Personal Communication with Telephone Pioneers of America.
3. Demonstration by Miss Muriel Zimmerman, O.T.R. New York University Medical Center.
4. Vanderheiden, G., Lamers, D.F., Volk, A.M., Geisler, C.D.: "A new means of communication for the severely handicapped: the Auto-Monitoring Communication Board (AutoCom)." Proceedings of the Annual Meeting, Biomedical Engineering Society. 4, 15, 3 (Abstract) 1973.
5. Kafafian, H.: "Study of man-machine communication systems for the handicapped." Cybernetics Research Institute, 1970.
6. Personal Communication with Bush Electric Co.

# THE EFFECTIVENESS OF LANGUAGE REDUNDANCY IN NON-VERBAL COMMUNICATION

by

Richard A. Foulds, M.S.  
Gregory Baletsa, B.S.  
William J. Crochetiere, Ph.D.  
Biomedical Engineering Center  
Tufts-New England Medical Center  
Boston, Massachusetts

Summary - This paper describes investigations conducted at the Tufts-New England Medical Center in the use of the statistical nature of the English language as an aid to improving the communication speed of non-verbal individuals.

## Introduction

In recent years the communication difficulties of non-verbal severely motor impaired individuals have given rise to a number of electronic communication devices. The methods of operation vary according to the severity of the disability of the potential user. The Biomedical Engineering Center has concentrated its efforts on serving the very severely impaired through the development of the TIC. This requires only one controllable ON-OFF movement.

While the TIC has achieved considerable success in providing a communication medium to its users, we recognize that it has severe limitations in terms of the speed at which a person can type his output. This is not a problem for the developmentally disabled child who is initially learning to read and spell, in spite of his disability; but as the educational level of the user increases, he will be faced with long periods of time during which he will already know his desired letter, but must wait for the TIC to reach that letter. The need for a faster communicator, requiring no additional physical exertion, has become apparent.

In studying various types of communication we began to observe what circumstances would lead to a faster communication rate. It was then that we noted an incident that was extremely significant. An opportunity arose to communicate with an individual whose only means of "speaking" was through eye movements. His sister, having a great deal of rapport with her brother, scanned individual letters on a letter board. When she pointed to the letter he wished to communicate, he would signal her by looking up and to the

left. It was noticed that the sister would present a different order of characters throughout a somewhat labored conversation. It became clear that she was anticipating the next characters and even the remainder of the message with a high degree of success. In effect she was serving as an intelligent communication processor.

As a result of this experience, the question arose as to whether a machine could be built to perform this anticipatory function. Research was conducted into the statistical behavior of English. It was discovered that there is a great wealth of literature on the statistics of the language. Much of the work was done by cryptographers.

It is common knowledge that English does exhibit certain statistical properties. Samuel Morse sought to optimize his code by assigning the shorter, easier designations to the more frequently occurring characters. He visited a printer's shop to examine the type box. By counting the number of pieces of type for each character, he was able to approximate the rank order of characters used in English text. The rank order of characters varies from source to source, depending upon the sample text from which it was drawn. The order does, however, seem to fall into groupings. Within these, letters may change order, but rarely change groups. These are shown in Table 1.<sup>1</sup>

## Redundancy

The use of the statistical nature of English in improving communication speed is directly related to the amount of predictability evident in the language. If all letters were equally likely to occur there would be no opportunity to predict any particular letter other than by chance. The extent to which the characters are not equiprobable is a measure of the redundancy in the spelling of a language. In a case where there is no predictability beyond chance,

## Acknowledgement

This work is supported by SRS/DHEW Grant Numbers 16-P-56800/1-10 and 16-P-57856/1-01.

Group Characters Within Group

I	SPACE
II	E
III	T
IV	A,O,N,R,I,S
V	H
VI	D,L,F,C,M,U
VII	G,Y,P,W,B
VIII	V,K,X,J,Q,Z

2	3	4	5	6	7	8
3	4	5	6	7	8	
4	5	6	7	8		
5	6	7	8			
6	7	8				
7	8					

Groupings of the Rank Order of Occurrence of Letters in the English Language

TABLE 1

there is 0% redundancy. Continuing this approach to the rank order of characters, there is approximately 15% redundancy. By increasing the statistical knowledge, one can find that the language approaches 60% redundancy.<sup>2</sup>

Use of Rank Order in the TIC

The earliest model of the TIC featured an alphabetically arranged visual keyboard. This seemed appropriate since the academic world of the original client population was structured alphabetically. This offered extremely slow communication speeds.

The scanning method of the TIC favors certain entries on the visual keyboard. The keyboard locations are shown in Figure 1 with an "iterative value" assigned to them. An iterative value is a measure used by the BMEC to indicate the number of scanning steps or iterations (either vertical or horizontal) needed to reach a designated location. The upper left square of the keyboard, for example, has an iterative value of 2. This indicates that one iteration is required to offer the row, and a second iteration is needed to offer the square once the row is chosen. (Please refer to the previous paper for an explanation of the method of character selection on the TIC.) The positions with a value of 5 all require combinations of row-scans and position-scans which total to five.

From this analysis we recognize that the most easily accessible locations on the TIC are in the upper left of the keyboard. The loci of descending accessibility are diagonal lines located farther and farther from the upper left corner. By arranging the characters on the TIC according to rank order, the communication rate can be substantially improved. The final keyboard layout, arrived at in this manner, is shown in Figure 2.

Beyond Rank Order

The rank order of characters indicates some of the statistical behavior of the language. From our experience with the man and

Iterative Values of the TIC Visual Keyboard

Figure 1

SPACE	E	A	R	D	U	V
T	O	I	L	G	K	
N	S	F	Y	X		
H	C	P	J			
M	W	Q				
B	Z					

Arrangement of Characters on the TIC Visual Keyboard

Figure 2

his sister, we felt that by considering the frequency of occurrence of groups of letters rather than simply individual letters, the rate might be further increased. The literature describes such groupings as "n-grams." Individual letters are designated monograms; pairs of letters are digrams; and groups of three and four characters are described as trigrams and quadgrams, respectively.

We suggest a tabulation of n-grams based upon a 27-character alphabet (space plus A-Z). Since most cryptographers eliminate space from their codes, we found their n-gram tables unacceptable. Several months of correspondence led us to Dr. E. Newman at Harvard University who had compiled trigram and quadgram information during his research in the 1960's. Dr. Newman provided us with his data from which we extracted digram and monogram information.

The first task was to assure that the data we had available were truly representative of common written English. Newman's work had used a sample of 250,000 letters of text taken equally from the writings of E.B. White, Henry James, Saturday Review Magazine, and the Holy Bible. Our tests included evaluating much smaller samples of first-, third-, and sixth-grade texts, "Time Magazine" and the Encyclopaedia Britannica. Tests of the mean, variance, and the Student's "t" distribution indicated that in all likelihood our small samples were from the "normal" population (i.e. Newman's data). This told us that we could make predictions of the next most likely character within any reasonably common text using one standard data base.

In addition to deriving the monogram and digram data from Newman's tables, we rearranged the presentation of the information. Whereas the tabulated information would tell us that the trigram "ECH" occurred 48 times in the total text of 250,000 characters, we interpret this to mean that out of the 613 times the pair "EC" occurred, it was followed 48 times by "H". This then allowed us to derive the rank order of characters following any existing pair of characters and calculate the probabilities. An example of this is again the pair "EC" which has a rank order as follows:

"EC": T, E, O, A, I, H, U, K, L, R, C, D, S

It should be noticed that not all 27 characters are likely to follow the pair "EC". This is true of most trigrams. Table 3 indicates the theoretical number of possible letter combinations versus the number of actual combinations in our statistical tables.

	Theoretical Combinations	Actual Combinations
Monogram	$27^1$ 27	27
Digram	$27^2$ 729	520
Trigram	$27^3$ 19,683	5,000
Quadgram	$27^4$ 531,441	18,500

Combinations of Characters  
Both Theoretical and Actual

TABLE 2

Having established that there is a statistical behavior evident in the spelling of the language, we sought to demonstrate the usefulness of that feature. We have looked at the average probability of occurrence of each position in the 27 character string in monograms, digrams, and trigrams. The probabilities are shown in Figure 3.

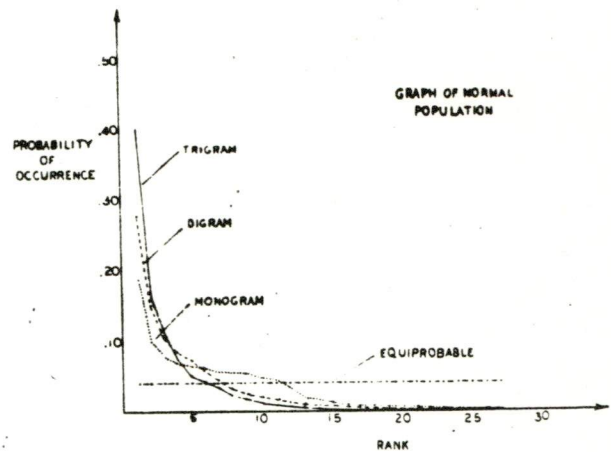

Probability vs. Rank Order of N-Grams

Figure 3

An illustrative example of the effect of probabilities upon the selection of characters is the case where the string of characters HAPPY has been selected and the user wishes to spell HAPPY. The "n-gram" strings are shown in Table 3 and the position of the "Y" is indicated.

The desired character keeps appearing earlier in the string as we progress toward higher-order tabulations beyond quadgrams. Estimates have been made that strings beyond the 16th-gram level offer little if any additional advantage.<sup>2</sup>

Preliminary tests have suggested that a fully-dynamic keyboard requires so much concentration and contributes to so many errors that this would not be a desirable method to use.

The most effective technique seems to be a compromise between the fully-dynamic and fully-static visual keyboards. We chose to offer only six dynamic elements in the

Monogram String

(SP) E T A O I N S D H R L U C F M W Y P G B V K X J Q Z  
18th

Digram String (Following "P")

E R O A L (SP) I U T P S H Y M W N F G  
13th

Trigram String (Following "PP")

E O R L Y A I S  
5th

Quadgram String (Following "APP")

E R L Y A O I  
4th

TABLE 3

six squares in the upper left of the keyboard. The entire alphabet would then be offered, in a fixed layout, on the remainder of the keyboard. Again using trigram information, the first six positions of the average rank order constitute 84% of the occurrences. We then have a communicator that will assign iterative values of 2, 3, or 4 to 84% of the characters typed. The order of the static part of the keyboard will not be the rank order of characters in English. We modified the trigram strings to eliminate the six most likely characters in each string; a tabulation was made to determine the rank order of characters remaining in all of the strings. This new rank order was found to be:

D,SPACE,M,C,O,L,U,B,F,N,H,E,R,  
G,S,W,A,Y,T,I,P,V,K,J,X,Q,Z

The entire 27 character alphabet will be included in the static portion of the keyboard in this order. Figure 4 shows the keyboard arrangement.

The Practical Implementation of Redundancy

The Biomedical Engineering Center has begun a project to simulate on a computer the various methods in which this information can be presented to a user. Presently five such methods are under study. One of these is a natural extension of the development of the TIC. If the TIC could remember the most recently typed letter, or letters, it could modify its visual keyboard to place the appropriate n-gram string along the diagonals referred to earlier.

A fully dynamic TIC with trigram information was simulated, and the ideal, error-free rate of communication was computed. This is compared to the static monogram TIC:

Trigram TIC:  
3.1 iterations/character

Monogram (standard) TIC:  
4.5 iterations/character

This is a sizable improvement when one considers that the fastest possible rate would be 2 iterations/character. (Each of the two switch closures requires one iteration.) The difficulty that arises with this

arrangement is that a fully-dynamic visual keyboard--in which the arrangement of letters on the keyboard changes each time a letter is printed--can be very confusing to the user.



"d" - Indicates DYNAMIC ELEMENT

Keyboard Arrangement for a Partially Dynamic TIC

Figure 4

The ideal rate of communication was again calculated and was found to be 3.3 iterations/character. This is very near to the value for a fully-dynamic communicator.

An explanation for this can be found by plotting (Figure 5) the probabilities of occurrence of the average rank positions 1-27 in the fully-dynamic keyboard versus those of 1-6 (dynamic) and 7-33 (static) of the partially-dynamic arrangement. The first six positions will be identical. The remainder of the graph shows surprising similarity in probability between the dynamic and static positions. After the sixth position the probability tables offer very little.

## Conclusion

We have shown that by taking advantage of the redundancy within English spelling, we can predict (with accuracy beyond that of chance) the characters most likely to follow known characters. The improvement in ideal communication rate is on the order of 50% of the maximum possible gain. Our prototype communicator will be fully evaluated to determine how this ideal rate is affected by human interaction.

## References

1. Pratt, F.: Secret and Urgent. Bobbs-Merrill Co., 1939.
2. Edwards, E.: Information Transmission. Chapman and Hall, London, 1969.
3. Crochetiere, W., Foulds, R., Sterne, R.: Computer Aided Motor Communication. Proceedings of the 1974 Conference on Engineering Devices in Rehabilitation, Boston, Mass., 1974.

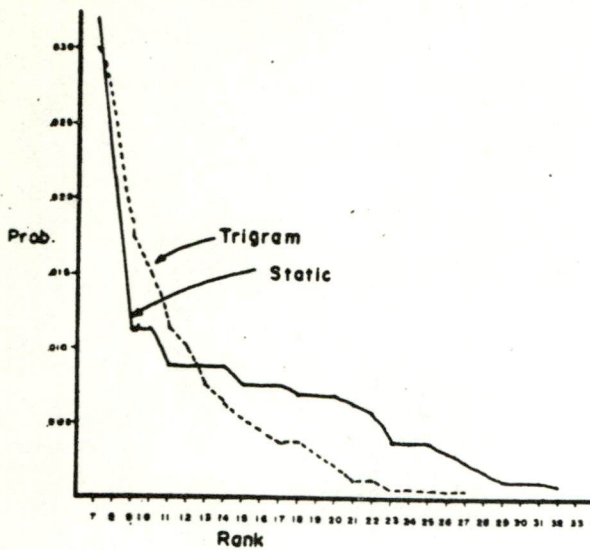

Probability vs. Rank Order for  
Trigram and Modified Trigram Data

Figure 5

# THE TUFTS NON-VOCAL COMMUNICATION PROGRAM

by

Richard A. Foulds            Gregory Baletsa  
William J. Crochetiere\*    Chester Meyer  
Biomedical Engineering Center  
Tufts-New England Medical Center  
Boston, Massachusetts

Summary: This paper describes the efforts of the Biomedical Engineering Center in conducting both research and applied studies in the area of non-vocal communication for the severely physically disabled.

## Introduction

The application of technology to the field of Rehabilitation Medicine has offered the promise of restoring or assisting physical functioning of a severely physically disabled person. A major area of concentration of the Biomedical Engineering Center has been that population which is prevented from normal communication because of a profound motor dysfunction. The lack of speech and writing skills due to muscle incoordination, weakness, or paralysis is evident in disorders such as cerebral palsy, ALS, traumatic head injury, and stroke. While each of these is medically different, the resultant absence of communication is commonly devastating in terms of the person's social, educational, and vocational life.

The Biomedical Engineering Center (BMEC) has staffed its non-vocal communication project with three engineers, an occupational therapist, and a special educator. The goals of the project are to identify technological means of assisting a person to better communicate, and work within the community in the application of assistive devices.

At the present time, the BMEC is under contract to the Massachusetts Bureau of Special Education to work with special needs programs throughout the state providing this type of technical support. As of this writing, twenty-two special education classrooms have been equipped with electronic devices developed by the BMEC. At the same time, the BMEC is working with other agencies and institutions in examining the communication needs of other disabled individuals. Older people who may have been educated before an accident or the onset of a disease do not require educational support, but may require a faster, more powerful device than would a child who is disabled from birth and is learning language in spite of his disability.

A very difficult situation is the older cerebral palsied person who may have been entirely missed by the educational system. He may be extremely intelligent while lacking the formal language skills necessary for effective use of an assistive device.

In order to meet the needs of a varied population, the BMEC has begun to develop a series of

\*Associate Professor of Engineering Design  
Tufts University Medford, Massachusetts

communication devices that span the entire range of communication possibilities. This effort will hopefully give the individual a choice of which machine (if any) he wishes to use. The remainder of this paper describes the developments of this program.

## The TIC and Related Devices

The Tufts Interactive Communicator<sup>1</sup> (TIC) has been designed as a single switch input typing device that can be operated by a single grossly controllable muscular movement. The need for such an easily operable unit was identified early in the project. While many non-vocal individuals can operate more complex interfaces, the single switch feature finds extensive use with the most severely disabled. The user selects the characters from a visual keyboard that offers rows of characters by successive illumination. A single switch closure chooses the illuminated row, and commands the TIC to scan the characters in that row. A second switch closure chooses a single illuminated character. Once selected, the letter or number is printed on a hardcopy medium, and is displayed electronically. In this way messages are constructed on a letter-by-letter basis.

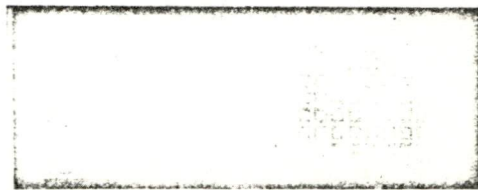

Front Panel of the TIC  
Fig. 1

The TIC that is now in use differs only slightly from that which was developed over 5 years ago. The method of letter selection has proven to be effective and hence is unaltered. The visual keyboard has been rearranged to take advantage of

the rank order of characters in the English language. This represents an approximate 30% speed improvement over an alphabetically-ordered visual keyboard.

Recent developments in low power electronics have offered the potential for battery operation of the TIC. Since funding for redesign of this device was not readily available, the program staff proceeded cautiously, looking for an appropriate time for a design change.

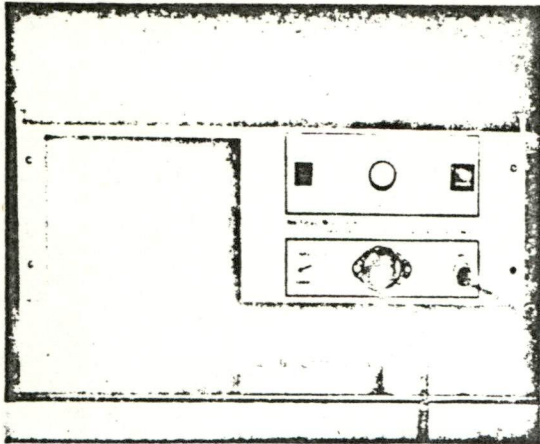

Rear Panel of the TIC  
Fig. 2

The current equipment modifications are actually taking place in two directions. The present TIC offers a 32-character electronic display, and a paper strip printer. These functions are being transferred into a smaller, portable unit with an operating life of eight hours before recharging is necessary. The existing TIC, for which a large price has been paid for tooling development, will simultaneously be upgraded into a more powerful communication tool. This device will offer a complete video display that can be edited and modified by the user. The corrected text can then be "dumped" onto a typed page. This will hopefully provide the flexibility required for academic and vocational activities.

#### The Dictionary

Each person who communicates either through written or spoken language tends to use a vocabulary that is smaller than that actually at his disposal<sup>2</sup>. This may be evident in conversational idioms, or in key words or phrases (i.e. jargon) of a geographical location, or business environment. Part of the Non-Vocal Communication Program's activities has been to identify ways of shortening the user's time involved in transmitting a message. The method chosen has been to incorporate a dictionary of 400 words or phrases that can be custom programmed into a personalized TIC. The new circuit card can accommodate 4 increments of 1000 letters. Therefore the complete dictionary will consist of no more than 400 entries whose total length is no longer than 4000 letters. While this provides an average of 10 characters per entry, the actual word or phrase lengths will be independently set.

The selection of such a large number of entries offered a challenge in the design of a

visual keyboard. The magnitude of a 456 entry keyboard (400 words + the standard TIC keyboard) would prevent efficient use due to long scanning times. An encoded method was determined to be the desirable approach. The bottom row of the TIC keyboard is designated with the numbers one through eight, indicating dictionary page numbers. Each character of the existing keyboard will represent a different word on each page. Selection of a word is accomplished by first choosing a page number, and then the appropriate keyboard character. The desired word will be taken from the dictionary memory and displayed on the output device.

#### Anticipatory Communication<sup>3</sup>

An important consideration in the application of a communication device is the speed with which its operator can make an output. The rate of output is limited by both the user's input time response, and the size of the scanned visual keyboard. Although the vocabulary and verbal skills of the user are expected to improve with training, the physical input cannot be expected to do the same. Disabilities such as cerebral palsy do not generally change dramatically and will most likely require the user to use the same grossly controlled input motion for his lifetime. ALS is a progressive disease and will result in a loss of motor control over time.

As can be understood from above, the easy solution of "speeding up" the scan rate is impractical. Improvement cannot be found in reducing the keyboard size since the TIC keyboard contains essential entries for alphabetic and numeric output as well as punctuation and arithmetic symbols.

A major effort of the BMEC has been to study the application of language redundancy to this rate problem. Results of the project have shown a theoretical improvement of approximately 50% over the standard TIC. Present studies are focusing on the display techniques that will maintain this level of improvement when the device is used by a human operator.

Based upon knowing no prior characters  $p=.19$   
Based upon knowing 1 prior character  $p=.28$   
Based upon knowing 2 prior characters  $p=.40$   
Based upon knowing 3 prior characters  $p=.51$

Probability of Correctly Predicting  
the next Character to be Typed

#### Fig. 3

The current state of the research has yielded a prototype device appropriately named the ANTIC (Anticipatory TIC) which predicts the six most likely letters to follow the letter most recently chosen. This prototype is being studied with the assistance of a high-level spinal cord injured client who is providing valuable information on its acceptability as a working design. In order to reach the 50% improvement, the statistics on letter frequency will be based not upon the single prior choice, but upon the three previous selections.

#### Symbol Communication

All of the above devices require that the user have the ability to spell, or at least

recognize words from the dictionary. Within the Non-Vocal Communication Project there has been identified the need for a less sophisticated device that will identify locations rather than character symbols. The solution to this need has been a small relatively inexpensive device that offers the user the choice of eight or 48 squares. Filling these squares will be symbols, letters, or pictures attached to small plastic clips. The same type of switch as is used in the TIC or ANTIC can stop the scanning at a particular symbol and cause the light to flash as an indication of choice. The Symbol TIC or SYMTIC scans the eight squares in a linear fashion, or scans the 48 in a row-column manner. There is no printout provided in the unit. The SYMTIC is envisioned as a teaching tool for early intervention with non-readers and can be used with various teaching systems such as the Peabody Rebus Reading Program<sup>4</sup>, or the alternative language programs like the Bliss Symbolics.<sup>5</sup>

### Symbol Printing

The principal difficulty encountered with the SYMTIC is its lack of a printed output. This prevents the user from communicating independently since his listener must remain within viewing distance.

The BMEC is trying to rectify this situation by developing a printing unit that will reproduce graphic symbols. The Cryptographic TIC or CRYPTIC will initially be programmed for use with the Bliss Symbols and will be assigned to the Vermont Achievement Center in Rutland, Vermont.

### Electronic Letterboard

The devices described throughout this paper have been operated by a single input switch. Many non-vocal individuals are capable of greater interaction with a machine. Letterboards have been commonly used by those clients who have some residual pointing ability or the use of a headpointer. Letterboards<sup>6</sup> have the advantage of being inexpensive and entirely flexible since they are only paper on which a teacher or clinician writes words and letters, or draws pictures. The locations of these objects can be determined according to the physical abilities of the user. Midline crossing problems, hand preference, or varying dexterity can be minimized by the proper placement of the symbols.

Electronic conversion of these letterboards has not been able to offer the same flexibility. The use of mechanical switches and sensors presents physical limitations that prohibit total flexibility. Expanded typewriter keyboards offer a fixed arrangement that may often be unsatisfactory to a user. Varying the size of that keyboard or even changing the size of the switches becomes a major mechanical task. The Autocom<sup>7</sup> from the University of Wisconsin offers an attempt at flexibility with several optional arrangements of the magnetic proximity switches.

The BMEC has contracted with the Flex Key Corporation of Gloucester, Massachusetts for the fabrication of a flat switch panel that measures 22" x 15" and contains 4000 switch contacts arranged in a honeycombed grid. The Flex Key Corp. has graciously donated the engineering time required in the design of the switch panel.

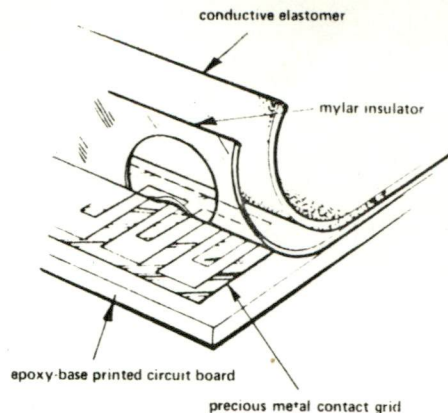

Elastomeric Switch Structure  
Fig. 4

The switching mechanism is a proprietary process owned by Flex Key<sup>8</sup> and utilizes the properties of a conductive elastomer. The entire panel consists of a large printed circuit card and a layer of elastomer separated by a mylar insulator. The entire panel is approximately 1/8" thick.

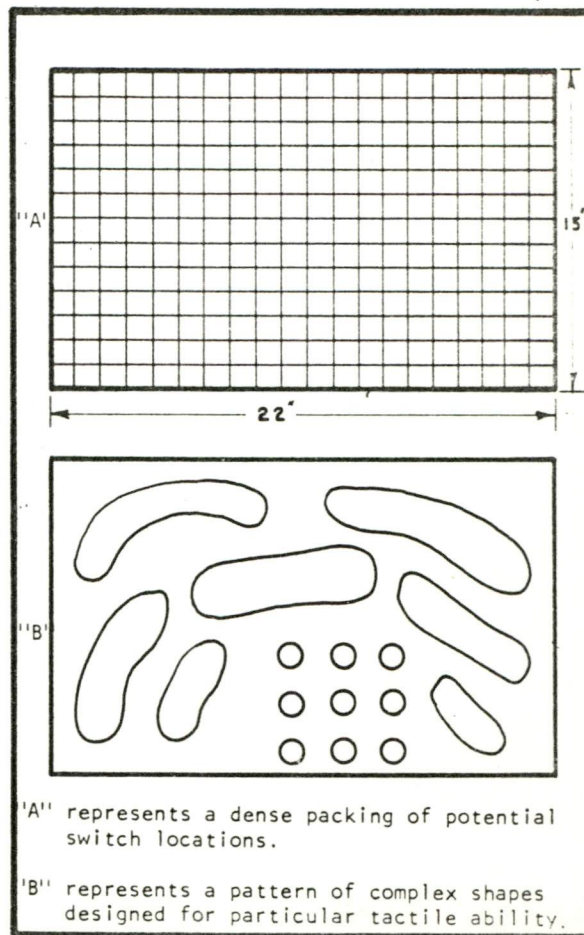

'A' represents a dense packing of potential switch locations.

'B' represents a pattern of complex shapes designed for particular tactile ability.

Samples of Complex and Custom Tactile Communicator Layout

Fig. 5

## References

1. Foulds, R.A., Gaddis, E.: "The Practical Application of an Electronic Communication Device in the Special Needs Classroom", Proceedings of the Conference on Devices and Systems for the Disabled, Krusen Center for Research and Engineering, Philadelphia, Pennsylvania. 1975, pp. 77-80.
2. Miller, G., Language and Communication, McGraw-Hill Co. c 1951, 63.
3. Foulds, R.A., Baletsa, G., Crochetiere, W.J.: "The Effectiveness of Language Redundancy in Non-Verbal Communication", Proceedings of the Conference on Devices and Systems for the Disabled, Krusen Center for Research and Engineering, Philadelphia, Pennsylvania. 1975, pp. 82-86.
4. Woodcock, R., "The Learning Disabled and the Peabody Rebus Reading Program", A Paper presented at the Annual Convention for the Council for Exceptional Children, Chicago, Illinois. April 1970.
5. Teaching Guideline - Symbol Communication Research Project, Ontario Crippled Children's Centre. Toronto, Ontario. 1974.
6. Vicker, B., Nonoral Communication System Project, University Hospital School, The University of Iowa, Iowa City, Iowa. c 1974.
7. Participant Resource Book, 1975 National Workshops on Non-Vocal Communication Techniques and Aids, The University of Wisconsin, c 1975.
8. Flex Key Brochure 10-73-FK-5K  
Flex Key Corporation, Gloucester, Massachusetts.

The switch contacts are .25" in diameter on .30 inch centers. Assuming that the smallest object pointing to the panel will be a human finger, at least one of the switches will be closed when the panel is touched. Once the switch closure is made, the X and Y coordinates of the contact will be detected by external circuitry. The force required to register an input is less than 10 ounces. The switch movement is .005 inches.

That external circuitry is now being developed and will allow the teacher or clinician to define clusters of switches as words or letters. In this way a totally flexible letterboard surface may be custom designed to meet the user's needs. The logic circuitry will identify the appropriate input and operate the same type of printing devices as are already in use in the TIC.



Tufts Interactive Communicator in Clinical Setting  
Fig. 6

### Technology Utilization Project

The Biomedical Engineering Center has felt an obligation to make available the results of its research and development. This has already been evident in the project within the State of Massachusetts. Other devices have also been made available to individuals and institutions for use in their own programs. The BMEC tries to maintain contact with these sites and provide any possible assistance. All devices have been offered as a service of Tufts-New England Medical Center and are made available on a non-profit basis.

### Acknowledgement

This work has been supported by HEW Rehabilitation Services Administration Grant 16-P-57856/1-01 and a Contract with the Massachusetts Department of Education.