

United States Department of the Interior
National Park Service



919

National Register of Historic Places Registration Form

This form is for use in nominating or requesting determinations for individual properties and districts. See instructions in National Register Bulletin, *How to Complete the National Register of Historic Places Registration Form*. If any item does not apply to the property being documented, enter "N/A" for "not applicable." For functions, architectural classification, materials, and areas of significance, enter only categories and subcategories from the instructions. Place additional certification comments, entries, and narrative items on continuation sheets if needed (NPS Form 10-900a).

1. Name of Property

historic name Masefau
other names/site number Masefau Beach (AS-23-064), Sua County, Tutuila Island, American Samoa; Sites TF 27 and TF28 (from Kennedy et al., 2005); and American Samoa LUPA # 12-1133-L, from Project Notification Review System (PNRS) in 2012.

2. Location

street & number Masefau Beach not for publication
city or town Masefau vicinity of Masefau
State American Samoa code AS county Sua code 001 zip code 96799

3. State/Federal Agency Certification

As the designated authority under the National Historic Preservation Act, as amended,
I hereby certify that this nomination ___ request for determination of eligibility meets the documentation standards for registering properties in the National Register of Historic Places and meets the procedural and professional requirements set forth in 36 CFR Part 60.
In my opinion, the property meets ___ does not meet the National Register Criteria. I recommend that this property be considered significant at the following level(s) of significance:

national statewide local

David J. Hendrich, SHPO 9/18/2012
Signature of certifying official/Title Date

State or Federal agency/bureau or Tribal Government

In my opinion, the property ___ meets ___ does not meet the National Register criteria.

Signature of commenting official Date

Title State or Federal agency/bureau or Tribal Government

Masefau Beach, Eastern Tutuila
 Name of Property

Sua,
American Samoa
 County and State

4. National Park Service Certification

I hereby certify that this property is:

- entered in the National Register determined eligible for the National Register
 determined not eligible for the National Register removed from the National Register
 other (explain: _____)

[Signature]
 Signature of the Keeper

11/14/2012
 Date of Action

5. Classification

Ownership of Property

(Check as many boxes as apply.)

- Private
 public - Local
 public - State
 public - Federal

Category of Property

(Check only one box.)

- building(s)
 District
 Site
 Structure
 Object

Number of Resources within Property

(Do not include previously listed resources in the count.)

Contributing	Noncontributing	
		Buildings
1		Sites
2		Structures
		Objects
3		Total

Name of related multiple property listing

(Enter "N/A" if property is not part of a multiple property listing)

N/A

Number of contributing resources previously listed in the National Register

N/A

6. Function or Use

Historic Functions

(Enter categories from instructions.)

DEFENSE / fortification

Current Functions

(Enter categories from instructions.)

VACANT/NOT IN USE

Masefau Beach, Eastern Tutuila
Name of Property

Sua,
American Samoa
County and State

7. Description

Architectural Classification

(Enter categories from instructions.)

MID 20TH CENTURY AMERICAN

Other: World War II Fortification

Materials

(Enter categories from instructions.)

foundation: CONCRETE, METAL

walls: CONCRETE, METAL

roof: CONCRETE, METAL

other: _____

Narrative Description

(Describe the historic and current physical appearance of the property. Explain contributing and noncontributing resources if necessary. Begin with a **summary paragraph** that briefly describes the general characteristics of the property, such as its location, setting, size, and significant features.)

Summary Paragraph

The Masefau Site is located along the coast at the village of Masefau in eastern Tutuila, the largest island in American Samoa. The site is associated with two features comprising octagonal, domed-top pillboxes with gun-slits similar to two-tiered pillboxes found throughout Tutuila (Kennedy et al., 2005: 130, Figure 110). The fortifications at Masefau were impacted by a tsunami, which revealed the base of these structures. The exposure of the foundations of these structures add to our knowledge of World War II fortifications. Previously, Kennedy advocated that a separate compartment was attached to these pillbox types for primarily ammunition storage (*Ibid.*, Kennedy et al., 2005). The Masefau fortifications exhibit no attached structures and are stand-alone units with a rearward entrance at the base of the pillboxes. The lack of separate compartments at the base of the structures at Masefau on the northeast of Tutuila contrasts with the presence of additional components on pillboxes in the west of the island such as found at Maloata (Kennedy et al., 2005: 120). This dichotomy may indicate differing tactical strategies by the U.S. Marines and Navy in preparing the defenses of Tutuila for a Japanese invasion during World War II.

Narrative Description

The Masefau Site (AS-23-064) comprises two defensive fortifications constructed during World War II. The site is located along the coast at the village of Masefau in eastern Tutuila, the largest island in American Samoa.

The expanse of the site is located between 8423650 N, 540245 E and 8423980 N, 539715 E using WGS-84, NAD 83, Zone 2L and measures approximately 40 meters north/south and around 830 meters east/west at an elevation between one to three meters above sea level.

The features at the Masefau Site are from World War II and both comprise a "round, domed top pillbox with gunslit", a term established by Kennedy (*et al.*, 2005: 130, Figure 110). However, the Masefau constructions are different from the standard, round, two-tiered pillbox and comprise non-tiered octagonal structures.

The two defensive fortifications at Masefau feature an approximately 174 cm wide and 29 cm high aperture for crew served weapons and rifles with walls measuring 22 cm in width. The construction material comprises concrete mixed with crushed aggregate made from local fine grain basalt and reinforced by iron beams. The bases of both structures are 209 cm in length and possess a small avenue of ingress and egress measuring 86 cm in height by 58 cm in width. From the base, both constructions are approximately 230 cm high and 200 cm wide. However, the interior of the structures are 142 cm wide and 207 cm in height.

Masefau Beach, Eastern Tutuila
Name of Property

Sua,
American Samoa
County and State

The Masefau site is located on the coast in coarse granular sand with no adjacent vegetation.

The exposure of the defensive fortifications at Masefau reveals the range of building plans in Marine Corps and Navy defensive structures during World War II, particularly variations in the most prevalent domed-top pillbox design.

Masefau Beach, Eastern Tutuila
Name of Property

Sua,
American Samoa
County and State

8. Statement of Significance

Applicable National Register Criteria

(Mark "x" in one or more boxes for the criteria qualifying the property for National Register listing.)

- A Property is associated with events that have made a significant contribution to the broad patterns of our history.
- B Property is associated with the lives of persons significant in our past.
- C Property embodies the distinctive characteristics of a type, period, or method of construction or represents the work of a master, or possesses high artistic values, or represents a significant and distinguishable entity whose components lack individual distinction.
- D Property has yielded, or is likely to yield, information important in prehistory or history.

Criteria Considerations

(Mark "x" in all the boxes that apply.)

Property is:

- A Owned by a religious institution or used for religious purposes.
- B removed from its original location.
- C a birthplace or grave.
- D a cemetery.
- E a reconstructed building, object, or structure.
- F a commemorative property.
- G less than 50 years old or achieving significance within the past 50 years.

Period of Significance (justification)

Masefau comprises exposed World War II fortifications in American Samoa that exhibit a heretofore unknown variation in building designs of the most prevalent American pillbox structures in the South Pacific.

Areas of Significance

(Enter categories from instructions.)

MILITARY

Period of Significance

World War II

Significant Dates

1941 – 1945

Significant Person

(Complete only if Criterion B is marked above.)

Cultural Affiliation

Euro-American

Architect/Builder

United States Marine Corps, Utah Construction

Masefau Beach, Eastern Tutuila
Name of Property

Sua,
American Samoa
County and State

Criteria Considerations (explanation, if necessary)

Masefau reveals a range of building designs in the most popular American defensive structures in Tutuila constructed during World War II. Although the defensive fortifications were impacted by a tsunami in 2009, their locations were not significantly modified. In addition, the Masefau structures retain a proximity to their original locales, their architectural value elucidates a range of previously undocumented martial fortifications, and these mostly intact concrete structures derive from an important historical event (World War II). Moreover, the pillboxes continue to evidence the relationship of the properties with their former surroundings, as the initial line of defense along the coast, built to resist an amphibious invasion by Japanese forces. Furthermore, the constructions were moved well after their period of significance by the tsunami of September, 2009, that impacted the entirety of the Tutuila Island.

Statement of Significance Summary Paragraph (Provide a summary paragraph that includes level of significance and applicable criteria.)

Masefau is an apt site for inclusion to the National Register of Historic Places. Reasons justifying this proposed addition to the National Register include that it qualifies under evaluations for three criteria of significance (A, C, and D). The Masefau Site exhibits unique architectural characteristics of defensive fortifications constructed during World War II and is associated with events that have made a significant contribution to the broad pattern of history. The structures at Masefau elucidate new data regarding the range of architectural traits regarding World War II defensive fortifications in American Samoa. The inclusion of Masefau to the Nation Register is warranted due to its research potential concerning the differing architectural components at Masefau and defensive preparations by the United States, on Tutuila and in the Pacific, during World War II.

Narrative Statement of Significance (Provide at least **one** paragraph for each area of significance.)

The Masefau Site satisfies **Criteria A** because it is associated with events that have made a significant contribution to the broad pattern of history. For example, a [U.S.] Marine Defense Facilities map, from November 18, 1941, indicates that Masefau was provisioned with three pound and thirty caliber ammunition (see Continuation Sheet, p. 3). The Site exhibits unique architectural characteristics of defensive fortifications constructed during World War II, being part of the defensive network of American Samoa.

The Masefau Site satisfies **Criteria C** because the structures at this site display new information and distinctive characteristics concerning World War II defensive fortifications in American Samoa. The Masefau pillboxes indicate that the U.S. armed forces built a series of stand-alone coastal fortifications, without attached ancillary rooms for ammunition, with foundations not exceeding 209 cm in length that were established in sand along the coast.

The Masefau Site satisfies **Criteria D** because of its research potential. The first large contingent of U.S. Marines, the 7th Defensive Battalion, landed in Tutuila on March 1, 1941 (Burke 1945b: 25). After securing the island and digging temporary fighting positions, the Marines built and emplaced concrete pillboxes on the coasts. The Battalion completed this directive in May of 1941 (Denfeld 1988: 57). The architectural components at Masefau exhibit new data concerning defensive preparations on Tutuila and in the Pacific.

Developmental history/additional historic context information (if appropriate)

In the months following the Japanese attack on Pearl Harbor on December 7, 1941, the American war effort in the Pacific focused on the defense of American Samoa, which provided a logistical link between America and its allies in Australia and New Zealand.

Masefau Beach, Eastern Tutuila
Name of Property

Sua,
American Samoa
County and State

9. Major Bibliographical References

Bibliography (Cite the books, articles, and other sources used in preparing this form.)

- Anonymous. 1942. *Report of Inspection of Tutuila by a Board of Officers Representing the Navy Department, Rear Admiral Richard E. Byrd, Senior Member.*
- Anonymous. 1945. *History of the First Samoan Battalion, United States Marine Corps Reserve.* (Located in ASHPO).
- Anonymous. 1947. *History of the First Samoan Battalion, United States Marine Corps Reserve.* (Located in ASHPO).
- Anonymous. 1947. *Building the Navy's Bases in World War II: History of Bureau of Yards and Dock and Civil Engineer Corps 1940-1946, Volume II.* Washington, D.C.: United States Government Printing Office. (Located in ASHPO).
- Anonymous. Undated. *From Samoan Navy History.* (Located in ASHPO).
- Bates, Cecil R. (1st Sgt, USMC). 1940. The Fita-Fita Guard. *Leatherneck*, October.
- Burke, J. (Lt. Cmdr, USNR). 1945a. *The United States Naval History of the Samoan Defense Group. Document 386.* Pago Pago, American Samoa: Headquarters, South Pacific Area and Force.
- Burke, J. (Lt. Cmdr, USNR). 1945b. *The United States Naval History of Tutuila, American Samoa. Document 387.* Pago Pago, American Samoa: Headquarters, South Pacific Area and Force.
- Burke, J. (Lt. Cmdr, USNR). 1945c. *The United States Naval History of Western Samoa. Document 388.* Pago Pago, American Samoa: Headquarters, South Pacific Area and Force.
- Caldwell, K. 2006. *9th Regional Readiness Command Properties in American Samoa – Te'o United States Army Reserve, U.S. Army Integrated Cultural Resources Management Plan, First Five Year Update.* Honolulu, HI: 9th Regional Readiness Command.
- Coletta, P.E. (ed.). 1985. *United States Navy and Marine Corps Bases Overseas.* Westport, CT: Greenwood Press
- Condit, K.W., G. Diamond and E.T. Turnbladh. 1956. *Marine Corps Ground Training in World War II. Historical Branch, G-3, Headquarters, United States Marine Corps.* Washington, D.C.: U.S. Government Printing Office.
- Darden, T.F. (Capt., USN). 1952. *Historical Sketch of the Naval Administration of the Government of American Samoa: April 17, 1900-July 1, 1951.* Washington, D.C.: U.S. Government Printing Office.
- Denfeld, C. 1988. *American Samoa: From Coaling Station to World War II Outpost.* (Located in ASHPO).
- Denfeld, D.C. 1986. Fort Mears was no Second Pearl Harbor! *Periodical: Journal of the Council on America's Military Past* 14(1):3-12.
- Denfeld, D.C. 1984. Korean Laborers in Micronesia During World War II. *Korean Observer* 3-15.
- Gray, J.A.C. (Capt., USN) 1960. *Amerika Samoa: A History of American Samoa and Its United States Naval Administration.* Maryland, Annapolis: United States Naval Institute.
- Hough, F.O. (Lt. Col.), V.E. Ludwig (Maj) and H.I. Shaw, Jr. 1958. *History of U.S. Marine Corps Operations in World War II. Volume I: Pearl Harbor to Guadalcanal. Historical Branch, G-3; Headquarters, United States Marine Corps.* Washington, D.C.: U.S. Government Printing Office.
- Hudson, J.C. and K.G. Hudson. 1994. *American Samoa in World War II.* Seabrook, Texas: Cultural Resource Services.

Masefau Beach, Eastern Tutuila
Name of Property

Sua,
American Samoa
County and State

Kennedy, J. 1985. *A Report Concerning Defense Environmental Restoration Program (DERP) Investigations in American Samoa*. Haleiwa, Hawaii: Archaeological Consultants of Hawaii.

Kennedy, J. 2000. *The Early History of Roads in Amerika Samoa*. Haleiwa, Hawaii: Archaeological Consultants of Hawaii. (Located in ASHPO).

Kennedy, J., A. Bevan, and M. Elmore. 2005. *Results of an Archaeological Survey and Archival Research of WWII Coastal Defenses on Tutuila Island, American Samoa*. Haleiwa, Hawaii: Archaeological Consultants of the Pacific, Inc.

Kennedy, J., A. Amira, S. Ireland, C. Liebhardt, and E. Yoshifuku. 2010. *An Archaeological Phase I Inventory Level Survey For The Fagatogo/Utulei Ridge Project Area, Ma'Oputasi County, Island of Tutuila, American Samoa, Volume I*. Haleiwa, Hawaii: Archaeological Consultants of the Pacific, Inc.

Kennedy, J., A. Amira, S. Ireland, C. Liebhardt, and E. Yoshifuku. 2010. *An Archaeological Phase I Inventory Level Survey For The Fagatogo/Utulei Ridge Project Area, Ma'Oputasi County, Island of Tutuila, American Samoa, Volume II*. Haleiwa, Hawaii: Archaeological Consultants of the Pacific, Inc.

Mead, M. 1969. *Social Organization of Manu'a, Bernice P. Bishop Museum Bulletin 76*. Honolulu, Hawaii: Bernice P. Bishop Museum.

Metzger, L. (Lt. Gen. USMC). 1982. Duty Beyond the Seas. *Marine Corps Gazette* 66(1):28-37.

Midkiff, F.E. 1956. Frederic Duclos Barstow Foundation for American Samoan. (Located in ASHPO).

Parsons, R.P. (Capt., USN). 1945. *MOB 3: A Naval Hospital in the South Sea Jungle*. Indianapolis: Bobb-Merrill.

Quinn, L.M. 1919. America's South Sea Soldiers. *National Geographic* 36(3)266-274.

Rasnick, P.N. 1942. My Buddies in the Service. (Located in ASHPO).

Sherrod, R. 1952. *History of Marine Corps Aviation in World War II*. Washington, D.C.: Combat Forces Press.

Thompson, E.N. 1987. *Sailors and Satraps in Samoa: U.S. Naval Station Tutuila, American Samoa, 1900-1951*. (Located in ASHPO).

Thompson, E.N. 1988. *U.S. Naval Station Tutuila*. National Register of Historic Places Nomination Form for the U.S. Naval Station Tutuila Historic District.

U.S. Navy. 1947. *Bureau of Yards and Docks. Building the Navy's Bases in World War II: History of the Bureau of Yards and Docks and the Civil Engineer Corps, 1940-46. Volumes 1-2*. Washington, D.C.: U.S. Government Printing Office.

Woodbury, D.O. 1946. *Builders for Battle: How the Pacific Naval Air Bases Were Constructed*. New York: E.P. Dutton.

Previous documentation on file (NPS):

- preliminary determination of individual listing (36 CFR 67 has been requested)
- previously listed in the National Register
- previously determined eligible by the National Register
- designated a National Historic Landmark
- recorded by Historic American Buildings Survey # _____
- recorded by Historic American Engineering Record # _____
- recorded by Historic American Landscape Survey # _____

Primary location of additional data:

- State Historic Preservation Office
 - Other State agency
 - Federal agency
 - Local government
 - University
 - Other
- Name of repository: _____

Historic Resources Survey Number (if assigned): AS-23-064

Masefau Beach, Eastern Tutuila
Name of Property

Sua,
American Samoa
County and State

10. Geographical Data

Acreage of Property 4.02 acres
(Do not include previously listed resource acreage.)

UTM References

(Place additional UTM references on a continuation sheet.)

1	<u>2L</u>	<u>540245</u>	<u>8423650</u>	2	<u>2L</u>	<u>539715</u>	<u>8423980</u>
	Zone	Easting	Northing		Zone	Easting	Northing

Verbal Boundary Description (Describe the boundaries of the property.)

The site comprising two (2) structures, which span an area of approximately 40 meters N/S and 830 meters E-W along Masefau Beach.

Boundary Justification (Explain why the boundaries were selected.)

Acreage incorporates defensive fortifications from World War II.

11. Form Prepared By

name/title Dr. Joel D. Klenck, Principal Investigator & Territorial Archaeologist
Organization American Samoa Historic Preservation Office / PRC, Inc. Date September 18, 2012
street & number 6800 Bird Road, #381 telephone (786) 277-4844
city or town Miami, FL 33155 state Am. Samoa zip code 96799
e-mail jklenck@paleorc.com

Additional Documentation

Submit the following items with the completed form:

- **Maps:** A **USGS map** (7.5 or 15 minute series) indicating the property's location.
A **Sketch map** for historic districts and properties having large acreage or numerous resources. Key all photographs to this map.
- **Continuation Sheets:** (See attached Continuation Sheets).
- **Additional items:** (Check with the SHPO or FPO for any additional items).

Photographs:

Submit clear and descriptive photographs. The size of each image must be 1600x1200 pixels at 300 ppi (pixels per inch) or larger. Key all photographs to the sketch map.

Name of Property: Masefau Beach

**United States Department of the Interior
National Park Service**

**NATIONAL REGISTER OF HISTORIC PLACES
CONTINUATION SHEET**

Section 10 Page 1

**Masefau Defensive Fortifications
American Samoa**

=====
Site Map.

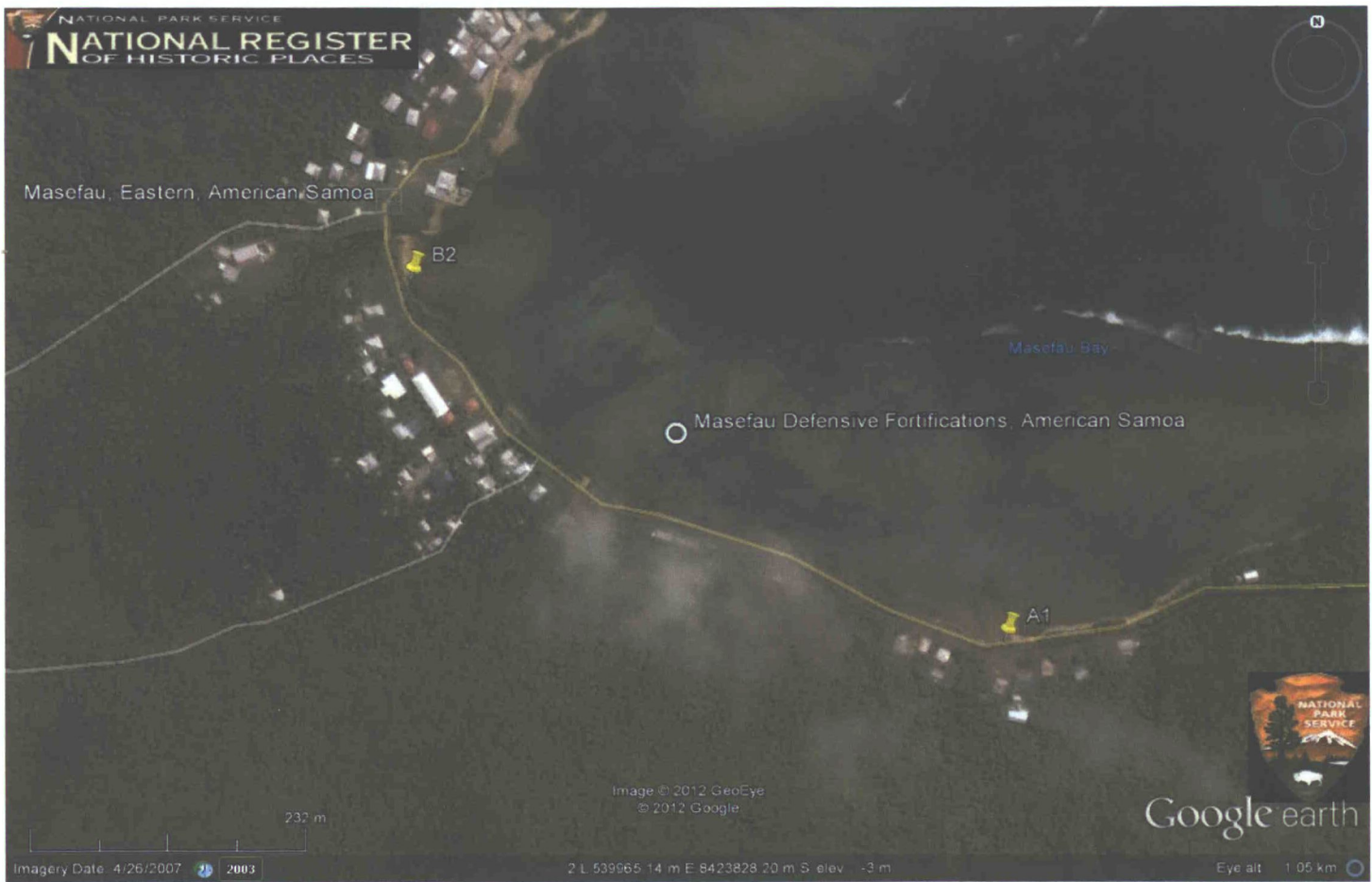

**Masefau Defensive Fortifications
American Samoa**

Point A1
2 540245 8423650

Point B2
2 539715 8423980

Masefau Beach, Eastern Tutuila
Name of Property

Sua,
American Samoa
County and State

City or Vicinity: Masefau

County: Sua State: American Samoa

Photographer: Joel D. Klenck

Date Photographed: 2012

Description of Photograph(s) and number: 10 photographs comprising site plan (sketch map) of site, World War II maps and two defensive fortifications.

See Attached

- 1 of 13: Site Plan of Masefau Beach Site, Eastern Tutuila, American Samoa.
- 2 of 13: Masefau Beach Site, Western Tutuila, American Samoa.
- 3 of 13: Map of Tutuila exhibiting U.S. Marine Corps and Navy locations during World War II and previously recorded defensive fortifications (U.S. Naval Survey; Comments From November 18, 1941).
- 4 of 13: Map of Tutuila exhibiting U.S. Marine Corps and Navy locations during World War II and previously recorded defensive fortifications (U.S. Navy Map 16, 1944).
- 5 of 13: Map of Tutuila exhibiting U.S. Marine Corps and Navy locations during World War II and previously recorded defensive fortifications (U.S. Navy Map 21, 1944).
- 6 of 13: Map of Tutuila exhibiting U.S. Marine Corps and Navy locations during World War II and previously recorded defensive fortifications (from Kennedy et al., 2005: 2, Figure 1).
- 7 of 13: Diagram of Round, Domed Top Pillbox with Gun Slit (from Kennedy *et al.*, 2005: 130, Figure 110).
- 8 of 13: World War II Defensive Fortification 1.
- 9 of 13: World War II Defensive Fortification 1, interior view.
- 10 of 13: World War II Defensive Fortification 1, orientation from base of structure.
- 11 of 13: World War II Defensive Fortification 2.
- 12 of 13: World War II Defensive Fortification 2, interior view.
- 13 of 13: World War II Defensive Fortification 2, orientation from base of structure.

Property Owner:

(Complete this item at the request of the SHPO or FPO.)

Name Village of Masefau
street & number N/A Telephone (684) 770-9512
city or town Village of Masefau Island of Tutuila state Am. Samo zip code 96799

Paperwork Reduction Act Statement: This information is being collected for applications to the National Register of Historic Places to nominate properties for listing or determine eligibility for listing, to list properties, and to amend existing listings. Response to this request is required to obtain a benefit in accordance with the National Historic Preservation Act, as amended (16 U.S.C.460 et seq.).

Estimated Burden Statement: Public reporting burden for this form is estimated to average 18 hours per response including time for reviewing instructions, gathering and maintaining data, and completing and reviewing the form. Direct comments regarding this burden estimate or any aspect of this form to the Office of Planning and Performance Management, U.S. Dept. of the Interior, 1849 C. Street, NW, Washington, DC.

**NATIONAL REGISTER OF HISTORIC PLACES
CONTINUATION SHEET 1**

European influence in the Samoa Islands began in the nineteenth century, with the arrival of the Reverend John Williams of the London Missionary Society at Sapapali'i, Savai'i (now in Western Samoa), on August 24, 1830. Nine years later, Lieutenant Charles Wilkes, USN, commanding the United States Exploring Expedition, arrived in Pago Pago Harbor aboard *USS Vincennes*, and reported on the excellence of the harbor as a suitable deep-water, protected refuge for ships. Three decades later, in 1872, Commander Richard Meade, USN, arrived in Pago Pago aboard *USS Narragansett*, seeking

Masefau Beach, Eastern Tutuila

Name of Property

Sua,
American Samoa

County and State

**NATIONAL REGISTER OF HISTORIC PLACES
CONTINUATION SHEET 2**

rights for a coaling station. On March 2 of that year, he and Paramount Chief Mauga Manuma signed the first American-Samoan treaty at Gagamoe, at the western end of Pago Pago Harbor. The US Congress failed to ratify this treaty; subsequently, clashes occurred between American landing forces and Samoans.

England and Germany were also interested in acquiring rights in the Samoas. Tensions grew among three nations; war was a strong possibility, and might have occurred had it not been for the "Great Apia Hurricane of 1889", which destroyed several American, German and English warships in Apia Harbor, in Western Samoa. Ten years later, the Treaty of Berlin was signed, recognizing German control of 'Upolu, Savai'i and adjacent western islands, and American hegemony in Tutuila and Manu'a Islands. In return for this, Germany recognized Britain's suzerainty in the Solomon Islands and relinquished their interest in Tonga.

On April 17, 1900, the principal chiefs of Tutuila signed the Deed of Cession, which recognized American control over their island. Four year later, on July 16, 1904, the Manu'a Islands, located to the east of Tutuila, were similarly ceded. Tutuila and Manu'a then became known as "American Samoa." The U.S. Navy had earlier established the "U.S. Naval Station Tutuila" in Pago Pago Harbor, and its commanding officer was designated Governor of American Samoa. The first land defenses for the Naval station were built during World War I, when fears of German raiders in the Pacific led to the installation of a 3-pounder and 3-inch gun. Both guns were emplaced on Blunts Point, on the south side of Pago Pago Harbor, across from Breakers Point.

The 1920s were peaceful in American Samoa, but tensions began to grow between the United States and the Empire of Japan in the 1930s. Japan annexed Manchuria in 1931 and invaded China proper in 1937. By the early 1940s,

the situation had worsened to such a degree that the Marine Corps' 7th Defense Battalion, a composite infantry-artillery unit with an initial strength of only 25 officers and 392 men, was dispatched to American Samoa, arriving in Pago Pago Harbor on March 1, 1941. Later that year, a detachment of the Utah Construction Company arrived to begin construction of the concrete fortifications for the defense of Tutuila, as part of the Pacific Naval Air Bases (PNAB) program. These defenses were constructed in accordance with a plan written in 1940 by Marine Corps Captain Alfred R. Pefley, and were completed in December, 1941. Due to these measures, American Samoa was much better prepared for defense than other American Pacific possessions such as Guam and Wake Island, which were captured by the Japanese in December of 1941 following their attack on Pearl Harbor.

After striking Pearl Harbor, Japan occupied Guam, Wake Island and the Gilbert Islands, and invaded the Philippines, Burma, Malaya, Thailand, Java, and New Britain. By early 1942, only the supply route through the South Pacific to Australia remained in Allied control. Admiral Ernest J. King, Chief of Naval Operations and Commander in Chief, U.S. Fleet, ordered Admiral Chester W. Nimitz, Commander in Chief, Pacific Fleet, to maintain communications with Australia "at all costs", by protecting the Hawaii-Samoa line. The concern was that Japanese forces would affect this route from their newly captured bases in the proximate Gilbert Islands.

The United States responded to this crisis by organizing the 2nd Marine Brigade at Camp Pendleton, California. The brigade comprised the 8th Marine Regiment, the 2nd Battalion of the 10th Marines, and the 2nd Defense Battalion. The Brigade sailed from San Diego on January 6, 1942, aboard Matson liners *Lurline*, *Matsonia*, and *Monterey*, escorted by the aircraft carriers *USS Enterprise* and *USS Yorktown*. Meanwhile, the 7th Defense Battalion maintained its defensive positions on Tutuila. During this period, the First Samoan Battalion, U.S. Marine Corps Reserve, was ordered into active duty. The extent of the Japanese threat was evidenced on January 11, 1942, when a Japanese submarine surfaced in Fagasa Bay, of the north coast of Tutuila, and fired fifteen 5.5 inch projectiles into the Naval Station. Two people were wounded and the material damage was not pronounced except for the destruction of the only Japanese owned store in American Samoa.

The 2nd Marine Brigade arrived in Pago Pago Harbor on January 23. The aircraft carrier task force, under the command of Vice Admiral William F. Halsey, Jr., continued on to conduct America's first carrier strike against the Japanese, raiding airfields in the Gilbert and Marshall Islands. The Brigade's Commanding Officer, Colonel (soon to be Brigadier General) Henry L. Larsen, was appointed as military governor of American Samoa. Navy *PBY Catalina* flying boats were attached to the Brigade, and flew reconnaissance and antisubmarine missions. By keeping lights on and

Masefau Beach, Eastern Tutuila

Name of Property

Sua,
American Samoa

County and State

**NATIONAL REGISTER OF HISTORIC PLACES
CONTINUATION SHEET 3**

working 'round-the-clock shifts, the first runway of the Tafuna Air Base was completed on April 6, 1942, and received its first aircraft a few days later. The air element consisted of one Marine fighter squadron (VMF-111, flying Grumman F4F Wildcats) and one scout bomber squadron (VMSB-151, using obsolete Curtiss SBC-4 Helldivers). To date, 103 concrete pillboxes have been recorded by archaeologists at potential landing beaches, in Tutuila's valleys and hills, and in Anu'u. The Brigade's first three months in Samoa were spent building these fortifications limiting the time spent on combat training.

While the 2nd Marine Brigade landed at Pago Pago, Japanese troops captured the port of Rabaul, on the island of New Britain, in the Bismarck Archipelago. This occupation heightened the threat to American Samoa. Japanese martial strategies against Australia relied on an interruption of logistical routes from the United States. New Zealand appealed to the Americans for aid in defending Western Samoa, which they received as a League of Nations mandate territory after World War I. New Zealand's garrison in Western Samoa numbered less than 160; yet, they were charged with defending 1,120 square miles, in contrast to American Samoa's 76 square miles, of which Tutuila comprised the majority of the area (52 square miles).

Agreements were signed with New Zealand regarding Western Samoa, and with the Free French concerning the defense of the Wallis Islands, which are geographically near, and linguistically related to Samoa. The United States was given responsibility for the defense of all these islands. The 7th Defense Battalion transferred to Western Samoa and the 8th Battalion established defenses at Wallis. The 3rd Marine Brigade, comprising the 7th Marine Regiment and the 1st Battalion of the 11th Marines, was organized in March, 1942. This Brigade arrived in Western Samoa on May 8. American Samoa became the headquarters of the Samoan Defense Group, which eventually included the Ellice Islands, French Polynesia, Tonga, and the aforementioned island groups. As such, it was the largest of the Pacific defense groups, and

the largest area command in the South Pacific. Major General Charles F.B. Price, USMC, who relieved Brigadier General Henry L. Larsen on April 24, 1942, became the Group's first commander, in addition to his duties as military governor of American Samoa. Tutuila's garrison expanded again in April, with the arrival of the Marine Corps' 1st Raider Battalion. Later, a barrage balloon squadron arrived for the protection of the harbor in Pago Pago and at Tafuna Airbase. On May 31, 1942, an inspection team, commanded by Rear Admiral Richard E. Byrd (the famous Antarctic explorer), found that 8,000 U.S. Navy and Marine Corps personnel were stationed in American Samoa, more than 5,000 in Western Samoa, and 2,600 in the Wallis Islands.

Encouraged by the successes of early 1942, Japanese leadership decided to accelerate their timetable for further military operations in the Pacific by capturing Port Moresby on New Guinea's south coast. This maneuver secured aerial supremacy of the Coral Sea and was followed by the capture of Midway Island, east of Hawaii. Japanese martial leadership envisioned a newly created perimeter of defensive islands to degrade offensives by the U.S. Pacific Fleet; the occupation of Samoa, Fiji, and New Caledonia, and the termination of supply routes to Australia.

Japanese efforts were complicated at Port Moresby by their strategic defeat in the Battle of the Coral Sea, from May 7 to 9, 1942. Japan's defeat at the Battle of Midway and subsequent losses, beginning in June of 1942, ended the threat to American Samoa.

Following these battles, American Samoa became an Advanced Jungle Warfare Training Center for replacements and reinforcements of Marine Corps units being forwarded to amphibious operations in the Solomon and Gilbert Islands, and elsewhere. For a seven-month period ending in July, 1943, Marine replacement battalions from the east coast of the United States trained in Samoa. However, the high incidence of filariasis compelled the Marine Corps to close the training center. MOB 3 left Tutuila on April 1, 1944, but the importance of Pago Harbor, as a destroyer repair facility, completed on February 17, 1944, continued until the end of the War.

In this milieu, the features at Masefau evidence defensive preparations and tactical considerations during the early days of World War II and demonstrate America's protection of its territory in the South Pacific.

**United States Department of the Interior
National Park Service**

**NATIONAL REGISTER OF HISTORIC PLACES
CONTINUATION SHEET**

Section _____ Page _____

=====

SUPPLEMENTARY LISTING RECORD

NRIS Reference Number: 12000919

Date Listed: 11/14/2012

Masefau
Property Name

Eastern AS
County State

N/A
Multiple Name

This property is listed in the National Register of Historic Places in accordance with the attached nomination documentation subject to the following exceptions, exclusions, or amendments, notwithstanding the National Park Service certification included in the nomination documentation.

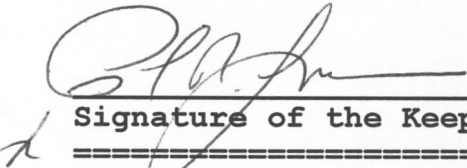

Signature of the Keeper

11/14/2012

Date of Action

Amended Items in Nomination:

Name:
The Historic name is revised to read: *Masefau Defensive Fortifications*
[The name better describes the physical nature and character of the nominated resources.]

Significance:
The nomination is amended to add *Engineering* as an Area of Significance under Criterion C. [Properties nominated under NR Criterion C, as embodying the distinctive characteristics of a type, period, or method of construction, are usually listed under the areas of either Architecture or Engineering.]

The nomination is amended to add *Archeology-Historic/Non-Aboriginal* as an Area of Significance under Criterion D. [Properties nominated under NR Criterion D, as embodying, or likely to embody information important in prehistory or history, are usually listed under the area of Archeology.]

The Period of Significance is amended to read: *1941—1945* and the Significant Dates are deleted. [The period of significance refers to the specific year or span of dates in which a property attained the significance qualifying it for listing. In order to correspond to the NRIS database format these must reflect specific dates rather than general terms, such as "World War II." Significant Dates usually mark specific events or construction activities. Properties with a period of significance spanning many years may not have any specific dates of significance.]

Geographical Data:
The verbal boundary description is revised to read: *The nominated site is comprised of two (2) structures located approximately 800 meters apart along Masefau Beach, within an area approximately 40 meters N/S and 830 meters E/W, running from UTM reference point A1 at 2 8423650N 540245E to Point B2 at 2 8423980N 539715E The specific locations are denoted by the points and are plotted on the attached site plan. The nominated areas are comprised of the fortification structures and an area of surrounding beach representing their original locations and setting sufficient to convey their historic defensive functions.*

These clarifications were confirmed with the AS HPO office.

DISTRIBUTION:
National Register property file
Nominating Authority (without nomination attachment)

UNITED STATES DEPARTMENT OF THE INTERIOR
NATIONAL PARK SERVICE

NATIONAL REGISTER OF HISTORIC PLACES
EVALUATION/RETURN SHEET

REQUESTED ACTION: NOMINATION

PROPERTY Masefau
NAME:

MULTIPLE
NAME:

STATE & COUNTY: AMERICAN SAMOA, Eastern

DATE RECEIVED: 9/28/12 DATE OF PENDING LIST: 10/26/12
DATE OF 16TH DAY: 11/13/12 DATE OF 45TH DAY: 11/14/12
DATE OF WEEKLY LIST:

REFERENCE NUMBER: 12000919

REASONS FOR REVIEW:

APPEAL: N DATA PROBLEM: N LANDSCAPE: N LESS THAN 50 YEARS: N
OTHER: N PDIL: N PERIOD: N PROGRAM UNAPPROVED: N
REQUEST: Y SAMPLE: N SLR DRAFT: N NATIONAL: N

COMMENT WAIVER: N

___ACCEPT ___RETURN ___REJECT _____DATE

ABSTRACT/SUMMARY COMMENTS:

The Masefau Defensive Fortifications are of local and statewide (American Samoa) significance under National Register Criterion A, C, and D in the areas of Military History, Engineering, and Archeology-Historic/Non-Aboriginal. Completed in 1941, in anticipation of Japanese amphibious invasion of the islands of American Samoa, the defensive fortifications at Masefau were part of a comprehensive, island-wide buildup of coastal installations by the U. S. Marines during World War II. Study of the intact structures can reveal new data regarding the distinctive characteristics of historic period engineering and the adaptation of different design forms to the unique functions and locations of these installations. Despite the alteration and movement of these structures due to storm damage, the site continues to convey the significant qualities necessary to understand and gain important information regarding the extant resources, their operational use, and their expansive historic site.

RECOM./CRITERIA Accept CRITERIA A C + D

REVIEWER Paul Lusignea / Erika Seibert DISCIPLINE HISTORIAN / ARCHEOLOGY

TELEPHONE _____ DATE 11/14/2012

DOCUMENTATION see attached comments Y/N see attached SLR (Y)/N

If a nomination is returned to the nominating authority, the nomination is no longer under consideration by the NPS.

**United States Department of the Interior
National Park Service**

**National Register of Historic Places
Continuation Sheet**

Masefau Beach, World War II Site
Name of Property
Sua County, American Samoa
County and State
N/A
Name of multiple listing (if applicable)

Section number Photographs Page 1

DESCRIPTION: Site plan of Masefau Beach Site, Eastern Tutuila, American Samoa. Arrow is oriented north. Western red circle encompasses Feature 1 and eastern red circle surrounds Feature 2. Scale: 1 inch = 500 feet.

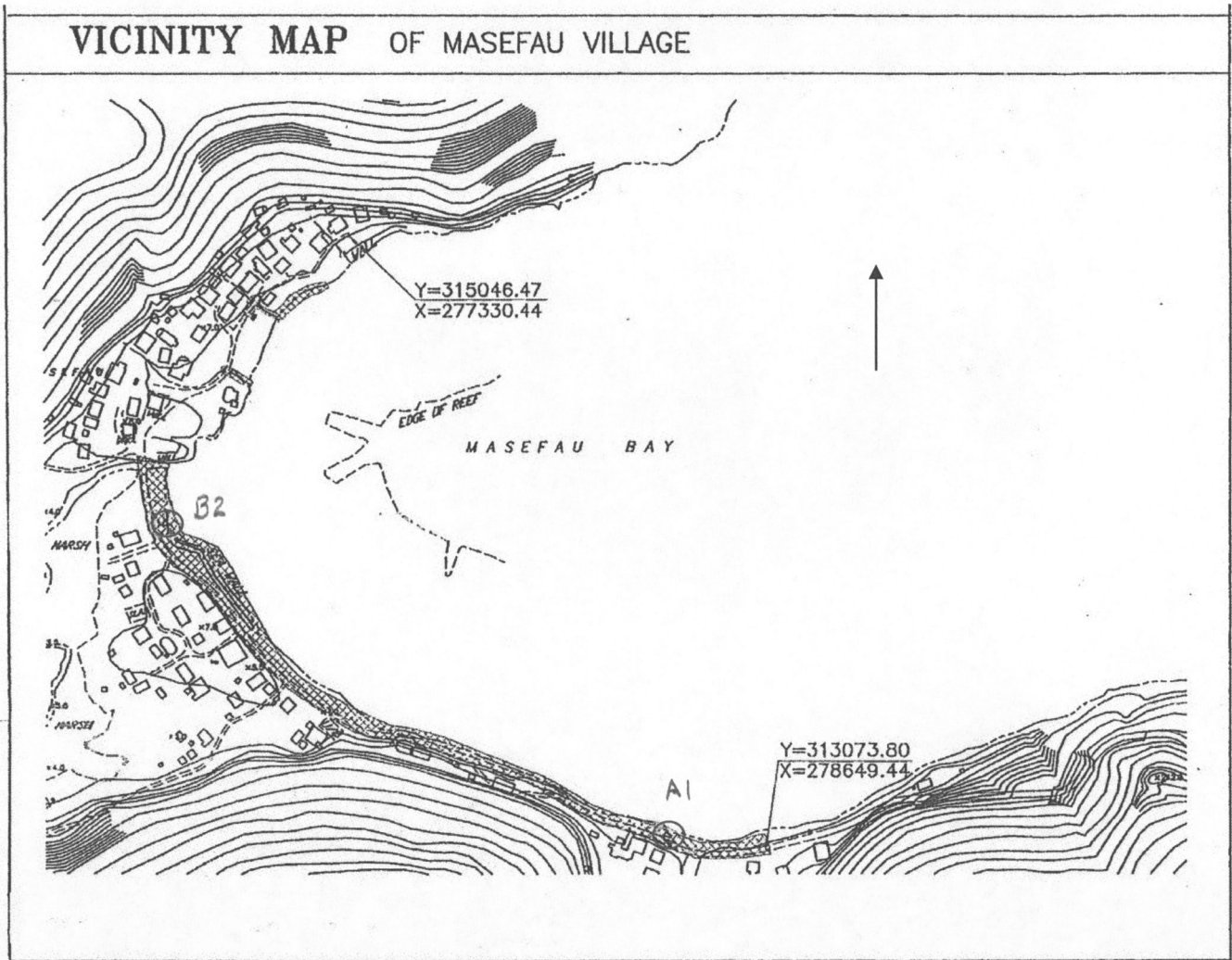

SITE PLAN		Y=313073.80	VILLAGE: MASEFAU
	SCALE:	X=278649.44	COUNTY: WEST VAIFANUA
	DATE: MARCH 21,2012	T-MAP: 5	DISTRICT: EASTERN

**United States Department of the Interior
National Park Service**

**National Register of Historic Places
Continuation Sheet**

Masefau Beach, World War II Site
Name of Property
Sua County, American Samoa
County and State
N/A
Name of multiple listing (if applicable)

Section number Photographs

Page 2

**DESCRIPTION: Photograph of Masefau Beach Site, Western Tutuila, American Samoa.
Orientation is to the northeast.**



United States Department of the Interior
National Park Service

National Register of Historic Places
Continuation Sheet

Masefau Beach, World War II Site

Name of Property

Sua County, American Samoa

County and State

N/A

Name of multiple listing (if applicable)

Section number Photographs

Page 3

DESCRIPTION: Map of Tutuila exhibiting U.S. Marine Corps and Navy locations during World War II and previously recorded defensive fortifications (U.S. Naval Survey; Comments From November 18, 1941). Location of Masefau marked by arrow.

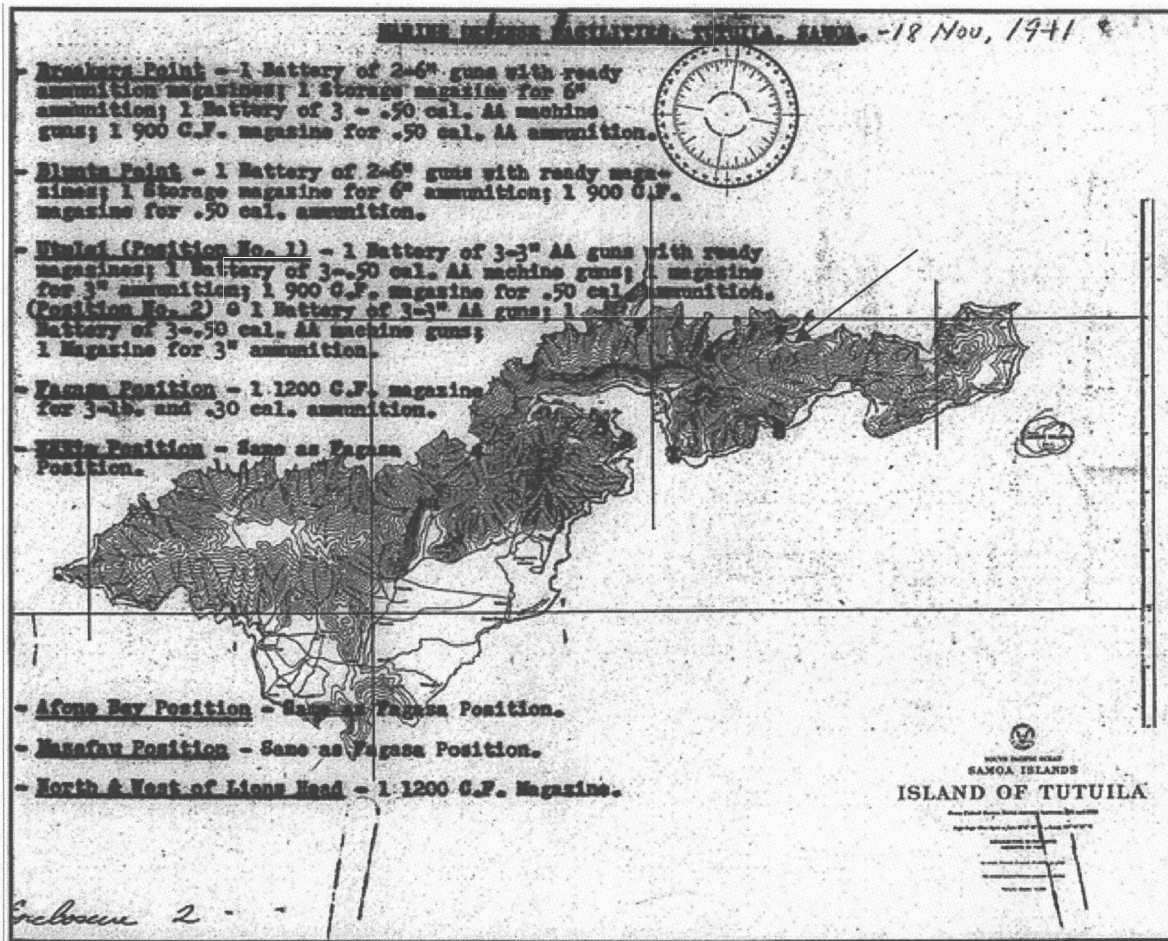

**United States Department of the Interior
National Park Service**

**National Register of Historic Places
Continuation Sheet**

Masefau Beach, World War II Site
Name of Property
Sua County, American Samoa
County and State
N/A
Name of multiple listing (if applicable)

Section number Photographs Page 4

DESCRIPTION: Map of Tutuila exhibiting U.S. Marine Corps and Navy locations during World War II and previously recorded defensive fortifications (U.S. Navy Map 16, 1944). Masefau denoted by red circle.

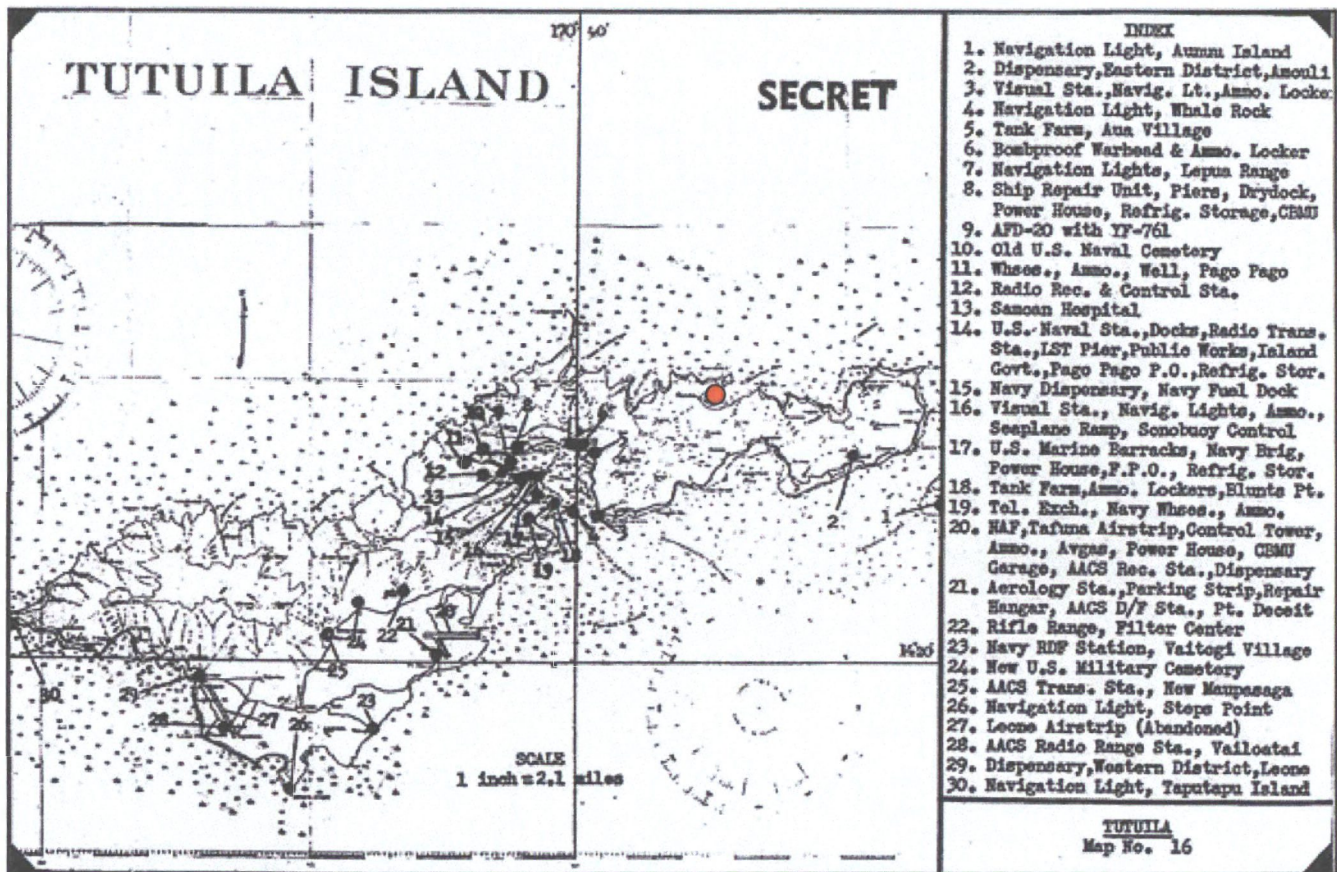

United States Department of the Interior
National Park Service

National Register of Historic Places
Continuation Sheet

Masefau Beach, World War II Site
Name of Property
Sua County, American Samoa
County and State
N/A
Name of multiple listing (if applicable)

Section number Photographs

Page 5

DESCRIPTION: Map of Tutuila exhibiting U.S. Marine Corps and Navy locations during World War II and previously recorded defensive fortifications (U.S. Navy Map 21, 1944). Approximate location of Masefau marked with red circle.

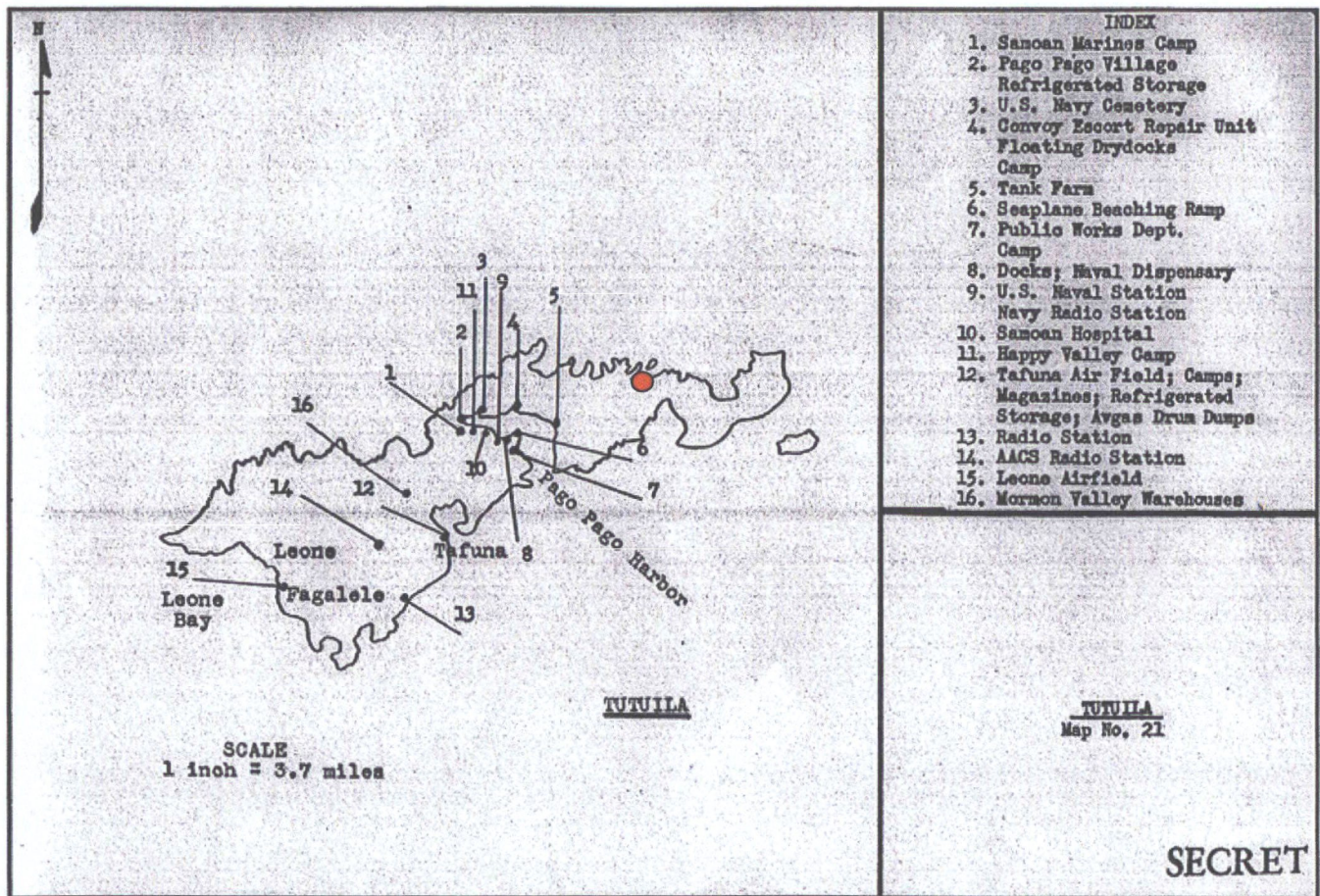

United States Department of the Interior
National Park Service

National Register of Historic Places
Continuation Sheet

Masefau Beach, World War II Site
Name of Property
Sua County, American Samoa
County and State
N/A
Name of multiple listing (if applicable)

Section number Photographs

Page 6

DESCRIPTION: Map of Tutuila exhibiting U.S. Marine Corps and Navy locations during World War II and previously recorded defensive fortifications (from Kennedy et al., 2005: 2, Figure 1). Location of Masefau noted with arrow.

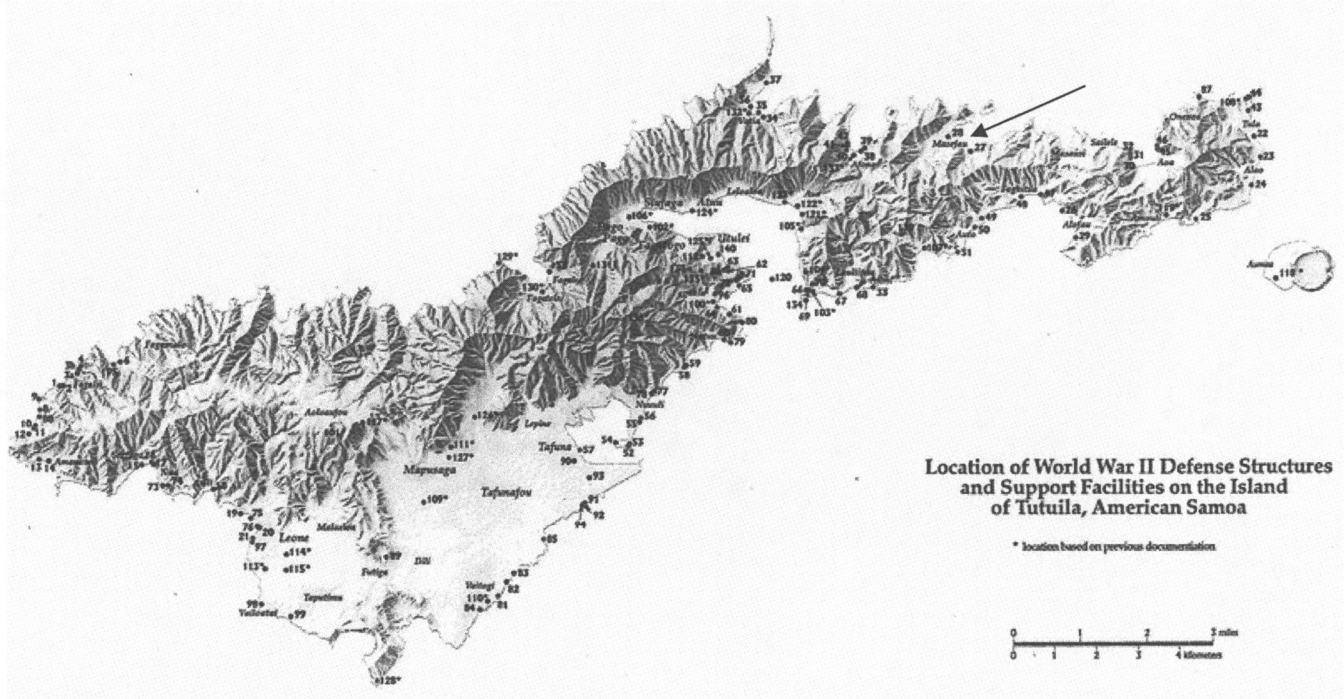

United States Department of the Interior
National Park Service

National Register of Historic Places
Continuation Sheet

Masefau Beach, World War II Site
Name of Property
Sua County, American Samoa
County and State
N/A
Name of multiple listing (if applicable)

Section number Photographs

Page 7

DESCRIPTION: Diagram of Round, Domed Top Pillbox with Gunslit (from Kennedy *et al.*, 2005: 130, Figure 110). The fortifications at Masefau conflict with Kennedy's assertions and evidence the construction of round, domed top pillboxes without ancillary structures.

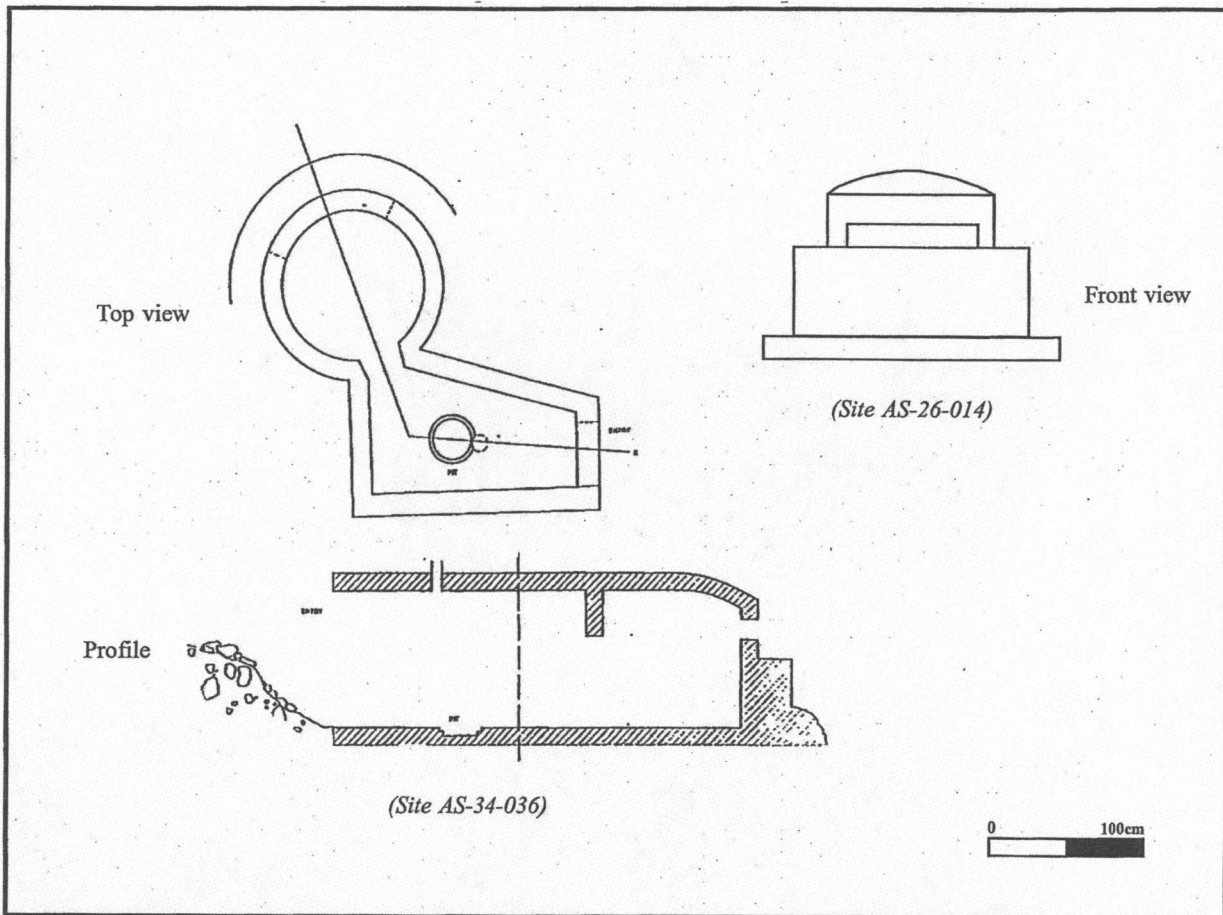

United States Department of the Interior
National Park Service

National Register of Historic Places
Continuation Sheet

Masefau Beach, World War II Site

Name of Property

Sua County, American Samoa

County and State

N/A

Name of multiple listing (if applicable)

Section number Photographs

Page 8

DESCRIPTION: World War II Defensive Fortification 1.



UTM Coordinates: 8423650 N, 540245 E, Zone 2L.

United States Department of the Interior
National Park Service

National Register of Historic Places
Continuation Sheet

Masefau Beach, World War II Site

Name of Property

Sua County, American Samoa

County and State

N/A

Name of multiple listing (if applicable)

Section number Photographs

Page 9

DESCRIPTION: World War II Defensive Fortification 1, interior view.



UTM Coordinates: 8423650 N, 540245 E, Zone 2L.

United States Department of the Interior
National Park Service

National Register of Historic Places
Continuation Sheet

Masefau Beach, World War II Site

Name of Property

Sua County, American Samoa

County and State

N/A

Name of multiple listing (if applicable)

Section number Photographs

Page 10

DESCRIPTION: World War II Defensive Fortification 1, orientation from base of structure.



UTM Coordinates: 8423650 N, 540245 E, Zone 2L.

**United States Department of the Interior
National Park Service**

**National Register of Historic Places
Continuation Sheet**

Masefau Beach, World War II Site

Name of Property

Sua County, American Samoa

County and State

N/A

Name of multiple listing (if applicable)

Section number Photographs

Page 11

DESCRIPTION: World War II Defensive Fortification 2.



UTM Coordinates: 8423980 N, 539715 E, Zone 2L.

United States Department of the Interior
National Park Service

National Register of Historic Places
Continuation Sheet

Masefau Beach, World War II Site
Name of Property
Sua County, American Samoa
County and State
N/A
Name of multiple listing (if applicable)

Section number Photographs

Page 12

DESCRIPTION: World War II Defensive Fortification 2, superior view.



UTM Coordinates: 8423980 N, 539715 E, Zone 2L.

**United States Department of the Interior
National Park Service**

**National Register of Historic Places
Continuation Sheet**

Masefau Beach, World War II Site
Name of Property
Sua County, American Samoa
County and State
N/A
Name of multiple listing (if applicable)

Section number Photographs

Page 13

DESCRIPTION: World War II Defensive Fortification 2, orientation from base of structure.



UTM Coordinates: 8423980 N, 539715 E, Zone 2L.



**TOPOGRAPHIC MAP
 OF
 TUTUILA ISLAND EAST
 AMERICAN SAMOA**

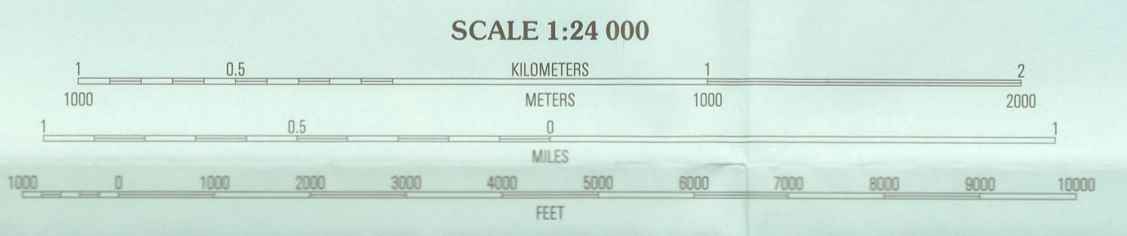

CONTOUR INTERVAL 40 FEET
 SUPPLEMENTARY CONTOUR INTERVAL 20 FEET
 DATUM IS MEAN SEA LEVEL
 DEPTH CURVES AND SOUNDINGS IN FATHOMS. DATUM IS MEAN LOWER LOW WATER
 THE RELATIONSHIP BETWEEN THE TWO DATUMS IS VARIABLE
 THE MEAN RANGE OF TIDE IS APPROXIMATELY 3 FEET
 TO CONVERT FROM FEET TO METERS, MULTIPLY BY 0.3048

Produced by the United States Geological Survey
 in cooperation with the National Imagery and Mapping Agency
 Topography compiled 1961. Planimetry derived from imagery
 taken 2001 and other sources. Survey control current as of 1987
 Selected hydrographic data compiled from
 NIMA chart 4190 (1962)
 This information is not intended for navigational purposes
 North American Datum of 1983/World Geodetic System of 1984
 Projection and 1 000-meter grid: Universal Transverse Mercator, zone 2
 There may be private inholdings within the boundaries of
 the National or State reservations shown on this map.
 Underwater contour gaps near edges are due to NOAA's shift
 Houses of worship, schools, and other labeled buildings verified 1987

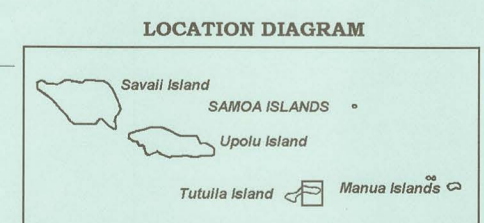

THIS MAP COMPLIES WITH NATIONAL MAP ACCURACY STANDARDS
 FOR SALE BY U.S. GEOLOGICAL SURVEY, P.O. BOX 25286, DENVER, COLORADO 80225
 A FOLDER DESCRIBING TOPOGRAPHIC MAPS AND SYMBOLS IS AVAILABLE ON REQUEST

2001
 NIMA 7945 II NW-SERIES X866

ROAD CLASSIFICATION

Secondary highway, hard surface Light-duty road, hard or improved surface
 Unimproved road Trail

ISBN 0-607-98114-4
 9 780607 981144



Hon. Togiola T. A. Tulafono
Governor

Faoa A. Sunia
Lieutenant Governor

**Executive Offices of the Governor
American Samoa Historic Preservation Office
American Samoa Government
Pago Pago, American Samoa 96799**

David J. Herdrich
Historic Preservation Officer

Phone: (684) 699-2316
Fax: (684) 699-2276

September 14, 2012

181-12-HP

Dr. Paul Lusignan - Historian
National Register of Historic Places
National Park Service, Suite 800
1201 I "Eye" Street, NW (2280) -8th Floor
Washington, DC 20005

Dear Dr. Lusignan:

Please find enclosed a National Register nomination submitted for review for Masefau in American Samoa.

Thank you for your time and assistance in reviewing the nomination for this site and the associated structures for inclusion on the National Register of Historic Places.

If you have any questions concerning this nomination please do not hesitate to contact me at (684) 699-2316 or email me at tavita22@mac.com.

Sincerely,

Dr. Paul D. Herdrich By
Joel D. Klenck Direction

David J. Herdrich
Historic Preservation Officer