

United States Department of the Interior  
National Park Service

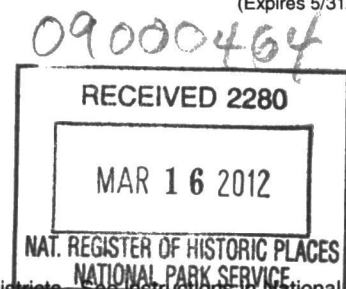

# National Register of Historic Places Registration Form

This form is for use in nominating or requesting determinations for individual properties and districts. See instructions in National Register Bulletin, *How to Complete the National Register of Historic Places Registration Form*. If any item does not apply to the property being documented, enter "N/A" for "not applicable." For functions, architectural classification, materials, and areas of significance, enter only categories and subcategories from the instructions. **Place additional certification comments, entries, and narrative items on continuation sheets if needed (NPS Form 10-900a).**

### 1. Name of Property

historic name South Carolina Memorial Garden  
other names/site number \_\_\_\_\_

### 2. Location

street & number 1919 Lincoln Street  not for publication  
city or town Columbia  vicinity  
state South Carolina code SC county Richland code 079 zip code 29201

### 3. State/Federal Agency Certification

As the designated authority under the National Historic Preservation Act, as amended,  
I hereby certify that this X nomination \_\_\_ request for determination of eligibility meets the documentation standards for registering properties in the National Register of Historic Places and meets the procedural and professional requirements set forth in 36 CFR Part 60.

In my opinion, the property X meets \_\_\_ does not meet the National Register Criteria. I recommend that this property be considered significant at the following level(s) of significance:

\_\_\_ national X statewide \_\_\_ local

Elizabeth M. Johnson \_\_\_\_\_ Date 3/12/2012  
Signature of certifying official

Elizabeth M. Johnson, Deputy State Historic Preservation Officer, South Carolina Department of Archives & History, Columbia, S.C.

In my opinion, the property \_\_\_ meets \_\_\_ does not meet the National Register criteria.

\_\_\_\_\_  
Signature of commenting official Date

\_\_\_\_\_  
Title State or Federal agency/bureau or Tribal Government

### 4. National Park Service Certification

I, hereby, certify that this property is:

- entered in the National Register
- determined not eligible for the National Register
- other (explain:)
- determined eligible for the National Register
- removed from the National Register

[Signature] \_\_\_\_\_ Date of Action 4/2/12  
Signature of the Keeper

**5. Classification**

**Ownership of Property**  
(Check as many boxes as apply)

- private
- public - Local
- public - State
- public - Federal

**Category of Property**  
(Check only **one** box)

- building(s)
- district
- site
- structure
- object

**Number of Resources within Property**  
(Do not include previously listed resources in the count.)

Contributing	Noncontributing	
		buildings
		district
1		site
		structure
		object
1	0	<b>Total</b>

**Name of related multiple property listing**  
(Enter "N/A" if property is not part of a multiple property listing)

N/A

**Number of contributing resources previously listed in the National Register**

0

**6. Function or Use**

**Historic Functions**  
(Enter categories from instructions)

Landscape/Garden  
\_\_\_\_\_  
\_\_\_\_\_  
\_\_\_\_\_  
\_\_\_\_\_  
\_\_\_\_\_  
\_\_\_\_\_

**Current Functions**  
(Enter categories from instructions)

Landscape/Garden  
\_\_\_\_\_  
\_\_\_\_\_  
\_\_\_\_\_  
\_\_\_\_\_  
\_\_\_\_\_  
\_\_\_\_\_

**7. Description**

**Architectural Classification**  
(Enter categories from instructions)

N/A  
\_\_\_\_\_  
\_\_\_\_\_  
\_\_\_\_\_  
\_\_\_\_\_  
\_\_\_\_\_

**Materials**  
(Enter categories from instructions)

foundation: N/A  
walls: N/A  
roof: N/A  
other: \_\_\_\_\_  
\_\_\_\_\_

---

### **Narrative Description**

(Describe the historic and current physical appearance of the property. Explain contributing and noncontributing resources if necessary. Begin with a **summary paragraph** that briefly describes the general characteristics of the property, such as its location, setting, size, and significant features.)

### **Summary Paragraph**

The South Carolina Memorial Garden, owned and maintained by Garden Club of South Carolina, is located at 1919 Lincoln Street, Columbia, on the southwest corner of the intersection of Lincoln and Calhoun Streets in the Arsenal Hill neighborhood. This quarter-acre site was created from a portion of the lot originally belonging to the Caldwell-Hampton-Boylston House, a ca. 1830 Greek Revival house itself listed in the National Register of Historic Places in 1971.<sup>1</sup>

This rectangular formal garden, oriented on an east-west axis, is segregated from adjoining properties by a series of walls and is characterized by its outdoor garden “rooms” featuring a limited variety of ornamental plants, complemented by walls, terraces, walks, sitting areas, a gatehouse, a tool house, a fountain, and other small features such as statuary and urns.

### **Narrative Description**

The South Carolina Memorial Garden, located within the two city blocks that comprise the South Carolina Governor’s Mansion Complex, is on a rectangular parcel measuring 220’ x 56’ and separated from adjoining properties by a series of walls. The garden’s north lot line features a late nineteenth- or early twentieth-century rough granite wall with raised mortar lines. An earlier, masonry wall with a pierced bond pattern stands at the western boundary of the garden, whereas a solid masonry wall incorporating blind arches stands at the east end of the lot. A late twentieth-century brick wall of a similar style as that of the western wall separates the plot from the Caldwell-Hampton-Boylston House grounds and gardens to the south. Entry into the Memorial Garden is primarily achieved through a set of cast iron gates featuring a combination of rectilinear and curvilinear designs set within the masonry wall facing Lincoln Street. A smaller, secondary gate located within the south wall grants access to the Caldwell-Hampton-Boylston House property.<sup>2</sup>

The entire garden can be seen from the perspective of the formal entrance, whose gates open onto a stone walkway flanked by planting beds established with soldier-coursed brick borders situated in front of the site’s two contributing support buildings.

### **General Description**

To the west of the entrance lies a large expanse of turf bordered to its north and south by planting beds set off by soldier-coursed brick edging. Originally incorporating a number of different plants including existing boxwood from Sarah Boylston’s original garden that preceded Loutrel W. Briggs’s 1946 plan for the South Carolina Memorial Garden, these areas now feature new boxwoods (planted 2007-08) as replacements for damaged originals. As in Briggs’s original conception, one of the garden’s benches, situated within the northern planting beds, lies on the same north/south axis as the secondary garden gate found within the south wall.

The garden’s western terminus is comprised of several hardscape and landscape elements that combine to result in a dramatic conclusion to the entry gates’ viewshed. Similar to the entryway’s patio, the garden’s western

---

<sup>1</sup> Caldwell-Hampton-Boylston House, National Register of Historic Places Nomination, 1971, South Carolina Department of Archives and History. <http://www.nationalregister.sc.gov/richland/S10817740017/index.htm>

<sup>2</sup> South Carolina Memorial Garden, Columbia, S.C., site visit by John M. Sherrer III, 29 May 2008.

component features a rectangular terrace of flagstone paving. A low masonry wall featuring coves articulated to accommodate ornamental trees provides a measure of visual drama to the shallow, circular fountain of Pompeian stone situated within the center of the terrace.<sup>3</sup> Added after Briggs's original plan was implemented, a large sculpture of Saint Francis of Assisi casts its gaze upon the garden that lies to the east. Flanking the fountain at the terrace's north and south termini are other garden benches. Behind the terrace is a stand of hollies that screen the garden from the adjacent property to the west.

The South Carolina Memorial Garden reflects the tenets of Briggs's plans in the Lowcountry and incorporates many of the landscape and hardscape features commonly associated with earlier, eighteenth- and early nineteenth-century gardens but does so in an essentially Colonial Revival fashion common to the early twentieth century.

Since 1957, when Loutrel Briggs's original plan was completely implemented, the garden suffered plant damage and loss due to age, storms, and fluctuating financial support. In 2007-2008, the Garden Club of South Carolina undertook a renovation and rehabilitation, following plans by James R. Cothran of the Atlanta-based architectural landscape firm of Robert and Company. Following this recent restoration, dedicated in April 2009, the South Carolina Memorial Garden retains the vast majority of Briggs's original 1946 plan and design elements as it evolved 1946-1957, while featuring upgraded irrigation, hardscaping, and replanting.

The following buildings, structures and objects, and plantings are among those that contribute to the historic character and significance of the South Carolina Memorial Garden:

## **Buildings**

**Gate House or Tea Room (1957):** The larger of the two buildings is an octagonal brick building in the northeast corner of the garden. This small building, painted white, is comprised of two rooms; a 10'-wide primary space for staging teas and other activities and a square restroom for garden guests situated on the building's rear, or north, elevation. Notable architectural details of this support building include a scalloped belcast standing-seam copper roof that peaks with a decorative ball finial, and eight-light windows with decorative iron security grates that flank a solid six-panel wooden entry door with segmental rowlock drip mould head. It was designed and approved by Loutrel Briggs.

**Tool House or Gardener's Shed (1949-1951):** Opposite the Gate House and flanking the flagstone-paved garden entry to the south stands a small rectangular tool house or gardener's shed. Purely utilitarian in function, this hipped roof brick building is also painted white, and features exposed rafter tails and a five open-paneled decorative screen across its facade (north elevation). The two end panels frame single-leaf six-paneled wooden doors. It was designed and approved by Loutrel Briggs.

## **Structures and Objects**

**Entrance Gates (1948):** The original brick wall on Lincoln Street was cut for the decorative iron entrance gates, and two brick piers were built to complement the original pier at the corner of Calhoun and Lincoln Streets. This work was approved by Loutrel Briggs.

**Terrace Walls (1948) and "Four Seasons" Statues (1952):** To the west of the Gate House and Tool House runs a low masonry wall embellished by two of the site's original four lead figural sculptures depicting the four

---

<sup>3</sup> Betsy Steele, "Memorial Garden Update," cited in The Garden Club of South Carolina, Inc., *The South Carolina Gardener*, Volume 88, Issue 6, (Winter 2006), 13.

seasons.<sup>4</sup> This hardscape element combines with the Gate House and Tool House to frame visually the remainder of the garden that lies to the west. The wall and statues were approved by Loutrel Briggs.

**Fountain Terrace and Fountain (1951-52):** This fountain terrace and fountain with 8' spray, carved of "Pompeiiian stone" was designed and approved by Loutrel Briggs.

**St. Francis of Assisi Statue (1954):** This 5' statue, carved of Italian "volcanic stone" and installed at the central iron arch in front of the Tool House near the Lincoln Street entrance in 1954, was approved by Loutrel Briggs. It was later moved to its present location at the rear of the Fountain Terrace, at the western end of the garden.

### Extant Plantings as of 2012, Specified on Original 1946 Plan

The extant plantings listed below were specified on Loutrel Briggs's original 1946 plan. Many of them appear in the list of plants Briggs traditionally used in his garden designs, as identified and discussed by James R. Cothran in *Charleston Gardens and the Landscape Legacy of Loutrel Briggs*.<sup>5</sup> Some are original to the garden as originally designed in 1946 and as it evolved until it was completed in 1957, while others are replacements planted since, but all of them are integral to the garden as originally designed by Briggs and as restored in 2007-2008.

#### Small Shrubs

"Fielder's White" Azalea	<i>Rhododendron indicum</i> x. "Fielder's White"
"George Tabor" Azalea	<i>Rhododendron indicum</i> x. "George Tabor"
Boxwood	Japanese box, <i>Buxus microphylla</i> var. <i>japonica</i> , or Harland box, <i>buxus harlandii</i>
Holly	<i>Ilex vomitoria</i>
Holly Ferns	<i>Cyrtomium falcatum</i>
Nandina	<i>Nandina domestica</i>
Pearl Bush	<i>Exochordas</i>

#### Large Shrubs

Camellia	<i>Camellia japonica</i>
Chinese Azalea	<i>Azalea indica</i>
Japanese Yew	<i>Podocarpus macrophylla</i>
Laurustinus	<i>Viburnum tinus</i>
Oleaster	<i>Eleagnus</i>
Sweet Olive or Tea Olive	<i>Osmanthus fragrans</i>
Sweet Viburnum	<i>Viburnum odoratissimum</i>
Wax-leaf Ligustrum	<i>Ligustrum japonica</i>

#### Small Trees

Flowering Dogwood	<i>Cornus florida</i>
Loquat	<i>Eriobotrya japonica</i>

<sup>4</sup> Lucille Gaffney Thomas, *Eleven Year History of The Garden Club of South Carolina Incorporated, 1950-1961* (Orangeburg, S.C.: The Garden Club of South Carolina, Inc., 1950), 13-14.

<sup>5</sup> James R. Cothran, *Charleston Gardens and the Landscape Legacy of Loutrel Briggs* (Columbia: University of South Carolina Press, 2010), Chapter Seven, "Briggs' Design Style," pp. 73-89.

## Ground Covers

Common Periwinkle	<i>Vinca minor</i>
Bigleaf Periwinkle	<i>Vinca major</i>

In addition, this modern design element from the 2007-2008 restoration is harmonious with Briggs's original 1946 plan and with the garden as it evolved from 1946 until completed in 1957.

**Brick Wall with Pierced Brick Openings and Wrought Iron Gate (2003):** This wall and gate were installed on the south boundary with the Caldwell-Hampton-Boylston House and garden, replacing the chain link fence originally installed in 1945 to separate the South Carolina Memorial Garden from the Caldwell-Hampton-Boylston House property.

**8. Statement of Significance**

**Applicable National Register Criteria**

(Mark "x" in one or more boxes for the criteria qualifying the property for National Register listing)

- A Property is associated with events that have made a significant contribution to the broad patterns of our history.
- B Property is associated with the lives of persons significant in our past.
- C Property embodies the distinctive characteristics of a type, period, or method of construction or represents the work of a master, or possesses high artistic values, or represents a significant and distinguishable entity whose components lack individual distinction.
- D Property has yielded, or is likely to yield, information important in prehistory or history.

**Criteria Considerations**

(Mark "x" in all the boxes that apply)

Property is:

- A owned by a religious institution or used for religious purposes.
- B removed from its original location.
- C a birthplace or grave.
- D a cemetery.
- E a reconstructed building, object, or structure.
- F a commemorative property.
- G less than 50 years old or achieving significance within the past 50 years.

**Period of Significance (justification)**

**Criteria Considerations (explanation, if necessary)**

**Areas of Significance**

(Enter categories from instructions)

Landscape Architecture

---



---



---



---

**Period of Significance**

1946-1957

---

**Significant Dates**

1946-1957

---



---

**Significant Person**

(Complete only if Criterion B is marked above)

---

**Cultural Affiliation**

---



---

**Architect/Builder**

Briggs, Loutrel Winslow

---



---

**Statement of Significance Summary Paragraph** (provide a summary paragraph that includes level of significance and applicable criteria)

The Garden Club of South Carolina's Memorial Garden is historically significant under Criterion C in the Area of Significance for Landscape Architecture, as a design of and for its association with Loutrel W. Briggs (1893-1977), one of the leading twentieth-century American landscape architects. Briggs is credited with establishing the nationally-recognized "Charleston Garden" as a garden type during his time in South Carolina's port city from 1929 until 1977.<sup>6</sup>

This garden is representative of Briggs's influential designs, with its imaginative use of limited space by utilizing a variety of ornamental plants and complimentary design elements such as a gate house and tool house, walls, gates, walks, terraces, a fountain, sculpture, and garden furniture. Its plan and characteristics are similar to many of Briggs's residential city gardens in Charleston and elsewhere, but this garden is distinctive among his designs as being designed for the Garden Club of South Carolina as a public space rather than a private one.

The South Carolina Memorial Garden, established in 1944-45 by the Garden Club of South Carolina, Inc. (GCSC), was envisioned by the club as the first memorial garden sponsored by a state garden club in the United States that recognized veterans of World War II for their military service.

The National Council of State Garden Clubs awarded the Garden Club of South Carolina its White Ribbon Award for Achievement of Exceptional Merit for the Memorial Garden at its annual convention in New Orleans on April 9, 1946, describing the garden in the award citation as "expressed in beauty, a place apart, where one may go as to a sanctuary, and undisturbed, arrange one's thoughts, and where all South Carolinians who served their country well in World War II—may be offered grateful remembrance."<sup>7</sup>

---

**Narrative Statement of Significance** (provide at least **one** paragraph for each area of significance)

### **Landscape Architecture: Loutrel Winslow Briggs (1893-1977)**

Loutrel Briggs was a familiar force among members within the Garden Club of South Carolina as he was renowned for considerable garden rehabilitation work in Charleston during the early twentieth century, in addition to numerous articles he published in popular magazines of the time such as *House and Garden*, *Country Life in America*, *Garden and Home Beautiful*, and *Garden Magazine*.<sup>8</sup> Within two years of visiting the port city during its cultural renaissance, Briggs established an office there in 1929. Over the next three decades the native New Yorker would winter there, enjoying numerous commissions that granted him the opportunity to work with both the eighteenth- and nineteenth-century landscapes of former plantations and historic urban gardens. In 1959, Briggs opted to reside in Charleston year-round.

Briggs's importance to Charleston, and by extension, the remainder of South Carolina, proved seminal in that the transplanted Northerner essentially created the landscape form that today is popularly recognized as the "Charleston Garden." Elemental in Briggs's historically sensitive landscape concepts was the inclusion of plant species considered "traditional" to Charleston, an approach that typically drew from between twenty-five and

---

<sup>6</sup> James R. Cothran, *Gardens of Historic Charleston* (Columbia: University of South Carolina Press, 1995), pp. 42, 54-69.

<sup>7</sup> Citation for National Convention of State Garden Clubs, White Ribbon Award for Achievement of Exceptional Merit, New Orleans, April 9, 1946, as quoted in "Report on 1946 Awards," Garden Club of South Carolina, *Yearbook, 1944-1946* (Columbia, S.C., 1946), p. 24.

<sup>8</sup> Charles A. Birnbaum and Robin Karson, *Pioneers of American Landscape Design* (New York: McGraw-Hill, 2000), 35-37.

thirty plants including azaleas, camellias, wisteria, tea olives, yellow jessamine, and oleander. Occasionally his designs mated these traditional plantings with grass lawns and beds featuring bulbs, annuals, and perennials. Also key to Briggs' landscapes were hardscapes of traditional materials including brick, stone, iron, and sculpture.<sup>9</sup>

The South Carolina Memorial Garden is characteristic of a Loutrel Briggs design, adhering to his design principles in general and in terms of what landscape architect and garden historian James R. Cothran has identified and described as hardscape materials, physical enclosures, pools and fountains, the illusion of space, garden features, ornamental plants, and design implementation.

It is an outstanding tangible expression of Loutrel Briggs' landscape design philosophy. According to Cothran, in his recent definitive study of Briggs' career, the garden "remains a lasting legacy to the visionary efforts of the Garden Club of South Carolina and the contributions of Loutrel Briggs."<sup>10</sup>

The South Carolina Memorial Garden contains most of the elements Cothran identifies and explains as basic to a Briggs garden, in "Briggs' Design Style," Chapter 7 of his definitive study *Charleston Gardens and the Landscape Legacy of Loutrel Briggs*. This garden is a quintessential Briggs garden in these specific ways:<sup>11</sup>

### **Design Principles**

Loutrel Briggs intended his gardens to be places in which open spaces and enclosures worked together to create "outdoor garden rooms," using terraces, fountains or pools, and seating to achieve that goal. The South Carolina Memorial Garden is an excellent illustration of an "outdoor garden room" with different levels, boundaries, and well-defined open spaces and enclosures.

### **Hardscape Materials**

Old bricks and stone were often used for walls, walks, steps, terraces, and similar elements. "The appropriate use of these historic materials," Cothran observes, "helped to articulate and enhance a design and connect the garden visually to its surroundings."<sup>12</sup> The use of historic brick in the South Carolina Memorial Garden was enhanced and emphasized by its proximity to the historic brick wall, antebellum house, and established garden at the Caldwell-Hampton-Boylston House, from which this garden was created. That connection is particularly important in the case of this garden, with its close geographical relationship to the Caldwell-Hampton-Boylston House and other significant historic houses in the Arsenal Hill section of old Columbia, including the Governors' Mansion (1855) at 800 Richland Street, listed in the National Register June 5, 1970, and the Lace House (1854) at 803 Richland Street, listed in the National Register December 17, 1969.<sup>13</sup>

### **Physical Enclosures**

---

<sup>9</sup> Cothran, *Gardens of Historic Charleston*, 54-58, 60-62.

<sup>10</sup> Cothran, *Charleston Gardens and the Landscape Legacy of Loutrel Briggs*, p. 50.

<sup>11</sup> *Ibid.*, 73-89.

<sup>12</sup> *Ibid.*, p. 79.

<sup>13</sup> Governor's Mansion and Lace House, National Register of Historic Places Nominations, 1970 and 1969, South Carolina Department of Archives and History, available online at <http://www.nationalregister.sc.gov/richland/S10817740003/index.htm> and <http://www.nationalregister.sc.gov/richland/S10817740002/index.htm>

Typical designs employed low brick walls, sometimes pierced-brick walls, to divide spaces without obscuring them altogether. The South Carolina Memorial Garden features both types of walls to great effect.

### **Pools and Fountains**

Pools or fountains were significant elements of Briggs gardens, both large and small. The dramatic visual movement and aural sound of splashing water in fountains is a vivid component of visitors' experience in and reaction to his gardens, especially in the case of smaller urban gardens such as the South Carolina Memorial Garden.

### **The Illusion of Space**

Briggs often incorporated terraces, steps, elevated planting beds, or pierced-brick walls set perpendicular to the main axis of the garden, and other elements such as benches or gates at the ends or sides of the main garden, as one way to create the effect of multiple "garden rooms." The South Carolina Memorial Garden contains all of these elements to some degree, giving the illusion that it is larger than is actually is.

### **Garden Features**

Furniture, sculpture, and other small objects were often selected and placed to draw visitors' attention to certain places within the overall layout of a particular garden. As Cothran notes, "Briggs possessed a special talent for enhancing the character of his designs by selecting appropriate garden features . . . based on size and appropriateness to the overall design. . . . It was Briggs' creative use of garden features and his genius for details that endowed his gardens with special character and visual appeal."<sup>14</sup> The South Carolina Memorial Garden features five statues and several benches that help achieve this effect.

### **Ornamental Plants**

"A particular trademark of a Briggs garden," Cothran explains, "was the sensitive use of appropriate plants. Briggs selected plants based on their individual character and ability to perform with the limitations of available space. . . . A limited palette of plants was a hallmark of a Briggs garden."<sup>15</sup> The South Carolina Memorial Garden, as will be seen by referring to the list of plantings in Section 7, features that "limited palette of plants" favored by Briggs.

### **Design Implementation**

Briggs generally supervised the work of contractors and others who laid out his gardens, built buildings and sculptures, and installed plants. The annual *Yearbooks* of the Garden Club of South Carolina are full of references to Briggs's approval of work being done on the South Carolina Memorial Garden between 1946 and 1957.<sup>16</sup>

---

### **Developmental history/additional historic context information** (if appropriate)

---

<sup>14</sup> Cothran, *Charleston Gardens and the Landscape Legacy of Loutrel Briggs*, pp. 83, 86.

<sup>15</sup> *Ibid.*, pp. 86-88.

<sup>16</sup> "Major Highlights of the South Carolina Memorial Garden, 1945-2010" (compiled from annual *Yearbooks* of the Garden Club of South Carolina, 1945-2010), timeline on file at the South Carolina State Historic Preservation Office (SHPO), South Carolina Department of Archives and History, Columbia, S.C.

The Garden Club of South Carolina represents an early twentieth-century manifestation of social activism that traces its roots back to nineteenth-century Victorian mores that assigned women the task of ensuring the physical, religious, and moral well being of their families. From this position of power, women gradually assumed a greater voice in addressing issues with broader, more public impact during the latter stages of the nineteenth century. Of great concern to Progressive era activists was addressing the ills associated with modern cities – particularly overcrowding and poor sanitation.

Civic improvement measures assumed many forms in response to this challenge. One of the most nationally widespread was the City Beautiful movement, which arose in the 1890s. Proponents of the movement championed the benefits of heightened sanitation and more thoughtful urban planning, which involved the creation of public green spaces and the enhancement of landscaping along roads. In their estimation a beautiful city was a progressive city that evoked both modern sensibilities and an elevated appreciation for the benefits of aesthetically compelling surroundings.<sup>17</sup> Enthusiasts for what would become Columbia's Civic Improvement League in 1904 often couched the movement as patriotic in spirit and worthy of widespread support.<sup>18</sup>

Among those citizens who proved active in pursuing the goals of the Civic Improvement League were activist Mrs. Edwin G. Seibels, whose industrialist banker husband came to chair Columbia's Tree and Park Commission established in 1906, and Sarah Boylston, who worked toward creating a park across from the Edwin Wales Robertson residence atop Arsenal Hill, in addition to catalyzing landscaping improvements at the nearby post office, United States Weather Bureau, and the Jefferson Hotel.<sup>19</sup> Ultimately, the extent to which this local expression of the City Beautiful movement proved successful in South Carolina's capital city paled in comparison with those of other cities, despite Columbia being "blessed with patriotic daughters who [were] willing to labor in her behalf."<sup>20</sup> The movement did establish a grassroots interest in activism involving horticultural and historic aspects of the city in addition to reinforcing the social connections that would prove integral in further civic improvement projects within the following decades.<sup>21</sup>

Not long after the City Beautiful movement's momentum had subsided by the end of the First World War, Columbians were again called to civic action. Couched in patriotic terms, much like that of the previous civic movement, and certainly war-related activist endeavors, came the grassroots preservation movement to save the Hampton Street boyhood home of the United States' twenty-eighth president, Woodrow Wilson, who resided there from 1870 to 1874. Prized for its association with the nation's first modern world statesman, the home was threatened with demolition for the construction of the Township Auditorium. Again, women were highly active in the successful efforts to preserve the site both as a shrine to Wilson and as a way of honoring veterans of the "war to end all wars." Among their ranks were those who came to support later civic improvements, including championing the cause to recognize service men and women a generation later in World War II.

---

<sup>17</sup> Marta Leslie Thacker, "Working for the City Beautiful: Civic Improvement in Three South Carolina Communities" (M.A. thesis, University of South Carolina, 1999), pp. 1-6.

<sup>18</sup> John Hammond Moore, *Columbia and Richland County: A South Carolina Community, 1740-1990* (Columbia: University of South Carolina Press, 1993), pp. 315-317.

<sup>19</sup> *Revised Ordinances of the City of Columbia, S.C., 1907* (Columbia: The R.L. Bryan Company, 1907), 65; "The Tree and Park Commission," *The State* (Columbia, S.C.), 3 February 1905; "Civic League Meeting," *The State*, 13 December 1916.

<sup>20</sup> "The City Beautiful," *The Daily Record* (Columbia, S.C.), 25 February 1913.

<sup>21</sup> *Ibid.*; Thacker, "Working for the City Beautiful," pp. 1-6.

## Founding the South Carolina Garden Club

Women's involvement in civic improvement initiatives grew substantially from a local level stance to one of statewide heightened activism and opportunity for social networking at roughly the same time that preservationists were invested in Columbia's Wilson Home initiative. In April 1930, a group of civic-minded women gathered at the home of Mrs. Sheffield Phelps (Claudia Wright Lea) in Aiken to explore the potential of developing an association comprised of representatives from long-established garden clubs located throughout the state. As a united body, this group could then "become federated with clubs across the nation, mutually benefiting efforts in conservation, roadside beautification, environmental awareness, and educational opportunities."<sup>22</sup> On December 9, 1930, the groups became federated in South Carolina at a meeting held at Columbia's Rose Mary Tea Room that consisted of members representing twelve active clubs throughout the state. Less than four years later, in April 1934, the South Carolina Garden Club became federated with the National Garden Clubs, Inc.<sup>23</sup>

Slightly more than five years later, key members of the South Carolina Garden Club became involved in an ultimately abortive, yet important, initiative to preserve the gardens of Columbia's historic Hampton-Preston estate, whose forty-year era as a campus for women's colleges concluded in the same year that the club was established. Within the activist ranks were Camden's Mrs. Robert W. Pomeroy (Lucy B.), president of the Garden Club of South Carolina 1933-1935 and Greenville's Mrs. Henry Crigler (Sara Gossett), president of the Garden Club of South Carolina 1938-1940. Also among the women who campaigned for the restoration of the fabled gardens were familiar faces that had been active years earlier in the Civic Improvement League's projects, namely Mrs. Samuel S. (Sarah) Boylston, Mrs. Edwin G. Seibels, Mrs. E.C. L. Adams and in the preservation of the Woodrow Wilson Boyhood Home, specifically Mrs. James A. Cathcart and Mrs. A. F. McKissick.<sup>24</sup> The laudable efforts of these women and others involved with the Columbia Art Association, which secured an option to buy the property for use as a museum, attracted the attention of Columbians and Loutrel W. Briggs, a noted New York landscape architect who had wintered in Charleston since 1927. Impressed with both groups' commitment and intrigued by the estate's extensive, though untended, gardens, Briggs delivered a presentation about the property's significance, following an invitation to travel to Columbia by the Garden Club of South Carolina. As he would later repeat, Briggs rendered his service free of charge for the furtherance of the group's effort.<sup>25</sup>

## Establishing the South Carolina Memorial Garden

Ultimately, the exigencies of World War II thwarted efforts to restore the Hampton-Preston gardens, which Briggs so greatly admired and championed in his 1940 address. Ironically, the same international conflict became the very impetus that led the architect to reestablish his relationship with Columbia a few years later.<sup>26</sup> Under the leadership of its seventh president, Mrs. Louis I. Guion (Elizabeth Guignard), the Garden Club of South Carolina at its annual meeting on November 2, 1944 voted to establish what would prove to be the first landscape of its kind – a memorial garden sponsored by a statewide garden club and dedicated to the memory of the dead and the honor of the living who served in World War II.

---

<sup>22</sup> Garden Club of South Carolina, Inc., *75<sup>th</sup> Diamond Anniversary 1930-2005* (Gaffney, S.C.: Print Depot, 2005), p. 5.

<sup>23</sup> *Ibid.*

<sup>24</sup> "First Report Meeting Set for Hampton-Preston Workers," *The State*, 19 May 1940; Garden Club of South Carolina, Inc., *75<sup>th</sup> Diamond Anniversary*, p. 5.

<sup>25</sup> "First Report Meeting Set."

<sup>26</sup> *Ibid.*

Columbia was chosen for the location for the Garden Club of South Carolina's ambitious project due to the city's geographic centrality and its status as the state's capital. This choice must have resonated with Guion, a graduate of the South Carolina College for Women, which had operated from the Hampton-Preston estate, and whose great grandfather John Gabriel Guignard was the surveyor responsible for laying out the city.<sup>27</sup> A site search committee comprised of civic leaders Mrs. Robert Durham, Mrs. D.S. Pope, and Mrs. Samuel S. Boylston was assembled to identify a suitable property for development. Shortly thereafter, Guion commissioned Briggs as the landscape architect who would render plans for this unprecedented garden initiative. As he had for the initiative to restore the gardens at Guion's former college campus, Briggs again donated his services.

When the site search committee failed in its initial efforts to secure an appropriate venue, Sarah Boylston donated a portion of her antebellum estate's grounds to the cause as a memorial to her husband and son.<sup>28</sup> Boylston's gift consisted of a rectangular parcel measuring "220 feet by 56 feet, high walled on three sides with brick and stone" that lay to the north of her antebellum home, the Caldwell-Hampton-Boylston House (ca. 1830), in Columbia's Arsenal Hill neighborhood.

The Garden Club of South Carolina applied to the State of South Carolina for an incorporation charter as a private, non-profit organization, so that it could hold title to real estate, qualify for tax-exempt status, and request aid from the South Carolina General Assembly to establish and maintain the garden.<sup>29</sup>

On March 29, 1945—less than two weeks before the death of President Franklin D. Roosevelt but before the end of World War II (a full month before V-E Day in Europe and a full four months before V-J Day in the Pacific)—South Carolina State Senators Ryan Milo Smith and Joe E. Berry introduced a joint Senate resolution requiring the state to furnish convict labor to assist the Garden Club in maintaining "a memorial shrine to the casualty list of veterans of World War II."<sup>30</sup> On April 26th Berry and Smith, joined by State Senators W. Brantley Harvey and T.B. Bryant, introduced a concurrent Senate resolution—to which the South Carolina House concurred on May 1st—explaining that "the State Garden Club is establishing a Memorial to the Casualties of World War II . . . at the corner of Lincoln and Calhoun Streets in the City of Columbia," and calling for convict labor "the equal of one man two days per week, for the purpose of assisting in the maintenance of the said Memorial Shrine."<sup>31</sup>

Such early legislative support underscores the Garden Club's vision of the South Carolina Memorial Garden as the state's "memorial shrine" to honor the memory of her dead servicemen and women and recognize the service of her living veterans, an effort initiated before the war had even been won.

By that time, on April 11th, the Garden Club of South Carolina had officially announced Boylston's gift during its annual meeting in Columbia. Two months later, on June 22nd, Boylston transferred the quarter-acre parcel

---

<sup>27</sup> Garden Club of South Carolina, Inc., *75<sup>th</sup> Diamond Anniversary*, p. 28.

<sup>28</sup> Thomas, pp. 13-14.

<sup>29</sup> "Memorial Garden Announcement," Garden Club of South Carolina, *Bulletin*, No. 32 (March 1945) and *Yearbook*, 1943-1944 (Columbia, S.C., 1945), p. 19.

<sup>30</sup> *Ibid.*; Journal, Thursday, March 29, 1945, in *Journal of the Senate of the First Session of the 86th General Assembly of the State of South Carolina, Being the Regular Session Beginning Tuesday, January 9, 1945* (Columbia, 1946), p. 472; additional mentions, pp. 872, 977.

<sup>31</sup> *Journal of the Senate of the First Session of the 86th General Assembly*, pp. 988, 1047. See also "History of the Memorial Garden," in Garden Club of South Carolina, *Yearbook, 1944-1946* (Columbia, S.C., 1946), pp. 35-36.

to the club. Situated on the southwest corner of Lincoln and Calhoun Streets, the garden would be a short walk from the Governor's Mansion, located to the southwest, thus ensuring significant visibility.<sup>32</sup>

Greater exposure and accolades were enjoyed by the club the next spring. On April 9, 1946, during the National Convention of State Garden Clubs, it received the White Ribbon Award for Achievement of Exceptional Merit in recognition of its establishment of the memorial garden and its work on it thus far.<sup>33</sup>

Only two days later, at the annual meeting of the Garden Club of South Carolina held in Columbia on April 11th, Loutrel W. Briggs submitted his plans for the garden and gatehouse at the club's annual convention, which boasted its largest attendance in years. His concept, copies of which were issued to garden representatives from each town represented, sought to transform Boylston's previously planted parcel into a formal memorial setting that was typical of his earlier work.<sup>34</sup> Mrs. Elizabeth Guignard Guion, president of the Garden Club of South Carolina, led the members of the club, many of whom had not yet seen it, on a tour of the Memorial Garden.<sup>35</sup>

A few days later, when 1,500 citizens attended an Easter sunrise service at the fledgling memorial site performed by Dr. R.C. Campbell, pastor of First Baptist Church, both Columbia newspapers called the South Carolina Memorial Garden "the State Memorial garden" and "State Memorial Garden," respectively.<sup>36</sup>

Over the course of the next decade, the club's influential members strove to implement the Briggs design, gaining ground with each successive year while soliciting support from community businesses for materials, plantings, and funds. Their efforts paid off as the site became a natural gathering spot among the socially well-placed who used it for annual memorial services, Easter events, weddings, teas, poetry readings by the South Carolina Arts Commission, and club meetings. By 1957, Briggs's concept was completed. The memorial garden featured considerable plantings, a fountain of Pompeian stone, a tea room, a gardener's shed, and a brick wall with an iron gate, many items of which were gifts from the various districts represented within the Garden Club of South Carolina.<sup>37</sup> That April, the club's thirteenth president, Mrs. Cuba Nunez Rutledge, presided over the memorial garden's formal dedication. In later years the club gathered for more solemn events such as the funeral of the garden's benefactor, Mrs. Samuel S. Boylston, and for memorial services for soldiers killed during the Vietnam War.

### **The Memorial Garden in the Twenty-First Century**

As with any landscape, the South Carolina Memorial Garden matured over the decades after Briggs's plan had been completed and came to include new plantings and basic amenities as funds allowed, and such upkeep remained true to Briggs's original design. Over two generations' worth of efforts suffered a devastating setback in 2000 during an ice storm that inflicted heavy damage to trees and shrubs. Club members initiated an extensive restoration of the garden's plantings, structures, and hardscapes in 2003 under the guidance of Atlanta landscape architect James R. Cothran of Robert and Company—an expert on Loutrel Briggs, whose recent

---

<sup>32</sup> "Mrs. R.H. Welch Heads Columbia Garden Club," *The State*, 17 April 1945; Helen W. Goforth, "Timeline History of the Memorial Garden, 1944-2007," Archives of the Garden Club of South Carolina, Inc., Columbia, S.C.

<sup>33</sup> Citation for White Ribbon Award for Achievement of Exceptional Merit as quoted in "Report on 1946 Awards," Garden Club of South Carolina, *Yearbook, 1944-1946*, p. 24.

<sup>34</sup> Claudia Seabrook Langley, "South Carolina Garden Club Convention Largest in Years; Next Meeting at Charleston," *The State* (Columbia, S.C.), 12 April 1946.

<sup>35</sup> *Ibid.*

<sup>36</sup> "Garden Scene of Sunrise Services," *The Columbia Record* (Columbia, S.C.), 20 April 1946; "Columbia Churches Crowded for Easter Sunday Services," *The State*, 22 April 1946.

<sup>37</sup> Thomas, pp. 13-14.

*Charleston Gardens and the Landscape Legacy of Loutrel Briggs* (University of South Carolina Press, 2010) is the definitive study of Briggs's gardens. Cothran's efforts during a restoration undertaken in 2007-2008 and dedicated in April 2009 have adhered to Briggs' original scheme in order to maintain the property's historic integrity.

## Summary

For more than sixty years the Garden Club of South Carolina's Memorial Garden has played a significant role in the state's social, cultural, and landscape history. Inspired by the social activism their predecessors embraced during such initiatives as the early twentieth-century's City Beautiful movement, members of the club meshed similar civic interests with patriotism by the end of World War II. By installing the nation's first World War II memorial garden sponsored by a state garden club in memory and in honor of veterans of that seminal event, South Carolina women inspired fellow gardeners in other states who later mimicked their efforts through memorial sites of their own. While never forsaking the garden's initial purpose, the club's stewardship of this important landscape has embraced the varied social interests of generations of South Carolinians who have sought out the garden for its natural beauty and proximity to other nearby and historically significant properties that lie nearby. As an historic asset embodying the tenets of landscape architect Loutrel Briggs, the South Carolina Memorial Garden reflects over a century's worth of social, cultural, and horticultural values, in addition to the economic and natural forces that made its establishment and management possible.

---

## 9. Major Bibliographical References

---

**Bibliography** (Cite the books, articles, and other sources used in preparing this form on one or more continuation sheets)

### UNPUBLISHED SOURCES

Archives of the Garden Club of South Carolina, Inc., Columbia, S.C.

Goforth, Helen W. "Timeline History of the Memorial Garden, 1944-2007."

South Carolina Department of Archives and History, Columbia, S.C.

South Carolina State Historic Preservation Office  
National Register of Historic Places Files

Nomination for Caldwell-Hampton-Boylston House, Columbia, Richland County, 1971.

Online at <http://www.nationalregister.sc.gov/richland/S10817740017/index.htm> , accessed 8 March 2012.

Nomination for the Lace House, Columbia, Richland County, 1969. Online at

<http://www.nationalregister.sc.gov/richland/S10817740002/index.htm> , accessed 8 March 2012.

Nomination for the South Carolina Governor's Mansion, Columbia, Richland County, 1970.

Online at <http://www.nationalregister.sc.gov/richland/S10817740003/index.htm> , accessed 8 March 2012.

“Major Highlights of the South Carolina Memorial Garden, 1945-2010,” compiled from annual *Yearbooks* of the Garden Club of South Carolina, 1945-2010, timeline on file.

Thacker, Marta Leslie. “Working for the City Beautiful: Civic Improvement in Three South Carolina Communities.” M.A. Thesis, University of South Carolina, 1999.

## **PUBLISHED SOURCES**

Birnbaum, Charles A., and Robin Karson. *Pioneers of American Landscape Design*. New York: McGraw-Hill, 2000.

“The City Beautiful.” *The Daily Record* (Columbia, S.C.), 25 February 1913.

City of Columbia, S.C. *Revised Ordinances of the City of Columbia, S.C., 1907*. Columbia: The R.L. Bryan Company, 1907.

“Civic League Meeting.” *The State* (Columbia, S.C.), 13 December 1916.

“Columbia Churches Crowded for Easter Sunday Services.” *The State* (Columbia, S.C.), 22 April 1946.

Cothran, James R. *Charleston Gardens and the Landscape Legacy of Loutrel Briggs*. Columbia: University of South Carolina Press, 2010.

\_\_\_\_\_. *Gardens of Historic Charleston*. Columbia: University of South Carolina Press, 1995.

“First Report Meeting Set for Hampton-Preston Workers.” *The State* (Columbia, S.C.), 19 May 1940.

The Garden Club of South Carolina. *Bulletin*, No. 32 (March 1945) and *Yearbook*, 1943-1944. Columbia, 1945.

The Garden Club of South Carolina. *Yearbook, 1994-1946*. Columbia, S.C., 1946.

The Garden Club of South Carolina, Inc. *75th Diamond Anniversary 1930-2005*. Gaffney, S.C.: Print Depot, 2005.

“Garden Scene of Sunrise Services,” *The Columbia Record* (Columbia, S.C.), 20 April 1946.

*Journal of the Senate of the First Session of the 86th General Assembly of the State of South Carolina, Being the Regular Session Beginning Tuesday, January 9, 1945*. Columbia, Printed under the Direction of the Joint Committee on Printing, General Assembly of South Carolina, 1946.

*Journal of the Senate of the Second Session of the 86th General Assembly of the State of South Carolina, Being the Regular Session Beginning Tuesday, January 8, 1946*. Columbia: Printed under the Direction of the Joint Committee on Printing, General Assembly of South Carolina, 1947.

Langley, Claudia Seabrook. “South Carolina Garden Club Convention Largest in Years; Next Meeting at Charleston.” *The State* (Columbia, S.C.), 12 April 1946.

Moore, John Hammond. *Columbia and Richland County: A South Carolina Community, 1740-1990*.  
Columbia: University of South Carolina Press, 1993.

“Mrs. R.H. Welch Heads Columbia Garden Club.” *The State* (Columbia, S.C.), 17 April 1945.

Steele, Betsy. “Memorial Garden Update.” In The Garden Club of South Carolina, Inc., *The South Carolina Gardener* 88:6 (Winter 2006).

Thomas, Lucille Gaffney. *Eleven Year History of the Garden Club of South Carolina Incorporated, 1950-1961*.  
Orangeburg, S.C.: The Garden Club of South Carolina, Inc., 1950.

“The Tree and Park Commission.” *The State* (Columbia, S.C.), 3 February 1905.

**Previous documentation on file (NPS):**

preliminary determination of individual listing (36 CFR 67 has been Requested)  
 previously listed in the National Register  
 previously determined eligible by the National Register  
 designated a National Historic Landmark  
 recorded by Historic American Buildings Survey # \_\_\_\_\_

recorded by Historic American Engineering Record # \_\_\_\_\_

**Primary location of additional data:**

State Historic Preservation Office  
 Other State agency  
 Federal agency  
 Local government  
 University  
 Other

Historic Columbia Foundation,  
1601 Richland Street,  
Columbia, S.C. 29201

Name of repository:

Historic Resources Survey Number (if assigned): \_\_\_\_\_

**10. Geographical Data**

**Acreage of Property** Less than one acre  
(Do not include previously listed resource acreage)

**UTM References**

(Place additional UTM references on a continuation sheet)

1	<u>17</u>	<u>495980</u>	<u>3763084</u>	3	<u>17</u>	<u>495929</u>	<u>3763011</u>
	Zone	Easting	Northing		Zone	Easting	Northing
2	<u>17</u>	<u>495610</u>	<u>2763044</u>	4	<u>17</u>	<u>495908</u>	<u>3763060</u>
	Zone	Easting	Northing		Zone	Easting	Northing

**Verbal Boundary Description** (describe the boundaries of the property)

The boundary of the South Carolina Memorial Garden represents a portion, as indicated, of Parcel 10 on the accompanying Richland County, South Carolina, Tax Map #0911, drawn at an original scale of 1" = 100'.

**Boundary Justification** (explain why the boundaries were selected)

The boundary is restricted to the footprint of the South Carolina Memorial Garden, measuring 220' on its northern and southern sides and 56' on its western and eastern sides.

---

**11. Form Prepared By**

---

name/title	1) John M. Sherrer, III, Director of Collections and Interpretation 2) J. Tracy Power, NR Co-Coordinator / Andrew W. Chandler, NR Co-Coordinator
organization	1) Historic Columbia Foundation 2) South Carolina SHPO, South Carolina Department of Archives and History
street & number	1) 1601 Richland Street 2) 8301 Parklane Road
city or town	Columbia
e-mail	1) <a href="mailto:jsherrer@historiccolumbia.org">jsherrer@historiccolumbia.org</a> 2) <a href="mailto:power@scdah.state.sc.us">power@scdah.state.sc.us</a>

---

---

**Additional Documentation**

---

Submit the following items with the completed form:

- **Maps:** A **USGS map** (7.5 or 15 minute series) indicating the property's location.  
A **Sketch map** for historic districts and properties having large acreage or numerous resources. Key all photographs to this map.
- **Continuation Sheets**
- **Additional items:** (Check with the SHPO or FPO for any additional items)

---

**Photographs:**

---

Submit clear and descriptive black and white photographs. The size of each image must be 1600x1200 pixels at 300 ppi (pixels per inch) or larger. Key all photographs to the sketch map.

Name of Property: South Carolina Memorial Garden  
Lincoln and Calhoun Streets  
City or Vicinity: Columbia  
County: Richland State: South Carolina

**Photographs 1-4:**

Photographer: John Hensel  
Date Photographed: 1949  
Location of Original  
Negatives: John Hensel Photograph Collection, Historic Columbia Foundation, Columbia, S.C.

**Number and Description:**

1 of 11: Main Garden Gate, Eastern Boundary (Lincoln Street), 1949  
2 of 11: Viewshed, Looking West, 1949  
3 of 11: Partial Viewshed, Looking North, 1949  
4 of 11: Viewshed, Looking East, St. Timothy Episcopal Church in Background, 1949

### Photographs 5-11:

Photographer: John M. Sherrer, III, Historic Columbia Foundation  
Date Photographed: 2008  
Location of Original  
Negatives: Historic Columbia Foundation, Columbia, S.C.

#### Number and Description:

5 of 11: Main Garden Gate, Eastern Boundary (Lincoln Street), 2008  
6 of 11: Viewshed, Looking West, 2008  
7 of 11: Partial Viewshed, Looking Northeast, 2008  
8 of 11: Viewshed, Looking East, St. Timothy Episcopal Church in Background, 2008  
9 of 11: Detail, Gate House or Tea Room, 2008  
10 of 11: Detail, Tool House or Gardener's Shed, 2008  
11 of 11: Detail, Fountain and St. Francis of Assisi Statue, 2008

### Plans, Graphics 12-15:

12: Loutrel W. Briggs, "General Design for the South Carolina Garden Club Memorial Garden." Charleston, S.C., 1956.  
13, 14, and 15: James R. Cothran, "South Carolina Memorial Garden: Garden Restoration Plan." Robert & Company, Atlanta, Ga., 2007.

**Paperwork Reduction Act Statement:** This information is being collected for applications to the National Register of Historic Places to nominate properties for listing or determine eligibility for listing, to list properties, and to amend existing listings. Response to this request is required to obtain a benefit in accordance with the National Historic Preservation Act, as amended (16 U.S.C.460 et seq.).

**Estimated Burden Statement:** Public reporting burden for this form is estimated to average 18 hours per response including time for reviewing instructions, gathering and maintaining data, and completing and reviewing the form. Direct comments regarding this burden estimate or any aspect of this form to the Office of Planning and Performance Management, U.S. Dept. of the Interior, 1849 C. Street, NW, Washington, DC.

UNITED STATES DEPARTMENT OF THE INTERIOR  
NATIONAL PARK SERVICE

NATIONAL REGISTER OF HISTORIC PLACES  
EVALUATION/RETURN SHEET

REQUESTED ACTION: RESUBMISSION

PROPERTY South Carolina Memorial Garden  
NAME:

MULTIPLE  
NAME:

STATE & COUNTY: SOUTH CAROLINA, Richland

DATE RECEIVED: 3/16/12 DATE OF PENDING LIST:  
DATE OF 16TH DAY: DATE OF 45TH DAY: 5/02/12  
DATE OF WEEKLY LIST:

REFERENCE NUMBER: 09000464

DETAILED EVALUATION:

   ACCEPT    RETURN    REJECT 4/2/12 DATE

ABSTRACT/SUMMARY COMMENTS:

*Corrected description.  
Better description + context for landscape  
architect Lancel Briggs.  
Astonia - C 1946-1957.  
Area sign. Landscape architecture*

RECOM./CRITERIA   C  

REVIEWER   Lori Schin  

TELEPHONE                     

DISCIPLINE   Landscape  

DATE   4/2/12  

DOCUMENTATION see attached comments Y/N see attached SLR Y/N

MEMORIAL GARDEN  
THIS GARDEN IS IN  
HONOR OF THE  
LARGE NUMBER OF  
SOLDIERS WHO DIED  
IN THE GREAT WORLD WAR  
1914-1918











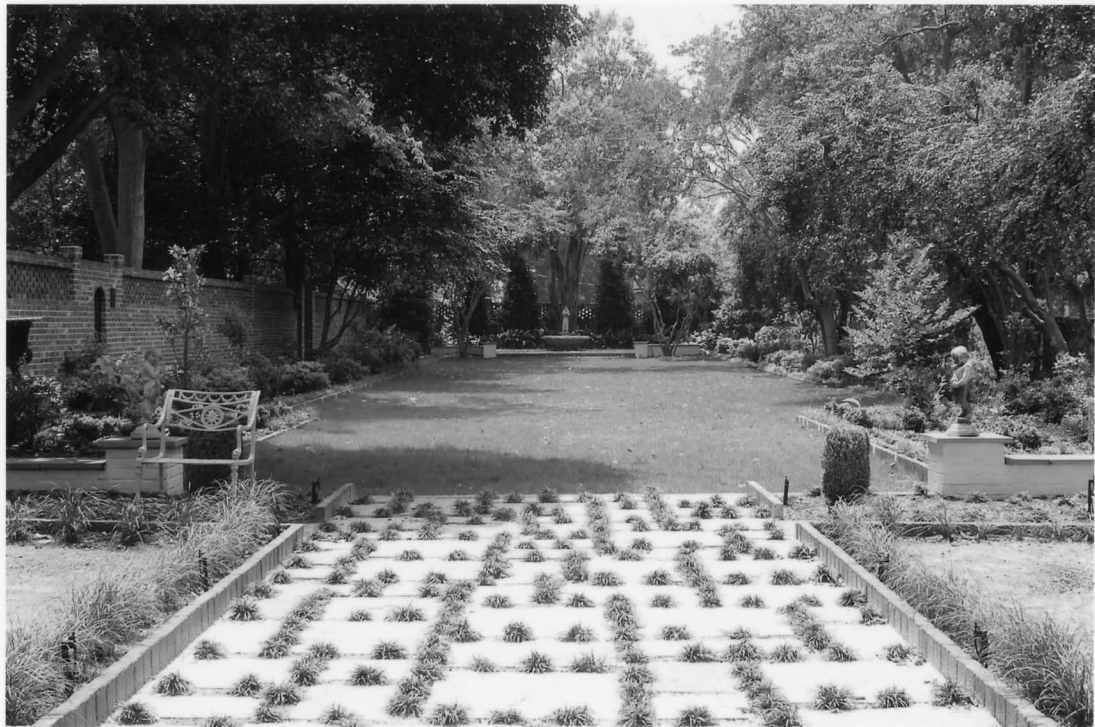











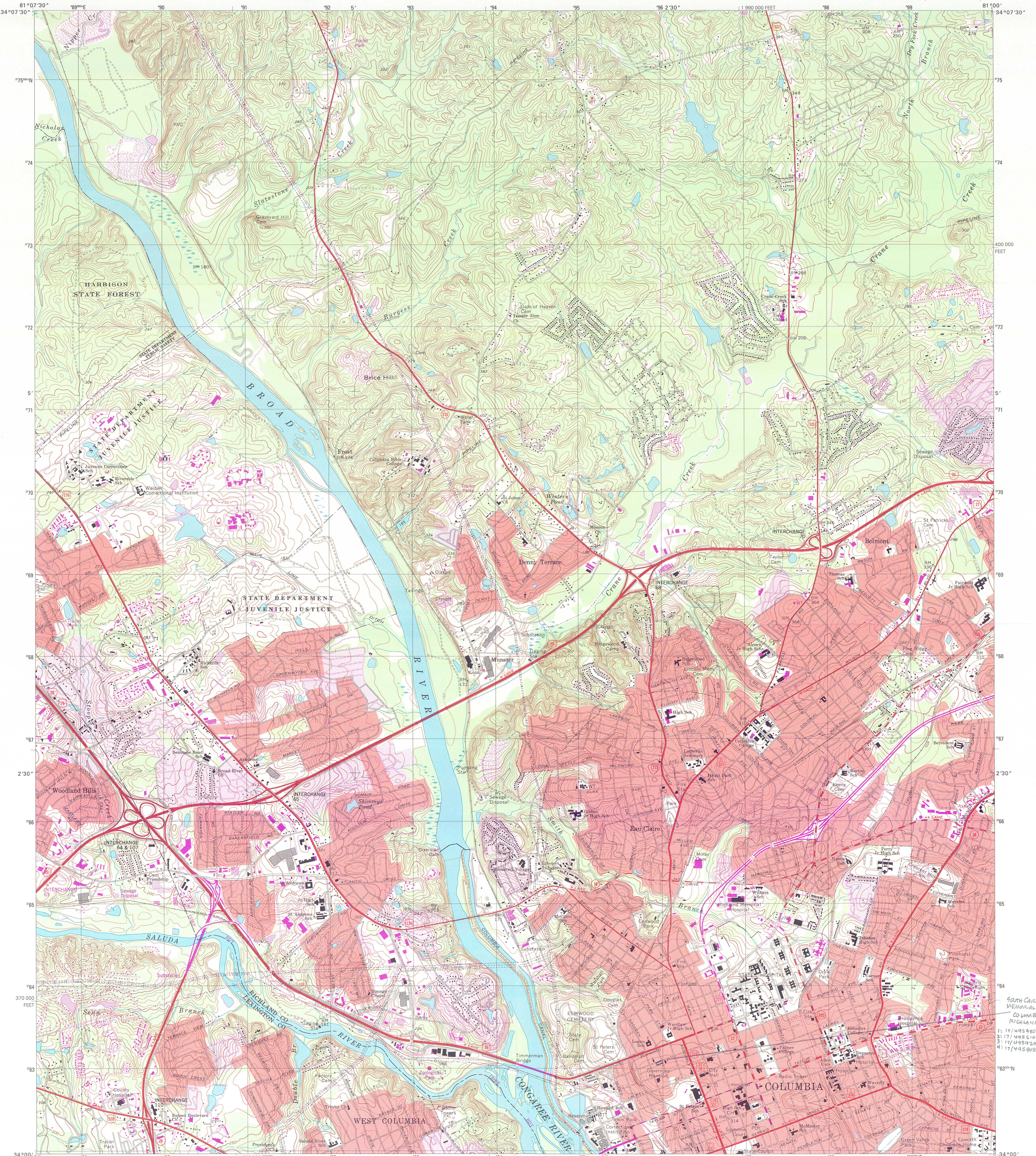

SCALE 1:24 000

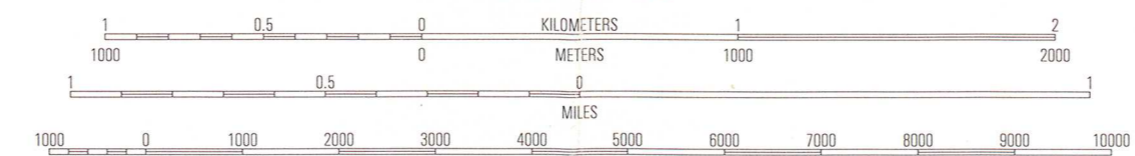

CONTOUR INTERVAL 10 FEET NATIONAL GEODETIC VERTICAL DATUM OF 1929 TO CONVERT FROM FEET TO METERS, MULTIPLY BY 0.3048

Produced by the United States Geological Survey Topography compiled 1971. Planimetry derived from imagery taken 1988 and other sources. Photoinspected using imagery dated 1997; no major culture or drainage changes observed. Survey control current as of 1972. Boundaries, other than corporate, revised 1999 North American Datum of 1927 (NAD 27). Projection and 10 000-foot ticks: South Carolina coordinate system, north zone (Lambert conformal conic) 1000-meter Universal Transverse Mercator grid, zone 17 North American Datum of 1983 (NAD 83) is shown by dashed corner ticks. The values of the shift between NAD 27 and NAD 83 for 7.5-minute intersections are obtainable from National Geodetic Survey NADCON software There may be private inholdings within the boundaries of the National or State reservations shown on this map Information shown in purple may not meet USGS content standards and may conflict with previously mapped contours

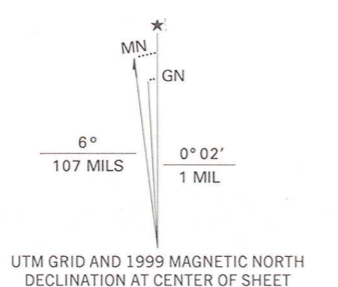

ROAD CLASSIFICATION table with symbols for primary/secondary highways, interstates, U.S. routes, and state routes.

QUADRANGLE LOCATION table with a grid of numbers 1-8 and corresponding location names.

COLUMBIA NORTH, SC 1997 NIMA 4752 II SE-SERIES V846

SOUTH CAROLINA MEMORIAL GARDEN COLUMBIA, RICHLAND CO., S.C. 1: 17/495 920/3763024 2: 17/495 610/3763044 3: 17/495 229/3763041 4: 17/495 908/3763060



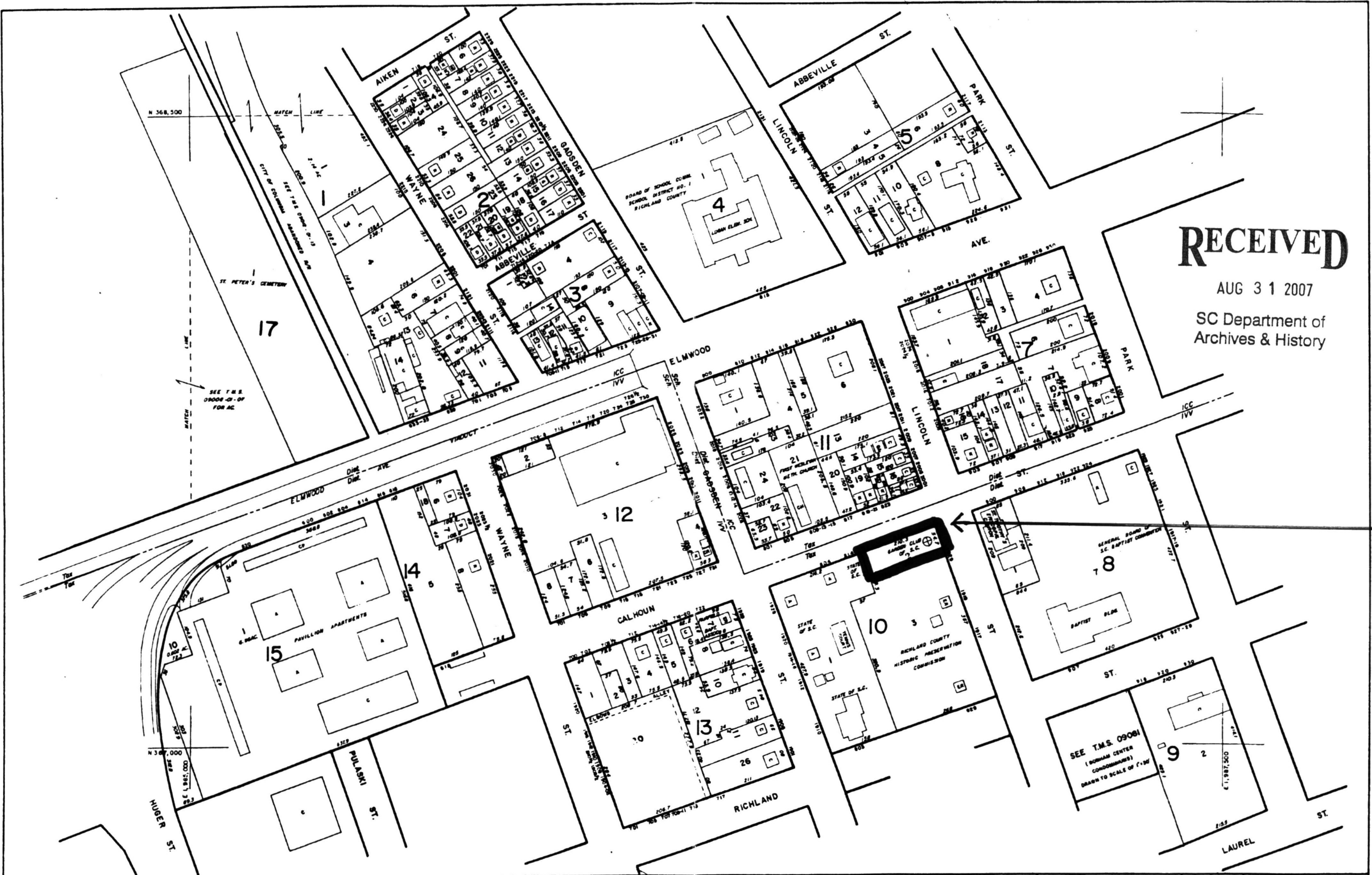

**RECEIVED**  
 AUG 31 2007  
 SC Department of  
 Archives & History

SOUTH CAROLINA  
 MEMORIAL  
 GARDEN  
 COLUMBIA,  
 RICHLAND  
 Co., S.C.

Prepared by <b>KUCERA</b> ASSOCIATES Professional Cartographers Columbia, S.C.	<b>REVISIONS</b>		<b>LEGEND</b> □ DENOTES BUILDING LINE R. RESIDENTIAL C. COMMERCIAL ETC. DENOTES SEPARATE COMP. FROM BUILDING (IN CL)	<b>50</b> 50 150 S 633 AC 1704	<b>PROPERTY TAX MAP</b> <b>RICHLAND COUNTY</b> SOUTH CAROLINA	<p>THIS MAP OR PHOTO SOLD BY THE RICHLAND COUNTY ASSESSOR'S OFFICE THE BOARD OF ASSESSMENT CONTRACTOR RESERVES THE EXCLUSIVE RIGHT TO SELL AND NO PURCHASE OR REPRODUCTION FOR SALE PURPOSES IS PERMITTED.</p>	<b>MAP KEY</b> 090-08 090-12 090-16 090-07 090-11 090-15 090-06 090-10 090-14	<b>GRAPHIC SCALE</b> 0 100 200 300 1" = 100' LOCATION AND DIMENSIONS OF BUILDINGS MAY NOT BE DRAWN TO SCALE		<b>PROPERTY MAP SHEET NO.</b> <b>09011</b> SCHOOL DISTRICT ICC,IVV
	DATE FIELD CHECKED	DATE LAST REVISED								
	12 / 83	12 / 04								
	12 / 84	12 / 06								
	12 / 85									
12 / 86	12 / 91									
12 / 87	12 / 98									
12 / 88	12 / 03									

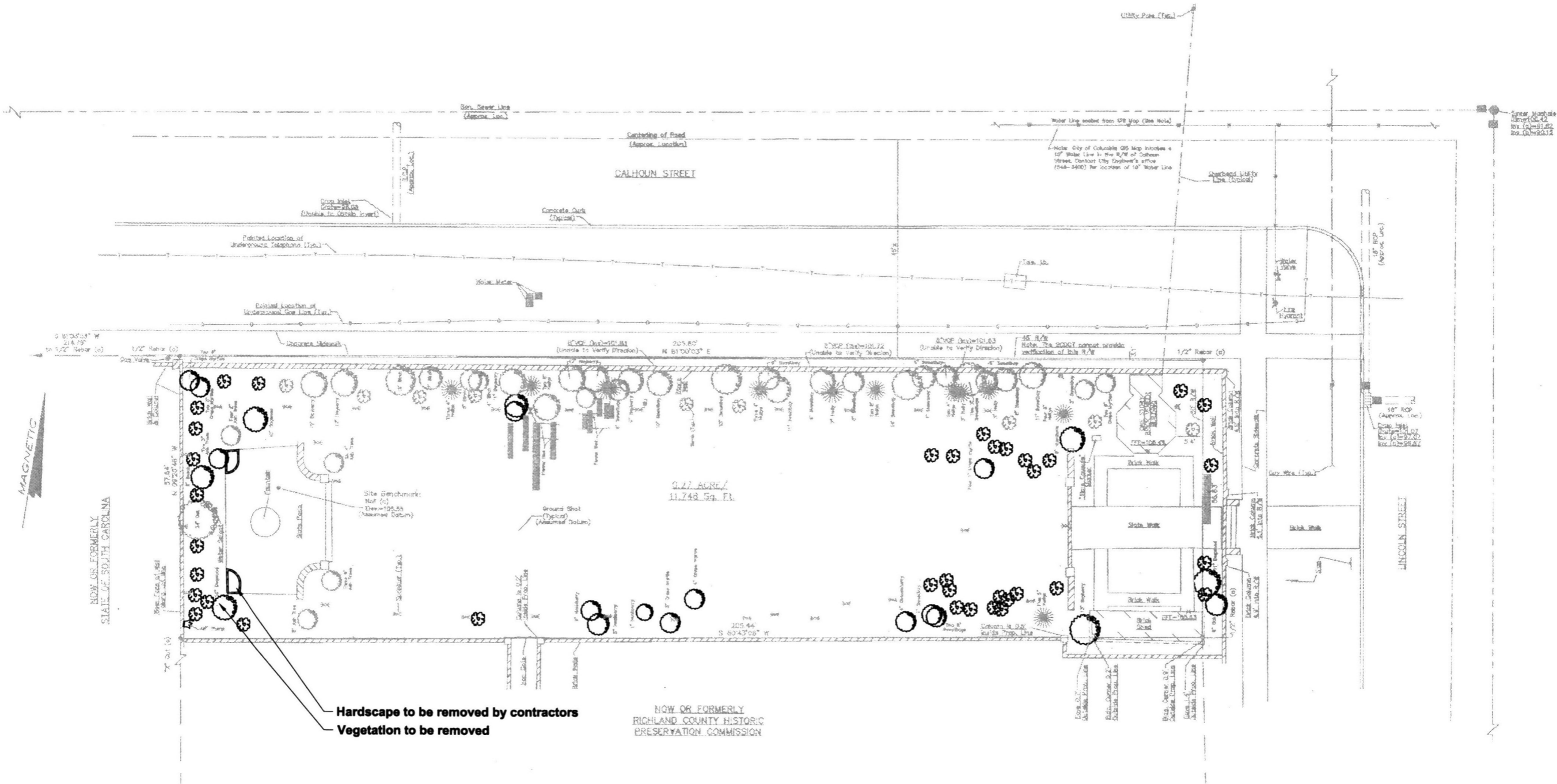

**NOTES:**  
 -VEGETATION & HARDSCAPE NOTED WITH BOLD LINE TO BE REMOVED.  
 -VOLUNTEERS TO REMOVE SMALL SHRUBS.  
 -CONTRACTOR TO REMOVE TREES TAGGED WITH TAPE AND OTHERS HIGHLIGHTED ON THIS REMOVAL PLAN.

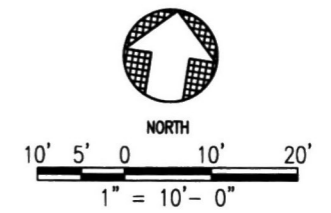

NO.	DATE	BY	REVISION

CLIENT: Garden Club of South Carolina  
 PROJECT: South Carolina Memorial Garden

DATE: July 14, 2007  
 SCALE: AS SHOWN  
 DRAWING TITLE: REMOVAL PLAN

DRAWING NO.: X-1.01  
 SHEET 2 of 4





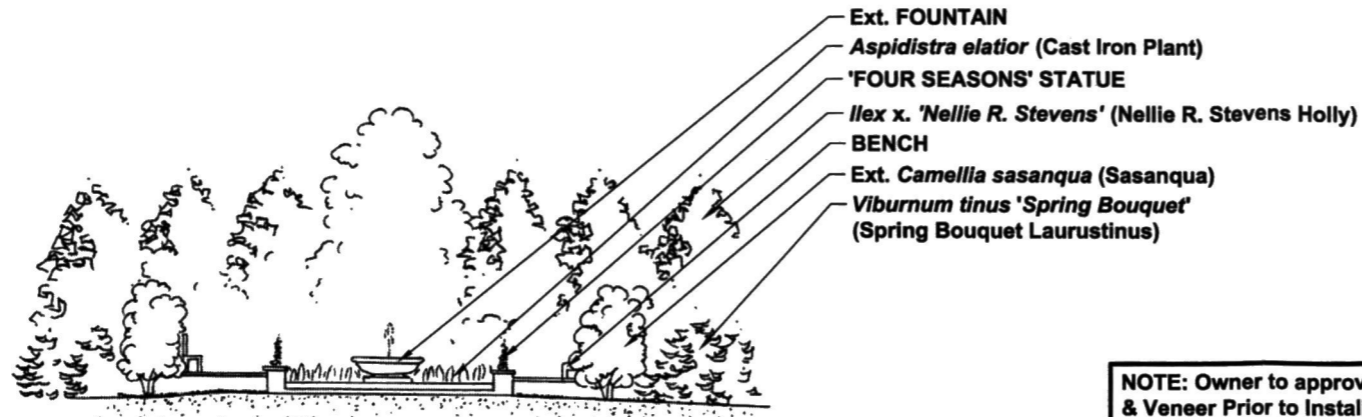

NOTE: Owner to approve Brick Paver & Veneer Prior to Installation

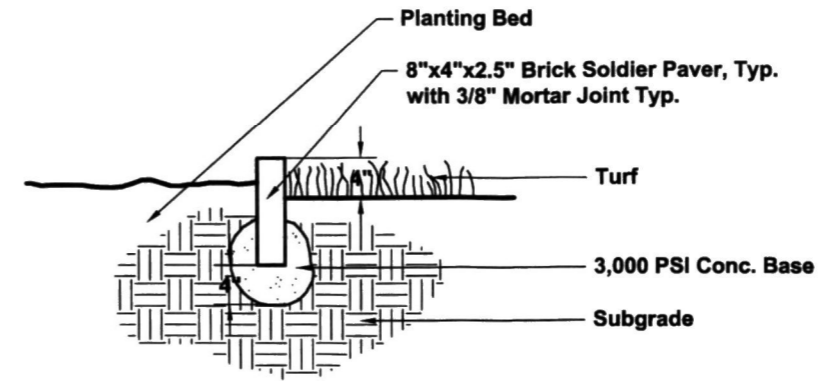

**A** FOUNTAIN  
 L-1.02 NTS

**D** BRICK PLANTING BED EDGING, TYP.  
 L-1.02 NTS

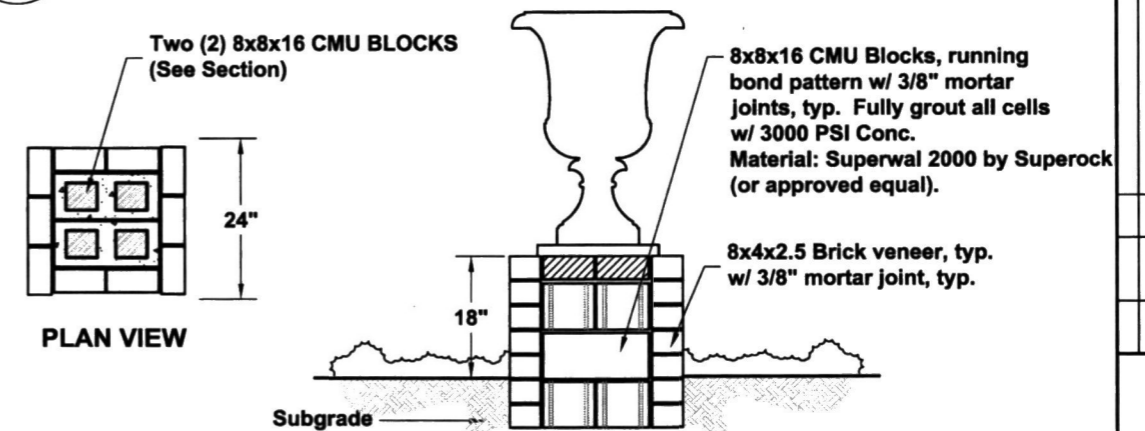
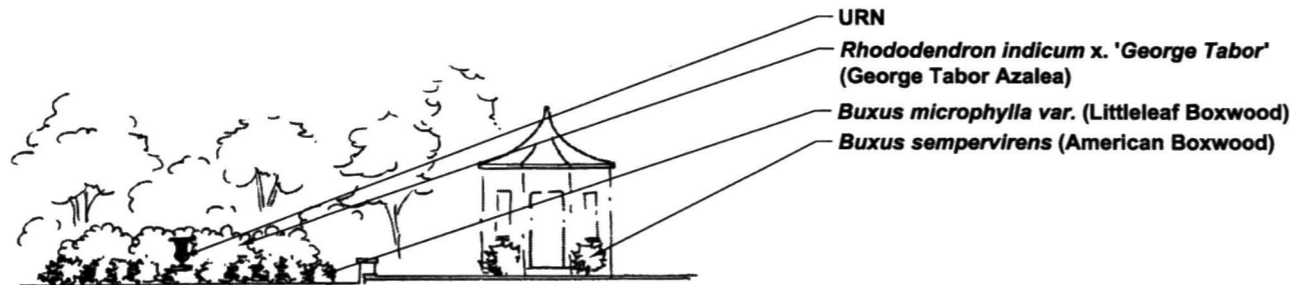

**B** GARDEN ENTRANCE  
 L-1.02 NTS

**E** PEDESTAL DETAIL, TYP.  
 L-1.02 NTS

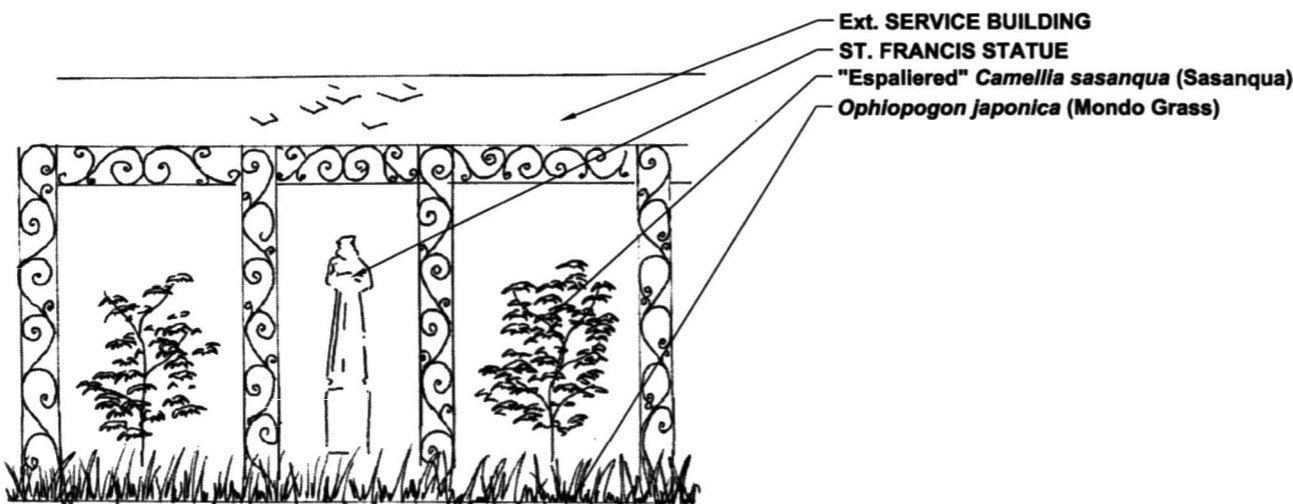

Quantity	Botanical Name	Common Name	Size	Comments
77	<i>Aspidistra elatior</i>	Cast Iron Plant	3 gal	
32	<i>Buxus microphylla</i> var.	Littleleaf Boxwood	3 gal	2' o.c. Clipped as hedge to 18" high
29	<i>Buxus sempervirens</i>	American Boxwood	3 gal	
15	<i>Camellia japonica</i>	Camellia	5 gal	
2	<i>Camellia sasanqua</i>	Sasanqua	5 gal	espaliered on service building
3	<i>Cornus florida</i>	Dogwood	2" cal.	
39	<i>Cyrtomium falcatum</i>	Holly Fern	3 gal	
5	<i>Gelsemium sempervirens</i>	Carolina Jessamine	1 gal	to grow on wall
1030	<i>Hedra helix</i>	English Ivy	4" pot	1' o.c.
9	<i>Ilex</i> x. 'Nellie R. Stevens'	'Nellie R. Stevens' Holly	3.5" cal.	for evergreen screening
25	<i>Illicium parviflorum</i>	Anise	3 gal	
15	<i>Ligustrum japonica</i>	Waxleaf Ligustrum	3 gal	
385	<i>Ophiopogon japonica</i>	Mondo Grass	4" pot	4" pots 4" o.c.
72	<i>Ophiopogon japonica</i> 'Nana'	Dwarf Mondo Grass	4" pot	4" pots 4" o.c.
25	<i>Parthenocissus tricuspidata</i>	Boston Ivy	8" pot	to grow on stone wall
27	<i>Rhododendron indicum</i> x. 'Fielder's White'	'Fielder's White' Azalea	3 gal	
19	<i>Rhododendron indicum</i> x. 'George Tabor'	'George Tabor' Azalea	3 gal	
11	<i>Viburnum tinus</i> 'Spring Bouquet'	Spring Bouquet Laurustinus	2 gal	

**C** SERVICE BUILDING FACADE  
 L-1.02 NTS

331 S.F.	Seasonal Color	Yellow Pansies (winter) / White Impatiens (summer)		
4,033 S.F.	<i>Stenotaphrum secundatum</i>	St. Augustine / Charleston Grass		
4	'The Four Seasons' Statues			2 placed at front, 2 at back
2	Urns			already purchased
existing	St. Francis Statue			to be moved in front of service building
existing	1- <i>Ligustrum lucidum</i>	Large Leaf Ligustrum		
existing	2- <i>Camellia sasanqua</i>	Multi-stem Sasanqua		to be judiciously pruned
existing	2- <i>Lonicera fragrantissima</i>	Winter Honeysuckle		
existing	1- <i>Cornus florida</i>	Dogwood		

**Robert and Company**  
 Engineers, Architects, Planners  
 229 Peachtree Street NE, Suite 2000  
 Atlanta, Georgia 30303  
 404-577-4000 FAX: 404-577-7119

NO.	DATE	BY	REVISION

DATE	PROJECT

DATE	SCALE	AS SHOWN	DETAILS & PLANT LIST
July 14, 2007	AS SHOWN	AS SHOWN	DETAILS & PLANT LIST

**L-1.02**  
 SHEET 4 of 4

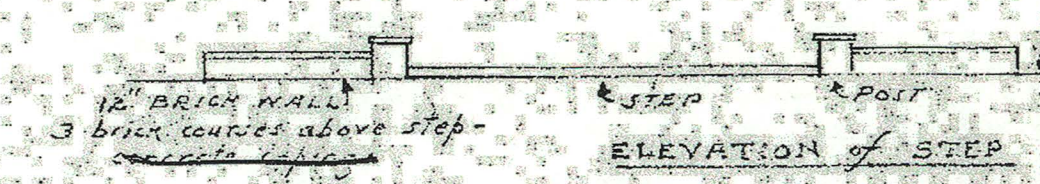
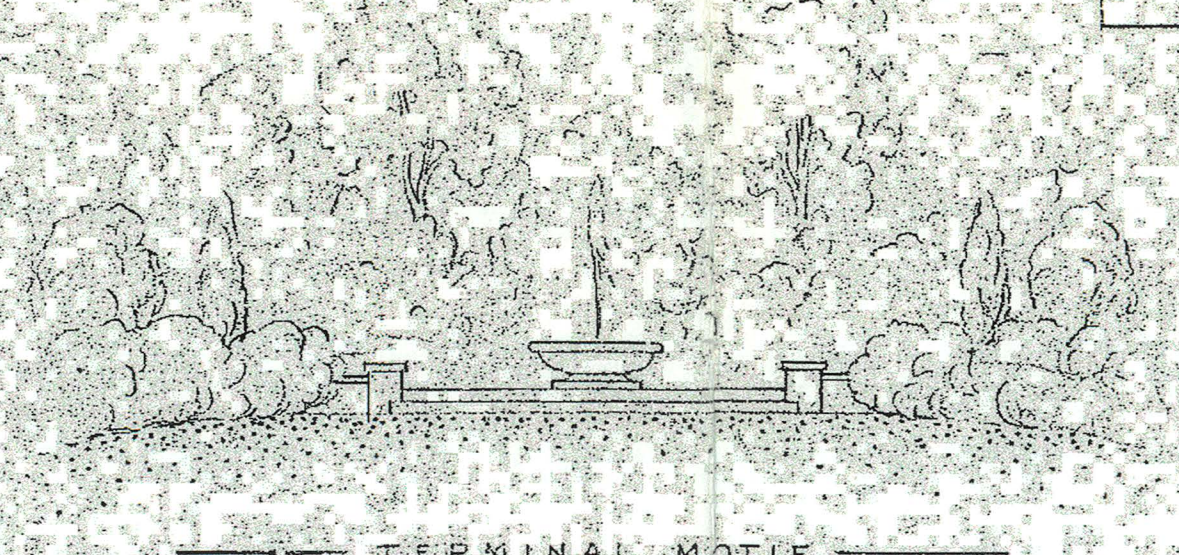
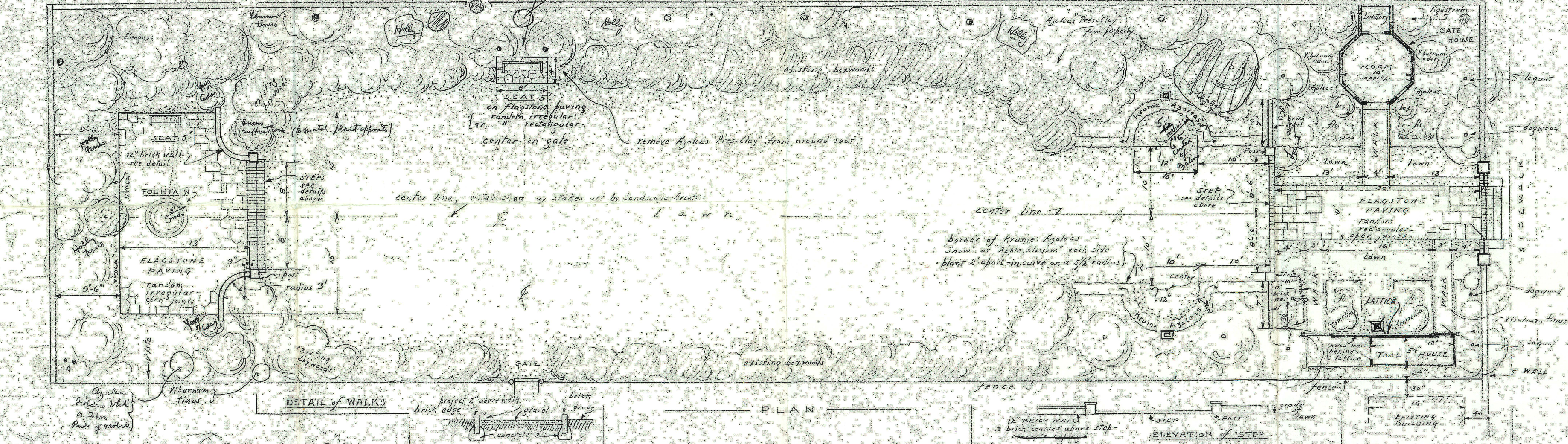

# GENERAL DESIGN

## THE SOUTH CAROLINA GARDEN CLUB MEMORIAL GARDEN LINCOLN & CALHOUN STREETS - COLUMBIA - S. C.

Scale - 1/8 inch equals 1 foot

Lourel W. Briggs - Landscape Architect - Charleston, S. C.

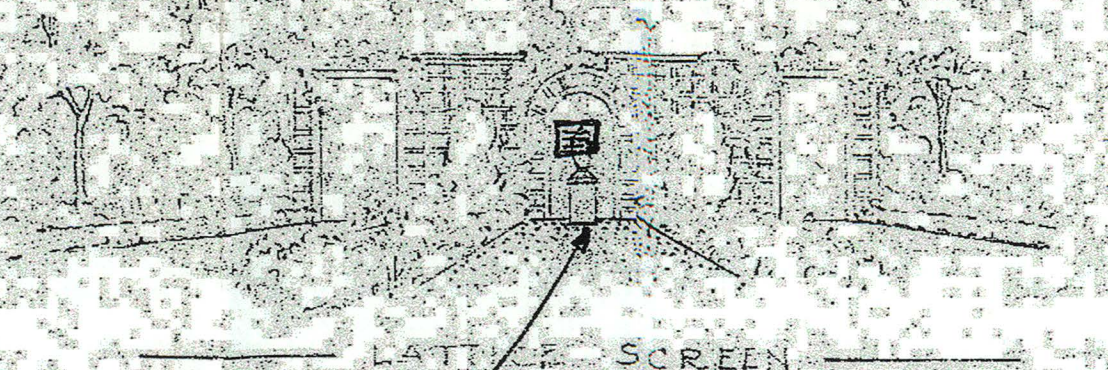
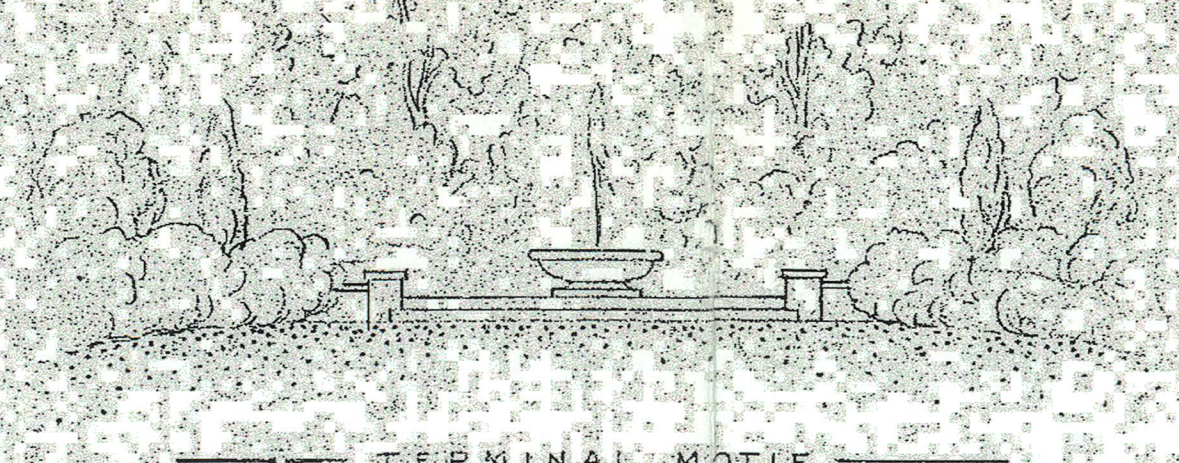

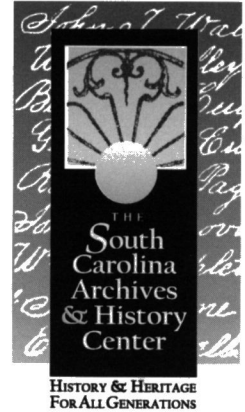
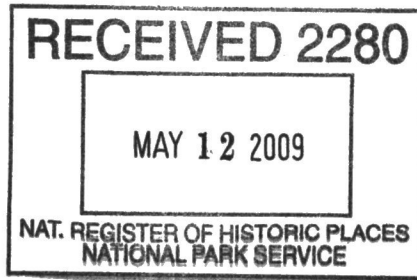

Friday, 8 May 2009

Dr. Janet Matthews  
Keeper, National Register of Historic Places  
U.S. Department of the Interior  
National Park Service  
1201 Eye (I) Street, NW, 8th Floor  
Washington, DC 20005

Dear Dr. Matthews:

Enclosed is the National Register nomination for the South Carolina Memorial Garden, in Richland County, South Carolina, recently approved by the South Carolina State Board of Review. We are now submitting this nomination for formal listing in the Register.

If I may be of further assistance, please do not hesitate to contact me at the address below, call me at (803) 896-6182, fax me at (803) 896-6167, or e-mail me at [power@scdah.state.sc.us](mailto:power@scdah.state.sc.us). I hope to hear from you soon.

Sincerely,

A handwritten signature in black ink, appearing to read "J. Tracy Power".

J. Tracy Power  
Historian and National Register Co-Coordinator  
State Historic Preservation Office