

1352

United States Department of the Interior
National Park Service

NATIONAL REGISTER OF HISTORIC PLACES
REGISTRATION FORM

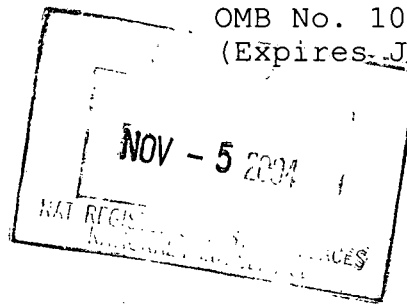

This form is for use in nominating or requesting determinations for individual properties and districts. See instructions in *How to Complete the National Register of Historic Places Registration Form* (National Register Bulletin 16A). Complete each item by marking "x" in the appropriate box or by entering the information requested. If any item does not apply to the property being documented, enter "N/A" for "not applicable." For functions, architectural classification, materials, and areas of significance, enter only categories and subcategories from the instructions. Place additional entries and narrative items on continuation sheets (NPS Form 10-900a). Use a typewriter, word processor, or computer, to complete all items.

=====

1. Name of Property

=====

historic name: **Great Northern Railway Steam Locomotive No. 1355 and Tender 1451**

other names: **Chief Ironhorse, GN1355, Engine 1494, GN1494, Engine 1020, GN1020**

=====

2. Location

=====

street & number **3400 Sioux River Road** not for publication N/A

city or town **Sioux City** vicinity N/A

state **Iowa** code **IA** county **Woodbury** code **193** zip code **51109**

=====

3. State/Federal Agency Certification

=====

As the designated authority under the National Historic Preservation Act, as amended, I hereby certify that this **X** nomination request for determination of eligibility meets the documentation standards for registering properties in the National Register of Historic Places and meets the procedural and professional requirements set forth in 36 CFR Part 60. In my opinion, the property **X** meets does not meet the National Register Criteria. I recommend that this property be considered significant **X** nationally statewide locally. (See continuation sheet for additional comments.)

Rowell G. Salce November 4, 2004
Signature of certifying official Date

STATE HISTORICAL SOCIETY OF IOWA
State or Federal Agency or Tribal government

In my opinion, the property _____ meets _____ does not meet the National Register criteria. (_____ See continuation sheet for additional comments.)

Signature of commenting official/Title

Date

State or Federal agency and bureau

=====
4. National Park Service Certification
=====

I, hereby certify that this property is:

entered in the National Register

_____ See continuation sheet.

determined eligible for the
National Register

_____ See continuation sheet.

determined not eligible for the
National Register

removed from the National Register

other (explain): _____

Edson A. Beall 12/15/04

for

Signature of Keeper

Date
of Action

=====
5. Classification
=====

Ownership of Property (Check as many boxes as apply)

private

public-local

public-State

public-Federal

Category of Property (Check only one box)

building(s)

district

site

structure

object

Number of Resources within Property

Contributing

 2

Noncontributing

_____ buildings

_____ sites

_____ **structures**

_____ objects

_____ Total

Number of contributing resources previously listed in the National Register 0

Name of related multiple property listing (Enter "N/A" if property is not part of a multiple property listing.)

``N/A``

=====
6. Function or Use
=====

Historic Functions (Enter categories from instructions)

Cat: Transportation

Sub: Rail-related

_____	_____
_____	_____
_____	_____
_____	_____
_____	_____

Current Functions (Enter categories from instructions)

Cat: Transportation

Sub: Rail-related

Work in Progress

_____	_____
_____	_____
_____	_____
_____	_____
_____	_____

=====
7. Description
=====

Architectural Classification (Enter categories from instructions)

Other: Steam Locomotive

Tender

Materials (Enter categories from instructions)

foundation _____

roof _____

walls _____

other **Metal: steel**

Metal: brass

Narrative Description (Describe the historic and current condition of the property on one or more continuation sheets.)

=====
8. Statement of Significance
=====

Applicable National Register Criteria (Mark "x" in one or more boxes for the criteria qualifying the property for National Register listing)

- A Property is associated with events that have made a significant contribution to the broad patterns of our history.
- B Property is associated with the lives of persons significant in our past.
- C Property embodies the distinctive characteristics of a type, period, or method of construction or represents the work of a master, or possesses high artistic values, or represents a significant and distinguishable entity whose components lack

individual distinction.

___ D Property has yielded, or is likely to yield information important in prehistory or history.

Criteria Considerations (Mark "X" in all the boxes that apply.)

___ A owned by a religious institution or used for religious purposes.

___ B removed from its original location.

___ C a birthplace or a grave.

___ D a cemetery.

___ E a reconstructed building, object, or structure.

___ F a commemorative property.

___ G less than 50 years of age or achieved significance within the past 50 years.

Areas of Significance (Enter categories from instructions)

**Transportation
Engineering**

Period of Significance **1924-1955**

Significant Dates **ca. 1943**

Significant Person (Complete if Criterion B is marked above)

Cultural Affiliation

Architect/Builder **Great Northern Railway Mechanical Department**

Narrative Statement of Significance (Explain the significance of the property on one or more continuation sheets.)

=====
9. Major Bibliographical References
=====

(Cite the books, articles, and other sources used in preparing this form on one or more continuation sheets.)

Previous documentation on file (NPS)

___ preliminary determination of individual listing (36 CFR 67) has been requested.

___ previously listed in the National Register

___ previously determined eligible by the National Register

___ designated a National Historic Landmark

___ recorded by Historic American Buildings Survey # _____

___ recorded by Historic American Engineering Record # _____

Primary Location of Additional Data

State Historic Preservation Office

___ Other State agency

___ Federal agency

___ Local government

___ University

___ Other

Name of repository: _____

=====
10. Geographical Data
=====

Acreeage of Property Less than one

UTM References (Place additional UTM references on a continuation sheet)

	Zone	Easting	Northing	Zone	Easting	Northing
1	14	707440	4711280	3	_____	_____
2	___	_____	_____	4	_____	_____
	___	See continuation sheet.				

Verbal Boundary Description (Describe the boundaries of the property on a continuation sheet.)

Boundary Justification (Explain why the boundaries were selected on a continuation sheet.)

=====
11. Form Prepared By
=====

name/title: **Narrative by Larry Obermeyer and Doug Bemrich
graphics, tables, and charts by Matthew Merk and Ben Ringnalda**

organization **Siouxland Historical Railroad Association** date: **June 9, 2004**

street & number **3400 Sioux River Road, P O Box 1355** telephone **712-276-6432**

city or town **Sioux City** state **IA** zip code **51102-1355**

=====
Additional Documentation
=====

Submit the following items with the completed form:

Continuation Sheets

Maps

- A USGS map (7.5 or 15 minute series) indicating the property's location.
- A sketch map for historic districts and properties having large acreage or numerous resources.

Photographs

Representative black and white photographs of the property.

Additional items (Check with the SHPO or FPO for any additional items)

=====
Property Owner
=====

(Complete this item at the request of the SHPO or FPO.)

name **Siouxland Historical Railroad Association**

street & number **3400 Sioux River Road, P O Box 1355** telephone **712-276-6432**

city or town **Sioux City** state **IA** zip code **51102-1355**

=====
Paperwork Reduction Act Statement: This information is being collected for applications to the National Register of Historic Places to nominate properties for listing or determine eligibility for listing, to list properties, and to amend existing listings. Response to this request is required to obtain a benefit in accordance with the National Historic Preservation Act, as amended (16 U.S.C. 470 et seq.). A federal agency may not conduct or sponsor, and a person is not required to respond to a collection of information unless it displays a valid OMB control number.

Estimated Burden Statement: Public reporting burden for this form is estimated to average 18.1 hours per response including the time for reviewing instructions, gathering and maintaining data, and completing and reviewing the form. Direct comments regarding this burden estimate or any aspect of this form to Keeper, National Register of Historic Places, 1849 "C" Street NW, Washington, DC 20240.

**United States Department of the Interior
National Park Service**

**National Register of Historic Places
Continuation Sheet**

Section number 7

Page 1

Description

Great Northern Railway Steam Locomotive No. 1355, rebuilt by the Great Northern Railway in 1924, is unique in steam locomotive technology and steam railroad operations. The railroad, under the direction of its mechanical department, chose a distinct class of ten wheel-style steam locomotives to rebuild into the new twelve-wheel, Pacific-style that had the latest steam technology of the times. Included in this National Register nomination is the sole surviving locomotive of fifty-two steam locomotives that underwent this conversion by the Great Northern Railway's mechanical department.

Great Northern Railway Steam Locomotive No. 1355 is a medium Pacific-style locomotive with a (4-6-2) wheel arrangement of four pilot wheels, six driving wheels, and two trailing wheels. The locomotive is located in Sioux City, Iowa at the Milwaukee Railroad Shops Historic District. Since it was originally constructed in 1909, the locomotive underwent one major reconstruction in 1924; and is currently under restoration to an operating condition.

In 1924 the locomotive was rebuilt from a smaller (4-6-0) wheel arrangement of four pilot wheels, six driving wheels, and zero trailing wheels, and had new engineering steam technologies added to the locomotive including a Belpaire boiler, superheated steam, and various other steam appliances. (Much of its original 1909 construction still exists, including the boiler barrel, smoke box, and cab.) The locomotive retains its original 1924 rebuilt appearance and continues to reflect its historical association with steam technology advancements, the Great Northern Railway and the nation's railroad heritage.

The locomotive is constructed of steel and iron. The locomotive's cab is constructed of steel, with interior tongue and groove woodwork in the floor and walls. Glass is used in the locomotive's windows, headlights, and steam gauges and valves. The locomotive's whistle, bell, throttle appliances, and wheel bearings and bushings are constructed of brass.

Tender 1451 was added to the locomotive in the 1940's when Engine 1355 was placed into freight service in Minnesota. Tender 1451 is a standardized tank-tender design that was assigned to freight service locomotives so that locomotives could be quickly identified as "in freight service." The tender was constructed by the Great Northern Railway (ca. unknown).

Both the locomotive and tender are suffering deterioration from twenty-nine years of outdoor exhibition (1955 – 1984) as a historical landmark commemorating Sioux City's growth into the nation's tenth largest railroad center during the first three decades of the twentieth century. The locomotive is being restored to an operating condition under CFR 230 of the Federal Railroad Administration (FRA) rules governing the restoration of historic steam locomotives.

Once restored, the steam locomotive and tender will be placed on permanent exhibition as an interpretive artifact within the roundhouse building at the Milwaukee Railroad Shops Historic District. During special events the locomotive will be operated for the purpose of pulling special excursion/passenger trains in the Midwest and Pacific Northwest.

**United States Department of the Interior
National Park Service**

**National Register of Historic Places
Continuation Sheet**

Section number 7

Page 2

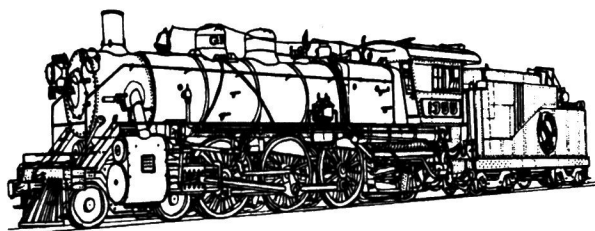

**Great Northern Railway Steam Locomotive No. 1355 and Tender No. 1451
Sioux City, Iowa**

• **Originally Great Northern Railway Steam Locomotive No. 1020**

Original Builder: Baldwin Locomotive Works

Builder's No. 33908

Original Building Date: 1909

Great Northern Railway Locomotive Class: E-14 Ten-wheel Style Locomotive

Wheel Arrangement: 4-6-0

• **Rebuilt at the Dale Street Shops of the Great Northern Railway (St. Paul, Minnesota)**

Rebuild Dates: 02/19/24 – 05/29/24

Great Northern Railway Locomotive Class: H-5 Pacific-Style Locomotive

Renumbered to Locomotive No. 1494

Wheel Arrangement: 4-6-2

• **Renumbered to Locomotive No. 1355 on April 10, 1926**

- **Disposition (per Great Northern records): Placed on exhibition at the Municipal Auditorium, Sioux City, Iowa, on July 14, 1955**

Current Owner: Siouxland Historical Railroad Association, Sioux City, Iowa

Previous Owners: Great Northern Railway (1909 - 1955)
City of Sioux City, Iowa (1955 - 1984)

Current Condition: Under Restoration

**United States Department of the Interior
National Park Service**

**National Register of Historic Places
Continuation Sheet**

Section number 7

Page 3

**Specifications for
Great Northern Railway Steam Locomotive No. 1355 & Tender No. 1451**

- **Description:** Passenger locomotive, Pacific-type 4-6-2
Class H-5, Building Cost: \$32,118.96 (1924)
- **Specifications:**

Cylinders	23 1/2" x 30"
Valve	Piston, 12" diameter
Valve Gear	Walschearts
Boiler Pressure	210 lbs. per square inch (psi)
Operating Pressure	200 lbs. per square inch (psi)
Weight on Drivers	176,000 lbs.
Weight of Total Engine	282,800 lbs.
Weight of Tender (loaded)	152,000 lbs.
Total Weight of Engine and Tender	439,000 lbs.
Capacity of Tender - Oil	5,000 gals.
Water	8,000 gals.
Factor of Adhesion	4.27
Tractive Effort	40,050 lbs.
Tubes - Diameter	2-1/4" and 5-1/2"
Length	21'0"
Number - 2-1/4" fire tubes	156
5-1/2" superheater	32
Heating Service of: Tubes	2,883.0 square feet
Firebox	274.0 square feet
Total	3,157.0 square feet
Superheating Surface	774.0 square feet
Grate Area	50.4 square feet
Dimensions of Firebox: Length	110-inches
Width	66-inches
Height at Front	72-inches
Height at rear	64-inches
Wheels: Drivers Number	6
Diameter	73-inches
Front Engine Truck Number	4
Diameter	36-inches
Trailing Truck Number	2
Diameter	45-inches
Journals: Driver (main)	10-1/2" x 12"
Driver (others)	9-1/2" x 12"
Front Truck	6" x 12"
Trailing Truck	8" x 14"
Tender	5-1/2" x 10"

**United States Department of the Interior
National Park Service**

**National Register of Historic Places
Continuation Sheet**

Section number 7

Page 4

**Chronological History of Service Modifications to Steam Locomotive No. 1355
(Per Great Northern records)**

November 13, 1909	Great Northern Railway Engine No. 1020, Class E-14, 4-6-0 Construction Number 33908 Delivered from Baldwin Locomotive Works
February - May 1924	Engine No. 1020 rebuilt to Class H-5, Pacific-type 4-6-2 Renumbered to Engine No. 1494
January 1925	Equipped with booster engine
10 April 1926	Engine No. 1494 renumbered to Engine No. 1355
June 1929	Converted from coal to oil burning
June 1929	Delta trailing truck and Franklin booster engine removed
April 1937	Power reverse applied, Alco Type K
October 1941	Mechanical force feed lubricator replaced with hydrostatic lubricator, Ale mite grease fittings and guns applied
June 1944	Nathan low water alarm installed
April 1945	Air operated cylinder drain cocks applied
June 1945	New driving axles applied
May 1947	Emergency brake valve installed on tender
March 1948	Auxiliary air reservoir installed for power reverse
July 1955	Retired from service, placed on public exhibition in Sioux City, Iowa
June 1984	Removed from public exhibition for restoration.

These specifications and dates are taken from official records of the mechanical department of the Great Northern Railway (a.k.a.: AFE Records). The records reflect the locomotive at the time of retirement. Therefore some specifications may differ from earlier published figures. (Source: Norman Keyes, Jr.)

**United States Department of the Interior
National Park Service****National Register of Historic Places
Continuation Sheet**

Section number 8

Page 5

Statement of Significance:

Great Northern Railway Steam Locomotive No. 1355 is nationally significant under Criteria C as a rare surviving example of the "Pacific-style" locomotive and as an example of engineering design of a type and method of construction important in railroad history. It is also significant under National Register Criteria A for its long association with rail travel, and for its association with the Great Northern Railway and the development and promotion of Glacier National Park.

1. Compared to other surviving steam locomotives, No. 1355 is the nation's best remaining example of a steam locomotive that has direct ties to the promotion of early travel to Glacier National Park through its "Glacier Park" paint scheme. Only the Great Northern Railway painted steam locomotives with a paint scheme to promote the development of the National Park System.
2. Secondly, this steam locomotive is "mechanically significant" to our industrial heritage because it represents a line of smaller class steam locomotives to be rebuilt to a larger class of steam locomotives. This rebuilding included the addition of the following advancement in steam technology at the time: the Belpaire boiler, larger firebox, superheated steam, and a new wheel arrangement. Engine No. 1355 is the nation's only surviving example of a conversion steam locomotive.
3. This locomotive is significant as a preserved example of the "Pacific-style" steam locomotive that did much to define the railroad character of the United States and our migration into the Pacific Northwest.
4. Great Northern Railway Steam Locomotive No. 1355 is critically important as a historic resource because this locomotive represents a line of Great Northern Railway steam locomotives dating back to 1909 and is the only surviving member of her class.

In October 1909, the Baldwin Locomotive Works originally built Great Northern Railway Steam Locomotive No. 1355 as a 4-6-0 ten-wheel arrangement steam locomotive originally numbered 1020. This locomotive was the 33,908 steam locomotive to be built by the Baldwin Locomotive Works.

The Great Northern Railway accepted delivery of the steam locomotive on November 13, 1909 in St. Paul, Minnesota at the Dale Street Shops. The locomotive was set up for service as a Class E-14 coal burning locomotive. On May 17, 1912 the steam locomotive was converted from a coal burner to an oil burner at the Great Northern Railway's Hillyard Shops. In 1921, the locomotive was again taken to the Hillyard Shops, where on April 29, 1921 the locomotive was converted from an oil burner to a coal burner. According to the engine service records of the Great Northern Railway, which are available only as far back as 1919, this locomotive was in passenger service on the Spokane Division, starting in August, 1919. Records of the 1020 are few, and no photograph has yet surfaced of this Ten-wheeler.

On February 19, 1924, Engine No. 1020 entered the Great Northern Railway's Dale Street Shops in Saint Paul for rebuilding. The locomotive was dismantled and rebuilt to a Class H-5 (4-6-2) twelve-wheel

**United States Department of the Interior
National Park Service**

**National Register of Historic Places
Continuation Sheet**

Section number 8

Page 6

Pacific-style locomotive with superheaters. On May 29, she emerged as Engine No. 1494, the eighth H-5 to be completed. After the conversion, the locomotive was assigned to passenger service on the Old St. Cloud Division. Records of her early service are sketchy, although being a coal burner at that time; she was no doubt assigned to the east end of the Great Northern Railway.

Engine No. 1494 was a typical early Class H-5 rebuilding project. The 1926 diagram shows her to have a weight of 260,000 pounds. This was to be revised several times throughout the engine's service history. Engine No. 1494 carried a Delta rear cradle and trailing truck as rebuilt, and that cost \$32,424 at the time.

On April 10, 1926 the locomotive was renumbered to Engine No. 1355, the number she wears to this day. Engine No. 1494 was the last H-5 to be renumbered from the 1400 series into the 1350 bracket. She went back to Dale Street Shops to be fitted with a trailing truck booster engine. Weight was raised to 271,000 pounds, with 164,000 remaining on the drivers. On May 29, 1929 Engine No. 1355 was converted from a coal burner to an oil burner.

In June 1929, Engine No. 1355 lost her booster engine and the Delta trailing truck, the latter being replaced by a Hodge trailing-truck of the type carried by locomotive classes H-4's and O-1's. Several O-1 Mikado-style locomotives received Delta trailing-trucks and boosters in this time frame.

After the conversion, the locomotive was transferred from the St. Cloud Division to the Old Montana section of the Butte Division. Although specific records do not survive, a display sign furnished by the Great Northern Railway in 1955 states that this locomotive was one of the engines assigned to handling the *Oriental Limited*, a named passenger train on the westbound sections of the Great Northern Railway System.

After serving on the Butte Division for many years, in June 1953, Engine No. 1355 was transferred over to the Mesabi Division in Minnesota. From 1953 to 1955, Engine No. 1355 was placed into ore-train service and branch-line passenger and freight service.

In 1955 the Great Northern Railway donated this last active (Class H-5) steam locomotive to the city of Sioux City. This was done at the suggestion of Sioux Cityan I. W. Reck who wanted to create a memorial to all the railroaders in Sioux City's rich railroad past. In 1954, Mr. Reck wrote a letter to the Great Northern Railway seeking the donation of a steam locomotive. John Budd, president of the Great Northern Railway and a former trainmaster in Sioux City for the railroad, approved the donation of Engine 1355 to the City of Sioux City. The locomotive was shipped at Wilmar, Minnesota, carefully restored to a "better than" new appearance and moved to the grounds of the Sioux City Municipal Auditorium. Upon receiving the steam locomotive, the City of Sioux City set the locomotive up as the *Old Chief Ironhorse Memorial*. For the next twenty-nine years the locomotive was referred to as: *Old Chief Ironhorse*

In 1984, Lawrence (Larry) J. Obermeyer, a retired railroad conductor and yardmaster, formed the Siouxsland Historical Railroad Association for the purpose of restoring this locomotive back to a running condition. This locomotive is currently undergoing restoration at the former Milwaukee Shops, a.k.a. the Chicago, Milwaukee and St. Paul Railroad Shops and Roundhouse Historic District, in Sioux City, Iowa.

**United States Department of the Interior
National Park Service**

**National Register of Historic Places
Continuation Sheet**

Section number 8

Page 7

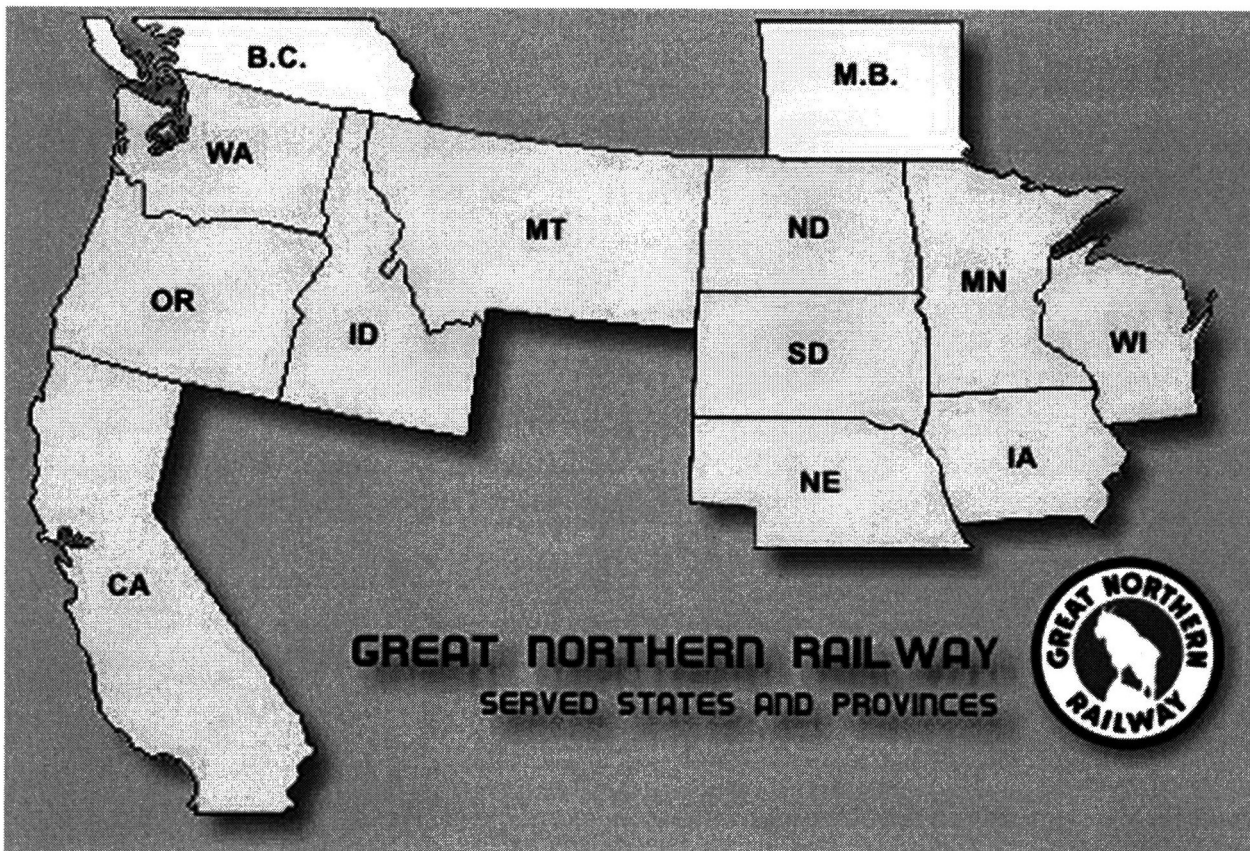

Map by Ben Ringalda, <http://www.greatnorthernempire.net/>

The Great Northern Railway and Sioux City, Iowa

The Great Northern Railway was the last of the Nation's six transcontinental railroads to be built. Completed in 1893, the railroad was built by James J. Hill after the federal government had stopped the land grant give-away along the railroad right of way. The following map illustrates the Great Northern Railway's service territory, which consisted of eleven states and two Canadian Provinces.



**United States Department of the Interior
National Park Service****National Register of Historic Places
Continuation Sheet**

Section number 8

Page 8

Map courtesy of Ben Ringalda, <http://www.greatnorthernempire.net>

In the late 19th century, Sioux City was well connected with railroads, which radiated in nearly every direction, forming the hub of a great wheel. However the meat packers and other local industrialists wanted to have a more direct route to Duluth, the Great Lakes, and the Pacific Northwest.

To achieve this end, local business people formed the Sioux City and Northern Railroad in 1887, a predecessor line of the Great Northern Railway. This group decided to build an independent railroad that would have a line from Sioux City to Duluth where it would meet the Great Northern Railway. Signing a 30-year traffic contract with the Great Northern Railway, the Sioux City & Northern Railroad remained independent for a decade. Traffic flowed between the two roads in increasing amounts to the satisfaction of both railroads.

The Panic of 1893 wreaked havoc on Sioux City and its industrial growth. The Sioux City and Northern Railroad was no stranger to this economic depression. Sioux City was devastated and the railroad went into receivership. Slowly and painfully the city recovered from the depression, but the Sioux City and Northern Railroad continued to flounder in receivership, finally going bankrupt.

In 1900, James J. Hill acquired the Sioux City and Northern Railroad into his rapidly expanding railroad domain. This line became a very important corridor for the Great Northern Railway system, both in terms of freight and passenger service into this area.

Two Great Northern Railway presidents came from Iowa. The first Iowan to head the Great Northern was Ralph Budd. He was born on a farm near Washburn, Iowa on August 20, 1879. Budd was an engineering genius for the railroad industry. He began his career with the Rock Island Railroad in 1902, eventually moving to the Great Northern. At the age of 40, Ralph Budd was elected president of the railroad in 1919.

The second Iowan to become president of the Great Northern was John Budd, son of Ralph. From 1933 to 1940, John was assistant trainmaster and later trainmaster at various points on the system. Sioux City

**United States Department of the Interior
National Park Service****National Register of Historic Places
Continuation Sheet**

Section number 8

Page 9

was one of his locales where he was stationed. He was elected president of the Great Northern Railway in 1951. Prior to this position, he was elected president of the Chicago and Eastern Illinois Railroad in 1947. At that time, he was the youngest president of any Class I railroad in the United States.

Sioux City and Iowa played an important role in the Great Northern Railway system. The only Iowa presence that this transcontinental railroad had was the line that ran from Sioux City to Willmar, Minnesota and on up to the Twin Cities. Sioux City was the southernmost part of the Great Northern Railway system.

The 1950's saw the rapid scrapping of steam locomotives as the railroads transitioned from steam to the more efficient diesel-electric locomotives. I. W. Reck felt that the steam locomotive would be a universal recognizable monument. However, railroads were not that public-spirited. Finally, John Budd, then president of the Great Northern Railway, agreed to donate a steam locomotive to Sioux City. On July 14, 1955 Great Northern Railway Engine No. 1355 was presented to the City of Sioux City as a gift of the Great Northern Railway. The locomotive was set up as the Old Chief Ironhorse Memorial for the purpose of paying homage to the Great Northern Railway's presence in Iowa, the steam locomotive era, and to the role that Sioux City played as a dominant railroad center.

Classifying the Steam Locomotive

A steam locomotive mainly consists of four parts:

1. The boiler, which is the apparatus that generates steam;
2. The engine, which is the mechanism for utilizing the steam
3. The wheels, frames, and springs that form the infrastructure to move the whole locomotive from place to place;
4. And the tender, which is the car that follows the engine for the purpose of carrying and supplying the fuel and water.

The evolution of American steam locomotive design had much to do with the operating conditions that railroads had to cope with in the 19th and early 20th Century. Trains ran long distances and had to be easy to overhaul and repair since major workshops and repair facilities were few and far between. This meant that American locomotive builders had to design parts that were interchangeable and functional.

There were many different types of steam locomotives that were standard in the United States. Because these types varied in wheel arrangement and were built to the different construction requirements of each individual railroad and the terrain they operated in; steam locomotives were divided into three general functional classes: freight, passenger, and switching locomotives.

**United States Department of the Interior
National Park Service****National Register of Historic Places
Continuation Sheet**

Section number 8

Page 10

- **Passenger Locomotives:**

Passenger locomotives generally had a four-wheel leading truck to give greater security in rounding curves at the high speeds. The leading wheels were followed by two, three, or four pairs of driving wheels ranging from 69 to 84 inches in diameter. The rear frame that supported the firebox was usually carried on a two-wheel trailing truck. Later, as the locomotives were built bigger, a four-wheel trailing truck was added.

- **Freight Locomotives:**

Freight locomotives generally had a two-wheel leading truck to help support the front end and guide the steam locomotive around curves. The lead truck was located under the forward end of the boiler. The driving wheels of the freight locomotive were of a relatively small diameter, usually under 63-inches. The rear end of the boiler and firebox were either supported on a separate rear frame or a cradle carried on a trailing truck. When without a set of trailing trucks, the firebox was supported on an extension of the frame. The large proportion of the total weight rested on the driving wheels, which provided the adhesion necessary for the large tractive effort needed to haul long, heavy trains.

- **Switching Locomotives:**

The switching locomotive was designed for varied service around railroad yards and industrial complexes. This type of work required a machine so proportioned that it would readily pass through the sharp curves encountered in industrial work. The engine also had to be able to start and stop easily and quickly in either direction, while possessing ample tractive force to move heavy loads. To accomplish this, the switching steam locomotive had its entire weight resting on the axles of driving wheels of comparatively small diameter. It secured the maximum amount of adhesion and tractive force from the total weight of the engine. The cylinder area and steam capacity was as consistent with the size of the locomotive. The wheel arrangement consisted of six or eight drivers, with no front or trailing trucks. The switching locomotive was traditionally smaller than the larger freight and passenger engines. It usually featured a tender with a sloping rear end so that the engineman could have an unobstructed view to the rear to the rear of the engine, as well as the front. Many of the smaller switch engines had fixed tenders resting as an extension of the frame.

Some time after the introduction of steam locomotives, it also became necessary to find a way of classifying locomotives according to their size and length. Eventually, a system was introduced by F. M. Whyte, based on the number and arrangement of the axles or wheels, which allowed a locomotive type to be described by observing the types of wheels, beginning from the front of the locomotive: the number of carrying wheels, followed by the number of driving wheels, followed by the number of trailing wheels. The following diagram illustrates some of the typical steam locomotive configurations that operated in North America.

**United States Department of the Interior
National Park Service**

**National Register of Historic Places
Continuation Sheet**

Section number 8

Page 11

Steam Locomotive Wheel Configurations

Wheel Arrangement	Locomotive Type	Example
0 - 4 - 0	Switcher	
2 - 6 - 2	Prairie	
4 - 4 - 2	Atlantic	
4 - 6 - 2	Pacific	
4 - 6 - 4	Hudson	
4 - 8 - 2	Mountain	
4 - 8 - 4	Northern	
4 - 8 - 8 - 4	Articulated	

Graphic by Matthew Merk

The Great Northern Railway Steam Era:

The wonderful and colorful age of steam ended on the Great Northern Railway in the Spring of 1958, when the railway officially retired the last surviving steam locomotive, No. 3059, a Mikado-type engine performing its final duties on Great Northern lines in August 1957. Although thirty-six engines remained on standby through the winter, they were never fired again.

The steam era spanned over 96 years, beginning with the maiden run of the William Crooks, in 1862. The William Crooks was the first steam locomotive in the Northwest. The steam era reached its apex on the Great Northern in 1926, when the railroad acquired one of the first diesel-electric locomotives in the Nation. *The railway's locomotive roster reached an all-time peak of 1,428 steam locomotives in 1920. In 2002, there are only five preserved steam locomotives of the Great Northern Railway.*

**United States Department of the Interior
National Park Service**

**National Register of Historic Places
Continuation Sheet**

Section number 8

Page 15

At this same time, the passenger train was the most popular form of travel when any distance had to be covered, especially in the sparsely populated Pacific Northwest. In addition, the Great Northern Railway was active in the development of the National Park System in the west. More vacationers meant more passengers and revenue. At this time, highways were still very rugged - dusty and rough in dry weather, muddy and nearly impassable in wet weather. There was very little competition from the automobile or the long distance buses, which were just coming into general use. Train speeds in this rugged region had to allow for the grades, curves, and frequent scheduled stops. At division points crews and motive power were changed. The Class E passenger locomotive met the needs of speed, durability, and reliability for the Great Northern Railway.

During the 1920's, the Great Northern Railway came under scrutiny because of its high earnings in comparison to their gross revenues and to those of the other railroads, within the industry. One way in which to deflate their net earnings was to modernize an older class of steam locomotives into newer wheel arrangements. When a railroad buys new locomotives from an outside builder, the cost of these locomotives is capitalized and does not affect the operating expense in the year they are acquired. By rebuilding the Class E-14's into the Class H-5 Pacifics, the railroad was able to make a substantial charge-off to the current year's operating expenses for the rebuilding, versus having to depreciate the value of a newly-manufactured steam locomotive over a period of years. The rebuilding of the Class E-14's locomotives gave the railroad essentially a new locomotive. The Great Northern Railway mechanical division chose the Class E-14 locomotive since they were versatile, easy riding, and they were very popular with the crews. The mechanical department decided to take what was the best of the ten-wheel arrangement and combine that with the new technological advancements of the Pacific-style engine. Thus, the Great Northern Railway gave birth to the Class H-5 Pacific.

H-5 Class 4-6-2 General Data

Built: Between 7/8/1921 and 11/18/1927	Cylinders: 23.5"x30"	Engine weight: 271,800 lbs. (weights varied)
Builder: Great Northern from E- 14 4-6-0 1008-1032	Driver diameter: 73"	Weight on drivers: 164,000 lbs. (weights varied)
Number series: 1486-1495 (pre 1926) 1350-1374	Boiler pressure: Design: 210 psi. Operating: 200 psi.	Tractive effort: 38,580 lbs.

Chart courtesy of Ben Ringnalda, <http://www.greatnorthernempire.net/>

**United States Department of the Interior
National Park Service****National Register of Historic Places
Continuation Sheet**

Section number 8

Page 16

In 1921, the E-14 Ten-wheelers were all twelve years old and undoubtedly due for heavy repairs. Most certainly they were in need of firebox renewals, and this may be one major factor in the decision to rebuild them into Pacifics. The fireboxes of the E-14's were of the wide type, mounted above the frames and driving wheels. This arrangement dictated that the fireboxes would be very shallow, with almost no slope to the grates. In addition, the level of the grates was almost even with the bottom edge of the rear tube sheet. This configuration, while fine on smaller engines, would have been difficult to draft properly on a steam locomotive this large. Lack of combustion volume would also have made the E-14's smoky engines. Someone in the engineering department no doubt realized that to fit a deeper firebox would pose severe vertical restrictions on an engine already more than sixteen feet high. Rebuilding as a 4-6-2 would alleviate this problem by allowing the firebox to be deeper where there were no drive wheels to work around.

Another factor, which may have influenced the decision to rebuild the E-14's, was their superheaters. The Emerson type, as previously described, made tube maintenance difficult, both by blocking access to the front flue sheet, and by being susceptible to severe cinder erosion. By now, the Elesco Type A superheater was well established as the industry standard. The Type A superheater used a single large header mounted across the top of the front tube sheet, with the elements reaching down from there into the large flues. This setup only blocked access to the large flues themselves, and the few small tubes between them, rather than blocking nearly all tubes as in the Emerson type. However, the E-14 smokebox lacked the necessary length to accommodate the Type A header between the front tube sheet and the stack.

The Class H-5's with their 73-inch drivers was the most numerous of the Pacific-type sub classes on the Great Northern Railway system. The twenty-five engines in this particular class powered at various times, every passenger train on the Great Northern Railway. As late as 1950, the Class H-5's was still in service, although relegated to light freight, mixed, and occasional passenger service.

Fortunately, one of the engines from this unique Pacific-style class has survived. Engine No. 1355 was donated to the city of Sioux City, Iowa. In 1984, Engine No. 1355 was removed from display and is currently being restored to operating condition. During Engine No. 1355's tenure of powering passenger trains over the Great Northern Railway system, this locomotive class was assigned to power the famous **Oriental Limited** passenger train and the **Fast Mail**.

In this section we will be discussing the mechanical attributes of Great Northern Railway Steam Locomotive No. 1355. Most of the information within this section is taken from the reference sheet that the late Doug Bemrich prepared for the Great Northern Railway Historical Society. Doug Bemrich and Larry Obermeyer, Jr. gathered most of the background material during the late 1980's for the preparation of this Register nomination. In 1990, Bemrich prepared the reference sheet at the request of the Great Northern Railway Historical Society.

The H-5 class 4-6-2's were the result of the Great Northern's experience with both earlier Pacifics and Ten-wheelers. The twenty-five engines in this class served all over the Great Northern, and lasted to nearly the end of the steam era. Fortunately, one locomotive of the class survived and was an invaluable aid in providing clues to just how the class was rebuilt.

**United States Department of the Interior
National Park Service****National Register of Historic Places
Continuation Sheet**

Section number 8

Page 17

The direct ancestors of the Class H-5's were the Pacific-style Class H-4 and the Ten-wheel style class E-14. The H-4 class provided the inspiration, and the E-14's the material. The first batch of H-4, 4-6-2's came from Baldwin in early 1909. Engines 1441-1460 were the first to combine Walschearts' valve gear, piston valves, and superheating, thus becoming the first "modern" Pacifics on the Great Northern. Large engines by 1909 standards, they weighed 255,000 pounds, had 26 by 50 inch cylinders, and 75 inch drivers. They carried 150 pounds working pressure, though their boilers were designed for 200. Their superheaters were of the early Emerson type, with the headers on the sides of the smokebox, and the elements radiating across in front of the tube sheet. The steam discharge from the headers was down low in the smokebox, below the level of the running boards. The second batch of H-4 engines came from Lima in 1914. 1461-1485 incorporated slight changes, including Schmidt superheaters, and different dome placement.

The E-14 Ten-wheelers were the direct parents of the H-5 class. There were two batches of E-14's delivered, with the first twenty-five engines, numbers 1008 to 1052, arriving from Baldwin in late 1909. A further twenty engines, numbers 1055 to 1052, came in August 1910. This second group was slightly heavier than the first, although all dimensions and power remained the same. Engine No. 1355, originally numbered Engine No. 1020, was one of the first twenty-five engines of the Class E-14 to be delivered to the Great Northern.

The first batch of E-14's, 1008-1052, were all rebuilt into H-5 4-6-2's. Built by Baldwin in October and November 1909, they shared many features with the Class H-4 Pacific-style engines delivered earlier that year. Visually, the H-4's appear to be a squatter version of the E-14 with a boiler course added between the sandbox and stack, and a trailer truck added behind the drivers. Closer examination of specifications, however, reveals that they were more an attempt to achieve the same result by a different approach.

The E-14 was the ultimate expression of the 4-6-0 engines on the Great Northern. These monster Ten-wheelers weighed over 200,000 pounds and stood more than sixteen feet tall, dwarfing all the other 4-6-0's on the system. With their Walchearts' valve gear, piston valves, and superheating, they shared more with the Pacifics than the other Ten-wheelers on the Great Northern's engine roster. These heavy Ten-wheelers were assigned to fast passenger schedules all over the Great Northern system. The E-14's could be found at the head of passenger trains at virtually every major terminal. The E-14's had 25 ½ by 50-inch cylinders and 200 pounds working pressure. With more weight on the same 73-inch drivers and better adhesion, the E-14's had a higher tractive effort than the H-4's, and could start a heavier train. By using higher boiler pressure and less steam per stroke in their smaller cylinders, the Class E-14's were more efficient in using steam. This is borne out by the fact that the H-4's later got 25 ½ inch cylinders and had their working pressure raised to 185 pounds. The E-14's used the same superheater as the H-4's as well as having many other features in common: cabs, valve gear, lead trucks, main rods, crossheads, domes, and stacks.

**United States Department of the Interior
National Park Service****National Register of Historic Places
Continuation Sheet**

Section number 8

Page 18

By 1921, the Great Northern found themselves needing more passenger power. The P-2 class 4-8-2's were soon to enter service in the hilly regions, so it was decided to obtain more 4-6-2's. Rather than order totally new power, the Great Northern made the decision to rebuild the largest and newest Ten-wheelers into Pacifics. Trains were getting steadily heavier, and faster schedules were rapidly outpacing the capability of the Ten-wheelers.

Three shops participated in the rebuilding program, Dale Street (Saint Paul, Minnesota), Hillyard (Spokane, Washington), and Delta (Everett, Washington). The first rebuild was completed at Dale St. on July 8, 1921, when former Engine No. 1051 emerged as the first H-5. The new engine was given the road number 1486, following the last of the second batch of H-4's. This engine was the "guinea pig" of the class and as such was slightly different than those, which followed. Apparently, the Great Northern was certain of success, since the second engine, No. 1019 entered the rebuilding program on July 5th, three days before the first one was complete. This engine and all subsequent H-5's incorporated some slight modifications from the original. The rebuilding affected almost every part of the locomotives, from their pilots to ash pans. The first obvious place to begin was with the boiler.

The first item in the boiler needing to be modified was the firebox. As the grate area was deemed sufficient in size, depth was the major influencing factor. The H-5 inside firebox measures 110 inches long, 66 inches wide, 72 inches high at the front, and 64 inches high at the back. These measurements are roughly the same as the E-14 except for height. An E-14's firebox was only 55 inches high at the back. The new firebox sections were fabricated with a larger opening at the front than the E-14. The second order of E-14 engines had larger openings and used a conical section to join firebox and barrel. The Great Northern may have been looking toward interchangeability when these fireboxes were designed. Whether the new fireboxes were made by the Great Northern in-house, or were ordered from Baldwin is open to conjecture. The view that they were constructed by the Great Northern holds some merit, as the existing firebox has no identifying markings on it whatsoever. Baldwin extra orders usually carried a construction number, as well as the standard type of pressure rating plate. The pressure plate on the 1355 is definitely not of the type that Baldwin was using as early as 1906.

**United States Department of the Interior
National Park Service**

**National Register of Historic Places
Continuation Sheet**

Section number 8

Page 19

About the Belpaire Boiler:

One important steam locomotive design was the Belpaire boiler. The Great Northern Railway was totally dedicated to this boiler design. With a few exceptions, only the Pennsylvania and Norfolk and Western Railroads extensively used the Belpaire Concept. The diagram below compares the Belpaire boiler and the more common radial stay boiler used by most railroads.

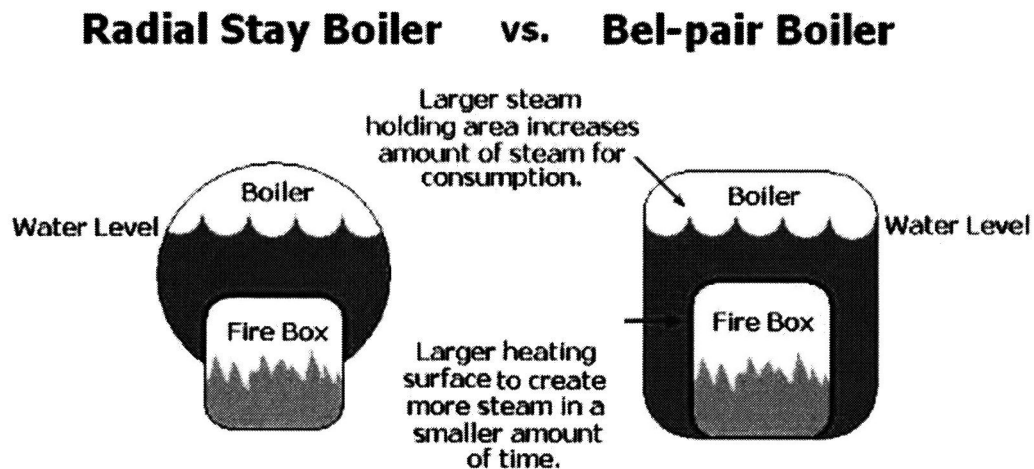

Graphic by Matthew Merk

The Belpaire boiler is constructed to have the crown sheet and top of the boiler shell parallel, and the staybolts at right angles to the sheets. It added considerable steam space to the boiler. In the Belpaire boiler, both the crown sheet and the main shell are made flat. These two sheets are held in place the stays, which are at right angles to both sheets, while the sides, which are also flat, are stayed with rods. Gusset stays support the back boiler head, while the front tube sheet is supported by the stay-rods. In this boiler design, the dome cannot be located above the crown sheet on account of the flat sheet.

The most prominent feature of the Class H-5 Pacific-style locomotive is the Belpaire firebox with its unusual "squared-off" appearance; a result of trying to design a firebox in which all of the supporting stays would meet the sheets at right angles. Except for the Great Northern's Mike-style and the Pennsylvania P-2s Pacific-style locomotives, the Great Northern Railway was totally dedicated to this Belpaire boiler design. With a few exceptions, the Pennsylvania Railroad and the Norfolk & Western Railroad were the only roads extensively using the Belpaire boiler design.

The Belpaire boiler design first appeared in 1885. The advantages of the Belpaire boiler are its increased steaming and water capacity in a given grate area. Its construction, with firebox and boilerplates parallel to each other, makes "staying" (radial stay bolts) a simple proposition.

**United States Department of the Interior
National Park Service**

**National Register of Historic Places
Continuation Sheet**

Section number 8

Page 12

- **Although locomotive No. 1355's heritage is tied to the Great Northern Railway, her importance reaches beyond those rails and carries national significance. This locomotive is Nationally Significant as a preserved example of the "Pacific-style" steam locomotive that did much to define the railroad character of the United States.**

About the Pacific-style Twelve-Wheel Locomotive Arrangement

The Pacific-style engine was introduced around the turn of the twentieth century. The locomotive was available in many sizes, from a small logging engine to the large mainline passenger engine. The Pacific was so popular around the world that an orchestral work was written in its honor - Symphonic Movement Number 1, "Pacific 231" by Arthur Honneger. French cinematographer Jean Mitry made a 1948 experimental film by the same name.

Steam locomotive construction for use in the United States ended in 1949 when the railroads replaced steam locomotives with diesel-electric locomotives. During the first half of the twentieth century, the predominant steam passenger locomotive was the twelve-wheel (4-6-2) arranged Pacific-style locomotive. Between 1902 and 1930, around 6,800 locomotives of this style were built for engine service in the United States and Canada. The Pacific-style locomotive comprised about nine percent or approximately 6,700 of the total number (75,000) of steam locomotives built for U.S. and Canadian railroads. The following drawing illustrates the Pacific-style steam locomotive wheel arrangement.

Steam Locomotive Wheel Arrangement Example

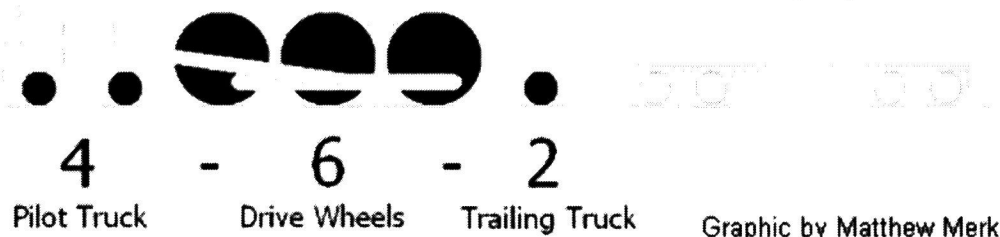

As the predominant steam passenger locomotive until the arrival of the diesel-electric locomotive, the Pacific's were built in a variety of designs for many services: passenger, freight, express freight, and fast

**United States Department of the Interior
National Park Service**

**National Register of Historic Places
Continuation Sheet**

Section number 8

Page 13

mail. Pacifics were built with drive wheel diameters ranging from sixty-seven inches up to eighty inches, and steam pressures ranging from 170 psi to 250 psi. Pacifics were classified as light, medium, or heavy locomotives. Engine No. 1355 is classified as a "medium" Pacific because of its superheated steam, Belpaire boiler, and seventy-two inch drivers.

Of the 6,700 Pacific-style locomotives built, eighty have survived the scrapper's torch. (Surviving Steam Locomotive Database, www.steamlocomotive.com)

- **Of these eighty, Engine No. 1355 is the only surviving member of its class that was built for the Great Northern Railway.**
- **Engine No. 1355 is the only surviving Pacific-style locomotive that has carried an environmental paint scheme (Glacier Park), which promoted the development of the National Park System in the Western States.**

The Pacific-style locomotives weren't the biggest, the most powerful, or the most elegant engines, but they were popular because of their size and adaptability. The Pacific was, for many applications, the perfect choice for fast passenger and freight train service. The 4-6-2 had ample steam producing capacity, and a four-wheel lead truck assured stability at high speeds. Six drivers allowed sufficient adhesion for most trains, and the Pacific-style locomotive carried a higher percentage of its weight on the drivers than did most other passenger engines. This allowed for this style of locomotive to earn the nickname of "high-stepper" because it was far less prone to difficulty in starting heavy trains. This was crucial to the railroads in the delivery of mail service and passengers.

The Pacific (4-6-2) locomotive is a development from the 4-4-2-type locomotive, simply having three pairs of driving wheels instead of two, and a larger boiler and firebox. These design features provided an increase in steam capacity and higher tractive effort. In 1886, George S. Strong built a prototype Pacific-style locomotive for use on the Lehigh Valley railroad. But the true ancestral background of the Pacific-style locomotive is up for debate. Many historians generally accept that the Baldwin engines built in 1901 are the true ancestor of the 4-6-2 Pacific-style in the United States. These locomotives were originally built and designed for export to New Zealand. The Baldwin design was highly successful because it allowed for the engine to be bigger, with more power, speed, and traction than the earlier prototype and the other Atlantic or Mogul style locomotives. In 1902 the American Locomotive Company (ALCO) built some 4-6-2-style engines for the Missouri Pacific Railroad, hence the name "Pacific" was applied to the 4-6-2-wheel arrangement. Combining exceptional speed and power, the Pacifics became the standard for fast main line passenger service. Many Pacifics were used right up until the end of the steam era. The last known construction year for the Pacific-style locomotive is 1948.

As stated before, the Pacific-style locomotive was a design modification of the earlier 4-4-2 Atlantic. The Pacific features an extra driver for better traction and a trailing axle for improved firebox support. On a classic Pacific, that trailing axle is directly under the firebox. In addition, the Pacific's firebox is noticeably larger than those on earlier steam locomotives. The firebox is actually the furnace of the locomotive.

**United States Department of the Interior
National Park Service**

**National Register of Historic Places
Continuation Sheet**

Section number 8

Page 14

- **Great Northern Railway Steam Locomotive Class H-5 is not typical of the time when Pacific-style locomotives were built. This locomotive class was not originally built with the 4-6-2-wheel arrangement. It was originally built as 4-6-0 Class E-14 Ten-wheel locomotives.**
- **This locomotive is the nation's only remaining steam locomotive to be built from one wheel classification to another, with new engineering technologies of the time applied to its redesign.**

About the Class E Ten- Wheel Locomotive Arrangement

During the late nineteenth and early twentieth centuries, the ten-wheel steam locomotive was pretty much the standard motive power on American railroads. They were the workhorse engines that were suitable for fast passenger service or slow, economical freight service. Although the ten wheelers lacked the catchy name like Pacific or Atlantic, this locomotive style was state of the art and played a major role in the industry for over twenty years. The ten-wheelers, with their large driver wheels, were frequently seen pulling five or six passenger cars. These locomotives lasted well into the 1940's in great numbers, but not on mainline service.

Heavier trains and the demand for greater speed brought the "high-stepping" ten-wheeler into service on the Great Northern Railway. During 1909 Baldwin Locomotive Works built the Class E-14 steam locomotives as dual-purpose freight and passenger engines.

Weighing 100-tons, this locomotive class featured 73-inch drive wheels and operated on 200 pounds of superheated steam. The hand reverse, alligator crossheads and Walshaert valve gear were typical locomotive designs of the period. Higher tender capacities for both coal and water led to the development of cast steel trucks of the equalizer. Because the Class E-14 was soundly designed to meet the specifications of the Great Northern Railway, many of these engines were rebuilt to the Pacific-type locomotive.

Reasons for Rebuilding the Class E-14's into Pacific-Style Locomotives

Rebuilding steam locomotives from one wheel arrangement to another was not a common practice of American Railroads. However, the Great Northern Railway found itself willing to rebuild the Class E ten-wheelers into the twelve-wheel Pacific-style locomotive.

The Great Northern Railway was experiencing extreme growth during the first half of the twentieth century. The Great Northern Railway was the only road of the three northwest transcontinental railroads to hold a government contract for the delivery of mail from St. Paul to Spokane and Seattle. The schedule was very demanding for this route. Mail was sorted in route and strict time schedules had to be met. The train that served this route was known as the ***Fast Mail*** or Train #27. For many years, the Great Northern ***Fast Mail*** held the record for the fastest long distance run in the world. The Class E passenger steam locomotive was designed with the demanding schedule of the ***Fast Mail*** in mind.

**United States Department of the Interior
National Park Service****National Register of Historic Places
Continuation Sheet**

Section number 8

Page 20

The new firebox was of the typical (for the Great Northern) Belpaire pattern. Flexible staybolts were extensively used in areas of high stress, and to support the crown sheet. The flexible stays in the side sheets are of the Tate-Flannery pattern with solid body and type D head. The crown stays are two piece units, with large type KN nuts at the outside ends. Cross braces above the crown sheet are solid, one piece forgings, spanning the entire width of the wrapper. Diagonal braces supporting the backhead are flattened and riveted to the roof sheet, and are attached to the backhead by clevis fittings. The inside firebox sheets are 5/8 inch thick. The crown sheet is 5/8 steel, as is the outside wrapper. Belpaire fireboxes were more expensive to construct than radial stay types, but were stronger, and cheaper to maintain.

The square topped Belpaire section extends farther forward than on an E-14. This is due to the H-5 having a combustion chamber ahead of the firebox. These are believed to be the first Great Northern locomotives so equipped. The firebox tube sheet is attached to the combustion chamber opening. The combustion chamber is 56 inches long, modest by later standards, but these were pioneers.

A combustion chamber serves to add more combustion volume to the firebox, and concurrently, more direct heating surface for the same grate area. Since the actual burning of the fuel must be nearly complete before the gasses enter the flues, the combustion chamber allows more time for the fuel to burn. If combustion is not complete by the time the gasses enter the flues, the unburned fuel is wasted as smoke. By protruding into the boiler barrel, a combustion chamber also reduces the required tube length for the same size boiler. The lack of firebox volume on the E-14's and to keep tube length within reason was most likely the reason that combustion chambers were included in the rebuilding.

The firebox shows evidence of excellent maintenance right up until GN 1355's retirement in 1955. The bottom three feet of the interior firebox are relatively new, this section has been welded in, rather than riveted. The whole inside firebox, in fact, is a Welded unit. The front tube sheet is welded to the sides and crown, as is the flange for the combustion chamber throat sheet. No patches or repairs are otherwise visible in the 1355's firebox.

The new firebox is joined to the existing boiler barrel by a semi-conical section. This section is straight on top, with the entire taper visible on the bottom, in an inverted wagon top configuration. This conical section is riveted to the existing boiler shell at the former location of the firebox, and contains the auxiliary dome, which in turn holds the three safety valves and whistle.

The boiler barrel is one of the few parts that was not affected by the rebuilding. This only amounted to three courses, the rear one of which contained the steam dome. The tall domes were retained on the new engines and in the same positions relative to the original boiler barrel, which placed them well forward on the modified boiler. The steam dome also carries the only truly reliable identification on the locomotive. The Baldwin construction number, date, and original road number are all stamped in the front of the steam dome. The boiler barrel is all of straight construction, with a nominal inside diameter of 72 inches.

**United States Department of the Interior
National Park Service****National Register of Historic Places
Continuation Sheet**

Section number 8

Page 21

The front tube sheet is the only component of the barrel that was replaced during the rebuild. This was necessary to accommodate the new Type A superheater. The old Emerson superheater consisted of 24 elements, inside five-inch flues. The Type A uses 52 elements coiled inside 5½-inch flues. The large superheater flues are arranged in four horizontal rows of eight, with 2¼-inch tubes filling the gaps between the large flues. An H-5 has 156 2¼-inch tubes (except for pioneer 1350, which had 160), versus the 180 tubes of an E-14. The H-5's 21 foot tubes are 3 ½ feet longer than those of an E-14, even allowing for the combustion chamber. The tube sheet is 5/8 inch thick, and is flanged and riveted into the front boiler course.

The front tube sheet in the 1355 shows evidence of a partial renewal late in the engine's career. There is a "D" shaped weld extending along the bottom of the superheater header, then following the flange around the remainder of its circumference. This was a totally acceptable method of replacing the tube holding area of the sheet without the added effort and expense of removing the header and all of the rivets. Due to the stresses involved when rolling tubes in the course of periodic replacement, the tube sheets would often develop cracks in the webs between the tube holes. This is often what necessitated this type repair. As electric arc welding techniques progressed, these type repairs became increasingly common.

The smokebox was also replaced during the process of turning a Ten-wheeler into a Pacific. The placement of the superheater header required more room between the front tube sheet and the stack. On the H-5's, the way this was accomplished was to simply move the stack forward 5½-inches. Since the H-5 uses the same boiler mounting points as the E-14, this now places the stack centerline 5½-inches ahead of the exhaust nozzle opening. This difference is compensated for, by using a new exhaust nozzle with a curious "S" curve in it. This unusual feature appears in both the drawing and photographs. The original stamped smokebox front was also replaced with a flat plate front, with the original door mounted in it. It is certain that the smokebox on the H-5 is not the original, simply modified for the superheater. There is no evidence of the stack being moved, such as in a patch over the old stack opening.

The boiler is mounted to the frame at six points. At the front it is bolted directly to the smokebox saddle with two rows of bolts. Between the smokebox saddle and the first drive axle there is a plate steel saddle above the narrow frame section around the cylinders. This saddle is not fastened to the barrel, to allow for expansion and flexing during operation. There is a similar saddle in line with the valve gear yoke, bolted to the yoke crossmember over the main frames. Two more are mounted directly to the frames between the main and third pair of drivers. The front of the firebox mud ring is mounted in a sliding furnace bearer resting on the top of the main frame runners. This arrangement allows side to side movement of the firebox, which, along with the non-rigid saddles beneath the barrel, allows movement in two axes. The rear of the firebox is attached to a semi-flexible flat plate mounting. This mount is a simple piece of flat steel, one half inch thick, bolted to a flange riveted to the rear of the firebox, and to an angle bracket bolted to the rear frame cradle. Longitudinal shifting of the boiler due to expansion is thus limited by the flexing of the flat plate. This same plate controls the side to side movement at the extreme rear of the boiler. It does at first seem surprising that there are only two points where the boiler is actually attached to the locomotive frame.

**United States Department of the Interior
National Park Service****National Register of Historic Places
Continuation Sheet**

Section number 8

Page 22

The frame itself had to be extensively modified in the 4-6-0 to 4-6-2 process. The E-14 class engines had unequal driver spacing to allow for sufficient ash pan openings and at least some slope for the grates. This uneven spacing between the main and third drivers was eliminated during the rebuild. Also, a trailing truck had to be accommodated behind the drivers. In light of the available evidence, which in this case is only the existing locomotive, it appears that the frame was cut between the first and second drive axles and a new frame from there on back substituted. Why this was done, rather than make the splice between the main and third drivers is unknown, but Engine No. 1355 bears clear evidence of the splice behind the first drive axle.

The new frame section was of the same construction as the original as far back as the rear drive axle. Behind that point there was a cast steel Delta rear cradle bolted into the bar frames. This cast cradle incorporated the firebox mountings and the attachment points for the one piece Delta trailing truck, which all H-5's carried when they first emerged from rebuilding. Some engines lost these trailers in favor of Hodge trucks in later years, a change, which made them almost identical to the second group of H-4's. All H-5 trailers, regardless of type, carried 45-inch wheels, those in Hodge trucks being spoked. All axles of the H-5 locomotives were fitted with friction bearings, and retained these throughout their service lives.

The original front frame section was not modified, nor was the leading truck. The same valve gear yokes, crosshead guide mountings, and cylinder attachment points were used, along with the spring rigging as far back as the main drivers. From there back, the spring rigging was built new both to accommodate the trailing truck, and redo the rear drive axle springs and equalization.

Originally, the spoked lead truck wheels of the E-14's were retained, although eventually nearly all were replaced with solid wheels. The lead truck wheels are all 36-inch diameter. The 73-inch drive wheels were retained as well, and were somewhat longer lived. The rear driver on the left side of Engine No. 1355 bears the number 1020, her original E-14 number.

One obvious difference existing between the E-14 and H-5 classes, visible in both the photos and diagrams, is that the boiler of an H-5 sits several inches lower over the frames than does that of an E-14. This has proven to be a topic of discussion for some time as to how this was accomplished. The solution lies in the fact that new cylinders were part of the rebuilding. These new cylinders have a lower smokebox saddle than the originals, allowing the boiler to ride lower. The giveaway is the fact that the cylinders on the existing locomotive have the characters "H-5" cast in them, proving at least that they are not reused E-14 components. The new cylinders retain the same 25-½ inch bore and 50-inch stroke of the originals.

**United States Department of the Interior
National Park Service****National Register of Historic Places
Continuation Sheet**

Section number 8

Page 23

The Emerson superheaters used two headers, placed more or less vertical at the sides of the smokebox interior. These headers discharged the superheated steam at their bottoms, and thence out through the sides of the smokebox at a very low level. From there the steam traveled through oblong, almost rectangular, passages to the cylinders, entering through the upper, inboard quadrant of the steam chests. This does look similar to the arrangement of an outside admission engine. The clincher is the valve gear. The radius rod is connected to the combination lever above the valve stem. With the eccentric crank following the crankpin (leaning forward when the rods are down). This arrangement would provide the correct lap and lead only for inside admission. In fact the setup of the radius rod and combination lever is the only sure way to tell if a locomotive has inside or outside admission. And the option of direct or indirect Walschaerts adds another possible bit of confusion.

The drive rods required modification, due to the altered driver spacing. New rear side rod sections were provided to compensate for this reduced spacing. Apparently, this operation was not judged sufficient to warrant a rebalancing of the mechanism, since no lightening holes are present in the counterweight of the one original drive wheel on the 1355. The main rods were also replaced. The originals were held in place by pins and wedges, with split bearings, a method obsolete by the twenties. The new engines received one piece forged main rods with solid bushings.

The valve gear in turn received slight modifications. In the E-14's, the union link is attached to an extension arm reaching down from the crosshead. On the H-5 engines, the union link mounts directly to the crosshead wrist pin. The crosshead guides were likewise provided with an outboard vertical yoke brace near the rear of the guide bars, which was not present on the E-14 class.

As a result of the H-5 firebox being shaped differently than the E-14, modifications were required to the front cab wall. There appears to have been a great variance as to how this was done. The E-14 cab had windows in the front, above the boiler, and some H-5's retain this feature, while others do not. Some which lack windows show evidence of where they were blanked out, and some, such as 1355, show no evidence of them whatsoever. It follows that at least some engines got entirely new front cab walls during the rebuild. Additional grab irons and handrails were added to most, if not all, engines at the same time. There is one hinged cab vent centered in the roof of all engines.

Initially, all the new engines were equipped with two, non-lifting injectors, one to a side. Later, the Class H-5's got all manner of injectors, feedwater heaters, and exhaust steam injectors.

As built, the H-5's weighed around 265,000 pounds, of which 164,000 was carried on drivers, resulting in an excellent 4.27 factor of adhesion. They exerted a tractive effort of 38,580 pounds. These figures were based on engineering estimates, as the class was not actually weighed at this time. Engine 1486 (later 1350) weighed only 260,000 pounds. Boiler pressure remained the E-14's 200 pounds.

By 1921, the H-5 program was now in full swing. Three were completed in 1921: 1486, 1488, and 1489. These were originally engine numbers 1031, 1019, and 1025, respectively. In 1922, 1018, 1022, and 1023 emerged as 1487, 1490, and 1491. Only one H-5 was completed during 1925. 1492 came out as the reincarnation of 1016. 1924 saw just two more added to the roster. In May the former 1020 appeared as 1494, and in June, engine number 1495, ex-IO30 joined her.

**United States Department of the Interior
National Park Service****National Register of Historic Places
Continuation Sheet**

Section number 8

Page 24

The year 1925 again saw only a solitary H-5 joining the roster. 1493 saw the light of day at Dale Street on January 26. The former 1024 would be the last one built for fifteen months. 1926 and 1927 were the big years for H-5 production. Six E-14's came out as H-5's in 1926. Also, it became apparent that with continued production, the H-5 numbers would soon exceed 1500, where they would conflict with the class J-1 2-6-2's. It was decided to renumber the H-5 locomotives into the 1350-1399 series, between the F-9 2-8-0's and the H-1 Pacifics. Engines 1486-1495 became 1350-1359 between February and April 1926, although not in order. The six engines constructed in 1926 fell into the 1360-1365 number bracket.

In 1927 the last nine of the first batch of E-14 Ten-wheelers were rebuilt into H-5 Pacifics carrying the numbers 1366-1374. Engine 1369, ex-1014, rolled out on January 24, and the last H-5, 1374, steamed out on November 18. The totals for individual shops are as follows: Dale Street, fourteen, Delta, six, and Hillyard, five.

These twenty-five new Pacifics went to work along side the H-4 class in passenger pool service as they emerged from their respective shops. The H-5's soon showed that they could start a heavier train than earlier 4-6-2's, and had faster acceleration. They were assigned all over the railway as fast as the shops could turn them out.

As the newest and largest Pacifics on the Great Northern's roster, the engines drew many of the premier passenger "name-trained" assignments. For example, the 1924 *Oriental Limited* was hauled by H-5's over four sections of its run, two eastbound and two westbound. Interestingly, at that time, E-14 class engines still held down the Devils Lake-Minot westbound leg. *The International* and *Winnipeg Limited* were also often found in the charge of H-5's. The *Oriental Limited*, *The International* and *Winnipeg Limited* were all named passenger trains of the Great Northern Railway.

The H-5's were subjected to relatively few modifications or rebuilding during their 40+ year service lives. The most obvious changes were the cab modifications carried out in the late forties. Many H-5 cabs were cut off at an angle, both to facilitate staybolt maintenance, and for looks, as were several other classes of Great Northern power at the same time. This was simply a modification of the existing cabs and not a replacement as sometimes stated. The cab sides were cut off at the proscribed angle, and the front wall bent back to fit and riveted. The exception was 1372, which received a most unusual "back slanted" cab with rounded edges. Many H-5's received boosters during the late twenties and early thirties. Those getting them include, but are not limited to, engines 1352, 1355, 1356, and 1365. All the boosters were removed by the mid-thirties. Some engines, 1355 included, lost the Delta trailing trucks as well, having them replaced by Hodge trucks. It is interesting to note that some 0-1 class 2-8-2's received Delta trucks and boosters about the same time as the H-5's lost them.

The H-5's received the usual bewildering procession of feedwater heaters and exhaust steam injectors. Elesco and Sellars exhaust steam injectors were both used, mounted on either side of the locomotive. Worthington BL feedwater heaters were utilized, always on the left side. Most of the engines lasting late in the steam era had many of these appliances removed before retirement.

**United States Department of the Interior
National Park Service****National Register of Historic Places
Continuation Sheet**

Section number 8

Page 25

Power reverses were fitted in the thirties, most generally Alco type K, although this was not universal. 1365, for instance, had a type G. All power reverses were mounted on the right side, above the running board. Auxiliary air reservoirs for the reverses were acquired in the late forties, in response to an ICC rule requiring an alternate source of power in case of air system failure. These reservoirs were mounted directly behind the reverse, also above the running board.

The air brake equipment was from the New York Air Brake Company and was Great Northern design. New York 5B duplex pumps and H-6 automatic valves were fitted. A C-2 straight air valve, an unusual controlled Independent air brake, in that it was mounted vertically on the cab sidewall. The 1355 retains this brake system. Two-brake cylinders mounted between the frames in line with the crossheads actuated the brakes on the locomotive.

An interesting facet of the Class H-5's is their weight. As built they were believed to weigh in the neighborhood of 260,000 to 265,000 pounds, with 164,000 of those on the drivers. Beginning in 1947, the weights were raised substantially. Engine weight for most of the class was now listed as 279,000 pounds and 176,000 on drivers. However, engines 1350, 1354, 1356, 1357, 1358, and 1359 show engine weights of 289,840 and weight on drivers of 180,000 pounds in 1947. There were many other minor variances in weights of the other engines.

The Class H-5 locomotives were coal and oil burners, individual engines maybe discerned from the diagrams.

Locomotive No. 1351 was the first of the class H-5 to leave the roster. She was wrecked on July 24, 1941, and dismantled in October of the same year. The rest of the class remained intact until September 1950, when 1358 became the first H-5 to be retired and sold for scrap. She went to Paper Calmenson and Co. on the 15th. 1951 saw two more of the class go to scrap as Diesel motive power was making serious inroads on all divisions. 1367 and 1362 had left the roster by November.

The worst year for the class was 1952 with eight engines being retired from April to October. Two engines, 1354 and 1356, went the same day to different scrappers. Another bad year for the Pacifics was 1953, when seven locomotives were cut up. The black day for Class H-5 locomotives was July 16th, when five engines were sent to three scrap yards. The grim scrapper very nearly spared the class in 1954, only two locomotives left the G.N. both on December 28. 1366 and 1373 were both listed as scrap locomotives as early as July, so they no doubt sat derelict for several months before the end.

By 1955, only four of the 25 Class H-5 locomotives survived: 1355, 1359, and 1369 in ore service on the Mesabi Division at Kelly Lake, Minnesota, and lonely 1371 on the Dakota Division. Engines 1355 and 1369 were both photographed under steam on September 9th, 1954 and both apparently well cared for at that time. Time was running out though. It is doubtful that 1369 ever steamed in 1955, she went to be scrapped on West End Iron and Metal on April 26. The other three were "stored serviceable". In July fate smiled on 1355, she was pulled out of storage and donated to the city of Sioux City, Iowa. The last two H-5's, engines 1359 and 1371, were scrapped on August 28, thus bringing to an end the careers of a class of engines which had a working career spanning nearly forty-six years.

**United States Department of the Interior
National Park Service**

**National Register of Historic Places
Continuation Sheet**

Section number 8

Page 26

The Glacier Park Paint Scheme and the National Park System

The newly reconstructed Class H-5 locomotives emerged from the various engine shops attired in Great Northern's famous "Glacier Park" paint scheme, with the green boiler jacket and cylinders, red cab roof, and Goat herald on the tender flanks. They immediately were put to work pulling passenger trains all over the Great Northern. The "Glacier Park" paint scheme was very unique to the railroad industry. The Great Northern Railway painted their passenger equipment in this motif to call attention to the environmentalism movement that was occurring during this time period. Louis Hill, son of J. J. Hill - the founder of the Great Northern Railway, was very interested in the development of the National Park System, especially Glacier National Park. Thus, to call attention and market Glacier National Park to tourists, steam locomotives that headed the "named" passenger trains to and from Glacier National Park carried the Glacier Park paint scheme to distinguish those trains from other passenger trains on the Great Northern Railway system.

America's railroads and national parks have rolled together through history hand in hand since 1883, when the first national park, Yellowstone, was a decade old. The connection between the Great Northern Railway and the National Park System is most evident in Glacier National Park. The Great Northern Railway built its main line from the Great Lakes to the Pacific Coast just south of Glacier National Park in 1893. The Great Northern also undertook development of an impressive array of lodging in and near Glacier, including the magnificent Many Glacier Hotel. (Cultural Resource Management, Historic Railroads, p. 4).

This close working relationship between the Great Northern Railway and the National Park System allowed the railroad to profit in promoting vacation get-a-ways to Glacier National Park. The Great Northern Railway was key to the early visitation history of Glacier National Park. Promotional efforts included large travel posters, promotional booklets available through stations and depots, and advertisements in magazines and newspapers. The railroads gave birth to tourism advertising.

One result of their promotional efforts was to paint their locomotives in the "Glacier Park" paint scheme. The locomotives were painted in the following fashion:

Locomotive Area	Paint Color
Cab Exterior	Black
Cab Roof	Red Building Paint (Mineral)
Cab Interior	Green
Cab Sash	Green - inside, Black - outside
Frames, main and truck	Black
Jacket (surrounds boiler)	Jacket Green Enamel
Running gear, including wheels	Black
Letters and numbers	Aluminum
Smoke Box	Staybrite
Rods, side and main	Polished and oiled
Tires	Black
Running boards	Black
Cowcatcher, hand-holds, and steps	Black

**United States Department of the Interior
National Park Service****National Register of Historic Places
Continuation Sheet**

Section number 8

Page 27

Tender

Exterior	Black
Underframe	Black
Truck Frames	Black
Wheels	Black
Hand-holds	Black
Steps	Black

Source: Great Northern Railway Company, Office of General Superintendent Motive Power Color Chart

Passenger coaches and diners were matched with a similar green and black paint scheme. The green paint commemorated the National Park System. These locomotives were clearly identified as heading "named" passenger trains that would roll through the Pacific Northwest with stops near Glacier National Park.

- **Of all surviving steam locomotives in the United State, only Great Northern Railway Steam Locomotive No. 1355 is the best remaining national resource to illustrate the historical associations between the railroads and the National Park Service, and the historical development of visitation to the National Parks.**

**United States Department of the Interior
National Park Service**

**National Register of Historic Places
Continuation Sheet**

Section number 8

Page 28

Tender No. 1451

Historical records for Tender No. 1451 were not well kept by the Great Northern Railway. Upon the railroad's merger into the Burlington Northern System in 1970, the mechanical records for steam locomotives and tenders were permanently transferred to the Minnesota State Historical Society. At the time this nomination was prepared, no records existed within the Great Northern Railway permanent collection. Therefore, little information is known about the tender. However, because of its functionality with the steam locomotive, a definite connection exists between the steam locomotive and tender.

The tender played an important function in steam locomotive operations by providing a storage car for fuel and water. Generally tenders were built in a rectangular box-style, consisting of a fuel bunker (that held coal, wood, or heated fuel oil) and a water tank. The fuel bunker typically sloped downwards towards the locomotive providing fireman with easier access to the wood or coal; or to provide an even flow of fuel oil into the steam locomotives fire box.

The Great Northern Railway utilized two different styles of tenders: the rectangular style and the Vanderbilt, which featured a round cylinder tank. The Vanderbilt tender advantages over the rectangular style were more carrying capacity, lighter weight in construction materials, and stronger. While GN 1355 had been assigned both the Vanderbilt and rectangular box-style tenders; the locomotive spent most of its operating years with the rectangular-box style tender.

The Great Northern Railway didn't keep its steam locomotives and original tenders together very well. Many tenders migrated from type to type to solve capacity problems with changing operational requirements due to the topography of the railroad's system. Tender 1451 was assigned to Steam Locomotive no. 1355 during the 1940's when the engine was in service pulling ore trains out of the Minnesota Iron Range and branch line freight service in southwestern Minnesota and northwest Iowa. The following chart, courtesy of Ben Ringnalda, details the tenders assigned to GN 1355 from 1941 to the end of service in 1955:

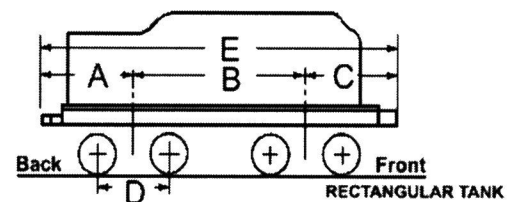

The following letters correspond to the columns in the table below. They represent the following:

A Truck-center to coupler distance

B Truck spacing

C Truck-center to engine-coupler distance

D Axle spacing

E Length over pulling surfaces

Graphic and Table by Ben Ringnalda

**United States Department of the Interior
National Park Service**

**National Register of Historic Places
Continuation Sheet**

Section number 8

Page 29

Tenders assigned to individual H-5 Class locomotives in the years given:

GN H-5#	1941			1943			1949			1952		
	STYLE	CLASS	NO.	STYLE	CLASS	NO.	STYLE	CLASS	NO.	STYLE	CLASS	NO.
1350	115		2597	20	F-8	1225	20	F-8	1225	20	F-8	1225
1351	70	O-1	3065	-	-	-	-	-	-	-	-	-
1352	66	O-1	3054	104	P-2	2512	104	P-2	2512	104	P-2	2512
1353		O-1	3059	70	O-1	3057	70	O-1	3057	70	O-1	3057
1354	70	O-1	3060	59	N-2	2016	59	N-2	2016	-	-	-
1355	70	O-1	3052	33	H-4	1451	33	H-4	1451	33	H-4	1451
1356	56	M-2	1983	56	M-2	1983	56	M-2	1983	-	-	-
1357	69	O-1	1315	69	O-1	1315	69	O-1	1315	-	-	-
1358	70	O-1	3061	70	O-1	3050	70	O-1	3050	-	-	-
1359	70	O-1	3048	70	O-1	3048	50	J-2	1578	50	J-2	1578
1360				70	O-1	3051	63	O-1	3105	63	O-1	3105
1361				70	O-1	3061	69	O-1	3034	31	H-3	1436
1362	104	P-2	2513	104	P-2	2513	104	P-2	2513	-	-	-
1363	104	P-2	2512	66	O-1	3054	70	O-1	3061	70	O-1	3061
1364				59	N-2	2011	59	N-2	2011	59	N-2	2011
1365	70	O-1	3055	70	O-1	3055	70	O-1	3055	-	-	-
1366				70	O-1	3056	70	O-1	3056	100	O-4	3246
1367				66	O-1	3046	58	N-2	2008	-	-	-
1368	70	O-1	3069	70	O-1	3069	26	H-2		-	-	-
1369				104	P-2	2515	104	P-2	2515	104	P-2	2515
1370				104	P-2	2509	104	P-2	2509	104	P-2	2509
1371				50	J-2	1578	69	O-1	3034	69	O-1	3034
1372					M-2	1963	104	P-2	2505	104	P-2	2505
1373				70	O-1	3045	70	O-1	3045	70	O-1	3045
1374				70	O-1	3052	70	O-1	3052	70	O-1	3052

United States Department of the Interior
National Park Service

National Register of Historic Places
Continuation Sheet

Section number 8

Page 30

APPENDIX

Graphic by Doug Bemrich: 1987

Boiler Diagram for
Great Northern Railway Steam Locomotive No. 1355

- 1. FIREBOX
- 2. WHISTLE
- 3. BELFAIRE SHEET
- 4. FLEXIBLE CROWN STAYS (see fig. 2)
- 5. LONGITUDINAL STAYS
- 6. FIREDOOR
- 7. SAFETY VALVES
- 8. AUXILIARY DOME
- 9. STEAM DOME
- 10. THROTTLE SHAFT
- 11. LONGITUDINAL SEAM
- 12. CHECK VALVE OPENING
- 13. STACK
- 14. STEAM PIPE OPENING
- 15. SMOKEBOX DOOR
- 16. SMOKEBOX
- 17. BARREL
- 18. CONICAL COURSE
- 19. STEAM DOME COURSE
- 20. SECOND COURSE
- 21. FIRST COURSE
- 22. THROAT SHEET
- 23. WASHOUT PLUG
- 24. FIREBOX DRAFT OPENING
- 25. FLEXIBLE STAYBOLTS
- 26. FIXED STAYBOLTS
- 27. WASHOUT PLUG
- 28. FIREDOOR OPENING
- 29. DIAGONAL BRACES
- 30. FIXED CROWN STAYS
- 31. ARCH TUBE
- 32. FLEXIBLE CROWN STAYS
- 33. WATER
- 34. SAFETY VALVE
- 35. AUXILIARY DOME
- 36. STEAM DOME
- 37. THROTTLE VALVE
- 38. DRY PIPE
- 39. SUPERHEATER HEADER
- 40. STACK
- 41. SMOKEBOX
- 42. STEAM DELIVERY PIPE
- 43. BAFFLE
- 44. FRONT FLUE SHEET
- 45. 2 1/4" FLUES
- 46. SUPERHEATER UNITS
- 47. 5 1/2" FLUES
- 48. FLEXIBLE STAYBOLTS (see fig. 1)
- 49. INNER RIVETED ENDS OF STAYBOLTS
- 50. DRAFT OPENING
- 51. OIL BURNER NOZZLE
- 52. FIREBRICK
- 53. MUD RING

STAYBOLT

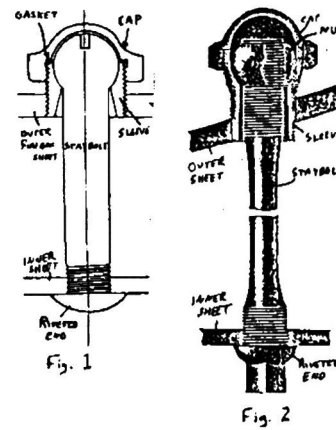

EXTERIOR VIEW

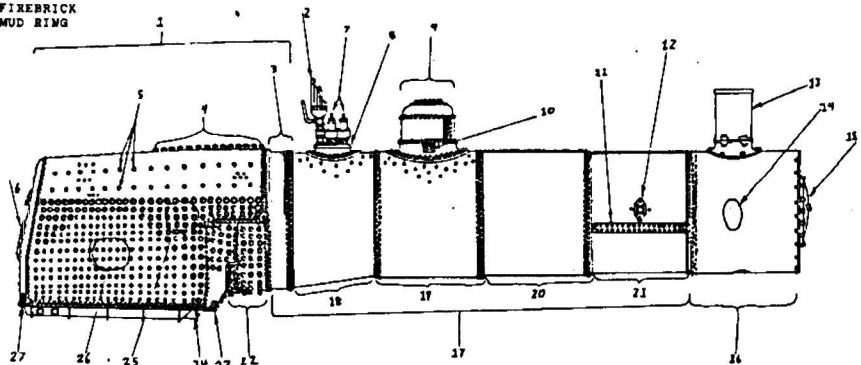

INTERIOR VIEW

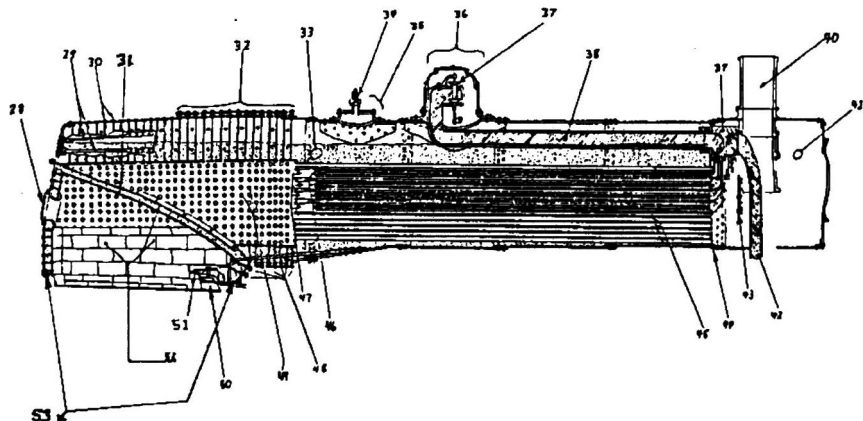

United States Department of the Interior
National Park Service

National Register of Historic Places
Continuation Sheet

Section number 8

Page 31

ROSTERS

Class H-5 4-6-2: 23½x30-73-210 (200) - 271,800-164,000 (weights varied) - 38,580 originally. Working boiler pressure later increased to 210 psi, increasing T.E. to 40,510 lb. During the 1930's, locomotive Nos. 1352, 1353, 1356, and 1363 had boosters (11,000 lb. T.E.) mounted on trailing trucks. (Rebuilt from Class E-14 4-6-0)

No.	Builder	Date Start Rbid.	Date Finish Rbid.	C/N	Rbit. From E-14 No.	Renumbered From No.	Date	Disposition
1350	GN (Dale Street)		7-8-1921	33948	GN 1031	GN 1486	2-10-1926	Sold for scrap WEI&M 7-16-1953.
1351	GN (Dale Street)	8-25-1921	1-11-1922	33887	GN 1018	GN 1487	2-24-1926	Wrecked 7-24-1941, dismantled 10-1941.
1352	GN (Dale Street)	7-5-1921	10-6-1921	33907	GN 1019	GN 1488	3-3-1926	Sold for scrap PC&Co 7-16-1953.
1353	GN (Dale Street)	8-3-1921	11-14-1921	33913	GN 1025	GN 1489	2-12-1926	Sold for scrap DI&M 7-16-1953.
1354	GN (Dale Street)	12-5-1921	3-20-1922	33910	GN 1022	GN 1490	2-8-1926	Sold for scrap PC&Co 4-26-1952.
1355	GN (Dale Street)	2-19-1924	5-29-1924	33908	GN 1020	GN 1494	4-10-1926	Placed on public exhibition.*
1356	GN (Dale Street)	4-25-1922	3-26-1923	33885	GN 1016	GN 1492	2-8-1926	Sold for scrap DI&M 4-26-1952.
1357	GN (Dale Street)	12-6-1924	1-26-1925	33912	GN 1024	GN 1493	2-10-1926	Sold for scrap PC&Co 5-2-1952.
1358	GN (Dale Street)		12-30-1922	33911	GN 1023	GN 1491	2-24-1926	Sold for scrap PC&Co 9-13-1950.
1359	GN (Dale Street)	4-4-1924	6-4-1924	33943	GN 1030	GN 1495	2-10-1926	Sold for scrap WEI&M 8-25-1955.
1360	GN (Delta)	12-10-1925	4-16-1926	33942	GN 1029	---	---	Sold for scrap PC&Co 7-16-1953.
1361	GN (Hillyard)	1-23-1926	3-22-1926	33989	GN 1032	---	---	Sold for scrap PC&Co 4-21-1953.
1362	GN (Hillyard)	3-13-1926	5-8-1926	33842	GN 1010	---	---	Sold for scrap DI&M 11-13-1951.
1363	GN (Hillyard)	4-3-1926	5-28-1926	33940	GN 1027	---	---	Sold for scrap PC&Co 7-16-1953.
1364	GN (Delta)	4-24-1926	6-15-1926	33840	GN 1008	---	---	Sold for scrap PC&Co 10-28-1952.
1365	GN (Dale Street)		12-23-1926	33844	GN 1012	---	---	Sold for scrap DI&M 4-1-1952.
1366	GN (Dale Street)	10-28-1926	2-9-1927	33909	GN 1021	---	---	Sold for scrap DI&M 12-28-1954.
1367	GN (Dale Street)	11-16-1926	4-11-1927	33941	GN 1028	---	---	Sold for scrap DI&M 6-8-1951.
1368	GN (Dale Street)		6-17-1927	33845	GN 1013	---	---	Sold for scrap PC&Co 4-22-1952.
1369	GN (Delta)	11-12-1926	1-24-1927	33883	GN 1014	---	---	Sold for scrap WEI&M 4-26-1955.
1370	GN (Delta)	1-26-1927	4-29-1927	33843	GN 1011	---	---	Sold for scrap DI&M 10-1-1952.
1371	GN (Hillyard)	2-19-1927	5-27-1927	33884	GN 1015	---	---	Sold for scrap DI&M 8-25-1955.
1372	GN (Delta)	4-8-1927	7-9-1927	33886	GN 1017	---	---	Sold for scrap DI&M 4-21-1953.
1373	GN (Hillyard)	6-4-1927	8-9-1927	33841	GN 1009	---	---	Sold for scrap DI&M 12-28-1954.
1374	GN (Delta)	7-27-1927	11-18-1927	33914	GN 1026	---	---	Sold for scrap PC&Co 10-10-1952.

*Municipal Auditorium, Sioux City, IA, 7-14-1955.

H-5 Tender Assignments

1350	St. 115, ..., 2597 (5-1941) St. 20, F-8, 1225 (4-1943 to 12-1951)	1362	St. 104, P-2, 2513 (5-1941 to 6-1949)
1351	St. 70, O-1, 3065 (5-1941)	1363	St. 104, P-2, 2512 (5-1941) St. 66, O-1, 3054 (4-1943) St. 70, O-1, 3061 (6-1949 to 12-1951)
1352	St. 66, O-1, 3054 (5-1941) St. 104, P-2, 2512 (4-1943 to 6-1949)	1364	St. 59, N-2, 2011 (4-1943 to 12-1951)
1353	St. ?, O-1, 3059 (5-1941) St. 70, O-1, 3057 (4-1943 to 3-1952)	1365	St. 70, O-1, 3055 (5-1941 to 12-1951)
1354	St. 70, O-1, 3060 (5-1941) St. 59, N-2, 2016 (4-1943 to 6-1949)	1366	St. 70, O-1, 3069 (5-1941) St. 70, O-1, 3056 (4-1943 to 6-1949) St. 100, O-4, 3246 (12-1951)
1355	St. 70, O-1, 3052 (5-1941) St. 33, H-4, 1451 (4-1943 to 6-1949)	1367	St. 66, O-1, 3046 (4-1943) St. 58, N-2, 2008 (6-1949)
1356	St. 56, M-2, 1983 (5-1941 to 3-1952)	1368	St. 70, O-1, 3069 (5-1941 to 4-1943) St. 26, H-2, ? (6-1949) NOTE: Diagram says No. 1472, but 1472 is H-4
1357	St. 69, O-1, 3015 (5-1941 to 3-1952)	1369	St. 104, P-2, 2515 (4-1943 to 12-1951)
1358	St. 70, O-1, 3061 (5-1941) St. 70, O-1, 3050 (4-1943 to 6-1949)	1370	St. 104, P-2 2509 (4-1943 to 12-1951)
1359	St. 70, O-1, 3048 (5-1941 to 10-1947) St. 50, J-2, 1578 (6-1949 to 12-1951)	1371	St. 50, J-2, 1578 (4-1943) St. 69, O-1, 3034 (6-1949 to 12-1951)
1360	St. 70, O-1, 3051 (4-1943) St. 63, O-1, 3105 (6-1949 to 12-1951)	1372	St. ?, M-2 1963 (4-1943) St. 104, P-2, 2505 (6-1949 to 12-1951)
1361	St. 70, O-1, 3061 (4-1943) St. 69, O-1, 3034 (6-1949) St. 31, H-3, 1436 (12-1951)	1373	St. 70, O-1, 3045 (4-1943 to 12-1951)
		1374	St. 70, O-1, 3052 (4-1943 to 12-1951)

United States Department of the Interior
National Park Service

National Register of Historic Places
Continuation Sheet

Section number 8

Page 32

Source: Great Northern Steam Locomotives Class H-5, Reference Sheet No. 170. 1990

Great Northern Railway
Pacific-Style Locomotive Specification Sheets

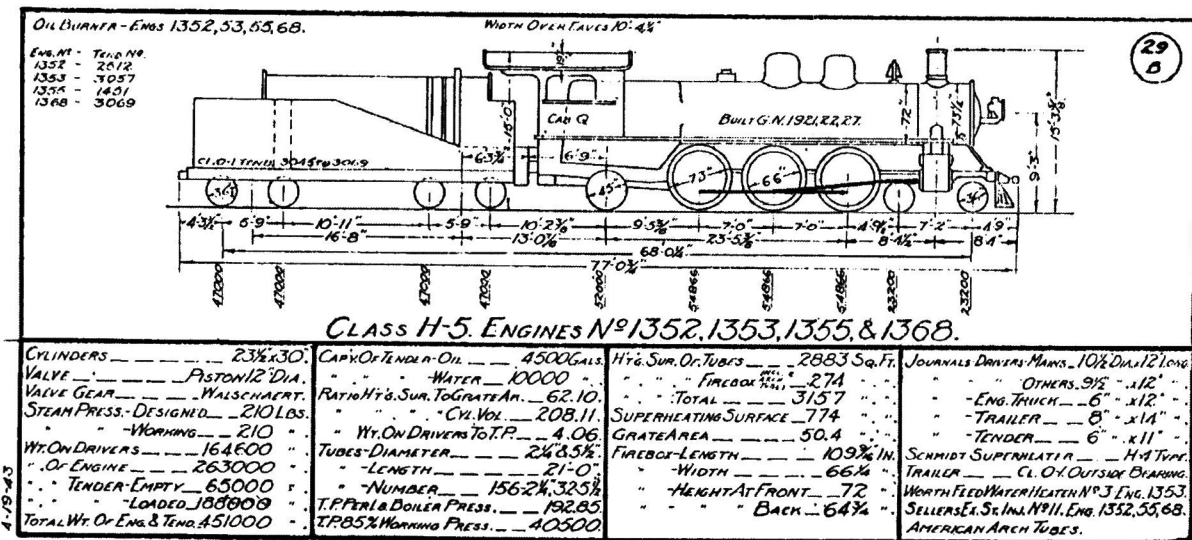

United States Department of the Interior
National Park Service

National Register of Historic Places
Continuation Sheet

Section number 8

Page 33

Source: Great Northern Steam Locomotives Class H-5, Reference Sheet No. 170. 1990

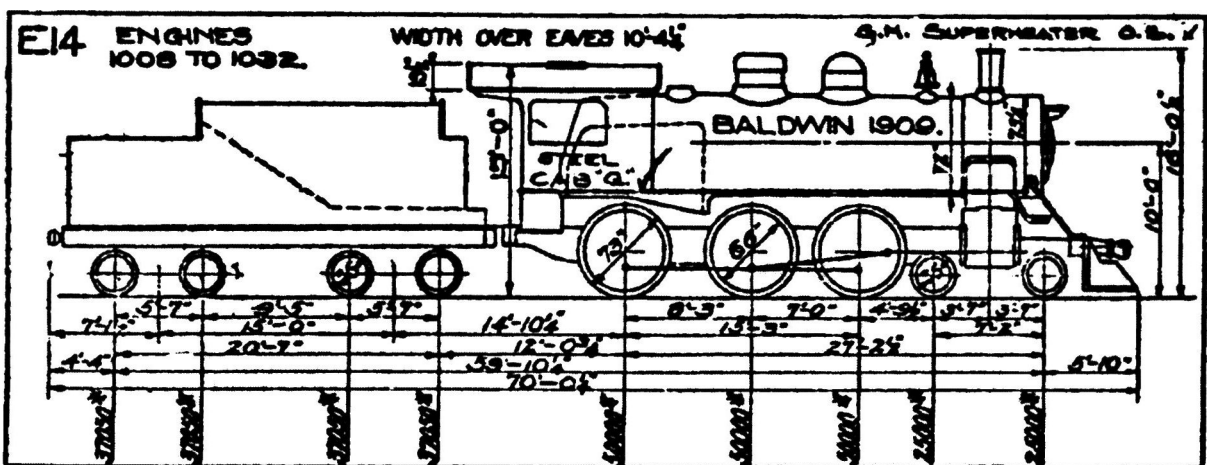

L.C.B. - W.J.S.	CYLINDERS	23 1/2 X 30"	TUBES, DIAMETER	2 1/2 & 5 INCH
	VALVES	PISTON	• LENGTH	18'-6"
	VALVE GEAR	WALSCHAERT	• NUMBER	180-2 1/4, 26-5"
	STEAM PRESSURE (DESIGNED)	210 LBS	HEATING SURFACE, TUBES	2311.50 FT
	WEIGHT ON DRIVERS	150000 #	• FIREBOX	165.50 FT
	• OF ENGINE	200000 #	• TOTAL	2470.50 FT
	• TENDER-EMPTY	55600 #	SUPERHEATING SURFACE	445.50 FT
	• TENDER-LOADED	148200 #	GRATE AREA	49.5 SQ. FT
	• ENGINE & TENDER	348200 #	FIREBOX, LENGTH	108 INCHES
	CAPACITY, TENDER-COAL	13 TONS	• WIDTH	66 1/2 INCHES
	• TENDER-WATER	8000 GALS	• HEIGHT-FRONT	69 INCHES
	RATIO, HEATING SURFACE TO GRATE	50.02	• HEIGHT-BACK	83 1/2 INCHES
	• HEATING SURFACE TO CYL. VOL.	164.63	JOURNALS, DRIVERS	6 1/2 DIA X 12" LONG
	• WT. ON D'RS. TO T.P.	3.89	• ENG. TRUCK	6" DIA X 12" LONG
	TRACTIVE POWER @ 85% Working Press	38,580	• TENDER	5 1/2 DIA X 10" LONG
" PER LB.	192.94			
STEAM PRESSURE (WORKING)	220 LBS.			

United States Department of the Interior
National Park Service

National Register of Historic Places
Continuation Sheet

Section number 8

Page 34

Source: International Library of Technology

Locomotive Boilers, Valve Gears, Breakdowns

London: International Textbook Company, 1906

Boiler Comparison Drawings

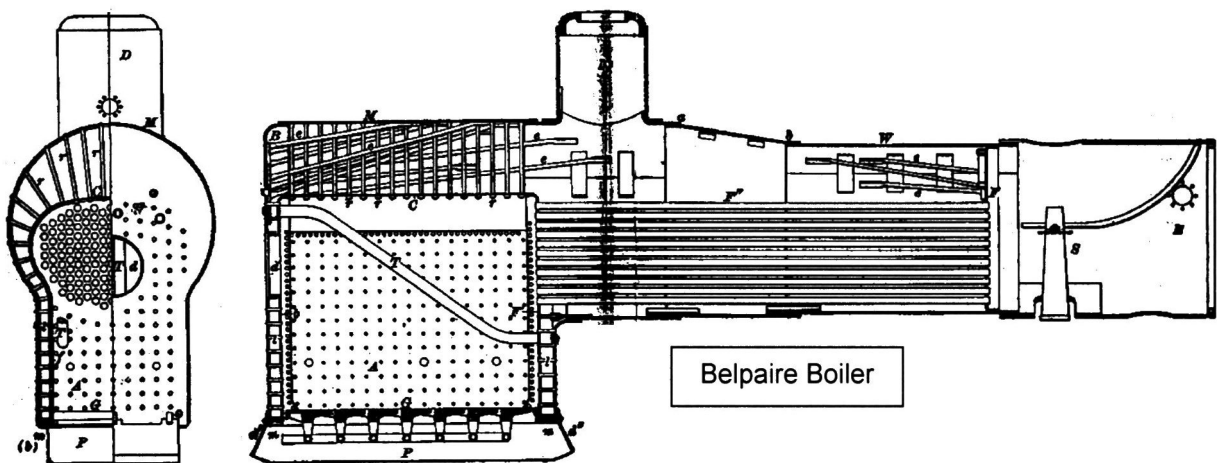
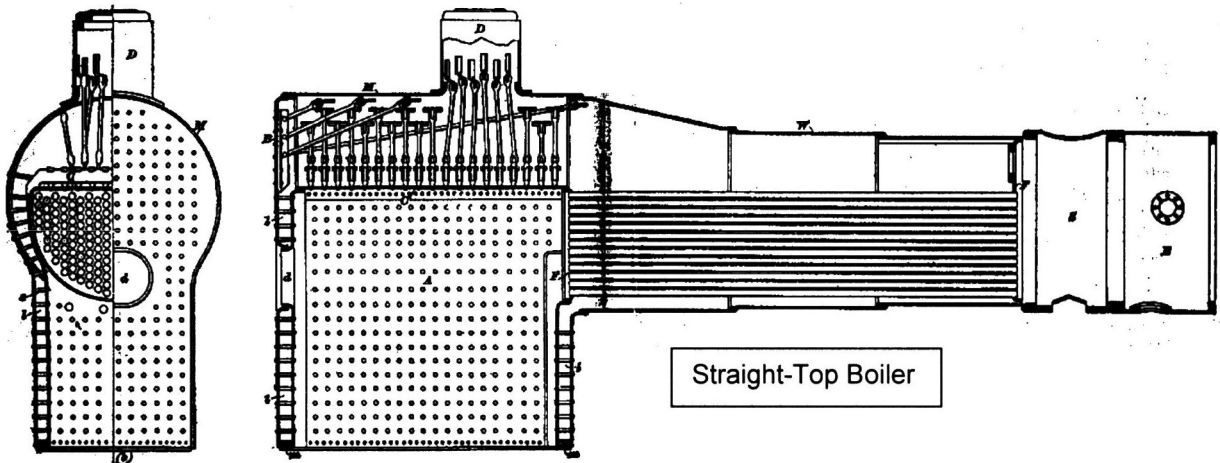

**United States Department of the Interior
National Park Service**

**National Register of Historic Places
Continuation Sheet**

Section number 8

Page 35

Source: Surviving Steam Locomotive Database, www.steamlocomotive.com

Steam Locomotive Search: Surviving Pacific-Style Steam Locomotives

1 search keyword(s): 4-6-2

No.	Class	F.M. Whyte	Gauge	Railroad Line	Location	Status	Notes
1912		<u>4-6-2</u>	19"	<u>Swanton Pacific</u>	Swanton Pacific, Davenport, CA	operational	
1913		<u>4-6-2</u>	19"	<u>Swanton Pacific</u>	Swanton Pacific, Davenport, CA	restoration	
1914		<u>4-6-2</u>	19"	<u>Swanton Pacific</u>	Swanton Pacific, Davenport, CA	operational	
2467	P-8	<u>4-6-2</u>	4'-8½"	SP	<u>PLA</u> , Army base (80/Grand), Oakland, CA	operational	
1915		<u>4-6-2</u>	19"	Overfair	<u>California State Railroad Museum</u> , Sacramento, CA	display	
2472	P-8	<u>4-6-2</u>	4'-8½"	SP	<u>Golden Gate Railroad Museum</u> , San Francisco, CA	operational	
<u>2479</u>	P-10	<u>4-6-2</u>	4'-8½"	SP	<u>Santa Clara Co Fairgnds</u> , S Hwy 101, San Jose, CA	restoration	
22		<u>4-6-2</u>	ng		S Turkey Rd, Hwy 285, Tiny Town, CO	operational	
1246	G5c	<u>4-6-2</u>	4'-8½"	CPR	<u>RMNE, Valley Railroad</u> , Essex, CT	display	painted in April, 2002
<u>1401</u>	Ps-4	<u>4-6-2</u>	4'-8½"	<u>SR</u>	Smithsonian Museum, Washington, DC	display	Named Charlotte
1504	<u>USRAI</u>	<u>4-6-2</u>	4'-8½"	<u>ACL</u>	Convention Center, Jacksonville, FL	display	
113		<u>4-6-2</u>	4'-8½"	<u>FEC</u>	<u>Gold Coast Railroad Museum</u> , Miami, FL	display	
153		<u>4-6-2</u>	4'-8½"	<u>FEC</u>	<u>Gold Coast Railroad Museum</u> , Miami, FL	display	
107(88)		<u>4-6-2</u>	4'-8½"	<u>GAN(FEC)</u>	near old depot, downtown, Albany, GA	display	
290	<u>USRAh</u>	<u>4-6-2</u>	4'-8½"	<u>A&WP</u>	<u>Southeastern Railway Museum</u> , Duluth, GA	restoration	
750(80)		<u>4-6-2</u>	4'-8½"	<u>S&A(FEC)</u>	<u>Southeastern Railway Museum</u> , Duluth, GA	display	
1355	H-5	<u>4-6-2</u>	4'-8½"	<u>GN</u>	Siouxland Hist Assn(Milw Shops), Sioux City, IA	restoration	Official Project of "Save America's Treasures"
886 (887)	P-31	<u>4-6-2</u>	4'-8½"	<u>CRI&P</u>	Wheels O' Time Museum, Peoria, IL	display	

**United States Department of the Interior
National Park Service**

**National Register of Historic Places
Continuation Sheet**

Section number 8

Page 36





938	P-33	<u>4-6-2</u>	4'-8½"	<u>CRI&P</u>	<u>Illinois Railway Museum</u> , Union, IL	display	from Fort Worth
3415	3400	<u>4-6-2</u>	4'-8½"	<u>AT&SF</u>	Abilene & Smoky Hill RR, Abilene, KS	display	
3416	3400	<u>4-6-2</u>	4'-8½"	<u>AT&SF</u>	City Park, Great Bend, KS	display	
3424	3400	<u>4-6-2</u>	4'-8½"	<u>AT&SF</u>	Highway Park, Kinsley, KS	display	
152	K-2A	<u>4-6-2</u>	4'-8½"	<u>L&N</u>	<u>Kentucky Railway Museum</u> , New Haven, KY	operational	official steam locomotive of KY
5300	P7	<u>4-6-2</u>	4'-8½"	B&O	<u>B&O Railroad Museum</u> , Baltimore, MD	display	Named President Washington
202	K-2	<u>4-6-2</u>	4'-8½"	<u>WM</u>	Hagerstown City Park, Hagerstown, MD	display	
470		<u>4-6-2</u>	4'-8½"	MEC	park next to RR yard, Waterville, ME	display	
3003		<u>4-6-2</u>	15"		Detroit Zoo, Detroit, MI	display	
5632	K-4-b	<u>4-6-2</u>	4'-8½"	<u>GTW</u>	depot, Durand, MI	display	
730	H-3	<u>4-6-2</u>	4'-8½"	<u>MSP&SSM</u>	Penstar Complex, Gladstone, MI	display	
5030	J-3-a	<u>4-6-2</u>	4'-8½"	<u>GTW</u>	R.A. Greene Park, Jackson, MI	display	
148		<u>4-6-2</u>	4'-8½"	<u>FEC</u>	Zerr's Historic Steam Train LLC, near C&O engine house, Traverse City, MI	restoration	scheduled to run in fall, 2001
110		<u>4-6-2</u>	4'-8½"	Little River	<u>Little River Railroad</u> , White Pigeon, MI	operational	<u>photo</u>
2153	Q-3	<u>4-6-2</u>	4'-8½"	<u>NP</u>	park, East Grand Forks, MN	display	to <u>Minnesota Transportation Museum</u>
2156	Q-3	<u>4-6-2</u>	4'-8½"	<u>NP</u>	<u>Minnesota Transportation Museum</u> , St. Paul, MN	stored	
5529	K-1-d	<u>4-6-2</u>	4'-8½"	CNR	<u>Museum of Transportation</u> , St. Louis, MO	display	
2164	Q-3	<u>4-6-2</u>	4'-8½"	<u>NP</u>	<u>Camp Hancock State Historic Site</u> , Bismarck, ND	display	
735	H-3	<u>4-6-2</u>	4'-8½"	<u>MSP&SSM</u>	Roosevelt Park, Minot, ND	display	<u>in danger of being scrapped</u>
3666	P-2	<u>4-6-2</u>	4'-8½"	B&M	harbor, Portsmouth, NH	<u>sunk</u>	
1293	G5d	<u>4-6-2</u>	4'-8½"	CPR	<u>Ohio Central Railroad</u> , Sugar creek, OH	operational	to operate daily runs while 1551 is in the shop
1278	G5d	<u>4-6-2</u>	4'-8½"	CPR	<u>Ohio Central Railroad Shops</u> , West Lafayette, OH	stored	awaiting restoration, suffered crownsheet failure
578	E2b	<u>4-6-2</u>	4'-8½"	<u>N&W</u>	<u>Ohio Railway Museum</u> , Worthington, OH	display	
905	P-33	<u>4-6-2</u>	4'-8½"	<u>CRI&P</u>	Fuqua Park, Hwy 81 & Beech Ave., Duncan, OK	display	

**United States Department of the Interior
National Park Service**

**National Register of Historic Places
Continuation Sheet**

Section number 8

Page 37

3203 (197)	P-2	<u>4-6-2</u>	4'-8½"	UP(OR&N)	SP Brooklyn roundhouse, Portland, OR	restoration	 info
425	G-1	<u>4-6-2</u>	4'-8½"	BM&R (GM&N)	RBM&N headquarters, Port Clinton, PA	operational	
2317	G3c	<u>4-6-2</u>	4'-8½"	CPR	<u>Steamtown National Historic Site</u> , Scranton, PA	operational	
3713	P-4	<u>4-6-2</u>	4'-8½"	B&M	<u>Steamtown National Historic Site</u> , Scranton, PA	restoration	info
1361	K4s	<u>4-6-2</u>	4'-8½"	PRR	<u>Steamtown National Historic Site</u> , Scranton, PA	restoration	information
3750	K4s	<u>4-6-2</u>	4'-8½"	PRR	<u>Railroad Museum of Pennsylvania</u> , Strasburg, PA	display	was temporarily numbered 1737 after retirement
5288 (516)	J-7-b	<u>4-6-2</u>	4'-8½"	CNR	East Station, TVRM, Chattanooga, TN	display	from Steamtown
501		<u>4-6-2</u>	4'-8½"	CB&Q (FW&D)	depot, Childress, TX	display	
3417	3400	<u>4-6-2</u>	4'-8½"	AT&SF	3417ORG, Hulen Park, Cleburne, TX	restoration	
500 (1316)	137t	<u>4-6-2</u>	4'-8½"	TSRR (AT&SF)	<u>Texas State Railroad</u> , Rusk, TX	operational	
3423	3400	<u>4-6-2</u>	4'-8½"	AT&SF	Railroad & Pioneer Museum, Temple, TX	display	moved to restored downtown depot
1238	G5c	<u>4-6-2</u>	4'-8½"	AC(CPR)	VA Cen RR (Wharf Dist), Staunton, VA	stored serviceable	owned by Jack Showalter
1286	G5d	<u>4-6-2</u>	4'-8½"	AC(CPR)	VA Cen RR (Wharf Dist), Staunton, VA	stored serviceable	owned by Jack Showalter
2152	Q-3	<u>4-6-2</u>	4'-8½"	NP	City Park, Auburn Way N, Auburn, WA	display	
3206	P-1	<u>4-6-2</u>	4'-8½"	UP(OR&N)	Spokane Co. Fairgrounds/Expo Center, Spokane, WA	display	
2719	H-23	<u>4-6-2</u>	4'-8½"	MSP&SSM	<u>Chippewa Valley Railroad</u> , UP roundhouse, Altoona, WI	operational	
736	H-3	<u>4-6-2</u>	4'-8½"	MSP&SSM	Telulah Park, Appleton, WI	display	
2714	H-22	<u>4-6-2</u>	4'-8½"	MSP&SSM	Lakeside Park, Fond Du Lac, WI	display	photo
2718	H-23	<u>4-6-2</u>	4'-8½"	MSP&SSM	<u>National Railroad Museum</u> , Green Bay, WI	display	
60008	A4	<u>4-6- 2.3C</u>	4'-8½"	BR(LNER)	<u>National Railroad Museum</u> , Green Bay, WI	display	 Named Dwight D. Eisenhower
1924		<u>4-6-2</u>	15"		<u>Milwaukee County Zoo</u> , Milwaukee, WI	operational	
2713	H-21	<u>4-6-2</u>	4'-8½"	MSP&SSM	Depot Park, Stevens Point, WI	display	
5270	J-7-a	<u>4-6-2</u>	4'-8½"	CNR	City of M. Natural Park, Moncton, NB	display	

**United States Department of the Interior
National Park Service**

**National Register of Historic Places
Continuation Sheet**

Section number 8

Page 38

593	J-8-a	<u>4-6-2</u>	42"	CNR(NR)	RY Society of Newfoundland, Corner Brook, NF	display	info
701		<u>4-6-2</u>	4'-8½"	Temisk&N.Ont	S of ONR station, Englehart, ON	display	
5107	J-4-d	<u>4-6-2</u>	4'-8½"	CNR	CN station, Kapuskasing, ON	display	
1201	G5a	<u>4-6-2</u>	4'-8½"	CPR	<u>National Museum of Science and Technology</u> , Ottawa, ON	stored	
5588	K-3-b	<u>4-6-2</u>	4'-8½"	CNR	Riverside Drive, Windsor, ON	display	
2231	G1v	<u>4-6-2</u>	4'-8½"	CPR	<u>Canadian Railway Museum</u> , Delson, QC	display	
2341	G3d	<u>4-6-2</u>	4'-8½"	CPR	<u>Canadian Railway Museum</u> , Delson, QC	display	
5550	K-2-b	<u>4-6-2</u>	4'-8½"	CNR	<u>Canadian Railway Museum</u> , Delson, QC	display	
60010	A4	<u>4-6- 2.3CI</u>	4'-8½"	LNER	<u>Canadian Railway Museum</u> , Delson, QC	display	Named Dominion of Canada
702		<u>4-6-2</u>	4'-8½"	QNS&L (ONR)	QNS&L Headquarters, Sept-Iles, QC	display	
5114	J-4-d	<u>4-6-2</u>	4'-8½"	CNR	Regional Park RR Mus, Melville, SK	display	
2634	G2u	<u>4-6-2</u>	4'-8½"	CPR	Western Dev Mus, Moose Jaw, SK	display	
5080	J-4-a	<u>4-6-2</u>	4'-8½"	CNR	Exhibition Grounds, Prince Albert, SK	display	
5093	J-4-c	<u>4-6-2</u>	4'-8½"	CNR	Union Station/Casino, Regina, SK	display	
2520	MR-6	<u>4-6-2</u>	4'-8½"	NdeM	depot, Querétaro, Queretaro	display	photo

**United States Department of the Interior
National Park Service**

**National Register of Historic Places
Continuation Sheet**

Section number 9

Page 39

Bibliography:

"Surviving Steam Locomotive Database": www.steamlocomotive.com

Bemrich, Douglas. Great Northern Steam Locomotives Class H-5, Reference Sheet No. 170. St. Paul: Great Northern Railway Historical Society, 1990.

Dorin, Patrick C. Great Northern Lines East. Superior Publishing Company, 1989.

Halberstadt, Hans. Working Steam Vintage Locomotives Today New York: Metro Books, 1999.

International Library of Technology. Locomotive Boilers, Valve Gears, Breakdowns. Scranton: International Textbook Company, 1906.

Kraft, Susan and Chappell, Gordon. "Historic Railroads in the National Park System and Beyond." Cultural Resource Management No. 10. U.S. Department of the Interior, National Park Service, 1999.

Krause, John & Crist, Ed. Baltimore & Ohio Heritage. Carstens Publications, 1986.

Lucas, Walter A. 100 Years of Steam Locomotives, Collectors Edition. Omaha: Rail Heritage Publications, 1981.

Petersen, William The Palimpsest: The Great Northern in Iowa." Iowa City: The State Historical Society of Iowa, 1965.

Ringnalda, Ben. Great Northern Empire Then and Now. <http://www.greatnorthernempire.net>

Stauffer, Alvin F. Steam & Electric Locomotives of the Pennsylvania Railroad (1900-1957) 1962.

Wood, Charles R. Lines West: A Pictorial History of the Great Northern Railway Operations and Motive Power from 1887 to 1967. Seattle: Superior Publishing Company, 1967

**United States Department of the Interior
National Park Service****National Register of Historic Places
Continuation Sheet**

Section number 10

Page 40

Boundary Description**Verbal Boundary Description**

The steam locomotive is permanently housed at the Milwaukee Railroad Shops Historic District in Sioux City, Iowa. The legal description for the Milwaukee Railroad Shops Historic District is as follows:

All Government Lot 1 & Lot 2 & Accretions lying west of the center line of road & Lot 2 NW SE Auditors subdivision 1 (except northeasterly part of Government Lot 1 lying west of highway being part of Accretion adjacent being 959.23 feet on south x 447.21 feet on west x 703.96 feet on east), all being located within Section 14, Township 89, Range 48 Woodbury County, Iowa.

Verbal Boundary Justification

While the Milwaukee Railroad Shops are not the locomotive's native railroad, the Milwaukee Railroad Shops are appropriate to the locomotive by allowing it to convey its significance as a steam locomotive. As a steam-era railroad engine terminal and shops complex, the Milwaukee Railroad Shops complex is an appropriate setting to adequately preserve, maintain, and further the public's understanding of the importance this locomotive has to the nation's railroad history.

UNITED STATES DEPARTMENT OF THE INTERIOR
NATIONAL PARK SERVICE

NATIONAL REGISTER OF HISTORIC PLACES
EVALUATION/RETURN SHEET

REQUESTED ACTION: NOMINATION

PROPERTY Great Northern Railway Steam Locomotive No. 1355 and Tender
NAME: 1451

MULTIPLE
NAME:

STATE & COUNTY: IOWA, Woodbury

DATE RECEIVED: 11/05/04 DATE OF PENDING LIST: 11/19/04
DATE OF 16TH DAY: 12/04/04 DATE OF 45TH DAY: 12/19/04
DATE OF WEEKLY LIST:

REFERENCE NUMBER: 04001352

REASONS FOR REVIEW:

APPEAL: N DATA PROBLEM: N LANDSCAPE: N LESS THAN 50 YEARS: N
OTHER: N PDIL: N PERIOD: N PROGRAM UNAPPROVED: N
REQUEST: N SAMPLE: N SLR DRAFT: N NATIONAL: N

COMMENT WAIVER: N

ACCEPT RETURN REJECT 12/15/04 DATE

ABSTRACT/SUMMARY COMMENTS:

Entered in the
National Register

RECOM./CRITERIA _____

REVIEWER _____ DISCIPLINE _____

TELEPHONE _____ DATE _____

DOCUMENTATION see attached comments Y/N see attached SLR Y/N

If a nomination is returned to the nominating authority, the nomination is no longer under consideration by the NPS.

SEP 29 2004

CLG NATIONAL REGISTER REVIEW

CLG Name Sioux City Date of Public Meeting September 14, 2004

Property Name Great Northern Railway Steam Locomotive No. 1355 and Tender 1451, 3400 Sioux River Road, Sioux City, Woodbury County

1. For Historic Preservation Commission:

- Recommendation of National Register eligibility
- Recommendation of National Register ineligibility

Signature *Robert R. Coacher*

Date 9-14-04

Print Name Robert R. Coacher

Title Chair, Sioux City Historic Preservation Commission

Reason(s) for recommendation:

We recommend approval because No. 1355 is the only surviving locomotive in its class; it is the only one being restored to an operable condition (in the state of Iowa); and it is a wonderful representative of the Great Northern Railway's heritage.

2. For Chief Elected Local Official:

- Recommendation of National Register eligibility
- Recommendation of National Register ineligibility

Signature *David W. Ferris*

Date _____

Print Name David W. Ferris, Mayor

Title Mayor

Reason(s) for recommendation:

3. Professional Evaluation Name Gretchen E. Schalge

- Recommendation of National Register eligibility
- Recommendation of National Register ineligibility

Signature *Gretchen E. Schalge*

Date Sept 15 2004

Print Name Gretchen E. Schalge

Title Community Development Coordinator

Reason(s) for recommendation:

See no. 1 above.

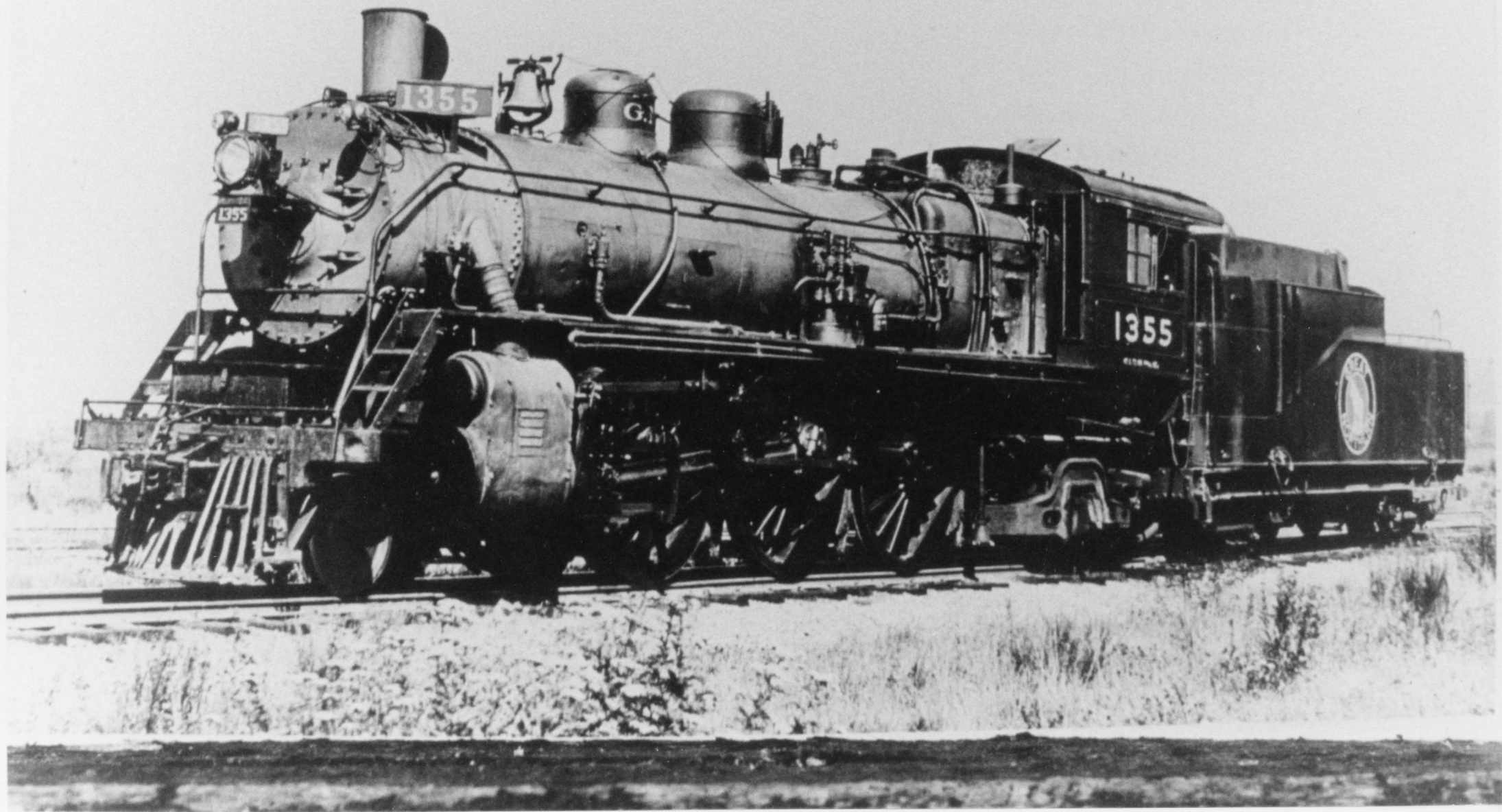

Great Northern Railway Steam Locomotive No. 1355

Woodbury County, Iowa

Photographer: unknown - Great Northern Railway

Negative Location: unknown - owner has a negative off of a print - Sioux City, Iowa

Photograph Date: 1924

Description:

View - Fireman (left) side

Company photo of locomotive after its rebuild and conversion.

Photo #1.

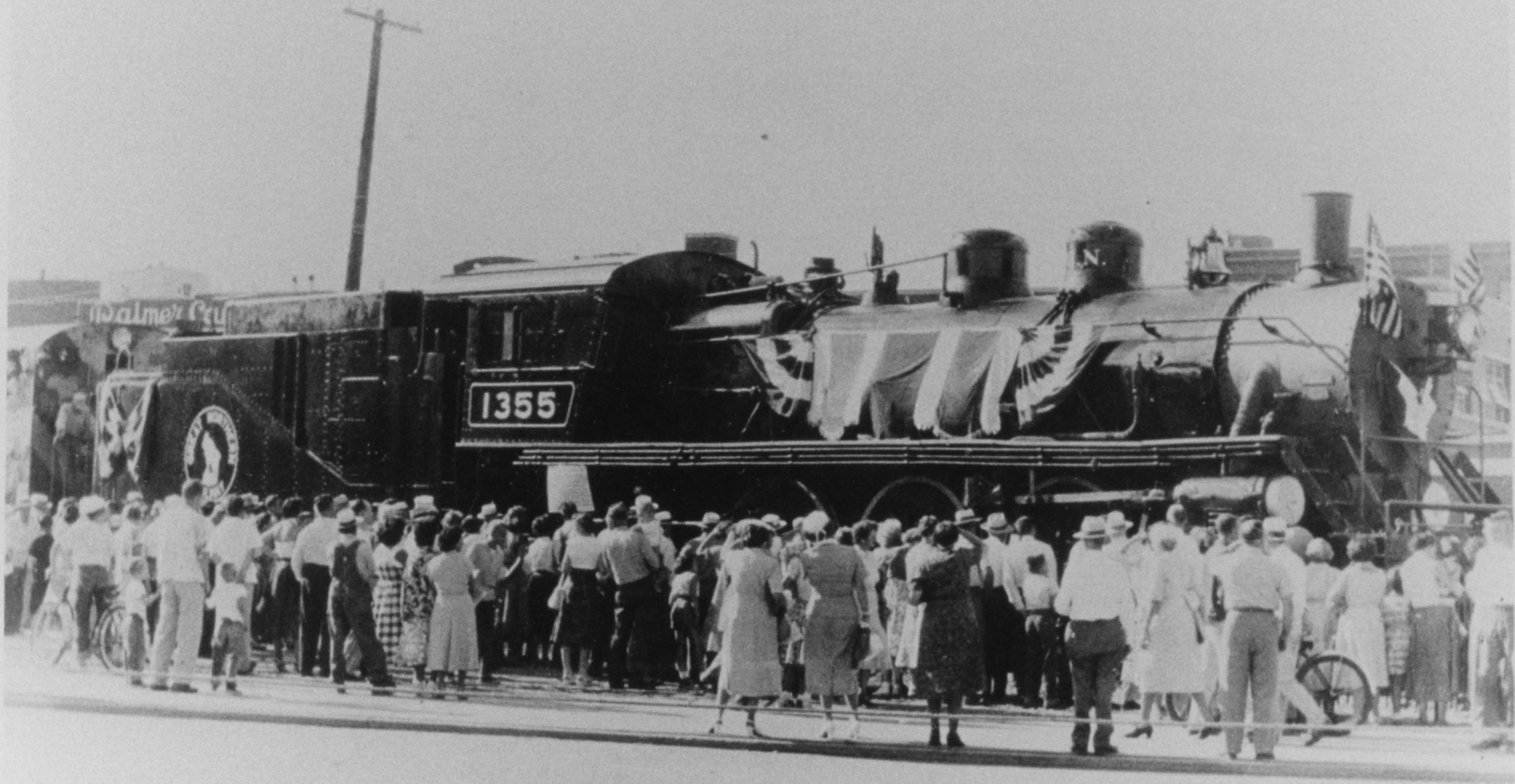

Great Northern Railway Steam Locomotive No. 1355 and Tender 1451

Woodbury County, Iowa

Photographer: I. W. Reck

Original Negative Location: unknown

Photograph Date: July 14, 1955

Description:

View - Engineer (Right) Side

Locomotive is retired from railroad service and placed on exhibition at the Sioux City Municipal Auditorium.

Photo #2



"THE LAST NIGHT"

Great Northern Railway Steam Locomotive No. 1355 and Tender 1451

Woodbury County, Iowa

Photographer: Gerald Zensen

Original Negative Location: Anthon, Iowa

Photograph Date: June 29, 1984

Description:

Fireman Side (Left) View.

Photo of the locomotive's last night of public exhibition on the grounds of the Sioux City Municipal Auditorium.

Photo #3



Great Northern Railway Steam Locomotive No. 1355 and Tender 1451

Woodbury County, Iowa

Photographer: Larry Obermeyer

Negative Location: Sioux City, Iowa - Owner's Archives

Photograph Date: Circa 2004

Description of View: (Engineer Side) Right side of Locomotive.

Current Condition Photo - Locomotive under restoration

Location: Milwaukee Railroad Shops Historic District
Sioux City, Iowa

Photograph Number: #4

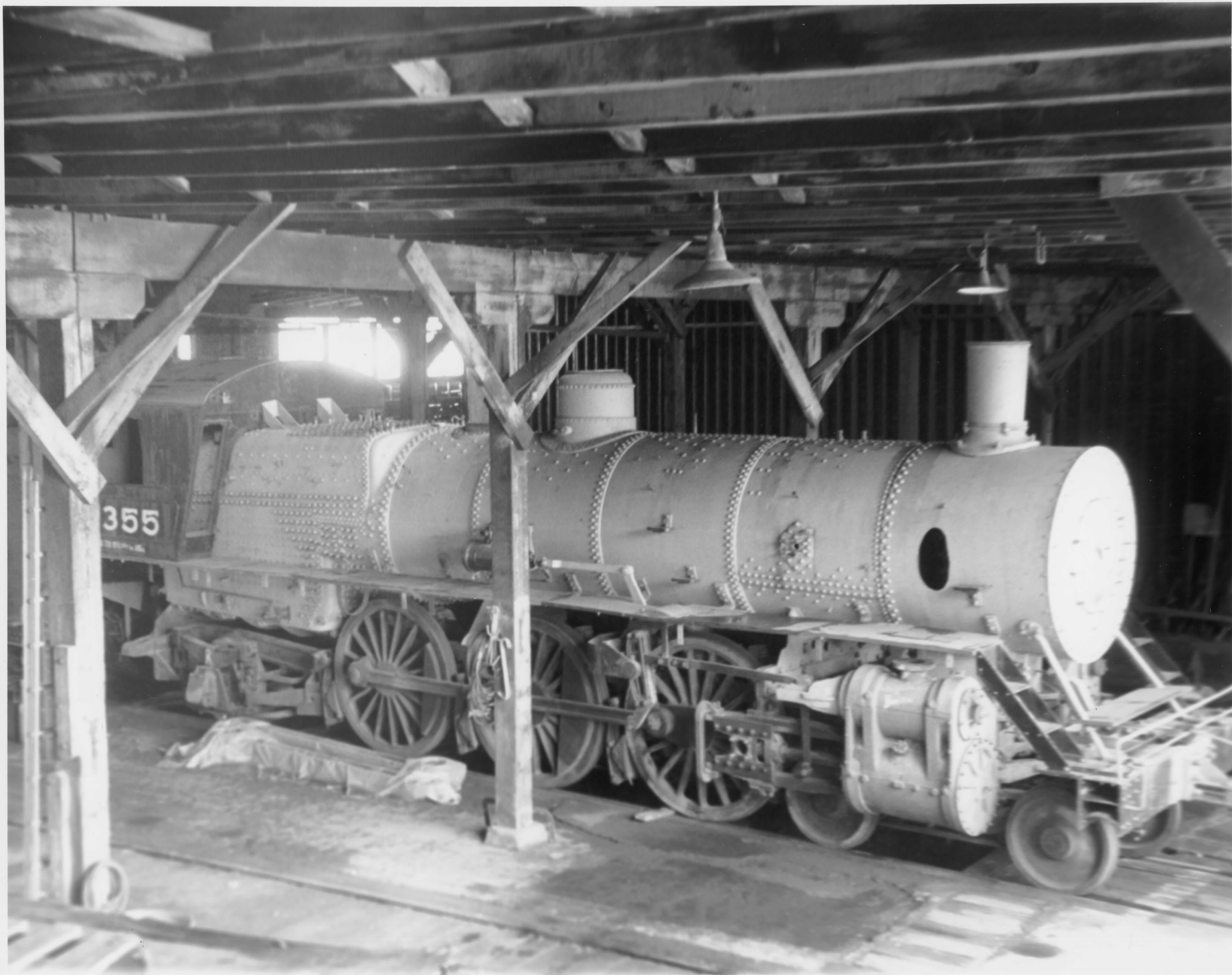

Great Northern Railway Steam Locomotive No. 1355 and Tender 1451

Woodbury County, Iowa

Photographer: Larry Obermeyer

Negative Location: Sioux City, Iowa - Owner's Archives

Photograph Date: Circa 2004

Description of View: Engineer Side - Locomotive under restoration and on display at the Milwaukee Railroad Shops Historic District, Sioux City, Iowa. Interior view of roundhouse building. Current Condition Photo - GN1355.

Photograph #5



Great Northern Railway Steam Locomotive No. 1355 and Tender 1451

Woodbury County, Iowa

Photographer: Larry Obermeyer

Negative location: Sioux City, Iowa - Owner's Archives

Photograph Date: Circa 2004

Description of View: Locomotive and tender on display, between the turntable and roundhouse, at the Milwaukee Railroad Shops Historic District in Sioux City, Iowa. Pictured with the steam locomotive is ex-Marine Corps diesel locomotive, a first-generation G.E. Center-Cab engine.

Photograph # 6

UNITED STATES
DEPARTMENT OF THE INTERIOR
GEOLOGICAL SURVEY

SIoux CITY NORTH QUADRANGLE
IOWA-SOUTH DAKOTA
7.5 MINUTE SERIES (TOPOGRAPHIC)

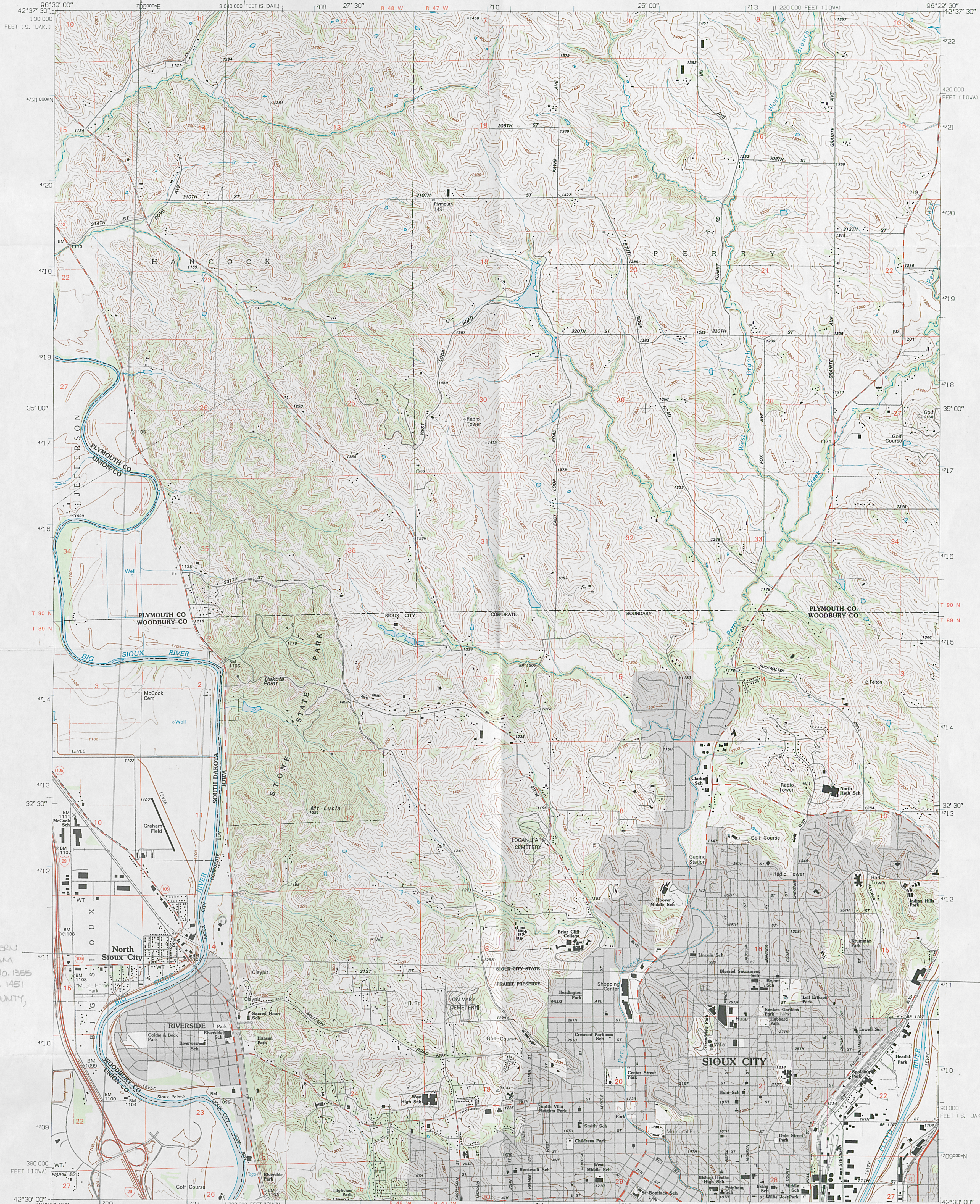

GREAT NORTHERN
RAILWAY STEAM
LOCOMOTIVE NO. 1355
AND TENDER 1451
WOODBURY COUNTY,
IOWA
E 707440
N 4711280

Produced by the United States Geological Survey
Control by USGS and NOS/NOAA
Topography by photogrammetric methods from aerial photographs taken 1961 and planimetric surveys 1963. Revised from aerial photographs taken 1990-91. Field checked 1993. Map edited 1994
North American Datum of 1927 (NAD 27). Projection and blue 1000-meter ticks: Universal Transverse Mercator, zone 14
10 000-foot ticks: Iowa coordinate system, north zone and South Dakota coordinate system, south zone
North American Datum of 1983 (NAD 83) is shown by dashed corner ticks. The values of the shift between NAD 27 and NAD 83 for 7.5-minute intersections are obtainable from National Geographic Survey NADCON software
There may be private inholdings within the boundaries of the National or State reservations shown on this map
Gray tint indicates areas in which only landmark buildings are shown
Fine red dashed lines indicate selected fence and field lines where generally visible on aerial photographs. This information is unchecked

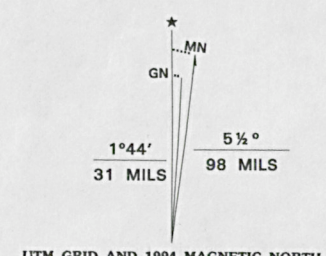

SCALE 1:24000
CONTOUR INTERVAL 20 FEET
SUPPLEMENTARY CONTOUR INTERVAL 5 FEET
NATIONAL GEODETIC VERTICAL DATUM OF 1929



ROAD CLASSIFICATION
Primary highway Light-duty road, hard or hard surface
Secondary highway Improved surface
hard surface Unimproved road
Interstate Route U.S. Route State Route

1	2	3	1 Elk Point NE
4	5	6	2 Millerville
7	8	7	3 Hinton
		8	4 Jefferson
			5 James
			6 Jackson
			7 Sioux City South
			8 Sergeant Bluff

SIoux CITY NORTH, IOWA-S. DAK.
42096-E4-TF-024
1994
DMA 6769 III SW-SERIES V876

THIS MAP COMPLIES WITH NATIONAL MAP ACCURACY STANDARDS
FOR SALE BY U.S. GEOLOGICAL SURVEY, DENVER, COLORADO 80225, OR RESTON, VIRGINIA 22092
AND IOWA GEOLOGICAL SURVEY, IOWA CITY, IOWA 52240
A FOLDER DESCRIBING TOPOGRAPHIC MAPS AND SYMBOLS IS AVAILABLE ON REQUEST