

To inverter users:

The inverter described in this operation manual is used for variable-speed operation of 3-phase induction motors for general industry use.



▼The inverter described in this manual is not designed and manufactured for use in equipment or a system used under the following conditions that will directly lead to death or injury : atomic energy control, aerospace equipment, traffic equipment, medical instrument and all kinds of safety devices. When our products are applied to the above equipment or system, be sure to consult us.

▼Our products are manufactured under stringent quality control. However, install a safety device on the equipment side in order to prevent serious accidents or loss when our products are applied to equipment that may cause serious accidents or loss due to failure or malfunction.

▼Do not use the inverter for any load other than 3-phase induction motors.

▼When an explosion-proof motor is selected, pay attention to the installation environment, because the inverter is not of an explosion-proof type.

▼Carefully read the "Operation Manual" before use for correct operation.
Read the manual carefully also for long-term storage.

▼Electrical work is necessary for installation of the inverter. Leave the electric work to specialists.

Worldwide Sumitomo Network

U.S.A.

Sumitomo Machinery Corporation of America (SMA)
4200 Holland Blvd. Chesapeake, VA 23323, U.S.A.
Tel: (1)757-485-3355
Fax: (1)757-485-7490

Austria

SCG Branch Austria Office
Gruentalerstraße 30A, 4020 Linz, Austria
Tel: (43)732-330958
Fax: (43)732-331978

China

Sumitomo(SHI) Cyclo Drive China, Ltd. (SCT)
13 Floor, No. 1698 Yishan Rd, Shanghai, China 201103
Tel: (86)21-3462-7877
Fax: (86)21-3462-7922

Vietnam

SCA Representative Office in Ho Chi Minh
7th Floor, 301 Tran Hung Dao St., Co Giang Ward,
District.1, HCMC
Tel: (84) 8-3920-4539
Fax: (84) 8-3920-4540

Argentina

SM-Cyclo de Argentina S.A. (SMAR)
Montes de Oca #6719, (B1606BMG)Munro,
Buenos Aires, Argentina
Tel: (54)11-4765-5332
Fax: (54)11-4765-5517

Benelux

SCG Branch Benelux Office
Office Heikneuterlaan 23, 3010 Kessel-Lo/Leuven,
Belgium
Tel: (32)16 60 83 11
Fax: (32)16 57 16 39

Hong Kong

SM-Cyclo of Hong Kong Co., Ltd. (SMHK)
Unit 1802, 18/F, Park Building, 476 Castle Peak Road,
Kowloon, Hong Kong
Tel: (852)2460-1881
Fax: (852)2460-1882

Malaysia

SM-Cyclo(Malaysia) Sdn. Bhd. (SMMA)
No. 2, Jalan BP 4/1, Bandar Bukit Puchong, 47100
Puchong, Selangor Darul Ehsan, Malaysia
Tel: (60)3-8061-2909
Fax: (60)3-8061-3909

Brazil

SM-Cyclo Redutores do Brasil, Com. Ltda. (SMBR)
Av. Fagundes Filho, 191 Metrô Sao Judas
Edifício - Sala H123 São Paulo-SP
Brasil 04304-010
Tel: (55)11-5585-3600
Fax: (55)11-5585-9990

France

SM-Cyclo France SAS (SMFR)
8 Avenue Christian Doppler Arlington
Techniparc, 77700 Serris, France
Tel: (33)149-929494
Fax: (33)149-929490

Korea

Sumitomo(SHI) Cyclo Drive Korea, Ltd. (SCK)
Royal Bldg. 9F Rm. 913, 5 Danju-Dong, Chongro-Gu,
Seoul, Korea 110-721
Tel: (82)2-730-0151
Fax: (82)2-730-0156

Thailand

SMTH Bangkok Office
195, Empire Tower 21st Fl., Unit 2103-4, South
Sathorn Road, Yannawa Sathorn Bangkok 10120,
Thailand
Tel: (66)2-670-0998
Fax: (66)2-670-0999

Chile

SM-Cyclo de Chile, Ltda. (SMCH)
San Pablo N3507, Comuna de Quinta Normal,
Santiago, Chile
Tel: (56)2-892-7000
Fax: (56)2-892-7001

Italy

SM-Cyclo Italy Srl (SMIT)
Via dell' Artigianato 23, 20010 Cornaredo(MI), Italy
Tel: (39)02-9356-2121
Fax: (39)02-9356-9893

Taiwan

Tatung SM-Cyclo Co., Ltd. (TSC)
22 Chungshan N. Road 3rd., Sec. Taipei, Taiwan 104,
R. O. C.
Tel: (886)2-2595-7275
Fax: (886)2-2595-5594

Australia

SM Cyclo(Australia) Pty., Ltd. (SMAU)
9 Holbeche Rd, Arndell Park, NSW, 2148, Australia
Tel: (61)2-8811-6555
Fax: (61)2-8811-6500

Mexico

SM-Cyclo de Mexico, S.A. de C.V. (SMME)
Calle "C" No. 506A Parque Industrial
Almacentro Apodaca, N. L., Mexico 66600
Tel: (52)81-8144-5130
Fax: (52)81-8369-3699

Spain

SM-Cyclo Iberia, S.L. (SMIB)
Edificio Gobelas, C/Landabarrí, n° 4 Escalera 1, 2º Izqda,
Leioa 48940 Vizcaya, Spain
Tel: (34)944-805389
Fax: (34)944-801550

Singapore

Sumitomo(SHI) Cyclo Drive Asia Pacific Pte. Ltd.(SCA)
15 Kwong Min Road, Singapore 628718
Tel: (65)6591-7800
Fax: (65)6863-4238

India

Sumi-Cyclo Drive India Private Limited
Survey No. 130, Hissa No. 02, Jeevan Nagar,
Off Mumbai-Bangalore bypass,
Tathawade, Pune-411 033, India
Tel: (91)20-6674-2900
Fax: (91)20-6674-2901

Canada

SM-Cyclo of Canada, Ltd. (SMC)
1045 South Service Road West, Oakville, Ontario,
Canada L6L 6K3
Tel: (1)905-469-1050
Fax: (1)905-469-1055

Sweden

SM-Cyclo Scandinavia AB (SMSC)
Ridbanegatan 4, S-21377 Malmö, Sweden
Tel: (46)40220030
Fax: (46)40220035

Philippines

SCA Branch Office in Philippines
B2b Granville Industrial Complex, Governor's Drive, Bo,
Bancal, Carmona 4116 Cavite, Philippines
Tel: (63)2-6800-6500
Tel: (63)2-6800-6501
Tel: (63)4-6430-3591
Fax: (63)2-6800-6555
Fax: (63)4-6430-3592

Japan

Sumitomo Heavy Industries, Ltd.
ThinkPark Tower, 1-1, Osaki 2-Chome,
Shinagawa-ku, Tokyo 141-6025, Japan
Tel: (81) 3-6737-2511
Fax: (81) 3-6866-5160

Germany

Sumitomo(SHI) Cyclo Drive Germany GmbH (SCG)
Cyclostraße 92, 85229 Markt Indersdorf, Germany
Tel: (49)8136-66-0
Fax: (49)8136-5771

UK

SM-Cyclo UK Ltd. (SMUK)
Unit 29, Bergen Way, Sutton Fields Industrial Estate,
Kingston upon Hull, HU7 0YQ, East Yorkshire,
United Kingdom
Tel: (44)1482-790340
Fax: (44)1482-790321

Sumitomo Drive Technologies
Always on the Move

HF-430 Series

5.5 ~ 55kW/200V Class

5.5 ~ 55kW/400V Class

General-purpose High-performance Inverter



Sumitomo Heavy Industries, Ltd.

POWER TRANSMISSION & CONTROLS GROUP

ThinkPark Tower, 1-1, Osaki 2-Chome, Shinagawa-ku, Tokyo 141-6025, Japan
Tel: (03)6737-2511 Fax: (03)6866-5160

Specifications, dimensions, and other items in the catalog are subject to change without prior notice.

DM1401E-2.10

MW25
Printed 2011.04

Operating and Maintenance Manual DM1401E-2

SAFETY

For the Best Results with HF-430 Series inverter, read this manual and all of the warning sign attached to the inverter carefully before installing and operating it, and follow the instructions exactly. Keep this manual handy for your quick reference.

Definitions and Symbols

A safety instruction (message) is given with a hazard alert symbol and a signal word;

WARNING or **CAUTION**. Each signal word has the following meaning throughout this manual.



This symbol means hazardous high voltage. It used to call your attention to items or operations that could be dangerous to your and other persons operating this equipment.
Read these message and follow these instructions carefully.



This is the "Safety Alert Symbol" This symbol is used to call your attention to items or operations that could be dangerous to your or other persons operating this equipment. Read these messages and follow these instructions carefully.



WARNING

WARNING

Indicates a potentially hazardous situation which, if not avoided, can result in serious injury or death.



COUTION

CAUTION

Indicates a potentially hazardous situation which, if not avoided, can result in minor to moderate injury, or serious damage of product.

The matters described under  **CAUTION** may, if not avoided, lead to serious results depending on the situation. Important matters are described in **CAUTION** (as well as **WARNING**), so be sure to observe them.

NOTE

NOTE

Notes indicate an area or subject of special merit, emphasizing either the product's capabilities or common errors in operation or maintenance.



HAZARDOUS HIGH VOLTAGE

Motor control equipment and electronic controllers are connected to hazardous line voltages. When servicing drives and electronic controllers, there might be exposed components with cases or protrusions at or above line potential. Extreme care should be taken to product against shock.

Stand on an insulating pad and make it a habit to use only one hand when checking components. Always work with another person in case an emergency occurs. Disconnect power before checking controllers or performing maintenance. Be sure equipment is properly grounded. Wear safety glasses whenever working on an electronic controller or rotating electrical equipment.

PRECAUTION

⚠ WARNING : This is equipment should be installed, adjusted and serviced by qualified electrical maintenance personal familiar with the construction and operation of the equipment and the hazards involved. Failure to observe this precaution could results in bodily injury.

⚠ WARNING : The user is responsible for ensuring that all driven machinery, drive train mechanism not supplied by Sumitomo Heavy Industries, Ltd., and process line material are capable of safe operation at an applied frequency of 150% of the maximum selected frequency range to the AC motor. Failure to do so can result in destruction of equipment and injury to personnel should a single point failure occur.

⚠ WARNING : For protection, install a leak breaker type with a high frequency circuit capable of large currents to avoid an unnecessary operation. The ground fault protection circuit is not designed to protect personal injury.

⚠ WARNING : HAZARD OF ELECTRICAL SHOCK. DISCONNECT INCOMING POWER BEFORE WORKING ON THIS CONTROL.

⚠ WARNING : SEPARATE MOTOR OVERCURRENT, OVERLOAD AND OVERHEATING PROTECTION IS REQUIRED TO BE PROVIDED IN ACCORDANCE WITH THE SAFETY CODES REQUIRED BY JURISDICTIONAL AUTHORITIES.

⚠ CAUTION : These instructions should be read and clearly understood before working on HF-430 series equipment.

⚠ CAUTION : Proper grounds, disconnecting devices and other safety devices and their location are the responsibility of the user and are not provided by Sumitomo Heavy Industries, Ltd.

⚠ CAUTION : Be sure to connect a motor thermal switch or overload devices to the HF-430 series controller to assure that inverter will shut down in the event of an overload or an overheated motor.

⚠ CAUTION : DANGEROUS VOLTAGE EXISTS UNTIL CHARGE LIGHT IS OFF.

⚠ CAUTION : Rotating shafts and above ground electrical potentials can be hazardous. Therefore, it is strongly recommended that all electrical work conform to the National Electrical Codes and local regulations. Only qualified personnel should perform installation, alignment and maintenance. Factory recommended test procedures, included in the instruction manual, should be followed. Always disconnect electrical power before working on the unit.

NOTE : POLLUTION DEGREE 2

The inverter must be used environment of the degree 2.

Typical constructions that reduce the possibility of conductive pollution are;

- 1) The use of an unventilated enclosure
- 2) The use of a filtered ventilated enclosure when the ventilation is fan forced that is, ventilation is accomplished by one or more blowers within the enclosure that provide a positive intake and exhaust.

Precautions for EMC (Electromagnetic Compatibility)

You are required to safety the EMC directive (89/336/EEC) when using a HF-430 inverter in a European country. To safety the EMC directive and to comply with standard, follows the checklist below.

⚠ WARNING : This equipment should be installed, adjusted, and serviced by qualified personal familiar with construction and operation of the equipment and the hazards involved. Failure to observe this precaution could result in bodily injury.

1.The power supply to HF-430 inverter must meet these specifications:

- a. Voltage fluctuation +/-10% or less.
- b. Voltage imbalance +/-3% or less.
- c. Frequency variation +/-4% or less.
- d. Voltage distortion THD = 10% or less.

2.Installation measure:

- a. Use a filter designed for HF-430 inverter.

3.Wiring

- a. Shielded wire (screened cable) is required for motor wiring, and the length must be less than 20 meters.
- b. The carrier frequency setting must be less than 5 kHz to satisfy EMC requirements.
- c. Separate the main circuit from the signal/process circuit wiring.

4.Environmental conditions – when using a filter, follow these guidelines:

- a. Ambient temperature: -10 - +50 degrees.
- b. Humidity: 20 to 90% RH (non-condensing)
- c. Vibration: 5.9 m/sec² (0.6 G) 10 – 55Hz. (HF4302-5A5~022)
(HF4304-5A5~022)
2.94 m/sec² (0.3 G) 10 – 55Hz. (HF4302-030~055)
(HF4304-030~055)
- d. Location: 1000meters or less altitude, indoors (no corrosive gas or dust)

Revision History Table

No.	Revision Contents	The Date of Issue	Operation Manual No.
1	.		
2			

1. Installation and Wiring

WARNING

Do not remove the rubber bush. Due to the possibility that a wire may be damaged shorted or may have a ground fault with the edge of the wiring cover.	p.2-1
Be sure to ground the unit. Otherwise, there is a danger of electric shock and/or fire. Otherwise, there is a danger of electric shock and/or injury.	p.2-5
Only qualified personnel shall carry out wiring work. Otherwise, there is a danger of electric shock and/or fire.	p.2-5
Implement wiring after checking that the power supply is off. Otherwise, there is a danger of electric shock and/or injury.	p.2-5
Be sure to implement wiring after installing the body. Otherwise, there is a danger of electric shock and/or injury.	p.2-5
"Use 60/75 deg. Cu wire only" or equivalent.	p.2-5
"A Class 2 circuit wired with Class 1 wire" or equivalent.	p.2-5
"Suitable for use on a circuit capable of delivering not more than 5,000 rms symmetrical amperes, 240V maximum". For HF4302-*** models.	p.2-5
"Suitable for use on a circuit capable of delivering not more than 5,000 rms symmetrical amperes, 480V maximum". For HF4304-*** models..	p.2-5
Use suitable circuit breaker listed in this manual for UL's listing purpose. Otherwise, there is a danger of fire.	p.2-12
Install using non-combustible materials (metal etc.) It is a fire risk.	p.2-1

 **CAUTION**

<p>Do not install combustible materials nearby. It is a fire risk.</p>	<p>... .. p.2-1</p>
<p>Do not carry unit by top cover, always carry by supporting base of unit. There is a risk of falling and injury.</p>	<p>... .. p.2-1</p>
<p>Do not allow substance of cutting waste, sputtering of welding, waste of iron, wire and dust etc. to come into contact with the unit. It is a fire risk.</p>	<p>... .. p.2-1</p>
<p>Make sure the surface the unit is installed onto can support the weight of the unit comfortably. There is a risk of falling and injury.</p>	<p>... .. p.2-1</p>
<p>Do not install or operate the unit if the unit appears damaged. There is a risk of injury.</p>	<p>... .. p.2-1</p>
<p>Avoid locations of high temperatures, high humidity, dew condensation, dust, corrosive gases, explosive gases, combustible gases, coolant mist and sea damage etc. Install indoors, to avoid direct sunlight and the unit should be well ventilated.</p>	<p>... .. p.2-1</p>
<p>Be sure that the rated voltage matches the AC power supply voltage of the unit. Otherwise, there is the danger of injury and/or fire.</p>	<p>... .. p.2-5</p>
<p>Be sure not to connect an AC power supply to the output terminals. Otherwise, there is the danger of injury and/or fire.</p>	<p>... .. p.2-5</p>
<p>Be sure not to connect an AC power supply to the output terminals. Otherwise, there is the danger of injury and/or fire.</p>	<p>... .. p.2-5</p>
<p>Be sure not to connect the resistor to the direct current terminals (P1, P, and N). Otherwise, there is the danger of fire.</p>	<p>... .. p.2-5</p>

 **CAUTION**

Be sure to install the earth leakage circuit breaker on the inputting side. p.2-5
Otherwise, there is in the danger of fire.

Be sure to use power cables, earth leakage breakers and electromagnetic contactors that are rated correctly. p.2-5
Otherwise, there is the danger of fire.

Do not use the electromagnetic contactors to stop the Motor running always use the Inverters internal controls. p.2-5
Otherwise, there is the danger of injury and/or fire.

2. Operation

 **CAUTION**

Make sure that the direction of the motor is correct. It is in danger of injury or machine damage. p.3-4

Make sure there is no abnormal noise and vibration. It is in danger of injury or machine damage p.3-4

TABLE OF CONTENTS

Chapter 1	Inspection upon Unpacking	
1.1	General Description.....	1-1
1.1.1	Inspection of the unit.....	1-1
1.1.2	Operation manual.....	1-1
1.2	Question and Warranty of the Unit.....	1-2
1.2.1	Request upon asking.....	1-2
1.2.2	Warranty for the unit.....	1-2
1.3	Appearance.....	1-2
1.3.1	Appearance and Names of Parts.....	1-2
Chapter 2	Installation and Wiring	
2.1	Installation.....	2-1
2.1.1	Installation.....	2-2
2.1.2	Blind cover of wiring parts.....	2-4
2.2	Wiring.....	2-5
2.2.1	Terminal Connection Diagram.....	2-6
2.2.2	Main circuit wiring.....	2-8
2.2.3	Terminal Connection Diagram.....	2-14
Chapter 3	Operation	
3.1	Operation.....	3-1
3.2	Test Run.....	3-2
Chapter 4	Explanation of Function	
4.1	About Digital Operator.....	4-1
4.2	Code list.....	4-5
4.3	Explanation of function.....	4-13
4.3.1	Monitor mode.....	4-13
4.3.2	Function mode.....	4-17
4.4	Protection function list.....	4-87
4.4.1	Protection function.....	4-87
4.4.2	Trip monitor display.....	4-89
4.4.3	Warning Monitor display.....	4-90

Chapter 5 Maintenance, Inspection

5.1 Precaution for Maintenance/Inspection..... 5-1

 5.1.1 Daily inspection..... 5-1

 5.1.2 Cleaning..... 5-1

 5.1.3 Regular inspection..... 5-1

5.2 Daily inpection and regular inspection..... 5-2

5.3 Megger test..... 5-3

5.4 Withstand Voltage test..... 5-3

5.5 The method to check Inverter, converter part..... 5-4

5.6 Capacitor Life Curve..... 5-5

Chapter 6 Specification

6.1 Standard specification list..... 6-1

6.2 Dimension..... 6-2

Chapter 7 Index..... 7-1

1.1 Inspection upon Unpacking

1.1.1 Inspection of the unit

Open the package and pick out the inverter, please check the following item.

If you discover any unknown parts or the unit is in bad condition, please contact your supplier or the local Sumitomo Distributor.

- (1) Make sure that there was no damage (injury, falling or dents in the body) during transportation of the unit.
- (2) After unpacking the unit, make sure that the package contains one operation manual for the Inverter.
- (3) Make sure that the product is the one you ordered by checking the specification label.

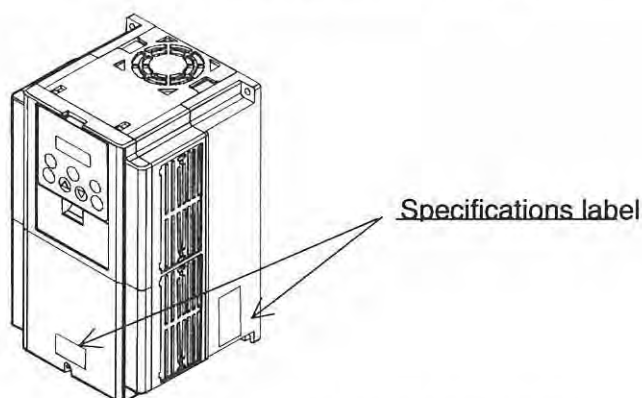

Picture 1-1 Position of specification label

Inverter model	→	Model : HF4304-5A5
Maximum applicable motor	→	kW/HP: 5.5/7.5
Input ratings	→	Input / Entree: 50 Hz,60Hz V 1 Ph A 50 Hz,60Hz 380 ~ 480 V 3 Ph 13 A
Output ratings	→	Output / Sortie: 0.1 - 400Hz V 3 Ph 12 A
Production number	→	MFG No. MASS:

Picture 1-2 Contents of specifications label

1.1.2 Operation manual

This operation manual is the manual for the Sumitomo Inverter HF-430 Series.

Before operation of the Inverter, read the manual carefully. After Reading this manual, keep it to hand for future reference.

When using optional units for this inverter; please refer to the operation manuals packed with the optional units.

This operation manual was correct at the time of going to press.

1.2 Question of the Unit

1.2.1 Request upon asking

If you have any questions regarding damage to the unit, unknown parts or for general enquiries please contact your supplier or the local Sumitomo Distributor with the following information.

- (1) Inverter Model
- (2) Production Number (MFG, NO)
- (3) Date of Purchase
- (4) Reason for Calling
 - Damaged part and its condition etc.
 - Unknown parts and their contents etc.

1.3 Appearance

1.3.1 Appearance and Names of Parts

Appearance from the front

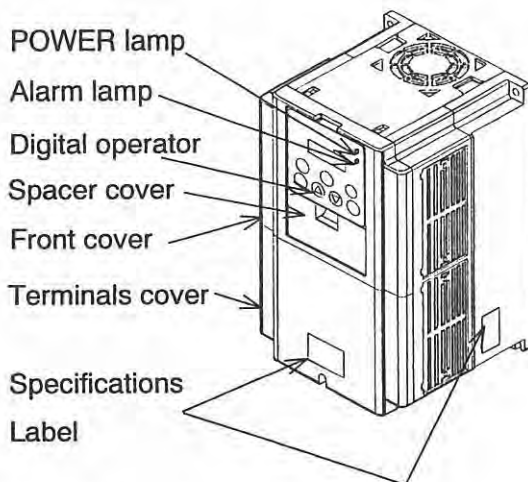

Front cover removed

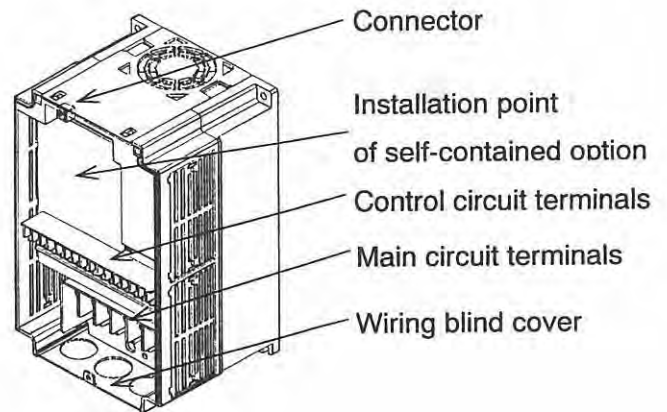

2.1 Installation

WARNING

Do not remove the rubber bush. Due to the possibility that a wire may be damaged, shorted or may have a ground fault with the edge of the wiring cover.

CAUTION

Install using non-combustible materials (metal etc.)

It is a fire risk.

Do not install combustible materials nearby.

It is a fire risk.

Do not carry unit by top cover, always carry by supporting base of unit.

There is a risk of falling and injury.

Do not allow substance of cutting waste, sputtering of welding, waste of iron, wire and dust etc. to come into contact with the unit.

It is a fire risk.

Make sure the surface the unit is installed onto can support the weight of the unit comfortably.

There is a risk of falling and injury.

Do not install or operate the unit if the unit appears damaged.

There is a risk of injury.

Avoid locations of high temperatures, high humidity, dew condensation, dust, corrosive gases, explosive gases, combustible gases, coolant mist and sea damage etc. Install indoors, to avoid direct sunlight and the unit should be well ventilated.

2.1.1 Installation

1. Transportation

This inverter has plastic parts. So handle with care.

Do not over tighten the wall mounting fixings as the mountings may crack, causing is a risk of falling.

Do not install or operate the inverter if there appears to be damage or parts missing.

2. Surface for Mounting of Inverter

The temperature of the Inverter heatsink can become very high (the highest being about 150°C). The surface, which you are mounting the Inverter onto, must be made of a non-flammable material (i.e steel) due to the possible risk of fire. Attention should also be made to the air gap surrounding the Inverter. Especially when there is a heat source such as a braking resistor or a reactor.

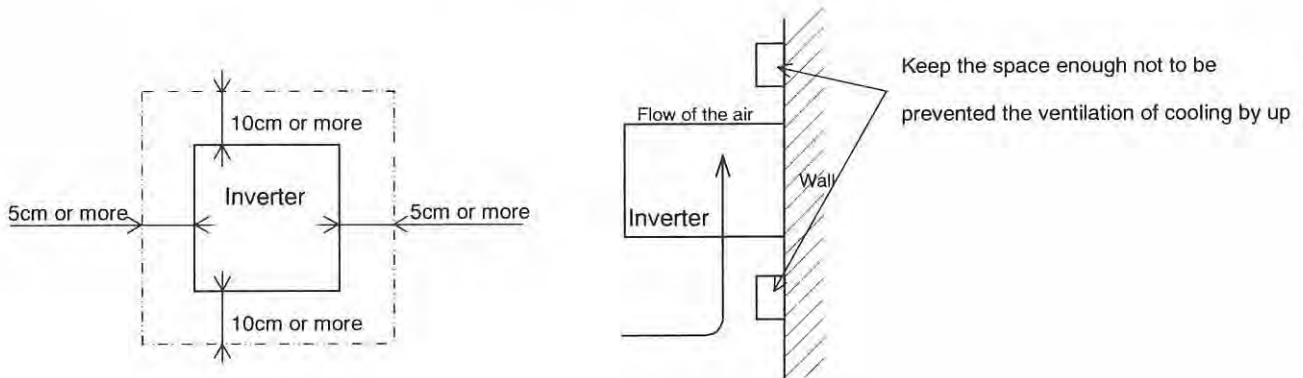

3. Operating Environment - Ambient Temperature

The ambient temperature surrounding the Inverter should not exceed the allowable temperature range (usually -10 to 50°C).

The temperature should be measured in the air gap surrounding the Inverter, shown in the diagram above. If the temperature exceeds the allowable temperature, the component life will become shortened especially in the case of the Capacitors.

4. Operating Environment - Humidity

The humidity surrounding the Inverter should be within the limit of the allowable percentage range (usually 20% to 90%). Under no circumstances should the Inverter be in an environment where there is the possibility of moisture entering the Inverter.

Also avoid having the Inverter mounted in a place that is exposed to the direct sunlight.

5. Operating Environment - Air

Install the Inverter avoiding any place that has dust, corrosive gas, explosive gas, combustible gas, mist of coolant and sea damage.

6. Mounting Position

Mount the Inverter in a vertical position using screws or bolts. The surface you mount onto should also be free from vibration and can easily hold the weight of the Inverter.

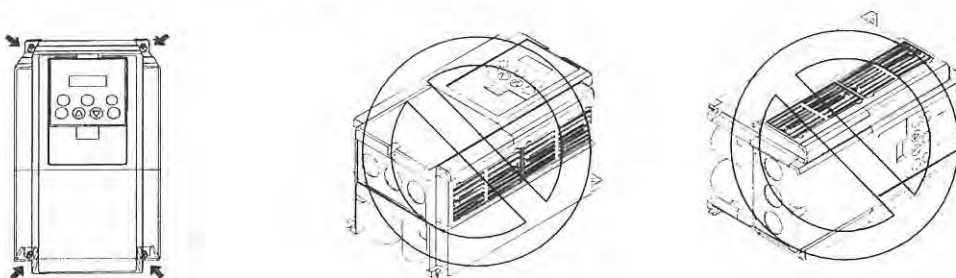

7. Ventilation within an Enclosure

If you are installing one or more Inverters in an enclosure a ventilation fan should be installed. Below is a guide to the positioning of the fan to take the airflow into consideration. The positioning of Inverter, cooling fans and air intake is very important. If these positions are wrong, airflow around the Inverter decreases and the temperature surrounding the Inverter will rise. So please make sure that the temperature around is within the limit of the allowable range.

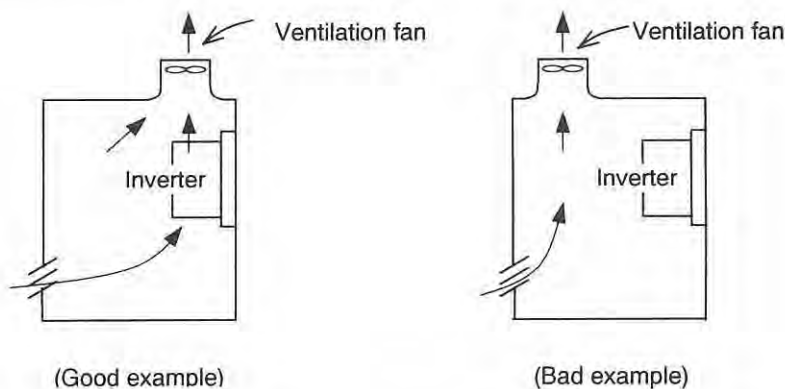

8. External cooling of Inverter

It is possible to install the inverter so that the heatsink is out of the back of the enclosure. This method has two advantages, cooling of the inverter is greatly increased and the size of the enclosure will be smaller.

To install it with the heatsink out of the enclosure, a metal fitting option is required to ensure heat transfer.

Do not install in a place where water, oil mist, flour and dust etc can come in contact with the inverter as there are cooling fans fitted to the heatsink.

9. Approximate loss for each capacity

Inverter capacity (kW)	5.5	7.5	11	15	22	30	37	45	55
70% of rated output (W)	242	312	435	575	820	1100	1345	1625	1975
100% of rated output (W)	325	425	600	800	1150	1550	1900	2300	2800
100% of rated efficiency(%)	94.4	94.6	94.8	94.9	95.0	95.1	95.1	95.1	95.1

2.1.2 Blind cover of wiring parts

(1) Cable entry through Rubber Bushes

The wiring should be done after making a cut in the rubber bushes with nippers or cutters.

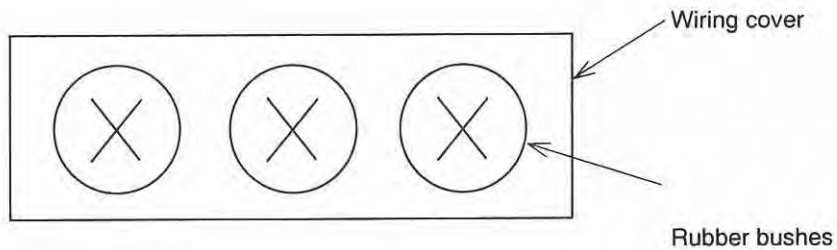

(2) Cable entry through Conduit

After taking out the rubber bushes, connect the conduit.

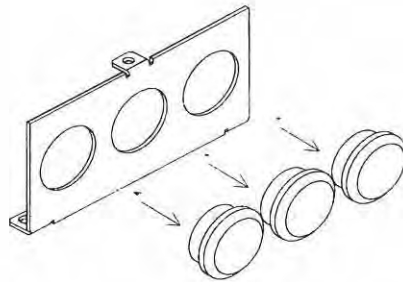

Note; Except for when connecting conduit, Do not take out the rubber bushes. It is possible that the wiring insulation is broken and a possible earth fault is caused.

2.2 Wiring

WARNING

Be sure to ground the unit.

Otherwise, there is a danger of electric shock and/or injury.

Only qualified personnel shall carry out wiring work.

Otherwise, there is a danger of electric shock and/or fire.

Implement wiring **after** checking that the power supply is off.

Otherwise, there is a danger of electric shock and/or injury.

Be sure to implement wiring **after** installing the body.

Otherwise, there is a danger of electric shock and/or injury.

"Use 60/75 deg. Cu wire only" or equivalent.

"A Class 2 circuit wired with Class 1 wire" or equivalent.

"Suitable for use on a circuit capable of delivering not more than 5,000 rms symmetrical amperes, 240V maximum". For HF4302-*** models.

"Suitable for use on a circuit capable of delivering not more than 5,000 rms symmetrical amperes, 480V maximum". For HF4304-*** models.

CAUTION

Be sure that the rated voltage matches the AC power supply voltage of the unit.

Otherwise, there is the danger of injury and/or fire.

Be sure not to connect an AC power supply to the output terminals.

Otherwise, there is the danger of injury and/or fire.

Be sure not to connect the resistor to the direct current terminals (P1, P, and N).

Otherwise, there is the danger of fire.

Be sure to install the earth leakage circuit breaker on the inputting side.

Otherwise, there is in the danger of fire.

Be sure to use power cables, earth leakage breakers and electromagnetic contactors that are rated correctly.

Otherwise, there is the danger of fire.

Do not use the electromagnetic contactors to stop the Motor running always use the Inverters internal controls.

Otherwise, there is the danger of injury and/or fire.

2.2.1 Terminal Connection Diagram (sink type)

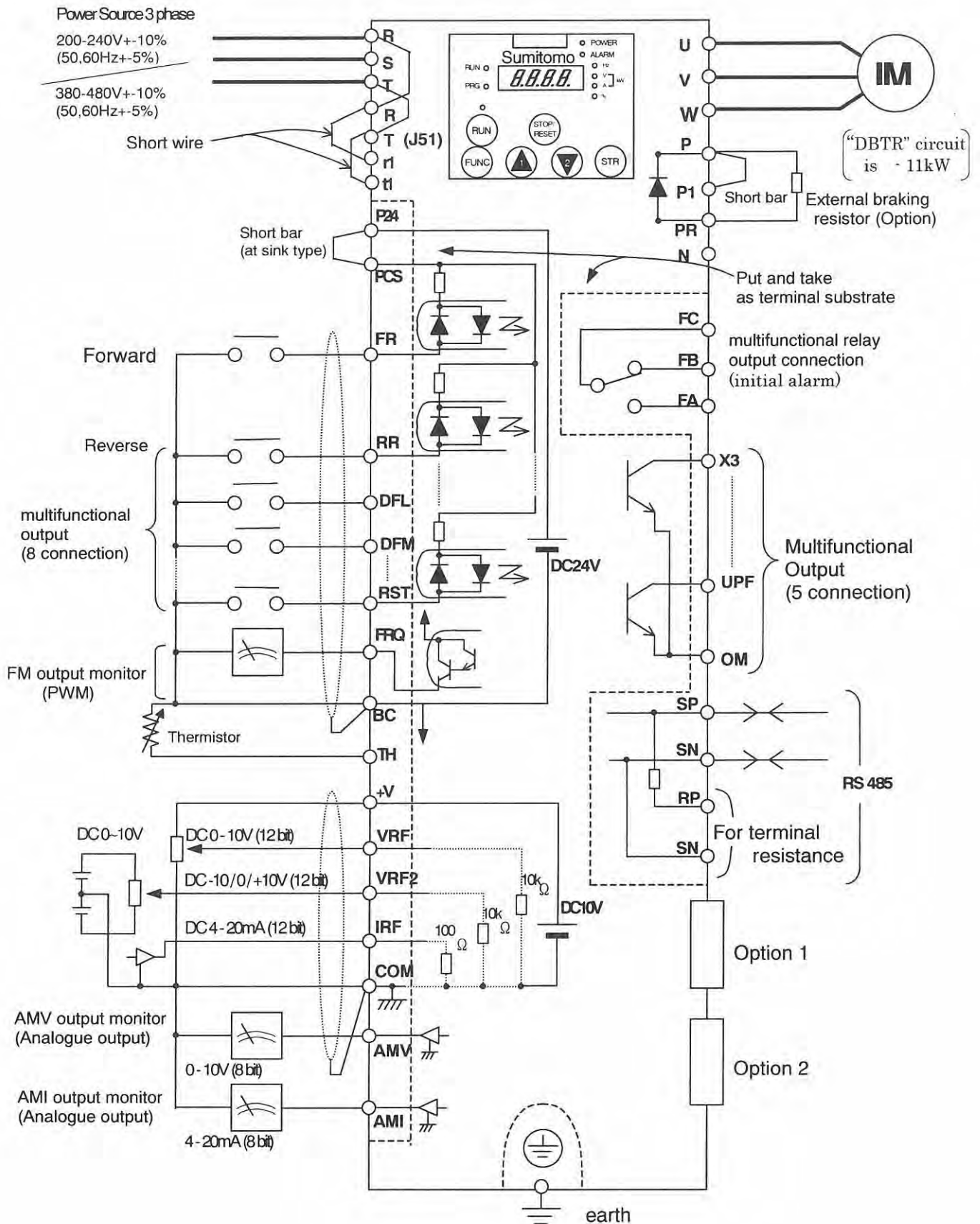

2.2.1 Terminal Connection Diagram (source type)

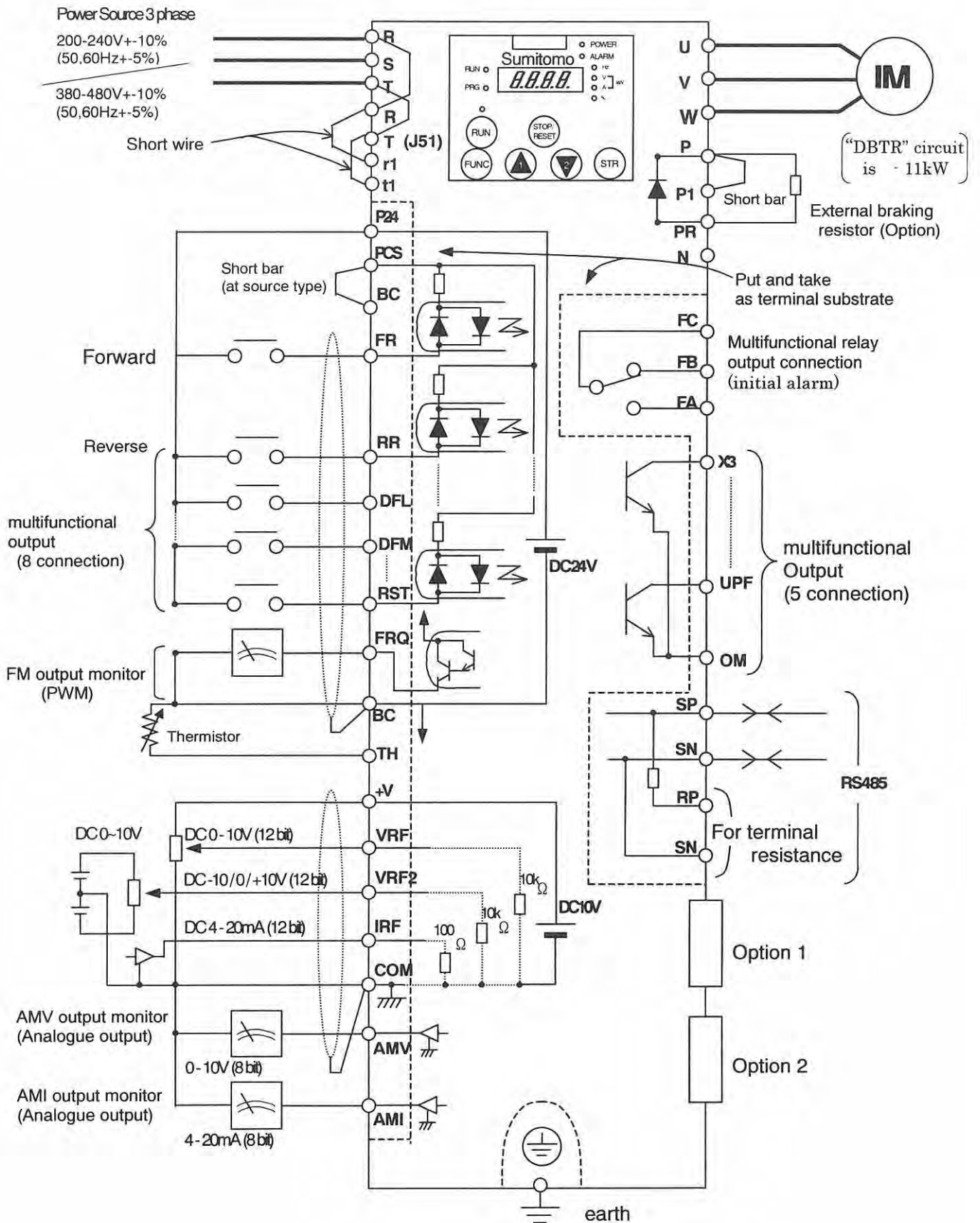

(1) Explanation of main circuit terminals

Symbol	Terminal Name	Explanation of contents
R, S, T (L1,L2,L3)	Main power	Connect alternating power supply. When using regenerative converter, don't connect.
U, V, W (T1,T2,T3)	Inverter output	Connect three-phase motor.
P1, P (+)	D.C.reactior	Remove the short bar between P1 and P, connect optional Power factor reactor.
P, PR (+,PR)	External braking resistor	Connect optional External braking resistor. (Installed on 5.5 , 7.5 and 11kW.)
P, N (+,-)	External braking unit	Connect optional Braking unit.
E(G) ⊕	Inverter earth terminals	It is earth terminals of inverter case.

(2) Explanation of control circuit terminal

	Symbol	Terminal Name	Explanation of contents		
Analogue	Power Source	COM	Analogue power common It is common terminal of frequency command signal (VRF, VRF2, IRF) and analogue output, AMV, AMI. Don't earth.		
		+V	Frequency power It is the DC+10V power for terminals. Allowable load current 20mA		
	Frequency setting	VRF	Frequency command power terminal (voltage) When inputting DC 0 - 10V, it is maximum frequency on 10V. When maximum frequency is expected to be on being less than 10V, set with A014.	Input Impedance 10k ohm Allowable maximum voltage 12V	
		VRF2	Frequency command support (voltage) When inputting DC 0 - ± 10V, this signal is added to frequency command of VRF or IRF terminal.	Input Impedance 10k ohm Allowable maximum load current 20mA	
		IRF	Frequency command Terminal (current) When inputting DC 4 - 20mA, 20mA is maximum frequency. When only AUT(input multifunctional) terminal is ON, this input signal is effective.	Input Impedance 100 ohm Allowable maximum current 24mA	
	Monitor	AMV	Analogue monitor (voltage) Output one selected from monitor item, output frequency, output current, torque, output voltage, input electric power, electric thermal rate, LAD frequency	Allowable maximum current 2mA	
		AMI	Analogue monitor (current)	Allowable output less than Impedance 250 ohm	
		FRQ	Digital monitor (voltage) Output the output frequency with digital besides above monitor.	Allowable maximum current 1.2mA Maximum frequency 3.6khz	
	Power Source	P24	Interface power It is DC24V power for connection input signal. When selecting source logic, it's for connection input common.	Allowable maximum output current 100mA	
		BC	Interface power common The common terminal is FR terminal, RST - RR(multifunctional input) terminal, TH terminal and FRQ		
PCS		Multifunctional input common Change sink type and source type by short bar on control terminals. P24-PCS : Sink type BC-PCS :Source type			
Digital (connection)	Input signal	FR	Forward command About FR signal, ON is Forward and OFF is stop command.	Allowable maximum voltage 27V Input impedance 4.7k ohm	
		RST ES JOG MBS AD2 DFM DFL RR	Multifunctional Input Select 8 functions from 44 functions, and divide between RST terminal and RR terminals.		
	Output signal	Condition/Alarm	UPF DRV X1 X2 X3	Multifunctional Output Select 5 functions from 22 functions, and divide between UPF terminal and X3 terminals	Allowable maximum voltage 27V current 5mA
			FA FB	Alarm output terminal Assign output function. Output is c contact.	Allowable maximum AC250V,0.2A
			FC	Common terminal It is common terminal of alarm output terminal	Allowable minimum AC100V,10mA
	Analogue	Sensor	TH	Thermistor input terminal When a Thermistor is connected to terminals TH and BC,the Inverter checks for over-temperature and will cause trip event and turn off output to motor.	Allowable minimum Thermistor Power 100mW

2.2.2 Main circuit wiring

(1) Warning on wiring

When carrying out work on the Inverter wiring make sure to wait for at least ten minutes before you remove the cover.

Making sure to check that the charge lamp is not illuminated.

A final check should always be made with a voltage meter.

After removing the power supply, there is a time delay before the capacitors will dissipate their charge.

1. Main power terminals(R, S, T)

Connect the main power terminals (R, S, and T) to the power supply through an electromagnetic contactor or an earth-leakage breaker.

We recommend connecting the electromagnetic contactor to the main power terminals. Because when the protective function of inverter operates, it isolates the power supply and prevent the spread of damages and accidents.

This unit is for the three-phase power supply. It isn't for the single-phase power supply.

The initial data of Open - phase selection(b006) is invalid. Therefor, when Open-phase occur, inverter is the following state.

R(L1)-Phase or T(L3)-Phase is open -> Not operate.

S(L2)-Phase is open -> Inverter operates by Single-Phase power supply. Therefor, UV or OC may occur.

2. Inverter output terminals (U, V, W)

Wire with thicker wire than the applicable wire to control the voltage drop.

Particularly when outputting low frequencies, the torque of the motor will reduce by the voltage drop of the wire.

Do not install power factor correction capacitors or a surge absorber to the output.

The inverter will trip or sustain damage to the capacitors or the surge absorber.

In the case of the cable length being more than 20 metres, it is possible that a surge voltage will be generated and damage to the motor is caused by the floating capacity or the inductance in the wire (400V especially).

An EMC Mains Filter is available, please contact us.

In the case of two or more motors, install a thermal relay to each motor.

When the cable length between the inverter and motor is long (10m or more), a countermeasure for a malfunction of the thermal relay by harmonic due to switching on inverter is taken by inserting reactor. Please contact us.

3. Direct current reactor (DCL) connection terminals (P1, P)

These are the terminals to connect the current reactor DCL (Option) to help improve the power factor.

The short bar is connected to the terminals when shipped from the factory, if you are to connect a DCL you will need to disconnect the short bar first.

When you don't use a DCL, don't disconnect the short bar.

4. External braking resistor connection terminals (P, PR)

The regenerative braking circuit (DBTR) is built-in as standard up to the 15kw Inverter.

When braking is required, install an external-braking resistor to these terminals.

The cable length should be less than 5 meters, and twist the two connecting wires to reduce inductance.

Don't connect any other device other than the external braking resistor to these terminals.

When installing an external braking resistor make sure that the resistance is correctly rated to limit the current drawn through the DBTR.

5. Regenerative braking unit connection terminals

The Inverters rated more than 11kw don't contain a DBTR circuit. If regenerative braking is required an external DBTR circuit (Option) is required along with the resistor (Option).

Connect external regenerative braking unit terminals (P, N) to terminals (P,N) on the inverter. The braking resistor is then wired into the External Braking unit and not directly to the Inverter.

The cable length should be less than 5 meters, and twist the two connecting wires to reduce inductance.

6. Earth (E(G)⊕)

Make sure that you securely ground the Inverter and motor for prevention of electric shock.

The inverter and motor must be connected to an appropriate safety earth and follow the local standard.

Failure to do so constitutes an electrical shock hazard.

(2) Wiring of main circuit terminals

The wiring of main circuit terminals for inverter is the following picture.

Wiring of terminals	Corresponding type
	<p>HF4302-5A5 HF4304-5A5</p> <p>r1-t1 : M4 Other : M5</p>
	<p>HF4302-7A5 HF4304-7A5</p> <p>r1-t1 : M4 Other : M5</p> <p>HF4302-011 HF4304-011</p> <p>r1-t1 : M4 Other : M6</p>
	<p>HF4302-015 HF4304-015 HF4304-022 HF4304-030 HF4304-037 r1-t1 : M4 Other : M6</p> <p>HF4302-030 HF4302-037 HF4304-045 HF4304-055</p> <p>r1-t1 : M4 Other : M8</p>
	<p>HF4302-022</p> <p>r1-t1 : M4 Earth terminal : M6 Other : M8</p> <p>HF4302-045 HF4302-055</p> <p>r1-t1 : M4 Earth terminal : M8 Other : M10</p>

(2) The Applicable Tools

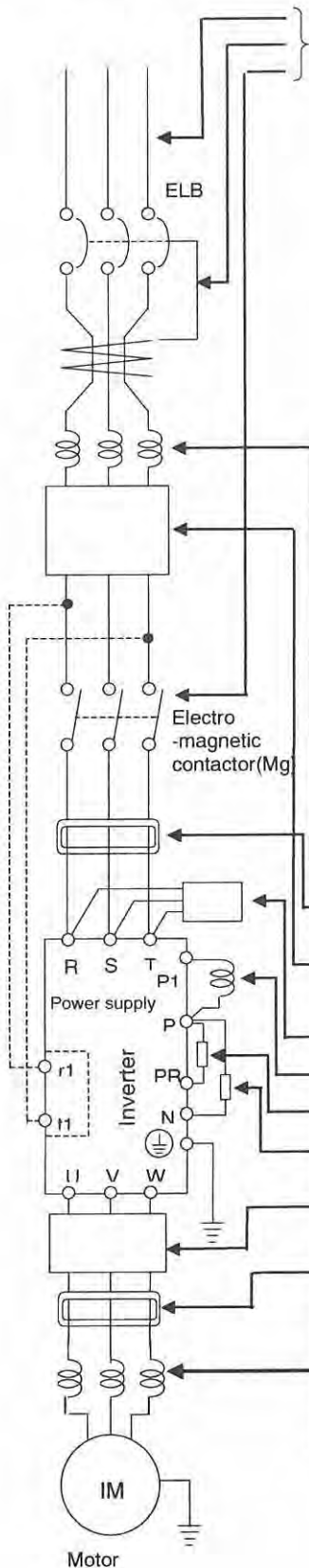

See [(4) Common Applicable Tools] in this chapter

Note1: The applicable tools indicate for Sumitomo standard four-pole squirrel-cage Motor.

Note2: Select applicable tools for breakers examining the capacity of breakers. (Use Inverter type.)

Note3: It needs bigger wires for power lines, if the distance exceeds 20m.

Note4: Use earth-leakage breakers (ELB) for safety.

*Use 0.75mm² for Alarm output contact.

Separate by the sum wiring distance from Inverter to power supply, from inverter to motor for the sensitive current of leak breaker (ELB).

Wiring distance	Sensitive Current(mA)
100m and less	50
300m and less	100

Note5: When using CV line and wiring by rigid metal conduit, leak flows.

Note6: IV line is high dielectric constant. So the current increase 8 times. Therefore, use the sensitive current 8 times as large as that of the left list. And if the distance of wire is over 100m, use CV line.

Name	Function
Input reactor(harmonic control, electrical coordination, power-factor improvement)	This part is used when the unbalance voltage rate is 3% or more and power supply is 500 kVA or more, and there is a rapid change in the power supply/. It also improves the power factor.
Radio noise filter (zero-phase reactor)	Using the inverter may cause noise on the peripheral radio through the power lines. This part reduces noise.
Noise filter for Inverter	This part reduces common noise generated between the power supply and the ground, as well as normal noise. Put it in the primary side of inverter.
Input radio noise filter (capacitor filter)	This part reduces radiation noise emitted from wire at the input.
Direct reactor	This part control harmonic from inverter.
Braking resistor	This part is used for applications that need to increase the brake torque of the inverter or to frequently turn on and off and to run high inertia load.
Regenerative braking unit	
Output noise filter	This part reduces radiation noise emitted from wire by setting between inverter and motor. And it reduces wave fault to radio and TV , it is used for preventing malfunction of sensor and measuring instruments.
Radio noise filter(zero-phase reactor)	This part reduces noise generated at the output of the inverter. (It is possible to use for both input and output.)
Outoput alternation reactor Reducing vibration and the surge voltage thermal Relay, preventing Misoperation.	Running motors with the inverter generates vibration greater than that with commercial power supply. This part installed between the inverter and motor reduces torque ripple. When the cable length between the inverter and motor is long (10m or more), a countermeasure for a malfunction of the thermal relay by harmonic and the surge voltage due to switching on inverter is taken by inserting reactor. Please contact us.

(4) Common applicable tools

	Motor Output (kW)	Applicable Inverter model	Power lines R,S,T,U,V, W,P,P1,		External resistor Between P and PR		Screw size of terminal	Torque (Nm)	Applicable tools			
			mm ² or more	AWG or more	mm ²	AWG			Circuit breaker and earth leak breaker(ELB) made by Mitsubishi Elec.		Electro-magnetic contactor (Mg)(with reactor) made by Fuji Elec.	
									Without reactor	With reactor		
200V class	5.5	HF4302-5A5	5.5	8	5.5	8	M5	2.5	NF50,NV50 50A	NF50,NV50 40A	SC-1N(//)	
	7.5	HF4302-7A5	8	6	5.5	8	M5	2.5	NF100,NV100 60A	NF50,NV50 50A	SC-2N(//)	
	11	HF4302-011	14	4	5.5	8	M6	4.9	NF100,NV100 75A	NF100,NV100 60A	SC-2SN(//)	
	15	HF4302-015	22	2	-	-	M6	4.9	NF100,NV100 100A	NF100,NV100 75A	SC-3N(//)	
	22	HF4302-022	38	1/0	-	-	M8	8.8	NF225,NV225 175A	NF225,NV225 125A	SC-5N(//)	
	30	HF4302-030	60	2/0	-	-	M8	8.8	NF225,NV225 200A	NF225,NV225 150A	SC-7N(6N)	
	37	HF4302-037	100 (38x2)	(#1)	-	-	M8	8.8	NF400,NV400 250A	NF225,NV225 175A	SC-8N(7N)	
	45	HF4302-045	100 (38x2)	(#2)	-	-	M10	-	NF400,NV400 300A	NF225,NV225 225A	SC-10N(8N)	
	55	Hf4302-045	150 (60x2)	(#3)			M10		NF400,NV400 350A	NF400,Nv400 250A	SC-11N(10N)	
400V class	5.5	HF4304-5A5	2	12	2	12	M5	1.5	NF30,NV30 30A	NF30,NV30 20A	SC-5-1(//)	
	7.5	HF4304-7A5	3.5	10	3.5	10	M5	1.5	NF30,NV30 30A	NF30,NV30 30A	SC-5-1(//)	
	11	HF4304-011	5.5	8	5.5	8	M6	1.5	NF50,NV50 50A	NF50,NV50 40A	SC-1N(//)	
	15	HF4304-015	8	6	-	-	M6	4.9	NF100,NV100 60A	NF50,NV50 50A	SC-2N(//)	
	22	HF4304-022	14	4	-	-	M6	4.9	NF100,NV100 100A	NF100,NV100 60A	SC-2SN(//)	
	30	HF4304-030	22	3	-	-	M6	4.9	NF225,NV225 125A	NF100,NV100 100A	SC-3N(//)	
	37	HF4304-037	38	1	-	-	M6	4.9	NF225,NV225 150A	NF100,NV100 100A	SC-4N(//)	
	45	HF4304-045	38	1	-	-	M8	8.8	NF225,NV225 175A	NF225,NV225 125A	SC-5N(//)	
	55	HF4304-055	60	1/0	-	-	M8	8.8	NF225,NV225 200A	NF225,NV225 150A	SC-7N(6N)	

#1 3/0 or 2 parallel of 1AWG

#2 250kcmil or 2 parallel of 1 AWG(75 deg.)

#3 350kcmil or 2 parallel of 1/0 AWG

Note : Field wiring must be made by a UL-listed and CSA-certified closed-loop terminal connector sized for the wire gauge involved. Connector must be fixed by using the crimping tool specified by the connector manufacture

WARNING

Use suitable circuit breaker listed in this manual for UL's listing purpose.
Otherwise, there is a danger of fire.

5) Connecting power to the control circuit, separating from main power

When the protection circuit of inverter is activated and the electromagnetic contactor on the input supply to the inverter isolates the power supply, the control circuit power supply from the inverter will also switch off and the alarm output signal will not be held.

The power terminals r1 and t1 are designed to allow a supply to go direct to the control circuit and therefore keep the alarm output signal on.

In this case, please connect power terminals r1 and t1, to the primary side of the electromagnetic contactor.

(inverter unit side of ACL, EMI filter, on using input ACL, EMI filter).

(Connection)

[3] Connect power supply for control circuit to power terminals.

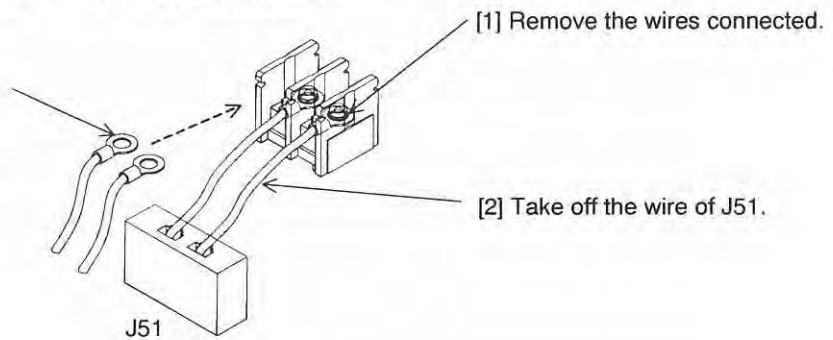

2.2.3 Terminal Connection Diagram

(1) Wiring

1. Both the BC and COM terminal is insulated to both the common terminal of the input and output signals.
Do not short or earth these common terminals.
2. Use twisted screened cable, for the input and output wires of the control circuit terminals.
Connect the screen to the common terminal.
3. Limit connection wires to 20m. When it is necessary to wire over 20m, use an Insulated signal transducer.
4. Separate the control circuit wiring from the main power and relay control wiring.
5. If control and power wires must cross make sure they cross at 90 degrees to each other.
6. When connecting a thermistor to the TH and BC terminal, twist the thermistor cables separate from the rest.

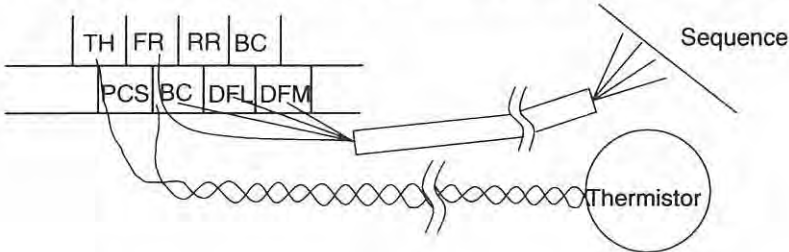

7. When using relays for the FR terminal or an multifunctional input terminal use a control relay as they are designed to work with 24Vdc.
8. When the relay is used as an multifunctional output, connect a diode for surge protection parallel to the coil.
9. Do not short the analogue voltage terminals +V and COM or the internal power terminals P24 and BC.
There is risk of Inverter damage.

(2) Layout of control circuit terminals

+V	VRF2	AMV	FRQ	TH	FR	RR	BC	AD2	JOG	RST	X2	X1	UPF	FB	
COM	VRF	IRF	AMI	P24	PCS	BC	DFL	DFM	MBS	ES	X3	OM	DRV	FC	FA

The terminal screw size:M 3

(3)Change of input logic type

The input logic type can be changed by changing the Short bar connection of control terminal.

Sink type	Between P24 and PCS on the control terminal.
Source type	Between PCS and BC on the control terminal.

(4) The connection to the input programmable logic controller (sequencer)

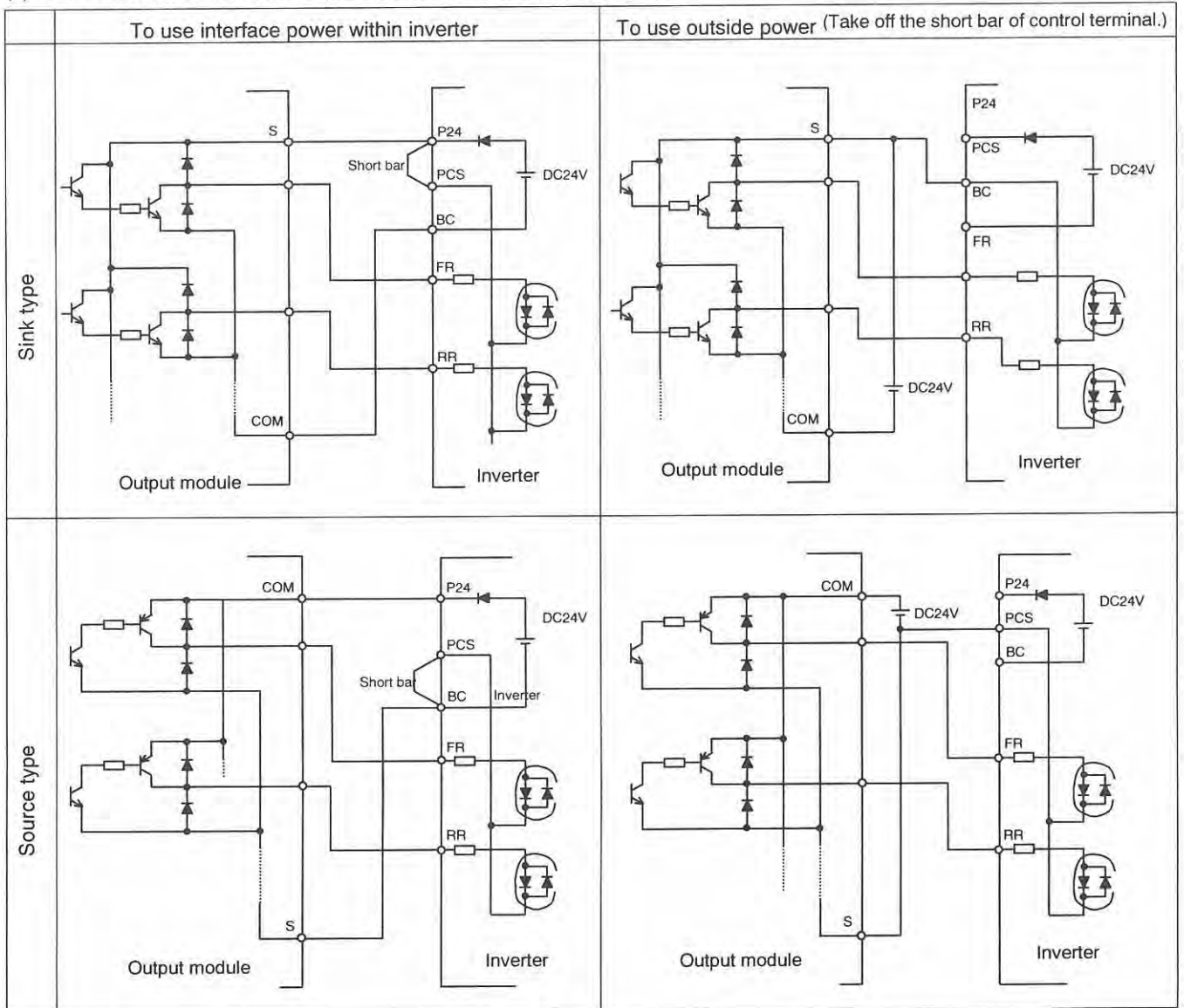

(5) The connection to the output programmable logic controller (sequencer)

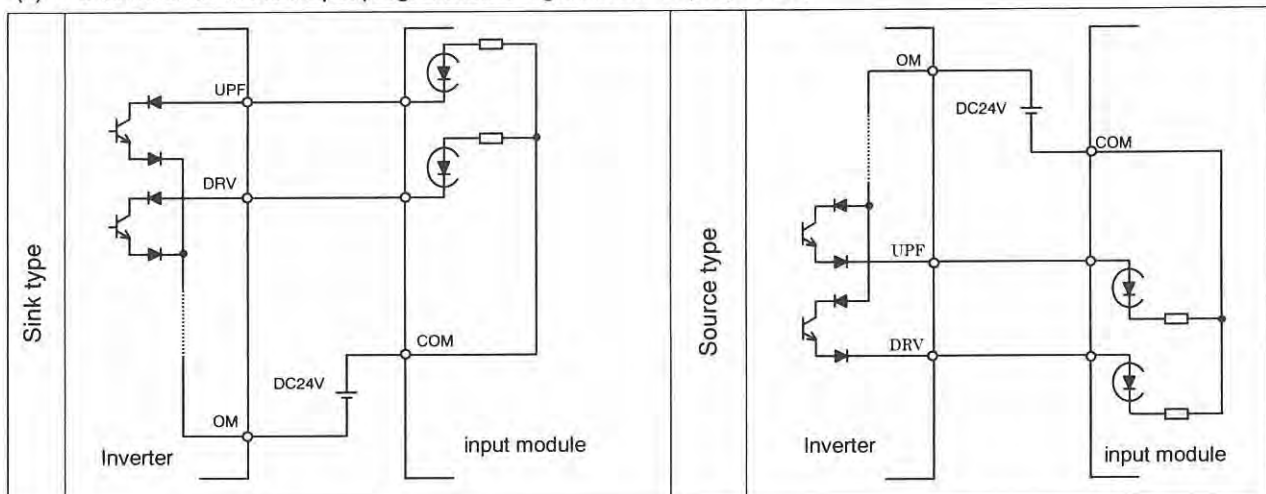

3.1 Operation

This inverter requires two different signals in order for the Inverter to operate correctly. The Inverter requires both an operation setting and a frequency setting.

The following indicates the details of each method of operation and the necessary instructions for operation.

(1) Operation setting and a frequency setting by the terminal control.

This is the method by connecting signals from the outside (the frequency setting, the starting switch etc.) with the control circuit terminals.

The operation is started when the operation setting (FR, RR) is turned ON while the input power is turned ON.

NOTE: The methods of the setting frequency with terminal are the voltage setting and the electric setting.

And they are selective by each system. The control circuit terminal list shows this in detail.

(Necessary things for operation)

[1] The operation setting: switch, relay etc.

[2] The frequency setting: signals from volume or outside (DC0-10V, DC-10-10V, 4-20mA etc.)

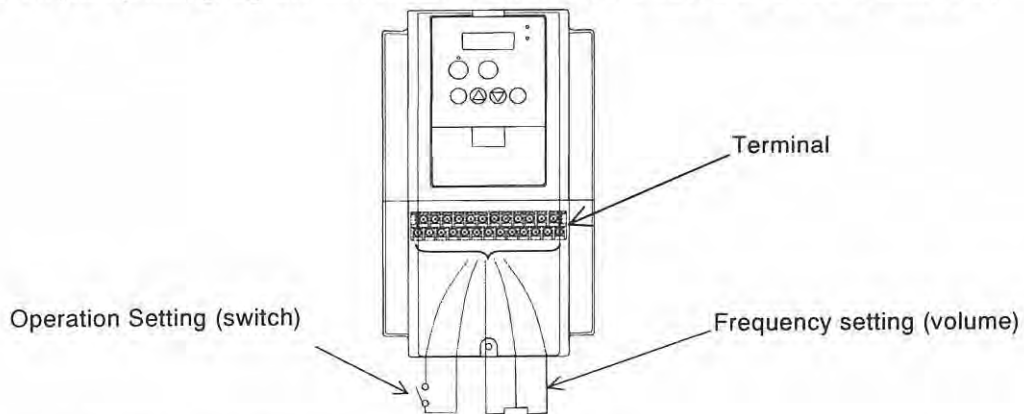

(2) Operation setting and frequency setting with the digital operator.

This is the method for operation from the digital operator, which comes equipped with the inverter as standard, or the remote operator keypad.

When the digital operator sets the operation, the terminals (FR, RR) don't need to be linked.

And it is possible to select frequency from the digital operator as a method of the frequency setting too.

(Necessary things for operation)

[1] Remote Operator (It's unnecessary in case of digital operator operation)

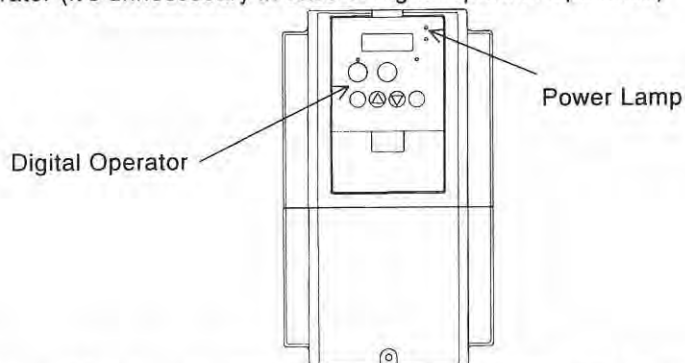

(3) Operation setting and frequency setting from both digital operator and terminal operator

This is the method of inverter operating from both of the above two operating methods

It is possible that the operation setting and the frequency setting can be selected for both the digital operator and the terminal operator each separately.

3.2 Test Run

This is the common connection example. Please refer to 4.1 Digital Operator, for the detailed use of the digital operator.

(1) To input the operation setting and the frequency setting from terminal control.

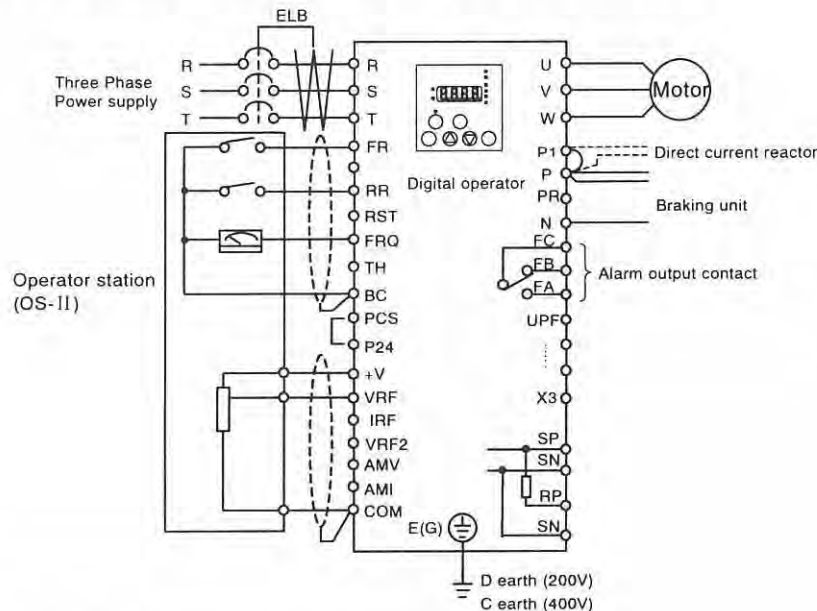

(Arrangements)

- [1] Please make sure that the connections are correctly secure.
- [2] Turn the ELB ON to supply power to the inverter.
(The red LED "POWER" on the digital operator should illuminate.)
- [3] Set terminal with the frequency setting selection.
Set A001 as indication code, press the **FUNC** key once. (Two figures are shown.)
Set 01 with the **▲** key or the **▼** key, press the **STR** key once to set the frequency setting for terminal. (Indication code turns back to A001.)
- [4] Set terminal with the operation setting selection.
Set A002 as indication code, press the **FUNC** key once. (Two figures are shown.)
Set 01 with the **▲** key or the **▼** key; press the **STR** key once to set the operation setting for terminal. (Indication code turns back to A002.)
- [5] Set monitor mode.
When monitoring the output frequency, set indication code to d001, and press the **FUNC** key once.
Or when monitoring the operating direction, set indication code to d003, press the **FUNC** key once.
- [6] Input starting operation setting.
Turn ON between [FR] and [BC] of terminal.
Impress voltage between [VRF] and [COM] of terminal to start operation.
- [7] Input ending operation setting.
Turn OFF between [FR] and [BC] to stop slowly down.

(2) Operation setting and the frequency setting from the digital operator
 (Copy unit is also same use.)

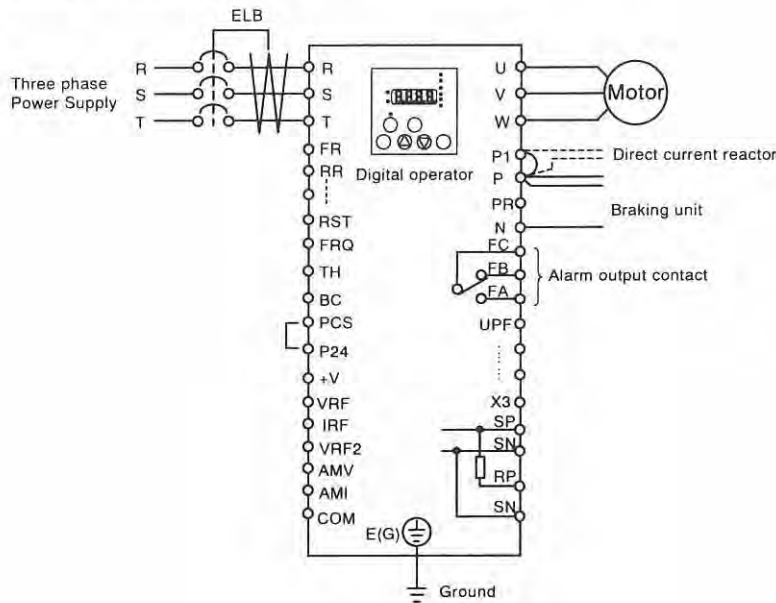

(Arrangements)

[1] Please make sure that there isn't matter about the connection.

[2] Turn the ELB on to supply power to the inverter.
 (The red LED "POWER" on the digital operator should illuminate.)

[3] Set operator with the frequency setting selection.
 Set A001 as indication code, press the **FUNC** key once.
 (Two figures are shown.)



Set 02 with the **1** key or the **2** key, press the **STR** key once to set the frequency setting for the operator.
 (Indication code turns back to A001.)

[4] Set operator with the operation setting selection.
 Set A002 as indication code, press the **FUNC** key once.
 (Two figures are shown.)

Set 02 with the **1** key or the **2** key, press the **STR** key once to set the operation setting for the operator.
 (Indication code turns back to A002.)

[5] Set the output frequency



Set F001 as indication code, as press the  key once.
(Indication code of four figures is shown.)

Set to the desired output frequency with the  key or the  key, press the  key once to store it.



(Indication code turns back to F001.)



[6] Set the operation direction.

Set F004 as indication code, press the  key once.
(00 or 01 is shown.)

Set operation direction to 00 in case of forward, or to 01 in case of reverse with the  key or the  key. Press the  key once to establish it.
(Indication code turns back to F004.)

[7] Set monitor mode.

When monitoring the output frequency, set indication code to d001, and press the  key once.
Or when monitoring the operation direction, set indication code to d003, press the  key once.

(Indication code are  forward,  reverse or  stop.)

[8] Press the  key to start operating.

(The green LED "RUN" turns on a light, and the indication changes in response to the monitor mode set.

[9] Press the  key to decelerate to a stop.

(When the frequency turn back to 0, the green LED "RUN" light will switch off.)

**CAUTION**

Make sure that the direction of the motor is correct. It is in danger of injury or machine damage.

Make sure there is no abnormal noise and vibration. It is in danger of injury or machine damage.

Make sure that there is no tripping during the acceleration and deceleration and check that the revolution per minute and the frequency meter are correct.

When overcurrent tripping or overvoltage tripping occurs during the test run, increase the acceleration time or the deceleration time.

4.1 About Digital Operator

Explanation of operating the digital operator

HF430 series operates by using the digital operator, which is fitted as standard.

1. Name and contents of each part of the digital operator

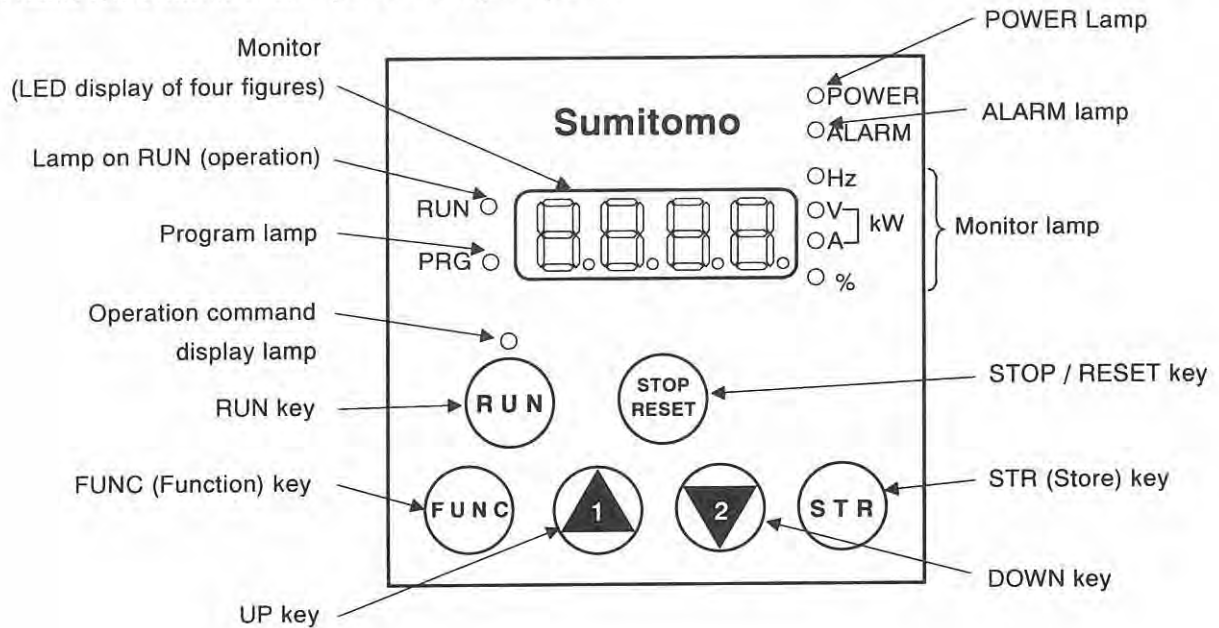

Name	Contents
Monitor	Display of frequency, output current and set value
Lamp on RUN (Operation)	Light on when the inverter is running
Program lamp	Light on when displaying set value of each function in monitor section Light will flash On and Off as a warning (when set value is incorrect)
POWER lamp	Power lamp of control circuit
ALARM lamp	Light on when the Inverter trips
Monitor lamp	Lamp display state of monitor section. Hz : Frequency V : Voltage A : Current kW : Electric power % : Rate
Operation command Display lamp	Light on only when operating command (RUN/STOP) is set in operator
Run key	Run command to start the motor. But this is only valid when operation command is from the operator. (Be sure that the operation command display lamp is illuminated.)
Stop (stop/reset) key	This key is used to stop motor, or reset an alarm.
FUNC(Function) key	The key containing monitor mode, basic setting mode, extension function mode.
STR (Store) key	The key to store the data set. (On changing set value, must be pushed or value is lost.)
UP/DOWN key	The keys to change extension function mode, function mode and set value.

2. Operating method

(1) Method to display monitor mode, basic setting mode, extension function mode

Power on



[1] Display of monitor contents set
(Display 0.00 in initial state)

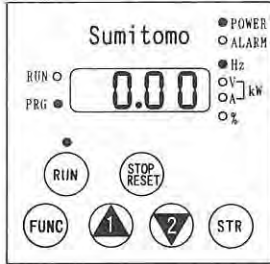

[5] Display monitor code No.
(Display d001)

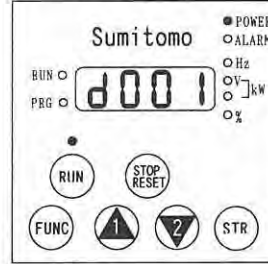

When power is turned off while the basic setting mode or the extension setting mode is displayed. The display will be different from the one above when the power is restored.

Return to the state of [2].



Push the FUNC key.

Push the 1 key. (6 times)



Push the 2 key. (6 times)

[2] Display monitor code No.
(Display d001)

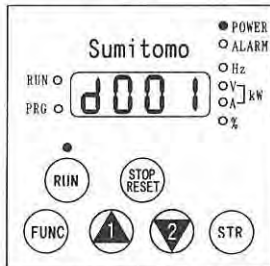

[4] Display extension function mode
(Display A - - -)

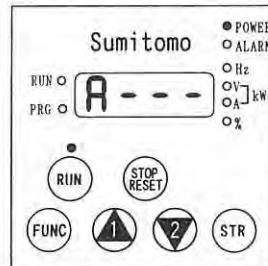

Monitor mode is displayed by pushing FUN (Function) key once when display of Monitor mode No.

Extension function mode
Display in the order of

A ← b ← c ← H ← P ← U.

Push the 2 key. (8 times)



Push the 1 key. (8 times)



Push the 2 key. (8 times)

(Display d002)

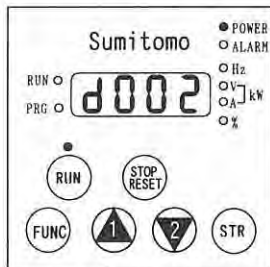

*1 Push the 1 key. (19 times)

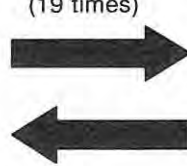

Push the 2 key. (19 times)

[3] Display code No. of basic setting mode.
(Display F001)

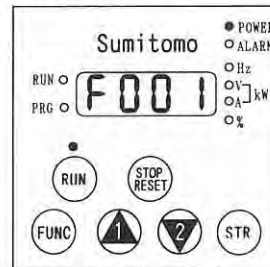

*1(3) Refer to setting method of function code.

(2) Setting method of function

Change operation command part. (Operator → Control terminal)

[1] Display extension function mode

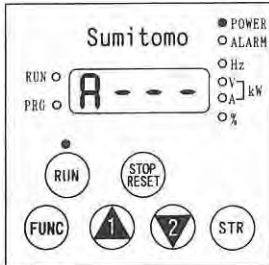

Make monitor display "A - - -" by referring to (1) displaying method.

Now operating command part is by the operator, so operating command display lamp should illuminate.

↓ Push the **FUNC** key.

[2] Display code No. of function mode.

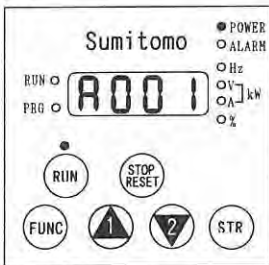

↓ Push the **1** key.

(Display A002)

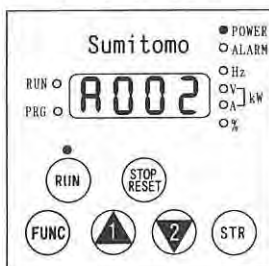

↓ Push the **FUNC** key.

[3] Display contents of function mode Push the **2** key.

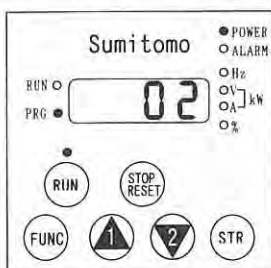

Operation command part displays 02(operator).

Program (PRG) light on by displaying contents of function mode

[5] Display extension function mode (Display A - - -)

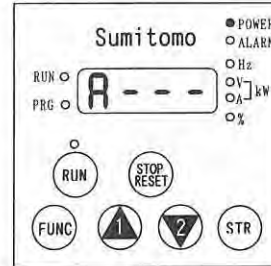

It is possible to shift to other extension function modes, monitor modes and basic modes in this state.

↑ Push the **FUNC** key.

[4] Display code No. of monitor mode. (Display A002)

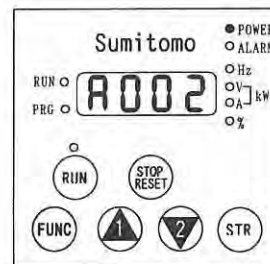

The changed set value is confirmed by pushing the STR key.

Operation command display lamp light will switch off so that operation command is now changed to the control terminal.

↑ Push the **STR** key.

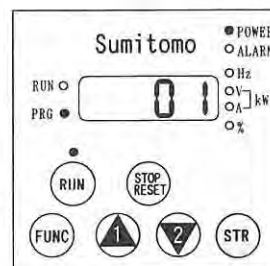

Change operation command part to control terminal 01.

(3) Setting method of function code

Code No. of monitor modes, basic setting modes and extension function codes can be set easily.

Indicate the method to change code No.d001 of monitor mode to function code No. A029 simply.

[1] Display code No. of monitor mode.

(Displayd001)

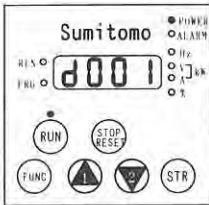

Push the key together.

(Display A029)

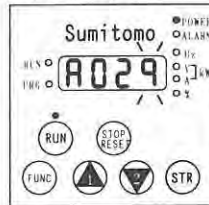

"9" of first figure blinks.

Push the Key
 (Decide "9")

[6] Finish setting function code No.

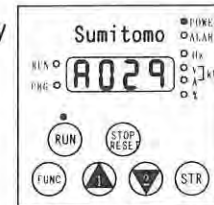

Finish setting A029

(Note) When you input code No. there isn't in the code list, "A" of left end blinks again. Confirm code No. and input it again.

[2] Change extension function mode

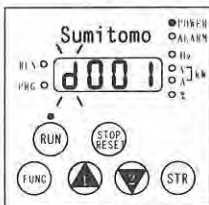

"d" blinks.

Push the key.
 (2 times)

(Display A001)

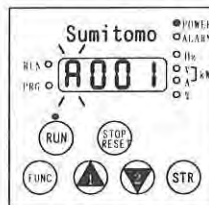

"A" blinks.

The figure lighting is decided by pushing STR key.

Push the key.
 (Confirm "A")

[3] Change third figure of function code No.

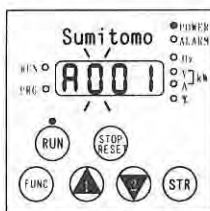

Push the key.
 (Confirm "0")

Third figure "0" blinks.

Don't change third figure and push the STR key and confirm 0.

[5] Change first figure of function code No.

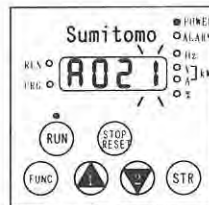

First figure, "1" blinks.

Push the key.

(Display A021)

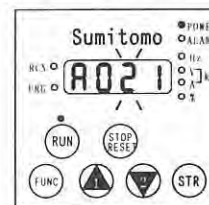

Second figures, "2" blinks.

Push the key.
 (2 times)

[4] Change second figure of function code No.

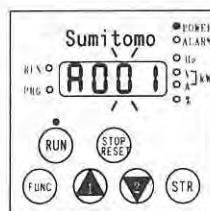

Second figure, "0" blinks.

4.2 Code list

Monitor Mode

(Note1)

Display code	Function name	HF430 monitor or data range (digital operator)	Initial data	Setting On Running	Change mode during running	Page
d001	Output frequency monitor	0.00-99.99/100.0-400.0(Hz)	-	-	-	4-13
d002	Output current monitor	0.0-999.9(A)	-	-	-	4-13
d003	Operation direction monitor	F(forward)/o(stop)/r(reverse)	-	-	-	4-13
d004	PID feedback monitor	0.00-99.99/100.0-999.9/1000. -9999. / 1000-9999/{100-999 (10000-99900)	-	-	-	4-13
d005	multifunctional input terminal monitor	<p>(Example) ON :RST,ES,DFL,FR OFF:JOG,MBS,AD2,DFM,RR</p>	-	-	-	4-14
d006	multifunctional output terminal monitor	<p>(Example) ON :UPF1,DRV OFF:X1,X2,X3,Alarm</p>	-	-	-	4-14
d007	Frequency conversion monitor	0.00-99.99/100.0-999.9/1000. -9999. / 1000-3996	-	-	-	4-15
d012	torque monitor	-300.-+300. %	-	-	-	4-15
d013	Output voltage monitor	0.0-600.0 V	-	-	-	4-15
d014	Input electric power monitor	0.0-999.9 kW	-	-	-	4-15
d016	Accumulated Run time monitor	0.-9999./1000-9999/{100-999 h	-	-	-	4-16
d017	Power ON time Monitor	0.-9999./1000-9999/{100-999 h	-	-	-	4-16
d080	Number of trip time monitor	0.-9999./1000-6553(10000-65530) (time)	-	-	-	4-16
d081	Error history 1	Trip Code, frequency(Hz), current(A), voltage(V),RUN time(h) power ON time(h)	-	-	-	4-16
d082	Error history 2		-	-	-	4-16
d083	Error history 3		-	-	-	4-16
d084	Error history 4		-	-	-	4-16
d085	Error history 5		-	-	-	4-16
d086	Error history 6		-	-	-	4-16
d090	Warning monitor	Warning code	-	-	-	4-100
F001	Output frequency setting	0.0, starting frequency-Max. frequency (B mode max. C mode max. frequency)(Hz)	0.00	✓	✓	4-17
F002	acceleration time	0.01-99.99/100.0-999.9/1000. -3600.(s)	30.00	✓	✓	4-19
F202	B mode acceleration time	0.01-99.99/100.0-999.9/1000. -3600.(s)	30.00	✓	✓	4-19
F302	C mode acceleration time	0.01-99.99/100.0-999.9/1000. -3600.(s)	30.00	✓	✓	4-19
F003	deceleration time	0.01-99.99/100.0-999.9/1000. -3600.(s)	30.00	✓	✓	4-19
F203	B mode deceleration time	0.01-99.99/100.0-999.9/1000. -3600.(s)	30.00	✓	✓	4-19
F303	C mode deceleration time	0.01-99.99/100.0-999.9/1000. -3600.(s)	30.00	✓	✓	4-19
F004	Operation direction selection	00(forward)/01(reverse)	00	-	-	4-17

(Note1) Change mode during run by selection of b031 (software lock selection).

(Note2) Do not forget to press "STR" key when you change the display.

Function Mode

	Code	Function name	Setting range	Initial data	Setting on run	Change Mode on run	Page
Base setting	A001	Frequency setting selection	01(terminal)/02(operator)/03(RS485)/04(option1)/05(option2)	02	-	-	4-17
	A002	Operation setting selection	01(terminal)/02(operator)/03(RS485)/04(option1)/05(option2)	02	-	-	4-18
	A003	Base frequency	30. Maximum frequency(Hz)	60.	-	-	4-20
	A203	B mode Base frequency	30. - B mode Maximum frequency (Hz)	60.	-	-	4-20
	A303	C mode Base frequency	30. - C mode Maximum frequency (Hz)	60.	-	-	4-20
	A004	Maximum frequency	30. - 400. (Hz)	60.	-	-	4-21
	A204	B mode Maximum frequency	30. - 400. (Hz)	60.	-	-	4-21
Analog input setting	A304	C mode Maximum frequency	30. - 400. (Hz)	60.	-	-	4-21
	A005	AUT terminal selection	00(Changing of VRF and IRF with AT terminal)/ 01(Changing of VRF and VRF2 with AT terminal)	00	-	-	4-22
	A006	VRF2 selection	00(single)/01(auxiliary speed of VRF, IRF) [no reversible] / 02(auxiliary speed of VRF, IRF) [reversible]	00	-	-	4-22
	A011	VRF start	0.00-99.99/100.0-400.0 (Hz)	0.00	-	✓	4-23
	A012	VRF end	0.00-99.99/100.0-400.0 (Hz)	0.00	-	✓	4-23
	A013	VRF start rate	0.-100.0 (%)	0.	-	✓	4-23
	A014	VRF end rate	0.-100.0(%)	100.	-	✓	4-23
Multistage speed · jogging frequency setting	A015	VRF start selection	00 (external starting frequency)/01(0Hz)	01	-	✓	4-23
	A016	VRF,IRF, VRF2 sampling	1.-30.(times)	8.	-	✓	4-24
	A019	Multi-speed selection	00(binary : range is to 16 stage speed with 4 terminals)/ 01(bit : range is to 8 stage speed with 7 terminals)	00	-	-	4-44
	A020	Multi-speed 0	0.00, starting frequency-maximum frequency(Hz)	10.0	✓	✓	4-44
	A220	B mode Multi-speed 0	0.00, starting frequency-B mode maximum frequency(Hz)	10.0	✓	✓	4-44
	A320	C mode Multi-speed 0	0.00, starting frequency-C mode maximum frequency(Hz)	10.0	✓	✓	4-44
	A021	Multi-speed1	0.00, starting frequency-maximum frequency(Hz)	20.00	✓	✓	4-44
	A022	Multi-speed2	0.00, starting frequency-maximum frequency(Hz)	30.00	✓	✓	4-44
	A023	Multi-speed3	0.00, starting frequency-maximum frequency(Hz)	40.00	✓	✓	4-44
	A024	Multi-speed4	0.00, starting frequency-maximum frequency(Hz)	0.00	✓	✓	4-44
	A025	Multi-speed5	0.00, starting frequency-maximum frequency(Hz)	0.00	✓	✓	4-44
	A026	Multi-speed6	0.00, starting frequency-maximum frequency(Hz)	0.00	✓	✓	4-44
	A027	Multi-speed7	0.00, starting frequency-maximum frequency(Hz)	0.00	✓	✓	4-44
	A028	Multi-speed8	0.00, starting frequency-maximum frequency(Hz)	0.00	✓	✓	4-44
	A029	Multi-speed9	0.00, starting frequency-maximum frequency(Hz)	0.00	✓	✓	4-44
	A030	Multi-speed10	0.00, starting frequency-maximum frequency(Hz)	0.00	✓	✓	4-44
	A031	Multi-speed11	0.00, starting frequency-maximum frequency(Hz)	0.00	✓	✓	4-44
A032	Multi-speed12	0.00, starting frequency-maximum frequency(Hz)	0.00	✓	✓	4-44	
A033	Multi-speed13	0.00, starting frequency-maximum frequency(Hz)	0.00	✓	✓	4-44	
A034	Multi-speed14	0.00, starting frequency-maximum frequency(Hz)	0.00	✓	✓	4-44	
A035	Multi-speed15	0.00, starting frequency-maximum frequency(Hz)	0.00	✓	✓	4-44	
A038	Jogging frequency	0.00, starting frequency-9.99(Hz)	5.00	✓	✓	4-46	
A039	Jogging selection	00(free-run on JOG stop / invalid on running) / 01(stop decelerating on JOG stop / invalid on running) / 02(DC braking on JOG stop/invalid on running) / 03(free-run on JOG stop/valid on running[JOG after stop decelerating]) / 04 (stop decelerating on JOG stop/valid on running) / 05 (DC braking on JOG stop/valid on operating)	01	-	✓	4-46	
V/f characteristic	A041	Torque boost selection	00 (manual torque boost) / 01 (automatic torque boost)	00	-	-	4-26
	A241	B mode Torque boost selection	00 (manual torque boost) / 01 (automatic torque boost)	00	-	-	4-26
	A042	Manual torque boost	0.0-20.0(%)	1.0	✓	✓	4-26
	A242	B mode Manual torque boost	0.0-20.0(%)	1.0	✓	✓	4-26
	A342	C mode Manual torque boost	0.0-20.0(%)	1.0	✓	✓	4-26
	A043	Manual torque boost point	0.0-50.0(%)	0.8	✓	✓	4-26
	A243	B mode Manual torque boost point	0.0-50.0(%)	0.8	✓	✓	4-26
	A343	C mode Manual torque boost point	0.0-50.0(%)	0.8	✓	✓	4-26
	A044	Control	00/(VC)/01(VP1.7power)/02(free V/f setting)/03(SLV)/ 04(0Hz-SLV)/05(V2)	00	-	-	4-25
	A244	B mode control	00/(VC)/01(VP1.7power)/02(free V/f setting) /03(SLV)/ 04(0Hz-SLV)	00	-	-	4-25
A344	C mode control	00/(VC)/01(VP1.7power)	00	-	-	4-25	
A045	Output voltage gain	20. - 100.	100.	✓	✓	4-24	
Direct current braking	A051	DC braking selection	00(invalid)/01(valid)	00	-	✓	4-27
	A052	DC braking frequency	0.00-60.00(Hz)	0.50	-	✓	4-27
	A053	DC braking wait time	0.0 - 5.0(s)	0.0	-	✓	4-27
	A054	DC braking power	0. - 100. (%)	0.	-	✓	4-27
	A055	DC braking time	0.0 - 60.0(s)	0.0	-	✓	4-27
	A056	DC braking edge/level selection	00(edge action)/01(level action)	01	-	✓	4-27
	A057	DC braking power (starting time)	0. - 100. (%)	0.	-	✓	4-27
	A058	DC braking time(starting time)	0.00-60.0(s)	0.0	-	✓	4-27
	A059	DC carrier frequency	0.5-15(kHz) Derating	5.0	-	-	4-27

Function Mode

Code	Function name	Setting range	Initial data	Setting on run	Change mode on run	Page		
Upper and lower limiter-jump frequency	A061	frequency maximum limiter	0.00, frequency lower limiter-maximum frequency(Hz)	0.00	-	✓	4-29	
	A261	B mode frequency maximum limiter	0.00, B mode frequency lower limiter -B mode setting maximum frequency(Hz)	0.00	-	✓	4-29	
	A062	frequency minimum limiter	0.00, start frequency- frequency maximum limiter (Hz)	0.00	-	✓	4-29	
	A262	B mode frequency minimum limiter	0.00, start frequency-B mode frequency maximum limiter (Hz)	0.00	-	✓	4-29	
	A063	Jump frequency1	0.00-99.99/100.0-400.0(Hz)	0.00	-	✓	4-29	
	A064	Jump frequency Width 1	0.00-10.00(Hz)	0.50	-	✓	4-29	
	A065	Jump frequency2	0.00-99.99/100.0-400.0(Hz)	0.00	-	✓	4-29	
	A066	Jump frequency Width 2	0.00-10.00(Hz)	0.50	-	✓	4-29	
	A067	Jump frequency3	0.00-99.99/100.0-400.0(Hz)	0.00	-	✓	4-29	
	A068	Jump frequency Width 3	0.00-10.00(Hz)	0.50	-	✓	4-29	
PID control	A069	Acceleration stop frequency	0.00-99.99/100.0-400.0(Hz)	0.00	-	✓	4-29	
	A070	Acceleration stop time	0.00-60.0(s)	0.0	-	✓	4-29	
	A071	PID selection	00(Invalid)/01(valid)	00	-	✓	4-31	
	A072	PID-P gain	0.2-5.0	1.0	✓	✓	4-31	
	A073	PID-I gain	0.0-3600.(s)	1.0	✓	✓	4-31	
	A074	PID-D gain	0.00-100.0(s)	0.00	✓	✓	4-31	
	A075	PID scale	0.01-99.99(%)	1.00	-	✓	4-31	
AVR	A076	PID feedback selection	00(feedback : IRF)/01(feedback : VRF)	00	-	✓	4-31	
	A081	AVR selection	00(ON always)/01(OFF always)/02(OFF on decelerating)	00	-	-	4-20	
	A082	Motor voltage selection	200/215/220/230/240, 380/400/415/440/460/480	(200/400)	-	-	4-20	
	A085	Operation mode selection	00(normal operation)/01(energy-saving operation)/02(Fuzzy)	00	-	-	4-32	
	A086	Energy-saving response-accuracy adjustment	0.0-100.0	50.0	✓	✓	4-32	
	A092	Acceleration time2	0.01-99.99/100.0-999.9/1000.-3600.(s)	30.00	✓	✓	4-33	
	A292	B mode Acceleration time2	0.01-99.99/100.0-999.9/1000.-3600.(s)	30.00	✓	✓	4-33	
	A392	C mode Acceleration time2	0.01-99.99/100.0-999.9/1000.-3600.(s)	30.00	✓	✓	4-33	
	A093	Deceleration time2	0.01-99.99/100.0-999.9/1000.-3600.(s)	30.00	✓	✓	4-33	
	A293	B mode Deceleration time2	0.01-99.99/100.0-999.9/1000.-3600.(s)	30.00	✓	✓	4-33	
Operation mode/ adjustable function	A393	C mode Deceleration time2	0.01-99.99/100.0-999.9/1000.-3600.(s)	30.00	✓	✓	4-33	
	A094	2nd stage adjustable selection	00(change with AD2 terminal)/01(change with setting)	00	-	-	4-33	
	A294	B mode 2nd stage adjustable selection	00(change with AD2 terminal)/01(change with setting)	00	-	-	4-33	
	A095	2nd Acceleration frequency	0.00-99.99/100.0-400.0(Hz)	0.00	-	-	4-33	
	A295	B mode 2nd accelerationFrequency	0.00-99.99/100.0-400.0(Hz)	0.00	-	-	4-33	
	A096	2nd deceleration frequency	0.00-99.99/100.0-400.0(Hz)	0.00	-	-	4-33	
	A296	B mode 2nd deceleration frequency	0.00-99.99/100.0-400.0(Hz)	0.00	-	-	4-33	
	A097	Acceleration pattern selection	00(straight line)/01(S-curve)/02(U-curve)/03(reverse U-curve)	00	-	-	4-34	
	A098	Deceleration pattern selection	00(straight line)/01(S-curve)/02(U-curve)/03(reverse U-curve)	00	-	-	4-34	
	External frequency adjustment	A101	IRF start	0.00-99.99/100.0-400.0(Hz)	0.00	-	✓	4-23
A102		IRF end	0.00-99.99/100.0-400.0(Hz)	0.00	-	✓	4-23	
A103		IRF start rate	0.-100.(%)	20.	-	✓	4-23	
A104		IRF end rate	0.-100.(%)	100.	-	✓	4-23	
A105		IRF start selection	00(external start frequency)/01(0Hz)	01	-	✓	4-23	
A111		VRF2 start	-400.-100./-99.9-0.00-99.9/100.-400.(Hz)	0.00	-	✓	4-23	
A112		VRF2 end	-400.-100./-99.9-0.00-99.9/100.-400.(Hz)	0.00	-	✓	4-23	
Accel, Decel.	A113	VRF2 start rate	-100.-100.(%)	-100.	-	✓	4-23	
	A114	VRF2 end rate	-100.-100.(%)	100.	-	✓	4-23	
	A131	Acceleration curve constant	01(small swelling)-10(large swelling)	02	-	-	4-34	
	A132	Deceleration curve constant	01(small swelling)-10(large swelling)	02	-	-	4-34	
	Instantaneous power failure restart	b001	Retry selection	00(trip)/01(0Hz start)/02(start after equal frequency)/03(trip after equaling frequency and deceleration stop)	00	-	✓	4-35
		b002	Allowable under-voltage power failure time	0.3-1.0(s)	1.0	-	✓	4-35
		b003	Retry wait time	0.3-100.(s)	1.0	-	✓	4-35
b004		Instantaneous power failure/ Under-voltage trip during stop	00(Invalid)/01(valid)/02(Invalid during stop and deceleration by stop command)	00	-	✓	4-35	
b005		Instantaneous power failure/ under-voltage retry time selection	00(16 times)/01(free)	00	-	✓	4-35	
b006		Open-phase selection	00(Invalid)/01(valid)	00	-	✓	4-37	
b007		Frequency setting to match	0.00-99.99/100.0-400.0(Hz)	0.00	-	✓	4-35	

Function mode

Code	Function name	Setting range	Initial data	Setting on run	Change on run mode	Page	
Electronic thermal	b012	Electronic thermal level	0.2*constant current-1.20*constant current(A)	Rated Current of inverter	-	✓	4-37
	b212	B mode Electronic thermal level	0.2*constant current-1.20*constant current(A)	Rated Current of inverter	-	✓	4-37
	b312	C mode Electronic thermal level	0.2*constant current-1.20*constant current(A)	Rated current of inverter	-	✓	4-37
	b013	electronic thermal characteristic selection	00(reduced characteristic)/ 01(constant torque characteristic)/ 02(free setting)	00	-	✓	4-37
	b213	B mode electronic thermal Characteristic selection	00(reduced characteristic)/ 01(constant torque characteristic)/ 02(free setting)	00	-	✓	4-37
	b313	C mode electronic thermal Characteristic selection	00/(reduced characteristic)01(constant torque characteristic)/ 02(free setting)	00	-	✓	4-37
	b015	Free electronic thermal frequency 1	0.-400.(Hz)	0.	-	✓	4-38
	b016	Free electronic thermal current 1	0.0-1000.(A)	0.0	-	✓	4-38
	b017	Free electronic thermal frequency 2	0.-400.(Hz)	0.	-	✓	4-38
	b018	Free electronic thermal current 2	0.0-1000.(A)	0.0	-	✓	4-38
	b019	Free electronic thermal frequency 3	0.-400.(Hz)	0.	-	✓	4-38
b020	Free electronic thermal current 3	0.0-1000.(A)	0.0	-	✓	4-38	
Overload limit	b021	Stall prevention selection	00(invalid)/01(enabled on acceleration / constant speed)/ 02(enabled on constant speed)/03(enabled on acceleration / constant speed (speed increasing at regenerating mode))	03	-	✓	4-39
	b022	Stall prevention level	0.50* rated current-2.00* rated current(A)	Rated current of Inverter x 1.50	-	✓	4-39
	b023	Stall prevention constant	0.10-30.00(s)	1.00	-	✓	4-39
	b024	Stall prevention 2 selection	00(invalid)/01(enabled on acceleration / constant speed)/ 02(enabled on constant speed)/03(enabled on acceleration / constant speed (speed increasing at regenerating mode))	03	-	✓	4-39
	b025	Stall prevention level 2	0.50*rated current-2.00*rated current(A)	Rated current of inverter x1.50	-	✓	4-39
	b026	Stall prevention constant 2	0.10-30.00(s)	1.00	-	✓	4-39
	b031	Software lock mode selection	00(impossible to change the data except this item when SFT terminal is ON)/01(impossible to change the data except setting frequency item when SFT terminal is ON)/02(impossible to change the data except this item)/ 03(impossible to change the data except setting frequency item)/ 10(possible to change data on operating)	01	-	✓	4-48
Free V/f setting	b100	Free V/f frequency 1	0.- Free V/f frequency2(Hz)	0	-	-	
	b101	Free V/f voltage 1	0.-800.0(V)	0.0	-	-	
	b102	Free V/f frequency 2	0.- Free V/f frequency3(Hz)	0	-	-	
	b103	Free V/f voltage 2	0.-800.0(V)	0.0	-	-	
	b104	Free V/f frequency 3	0.- Free V/f frequency4(Hz)	0	-	-	
	b105	Free V/f voltage 3	0.-800.0(V)	0.0	-	-	
	b106	Free V/f frequency 4	0.- Free V/f frequency5(Hz)	0	-	-	
	b107	Free V/f voltage 4	0.-800.0(V)	0.0	-	-	
	b108	Free V/f frequency 5	0.- Free V/f frequency6(Hz)	0	-	-	
	b109	Free V/f voltage 5	0.-800.0(V)	0.0	-	-	
	b110	Free V/f frequency 6	0.- Free V/f frequency7(Hz)	0	-	-	
	b111	Free V/f voltage 6	0.-800.0(V)	0.0	-	-	
	b112	Free V/f frequency 7	0.-400.(Hz)	0	-	-	
b113	Free V/f voltage 7	0.-800.0(V)	0.0	-	-		
Multifunctional input terminal setting	C001	Multifunctional input RST setting	01/(RR:Reverse is valid)/02(DFL:Multi-speed1)/ 03(DFM:Multi-speed2)/ 04(DFH:Multi-speed3)/ 05(DFHH:Multi-speed4)/ 06(JOG:Jogging)/ 07(DB:External DC braking)/ 08(BMD:B mode control)/ 09(AD2:two-stage adjustable speed)/ 11(MBS:Free-run)/ 12(ES:External trip)/13(USP:Unattended start protection)/ 14(CS:commercial change)/15(SFT:software lock)/ 16(AUT:Analog input voltage/current select)/ 17(CMD:C modecontrol)/ 18(RST:Reset inverter)/ 20(STA:3wire run)/ 21(STP:3wire keep)/ 22(F/R:3wire forward/reverse)/ 23(PID:PID selection valid/invalid)/ 24(PIDC:PID integrating reset)/26(CAS:Control gain switch function)/ 27(UP:Remote control UP function)/	18	-	✓	4-43
	C002	Multifunctional input ES setting	28(DWN:Remote control DOWN function)/29(UDC:Remote control data clear)/ 31(OPE:Operating by operator select)/ 32(SF1:Multi-speed bit1)/ 33(SF2:Multi-speed bit2)/ 34(SF3:Multi-speed bit3)/ 35(SF4:Multi-speed bit4)/ 36(SF5:Multi speed bit5)/ 37(SF6:Multi-speed bit6)/ 38(SF7:Multi-speed bit7)/ 39(OLR:Overload restriction change) / 40(TL:Torque limit select)/	12	-	✓	4-43
	C003	Multifunctional input JOG setting	41(TRQ1:Torque limit switch 1)/ 42(TRQ2:Torque limit switch 2)/ 43((PPI:P/PI switch)/ 44(BOK:Braking comformation)/ 45(ORT:Orientation)/ 46(LAC:LAD cancel)/ 47(PCLR:Position error clear)/ 48(STAT:Permission of pulse train)/ no(NO:No assign)	06	-	✓	4-43
	C004	Multifunctional input MBS setting		11	-	✓	4-43
	C005	Multifunctional input AD2 setting		09	-	✓	4-43
	C006	Multifunctional input DFM setting		03	-	✓	4-43
	C007	Multifunctional input DFL setting		02	-	✓	4-43
	C008	Multifunctional input RR setting		01	-	✓	4-43

Function mode

	Code	Function name	Setting range	Initial data	Setting on run	Change mode on run	Page
Multifunctional input terminal setting	C011	Multifunctional input RST a/b (NO/NC) selection	00(NO)/01(NC)	00	-	✓	4-44
	C012	Multifunctional input ES a/b (NO/NC) selection	00(NO)/01(NC)	00	-	✓	4-44
	C013	Multifunctional input JOG a/b (NO/NC) selection	00(NO)/01(NC)	00	-	✓	4-44
	C014	Multifunctional input MBS a/b (NO/NC) selection	00(NO)/01(NC)	00	-	✓	4-44
	C015	Multifunctional input AD2 a/b (NO/NC) selection	00(NO)/01(NC)	00	-	✓	4-44
	C016	Multifunctional input DFM a/b (NO/NC) selection	00(NO)/01(NC)	00	-	✓	4-44
	C017	Multifunctional input DFL a/b (NO/NC) selection	00(NO)/01(NC)	00	-	✓	4-44
	C018	Multifunctional input RR a/b (NO/NC) selection	00(NO)/01(NC)	00	-	✓	4-44
	C019	Input FR a/b (NO/NC) Selection	00(NO)/01(NC)	00	-	✓	4-44
Multifunctional output terminal	C021	Multifunctional output UPF1 setting	00(DRV:driving)/01(UPF1:Frequency arrival type1 signal)/02(UPF2:over setting frequency)/03(OL:Overload advance notice signal)/04(OD:Output deviation for PID control)/05(AL:Alarm signal)/06(UPF3:Only setting frequency)/07(OTQ:Over-torque signal)/08(IP:On instantaneous stop)/09(UV:Under voltage)/10(TRQ:Torque limit)/11(RNT:RUN time over)/12(ONT:ON time over)/13(THM:thermal caution)/19(BRK:Brake release signal)/20(BER:Brake error signal)/21(ZS:Zero speed detect signal)/22(DSE:Speed error over signal)/23(POK:Positioning completion signal)24(UPF4:Over frequency 2 signal)/25(UPF5:Only setting frequency)/26(OL2: Overload advance notice signal 2)	01	-	✓	4-53
	C022	Multifunctional output DRV setting		00	-	✓	4-53
	C023	Multifunctional output X1 setting		13	-	✓	4-53
	C024	Multifunctional output X2 setting		07	-	✓	4-53
	C025	Multifunctional output X3 setting		08	-	✓	4-53
	C026	Alarm relay output (FA,FB,FC)		05	-	✓	4-53
	C027	FRQ selection	00(Output frequency)/01(Output current)/02(Output torque)/03(Digital output frequency)/04(Output voltage)/05(Input electric power)/06(thermal load rate)/07(LAD frequency)	00	-	✓	4-57
	C028	AMV selection	00(Output frequency)/01(Output current)/02(Output torque)/04(Output voltage)/05(Input electric power)/06(thermal load rate)/07(LAD frequency)	00	-	✓	4-58
	C029	AMI selection	00(Output frequency)/01(Output current)/02(Output torque)/04(Output voltage)/05(Input electric power)/06(Thermal load rate)/07(LAD frequency)	00	-	✓	4-58
Output level setting Output terminal state setting*	C031	Multifunctional output UPF a/b(NO/NC) selection	00(NO)/01(NC)	00	-	✓	4-53
	C032	Multifunctional output DRV a/b(NO/NC) selection	00(NO)/01(NC)	00	-	✓	4-53
	C033	Multifunctional output X1 a/b(NO/NC) selection	00(NO)/01(NC)	00	-	✓	4-53
	C034	Multifunctional output X2 a/b(NO/NC) selection	00(NO)/01(NC)	00	-	✓	4-53
	C035	Multifunctional output X3 a/b(NO/NC) selection	00(NO)/01(NC)	00	-	✓	4-53
	C036	Alarm relay output a/b(NO/NC) selection	00(NO)/01(NC)	01	-	✓	4-53
	C040	Current detection signal output mode	00(On accel. And decel, constant speed)/01(Only constant speed)	00	-	✓	4-40
	C041	Current detection level	0.0-2.0*rated current(A)	Inverter rated current	-	✓	4-40
	C042	Frequency reaching setting for acceleration.	0.00-99.99/100.0-400.0(Hz)	0.00	-	✓	4-54
	C043	Frequency reaching setting for deceleration.	0.00-99.99/100.0-400.0(Hz)	0.00	-	✓	4-54
	C044	PID deviation setting level	0.0-100.0(%)	3.0	-	✓	4-31
	C045	Frequency reaching setting for acceleration 2.	0.00-99.99/100.0-400.0(Hz)	0.00	-	✓	4-54
	C046	Frequency reaching setting for deceleration 2.	0.00-99.99/100.0-400.0(Hz)	0.00	-	✓	4-54
	C055	Over torque level setting (Forward-driving)	0-200.(%)	100.	-	✓	4-54
	C056	Over torque level setting (Reverse-regenerating)	0-200.(%)	100.	-	✓	4-54
C057	Over torque level setting (Reverse-driving)	0-200.(%)	100.	-	✓	4-54	
C058	Over torque level setting (Forward-regenerating)	0-200.(%)	100.	-	✓	4-54	
C061	Electronic thermal relay Pre-alarm level setting	0-100.(%)	85.	-	✓	4-37	
C062	Alarm code selection	00(Invalid)/01(3bit)/02(4bit)	00	-	✓	4-57	
C063	Zero speed detection level setting	0.00-99.99/100.(Hz)	0.00	-	✓	4-56	
Communication function adjustment	C070	Data command	02(operator)/03(RS485)/04(option1)/05(option2)	02	-	-	4-74
	C071	Communicating transmission speed	02(loop-back test)03(2400bps)/04(4800bps)/05(9600bps)/06(19200bps)	04	-	✓	4-74
	C072	Communication code	1-32.	1.	-	✓	4-74
	C073	Communication bit	7(7bit)/8(8bit)	7	-	✓	4-74
	C074	Communication parity	00(no parity name)/01(even parity)/02(odd parity)	00	-	✓	4-74
C075	Communication stop bit	1(bit)/2(bit)	1	-	✓	4-74	
C078	Communication waiting time	0-1000.(ms)	0.	-	✓	4-74	

Function mode

	Code	Function name	Setting range	Initial data	Setting on run	Change mode on run	Page
Analog meter setting	C081	VRF adjustment	0.-9999./1000-6553(10000-65530)	Setting on forwarding	✓	✓	-
	C082	IRF adjustment	0.-9999./1000-6553(10000-65530)	Setting on forwarding	✓	✓	-
	C083	VRF2 adjustment	0.-9999./1000-6553(10000-65530)	Setting on forwarding	✓	✓	-
	C085	Thermistor adjustment	0.0 - 1000.	105.0	✓	✓	4-58
	C086	AMV offset adjustment	0.0 - 10.0(V)	0.0	✓	✓	4-58
	C087	AMI adjustment	0 - 255.	80	✓	✓	4-58
	C088	AMI offset adjustment	0. - 20.0(mA)	Setting on forwarding	✓	✓	4-58
	The others	b034	RUN time/Power ON time level	0.-9999./1000-6553(10000-65530)hr	0.	-	✓
b035		Operation direction restrict	00(Reverse is valid)/01(Only forward)/02(Only reverse)	00	-	-	4-17
b036		Start reduced voltage	00(Start reduced voltage time small)-06(Start reduced voltage time large)	06	-	✓	4-41
b037		Display selection	00(all display)/01(each function display)/02(User setting / main setting)	00	-	✓	4-60
b040		Torque limit mode selection	00(4 quadrant mode)/01(Terminal operation)/02(Analog input)/03(Option1)/04(Option2)	00	-	✓	4-71
b041		Torque limit level 1 setting (Forward-driving at 4 quadrant mode)	0.-200.(%)/no(Invalid)	150.	-	✓	4-71
b042		Torque limit level 2 setting (Reverse-regenerating at 4 quadrant mode)	0.-200.(%)/no(Invalid)	150.	-	✓	4-71
b043		Torque limit level 3 setting (Reverse-driving at 4 quadrant mode)	0.-200.(%)/no(Invalid)	150.	-	✓	4-71
b044		Torque limit level 4 setting (Forward-regenerating at 4 quadrant mode)	0.-200.(%)/no(Invalid)	150.	-	✓	4-71
b045		Torque LAD-STOP selection	00(Invalid)/01(Valid)	00	-	✓	4-73
b046		Reverse run prevention Selection	00(Invalid)/01(Valid)	00	-	✓	-
b050		Selection of non-stop function at instantaneous power failure	00(Invalid)/01(Valid)	00	-	-	-
b051		Start voltage of non-stop function setting	0.0-1000.(V)	0.0	-	-	-
b052		OV LAD-STOP level of non-stop function setting	0.0-1000.(V)	0.0	-	-	-
b053		Deceleration time of non-stop function setting	0.01-99.99/100.0-999.9/1000.-3600.(s)	1.00	-	-	-
b054		Deceleration frequency width of non-stop function setting	0.00-10.00(Hz)	0.00	-	-	-
b080		AMV adjustment	0 - 255.	180	✓	✓	4-58
b081		FRQ adjustment	0 - 255.	60	✓	✓	4-57
b082		Start frequency adjustment	0.10-9.99(Hz)	0.50	-	✓	4-41
b083		Carrier frequency setting	0.5-15.0(kHz) Derating enable,	5.0	-	✓	4-21
b084		Initialize mode	00(Error history clear)/01(Data initialization)/02(Error history clear + data initialization)	00	-	-	4-59
b085		Country code for initialization	00(Interior)/01(EC)/02(USA)	00	-	-	4-59
b086		Frequency scalar conversion factor	0.1-99.9	1.0	✓	✓	4-15
b087		STOP key enable	00(valid)/01(invalid)	00	-	✓	4-18
b088		Resume on FRS cancellation mode	00(0Hz start)/01(Start f-equaling)	00	-	✓	4-49
b090		DBTR usage ratio	0.0-100.0(%)	0.0	-	✓	4-42
b091		Stop mode selection	00(deceleration stop)/01(Free-run stop)	00	-	-	4-18
b092		Cooling fan control	00(Always ON)/01(ON during run, After power ON, then for 5 minutes on stop is implied.)	00	-	-	4-42
b095		DBTR selection	00(invalid)/01(valid<invalid during stop>)/02(valid<valid during stop>)	00	-	✓	4-42
b096		DBTR ON level	330-380/660-760(V)	360/720	-	✓	4-42
b098		Thermistor selection	00(invalid)/01(Positive temperature coefficient enable)/02 (NTC enable)	00	-	✓	4-59
b099		Thermistor error level	0 - 9999. (ohm)	3000.	-	✓	4-59
b120		Braking control selection	00(Invalid)/01(valid)	00	-	✓	4-62
b121		Waiting time for releasing braking conformation	0.00-5.00(s)	0.00	-	✓	4-62
b122		Waiting time for acceleration	0.00-5.00(s)	0.00	-	✓	4-62
b123		Waiting time for stop	0.00-5.00(s)	0.00	-	✓	4-62
b124		Waiting time for signal conformation	0.00-5.00(s)	0.00	-	✓	4-62
b125		Releasing frequency	0.00-99.99/100.0-400.0(Hz)	0.00	-	✓	4-62
b126		Releasing current	0.00*rated current-2.00*rated current(A)	Rated current of inverter	-	✓	4-62
C091		Debug mode selection	00(No display)/01(Display)	00	-	✓	-
C101		UP/DWN selection	00(No frequency data)/01(Keep frequency data)	00	-	✓	4-51
C102		Reset selection	00(Trip cancel during ON)/01(Trip cancel during OFF)/02(Valid only during trip<Cancel during ON>)	00	-	✓	4-50
C103	Reset f frequency matching selection	00(0Hz start)/01(Start f-equaling)	00	-	✓	4-50	
C111	Current detection level	0.0-2.0*rated current(A)	Inverter rated current	-	✓	4-40	
C121	VRF zero adjustment	0.-9999./1000-6553(10000-65530)	Set on forwarding	✓	✓	-	
C122	IRF zero adjustment	0.-9999./1000-6553(10000-65530)	Set on forwarding	✓	✓	-	
C123	VRF2 zero adjustment	0.-9999./1000-6553(10000-65530)	Set on forwarding	✓	✓	-	

Function mode

Code	Function name	Setting range	Initial data	Setting on run	Change mode on run	Page
H001	Autotuning selection	00(Invalid)/01(Valid(the motor does not rotate))/ 02(Valid(the motor rotates))	00	-	-	4-64
H002	motor constant selection	00(sumitomo general purpose motor data)/01(AF motor)/ 02(Explosion proof motor)/ 03(Autotuning data)/ 04(Autotuning data with online autotuning)	00	-	-	4-64
H202	B mode motor constant selection	00(sumitomo general purpose motor data)/01(AF motor)/ 02(Explosion proof motor)/ 03(Autotuning data)/ 04(Autotuning data with online autotuning)	00	-	-	4-64
H003	allowable motor selection	0.20-75.0(kW)	Set on forwarding	-	-	4-64
H203	B mode allowable motor selection	0.20-75.0(kW)	Set on forwarding	-	-	4-64
H004	motor pole selection	2/4/6/8(pole)	4	-	-	4-64
H204	B mode motor pole selection	2/4/6/8(pole)	4	-	-	4-64
H005	speed response setting	0.001-9.999/10.00-65.53	1.590	✓	✓	4-68
H205	B mode speed response setting	0.001-9.999/10.00-65.53	1.590	✓	✓	4-68
H006	stabilized factor	0. - 255.	100.	✓	✓	4-61
H206	B mode stabilized factor	0. - 255.	100.	✓	✓	4-61
H306	C mode stabilized factor	0. - 255.	100.	✓	✓	4-61
H020	motor constant R1	0.000-9.999/10.00-65.53(ohm)	Set on forwarding	-	-	4-47
H220	B mode motor constant R1	0.000-9.999/10.00-65.53(ohm)	Set on forwarding	-	-	4-47
H021	motor constant R2	0.000-9.999/10.00-65.53(ohm)	Set on forwarding	-	-	4-47
H221	B mode motor constant R2	0.000-9.999/10.00-65.53(ohm)	Set on forwarding	-	-	4-47
H022	motor constant L	0.00-99.99/100.0-655.3(mH)	Set on forwarding	-	-	4-47
H222	B mode motor constant L	0.00-99.99/100.0-655.3(mH)	Set on forwarding	-	-	4-47
H023	motor constant I _e	0.00-99.99/100.0-655.3(A)	Set on forwarding	-	-	4-47
H223	B mode motor constant I _e	0.00-99.99/100.0-655.3(A)	Set on forwarding	-	-	4-47
H024	motor constant J	0.001-9.999/10.00-99.99/100.0-9999.(kgm ²)	Set on forwarding	-	-	4-47
H224	B mode motor constant J	0.001-9.999/10.00-99.99/100.0-9999.(kgm ²)	Set on forwarding	-	-	4-47
H030	motor constant R1 (Autotuning data)	0.000-9.999/10.00-65.53(ohm)	Set on forwarding	-	-	4-47
H230	B mode motor constant R1 (Autotuning data)	0.000-9.999/10.00-65.53(ohm)	Set on forwarding	-	-	4-47
H031	motor constant R2 (Autotuning data)	0.000-9.999/10.00-65.53(ohm)	Set on forwarding	-	-	4-47
H231	B mode motor constant R2 (Autotuning data)	0.000-9.999/10.00-65.53(ohm)	Set on forwarding	-	-	4-47
H032	motor constant L (Autotuning data)	0.00-99.99/100.0-655.3(mH)	Set on forwarding	-	-	4-47
H232	B mode motor constant L (Autotuning data)	0.00-99.99/100.0-655.3(mH)	Set on forwarding	-	-	4-47
H033	motor constant I _e (Autotuning data)	0.00-99.99/100.0-655.3(A)	Set on forwarding	-	-	4-47
H233	B mode motor constant I _e (Autotuning data)	0.00-99.99/100.0-655.3(A)	Set on forwarding	-	-	4-47
H034	motor constant J	0.001-9.999/10.00-99.99/100.0-9999.(kgm ²)	Set on forwarding	-	-	4-47
H234	B mode motor constant J	0.001-9.999/10.00-99.99/100.0-9999.(kgm ²)	Set on forwarding	-	-	4-47
H050	PI-control proportion gain setting	0.00-99.99/100.0-999.9/1000.(%)	100.0	✓	✓	-
H250	B mode PI-control proportion gain setting	0.00-99.99/100.0-999.9/1000.(%)	100.0	✓	✓	-
H051	PI-control integration gain setting	0.00-99.99/100.0-999.9/1000.(%)	100.0	✓	✓	-
H251	B mode PI-control integration gain setting	0.00-99.99/100.0-999.9/1000.(%)	100.0	✓	✓	-
H052	P-control proportion gain setting	0.01-10.00	1.00	✓	✓	-
H252	B mode P-control proportion gain setting	0.01-10.00	1.00	✓	✓	-
H060	0Hz-SLV limiter setting	0.-100.(%)	100.	✓	✓	4-69
H260	B mode 0Hz-SLV limiter setting	0.-100.(%)	100.	✓	✓	4-69
H070	PI-control proportion gain for switching	0.00-99.99/100.0-999.9/1000.(%)	100.0	✓	✓	-
H071	PI-control integration gain for switching	0.00-99.99/100.0-999.9/1000.(%)	100.0	✓	✓	-
H072	P-control proportion gain for switching	0.00-10.00	1.00	✓	✓	-

The others

Function mode

Code	Function name	Setting range	Initial data	Setting on run	Change mode on run	Page	
Option	P001	Option1 operation selection on error	00(TRP)/01(RUN)	00	-	✓	-
	P002	Option2 operation selection on error	00(TRP)/01(RUN)	00	-	✓	-
	P010	Feed-back option selection	00(Invalid)/01(Valid)	00	-	-	-
	P011	Encoder pulse number Setting	128..9999./1000-6500(10000-65000) (pulse)	1024	-	-	-
	P012	Control mode selection	00(ASR mode)/01(APR mode)	00	-	-	-
	P013	Pulse train input mode Selection	00(Mode 0)/01(Mode 1)/02(Mode 2)/03(Mode 3)	00	-	-	-
	P014	Orientation stop position Setting	0..4095.	0.	-	✓	-
	P015	Orientation speed setting	0.00-99.99/100.0-120.0(Hz)	5.00	-	✓	-
	P016	Orientation direction Selection	00(Forward)/01(Reverse)	00	-	-	-
	P017	Orientation completion range setting	0..9999./1000(10000) (pulse)	5	-	✓	-
	P018	Orientation completion delay time setting	0.00-9.99(s)	0.00	-	✓	-
	P019	Electronic gear position Selection	00(Feedback)/01(Reference)	00	-	✓	-
	P020	Electronic gear numerator of ratio setting	1..9999.	1.	-	✓	-
	P021	Electronic gear denominator of ratio setting	1..9999.	1.	-	✓	-
	P022	Position control feed-forward gain setting	0.00-99.99/100.0-655.3	0.00	-	✓	-
	P023	Position control loop gain setting	0.00-99.99/100.0	0.50	-	✓	-
	P025	Compensation of secondary resistor selection	00(Invalid)/01(Valid)	00	-	✓	-
	P026	Over-speed detect level setting	0.00-99.99/100.0-150.0(%)	135.0	-	✓	-
	P027	Speed-error over detect level setting	0.00-99.99/100.0-120.0(Hz)	7.50	-	✓	-
	P031	Digital input option input mode selection (Acc/Dec)	00(operator)/01(option1)/02(option2)	00	-	-	-
P032	Stop position setting for orientation input mode selection	00(operator)/01(option1)/02(option2)	00	-	✓	-	
User selection	U001	User1 selection	no/d001-P032	no	-	✓	4-60
	U002	User2 selection	no/d001-P032	no	-	✓	4-60
	U003	User3 selection	no/d001-P032	no	-	✓	4-60
	U004	User4 selection	no/d001-P032	no	-	✓	4-60
	U005	User5 selection	no/d001-P032	no	-	✓	4-60
	U006	User6 selection	no/d001-P032	no	-	✓	4-60
	U007	User7 selection	no/d001-P032	no	-	✓	4-60
	U008	User8 selection	no/d001-P032	no	-	✓	4-60
	U009	User9 selection	no/d001-P032	no	-	✓	4-60
	U010	User10 selection	no/d001-P032	no	-	✓	4-60
	U011	User11 selection	no/d001-P032	no	-	✓	4-60
	U012	User12 selection	no/d001-P032	no	-	✓	4-60

4.3 Explanation of function

4.3.1 Monitor mode

Output frequency monitor

Indication code d001 displays the frequency the inverter outputs.

The data is displayed as follows.

When d001 is displayed, the monitor lamp "Hz" is illuminated.

(Display)

0.00 - 99.99 : Display is in 0.01Hz unit.

100.0 - 400.0 : Display is in 0.1Hz unit.

Relation code

d001: Output frequency
monitor

Output current monitor

Indication code d002 displays the output current value.

The data is displayed as follows.

In case of displaying d002, the monitor lamp "A" is illuminated.

(Display)

0.0 - 999.9 : Display is in 0.1A unit.

Relation code

d002: Output current
monitor

Operation direction monitor

Indication code d003 displays the direction that the inverter output is

Rotating. Forward, reverse or stop.

On operating the inverter (in case of forward or reverse), the RUN lamp will illuminate.

(Display)

F : Forward

o : Stop

r : Reverse

Relation code

d003: Operation direction
monitor

PID feedback monitor

When you select PID function (01) in A071, the inverter displays the feedback value changed by A075 (PID scale).

" Display of monitor part " = " Feedback quantity " x " PID scale "

(Frequency command value) (A075)

(Setting)

A071 : 0.1 (PID is effective)

A075 : 0.01-99.99 (Display is 0.01-99.99 (Set with the 0.01 unit))

Relation code

d004: PID feedback monitor
A071: PID selection
A075: PID scale

(Display)

0.00 - 99.99 : Display is in 0.01 unit.

100.0 - 999.9 : Display is in 0.1 unit.

1000 - 9999 : Display is in 1 unit.

{100 - {999 : Display is in 100 unit.

Multifunctional input monitor

The LED display will monitor the state of the Multifunctional inputs.

Relation code

d005: Multifunctional input monitor

(Example)

FR; input Multifunctional terminal DFL,ES,RST:ON
 Input Multifunctional terminal RR,DFM,AD2,MBS,JOG:OFF

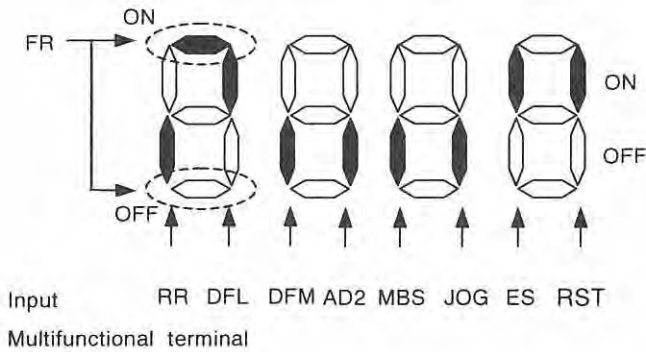

Display

(Black): Lights up

(White): Lights out

Multifunctional output monitor

The LED display will monitor the state of the Multifunctional outputs.

Relation code

d006: Multifunctional output monitor

(Example)

Output Multifunctional terminal DRV,UPF: ON
 Output alarm relay, Output Multifunctional terminal X3,X2, X1: OFF

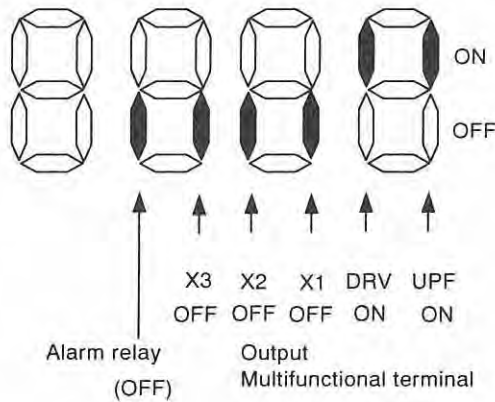

Display

(Black): Lights up

(White): Lights out

Frequency conversion monitor

This inverter displays the value changed by the Inverter output frequency and the value set in b086 on the monitor part.

“Monitor part of display” = “ output frequency(d001)” x “ output frequency factor(b086)”

(Display) Display of d007

- 0.00 - 99.99: Display is in 0.01 unit.
- 100.0 - 999.9: Display is in 0.1 unit.
- 100. - 9999.: Display is in 1 unit.
- 1000 - 3996 :Display is in 10 unit.

Relation code

d007: Frequency conversion monitor

b086: Frequency conversion factor

(Range of setting) The setting range of b086

- 0.1 - 99.9 :Set it with the 0.1 unit.

(Example)Output frequency (d001):50.00Hz

When the frequency conversion factor (b086) is 1.1,
the frequency conversion monitor (d007) displays “55.00” as “50 x 1.1 = 55.00”.

Output torque monitor

This inverter displays the output torque estimation value.

The monitor lamp “%” should illuminate while the contents of d012 are displayed.

Display substitutes only at the time of the sensorless vector control, 0Hz domain sensorless vector control and vector control.

(Display)

- 300.0 – 300.0 :Display is in 1% unit.

Relation code

d012: Output torque monitor

Output voltage monitor

This inverter displays the output voltage of the inverter converted into the alternating Voltage.

The monitor lamp “V” should illuminate while the contents of d013 are displayed.

(Display)

- 0.0 – 600.0 :Display is in 0.1V unit.

Relation code

d013: Output voltage monitor

Input electric power monitor

Display input electric power from inverter.

The monitor lamp “kw” (“V” and “A”) should illuminate while the contents of d014 is displayed.

(Display)

- 0.0 – 999.9 :Display is in 0.1kw unit.

Relation code

d014: Input electric power monitor

Accumulated time monitor on RUN

The operation time of inverter is accumulated and the value is displayed.

(Display)

- 0. - 9999. : Display is in 1 hour units.
- 1000 - 9999 : Display is in 10 hour units.
- {100 - {999 : Display is in 1000 hour units.

Relation code

d016: Accumulated time monitor on RUN

Power ON time monitor

This accumulates the time running to the inverter and displays the value.

(Display)

- 0. - 9999. : Display is in 1 hour units.
- 1000 - 9999 : Display is in 10 hour units.
- {100 - {999 : Display is in 1000 hour units.

Relation code

d017: Power ON time monitor

Trip time monitor

This displays the number of inverter trips.

(Display)

- 0. - 9999. : Display is in 1 times unit.
- 1000 - 6553 : Display is in 10 times unit.

Relation code

d080: Trip time monitor

Error history 1-6

This displays the details for the last six protective trips.

The Error history 1 displayed the details of the last trip.

(Display contents)

- [1] Trip Code (Display anything from E01 to E79.)(Notes 1)
- [2] Output frequency on tripping (Hz)
- [3] Output current on tripping (A)
- [4] The direct voltage (between P and N) on tripping (V)
- [5] The accumulated time inverter was operating until tripping (h)
- [6] The accumulated time inverter was run until tripping (h)

(Note 1) Please refer to the pages 4.4 Protection function list (2) Trip monitor display.

Relation code

d081: Error history 1
d082: Error history 2
d083: Error history 3
d084: Error history 4
d085: Error history 5
d086: Error history 6

The methods of trip monitor

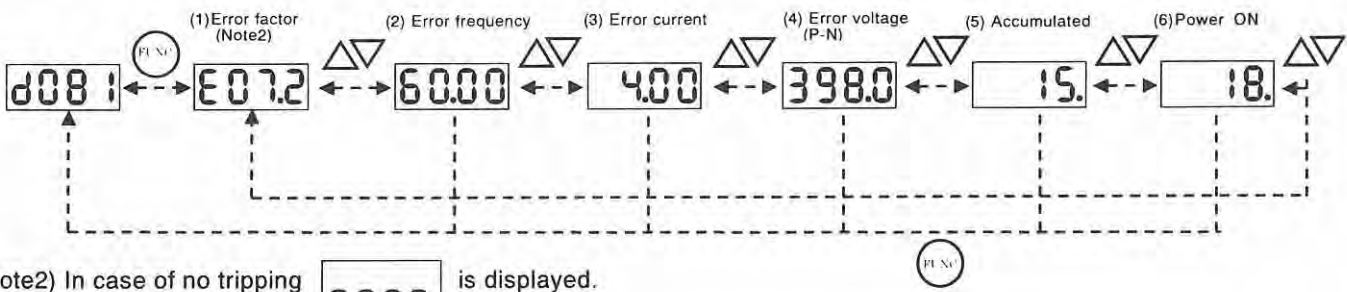

(Note2) In case of no tripping [---] is displayed.

4.3.2 Function mode

Output frequency setting

Setting the output frequency of the motor.

The output frequency is set by F001, when the frequency command select (A001) is set to 02.

Please refer to the frequency command select (A001) about other methods of frequency setting.

When a frequency is set in F001, the same value is automatically set in multistage speed zero (A020).

Set up with F001 in the condition where turned on the BMD terminal, whether or not it sets up with the B mode multistage speed zero (A220)/ C mode multistage speed zero (A320), in the case that the B/C mode control is set up.

In the case of using BMD/CMD, you will need to assign 08(BMD)/17(CMD) to a Multifunctional input terminal.

Set item	Function code	Data	Contents
Output frequency Setting	F001	0.0, start frequency- Maximum frequency	Unit : Hz "F001" = "A020"
Multistage speed zero	A020/A220/ A320		"F001"(B mode) = "A220" "F001"(C mode) = "A320"

Relation code

F001 :Output frequency setting
A001 :Frequency command select
A020/A220/A320: multistage speed zero
C001-C008: Multifunctional input terminal

Operation direction

This is effective when the operating command is set by the digital operator.

Function code	Data	Contents
F004	00	Forward
	01	Reverse

Relation code

F004: Operation direction select

Selection with limits of operation direction

The direction of the motor can be restricted.

Function code	Data	Contents
b035	00	Forward/reverse is Effective.
	01	Only forward
	02	Only reverse

Relation code

b035: Selection with limits of operation direction

Frequency command selection

Select the method of frequency command.

When 0-10Vdc is inputted to the frequency command by VRF2-COM terminal, operation direction of motor reverses. On output frequency monitor d001, you can't get information about forward/reverse. So be sure with operation direction monitor d002.

Relation code

A001:Frequency command selection

Function code	Data	Contents
A001	(00)	(Setting frequency with the potentiometer the digital operator has.)
	01	Setting frequency with control terminals (Terminals: VRF-COM, IRF-COM, VRF2-COM)
	02	Setting frequency with digital operator(F001), remote operator.
	03	Setting frequency with RS485 terminals for communication.
	04	Setting frequency with option board 1.
	05	Setting frequency with option board 2.

Operation command selection

Select the control of RUN/STOP commands.

Operation command from the control terminals (Terminal)

Start/Stop by ON/OFF of control terminals.

Forward : FR-BC terminal

Reverse : RR-BC terminal

Put 01(RR) to an Multifunctional Input terminal.

When using the FR terminal, it is possible to change the contact from NO to NC by setting a or b (respectively) in C019.

When operating from the digital operator, set operation direction in F004.

Or operate Start/Stop with RUN key/STOP key on the digital operator.

When forward command and reverse command entered simultaneously, operation command becomes stop command .

Relation code

A002 :Operation command selection
 C001-C008 : Multifunctional input terminal
 C019 :Inputting FR a/b (NO/NC) selection
 F004 :Operation direction select

Setting item	Function code	Data	Contents
Operation command selection	A002	01	Start/Stop with control terminals(Terminal).(FR, RR)
		02	Start/Stop with digital operator, remote operator.
		03	Start/Stop with RS485 terminals for communications.
		04	Start/Stop with option board 1.
		05	Start/Stop with option board 2.
Input FR a/b (NO/NC) selection	C019	00	a contact (NO)
	C011-C018	01	b contact (NC)

Selection on stop

When stop is commanded from the digital operator or the control terminals (Terminal), select the stop after slowing-down according to slowing-down time or the free run stop.

When the second cycle is started while in free run stop, the inverter follows the free-run stop selection b088 and restarts.

(Refer to the item of free-run stop.)

Relation code

b091 :Selection on stop
 F003/F203/F303: deceleration time
 b003 :Waiting time for retrying
 b007 :Frequency setting to match
 b088 :Select for free-run stop

Setting item	Function code	Data	Contents
Selection on Stop	b091	00	Normal stop (Decelerated stop)
		01	Free-run stop
Selection of free-run stop	b088	00	0Hz start
		01	Start frequency matching
Frequency setting to match	b007	0.00-400.0	Unit : Hz
Waiting time for retrying	b003	0.3-100.	Unit : second

Selection of Stop key

Even though the control terminals are selected for the operation command, you can still set whether the stop key of operator (digital operator etc) is effective or not. Trip reset function by the stop key complies with this setting, too.

Function code	Data	Contents
b087	00	The stop key is effective.
	01	The stop key is ineffective.

Relation code

b087: Selection of stop key

Adjustable time

The acceleration and deceleration time can be set. Set a long time to accelerate or decelerate slowly or set a short time to accelerate or decelerate quickly.

The time setting is the time it takes to accelerate from zero to the maximum frequency and to decelerate from the maximum frequency to zero.

Switching of the acceleration time and the deceleration time can be controlled with multifunctional input terminal assigned to 08 (BMD).

When select the LAD cancel (LAC) function to Multifunctional input and turn on the signal acceleration/deceleration time is disregarded and the output frequency flatters the command frequency instantaneously.

Relation code

F002/F202/F302: Acceleration time
 F003/F203/F303: Deceleration time
 A004/A204/A304: maximum frequency
 C001-C008: Multifunctional input selection

Set item	Function code	Limit of setting	Contents
Acceleration time	F002/F202/F302	0.01-3600.	Unit : second Setting acceleration time from zero to maximum frequency.
Deceleration time	F003/F203/F303	0.01-3600.	Unit : second Setting deceleration time from maximum frequency to zero.
Multifunctional input selection	C001-C008	46	LAD cancel

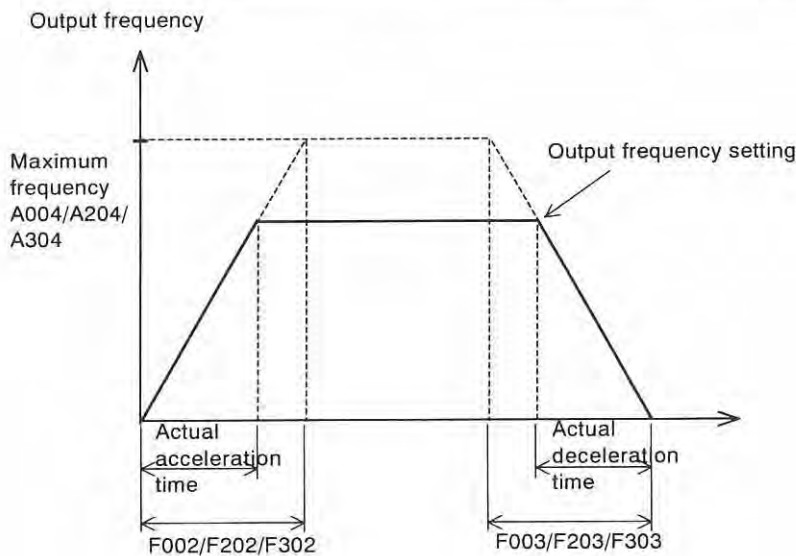

Base frequency and motor voltage

Base frequency and motor voltage
AVR function

Relation code

A003/A203/A303: base frequency
A081: AVR selection
A082: Motor voltage selection

(1) Base frequency and motor voltage

On selection of base frequency and motor voltage, set the output of the inverter (frequency voltage) to the motor rating.

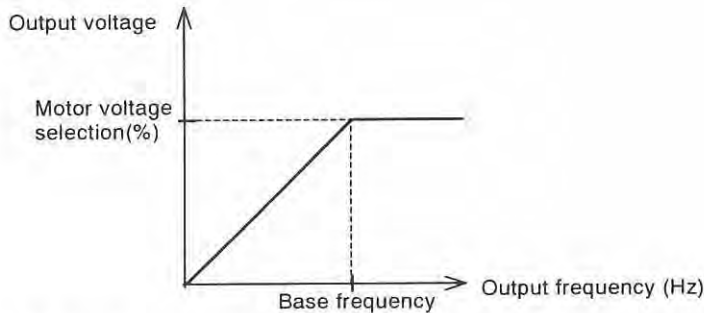

The Base frequency is the nominal frequency of the motor, this value can be found on the nameplate of the motor. It is important to match the Base frequency (A003) to this nominal value or there is risk of damage to the motor.

If a motor has a base frequency higher than 60Hz, it is considered to be a special motor. In this situation, it is important to make sure the maximum output current of the inverter is higher than the FLC of the motor.

The Motor Voltage Selection is the nominal voltage of the motor, this value can be found on the nameplate of the motor. It is important to match the Motor Voltage (A082) to this nominal value or there is risk of damage to the motor.

When changing B mode base frequency (A203) / C mode base frequency(A303) an Multifunctional input terminal must be set to 08(BMD) / 17(CMD) and switched on.

Setting item	Function code	Setting limit	Contents
Base frequency	A003/A203 A303	30.-maximum frequency	Unit:Hz
Motor voltage selection	A082	200/215/220/230/240	Unit:V When inverter is 200V class, selection is possible.
		380/400/415/440/460/480	Unit:V When inverter is 400V class, selection is possible.

(2) AVR function

Even if the incoming voltage changes, this function will keep the output voltage and a constant voltage level. The output voltage to the motor in this function references to the voltage selected on motor voltage selection. Select Yes/No of this function on A081 AVR selection.

Function code	Data	Contents	Description
A081	00	Always ON	This function is effective on acceleration, constant speed, deceleration.
	01	Always OFF	This function is ineffective on acceleration, constant speed, deceleration.
	02	On decelerating OFF	This increases a loss of motor and reduces the energy regenerated to inverter on decelerating.

Maximum frequency

Set the maximum frequency value of the inverter.

This set value is the maximum frequency that the inverter will achieve when it receives top speed reference from the control terminals or the digital operator.

To change the maximum frequency, set a Multifunctional input terminal to 08(BMD)/17(CMD) and switch the input ON.

The inverter output voltage from the base frequency to the maximum frequency is the same level as the voltage selected on the motor voltage selection.

Relation code
A004/A204/A304:
maximum frequency

Function code	Limit of setting	Contents
A004/A204 A304	30.-400.	Unit : Hz

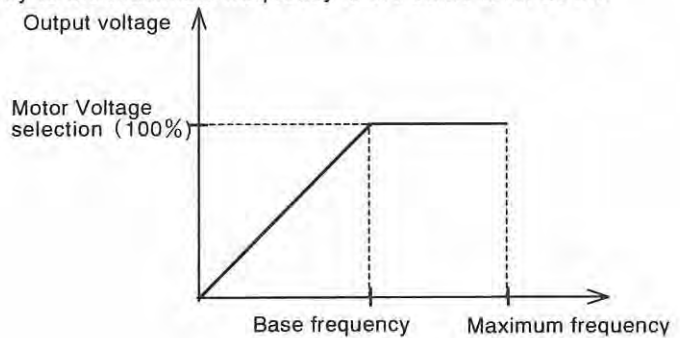

Carrier frequency

The carrier frequency of the PWM wave-form output from the inverter is adjustable by changing b083.

If the carrier frequency is set higher, the audible noise from motor will be reduced but the RFI noise and the leakage current may be increased.

This function may help to avoid the resonant frequency of the motor or the mechanical system.

Relation code
b083:Carrier frequency

Function code	Limit of setting	Contents
b083	0.5-15.0 (Note1)	Unit:kHz

(Note1) The maximum value of the carrier frequency in order to achieve full output current is different depending on the capacity. When raising the carrier frequency, the rated output current will be reduced.

Voltage class	200V class		400V class	
	Maximum carrier frequency	Derating on carrier frequency = 15kHz	Maximum carrier frequency	Derating on carrier frequency = 15kHz
5.5kW	15	100%	15	100%
7.5kW	15	100%	15	100%
11kW	15	100%	15	100%
15kW	12	95% (below 60.8A)	15	100%
22kW	5	65% (below 61.8A)	6	80% (below 38.4A)
30kW	5	80% (below 96.8A)	10	75% (below 43.5A)
37kW	10	90% (below 130.5A)	10	95% (below 71.2A)
45kW	7	70% (below 127.4A)	10	80% (below 72A)
55kW	6	70% (below 154A)	6	60% (below 66A)

⚠ CAUTION

: Be sure to keep the above-mentioned table. Otherwise, there is a danger of inverter unit breakage.

Chapter4 Explanation of function

External analog input (VRF, VRF2, IRF)

This inverter has three kinds of external analog output terminals.

- VRF - COM terminal : 0 - 10V
- IRF - COM terminal : 4 - 20mA
- VRF2- COM terminal : -10 / 0 / +10V

Relation code
A005: AUT terminal selection
A006: VRF2 Selection
C001-C008: Multifunctional input terminal

The setting contents of this function is as follows.

Setting item	Function code	Data	Contents
AUT terminal Selection	A005	00	Change of VRF/IRF with AUT terminal (AUT terminal ON : IRF -COM valid AUT terminal OFF: VRF-COM valid)
		01	Change of VRF/VRF2 with AUT terminal (AUT terminal ON : VRF2-COM valid AUT terminal OFF: VRF-COM valid)
VRF2 selection	A006	00	Single
		01	Auxiliary frequency command of VRF, IRF(No reverse)
		02	Auxiliary frequency command of VRF, IRF(Reverse)

Assign 16(AUT) to Multifunctional input terminal.

The frequency setting is the values from terminals VRF, IRF and VRF2 when 16(AUT) isn't assigned. The frequency set up when A006 is "00" becomes the value of VRF2. And, the frequency set up when A006 is "01" or "02" becomes the value which IRF and VRF2 were added to.

The following frequency command methods are available by combining A005, A006 with the Multifunctional output at terminal.

In the case that reverse and FR(forward) terminals are ON, the inverter operates reversely when (main frequency command + auxiliary frequency command) < 0.

	A006	A005	AUT Terminal	Main frequency command	Existence of Auxiliary frequency command (VRF2-COM)	Existence of Reverse
Multifunctional input terminal on assigning AUT	00	00	OFF	VRF-COM	No	No
			ON	IRF-COM	No	
		01	OFF	VRF-COM	No	
			ON	VRF2-COM	No	
	01	00 (Example1)	OFF	VRF-COM	Yes	No
			ON	IRF-COM	Yes	
		01	OFF	VRF-COM	Yes	
			ON	VRF2-COM	No	
02	00 (Example2)	OFF	VRF-COM	Yes	Yes	
		ON	IRF-COM	Yes		
	01	OFF	VRF-COM	Yes		
		ON	VRF2-COM	No		
Multifunctional input Terminal when Don't assign AUT	00	-	-	VRF2-COM	No	Yes
	01	-	-	Adding VRF-COM and IRF-COM	Yes	No
	02	-	-	Adding VRF-COM and IRF-COM	Yes	Yes

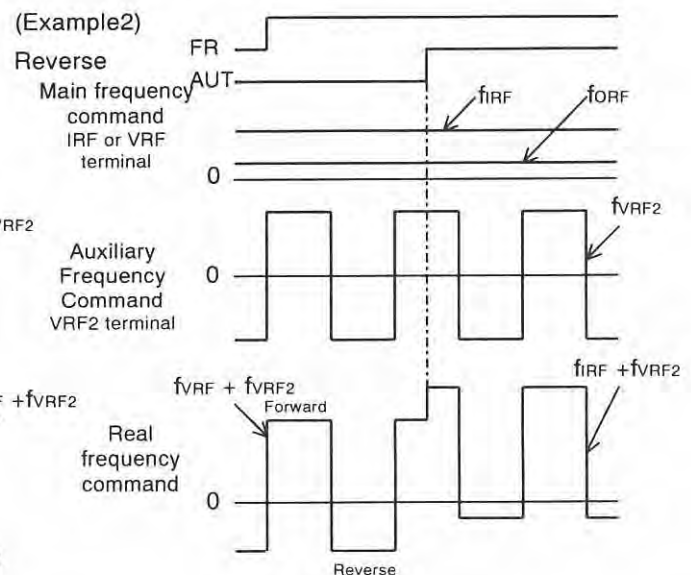
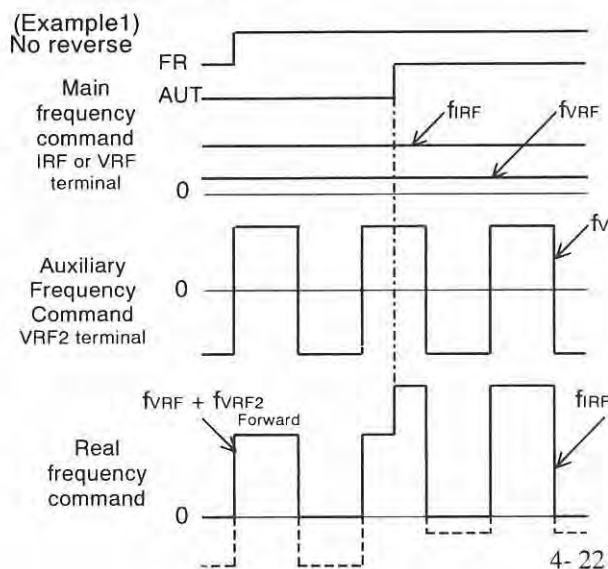

Input Frequency Start/End

External analog signal from the control terminals
(frequency command)

- VRF-COM terminal : 0 - 10V
- IRF-COM terminal : 4 - 20mA
- VRF2-COM terminal : -10 / 0 / +10V

Set output frequency for one of the above

(1) Start, End of VRF-COM terminal, IRF-COM terminal

Relation code

- | | |
|---------------------------|---------------------------|
| A011: VRF start | A103: IRF start rate |
| A012: VRF end | A104: IRF end rate |
| A013: VRF start rate | A105: IRF start selection |
| A014: VRF end rate | A111: VRF2 start |
| A015: VRF start selection | A112: VRF2 end |
| A101: IRF start | A113: VRF2 start rate |
| | A114: VRF2 end rate |

Set item	Function code	Data	Contents
VRF/IRF start	A011/A101	0.00-400.0	Unit : Hz Set starting frequency
VRF/IRF end	A012/A102	0.00-400.0	Unit : Hz Set ending frequency
VRF/IRF start rate	A013/A103	0.-100.	Unit : % Set start rate for output frequency command 0-10V, 4-20mA
VRF/IRF end rate	A014/A104	0.-100.	Unit : % Set end rate for output frequency command 0-10V, 4-20mA
VRF/IRF start Selection	A015/A105	00	External start frequency Output frequency from 0 to A013/A103 outputs the value of A011/A101
		01	0Hz Output frequency from 0 to A013/A103 outputs the value of 0Hz

When the input is from 0 to 5V with VRF-COM terminal, set A014 to 50%.

(Example 1) A015/A105 : 00

(Example 2) A015/A105 : 01

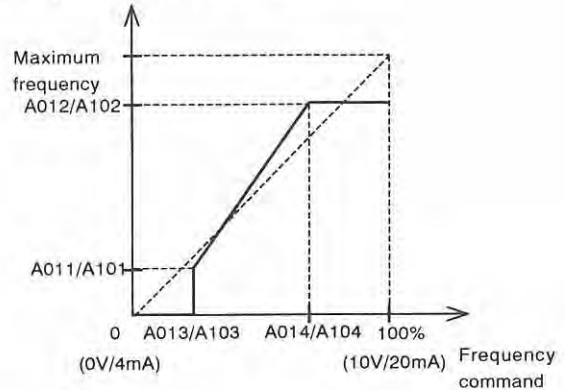
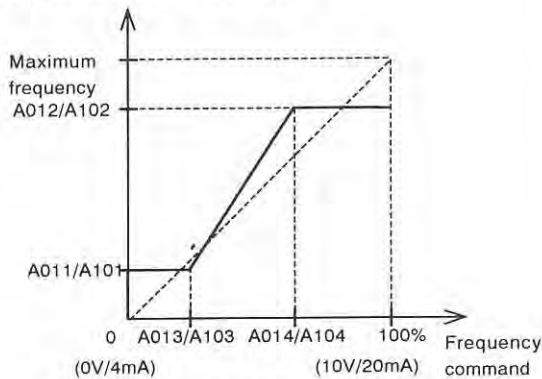

(2) Start, End of VRF2-COM terminal

Set item	Function code	Data	Contents	Notes
VRF2 start	A111	-400.-400.	Unit : Hz Set starting frequency	(Example 3)
VRF2 end	A112	-400.-400.	Unit : Hz Set ending frequency	
VRF2 start rate	A113	-100.-100.	Unit : % Set starting rate for output frequency command -10-10V (Notes)	
VRF2 end rate	A114	-100.-100.	Unit : % Set ending rate for output frequency command -10-10V(Notes)	

(Notes) The rates of -10V-10V is following.

-10V- 0V:-100-0%

0V-10V:0-100%

For example, in case of use with VRF2-COM terminal, set -50% to A113,

50% to A114.

(Example 3)

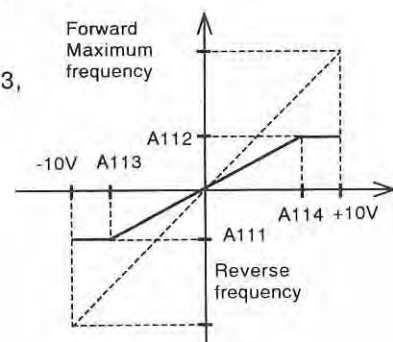

Setting analog input filter

Set the internal filter of the frequency setting signal of voltage or current from the control terminals

It is important to first remove the source of the noise to the system.

When stable operation can not be achieved due to the effect of electrical noise, set a larger value.

The response will be slower by setting a larger value. The limit of setting is about 10ms-60ms(set value : 1-30)

Relation code
A016: VRF, IRF, VRF2 filter

Function code	Limit to set	Contents
A016	1.-30.	Can set with the 1 unit.

Output voltage gain

Regarding the voltage selected on A082 motor voltage selection as 100 %, set the rate of the voltage which the inverter outputs for the voltage selected.

Relation code
A045: Output voltage gain
A082: Motor voltage selection

Function code	Limit to set	Contents
A045	20.-100.	Unit:%

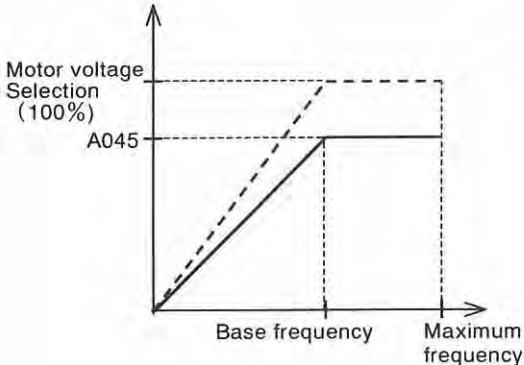

Control system (V/f Characteristic)

Set V/f (output voltage/output frequency) characteristic.
 To change control system (V/f characteristic), set 08(BMD) / 17(CMD) to an Multifunctional input terminal and switch it ON.

Relation code

A044/A244/A344: control system
 b100/b102/b104/b106/b108/b110/b112
 : Free setting V/f frequency 1/2/3/4/5/6/7
 b101/b103/b105/b107/b109/b111/b113
 : Free setting V/f voltage 1/2/3/4/5/6/7

Function code	Data	V/f characteristic	remarks
A044/A244/ A344	00	Constant torque characteristic(VC)	-
	01	Reduced torque characteristic(VP1.7power)	-
	02	Free setting V/f characteristic	only A044/A244
	03	Sensorless vector control	only A044/A244
	04	0Hz domain Sensorless vector control	only A044/A244
	05	Sensoring vector control (V2)	only A044

(1) Constant torque characteristic (VC)

Output voltage outputs proportionally to the output frequency.

Output voltage outputs proportionally from 0 to the base frequency, but the output voltage from the base frequency to the maximum frequency is constant regardless of frequency.

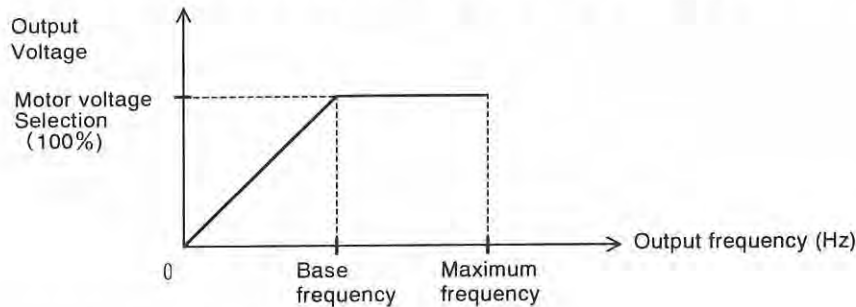

(2) Reduced torque characteristic (VP1.7 power)

This characteristic can be used when a large starting torque isn't required.

At low speeds, it can cause improvement of efficiency, low noise and low vibration because of lowering the output voltage. V/f characteristic is as follows.

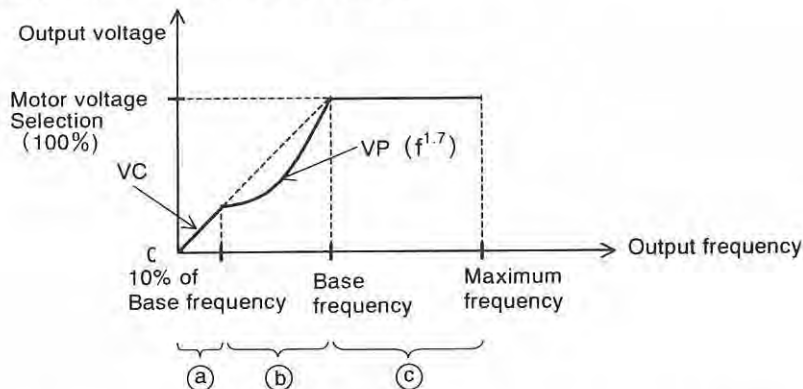

Period (a) :The limit from 0 to 10% of basic frequency is the constant characteristic.

(Example) If the base frequency is 60Hz, the limit from 0 to 6Hz is constant characteristic.

Period (b) :The limit from 10% of base frequency to base frequency is reduced torque characteristic.

The voltage is output in the curve of 1.7 power for frequency.

Period (c) :The voltage is constant from the base frequency to the maximum frequency.

Torque boost

A correctly installed motor and careful attention to voltage drop in the wiring will improve the motor torque at low speed. Setting of A041/A241 will select between manual torque boost and automatic torque boost, the level of torque boost corresponds to the set motor capacity selection (H003/H203) and the motor pole selection (H004/H204).

Relation code	
A041/A241	: torque boost selection
A042/A242/A342	: manual operation torque boost
A043/A243/A343	: manual operation torque boost break point
H003/H203	: motor capacity selection
H004/H204	: motor pole selection

Set item	Function code	Data	Contents
Torque boost	A041/A241	00	Manual torque boost
		01	Automatic torque boost
Manual torque boost	A042/A242/A342	0.0-20.0	Unit:% Level corresponding to output Voltage (100%)
Manual torque boost break point	A043/A243/A343	0.0-50.0	Unit:% Level corresponding to base frequency

(1) Manual torque boost

The values set up with A042/A242/A342 and A043/A243/A343 is outputted.

A042/A242/A342 sets a percentage level where the base frequency voltage is 100%.

The level set is the value of torque boost output voltage at 0 Hz.

When using the manual torque boost, it should be noted that overuse will cause saturation of the motor and may cause damage.

The manual torque boost break point is the frequency at which the voltage torque boost is switched off and normal operation resumes.

To change of A041,A042,A043/ A241,A242,A343/A342,A343 an multifunctional input needs to be set to 08(BMD)/17(CMD) and switched on.

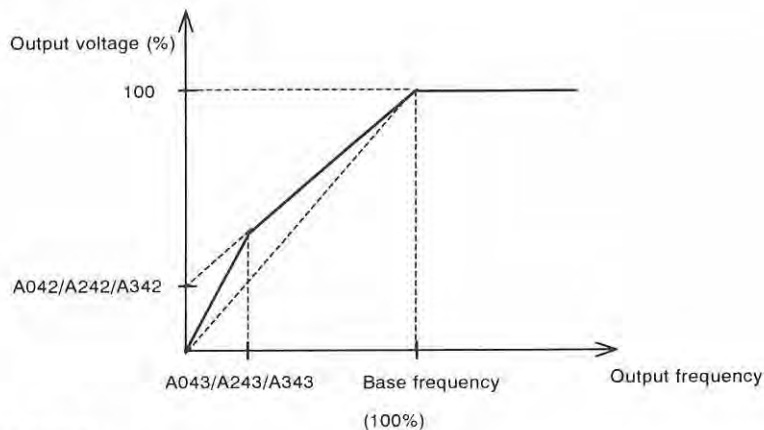

(2) Automatic torque boost

The output voltage is adjusted automatically by the condition of the load.

When using automatic torque boost it is important that the following two parameters are set correctly.

In case of adding over-current protection at deceleration time, set AVR selection ON all the time.

Set item	Function code	Setting limit	Contents
Motor capacity selection	H003/H203	0.20-75.0	Unit : kW
Motor pole selection	H004/H204	2/4/6/8	Unit : pole

Direct current braking(DB)

A DC voltage can be applied to the motor windings in order to lock the motor shaft and avoid overrun at low speeds.

There are two methods of activating the DC braking, Outside which is through the multifunctional input terminals and Inside which is automatically started at a specific frequency.

Relation code

A051: DC braking selection	A056: DC braking edge/level selection
A052: DC braking frequency	A057: Starting DC braking power
A053: DC braking late time	A058: Starting DC braking time
A054: DC braking power	A059: DC carrier frequency
A055: DC braking time	C001-C008: multifunctional input terminal

Set item	Functin code	Data	Contents
DC braking selection	A051	00	Inside DC braking : invalid
		01	Inside DC braking : valid
DC braking frequency	A052	0.00-60.00	Unit : Hz When the output reaches the set frequency and Inside DC braking is valid, DC braking is started.
DC braking late time	A053	0.0-5.0	Unit : second After DC braking time is reached, or DB (multifunctional input) terminal is ON, the late time is a delay before DC braking is started.
DC braking power /Starting DC braking power	A054/A057	0. ↓ 100	Unit : % Weak (Zero current) ↑ Strong (Inverter rating fairly 70% the DC current)
DC braking time	A055	0.0-60.0	Unit : second The DC braking is stopped after this time delay has elapsed. The time is tarted when the late time has elapsed.
DC braking edge/level selection	A056	00	Edge movement (Example 1-3-a)
		01	Level movement (Example 1-3-b)
Starting DC braking time	A058	0.0-60.0	Unit : second It is valid for inside DC braking. When operating command is ON, DC current is started.
DC braking carrier Frequency	A059	0.5-15	Unit : kHz

(1) DC braking carrier frequency

It is possible to alter the DC braking carrier frequency. However, if the DC braking carrier frequency is set higher than 5kHz, the value of maximum braking power level is automatically reduced as follows.

Set DC braking carrier frequency with A059.

(2) Outside DC braking

Set 07(DB) to an multifunctional input terminal.

DC braking is then switched by ON/OFF of DB terminal irrespective of DC braking selection A051.

Set strength of DC braking power with A054.

If DC braking late time A053 is set, the Inverter output is cut off for this time period, the motor will be free running.

After the late time passes, DC braking is started.

Please set DC braking time A055 or DC braking time by DB terminal paying attention to the heat of the motor.

Please set each setting in accordance with the system, after level action or edge action are selected with A056.

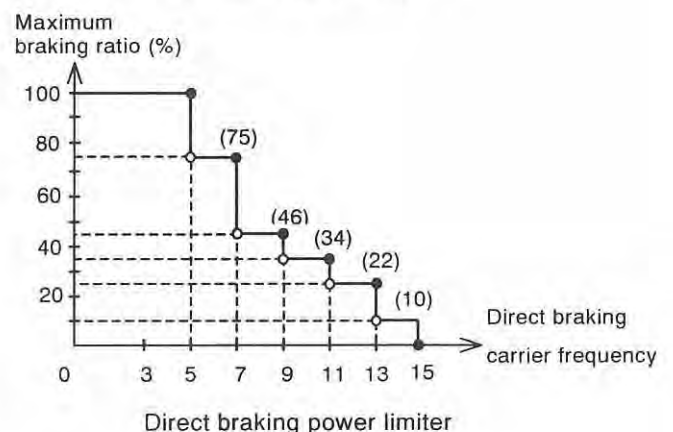

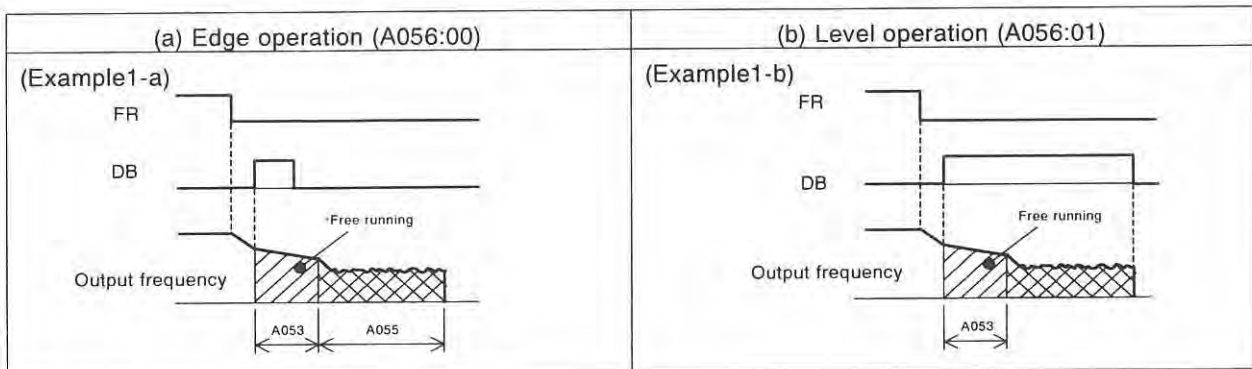

(3) Inside DC braking

When the inverter starts, and the DB terminal is not ON the inverter can operate DC braking.

When using inside DC braking, the DC braking selection A051 should be set 01.

Starting DC braking power is set with A057, DC braking time at starting is set with A058.

Braking power setting except starting time, set with A054.

If DC braking late time A053 is set and the DC braking frequency is reached, the operating command (FR) is switched OFF. The inverter cuts the output and for the set time of A053, free running of the motor will occur. After finishing the set time in A053, DC braking is started.

Set the frequency at which the DC braking will operate at with A052.

The operation of Edge/Level selection when using inside DC braking is different.

Edge action: Give priority to A055 DC braking action time, operate DC braking according to set time.

After turning operating command (FR) OFF, when output frequency reaches the set value of A052, during setting A055 DC braking is run. Even if operation command is turned ON, during setting time of A055, DC braking is run. (Example 5-a), (Example 6-a)

Level action: Give priority to operating command, ignore DC braking time A055 and move to normal operation. When operation command is turned ON during DC braking, set time of A055 is ignored and normal operation is restored. (Example 5-b), (Example 6-b)

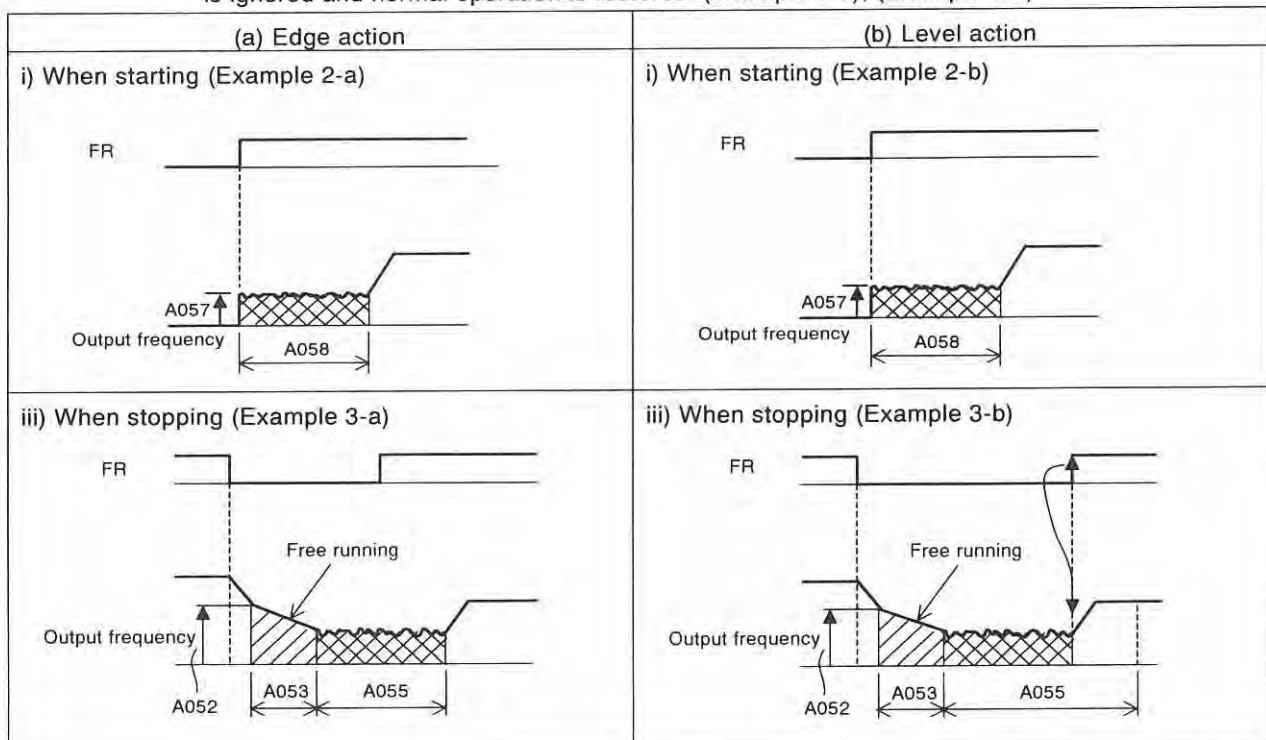

Frequency limiter

This function can set a maximum and minimum limit of the output frequency. Even if a frequency command exceeds the maximum and minimum limiter the inverter will ignore this value and stop at the values set.

Set first maximum limiter on setting.

Be sure that the maximum limiter (A061/A261) > minimum limiter (A062/A262).

The maximum and minimum limiter will not operate if 0Hz is set.

This function is not available under third control function.

Relation code
A061/A261:frequency maximum limiter
A062/A262:frequency minimum limiter

Set item	Function code	Setting limit	Contents
Frequency max. limiter	A061/A261	0.00, frequency min. limiter - max. limiter frequency	Unit : Hz Setting max. of output frequency
Frequency min. limiter	A062/A262	0.00, starting frequency - max. limiter frequency	Unit : Hz Setting min. of output frequency

(1) In use VRF-COM, IRF-COM case

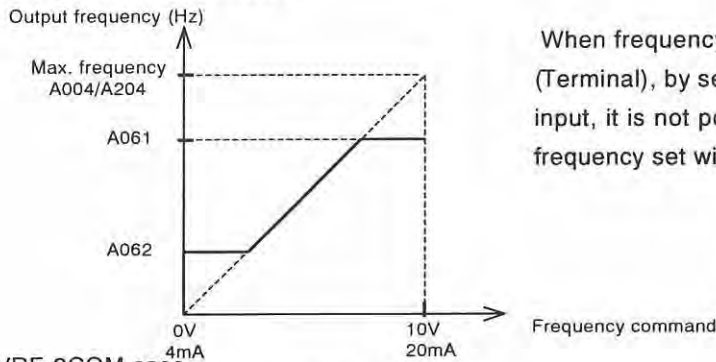

(2) In use VRF-2COM case

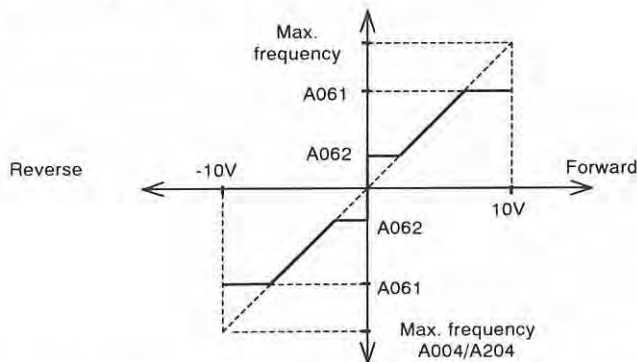

When using the minimum frequency limiter and 0v is inputted into VRF2 terminal, A062 applies to both forward and reverse directions.

(a) When operation command is control terminal (Terminal)(A002:01)

Terminal	Revolution when VRF2 is 0V
FR(ON)	A062 on forward side
RR(ON)	A062 on reverse side

(b) When operation command is operator (A002:02)

F004	Revolution when VRF2 is 0V
00	A062 on forward side
01	A062 on reverse side

Frequency Jump Function

Frequency jump can be used to avoid resonance points on machinery.
 Frequency jump is to jump the frequency command and avoid usual operation within the limit of the jump frequency.
 Output frequency changes continuously according to adjustable time.
 It is possible three different points are set for the jump frequency.

- Relation code
- A063: Jump frequency1
 - A064: Jump frequency band1
 - A065: Jump frequency2
 - A066: Jump frequency band2
 - A067: Jump frequency 3
 - A068: Jump frequency band3

Set item	Function code	Setting limit	Contents
Jump frequency 1/2/3	A063/A065/A067	0.00-400.0	Unit: Hz Set the frequency f_j of center to jump.(Note)
Jump Width 1/2/3	A064/A066/A068	0.00-10.00	Unit:Hz Set 1/2 value of frequency band to jump (Note)

(Note) The frequency to jump is $f_j + 2$ (Hz).

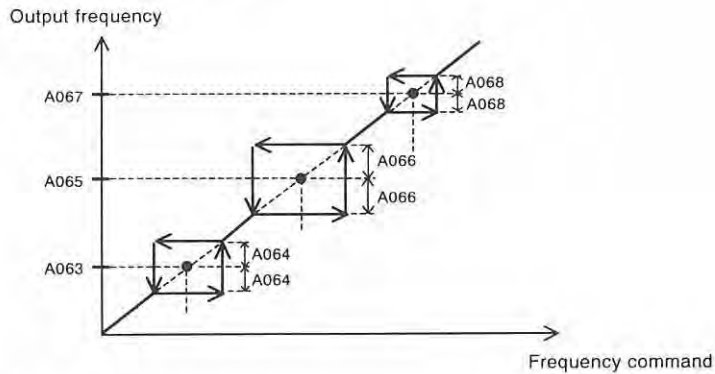

Acceleration stop function

When the inertial moment of a load is high, this is the function to wait until the slip of the motor on starting becomes smaller.
 Use when the overcurrent trip occurs on starting.

- Relation code
- A069: Acceleration stop frequency
 - A070: Acceleration stop time

Set item	Function code	Data	Contents
Acceleration stop frequency	A069	0.00-400.0	Unit: Hz Set the frequency to be held.
Acceleration stop time	A070	0.0-60.0	Unit: second Set the time to hold the frequency.

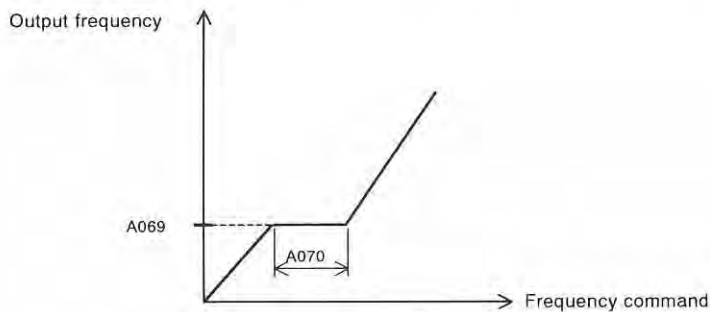

Chapter 4 Explanation of function

PID Function

This integrated process control function can be used for controls such as constant flow and control for fan and pump applications. When using this function set A071 to 01. Turn off the terminal in the case that you validate this function or turn on the terminal in the case that you invalidate this function after assigned 23 (PID valid/invalid) to multifunctional input terminal in the case of switching valid/invalid of this function with the outside signal.

Set item	Function code	Data	Contents
PID selection	A071	00	Invalid
		01	Valid
PID P gain	A072	0.2-5.0	Proportional gain
PID I gain	A073	0.0-3600.	Integration Gain Unit: seconds
PID D gain	A074	0.00-100.0	Derivative gain Unit: seconds
PID scale	A075	0.01-99.99	Unit :Times
PID feedback selection	A076	00	IRF-COM:4-20mA
		01	VRF-COM :0-10V
Maximum PID Deviation level	C044	0.0-100.0	Unit :%

- Relation code

 - A001 :Frequency command selection
 - A005 :AT selection
 - A071 :PID selection
 - A072 :PID P gain
 - A073 :PID I gain
 - A074 :PID D gain
 - A075 :PID scale
 - A076 :PID feedback selection
 - d004 :PID feedback monitor
 - C001-C008:multifunctional input terminal
 - 0021-C025:multifunctional output terminal
 - C044 :PID deviation setting level

(1) Feedback selection

Select which analogue input terminals will be the feedback reference (A076).

Set the set frequency command selection with A001. (It should not be the same as the terminals selected with A076). Or when the control terminal 01 is set with A001, the setting of AT selection A005 is invalid.

The contents changes when VRF2 is selected with A006.

(2) Basic operation of PID control

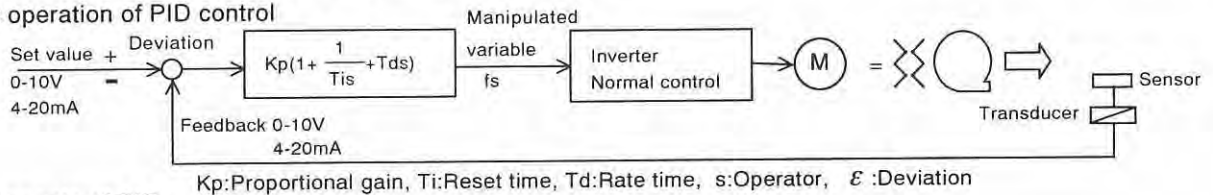

(3) Components of PID

[1] P action This is the action that the manipulated variable is in proportion to the command.

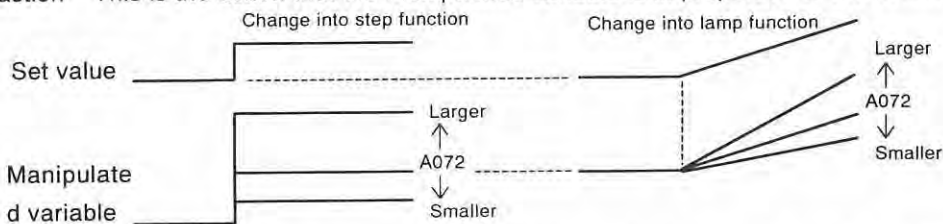

[2] I action This is the action that the manipulated variable increases with time in a straight line.

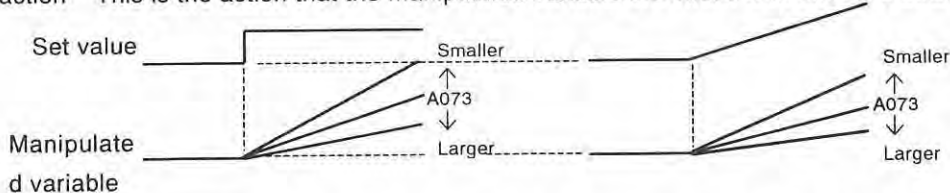

[3] D action This is the action that the manipulated variable is in proportion to the changing rate of command.

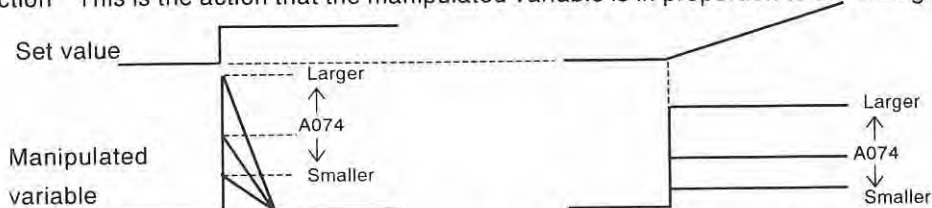

PI action combines above [1] and [2], PD action does [1] and [3], PID action does [1], [2] and [3].

(4) The adjustment of gain

Please adjust each gain according to the state as the following, when the response on the functional operation PID is not stable.

In spite of changing command, the change of feedback signal is slow. \longrightarrow Raise P gain.

The feedback signal changes instantly but is not stable. \longleftarrow Lower P gain.

The command and feedback signal doesn't coincide instantly. \longleftarrow Lower I gain.

The feedback signal oscillates and is not stable. \longleftarrow Raise I gain.

In spite of raising of P gain, the response is slow. \longleftarrow Raise D gain.

When P gain is raised, the feedback signal oscillates and is not stable. \longleftarrow Lower D gain.

(5) The Maximum PID Deviation Level/Output

It is possible to establish the maximum deviation level C044 on PID control. When the PID deviation amount reaches the set level C044, it is possible to set an multifunctional output.

C044 can be set from 0 to 100 and corresponds with the command; from 0 to maximum.

Assign 04 (OD) to multifunctional output terminal 11-15(C021-C025).

(6) Feedback monitor of PID

Feedback signal of PID can be monitored.

The monitor value can be displayed by the product of PID scale A075.

"Monitor display" = "Feedback (%)" x "A075 setting"

(7) PID integral reset

This is the function to clear integral value of PID action.

Assign 24(PIDC) to multifunctional input terminal.

It is cleared whenever PIDC is turned ON.

Don't turn absolutely ON PID terminal during PID action, because there is a possibility of overcurrent trip.

Turn ON PIDC terminal after turning OFF PID action.

Automatic energy-saving operation function

This function regulates the inverter output power automatically to a minimum while operating at constant speed.

This fits for the load of reduced torque characteristic of fans or pumps.

In case of operating by this function, set A085 to "01".

A086 can adjust the automatic operation, response time.

Relation code

A085: Operation mode selection

A086: Energy-saving response-

Accuracy adjustment

Set item	Function code	Data	Contents
Operation mode selection	A085	00	Normal operation
		01	Energy-saving operation

Set item	Function code	Data	Response	Accuracy
Energy saving Response / accuracy Adjustment	A086	0	Slow	High
		100	Fast	Low

2nd Stage Acceleration and Deceleration Function

By setting this function, it is possible to change the rate of acceleration and deceleration.

As methods to change the rate of acceleration and deceleration, you can select the method of changing by multifunctional input terminal and the method of automatic changing by optional frequency.

In case of changing by multifunctional input terminal, assign 09(AD2) to an Intelligent input terminal.

Relation code

F002/F202/F302: acceleration time 1

F003/F203/F303: deceleration time 1

A092/A292/A392: acceleration time 2

A093/A293/A393: deceleration time 2

A094/A294: 2nd-stage acceleration
and deceleration selection

A095/A295: 2nd-stage acceleration
frequency

A096/A296: 2nd-stage deceleration
frequency

C001-C008: multifunctional input terminal

Set item	Function code	Data	Contents
Acceleration time 2	A092/A292/A392	0.01-3600.	Unit : second (Example1,2)
Deceleration time 2	A093/A293/A393	0.01-3600.	Unit : second (Example1,2)
Two-stage acceleration and deceleration selection	A094/A294	00	Changing by multifunctional input terminal 09 (AD2) (Example1)
		01	Changing by two-stage acceleration and deceleration frequency (A095/A295, A096/A296) (Example2)
Two-stage acceleration frequency	A095/A295	0.00-400.0	Unit: Hz It is valid when 2nd-stage acceleration and deceleration selection (A094/A294) is 01. (Example2)
Two-stage deceleration frequency	A096/A296	0.00-400.0	Unit: Hz It is valid when two-stage acceleration and deceleration selection (A094/A294) is 01. (Example2)

(Example1) In to set A094/A294 to 00 case

(Example2) In to set A094/A294 to 01 case

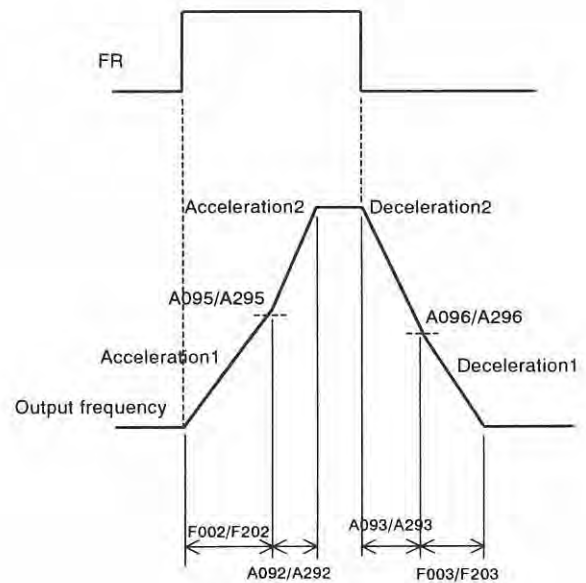
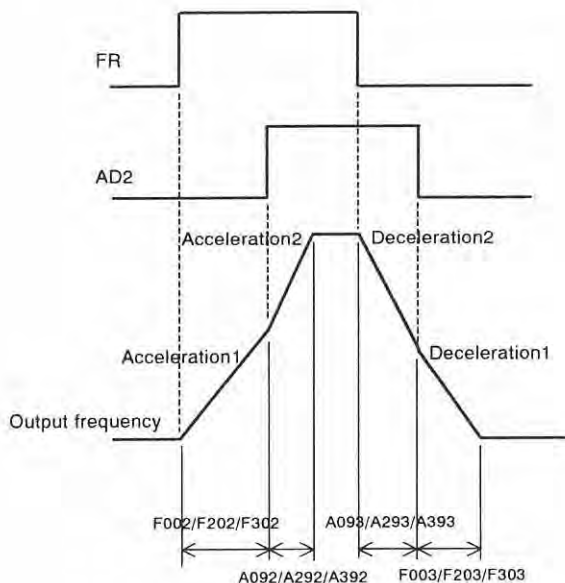

Acceleration and deceleration pattern

(1) Selection of pattern

Pattern of acceleration and deceleration speed is possible to set up corresponding to each system.

Select the pattern of acceleration and deceleration with A097 and A098.

Relation code

- A097: Acceleration pattern selection
- A098: Deceleration pattern selection
- A131: Acceleration curve constant
- A132: Deceleration curve constant

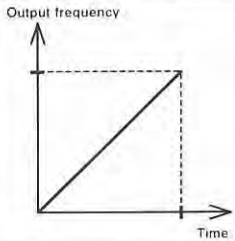
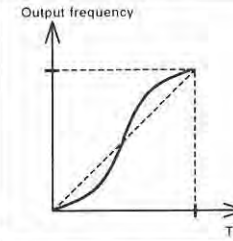
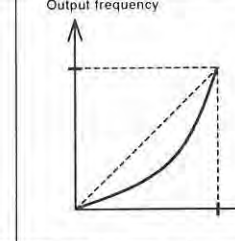
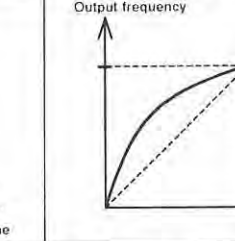
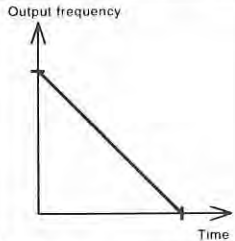
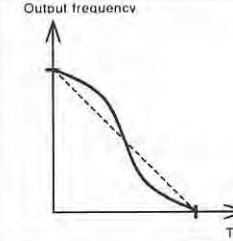
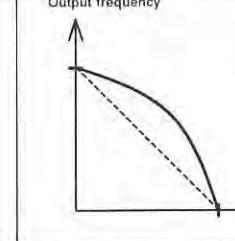
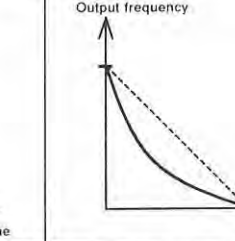
Set value	00	01	02	03
Curve	Line	Sigmoid	U-shape	Reverse U-shape
A097 (Acceleration)				
A098 (Deceleration)				
Contents	Accelerate and decelerate in line until output frequency set value.	Collapsing the cargo such as the going up and down machine, conveyor it uses it for prevention.	Cutting the tension control, rolled book such as the volume collector machine it uses it for prevention.	

It is possible to set the pattern of both acceleration, deceleration.

(2) The curve constant (the swelling degree)

It makes the rough sketch reference and please decide the swelling degreee.

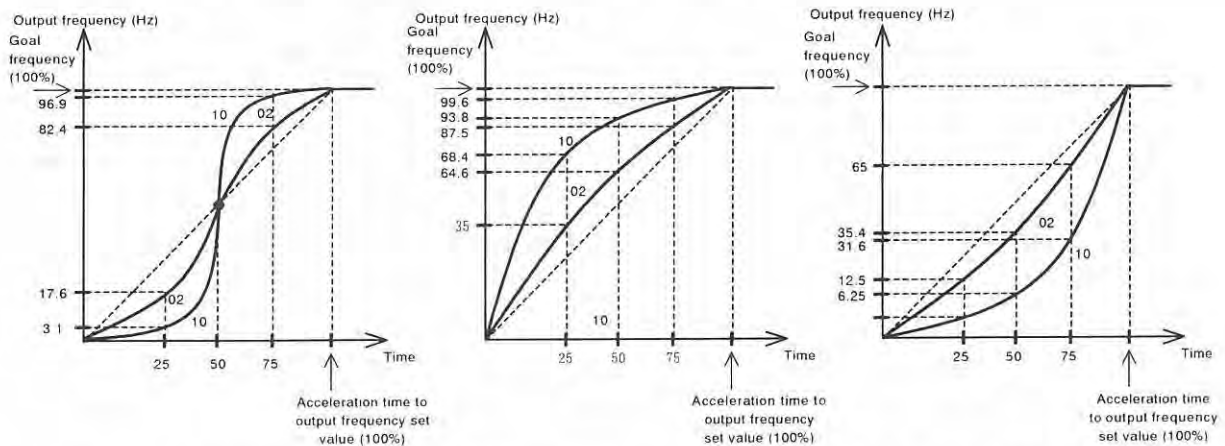

There is the range which the midway adjustable-speed time becomes fast in the S character pattern.

When An multifunctional input terminal is allocated to LAD cancel (LAC) and the terminal is ON, output frequency is immediately controlled by Setup frequency.

Instantaneous power failure / under-voltage

Instantaneous stop and start

(1) You can select whether the inverter trips or retries (restart) when an instantaneous power failure/under-voltage occurs. When retry function is selected with b001, and an instantaneous stop/under-voltage trip occurs restart is tried 16 times and a trip will occur after 17 times.

And when retry function is selected, and an over-current or an over-voltage occurs, restart is tried 3 times and a trip will occur on the fourth time. When an instantaneous power failure/under-voltage occurs, you can select execution of trip with b004. To select a retry function with b001, set the following retry mode correspondent to each system.

Relation
b001 :Retry selection
b002 :Allowable under-voltage power failure time
b003 :Retry delay time
b004 :Instantaneous power failure under-voltage trip during stop
b005 :Instantaneous power failure undervoltage retry time selection
b007 :frequency setting to match
C021-C022 : multifunctional output terminal
C026 :Alarm relay output

Set item	Function code	Data	Description
Retry selection (note3)	b001	00	Trip.
		01	Restart from 0Hz on retry.
		02	F-matching start on retry. (example1)
		03	F-matching start and stop decelerating on retry. After stop, start trip. (note1)
Allowable under-Voltage power failure time	b002	0.3-1.0	Units : second If the instantaneous power failure time is shorter than the set time, a restart will occur. (example1) If the instantaneous stop time is longer than set time, trip. (example2)
Retry wait time	b003	0.3-100.	Units:second Delay before motor restart time.
Instantaneous power failure/under-voltage trip during stop(note2)	b004	00	Invalid Trip isn't caused and alarm isn't output.
		01	Valid Trip is cause and alarm is output.
		02	Invalid Trip isn't caused and alarm isn't output during stop and deceleration by stop command.
Instantaneous power failure/Under-voltage retry time selection	b005	00	Restart to 16 times on instantaneous stop under-voltage.
		01	Restart freely on instantaneous stop under-voltage.
Frequency setting to match	b007	0.00-400 .0	Units:Hz When the frequency of the motor during free-run is less than this set frequency, restart with 0Hz is caused. (example3,4)

(Note 1) When trip of the over voltage or over current etc. occurs in the deceleration midway an instantaneous power failure error (E16) is displayed and operates free-run. In this case make the deceleration time of long

(Note 2) When using control power supply terminal r1-t1 and connecting DC voltage (P-N) to r1-t1, an under-voltage may be detected at power off and give trip signal. If this may cause any problem to your system, set data in 00 or 02.

Frequency matching start: The inverter reads the motor RPM and direction and restarts the inverter to match these readings. Retry function (b001: 02): The timing chart in case of selection is following.

t0 :Instantaneous stop power failure
t1 :Allowable under-voltage power failure time(b002)
t2 :Retry wait time(b003)

(example1)

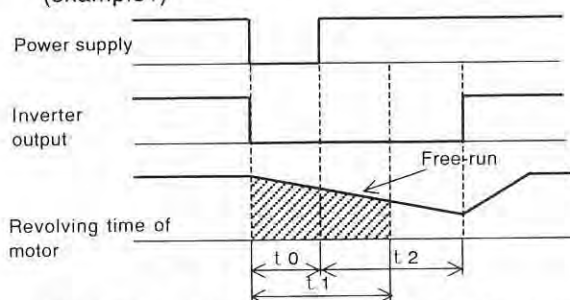

After wait for t2 seconds according to $t_0 < t_1$, restart.

(example2)

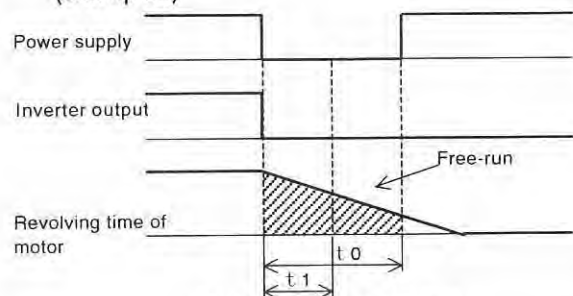

Trip according to $t_0 > t_1$.

Chapter 4 Explanation of function

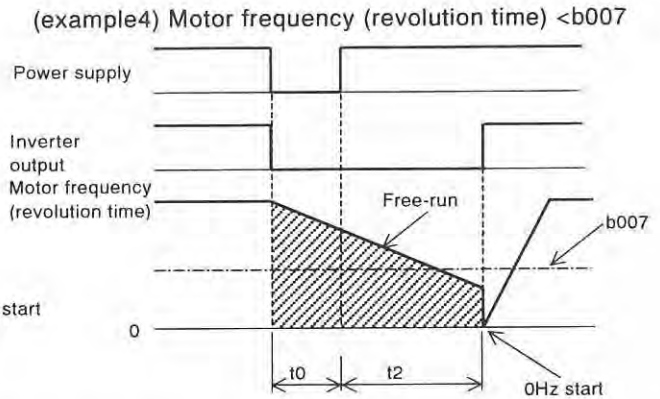
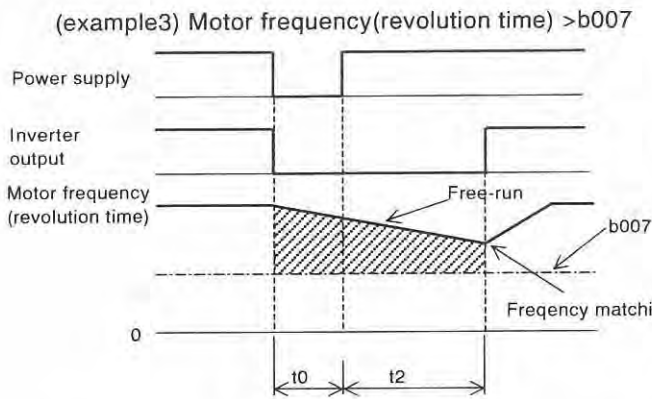

(2) Instantaneous power failure during stop alarm output during under-voltage

Select yes/no of alarm output when instantaneous power failure or under-voltage occurs with b004.

Alarm outputs while control power of inverter remains.

- Alarm output at an instantaneous power failure and under-voltage during standstill.

Standard (example 5-7).

Alarm signal performance when connecting DC voltage (P-N) to r1-t1 terminal. (example 8-10).

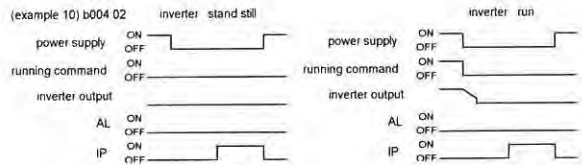
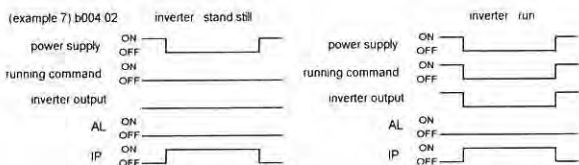
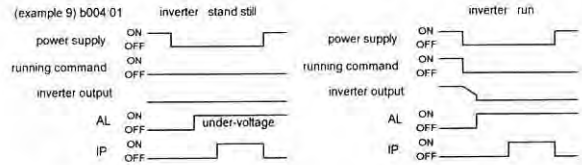
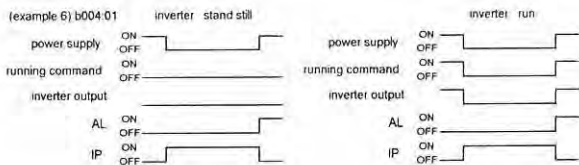
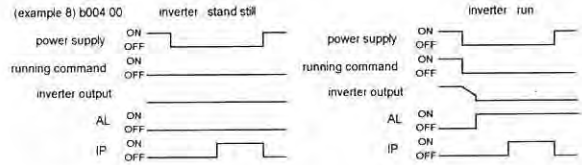
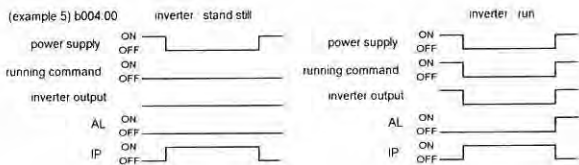

(3) It is possible to use an output by assigning the signal (IP: 08) during instantaneous stop, by setting (UV: 09) during under-voltage to an multifunctional output terminal 11-15(C021-C025) or alarm relay output terminal (C026).

(Note 3): It displays as follows during implementing frequency matching.

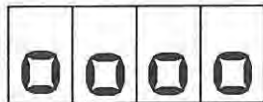

Chapter 4 Explanation of function

Open phase protection function selection

This is the function to warn when the inverter input supply opens.

Function code	Data	Description
b006	00	Invalid Don't trip when the input supply opens.
	01	Valid Trip when the input supply opens..

Relation code
b006:Open phase selection

When an open phase occurs, there is a danger that the inverter could produce one of the following states;

- (1) Ripple current of main capacitor increases, life of main capacitor shortens remarkably.
- (2) In case of load, there is danger that the capacitors or thyristors inside the inverter could be damaged.
- (3) There is a risk that the in-rush resistor to limit the current inside the inverter may burn out.

Electronic thermal function

Set the Inverter according to motor rated current to protect the motor from overloading, overheating and damage.

A warning signal is outputted before tripping on electronic thermal Protection.

- (1) Electronic thermal level

Function code	Setting range	Description
b012/b212/ b312	Rated Current x 0.2 to Rated Current x 1.2	Units:A

- (2) Electronic thermal characteristic

Frequency characteristic is added up to set value of b012.

Function code	Data	Electronic thermal characteristic
b013/b213 /b313	00	Reduced torque characteristic
	01	Constant torque characteristic
	02	Free setting

Relation code
b012/b212/b312:electric thermal level
b013/b213/b313: electric thermal characteristic selection
b015/b017/b019:free electric thermal frequency 1/2/3
b016/b018/b020:free thermal current 1/2/3
C021-C025:Multifunctional output terminal
C026:Alarm relay output terminal

When output frequency of general motor decreases, cooling function of self-cooled fan will fall.

Reduced torque characteristic is calculated according to heat of a SUMITOMO general motor.

- (a) Reduced torque characteristic

To add to the time limit characteristic set with the reduced time rate b012/b212/b312 by each frequency.

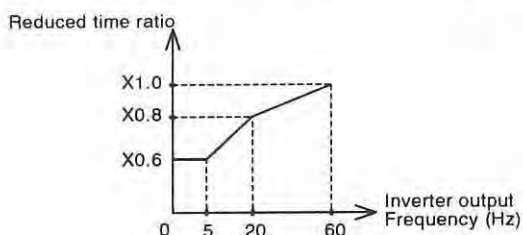

(example)b012 = 46(A), when output frequency = 20Hz

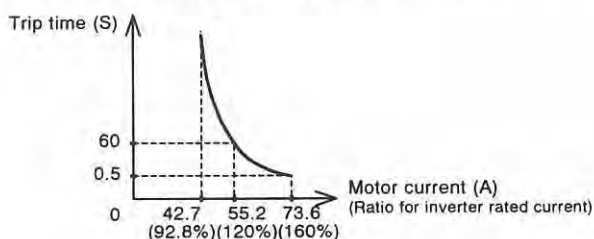

- (b) Constant torque characteristic

Set this in to use constant torque motor case.

(Example)b012 = 46(A), when output frequency=2.5Hz.

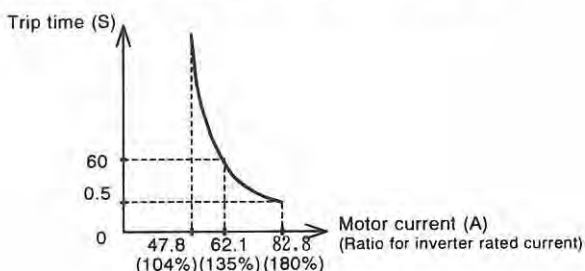
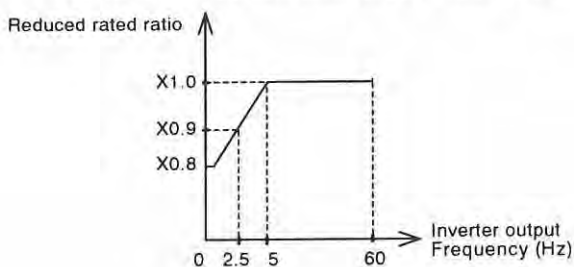

Chapter 4 Explanation of function

(3) Free/thermal characteristic

It is possible to set the electronic thermal characteristic freely according to the load in order to protect the motor and the Inverter.

Setting range is shown as follows;

Set item	Function code	Set range	Description
Free electronic thermal frequency 1/2/3	b015/b017/b019	0 to 400	Units : Hz
Free electronic thermal current 1/2/3	b016/b018/b020	0.0 0.1 to 999.9	Don't operate. Units : A

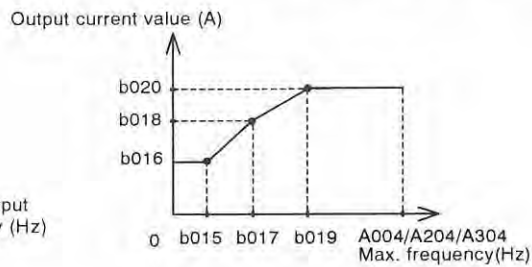
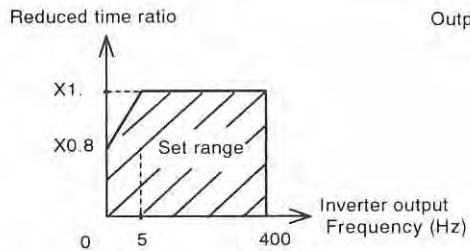

(Example) b012=44(A), output frequency=b017

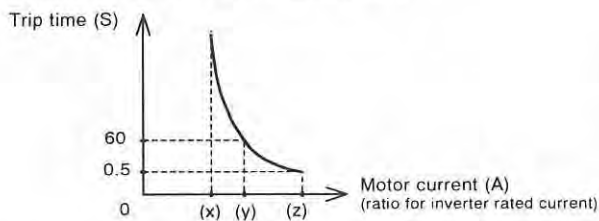

- (x):b018x116%
- (y):b018x120%
- (z):b018x150%

(4) Thermal warning

A warning signal is outputted before overheat protection by the electronic thermal protection occurs. Warning level is set with C061.

Assign 13 (THM) to a multifunctional output terminal (C021-C025) or the alarm relay output (C061).

Function code	Data	Description
C061	0. 1.-100.	Don't operate. Units : %

Stall prevention/Current detection

(1) Stall prevention

The Inverter monitors the motor current on acceleration and constant speed. When the inverter reaches the stall prevention level, the Inverter will reduce the output frequency automatically to restrict the over-load. This function prevents an overcurrent trip by inertia during acceleration or radical changes in load at constant speed. Two kinds of stall prevention function are set with b021, b022, b023 and b024, b025, b026. To change b021, b022, b023 and b024, b025, b026, assign 39(OLR) to a multifunctional input terminal. The current value this function operates at is set in stall prevention level. The stall prevention constant is the time to decelerate to 0Hz from max frequency.

b021, b022, b023 and b024, b025, b026 is changed with OLR.

As this function operates, the acceleration time is longer than setting time. If the stall prevention constant is set too short, in spite of accelerating, an over-voltage trip is caused with regenerative energy from the motor on automatic deceleration by this function. When this function operates in the midst of accelerating, the frequency will not reach the goal frequency, the Inverter will adjust in the following way.

- Make acceleration time longer.
- Raise torque boost.
- Raise stall prevention level.

Relation code

- b021: Stall prevention selection
- b022: Stall prevention level
- b023: Stall prevention constant
- b024: Stall prevention 2 selection
- b025: Stall prevention level2
- b026: Stall prevention constant2
- C001-C008: Multifunctional input
- C021-C025: Multifunctional output
- C026: Alarm relay output setting
- C040: Current detection signal output mode
- C041: Current detection level
- C111: Current detection level2

Set item	Function code	Data	Description
Stall prevention Selection.	b021/b024	00	Invalid
		01	Acceleration/valid on constant speed.
		02	Valid on constant speed.
		03	Acceleration/valid on constant speed. (Note 1)
Stall prevention Level.	b022/b025	Rated current x 0.5 to Rated current x 2.0	Units :A Current value stall prevention operates.
Stall prevention Constant.	b023/b026	0.1 to 30.0	Units :second Deceleration time when stall prevention Operates.

(Note 1): (Increase speed mode at the time of regenerating)

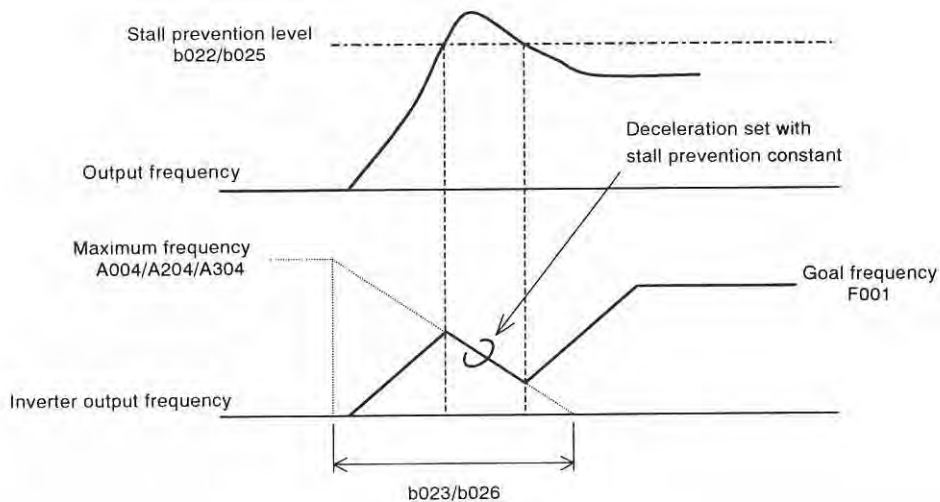

(2) Current detection

When the load is high, it is possible to adjust the load again by outputting a Current detection.

It is used to prevent damage to the machine from too much load, i.e. baggage on a conveyor, the Inverter overload protection will operate.

Assign 03(OL) or 26(OL2) to a multifunctional output terminal UPF – X3 or the alarm relay output terminal.

(Two kinds of Current detection signals are possible output.)

Set item	Function code	Data	Description
Current detection signal output mode selection	C040	00	On acceleration/deceleration, constant speed, this is valid.
		01	On constant speed only, this is valid.
Current detection Level	C041	0.0 0.1 to Rated current x 2	Don't operate. Units: A As load reaches Current detection level, OL signal is output.
Current detection Level2	C111	0.0 0.1 to Rated current x 2	Don't operate. Units: A As load reaches Current detection level, OL2 signal is output.

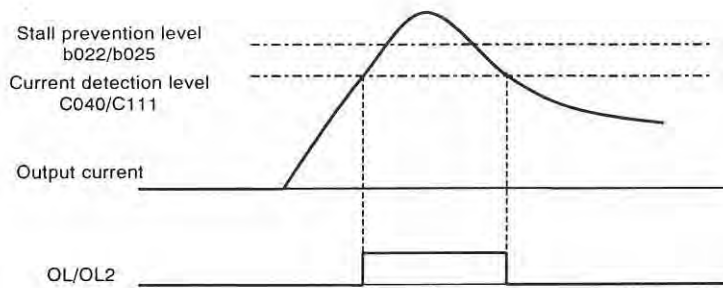

Start frequency

This frequency is the value the operator must set before the Inverter will give an output.

Mainly used when an operator adjusts the start torque.

By setting the start frequency higher, direct starting is caused and the starting current increases. Therefore an overload is within the restriction range and the inverter has a tendency to trip on over-current protection.

Relation code
b082:Start frequency

Function code	Set range	Description
b082	0.10 to 9.99	Units:Hz

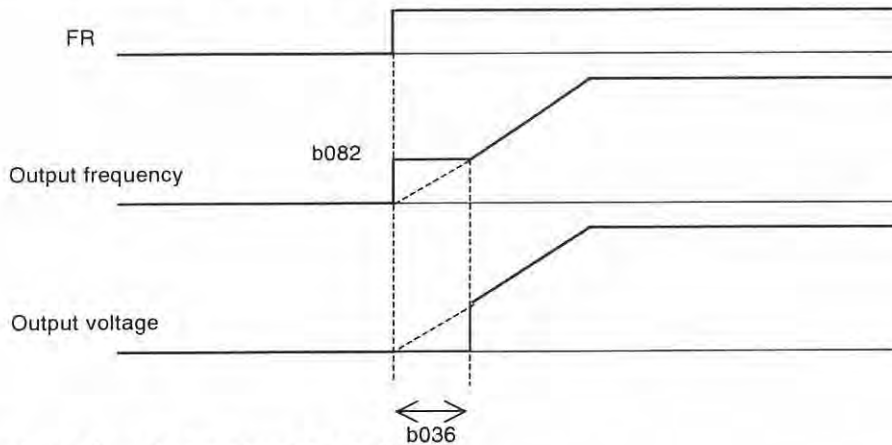

Reduced voltage start selection

This function is to raise the voltage slowly on motor starting.

The lower this value the more torque is available on starting..

However, by making this value lower, the inverter has a tendency of tripping on over-current protection, because of almost direct starting.

Relation code
b036:Reduced voltage
start selection
b082:Start frequency

Function code	Data	Time to take for reduced voltage starting
b036	00	No reduced voltage start
	01	Short (about 6ms)
	↑ ↓	↑ ↓
	06	Long (about 36ms)

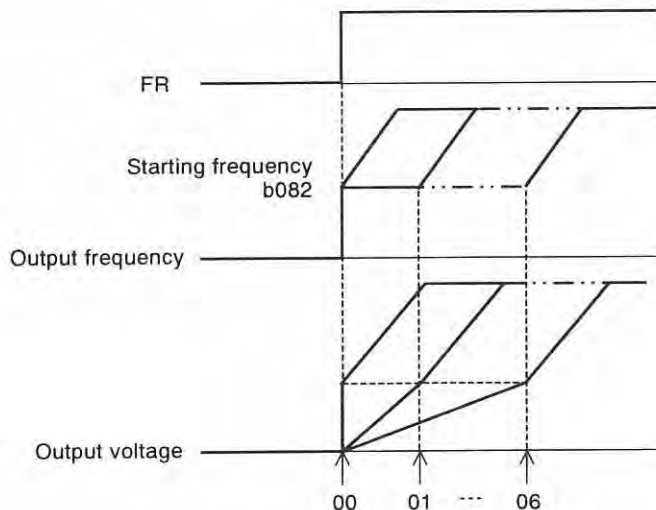

DBTR (Dynamic breaking) function

This function only operates with the HF-430 - 11kW and lower, as they have the built-in DBTR.

This function is to consume regenerative energy from the motor as heat by the use of an external resistor.

Regeneration occurs when the motor is decelerated to quickly and the motor turns into a generator and voltage flows back into the Inverter.

To use the DBTR function, set following condition.

Relation code
 b090: DBTR use rate
 b095: DBTR action selection
 b096: DBTR on level

Set item	Function code	Data	Description
DBTR usage Ratio	b090	0.0	DBTR don't operate.
		0.1-100.0	The usage ratio of DBTR is set by 0.1% unit. When inverter exceeds the usage ratio, trip. <div style="text-align: center; margin-top: 10px;"> $\text{Usage ratio (\%)} = \frac{(t1+t2+t3)}{100 \text{ second}} \times 100$ </div>
Selectio n of DBTR	b095	00	DBTR don't operate.
		01	During run: valid (DBTR operates.) During stop: invalid (DBTR doesn't operate.)
		02	During run, stop, valid (DBTR operates.)
DBTR ON Level	b096	(Note) 330-380	Units: V In case of 200V class inverter, setting is valid.
		(Note) 660-760	Units: V In case of 400V class inverter, setting is valid.

(Note) DBTR ON level is the voltage setting of the DC (direct current) voltage of the inverter.

Cooling fan operating selection

You can select whether the fan operates continuously or operates only when the inverter is in the running operation.

Relation code
 b092: Cooling fan
 operation selection

Function code	Data	Description
b092	00	Always run
	01	Only during run However, inverter operates for five minutes after power ON, and for five minutes after inverter operation stops.

Multifunctional input terminal setting

It is possible to operate functions by assigning those functions to the multifunctional input terminals RST-RR (C001-C008).

The multifunctional input terminals RST-RR can be selected individually whether the contact input specification is either a NO or a NC contact.

Two or more multifunctional input terminals can't be assigned to be the same function.

If an multifunctional input is assigned a function which is already assigned to another terminal it will automatically be restored back to the setting before.

Relation code

C001-C008:multifunctional input terminal

Function Code	Data	Description	Reference item	Page	
C001 - C008	01	RR:Reverse command	Operation run	4-17	
	02	DFL:Multi-speed 1 (binary operation)	Multi-speed operation function	4-44	
	03	DFM:Multi-speed 2 (binary operation)			
	04	DFH:Multi-speed 3 (binary operation)			
	05	DFHH:Multi-speed 4 (binary operation)			
	06	JOG:Jogging	Jogging operation	4-46	
	07	DB:External DC braking	DC braking(external DC braking)	4-28	
	08	BMD:Set of Motor Data	B-mode Set of Motor Data	4-47	
	09	AD2:Two-stage adjustable-speed	2nd-stage adjustable-speed function	4-33	
	11	MBS:Free-run stop	Free-run stop	4-49	
	12	ES:External trip	External trip	4-52	
	13	USP:Unattended start protection	Unattended start protection function	4-51	
	14	CS:Commercial change	Commercial change	-	
	15	SFT:Software lock (control terminal)	Software lock	4-48	
	16	AUT:analog input voltage/current select	Analog external input	4-22	
	17	CMD:Set of Motor Data	C-mode Set of Motor Data	4-47	
	18	RST:Reset inverter	Reset inverter	4-50	
	20	STA:3 wire start	3 wire input function	4-52	
	21	STP:3 wire stop			
	22	F/R:3 wire direction			
	23	PID:PID selection (valid/invalid)	PID function	4-32	
	24	PIDC:PID integrating reset			
	26	CAS: Control gain switching	Control gain switching	-	
	27	UP:Remote control UP function	UP/DOWN function	4-51	
	28	DWN:Remote control DOWN function			
	29	UDC:Remote control data clear			
	31	OPE: Force operation ope	Force operation function	4-48	
	32-38	SF1-7:Multi-speed 1-7 (bit run)	Multi-speed operation function	4-45	
	39	OLR:Overload restriction change	Overload restriction	4-39	
	40	TL: Torque restriction presence	Torque limit function	4-71	
	41	TRQ1: Torque limit switching 1			
	42	TRQ2: Torque limit switching 2			
	43	PPI:P/PI switching	P/PI switching function	-	
	44	BOK: Brake confirmation	Brake control function	4-62	
	45	ORT: Orientation	Option function	(note)	
	46	LAC: LAD cancel	LAD cancel function	-	
	47	PCLR: Position deviation clear	Option function	(note)	
	48	STAT: Pulse train input permission			
		no	NO:No assign	-	-

(note) Refer to the option instruction manual.

Input terminal a/b (NO/NC) selection

It is possible to set a contact input or b contact input to multifunctional input terminals RST-RR and FR terminals individually.

Set item	Function code	Data	Description
multifunctional input a/b(NO/NC)selection	C011-C018	00	A contact(NO)
		01	B contact(NC)
Input FR a/b(NO/NC)selection	C019	00	A contact(NO)
		01	B contact(NC)

Relation code

C011-C018: multifunctional input a/b (NO/NC) selection
 C019 : Input FR a/b (NO/NC) selection

a contact: "ON" with Close, "OFF" with Open
 b contact: "ON" with Open, "OFF" with Close
 RST terminal can set only a contact.

Multi-speed operation function

It is possible to set multiple operation speeds and switch between the speeds with the terminals.

Multi-speed operation can be selected by binary operation(max. 16 speeds) with 4 terminals or by bit operation (max. 8 speeds) with 7 terminals.

Relation code

A019: Multi-speed selection
 A020/A220/A320: multi-stage speed zero
 A021-A035: Multi-speed 1-15
 C001-C008: Multifunctional input terminal

Set item	Function code	Set value	Description
Multi-speed selection	A019	00	Change to binary operation 16 speed.
		01	Change to bit operation 8 speed
Multi-speed 0-15	A020/A220/A320 -A035	0.00, start frequency-max. frequency	Units:Hz

(1) Binary operation

It is possible to set multi-speed 0 to 15 by selecting 02 to 05 (DFL to DFHH) on the multifunctional input terminals.

Set frequency setting for speed 1 to 15 with A021-A035.

Set 0 speed with A020/A220/A320 or F001 when frequency command is operator.

Or when frequency command is control terminal (Terminal), set with VRF, IRF, VRF2 terminal.

Multi-speed	DFHH	DFH	DFM	DFL
0 speed	OFF	OFF	OFF	OFF
1 speed	OFF	OFF	OFF	ON
2 speed	OFF	OFF	ON	OFF
3 speed	OFF	OFF	ON	ON
4 speed	OFF	ON	OFF	OFF
5 speed	OFF	ON	OFF	ON
6 speed	OFF	ON	ON	OFF
7 speed	OFF	ON	ON	ON
8 speed	ON	OFF	OFF	OFF
9 speed	ON	OFF	OFF	ON
10 speed	ON	OFF	ON	OFF
11 speed	ON	OFF	ON	ON
12 speed	ON	ON	OFF	OFF
13 speed	ON	ON	OFF	ON
14 speed	ON	ON	ON	OFF
15 speed	ON	ON	ON	ON

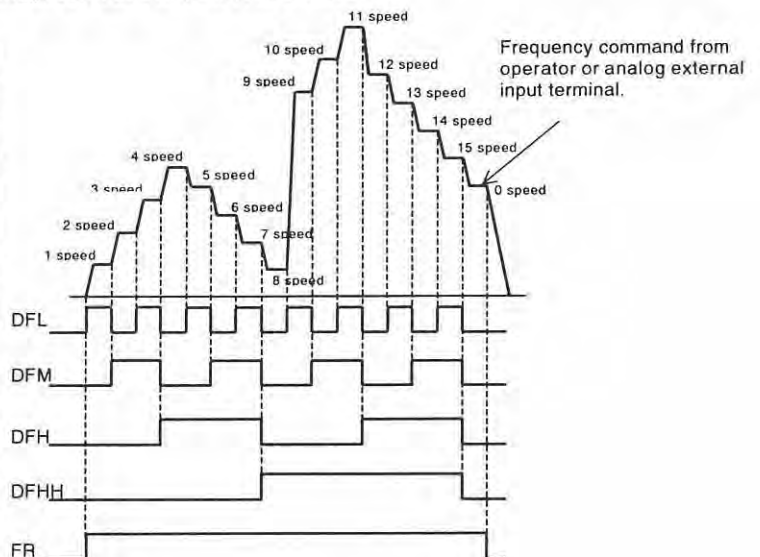

(2) Bit operation

It is possible to set multi-speed 0 to 7 by assigning 32 to 38 (SF1-SF7) to the multifunctional input terminals.

Set frequency SF1-SF7 to A021-A027.

Multi-speed	SF7	SF6	SF5	SF4	SF3	SF2	SF1
0 speed	OFF	OFF	OFF	OFF	OFF	OFF	OFF
1 speed	-	-	-	-	-	-	ON
2 speed	-	-	-	-	-	ON	OFF
3 speed	-	-	-	-	ON	OFF	OFF
4 speed	-	-	-	ON	OFF	OFF	OFF
5 speed	-	-	ON	OFF	OFF	OFF	OFF
6 speed	-	ON	OFF	OFF	OFF	OFF	OFF
7 speed	ON	OFF	OFF	OFF	OFF	OFF	OFF

When each terminal turns ON simultaneously, the lower number has priority.

In order for the inverter to operate both the frequency and the RUN operation (FR,RR) must be applied.

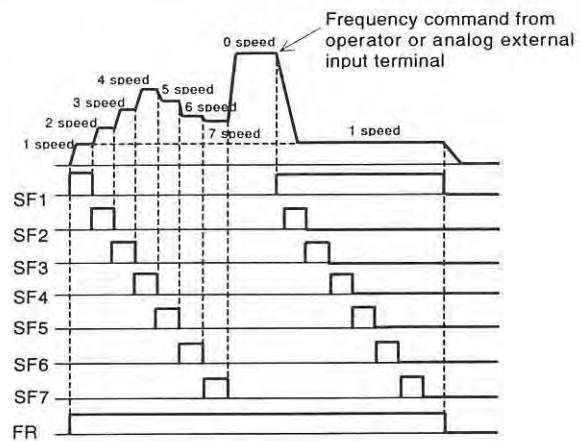

Jogging operation

This function can be used to rotate the motor in small steps to allow fine-tuning.

Set an multifunctional input terminal to 06(JOG).

Relation code	
A038	: Jogging frequency
A039	: Jogging selection
C001-C008	: multifunctional input terminal

(1) Jogging frequency

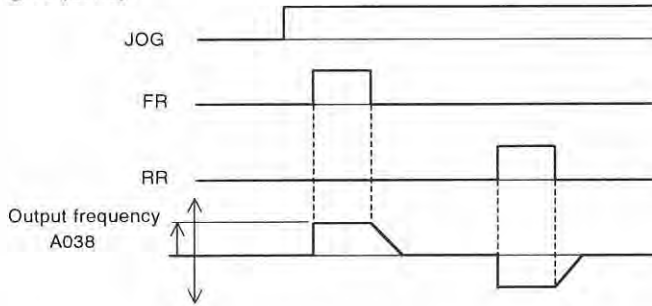

The jogging operation does not use acceleration, therefore it would be advisable to set the jogging frequency to limit the starting current to a minimum or tripping may occur. Adjust A038 to the jogging frequency required.

Function code	Data	Description
A038	0.0, start frequency-9.99	Units:Hz

(2) Jogging operation selection

Function code	Data	Description	Jogging operation during run Valid / Invalid
A039 (Note 2)	00	Free-run on jogging stop	Invalid (example1) (note 1)
	01	Decelerating stop on jogging stop.	
	02	Direct braking on jogging stop.	
	03	Free-run on jogging stop.	Valid (example2) (note 1)
	04	Decelerating stop on jogging stop.	
	05	Direct braking on jogging stop.	

(Note 1) When using the jogging function, turn FR terminal or RR terminal ON after the JOG terminal is turned ON.

(It is the same when the operation command point is from the operator.)

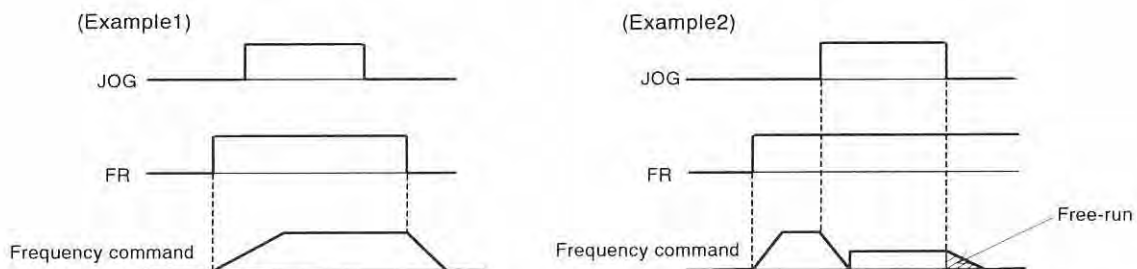

When setting of A039 is 00,01 or 02 and FR signal is turned ON beforehand, the inverter doesn't operate jogging.

When setting of A039 is 03,04 or 05 and FR terminal is turned ON beforehand, the inverter operates jogging. But jogging terminal is turned ON beforehand, the inverter output is cut off.

(Note 2) In the case that the setting of A039 is 02 or 05, data setting of DB is necessary.

B / C-mode function (BMD, CMD)

This control function is used when the Inverter is connected to two different types of motors. By assigning 08(BMD)/17(CMD) to a multifunctional input terminal and turning BMD/CMD terminal ON/OFF you can switch between three different Inverter set-ups.

Select B/c-mode function while the Inverter is in the STOP condition.

The functions which can change with BMD terminal

F002/F202/F302: acceleration time

F003/F203/F303: deceleration time

A003/A203/A303: base frequency

A004/A204/A304: max. frequency

A20/A220/A320: multi-speed 0 setting

A041/A241: torque boost selection

A042/A242/A342: manual torque boost

A043/A243/A343: manual torque boost point

A044/A244/A344: control system

A061/A261: frequency upper limiter

A062/A262: frequency lower limiter

A092/A292/A392: acceleration time 2

A093/A293/A393: deceleration time 2

A094/A294: two-stage adjustable speed selection

A095/A295: two-stage acceleration frequency

A096/A296: two-stage deceleration frequency

b012/b212/b312: electronic thermal level

b013/b213/b313: electronic thermal characteristic selection

H002/H202: motor constant selection

H003/H203: motor capacity selection

H004/H204: motor pole selection

H005/H205: Speed answer

H006/H206/H306: stabilized constant

H020/H220: Motor R1

H021/H221: Motor R2

H022/H222: Motor L

H023/H223: Motor I₀

H024/H224: Motor J

H030/H230: Motor R1 (Auto-tuning)

H031/H231: Motor R2 (Auto-tuning)

H032/H232: Motor L (Auto-tuning)

H033/H233: Motor I₀ (Auto-tuning)

H034/H234: Motor J (Auto-tuning)

H050/H250: PI proportion gain

H051/H251: PI integration gain

H052/H252: P proportion gain

H060/H260: Zero SLV limiter

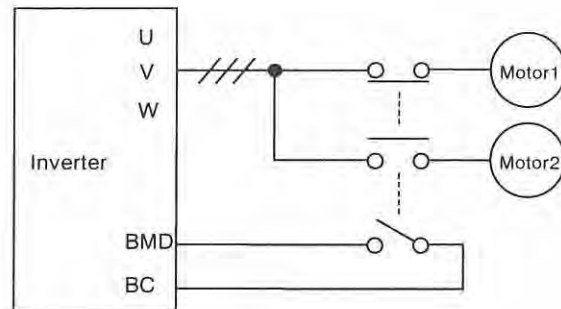

Display during setting isn't differentiated between the normal-mode function or the B/C-mode function. So confirm it in the state of ON/OFF of terminal. Even if each-mode(normal/B/C-mode) is changed during run, it will not be active until the inverter is stopped. When both of the BMD and CMD terminals are turned on it becomes the B-mode function.

Software lock mode selection(SFT)

This function is used to prevent changing data by mistake. When you want to use an multifunctional input terminal, assign 15(SFT). Below is the software lock code selection.

Relation code

b031 : Software lock mode selection
C001-C008: multifunctional input terminal

Function code	Data	SFT terminal	Description
b031	00	ON/OFF	Write disable except for b031/write enable
	01	ON/OFF	Write disable except for b031,F001,A020,A220,A320 A021-A035,A038 / write enable
	02	-	Write disable except for b031
	03	-	Write disable except for b031,F001,A020,A220,A320 A021-A035,A038
	10	-	Write disable except for change mode during running (code list reference)

Force operation function(OPE)

This function is used to operate from the operator forcibly by on/off of an multifunctional terminal when frequency and operation command is selected other than the operator.

Relation code

A001: Frequency setting selection
A002: Operation command selection
C001-C008: multifunctional input terminal

Becoming the operation from the frequency and operation command that was selected by A001 and A002 if the signal is off, and becoming the frequency and operation command from an operator forcibly if the signal is on when the compulsion operation function is selected by an multifunctional input selection.

When changed the operation command while driving, operation command is canceled and become stoppage at first. Operation command from each command input the operation command once again as the stoppage at first for driving once again.

Setting item	Function cord	Setting value	Contents
Frequency setting selection	A001	01	Terminal
		02	Operator
		03	RS485
		04	Option 1
		05	Option 2
Operation command selection	A002	01	Terminal
		02	Operator
		03	RS485
		04	Option 1
		05	Option 2
multifunctional input selection	C001-C008	31	OPE : Compulsion operation

Free-run stop (MBS)

By operating the free-run stop (MBS) function, the inverter output is cut off. The motor will free wheel under its own momentum.

This function is used when the motor is to be stopped by the use of a brake, like an electromagnetic brake.

If you stop the motor with a machine brake while the inverter is still outputting to the motor an over-current trip may occur. Assign 11 (MBS) to a multifunctional input terminal. This free-run stop function will operate when the MBS terminal is ON.

If you turn MBS terminal OFF the inverter will restart after the retry wait time b003 passes. However when the operation command selection A002 is set to control terminal (01), the inverter restarts during free-running.

This function will only operate when the FR terminal is ON.

On restart it is possible to select 0Hz start or matching frequency start as output methods with the free-run stop selection b088. (Example 1, 2)

When you set the frequency setting to match (b007) and the frequency detected is under this setting when the free-run stop is released, the inverter is restarted from 0Hz.

The setting of this function is valid for selection b091 on stopping.

Relation code

b088	: Free-run stop selection
b003	: Retry wait time
b007	: frequency setting to match
b091	: Stop mode selection
C001-C008	: multifunctional input terminal

Set item	Function code	Data	Description
Free-run stop selection	b088	00	0Hz start (example 1)
		01	Matching frequency start (example 2)
Retry wait time	b003	0.3-100.	Units:second Time until restart after MBS terminal is OFF. (This is also used for Instantaneous restart.)
Frequency setting to match	b007	0.00-400.0	Units:Hz (instantaneous stop, reference to item of insufficiency) This sets the level to match frequency. (Refer to item of instantaneous stop and restart.)

(Example1) 0Hz start

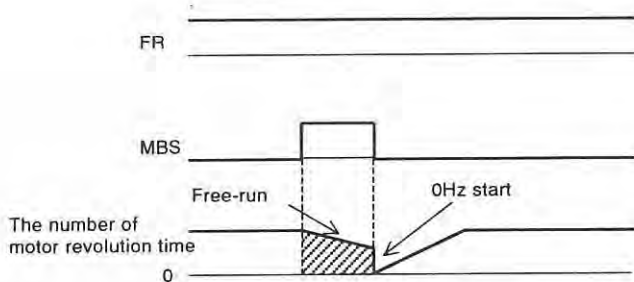

Start 0Hz regardless of the motor speed. On 0Hz start, the retry wait time is disregarded. When 0Hz start is used and the motor speed is still high there is the possibility of over-current trips.

(Example2) Matching start

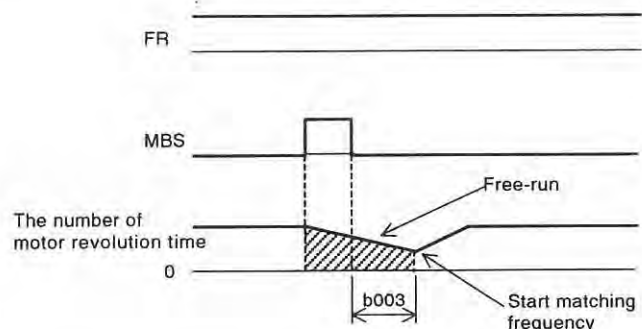

After MBS terminal is switched OFF, the Inverter reads the frequency of the motor and when it reaches the value in b007 the Inverter will begin to RUN again. On frequency matching start if an over-current trip occurs, try extending the retry time.

Reset (RST)

This function resets the inverter when a protective trip has occurred.

The method of reset is to either push the STOP/RESET key on the digital operator or to switch the RST terminal ON.

To reset the inverter with the control terminal, assign 18(RST) to an multifunctional input terminal.

Reset frequency matching selection C103 selects whether the

inverter restarts at 0Hz or the inverter matches the output frequency after the reset operation is complete.

Reset selection C102 selects when the alarm signal is cancelled and whether it is valid or invalid in normal operation.

The RST terminal is valid only when the contact is set to NO.

Relation code

- b003 : Retry waiting time
- b007 : Frequency setting to match
- C102 : Reset selection
- C103 : Reset frequency matching selection
- C001-C008 : Intelligent input terminal

Set item	Function code	Data	Description
Retry waiting time	b003	0.3-100	Units:seconds (Reference to items of instantaneous power failure or under-voltage) After reset, time until restart is tried.
Frequency setting to match	b007	0.00-400.0	Units:Hz (Reference to items of instantaneous stop/under-voltage)
Reset selection	C102	00	On ON signal, trip cancel (example1) On normal, this is valid (output cuts off).
		01	On OFF signal, trip cancel (example2) On normal, valid (output cuts off)
		02	On ON signal, trip cancel (example1) On normal, this is invalid. (only trip cancel)
Reset frequency matching selection	C103	00	0Hz start
		01	Frequency matching start. (example3)

(Example1)

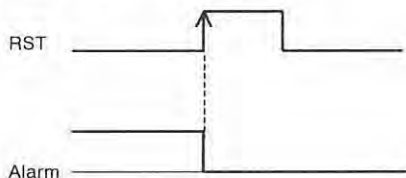

(Example2)

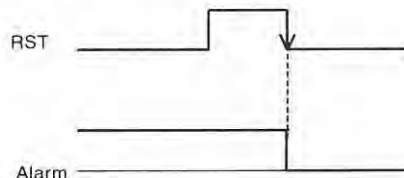

(Example3) When 01 (frequency matching) is selected with reset frequency matching selection C103, it is also possible to operate frequency start on power ON again. And retry waiting time is disregarded at the time of the setting C103:00 (0Hz start).

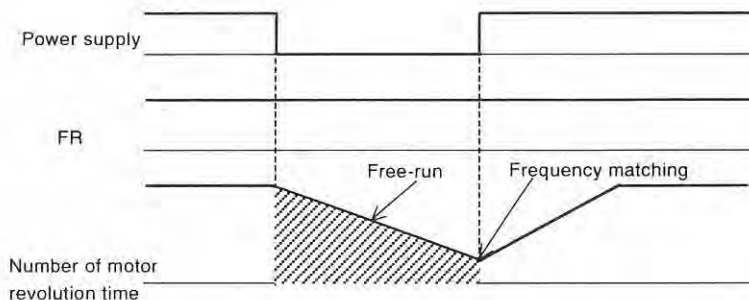

Unattended start protection (USP)

The USP function is designed as a fail safe to prevent accidental starting of the Inverter if the RUN signal is ON when the power is restored to the Inverter.

When this function worked E13 is displayed. Either resetting the Inverter or turning the RUN signal OFF can clear the trip.

This function is able to disarm when the operation command is turned off. (Example1)

If the trip is cancelled while the RUN signal is still ON then the inverter will restart automatically. (Example2)

When the operation command is turned on after the power supply input, the inverter drives normal. (Example3)

Assign 13(USP) to an multifunctional input terminal. Unattended start protection is shown as follows;

Relation code

C001-C008: multifunctional input terminal

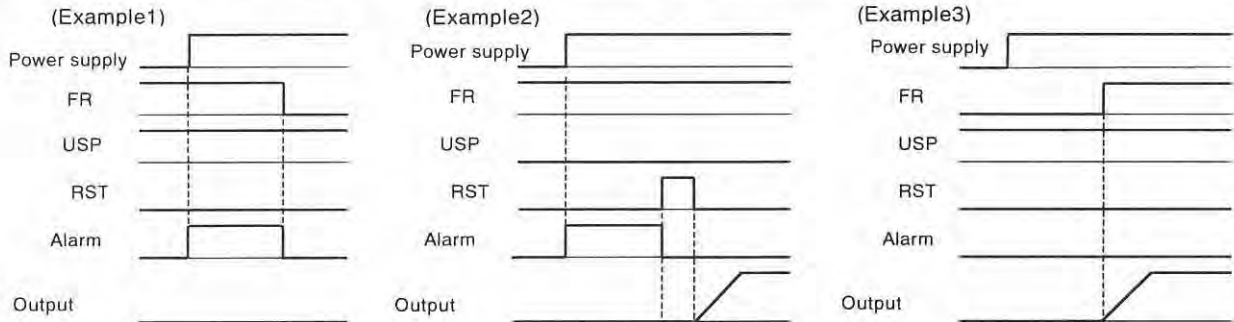

UP/DOWN selection(UP,DWN,UDC)

The Inverter output frequency can be changed with the UP and DWN multifunctional input terminals.

Assign 27(UP) and 28(DWN) to two of the multifunctional inputs.

This function is valid only when the frequency command selection A001 is set to 01 or 02. However, when 01 (control terminal) is set, this can only be used for multi-speed operation.

This function will not operate when the external analog frequency command or the jogging operation is used.

Acceleration time operates according to F002, F003/F202, F203/F302,F303 when UP/DWN terminal is ON.

To change B/C-mode, assign 08(BMD)/17(CMD) to an multifunctional input terminal, change with BMD/CMD terminal.

It is possible for the Inverter to retain the frequency setting value from the UP/DWN terminals. Parameter C101 switches the memory On or OFF. It is also possible to clear the memory and return to the original set frequency.

Assign 29(UDC) to an multifunctional input terminal and switch it on to clear the memory.

Relation code

C101 :UP/DOWN memory selection
C001-C008 :multifunctional input terminal

Function code	Data	Description
C101	00	This will not memorize the frequency command adjusted with UP/DWN. When power is turned ON again, set value is returned to the value before it was adjusted with UP/DWN.
	01	This memorizes the frequency command adjusted with UP/DWN. When power is turned ON again, set value is kept the value after it was adjusted with UP/DWN.

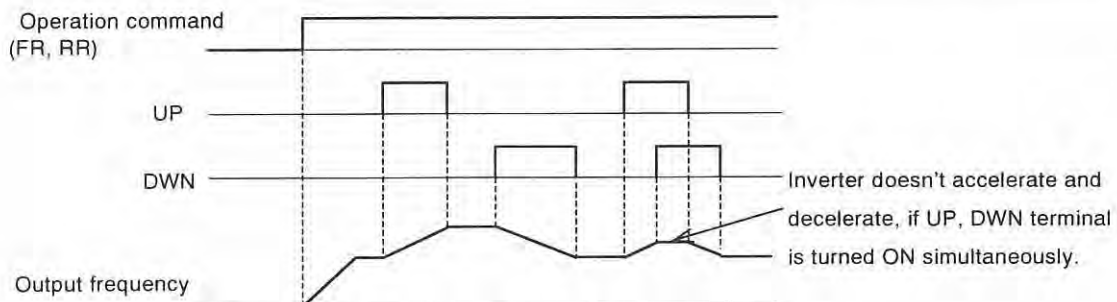

External trip (ES)

This function can be used to force the Inverter into a trip situation which is Switched by an external input, i.e. PLC or relay contact.

Relation code
C001-C008: multifunctional input terminal

When the ES terminal is switched ON, the inverter trips on an E12 error and the outputs are switched OFF.

Assign 12(ES) to an multifunctional input terminal.

The trip will not be canceled when the terminal is turned OFF.

To cancel the trip, the reset signal must be applied or the Inverter switched OFF and ON again at the supply.

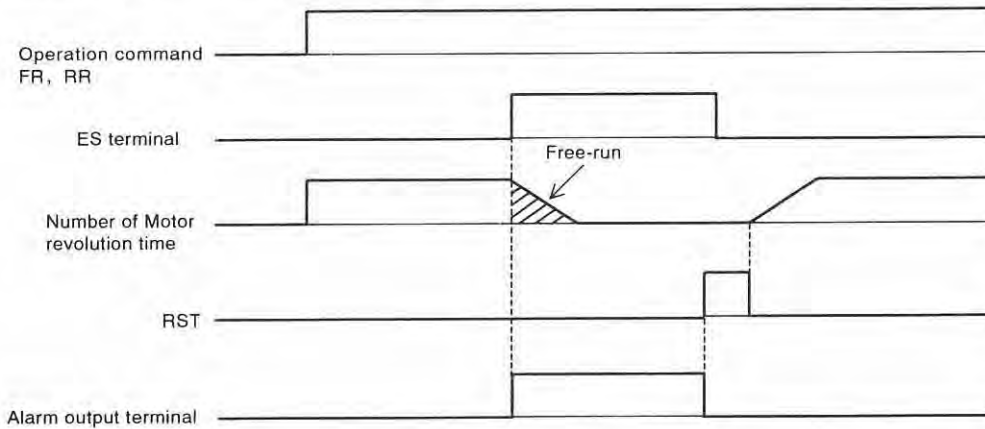

3 Wire input function(STA,STP,F/R)

This function is used when a momentary push start/stop control is required. Set the operation command selection A002 to control terminal (01). Assign 20 (STA), 21 (STP) and 22 (F/R) to three of the multifunctional input terminals, and the operation becomes possible as follows. When the terminal is assigned STP terminal, FR terminal and also RR terminal become invalid. If all three inputs are not assigned this function will not operate.

Relation code
C001-C008: multifunctional input terminal

The FR terminal and RR terminal become redundant when the 3 wire control is assigned to the multifunctional input terminals. Output from the 3 wire control terminal is as follows;

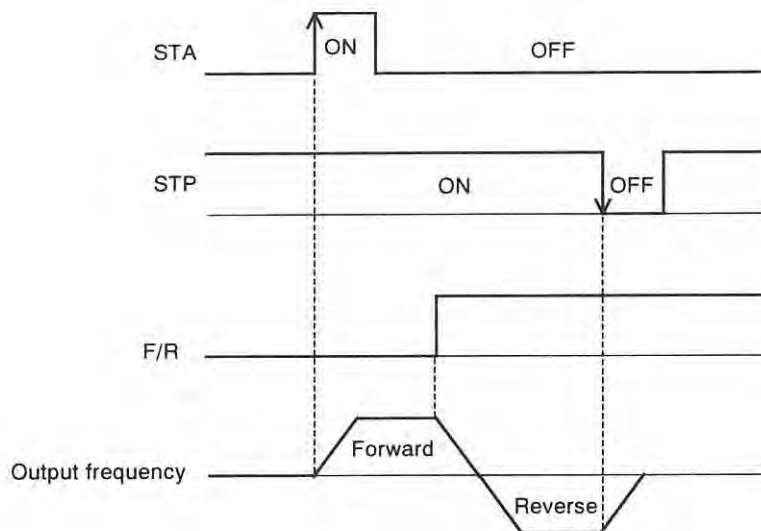

Multifunctional output terminal setting

Any of the following functions can be assigned to the multifunctional output terminals or the alarm relay.

Both multifunctional output terminals and the alarm relay are all relay outputs.

All three output relays can be selected to be either NO or NC (a or b).

Relation code	
C021-C025	: multifunctional output terminal
C026	: Alarm relay output terminal setting

Data	Description	Reference item	Page
00	DRV: Signal during run	Signal during run	4-54
01	UPF1: Constant speed arrival signal	Frequency arrival signal	4-54
02	UPF2: Over setting frequency		
03	OL: Current detection signal	Overload limit	4-39
04	OD: output deviation for PID control	PID function	4-31
05	AL: Alarm signal	Protection function	-
06	UPF3: Arrival signal for only setting frequency	Frequency arrival signal	4-54
07	OTQ: Over Torque	Over torque	4-56
08	IP: Instantaneous power stop signal	Instantaneous power stop /under-voltage	4-35
09	UV: Under voltage signal		
10	TRQ: Torque limit	Torque limit function	4-71
11	RNT: Accumulated run time over	Accumulated run time over	4-56
12	ONT: ON time over	Power ON time over	4-56
13	THM: Thermal caution	Electric thermal function	4-37
19	BRK: Brake opening	Brake control function	4-62
20	BER: Brake error		
21	ZS: Zero speed detect signal	Zero speed detect signal	4-56
22	DSE: Speed deviation excessive	Option function	-
23	POK: Positioning completion	Option function	-
24	UPF4: Arrival signal for over setting frequency 2	Frequency arrival signal	4-54
25	UPF5: Arrival signal for only setting frequency 2		
26	OL2: Current detection signal 2	Overload limit	4-39

Multifunctional output terminal a/b (NO/NC)selection

This sets the multifunctional output terminal and alarm relay output terminal contact condition to either NO or NC, (a or b).

Each output is changeable individually. Both multifunctional output terminals and the alarm relay are all relay outputs.

Relation code	
C031-C035	: multifunctional output a/b (NO/NC) selection
C036	: Alarm relay output a/b (NO/NC) selection

Set item	Function code	Data	Description
multifunctional output a/b(NO/NC) selection	C031-C035	00	A contact(NO)
		01	B contact(NC)
Alarm relay output a/b(NO/NC)selection	C036	00	A contact(NO)
		01	B contact(NC)

a contact: Close with {ON}, open with {OFF}. b contact: Open with {ON}, close with {OFF}.

(1) Specification of the multifunctional output terminals (2) Specification of the alarm relay output terminal

Electric characteristic
Between each terminal and OM Under 4V (Voltage depression while signal is turned on) Permission Max. Voltage DC27V Permission Max. Current 50mA

		Resistor load	Inductor load
FB-FC	Maximum	AC250V, 2A DC30V, 8A	AC250V, 0.2A DC300V, 0.6A
	Minimum	AC100V, 10mA DC5V, 100mA	
FA-FC	Maximum	AC250V, 1A DC30V, 1A	AC250V, 0.2A DC30V, 0.2A
	Minimum	AC100V, 10mA DC5V, 100mA	

Signal during run (DRV)

This function is to provide an output signal when the Inverter is in a running condition.

Assign 00(DRV: signal during run) to an multifunctional output terminal or the alarm relay output terminal.

The signal is still outputted when the dc braking operates.

Operation is as follows;

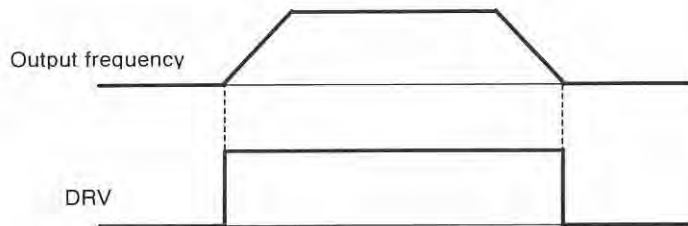

Relation code

C021-C025: multifunctional output terminal

Frequency arrival signal (UPF1, UPF2, UPF3, UPF4, UPF5)

When the output frequency arrives at the set frequency, an arrival signal is outputted. Assign 01(UPF1:constant speed arrival signal), 02(UPF2:over setting frequency),06(UPF3: only setting frequency), 24(UPF4:over setting frequency 2), or 25(UPF5:only setting frequency 2) to an multifunctional output terminal 11-15 or the alarm relay output terminal.

Hysteresis frequency arrival signal is the following.

When ON : ON with (1% of setting frequency – maximum frequency)(Hz)

When OFF: OFF with (2% of setting frequency – maximum frequency)(Hz)

However in to set 06(UPF3), 25(UPF5) case when inverter accelerate.

When ON : (1% of setting frequency – maximum frequency)(Hz)

When OFF: (2% of setting frequency + maximum frequency)(Hz)

When inverter decelerates

When ON : (1% of setting frequency + maximum frequency)(Hz)

When OFF: (2% of setting frequency – maximum frequency)(Hz)

Relation code

C021-C025: multifunctional output terminal
 C042: Acceleration arrival frequency
 C043: Deceleration arrival frequency
 C045: Acceleration arrival frequency 2
 C046: Deceleration arrival frequency 2

Set item	Function code	Data (Hz)	Description
Acceleration arrival frequency 2	C042 / C045	0.0	Don't output arrival signal on acceleration.
		0.01-400.0	Output arrival signal on acceleration.
Deceleration arrival frequency 2	C043 / C046	0.0	Don't output arrival signal on deceleration.
		0.01-400.0	Output arrival signal on deceleration.

Chapter 4 Explanation of function

(1) Output on constant speed arrival (01:UPF1)

When the inverter arrives at the set frequency with frequency setting (F001, A020, A220, A320) or multi-speed (A021-A035), the output relay is switched.

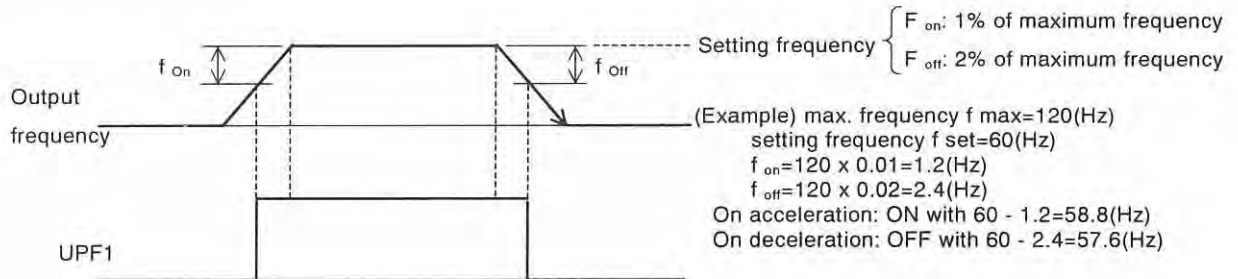

(2) Output over setting frequency (02:UPF2, 24:UPF4)

When the output is over the arrival frequency set in [C042, C043 (UPF2)], [C045, C046 (UPF4)] on adjustable speed time, the output relay is switched.

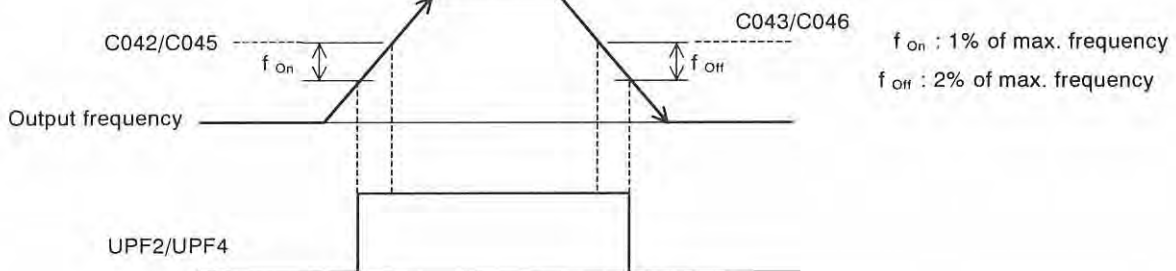

(3) Output setting frequency (06:UPF3, 25:UPF5)

The signal is switched only when the output frequency matches the arrival frequency set in [C042, C043 (UPF3)], [C045, C046 (UPF5)] on adjustable speed time.

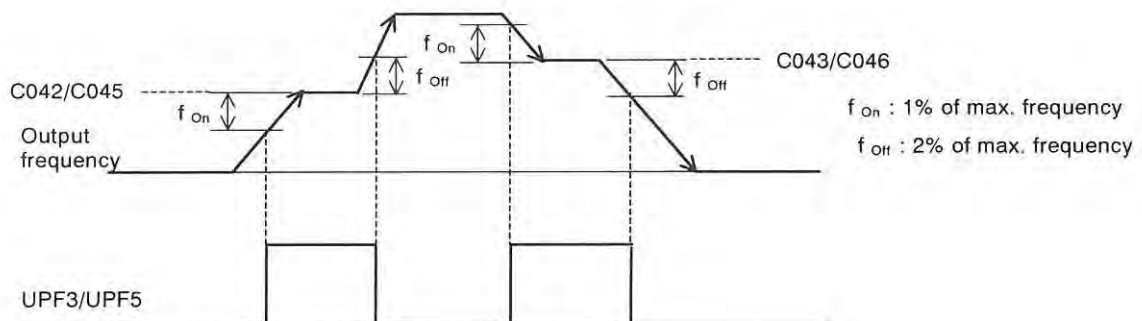

Accumulated RUN time / power ON time over (RNT/ONT)

When the accumulated operation time reaches or is over the setting time in b034, Accumulated RUN time/power ON time over (RNT/ONT) output is switched.

Function code	Data	Description
b034	0.	Don't operate.
	1. -9999.	Set by 10-hour unit.
	1000-6553	Set by 100 hours unit.
		(100000-655300 hours)

Relation code

b034 : Warning time level
 C021-C025: multifunctional output terminal
 C026 : Alarm relay output terminal
 d016 : Accumulation RUN time monitor
 d017 : Power ON time monitor

(1) Accumulated RUN time over (RNT)

Assign 11(RNT) to an multifunctional output terminal (C021 - C025) or the alarm relay output terminal (C026).
 set ON time level with b034.

(2) Power ON time over (ONT)

Assign 12(ONT) to an multifunctional output terminal (C021 - C025) or the alarm output terminal, (C026).
 Set ON time level with b034.

Zero speed signal(ZS)

This function detects that the output of the rotation speed of a motor or the output of LAD fell off from the zero speed detection level and be the function that outputs it.

By selecting zero speed signal in an multifunctional output selection this function comes into effect.

This function acts to the LAD output when the control method is VC,VP, free V/f, sensor-less vector control or zero speed area sensor-less vector control. Also, This function acts to the output of the rotation frequency of a motor when control method is vector control with sensor.

Setting item	Function cord	Setting value	Contents
Multifunctional output selection	C021-C025	21	ZS: Zero speed signal
Zero speed detection level	C063	0.00-100.0	Unit: Hz

Relation code

A044/A244/A344: control method selection
 C021-C025 : multifunctional output terminal
 C063 : Zero speed detect level

OVER TORQUE (OTQ)

This function can detect that estimated value of output torque of motor increase more than optional level and outputs.

When over torque signal is selected in multifunctional output selection, this function is valid.

This function is valid just when sensorless vector control, 0 Hz domain sensorless vector control, or vector control with sensor is selected. Make sure that output is unstable except these controls.

Relation code

A044/A244 : control method selection
 C021 - C025 : multifunctional output selection
 C055 : Over torque level
 (forward driving)
 C056 : Over torque level
 (reverse regenerating)
 C057 : Over torque level
 (reverse driving)
 C058 : Over torque level
 (forward regenerating)

Setting item	Function code	Setting range	contents
multifunctional output selection	C021 - C025	07	OTQ: Over toeque signal
Over torque level (reverse driving)	C055	0. - 200.	Unit : %
Over torque level(forward regenerating)	C056	0. - 200.	Unit : %
Over torque level (reverse driving)	C057	0. - 200.	Unit : %
Over torque level (forward regenerating)	C058	0. - 200.	Unit : %

Chapter 4 Explanation of function

ALARM CODE OUTPUT(AC0 – AC3)

This is the function that inverter outputs trip factor as signal.

When 01(3bit) or 02(4bit) is selected in alarm code selection,

multifunctional output terminal , UPF1-X1 or UPF1-X2 compulsorily is outputted in alarm code.

Alarm code output is the following below.

Relation code	
C021 - C025	: multifunctional output selection
C062	: Alarm code selection

multifunctional output terminal				In 4bit code selection		In 3bit code selection	
X2	X1	DRV	UPF	Factor code	Contents of trip	Factor code	Contents of trip
AC3	AC2	AC1	AC0				
0	0	0	0	Normal	Normal	Normal	Normal
0	0	0	1	E01 – E04	Over current protection	E01 - E04	Over current protection
0	0	1	0	E05,E25	Overload protection	E05,E25	Overload protection
0	0	1	1	E07,E15	Over voltage Power source over voltage protection	E07,E15	Over voltage Power source over Voltage protection
0	1	0	0	E09	Lack voltage protection	E09	Lack voltage protection
0	1	0	1	E16	Instantaneous power-failure protection	E16	Instantaneous power failure protection
0	1	1	0	E30	IGBT error	E30	IGBT error
0	1	1	1	E06	Braking resistor overload protection	-	-
1	0	0	0	E08,E11,E23	EEPROM error, CPU error, GA error	-	-
1	0	0	1	E10	CT error	-	-
1	0	1	0	E12,E13, E35,E36	External trip, USP error, thermistor error, brake abnormal	-	-
1	0	1	1	E14	Grand fault protection	-	-
1	1	0	0	-	-	-	-
1	1	0	1	E21	Power module temperature	-	-
1	1	1	0	E24	Phase failure protection	-	-
1	1	1	1	E50 – E79	RS485, option 1,2 error 0 - 9	-	-

Setting item	Function code	Setting range	contents
Alarm code selection	C062	00	Invalid
		01	3bit code
		02	4bit code

FRQ terminal

The FRQ control terminal can monitor the output frequency and output current.

FRQ terminal is a PWM (Pulse Width Modulation) output.

(1) FRQ selection

Select a signal to output from the following options.

When 03(digital frequency) is set a digital frequency counter meter is required.

Use an analog meter for all other output signals.

Relation code	
C027:	FRQ selection
b081:	FRQ adjustment

Function code	Data	Description	Full scale value
C027	00	Output frequency (example 1)	0-Max. frequency(Hz)
	01	Output current (example 1)	0-200%
	02	Output torque (example 1) (note)	0-200%
	03	Digital output frequency (example 2)	0-Max. frequency(Hz)
	04	Output voltage (example 1)	0-100%
	05	Input electric power (example 1)	0-200%
	06	Thermal load ratio (example 1)	0-100%
	07	LAD frequency (example 1)	0-Max. frequency(Hz)

(Note) Display substitutes only at the time of the sensorless vector control, 0Hz domain sensorless vector control and vector control.

(Example 1) Set value:00, 01, 02, 04, 05, 06, 07

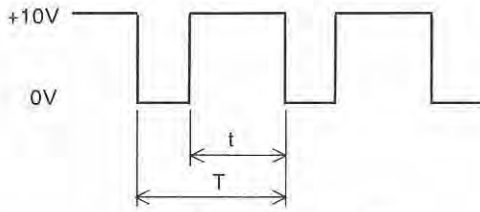

Period T: constant (6.4ms)
Duty t/T : change

(Example 2) Set value: 03

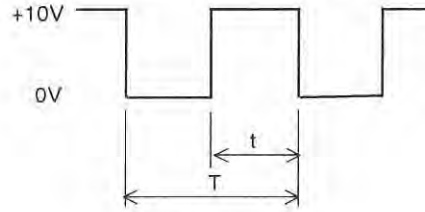

Period T: change
Duty t/T : 50%fixed

(2) FRQ adjustment

This function is used to calibrate a meter connected to the FRQ terminal.

Function code	Set range	Description
b081	0. -255.	Change one by one.

(calibration methods)

(1) Connect meter to FRQ-BC.

(2) Adjust b081 so that the meter is reading the same as the output frequency on your scale.

(Example) When output frequency is 60Hz, change value of b081 so that meter is 60Hz.

AMV , AMI terminal

The AMV terminal and the AMI terminal can monitor the output frequency or the output current.

The AMV terminal has an analog output of 0-10V.

The AMI terminal has an analog output of 4-20mA.

Relation code
b080 : AMV adjustment
C028 : AMV selection
C029 : AMI selection
C086 : AMV offset adjustment
C087 : AMI adjustment
C088 : AMI offset adjustment

(1) AMV, AMI selection

Select a signal to output from the following options;

Set item	Function code	Data	Contents	Full scale value
AMV selection/ AMI selection	C028/C029	00	Output frequency	0-Max. frequency(Hz)
		01	Output current	0-200%
		02	Output torque (note)	0-200%
		04	Output voltage	0-100%
		05	Input electric power	0-200%
		06	Thermal load ratio	0-100%
		07	LAD frequency	0-Max. frequency(Hz)

(Note) Display substitutes only at the time of the sensorless vector control, 0Hz domain sensorless vector control and vector control.

(2) AMV adjustment, AMI adjustment

This function is used to calibrate a meter connected to the AMV and AMI terminal.

Set item	Function code	Data	Description
AMV adjustment	b080	0. -255.	After offset adjustment with C086, adjust according to memory.
AMV offset Adjustment	C086	0.0-10.0	Units:V
AMI adjustment	C087	0. -255.	After offset adjustment with C088, adjust according to memory.
AMI offset adjustment	C088	0.0-20.0	Units:mA

External thermistor

Temperature protection of the external machine is possible by the use of a Thermistor fitted to your motor.

Wire the thermistor between control terminals TH and BC.

Set the following function according to the thermistor specification.

Relation code

- b098: Thermistor selection
- b099: Thermistor error level
- C085: Thermistor adjustment

Set item	Function code	Set value	Contents
Thermistor selection	b098	00	Invalid (No temperature protection by external thermistor)
		01	Valid normal temperature/factor resistance element (For PTC)
		02	Valid (For NTC)
Thermistor error level	b099	0. -9999.	Units:OHM Set the resistance value of temperature for trip according to thermistor methods.
Thermistor adjustment	C085	0.0-1000.	Use this as gain adjustment.

Initialization setting

It is possible at any time to reinitialize the Inverter parameters back to their factory default. The trip history can also be cleared at any time, however, if problems occur it will be difficult to fault find without the trip history for reference.

Initialization details are as follows;

Relation code

- b084: initialization selection
- b085: Initial data selection

Set item	Function mode	Data	Description
Initialization selection	b084	00	This clears only trip history.
		01	This only initializes setting value. Setting value becomes the state on factory forwarding.
		02	This clears trip history and initializes setting.
Initial data Selection	b085	00	Initializing setting for Japan.

(Initialization methods)

After setting the above parameters, initialize as follows;

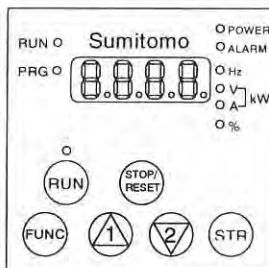

(1) Hold down the FUNC, UP and DOWN key and then press the STOP/RESET key. When the display starts to flash and rotate release all the keys.

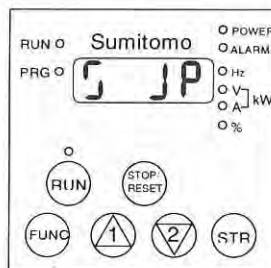

(2) During initializing
Above display is for Japan.
Other displays are below.

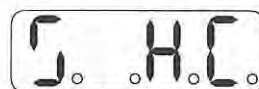

During initializing of trip history.

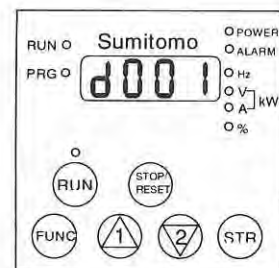

(3) When "d001" is displayed in the monitor, initialization is complete.

Chapter 4 Explanation of function

Display selection

This function can be used to limit what the digital operator can display.

Relation code
 b037 :Display selection
 U001-U012 : User selection

Set item	Function code	Data	Description
Display selection	b037	00	All display
		01	Function individual display (Display, no display by item set)(example1)
		02	User setting and b037 Only item set by user selection of U001-U012 is displayed. (Set U001-U012 first.)
User selection	U001-U012	no	No assignment.
		d001-P032	Select the code to display. (All code is an object.)

(Example1) When the Display selection (b037) is set to 02, only the programmed parameters are displayed. To set which parameters are displayed insert code groups in parameter U001-U012.

The table below shows which parameter groups can be displayed and what code is used in U001-U012.

No	Function to restrict display	Data	Code to be restricted display.	Note
1	A001	01	A005,A006,A011-A016,A101-A105, A111-A114,C081-C083,C121-C123	VRF,IRF,VRF2 terminal function
2	A002	01,03,04,05	b087	Stop key function
3	A019	00	A028-A035	Multi-speed function
	C001-C008	02,03,04,05		
4	A044,A244	02	b100-b113	Control methods
5	A051	01	A052-A059	DC braking
6	A071	01	A072-A076,C044	PID function
7	A094	01	A095-A096	2 stage adjustable frequency
8	A294	01	A295-A296	
9	b013,b213,b313	02	b015-b020	Electric thermal characteristic
10	b021	01,02	b022,b023	Overload restriction
11	b024	01,02	b025,b026	Overload restriction2
12	b095	01,02	b090,b096	DBTR function
13	C001-C008	06	A038,A039	Jogging
14		08	F202,F203,A203,A204,A220, A241-A244,A261,A262,A292-A296, b212,b213,H202-H206, H220-H224,H230-H234,H250-H252,H260	B-mode control
15		11	b088	Free-run stop
16		17	F302,F303,A303,A304,A320, A342-A344,A392,A393,b312,b313,H306	C-mode control
17		18	C102	Reset
18	27,28,29	C101	UP/DWN	
19	A044	00,01	A041-A043	Torque boost function
20		04	H060	0Hz SLV limiter
21	A244	00,01	A241-A243	torque boost function
22		04	H260	0Hz SLV limiter
23	A044	03,04,05	b040-b046, H001 H070-H072	Vector control
	A244	03,04		
24	A097	01,02,03	A131	Acceleration pattern constant
25	A098	01,02,03	A132	Deceleration pattern constant
26	b098	01,02	b099,C085	Thermistor function
27	b050	01	b051-b054	Instantaneous power failure nonstop
28	b120	01	b121-b126	Brake control
29	C021-C025,C026	02,06	C042,C043	Frequency arrival signal
30		03	C040,C041	Overload advance notice
31		07	C055-C058	Over torque
32		21	C063	Zero speed detection signal
33		24,25	C045,C046	Frequency arrival signal
34		26	C111	Overload advance notice 2

Chapter 4 Explanation of function

No	Function to restrict display	Data	Code to be restricted display.	Note
35	H002	00	H020-H024	Motor constant
		01,02	H030-H034	Motor constant (Auto-tuning)
36	H202	00	H220-H224	Motor constant
		01,02	H230-H234	Motor constant (Auto-tuning)
37	P010	01	P011-P023,P025-P027	Option function

Stabilized factor

When the motor is hunting or unstable, this function can be adjusted to help stabilize the motor.

Relation code
H006/H206/H306: stabilized factor

When the motor is unstable, check the allowable motor selection (H003/H203) and motor pole selection (H004/H204) with your motor. If their code data is different from your motor specification, set the right data.

When R1 of usage motor is less than R1 of regular motor, raise the set value of H006/H206 gradually.

When you operate greater motor than rated capacity of inverter, lower the set value of H006/H206.

The following two functions can also assist to reduce hunting or rattling of a motor.

- (1) Lower the carrier frequency (b083).
- (2) Lower the output voltage gain (A045).

Set item	Function code	Data	Description
Output gain	A045	20. -100.	Units :% Lower this when hunting occurs.
Carrier frequency	b083	0.5-15.0	Units :kHz Lower this when hunting occurs.
Stabilized factor	H006/H206/H306	0. -255.	Raise or lower when hunting occurs.

Operation selection on option error

When an add-in option is the cause of a protective trip this function can be used to switch the trip facility off and allow the inverter to carry on in its operation.

Relation code
P001: Option 1 operation selection on error
P002: Option 2 operation selection on error

Set item	Function code	Data	Description
Operation selection on optional error	P001/P002	00	TRP: inverter trip and output alarm when option error occurs.
		01	RUN: inverter ignores this and continues operation when option error occurs.

Motor constant

Set each constant according to the motor you use.

Relation code
H003/H203: allowable motor selection
H004/H204: motor pole selection

In case of using several motors in parallel, set the constant values that are closest to the total capacity of the belonging motor.

Reduced torque or instability may occur while using auto torque boost function if these settings are incorrect.

BRAKING CONTROL FUNCTION

This is a function that the inverter controls external braking used in systems like elevators. By braking control function selection(b120) is set to valid(01), this function is performed as the following below.

- (1) When running command turns on, the inverter begins to operate and accelerate to releasing frequency.
- (2) After output frequency arrives releasing frequency, the inverter outputs braking releasing signal (BRK) after waiting for the time for confirmation of releasing braking which is set in (b121).
However, if output current of the inverter is within releasing current which is set in (b121), braking releasing signal would not output, the inverter would occur the trip and output braking error signal (BER).
- (3) When braking confirmation signal (BOK) is set to multifunctional input terminal (when 44 is set to C001 – C008),
if braking releasing signal is outputted, the inverter would not accelerate during just waiting time for braking confirmation which is set in (b124).
If braking confirmation signal is not inputted within waiting time for braking confirmation, the inverter would output braking error signal (BER) and would occur the trip
If braking confirmation signal is not set to multifunctional input braking terminal, the waiting time for braking confirmation would be invalid, and after the inverter would output braking releasing signal, proceed to (4).
- (4) After braking confirmation signal is inputted(after braking releasing signal is outputted when BOK is not selected), the inverter waits for the time for acceleration, and then begins to accelerates again and accerates to the frequency.
- (5) When running command turns off, the inverter decelerates to releasing frequency and turns braking releasing signal(BRK) off.
- (6) When braking confirmation signal (BOK) is set to multifunctional input terminal(when 44 is set to C001 – C008),
after braking releasing signal turns off, the inverter would not decelerate during just the waiting time for braking confirmation which is set in (b124), and would wait for braking confirmation signal turning off.
If braking confirmation signal does not turn off within the waiting time for braking confirmation, the inverter would output braking error signal (BER) and would occur the trip
If braking confirmation signal is not set to multifunctional input braking terminal, the waiting time for braking confirmation would be invalid and after the inverter would output braking releasing signal, proceed to (7).
- (7) After braking confirmation signal turns off (after braking releasing signal turns off), the inverter waits for the waiting time for stop, and then begins to decelerate again and decelerates to 0 Hz

Relation code

b120 : Braking control selection
 b121 : Waiting time for releasing braking conformation
 b122 : Waiting time for acceleration
 b123 : Waiting time for stop
 b124 : Waiting time for signal conformation
 b125 : Releasing frequency
 b126 : Releasing current
 C001 - C008 : multifunctional input terminal
 C021 - C025 : multifunctional output terminal

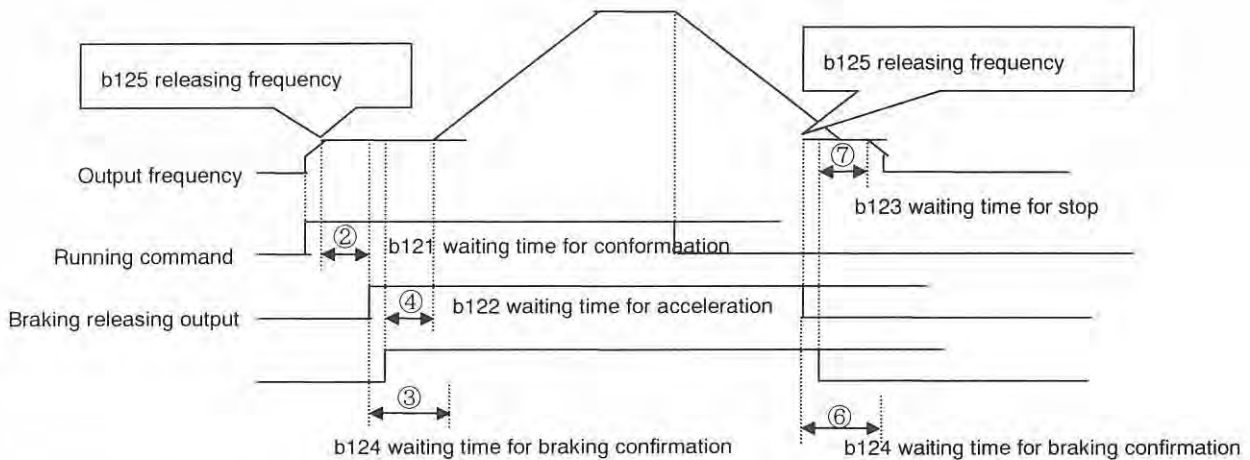

Note) Timing chart that braking confirmation signal(44:BOK) is selected to multifunctional input terminal.

When braking control function is used, if necessary, assign the following functions to multifunctional input / output terminals.

When signal outputted from external braking during releasing braking is inputted to inverter, one of multifunctional output terminals (C001 - C008) should be assigned braking confirmation signal : BOK(44)

One of multifunctional output terminals (C021 – C025) should be assigned tobraking signal : BRK(19) to release braking.

And when output signal at the time of braking trouble is used, signal of braking trouble : BER(20) should be assigned.

When braking control function is used, sensorless vector control (A44 to 03) or 0Hz domain sensorless vector control (A11 to 04) which generates high torque at starting should be recommended.

Setting item

Code	Function name	Setting range
b120	Braking control function selection	00(invalid)/01 (valid)
b121	The waiting time for braking releasing confirmation	0.00 - 5.00 s
b122	Waiting time for acceleration	0.00 - 5.00 s
b123	Waiting time for stop	0.00 - 5.00 s
b124	Waiting time for braking confirmarion	0.00 - 5.00 s
b125	Releasing frequency	0.00 - 99.99/100.0 - 400.0 Hz
b126	Releasing current	50% of the rated curret – 200% of the rated current

b121 : Set the time when output current arrives at releasing current after arriving at releasing frequency.

b122 : Set the mecanical late time to release braking from releasing signal outputting.

b123 : Set the mecanical late time to stop braking from releasing signal off.

b124 : Set the more time to input releasing stop signal which braking outputs from releasing signal.

b125 : Set frequency to output braking releasing signal. Set up a bigger value than the start frequency.

b126 : Set output current to permit braking releasing. Be sure that the motor would slip down easily if setting current is low

In the following case, the inverter occurs trip and outputs braking error signal(BER). (braking error : E36)

In the case that output current is less than releasing curret after waiting time for braking releasing confirmation.

When braking confirmation signal is used, in the case that braking confirmation signal does not turn on within waiting time for braking confirmation druing accelerating. In the case that braking confirmation signal does not turn off within waiting time for braking confirmation or braking confirmation signal turns off although braking releasing signal is outputted, during decelerating

OFFLINE AUTOTUNING FUNCTION

This is a function for measuring and automatically setting the motor circuit constant necessary for the sensorless vector control and 0Hz domain sensorless vector control.

When the sensorless vector control and the 0Hz domain sensorless vector control is performed by using the motor whose circuit constant is unknown, please measure the motor circuit constant by the offline autotuning function.

When 00(general purpose motor) in motor constant selection (H002) is set, general purpose motor is given a constant which is initial value.

In most case, the characteristics will be obtained without trouble, even if offline autotuning is not executed. (When online autotuning function mentioned later is performed, please be sure to operate offline autotuning)

This function acts only the normal-mode. Do not operate it in the B/C-mode.

Relation code

- H001 : Autotuning selection
- H002 : motor constant selection
- H003 : motor capacity selection
- H004 : motor pole selection
- H030 : autotuning motor constant R1
- H031 : autotuning motor constant R2
- H032 : autotuning motor constant L
- H033 : autotuning motor constant I_0
- H034 : autotuning motor constant J
- A003 : base frequency
- A051 : DC braking selection
- A082 : Motor voltage selection

Setting item	Function code	Setting range	Contents
Autotuning selection	H001	00 01 02	Invalid Valid(the motor does not rotate) Valid(the motor rotates)
Normal-mode motor constant selecton	H002	00 01 02 03 04	SHI general purpose motor data SHI AF motor data SHI explosion-proof motor Autotuning data Autotuning data (online autotuning valid)
motor cpacity selection	H003	0.2 – 55.0	Unit : kW
motor pole selection	H004	2/4/6/8	Unit : Pole
autotuning motor constant R1	H030	—	Unit : ohm
autotuning Motor constan R2	H031	—	Unit: ohm
autotuning motor constant L	H032	—	Unit : mH
autotuning motor constant I_0	H033	—	Unit : A
autotuning motor constant J	H034	—	Unit : kgm2
base frequency	A003	30 – Maximum frequency	Unit : Hz
DC braking selection	A051	00 01	Invalid Valid
Motor voltage selection	A082	200/215/220/230/240 380/400/415/440/460/480	When inverter is 200V class, it is possible to select When inverter is 400V class, it is possible to select

Precautions

- (1) Fit motor base frequency (A003) and motor voltage selection (A082) to the specification of the motor measured.
- (2) Motor capacity to be measured is one frame or less maximum applicable motors. If not within this range, correct constant is not measured.
- (2)By this function, the motor capacity to be measured is between the maximam applicable frame and under.
From the outside motor to be not driven.
- (3) In the state that the DC braking selection (A051) is set validly(01), the accurate motor constant will not be measured. Please set

DC

braking selection invalidly(02). (Initial value is invalid.)

(4) In the case of selecting (02) that the motor rotates in autotuning selection(H001), be cautious the following points.

- 1) It causes no trouble to accelerate up to 80% of the base frequency,
- 2) Do not execute the motor from outside.
- 3) Release the braking.
- 4) Torque is not enough during autotuning. In application like an elevator, as it is possibility to slip down.

The motor should be removed from the machine of the load and excute autotuning by itself.

(In this case, as nertia motor J is motor itself, add the motor shaft converting value to nertia motor.)

- 5) In the machine restricted the motor shaft revolution permit (elevator, ball screw, and so on), the mode (01) should be selected in which operates autotuning without rotating.

(5) In spite of selecting the mode (01) that the motor does not rotates, the motor sometimes rotates.

(6) When operating autotuning by using one class low motor. Validate overload restriction function, then set the overload restriction level 1.5 times as high as rated output current of motor.

Setting method

- (1) Set the autotuning selection (H001) to 01 or 02.
- (2) Turn the Run command On.

After turning the Run command on, the motor automatically runs in the following order of (1) to (7).

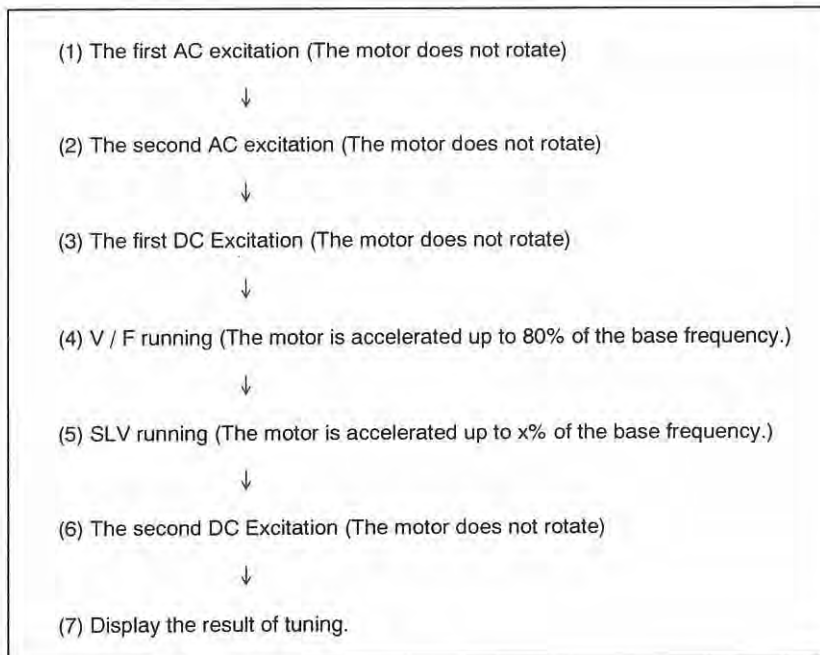

Cautions

- (1) When attuning (set H001 to 01) that the motor does not rotates is selected, (4) and (5) will not be performed.
- (2) Revolution of (5) is like the following.

$T < 50s$	-----	$x = 40%$
$50s < T < 100s$	-----	$x = 20%$
$100s \leq T$	-----	$x = 10%$

(3) When autotuning operation terminates, the following is displayed.



When the autotuning operation terminates abnormally, please execute the autotuning again.

(When one of the keys is pressed, the display stops.)

(4) When a trip occurred during the autotuning, the autotuning is forced to terminate.

(Abnormal termination is not displayed. The display of a trip has priority.)

After eliminating the cause of the trip, execute the autotuning again.

(5) If the autotuning is interrupted by power off (with the stop key or turning the run command off), the constant for autotuning may keep inside.

After making an initialization and reset the setting range, carry out autotuning again.

(In the case of normal running, do in the same way)

(6) Unusual completion is indicated, and a control form finishes treatment when offline autotuning is carried out at the time of the condition of a free V/F setting.

MOTER CONSTANT SELECTION

Motor constant used in sensorless vector control and 0Hz domain sensorless vector control and vector control with sensor can be selected from the following the three.

- (1) SHI general purpose motor constant, AF motor constant and explosion-proof motor constant.
- (2) motor constant measured in offline autotuning
- (3) Optional setting motor constant

When selecting C-mode, motor constant in normal-mode appears.

Setting item	Function code	Setting range	Contents
Each mode control method	A044/A244/A344	00	Constant torque characteristics
		01	Reduced torque characteristics
		02 (Note1)	V/F free setting
		03 (Note1)	Sensorless vector control
		04 (Note1)	0 Hz domain sensorless vector control
		05 (Note1)	FB optional vector control
motor constant selection (Note2)	H002	00 01 02 03 04	SHI general purpose motor constant SHI AF motor constant SHI explosion-proof motor Autotuning constant Autotuning constant (online autotuning valid)
motor capacity selection	H003	0.2 - 75.0	Unit : kW
motor pole selection	H004	2/4/6/8	Unit : pole
motor constant R1	H020	0.000 - 65.53	Unit : ohm
motor constant R2	H021	0.000 - 65.53	Unit : ohm
motor constant L	H022	0.00 - 655.3	Unit : mH
motor constant Io	H023	0.00 - 655.3	Unit : A
motor constant J	H024	0.001 - 9999.	Unit : kgm2
autotuning motor constant R1	H030	0.000 - 65.53	Unit : ohm
autotuning motor constant R2	H031	0.000 - 65.53	Unit : ohm
autotuning motor constant L	H032	0.00 - 655.3	Unit : mH
1 st autotuning motor constant Io	H033	0.00 - 655.3	Unit : A
1 st autotuning motor constant J	H034	0.001 - 9999.	Unit : kgm2

(Note1) In normal-mode control method, it is possible to select setting range 00 - 05.

In B-mode control method, it is possible to select setting range 00 - 04.

In C-mode control method, it is possible to select setting range 00 - 01.

(Note2) The second motor constant selection uses it with 00 (general purpose motor constant).

Optional setting of motor constant

When motor constant is set optionally, function code is as the following below.

Normal-mode control is valid and motor constant is 00 → Input H020 - H024 directly.

Normal-mode control is valid and motor constant is 01/02 → Input H030 - H034 directly.

B-mode control is valid and motor constant is 00 → Input H220 - H224 directly.

When offline autotuning is not executed, in H030/H230 - H034/H234, the same frame constant as the constant (general purpose motor constant) is set.

ONLINE AUTOTUNING FUNCTION

Online autotuning can revise the motor constant by increase of temperature, and stabilize running.

This function acts only the normal-mode control. Do not operate it in the B/C-mode control.

Setting item	Function code	Setting range	Contents
Motor constant selection	H002/H202	00	general purpose motor data
		01	Autotuning data
		02	Autotuning data (Online autotuning data valid)

Precautions

- (1) Be sure to execute offline autotuning before executing online autotuning.
- (2) Be sure to execute autotuning once when SHI general purpose motor, as the data for online autotuning is computed during off-line autotuning.
- (3) After the motor stops, online autotuning runs for maximum 5s. (DC Excitation is carried out 1 time for tuning of R1 and R2. Furthermore, this result is not reflected to the display.) If the run command is input during this time, it is given priority to online autotuning. Online autotuning terminates halfway. (The tuning result is not reflected.)
- (4) If DC braking is set when the motor stops, online autotuning is executed after DC braking operation terminates.

Setting method

- (1) Set the motor constant selection (H002/H202) to the data of autotuning that is valid online tuning.
(Give the auto tuning selection (H001) as the ineffectiveness (00).)
- (2) Input the run command. Online auto tuning is carried out automatically at the time of the stoppage.

SENSORLESS VECTOR CONTROL

- This function is the method that the revolution of motor and output torque are estimated by output current, voltage of the inverter and motor constant of setting. It is possible to operate high starting torque and high accuracy at low frequency(0.5Hz).
- In the case of using this function, please set 03 in A044/A244.
- In the case of using this function, please set surely the suitable motor constant of using the motor according to the parameter of "selection of motor constant" .

Caution!

- If the inverter operates less than twice capacity for the maximum adopted motor, the full performances may not be demonstrated.
- If satisfactory performance can not be obtained, please adjust the motor constant for the phenomena according to following table.
- Please use carrier frequency in more than 2.1kHz absolutely. Inverter can't operate normally in less than 2.1kHz.

Reference code

A001	: Frequency commanding method
A044/A244	: Control method
F001	: Output frequency setting
b040	: Selection of torque limit
b041-b044	: Torque limit of 4zone
H002, H202	: Selection of first, second motor constant
H003, H203	: Selection of first, second motor capacity
H004, H204	: Selection of first, second motor pole
H005, H205	: normal/B-mode speed response
H020, H220	: normal/B-mode motor constant R1
H021, H221	: normal/B-mode motor constant R2
H022, H222	: normal/B-mode motor constant L
H023, H223	: normal/B-mode motor constant I0
H024, H224	: normal/B-mode motor constant J
H050, H250	: normal/B-mode PI proportion gain
H051, H251	: normal/B-mode PI integration gain
H052, H252	: normal/B-mode P proportion gain

Status of running	Phenomena	Contents of adjustment	Adjusting parameter
Driving	Speed fluctuation is minus	Set "Motor constant R2" bigger and bigger slowly until 1.2 times for preset constant.	H021,H221
	Speed fluctuation is plus	Set "Motor constant R2" smaller and smaller slowly until 0.8 times for preset constant.	H021,H221
Regenerating	Lack of torque at low frequency	Set "Motor constant R1" bigger and bigger slowly until 1.2 times for preset constant.	H020,H220
		Set "Motor constant I0" bigger and bigger slowly until 1.2 times for preset constant.	H023,H223
At starting	The shock is occurred at starting	Set "Motor constant J" bigger and bigger slowly until 1.2 times for preset constant.	H024,H224
At deceleration	Unstable of motor rotation	Set speed response smaller.	H005,H205
		Set "Motor constant J" smaller for preset Constant.	H024,H224
During torque limit	Insufficient torque during torque limit at low speed	Set overload restriction level lower than torque limit level.	b021 b041-b044
At low frequency operation	Irregular of rotation	Set "Motor constant J" bigger for preset constant.	H024,H224

Note: 1 Use career frequency over 2.1kHz certainly. It doesn't operate correctly under 2.1kHz.

2 When using one class low motor against the inverter, Torque limit setting value (b041 – b044) is from following formula and T value is calculated by following formula. Don't set T over 200% otherwise it will cause of motor failure.

Formula A: $T = \text{Torque limit setting value} \times (\text{Inverter capacity}) / (\text{Motor capacity})$

(Example) Inverter 0.75kW, At motor 0.4kW, Torque limit setting value that is for $T = 200\%$ become from formula A.

$$\begin{aligned} \text{Torque limit setting value (b041 – b044)} &= T \times (\text{motor capacity}) / (\text{inverter capacity}) \\ &= 200\% \times (0.4\text{kW}) / (0.75\text{kW}) = 106\% \end{aligned}$$

0 Hz DOMAIN SENSORLESS VECTOR CONTROL

When this function is performed, raised torque running is possible in 0Hz range (0-2.5 command) by original torque control.

When this function is performed, set A004 in 04.

When this function is performed, set the motor most applicable setting, properly according to the another item motor constant selection'.

Precautions

- (1) Set the inverter one frame up of the motor.
- (2) If this inverter operates less than twice capacity for the maximum adopted motor, the full performance may not be demonstrated.
- (3) If satisfactory characteristics can not be obtained during the 0Hz sensorless vector running, please adjust motor constant for the phenomena according to the following table.
- (4) Please use carrier frequency in more than 2.1kHz absolutely. Inverter can't operate normally in less than 2.1kHz.

Relation code

A001	: frequency command selection
A044/A244	: control method
F001	: frequency command setting
b040	: torque limit selection
b041-b044	: 4zone torque limit
H002/H202	: normal/B-mode motor constant selection
H003/H203	: normal/B-mode motor capacity selection
H004/H204	: normal/B-mode motor pole selection
H005/H205	: normal/B-mode speed response
H020/H220	: normal/B-mode motor R1
H021/H221	: normal/B-mode motor R2
H022/H222	: normal/B-mode motor L
H023/H223	: normal/B-mode motor lo
H024/H224	: normal/B-mode motor J
H050/H250	: normal/B-mode PI proportion gain
H051/H251	: normal/B-mode PI integration gain
H052/H252	: normal/B-mode P proportion gain
H060/H260	: normal/B-mode 0 SLV limiter

Status of running	Phenomena	Contents of adjustment	Adjusting parameter
Driving	Speed fluctuation is Minus	Set "Motor constant R2" bigger and bigger slowly until 1.2 times for preset constant.	H021/H221
	Speed fluctuation is plus	Set "Motor constant R2" smaller and smaller slowly until 0.8 times for preset constant.	H021/H221
Regenerating	Lack of torque at low frequency	Set "Motor constant R1" bigger and bigger slowly until 1.2 times for preset constant.	H020/H220
		Set "Motor constant I0" bigger and bigger slowly until 1.2 times for preset constant.	H023/H223
At starting	The shock is occurred at starting	Set "Motor constant J" bigger and bigger slowly until 1.2 times for preset constant.	H024/H224
At deceleration	Unstable of motor rotation	Set speed response smaller.	H005/H205
		Set "Motor constant J" smaller for preset constant.	H024/H224
At low frequency operation	Irregular of rotation	Set "Motor constant J" bigger for preset constant.	H024/H224

Note: 1 Ues career frequency over 2.1kHz certainly. It doesn't operate correctly under 2.1kHz.

2 Torque limit setting value (b041 – b044) is from following formula and T is calculated by following formula. Don't set T over 200% otherwise it will cause of failure.

Formula A: $T = \text{Torque limit setting value} \times (\text{inverter capacity}) / (\text{Motor capacity})$

(Example) Inverter 0.75kW, At motor 0.4kW, Torque limit setting that is for T = 200% become from formula A

Torque limit setting value (b041 – b044) = $T \times (\text{Motor capacity}) / (\text{Inverter capacity})$

$$= 200\% \times (0.4\text{kW}) / (0.75\text{kW}) = 106\%$$

TORQUE MONITOR FUNCTION

This is a function for monitoring motor presumed output torque when sensorless vector control, 0Hz domain sensorless vector control, and vector control with sensor are selected in selection method.

When monitor is carried out in digital operator, select display code d012.

When monitor is carried out in control terminal, refer to the explanation about another section of the chapter4, FRQ terminal, AMV terminal, or AMI terminal.

When control method is selected VC, VP1.7 power or free V/f setting, take care that this function is invalid, and display or output signal of control terminal is unstable.

Torque monitor value of this function displays 100% output torque when the motor rotates at synchronized revolution in the rated frequency equivalent to the rated output of the motor.

This function presumes output torque prior to motor current, therefore error is about 20% when the motor which output is same as inverter is used.

Relation code	
A044/A244	: normal/B-mode control method
C027	: FRQ selection
C028	: AMV selection
C029	: AM I selection
H003/H203	: normal/B-mode motor capacity selection
H004/H204	: normal/B-mode motor pole selection

Setting item	Function Code	Setting range	Contents
Control method selection	A044/A244	(00)	VC
		(01)	VP1.7 power
		(02)	Vf free setting (A344 is not)
		03	SLV (A344 is not)
		04	0 Hz domain SLV (A344 is not)
		05	V2 (A344/A244 is not)
FRQ selection	C027	(00)	Output frequency
		(01)	Output current
		02	Output torque
		(03)	Digital output frequency
		(04)	Output voltage
		(05)	Input electric power
		(06)	Thermal load rate
		(07)	LAD frequency
AMV selection	C028	(00)	Output frequency
		(01)	Output current
AM1selection	C029	02	Output torque
		(04)	Output voltage
		(05)	Input electric power
		(06)	Thermal load rate
		(07)	LAD frequency
Motor capacity selection	H003/H203	0.20 - 75.0	Unit : KW
Motor pole selection	H004/H204	2/4/6/8	Unit : pole

TORQUE LIMIT FUNCTION

This function limits motor output torque when sensorless vector control, 0 Hz domain sensorless vector control, or vector control with sensor are selected.

Relation code	
A044/A244	: normal/B-mode control method
b040	: Torque limit selection
b041 - b044	: Torque limit 1 - 4
C001 - C008	: multifunctional input selection
C021 - C025	: multifunctional output selection

In torque limit function method, the following three are selected in b040 torque limit selection screen.

1) 4 zone individual setting mode

This mode sets torque limit in 4 zones, forward driving and regenerating, reverse driving and regenerating, to digital operator setting code b041 - b044 individually.

2) Terminal changing mode

By combination of torque limit changing terminals 41(TRQ1)and 42(TRQ2), this mode changes and uses torque limit 1 - 4

set by in digital operator setting. Selected torque limit range is valid in every driving condition.

3) Analog input mode

This mode sets torque limit value by voltage given to 02 terminal of control terminal. 0 - 10V is equal to torque limit value 0 - 200%. Selected torque limit value is valid in every driving condition.

4) Option1,Option2

It comes into valid when using the option board.

Refer to option instruction manual.

When torque control valid / invalid function (TL) is set to multifunctional input terminal, torque limit function is valid only during the signal turning ON. During OFF, torque limit setting is invalid, torque control value is 200% of maximum.

And when torque control valid / invalid function (TL) is not set, torque limit function is always valid.

Torque limit value in this function is 200% of maximum current which inverter can output. Therefore, output torque may change in accordance with motors combined. Make sure that the absolute value of torque is not appeared.

When torque control signal is selected in multifunctional output selection, torque limit signal above mentioned turns ON while torque limit function is performed.

Setting item	Function Code	Setting range	contents
Control method selection	A044/A244	(00)	VC
		(01)	VP 1.7power
		(02)	Vf free setting (A344is not)
		03	SLV (A344 is not)
		04	0 Hz domain (A344is not)
		05	V2 (A244/A344 is not)
Torque limit selection	b040	00	4 zone individual setting
		01	Terminal changing
		02	Analog input
		03	Option 1
		04	Option 2
Torque limit 1	b041	0 - 200	Unit : %(forward driving in 4 zone individual setting)
Torque limit 2	b042	0 - 200	Unit : %(reverse regenerating in 4 zone individual setting)
Torque limit 3	b043	0 - 200	Unit : %(reverse driving in 4 zone individual setting)
Torque limit 4	b044	0 - 200	Unit : %(forward regenerating in4 zone individual setting)
Multifunctional input selection	C001 - C008	40	Torque control valid / invalid
		41	Torque limit switching 1
		42	Torque limit switching 2
multifunctional output selection	C021 - C025	10	During torque limit

- Torque limit when 00 (4 quadrant mode) is chosen by torque limit choice (b040) becomes the bottom figure.

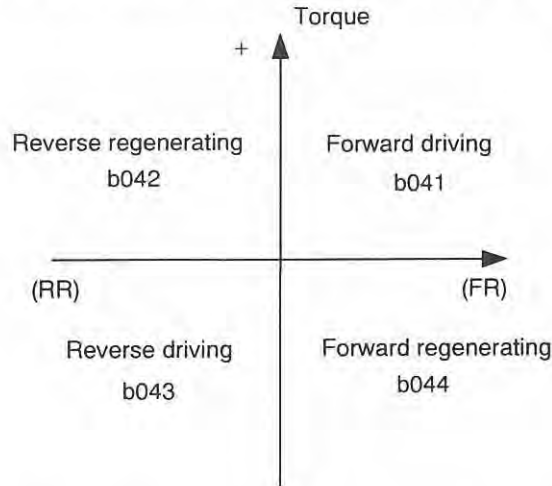

- When 01 (terminal switching) is chosen by torque limit choice (b040), torque limit 1 changed by torque limit switching 1,2 assigned to multifunctional input terminal - 4 are set up as the bottom figure.

(example) When torque limit switching 2 (42) was assigned to torque limit switching 1 (41), multifunctional input terminal RR in multifunctional input terminal DFL.

multifunctional input terminal

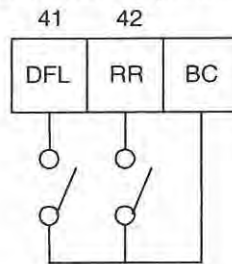

41(TRQ1) 42(TRQ2)

OFF	OFF	→	b041
ON	OFF	→	b042
OFF	ON	→	b044
ON	ON	→	b043

- When using torque limit function at low speed level, use overload restriction together.

TORQUE LADSTOP FUNCTION

This function temporarily stops frequency acceleration and deceleration function (LAD) when torque limit is performed, if sensorless vector control, 0 Hz domain sensorless vector, or vector control with sensor is selected

Relation code

A044/A244	: Control method
b040	: Torque limit selection
b041-b044	: 4 zone torque limit
b045	: torque LADSTOP selection

Setting item	Function code	Setting range	contents
Control method selection	A044/A244	00	VC
		01	VP 1.7power
		02	Vf free setting (A344 is not)
		03	SLV (A344 is not)
		04	0 HZ domain (A344is not)
		05	V2 (A244/A344 is not)
Torque limit selection	b040	00	4 zone individual setting
		01	Terminal changing
		02	Analog input
		03	Option1
		04	Option2
Torque limit 1	b041	0 - 200	Unit : %(forward driving in 4 zone individual setting)
Torque limit 2	b042	0 - 200	Unit : %(reverse regenerating in 4 zone individual setting)
Torque limit 3	b043	0 - 200	Unit : %(reverse driving in 4 zone individual setting)
Torque limit 4	b044	0 - 200	Unit : %(forward regenerating in4 zone individual setting)
Torque LADSTOP selection	b045	00	Valid
		01	Invalid
multifunctional input selection	C001 - C008	40	Torque control valid / invalid
		41	Torque limit switching 1
		42	Torque limit switching 2

Communication function

Serial communication is possible from the Inverter to any external equipment using RS485 protocol. This function is built-in as standard and is controlled by the TM2 control terminals.

Relation code

A001: Frequency selection
 A002: Operation command selection
 C070: Data command
 C071: Communication transmission speed
 C072: Communication code
 C073: Communication bit
 C074: Communication parity
 C075: Communication stop bit
 C078: Communication waiting time

(1) Communication specification

Item	Specification	Notes
Transmission speed	2400/4800/9600/19200 bps	Selection with operator
Communication methods	Half duplex communication methods	
Synchronizing methods	Direct current transmission	
Transmission code	ASCII code	
Transmission methods	Transmission from lower bit	
Communication interface	RS485	
Data bit	7/8 bit	Selection with Operator
Parity	No parity/even/odd	Selection with Operator
Stop bit	1/2 bit	Selection with Operator
Start methods	One-way start form by command of host side	
Waiting time	10-1000[ms]	Setting with operator
Connect form	1:N (N = Maximum 32)	Station number is selected with operator.
Error check	Overrun / Fleming / BCC / Vertical / Horizontal parity	

<RS485 port specification and connection>

Use TM2 of control terminal PCB for RS485 communication function.

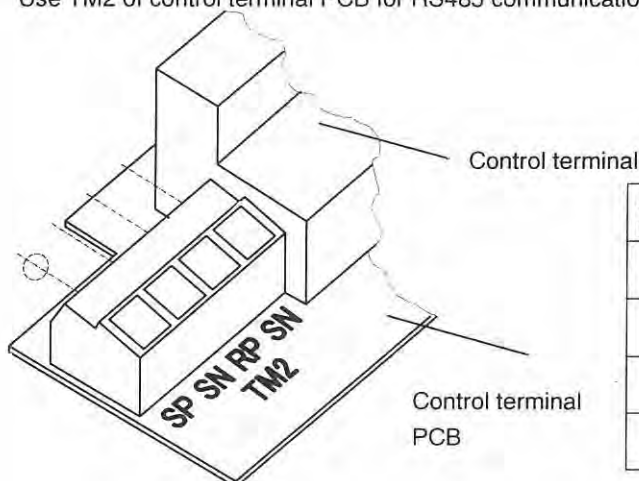

Abbreviation name	Description
S P	Transmission and Reception + side
S N	Transmission and reception - side
R P	Terminal resistance valid terminal
S N	Terminal resistance valid terminal

Chapter 4 Explanation of function

Connect each inverter in parallel as shown below. It is necessary to short terminals RP and SN on the last inverter in the link (even if communication is to only one inverter the link should still be made).

By shorting between RP and SN, the terminal resistance is increased and controls the reflection of the signal.

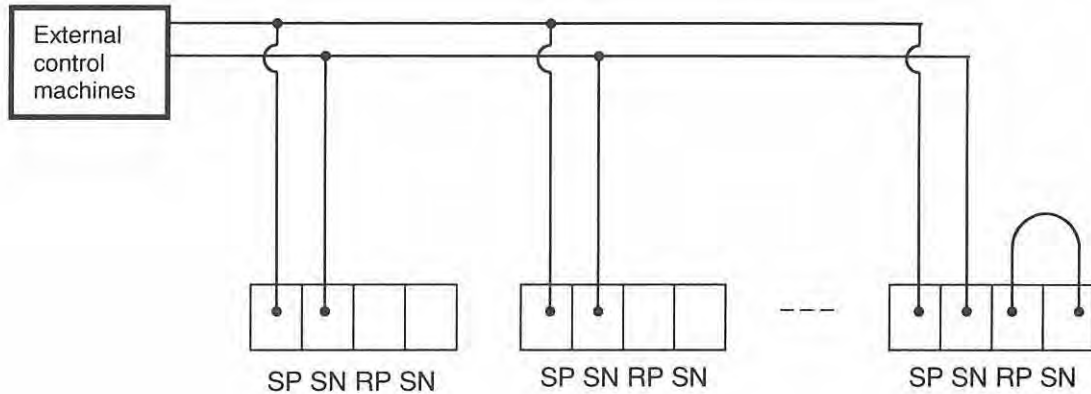

(2) Setting

The following settings are required to operate RS485 communication.

Set item	Function code	Set value	Description
Data command	C070	02	Operator
		03	RS485
		04	Option 1
		05	Option 2
Communicating transmission speed	C071	02	Loop-back test
		03	2400 bps
		04	4800 bps
		05	9600 bps
		06	19200 bps
Communication code	C072	1 to 32	This assigns the station number of the inverter. This is used when you control more than one simultaneously.
Communication bit	C073	7	7 bit
		8	8 bit
Communication parity	C074	00	No parity
		01	Even parity
		02	Odd parity
Communication bit	C075	1	1 bit
		2	2 bit
Communication waiting time	C078	0 to 1000	Units :ms Refer to it. (3)

(3) Communication protocol

The method of the communication protocol is shown below in the time diagram.

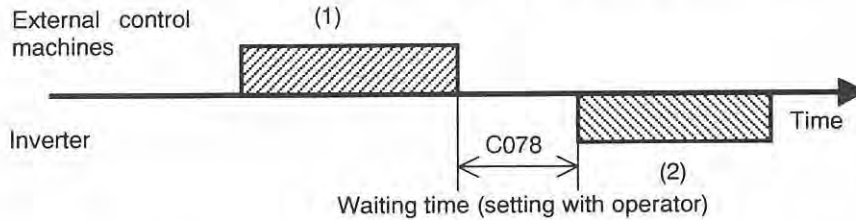

The following is indicated.

(1):Frame transmitted from external control machines to the inverter

(2):Frame replied from inverter to the external control machines

Frame (2) from the inverter is a reply to frame (1) from the external control machine, the active output is not operated.

The commands are shown below;

Command list

Command	Command description	Advisability of all code	Notes
00	Forward / backward / stop command	✓	
01	Setting of frequency command	✓	
02	Setting of multifunctional terminal state	✓	
03	Collective reading of monitor data	-	
04	Reading of inverter state	-	
05	Reading of trip history	-	
06	Reading of 1 setting item	-	
07	Setting of 1 set item	✓	
08	Returning of each set value to initial value	✓	This doesn't operate unless b084 is set to (01 or 02). (Clear of the trip origin)
09	This checks whether set value can be Conserved to EEPROM or not.	-	
0A	This conserves set value to EEPROM	✓	
0B	Recalculation of internal constant.	✓	

Chapter 4 Explanation of function

Explanation of each command is the following.

(i) 00 command : This controls the forward, backward and stop command. (Set up A002 in 03 in the case that this command is used.)

Transmission frame

Frame format

STX	Code	Command	Data	BCC	CR
-----	------	---------	------	-----	----

	Explanation	Data size	Value
STX	Control code (Start of TeXt)	1 byte	STX (0x02)
Code	Station number of inverter	2 byte	01-32, and FF(broadcast)
Command	Transmission command	2 byte	00
Data	Transmission data	1 byte	(Note1) Reference
BCC	Bloc check code	2 byte	Exclusive OR of Code, Command and Data
CR	Control code (Carriage Return)	1 byte	CR (0x0D)

Data	Description	Note
0	Stop command	
1	Forward command	
2	Reverse command	

(Note1)

(Example) when you transmit forward command to code 01

(STX)|01|00|1|(BCC)|(CR) → 02|30 31|30 30|31|33 30|0D
ASCII converter

Reply frame

On normal reply : (4) - (i) Reference

On abnormal reply : (4) - (ii) Reference

(ii) 01 command: This is to set frequency command. (Set up A001 in 03 in the case that this command is used.)

Transmission frame

Frame format

STX	Code	Command	Data	BCC	CR
-----	------	---------	------	-----	----

	Explanation	Data size	Value
STX	Control code (Start of TeXt)	1 byte	STX (0x02)
Code	Station number of inverter	2 byte	01-32, and FF (broadcast)
Command	Transmission command	2 byte	01
Data	Transmission data (tenth ASCII code)	6 byte	(Note2) Reference
BCC	Block check code	2 byte	Exclusive OR of Code, Command and Data
CR	Control code (Carriage Return)	1 byte	CR (0x0D)

(Note2) when you set code 01 for 5Hz

(STX)|01|01|000500|(BCC)|(CR)

ASCII conversion → 02|30 31|30 31|30 30 30 35 30 30|30 35|0D

Note) the data is 100 times as big as set value.

Example) 5(Hz) → 500 → 000500 → 30 30 30 35 30 30
ASCII conversion

Reply frame

On normal reply : (4) - (i) Reference

On abnormal reply : (4) - (ii) Reference

(iii) 02 command: This sets the state of the multifunctional terminals.

Transmission frame

Frame format

STX	Code	Command	Data	BCC	CR
-----	------	---------	------	-----	----

	Explanation	Data size	Value
STX	Control code (Start of TeXt)	1 byte	STX (0x02)
Code	Station number of inverter	2 byte	01-32, and FF (broadcast)
Command	Transmission command	2 byte	02
Data	Transmission data	16 byte	(Note3) reference
BCC	Block check code	2 byte	Exclusive OR of Code, Command and Data (5) Reference
CR	Control code(Carriage Return)	1 byte	CR (0x0D)

(Note3) Data (sixteenth) of multifunctional terminal and contents
(the details refer to multifunctional input terminal function.)

Data (Hex)	Description	Data (Hex)	Description
0000000000000001	FR: forward command	0000000010000000	PIDC: PID integral reset
0000000000000002	RR: reverse command	0000000020000000	-
0000000000000004	DFL: multi-speed1(binary operation)	0000000040000000	CAS: control gain switch functin
0000000000000008	DFM: multi-speed2(binary operation)	0000000080000000	UP: remote operation Accelerating speed
0000000000000010	DFH: multi-speed3(binary operation)	0000000100000000	DWN: remote operation Decelerate speed
0000000000000020	DFHH: multi-speed4(binary operation)	0000000200000000	UDC: remote operation data clear
0000000000000040	JOG: jogging(inching operation)	0000000400000000	-
0000000000000080	DB: external DC control	0000000800000000	OPE: Force operation ope
0000000000000100	BMD: B-mode control	0000001000000000	SF1: multi-speed(bit run)
0000000000000200	AD2: two stage adjustable speed	0000002000000000	SF2: multi-speed(bit run)
0000000000000400		0000004000000000	SF3: multi-speed(bit run)
0000000000000800	MBS: free-run stop	0000008000000000	SF4: multi-speed(bit run)
0000000000001000	EXP: external trip	0000010000000000	SF5: multi-speed(bit run)
0000000000002000	USP: unattended start protection	0000020000000000	SF6: multi-speed(bit run)
0000000000004000	CS: commercial change	0000040000000000	SF7: multi-speed(bit run)
0000000000008000	SFT: software lock (control terminal)	0000080000000000	OLR: overload restriction setting
0000000000010000	AUT: analog input voltage/current select	0000100000000000	TL: Torque limit
0000000000020000	CMD: C-mode control	0000200000000000	TRQ1: Torque limit 1 switch
0000000000040000	RST: reset	0000400000000000	TRQ2: Torque limit 2 switch
0000000000080000		0000800000000000	PPI: P/PI control switch
0000000001000000	STA: 3 wire start	0001000000000000	BOK: Brake confirmation
0000000002000000	STP: 3 wire holding	0002000000000000	ORT: Orientation command
0000000004000000	F/R: 3 wire forward	0004000000000000	LAC: LAD cancel
0000000008000000	PID: PID selection (valid/invalid)	0008000000000000	PCLR: Position error clear
		0010000000000000	STAT: Pulse train input permission

Example) When you make (forward), (multi-speed1) and (multi-speed2) active on inverter setting of code 01, the calculation of data is

$$0x0000000000000001 + 0x0000000000000004 + 0x0000000000000008 = 0x000000000000000D$$

so transmission frame is

(STX)|01|02|000000000000000D|(BCC)|(CR)

Reply frame

On normal reply : (4) - (i) Reference

On abnormal reply : (4) - (ii) Reference

(iv) 03 command: This reads monitor data collectively.

Transmission frame

Frame format

STX	Code	Command	BCC	CR	Replay frame
	Explanation		Data size	Value	
STX	Control code(Start of Text)		1 byte	STX (0x02)	
Code	Station number of inverter		2 byte	01-32	
Command	Transmission command		2 byte	03	
BCC	Block check code		2 byte	Exclusive OR of Code, Command and Data (5) Reference	
CR	Control code (Carriage Return)		1 byte	CR (0x0D)	

Frame format

STX	Code	Data	BCC	CR	Replay frame
	Explanation		Data size	Value	
STX	Control code (Start of TeXt)		1 byte	STX (0x02)	
Code	Station number of inverter		2 byte	01-32	
Data	Data		104 byte	(Note4) reference	
BCC	Block check code		2 byte	Exclusive OR of Code, Command and Data (5) Reference	
CR	Control code (Carriage Return)		1 byte	CR (0x0D)	

(Note4) Each monitor value

Monitor item	Units	Compe- titive rate	Data size	Explanation	
Output frequency	Hz	x100	8 byte	Tenth ASCII code	Upper bite-----lower bite
Output current	A	x10	8 byte	Tenth ASCII code	
Revolution direction	-	-	8 byte	0: stop, 1: forward, 2:backward	
PID feedback monitor	%	x100	8 byte	Tenth ASCII code	
Multifunctional input monitor	-	-	8 byte	*5) reference	
Multifunctional output monitor	-	-	8 byte	*6) reference	
Frequency converting monitor	-	x100	8 byte	Tenth ASCII code	
Output torque monitor	%	x1	8 byte	Tenth ASCII code	
Output voltage monitor	V	x10	8 byte	Tenth ASCII code	
Electric power monitor	kW	x10	8 byte	Tenth ASCII code	
-	-	-	8 byte	(00000000) padding data	
RUN time monitor	h	x1	8 byte	Tenth ASCII code	
ON time monitor	h	x1	8 byte	Tenth ASCII code	

(Note5) multifunctional input terminal monitor

Item	Data
FR terminal	00000001
RST terminal	00000002
ES terminal	00000004
JOG terminal	00000008
MBS terminal	00000010
AD2 terminal	00000020
DFM terminal	00000040
DFL terminal	00000080
RR terminal	00000100

(Note6) multifunctional output terminal monitor

Item	Data
AL	00000001
UPF terminal	00000002
DRV terminal	00000004
X1 terminal	00000008
X2 terminal	00000010
X3 terminal	00000020

(v) 04 command: This reads the state of the inverter.

Transmission frame

Frame format

STX	Code	Command	BCC	CR
	Explanation	Data size	Value	
STX	Control code(Start of TeXt)	1 byte	STX (0x02)	
Code	Station number of inverter	2 byte	01-32	
Command	Transmission command	2 byte	04	
BCC	Block check code	2 byte	Exclusive OR of Code, Command and Data (5) Reference	
CR	Control code(Carriage Return)	1 byte	CR (0x0D)	

Replay frame

Frame format

STX	Code	Data	BCC	CR
	Explanation	Data size	Value	
STX	Control code(Start of TeXt)	1 byte	STX (0x02)	
Code	Station number of inverter	2 byte	01-32	
Data	Data on trip	8 byte	(Note7) reference	
BCC	Block check code	2 byte	Exclusive OR of Code, Command and Data (5) Reference	
CR	Control code(Carriage Return)	1 byte	CR (0x0D)	

(Note7) The data to indicate status contents of inverter is constructed from the following three factors [A), B), C)].

Data	Status A	Status B	Status C	00 (reservation)
------	----------	----------	----------	------------------

Inverter status A)

Code	Status
00	Initial status
01	Vdc on waiting settlement
02	On stopping
03	On running
04	On FRS
05	On JOG
06	On DB
07	On reading frequency
08	On retrying
09	On UV
10	On TRIP
11	On waiting reset

Inverter status C)

Code	Status
00	---
01	Stop
02	Deceleration speed
03	Constant speed
04	Acceleration speed
05	Forward
06	Reverse
07	Reverse from forward
08	Forward from reverse
09	Forward start
10	Reverse start

Inverter status B)

Code	Status
00	On stopping
01	On running
02	On tripping

(vi) 05 command: This reads trip history data.

Transmission frame

Frame format

STX	Code	Command	BCC	CR
-----	------	---------	-----	----

	Explanation	Data size	Value
STX	Control code(Start of TeXt)	1 byte	STX (0x02)
Cord	Station number of inverter	2 byte	01-32
Command	Transmission command	2 byte	05
BCC	Block check code	2 byte	Exclusive OR of Code, Command and Data (5) Reference
CR	Control code(Carriage Return)	1 byte	CR (0x0D)

Replay frame

Frame format:

STX	Code	Data	BCC	CR
-----	------	------	-----	----

	Explanation	Data size	Value
STX	Control code(Start of Text)	1 byte	STX (0x02)
Code	Station number of inverter	2 byte	01-32
Data	Each monitor data on trip	440 byte	(Note8) reference
BCC	Block check code	2 byte	Exclusive OR of Code, Command and Data(5) Reference
CR	Control code(Carriage Return)	1 byte	CR (0x0D)

(Note8) The monitor data (trip history) on trip memorizes the last six errors with an accumulated count number (8byte).



Monitor item	Units	Magnification	Data size	Notes	
Trip factor	-	-	8byte	Cord display	Upper
Inverter status A)	-	-	8byte	04 command	
Inverter status B)	-	-	8byte	Note 7 reference	
Inverter status C)	-	-	8byte		Lower
Output frequency	Hz	x10	8byte	Tenth ASCII code	
Accumulated RUN time	hour	x1	8byte	Tenth ASCII code	
Output current	A	x10	8byte	Tenth ASCII code	
Current voltage	V	x10	8byte	Tenth ASCII code	
Accumulated RUN time	hour	x 1	8byte	Tenth ASCII code	
Power source ON time	hour	x1	8byte	Tenth ASCII code	

Chapter 4 Explanation of function

(vii) 06 command: This reads 1 set item.

Transmission frame

Frame format

STX	Code	Command	Parameter	BCC	CR
-----	------	---------	-----------	-----	----

	Explanation	Data size	Value
STX	Control code(Start of TeXt)	1 byte	STX (0x02)
Code	Station number of inverter	2 byte	01-32
Command	Transmission command	2 byte	06
Parameter	Parameter number of data	4 byte	(Note9)
BCC	Block check code	2 byte	Exclusive OR of Code, Command and Data(5) Reference
CR	Control code(Carriage Return)	1 byte	CR (0x0D)

(Note9) The range of parameter to get,

F002-, A001-, b001-, C001-, H003-, P001- (F001 uses 01 command.)

Replay frame

Frame format

On normal reply

STX	Code	ACK	Data	BCC	CR
-----	------	-----	------	-----	----

	Explanation	Data size	Value
STX	Control code(Start of TeXt)	1 byte	STX (0x02)
Code	Station number of inverter	2 byte	01-32
ACK	Control code(ACKnowledge)	1 byte	ACK (0x06)
Data	Data (tenth ASCII code)	8 byte	(Note10)
BCC	Block check code	2 byte	Exclusive OR of Code, Command and Data(5) Reference
CR	Control code(Carriage Return)	1 byte	CR (0x0D)

(Note10) when data is the selected item, this transmits and receives corresponding to station number.

The data of H003, H203 (motor capacity selection) is indicated following code data.

Code data	00	01	02	03	04	05	06	07	08	09	10
Internal, USA mode (b085 = 00, 02)	-	-	-	-	-	-	-	-	-	-	-
Code data	11	12	13	14	15	16	17	18	19	20	21
Internal, USA mode (b085 = 00, 02)	5.5kW	7.5	11	15	-	22	30	37	45	55	75

Refer to the function code list please.

On abnormal reply : (4) - (ii) Reference

(viii) 07 command: This sets 1 set item.

Transmission frame

Frame format

STX	Code	Command	Parameter	Data	BCC	CR
-----	------	---------	-----------	------	-----	----

	Explanation	Data size	Value
STX	Control code(Start of TeXt)	1 byte	STX (0x02)
Code	Station number of inverter	2 byte	01-32, FF(broadcast)
Command	Transmission command	2 byte	07
Parameter	Parameter number of data	4 byte	(Note9)
Data	Data of parameter (Tenth ASCII code)	8 byte	(Note10)
BCC	Block check code	2 byte	Exclusive OR of Code, Command and Data (5) Reference
CR	Control code(Carriage Return)	1 byte	CR (0x0D)

Reply frame

On normal reply : (4) - (i) Reference

On abnormal reply : (4) - (ii) Reference

(ix) 08 command: This returns each set value to initial value.

This works in conjunction with initial selection (b084). If b084 is 00, the trip history is cleared.

Transmission frame

Frame format

STX	Code	Command	BCC	CR
-----	------	---------	-----	----

	Explanation	Data size	Value
STX	Control code(Start of TeXt)	1 byte	STX (0x02)
Cord	Station number of inverter	2 byte	01-32, FF(broadcast)
Command	Transmission command	2 byte	08
BCC	Block check code	2 byte	Exclusive OR of Code, Command and Data (5) Reference
CR	Control code(Carriage Return)	1 byte	CR (0x0D)

Replay frame

On normal reply : (4) - (i) Reference

On abnormal reply : (4) - (ii) Reference

(x) 09 command: This checks whether it is possible to store set value to EEPROM or not.

Transmission frame

Frame format

STX	Code	Command	BCC	CR
-----	------	---------	-----	----

	Explanation	Data size	Value
STX	Control code(Start of TeXt)	1 byte	STX (0x02)
Code	Station number of inverter	2 byte	01-32
Command	Transmission command	2 byte	09
BCC	Block check code	2 byte	Exclusive OR of Code, Command and Data (5) Reference
CR	Control code(Carriage Return)	1 byte	CR (0x0D)

Transmission frame

Frame format

STX	Code	ACK	Data	BCC	CR
-----	------	-----	------	-----	----

	Explanation	Data size	Value
STX	Control code(Start of TeXt)	1 byte	STX (0x02)
Code	Station number of inverter	2 byte	01-32
ACK	Control code(ACKnowledge)	1 byte	ACK (0x06)
Data	Data	2 byte	Allowance with 01
BCC	Block check code	2 byte	Exclusive OR of Code, Command and Data (5) Reference
CR	Control code(Carriage Return)	1 byte	CR (0x0D)

On normal reply : (4) - (i) Reference

(xi) 0A command: This stores the set value to the EEPROM.

Transmission frame

Frame format

STX	Code	Command	BCC	CR
-----	------	---------	-----	----

	Explanation	Data size	Value
STX	Control code(Start of TeXt)	1 byte	STX (0x02)
Code	Station number of inverter	2 byte	01-32
Command	Transmission command	2 byte	0A
BCC	Block check code	2 byte	Exclusive OR` of Code, Command and Data (5) Reference
CR	Control code(Carriage Return)	1 byte	CR (0x0D)

Reply frame

On normal reply: (4) - (i) Reference

On abnormal reply: (4) - (ii) Reference

(xii) 0B command: This recalculates the internal motor constants.

This function is required when base frequency and parameter of H*** is changed by RS485

Transmission frame

Frame format

STX	Code	Command	BCC	CR
-----	------	---------	-----	----

	Explanation	Data size	Value
STX	Control code(Start of TeXt)	1 byte	STX (0x02)
Code	Station number of inverter	2 byte	01-32
Command	Transmission command	2 byte	0B
BCC	Block check code	2 byte	Exclusive OR of Code, Command and Data (5) Reference
CR	Control code(Carriage Return)	1 byte	CR (0x0D)

Reply frame

On normal reply : (4) - (i) Reference

On abnormal reply : (4) - (ii) Reference

(i) Affirmative reply

Reply frame

Frame format

STX	Code	ACK	BCC	CR
-----	------	-----	-----	----

	Explanation	Data size	Value
STX	Control code(Start of TeXt)	1 byte	STX (0x02)
Code	Station number of inverter	2 byte	01-32
ACK	Control code(ACKnowledge)	1 byte	ACK(0x06)
BCC	Block check code	2 byte	Exclusive OR of Code, Command and Data (5) Reference
CR	Control code(Carriage Return)	1 byte	CR (0x0D)

(ii) 01Inverter reply

Reply frame

Frame format

STX	Code	NAK	Error code	BCC	CR
-----	------	-----	------------	-----	----

	Explanation	Data size	Value
STX	Control code(Start of TeXt)	1 byte	STX (0x02)
Code	Station number of inverter	2 byte	01-32
NAK	Control code (Negative ACKnowledge)	1 byte	NAK(0x06)
Error code	Error contents of Communication	2 byte	(Note11)
BCC	Block check code	2 byte	Exclusive OR of Code, Command and Data (5) Reference
CR	Control code (Carriage Return)	1 byte	CR (0x0D)

(Note11) Error code list

Inverter doesn't reply on all code communication.

Error code	Contents
01H	Parity error
02H	Sum check error
03H	Framing error
04H	Overrun error
05H	Protocol error
06H	ASCII code error
07H	Reception buffer overrun error
08H	Reception time out error
-	-
-	-
11H	Error for abnormal command
12H	-
13H	Practice disapproval error
14H	-
15H	-
16H	Parameter abnormal error
17H	-

(5) About the calculation method of BCC (the Block Check Cord)

(Example) 5Hz is set up by using 01 commands (the setting of the frequency command). (when the code of the inverter of the object is '01')

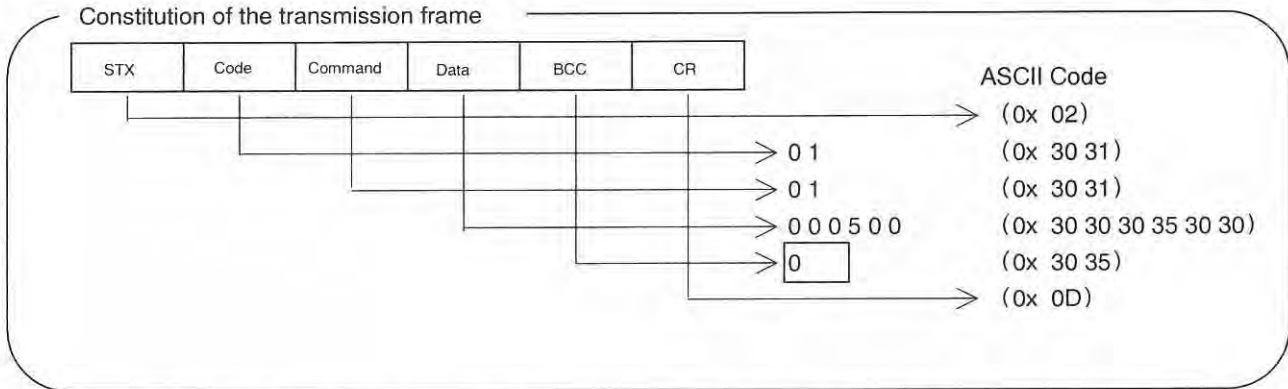

BCC is the result that transforms the Code~Data into ASCII Code and took an EXCLUSIVE OR (Xor) every 1byte. In the case of the above transmission frame, BCC calculates it as follows.

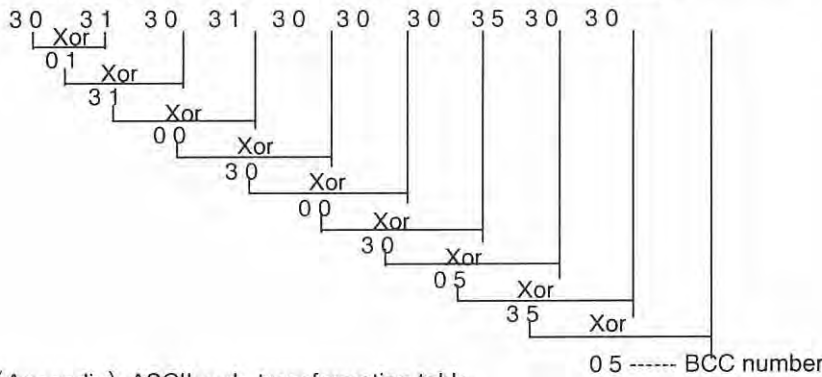

(Appendix) ASCII code transformation table

Character data	ASCII code
STX	0 2
ACK	0 6
CR	0 D
NAK	1 5
0	3 0
1	3 1
2	3 2
3	3 3
4	3 4
5	3 5
6	3 6
7	3 7

Character data	ASCII code
A	4 1
B	4 2
C	4 3
D	4 4
E	4 5
F	4 6
H	4 8
P	5 0

(6) Communication test mode

The communication test mode checks the communication line of RS485. (The communication test mode procedure)

1. Please remove the wiring of terminal unit TM2 of the control terminal unit foundation, to do the loop backcheck.
2. Please set up the following with the operator of the inverter.

Please set up C071 (Communication transmission speed selection) to 02 (Loop Back Test).

3. Shut the power supply of the inverter at first and please turn on the power supply once again.

The check is started.

4. When the check ends the display is as follows.

Normal : L - - 0

Abnormal : L - - J

5. Please push the reset button of the digital operator or copy unit. And, the setting of C071 is returned to the setting of an original request.

4.4 Protection function list

4.4.1 Protection function

Name	Description	Display of digital operator	Display of remote operator/ Copy unit [ERR1***]
Over-current protection	Motor is restricted and decelerates rapidly, excessive current is drawn through the inverter and there is a risk of damage. Current protection circuit operates and the inverter output is switched off.	At constant Speed	OC. Drive
		On deceleration speed	OC. Decel
		On acceleration speed	OC. Accel
		Other	Over. C
Overload protection (note1)	When the Inverter detects an overload in the motor, the internal electronic thermal overload operates and the inverter output is switched off.	Over. L	Over. L
Braking resistor overload Protection	When DBTR exceeds the usage ratio of the regenerative Braking resistor, the over-voltage circuit operates and the inverter output is switched off.	OL. BRD	OL. BRD
Over-voltage protection	When regenerative energy from the motor exceeds the maximum level, the over-voltage circuit operates and the inverter output is switched off.	Over. V	Over. V
EEPROM error (note2)	When EEPROM in the inverter is subject to radiated noise or unusual temperature rises, the inverter output is switched off.	EEPROM	EEPROM
Under-voltage	When the incoming voltage of inverter is low, the control circuit can't operate correctly. The under-voltage circuit operates and the inverter output is switched off.	Under. V	Under. V
CT error	When an abnormality occurs to a CT (current detector) in the inverter, the inverter output is switched off.	CT	CT
CPU error	When a mistaken action causes an error to the inbuilt CPU, the inverter output is switched off.	CPU	CPU
External trip	When a signal is given to the EXT multifunctional input terminal, the inverter output is switched off. (on external trip function select)	EXTERNAL	EXTERNAL
USP error	This is the error displayed when the inverter power is restored while still in the RUN mode. (Valid when the USP function is selected)	USP	USP
Ground fault protection	When power is turned ON, this detects ground faults between the inverter output and the motor.	GND. Flt	GND. Flt
Incoming over-voltage protection	When the incoming voltage is higher than the specification value, this detects it for 60 seconds then the over-voltage circuit operates and the inverter output is switched off.	OV. SRC	OV. SRC
Temporary power loss protection	When an instantaneous power failure occurs for more than 15ms, the inverter output is switched off. Once the instantaneous power failure wait time has elapsed and the power has not been restored it is regarded as a normal power failure. However, when the operation command is still ON with restart selection the inverter will restart. So please be careful of this.	Inst. P-F	Inst. P-F
Abnormal temperature	When main circuit temperature raises by stopping of cooling fan, the inverter output is switched off.	OH. FIN	OH. FIN
Gate Allay error	Communication error between CPU and gate allay indicate	GA	GA
Open-phase protection	When an open-phase on the input supply occurs the inverter output is switched off.	PH. Fail	PH. Fail
Overload protection2	When the Inverter detects an overload in the motor (under 0.2Hz), the inverter output is switched off.	Over.L2	Over.L2
IGBT error	When an instantaneous over-current is detected on the output the inverter output is switched off to protect the main devices.	IGBT	IGBT
Thermistor error	When the Inverter detects a high resistance on the thermistor input from the motor the inverter output is switched off.	TH	TH

Chapter 4 Explanation of function

Name	Description	Display of digital panel-digital operator	Display of remote operator/ Copy unit ERR1***
Abnormal brake	When inverter cannot detect switching of the brake(ON/FF) after releasing the brake ,and for waiting for signal condition(b124) (When the braking control selection(b120) is enable.)	E36	BRAKE
Option 1 error 0-9	These indicate the error of option 1. You can realize the details each instruction manual.	E60 - E69	OP1 0-9
Option 2 error 0-9	These indicate the error of option 2. You can realize the details by each instruction manual.	E70 - E79	OP2 0-9
During under-voltage waiting	When the incoming voltage of the inverter has dropped, the inverter output is switched off and the inverter waits.	- - - -	UV. WAIT

Note1: After a trip occurs and 10 seconds pass, restart with reset operation.

Note2: When EEPROM error E08 occurs, confirm the setting data again.

4.4.2 Trip monitor display

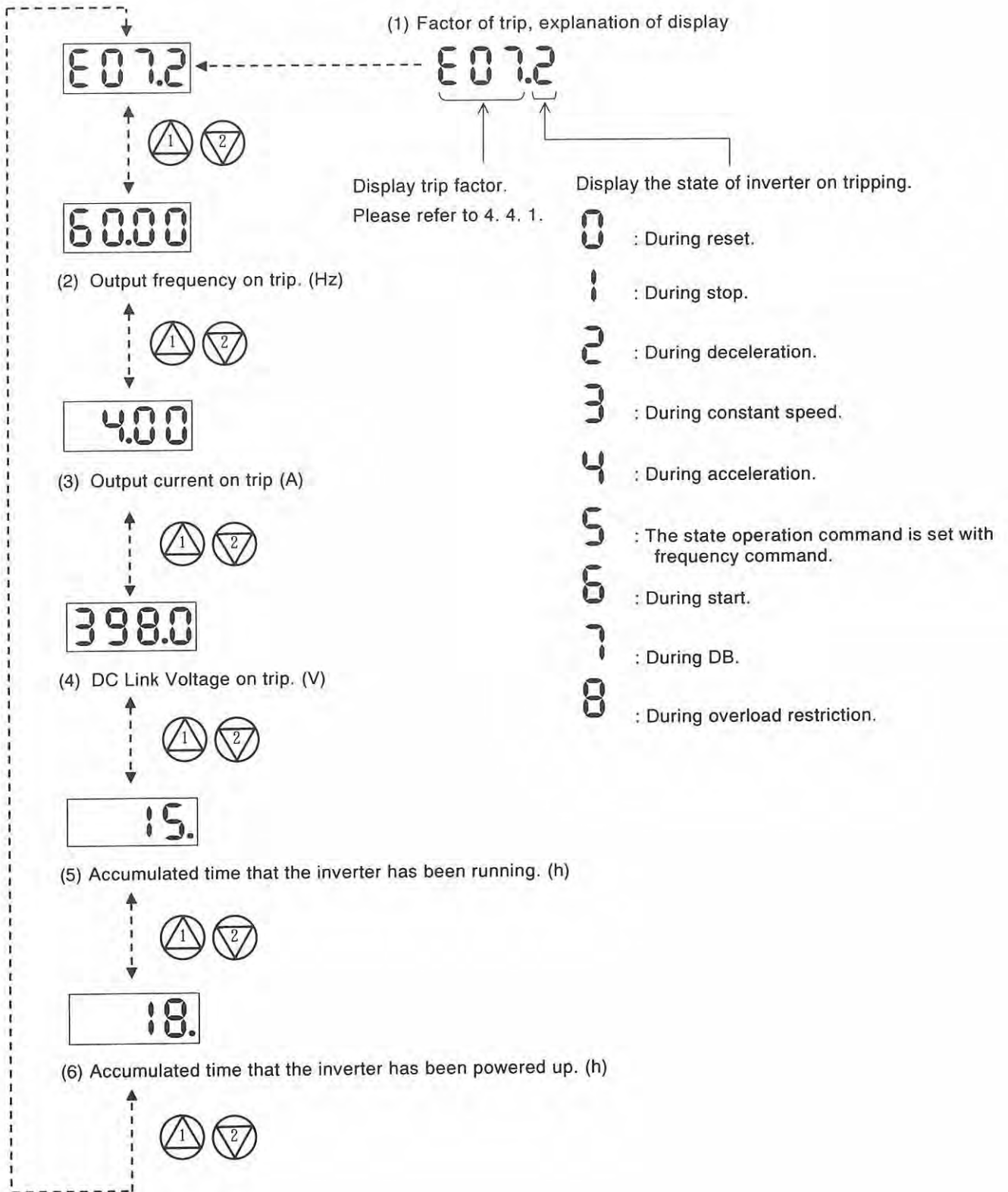

4.4.3 Warning Monitor display

Relation code
d090 : Warning Monitor

Warning messages will appear when the data set is contradicting to others.
Program lamp (PRG) turns ON during the warning (until the data is changed).

Below is the description of the warnings.

Warning	Codes	<, >	Basic code
001/201	frequency upper limiter A061/A261	>	Maximum frequency A004/A204/A304
	frequency lower limiter A062/A262	>	
	Base frequency A003/A203/A303	>	
004/204/304	Output frequency F001, Multi stage speed 0 A020/A220/A320	>	frequency upper limiter A061/A261
005/205/305	Multi stage speed 1~15 A021~A035	>	
006/206/306	frequency upper limiter A062/A262	>	frequency lower limiter A062/A262
012/212	Output frequency F001, Multi stage speed 0 A020/A220	>	
015/215	Multi stage speed 1~15 A021~A035	>	
016/216	frequency upper limiter A061/A261	<	Starting frequency b082
021/221	Output frequency F001, Multi stage speed 0 A020/A220	<	
025/225	frequency lower limiter A062/A262	<	
031/231	frequency upper limiter A061/A261	<	Jump frequency 1/2/3 +- Jump width A063+-A064 A065+-A066 A067+-A068 (note 1)
032/232	frequency lower limiter A062/A262	<	
035/235/335	Output frequency F001, Multi stage speed 0 A020/A220/A320	<	
036	Multi stage speed 1~15 A021~A035	<	Free v/f frequency 7 b112
037	Jogging frequency A038	<	
085/285/385	Output frequency F001, Multi stage speed 0 A020/A220/A320	<>	Free v/f frequency 1 b100
086	Multi stage speed 1~15 A021~A035	<>	
091/291	frequency upper limiter A061/A261	>	Free v/f frequency 2 b102
092/292	frequency lower limiter A062/A262	>	
095/295	Output frequency F001, Multi stage speed 0 A020/A220	>	Free v/f frequency 3 b104
096	Multi stage speed 1~15 A021~A035	>	
110	Free v/f frequency 1~6 b100, b102, b104, b106, b108, b110	>	Free v/f frequency 4 b106
	Free v/f frequency 2~6 b102, b104, b106, b108, b110	<	
	Free v/f frequency 1 b100	>	Free v/f frequency 5 b108
	Free v/f frequency 3~6 b104, b106, b108, b110	<	
	Free v/f frequency 1, 2 b100, b102	>	Free v/f frequency 6 b110
	Free v/f frequency 4~6 b106, b108, b110	<	
	Free v/f frequency 1~3 b100, b102, b104	>	Free electronic thermal frequency 1 b015
	Free v/f frequency 5, 6 b108~b110	<	
	Free v/f frequency 1~4 b100, b102, b104, b106	>	Free electronic thermal frequency 2 b017
	Free v/f frequency 6 b110	<	
	Free v/f frequency 1~5 b100, b102, b104, b106, b108	>	Free electronic thermal frequency 3 b019
Free electronic thermal frequency 2, 3 b017, b019	<		
120	Free electronic thermal frequency 1 b015	>	Free electronic thermal frequency 3 b019
	Free electronic thermal frequency 3 b019	<	
	Free electronic thermal frequency 1, 2 b015, b017	>	
	Free electronic thermal frequency 1, 2 b015, b017	>	

Warning is cleared when the setting fulfils the above condition.

Data will be changed automatically to the basic code.

(Note 1) The jump frequency will be automatically re-written to the lowest jump frequency (= Jump frequency – jump width)

5.1 Precautions for Maintenance/Inspection

5.1.1 Daily inspection

Every day before operation check the following;

- [1] Does the motor operate according to the settings?
- [2] Is there any trouble with the surroundings of the installation?
- [3] Is there any trouble with the cooling or ventilation system?
- [4] Is there any abnormal vibration or sound?
- [5] Are there any signs of over-current or discoloration?
- [6] Is there any unusual odour present?

Check the input voltage to the inverter by using a meter during running

- [1] Is the supply voltage constant?
- [2] Are all the phases of the supply balanced?

5.1.2 Cleaning

Make sure that the inverter is not dirty when operating.

Wipe clean with a soft cloth and synthetic detergent or ethanol.

(Notes) Don't use solvents containing any of the following, acetone, benzene, toluene, alcohol etc. as they can cause melting of the inverter surface, peeling of paint.
Never clean the display part of the digital operator with detergent or alcohol.

5.1.3 Regular inspection

Inspections should be regularly carried out on the parts that can't be inspected while the inverter is running.

- [1] Is there any trouble with the cooling system? - - - Cleaning of air filter etc.
- [2] Check that all screw terminals and fixings are tight as they may loosen due to vibration or temperature change etc.
- [3] Is there any corrosion, damage to insulators?
- [4] Measurement of insulation resistance.
- [5] Check of cooling fan, smoothing capacitor, relay and exchange if necessary.

5.2 Daily inspection and regular inspection

Inspection Parts	Inspection item	Inspection item	Inspection cycle			Inspection methods	Decision standard	Meter
			Daily	Regular				
				1	2			
Whole	Surroundings	Check temperature of surrounding, humidity, dust.	<input type="radio"/>			Refer to 2.1 Installing.	Temperature range is between -10 and 40 degrees. No dew present and humidity is below 90%.	Thermometer, hygrometer, recorder
	Whole equipment	Is there abnormal vibration, abnormal sound?	<input type="radio"/>			By watching, hearing.	No trouble.	
	Power voltage	Is main circuit voltage normal?	<input type="radio"/>			Measurement of inverter terminal R, S, T phase voltage	Within alternating voltage allowable change.	Tester, digital multi-meter
Main circuit	Whole	(1)Megger check Between circuit terminal and earth terminal (2)Are all screws terminals tight? (3)Is there any sign of over-voltage? (4)cleaning		<input type="radio"/>	<input type="radio"/>	(1)After you remove connector J61 from inside the inverter Take out the wiring of input/output of inverter main circuit terminal and control terminal, measure between parts shortened terminal R,S,T,U, V,W,P,P1,N,PR and earth terminal with megger. (2)Incremental clamping. (3)Watch.	(1)To be over 5M ohm. (2)(3) No abnormality	DC500V class megger
	Connection conductor/ electric line	(1)Is there warp in conductor? (2)Is there any damage of coating of wires?		<input type="radio"/>	<input type="radio"/>	(1)(2) By watching	(1)(2) No abnormality	
	Terminals	Is there any damage?		<input type="radio"/>		By watching.	No abnormality.	
	Inverter parts Converter parts	Resistance check Between each Terminal.			<input type="radio"/>	Take out connect of inverter, measure terminal between R,S,T and P,N, between U,V,W and P,N with tester x 1 ohm range.	Refer to check method of 5.5 inverter, converter parts.	Analog form tester
	Smoothing capacitor	(1)Is there any liquid? (2)Does relief valve come out? Is there any swell? (3)Measure of allow-able static-electricity.	<input type="radio"/>	<input type="radio"/>	<input type="radio"/>	(1),(2) By watching. (3)Measure with capacity measure.	(1),(2) No abnormality (3) Over 80% of rated capacity.	Capacity meter
	Relay	(1)Is there abnormal sound in operation? (2)Is there damage to the contacts?		<input type="radio"/>	<input type="radio"/>	(1)By hearing (2)By watching	(1) No abnormality (2) No abnormality	
	Resistor	(1)Is there any crack, discoloration of resistance insulator. (2)Confirm existance of breaking of wire.		<input type="radio"/>		(1)By watching, cementing resistance. Curl type resistance. Take out connection to other side, measure it with tester.	(1)No abnormality Error to be within 10% of Display resistance.	Tester Digital multi-meter
	Control circuit Protection circuit	Operation check (1)Confirm balance of each output phase voltage with inverter single operation. (2)Operate sequence protection moving test. And no abnormality.		<input type="radio"/>	<input type="radio"/>	(1)Measure inverter output terminal U,V,W phase voltage. (2)Short or open protection circuit output of inverter.	(1)Phase voltage balance 200v/400v class is within 4V/8V. (2)On sequence, to operate abnormality.	Digital multi-meter, rectification type voltmeter
Cooling system	Cooling fan (1)Is there abnormal vibration, abnormal sound? (2)Is there loosening of connecting parts?	<input type="radio"/>		<input type="radio"/>	(1)Revolve by hands in the state of tone-on idle. (2) By watching.	(1)Revolving smooth. (2)No abnormality.		
Display	Display	(1)Is the LED lamp illuminated? (2) Cleaning.	<input type="radio"/>	<input type="radio"/>		(1)Lamp indicates lamp on operator. (2) Cleaning with cloth.	(1)Confirm light.	
	Meter	Is direction value Normal?	<input type="radio"/>	<input type="radio"/>		Confirm indication value of board meter.	Satisfy normal value, control value.	Voltage meter, current meter
Motor	Whole	(1)Is there abnormal signal, abnormal sound? (2)Is there any abnormal odour?	<input type="radio"/>	<input type="radio"/>		(1)By hearing, feeling, watching. (2)Abnormal odour from overheat, damage etc. Confirmation.	(1)(2) No abnormality.	
	Insulated resistance	(1)Megger check (terminal collection - earth terminal)			<input type="radio"/>	Remove connection to U,V and W and disconnect motor wiring.	(1) To be over 5M ohm	DC 500V Megger

(Notes) Life time of the capacitors depends on the ambient temperature.

5.3 Megger test

When executing a Megger test on the inverter remove all wires to R, S, T, P1, P, N, PR, U, V and W.

Do not use a megger or buzzer on the control circuit only use a digital multi-meter.

(Megger Voltage 500V DC)

Execute megger test of main circuit after the J61 connector has been removed. Short terminals of R, S, T, P1, P, N, PR, U, V and W.

After the Megger test is complete, reconnect the J61 connector as before.

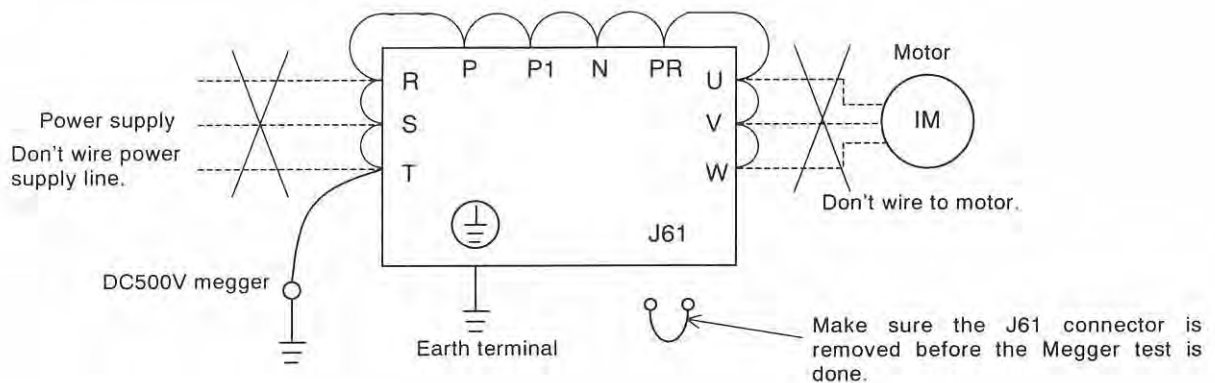

5.4 Withstand Voltage test

Never perform a withstand voltage test on the inverter.

The inverter main circuit uses semiconductors. Semiconductors can deteriorate when a withstand voltage test is performed.

5.5 The method to check Inverter, converter part

A test is possible to check quality.

(Preparation)

- [1] Take out the power lines (R, S and T) connected to the inverter, the motor connection lines (U, V and W) and the regenerative control resistance (P and PR).
- [2] Prepare tester. (Using range of 1 ohm resistance measure range.)

(How to check)

It is possible to check the quality of the charging state of the terminals R, S, T, U, V, W, PR, P and N of the inverter and the pole of the tester by measuring the charging state.

(Note1) Before you measure the voltage between P and N with DC current range, confirm that the smoothing capacitor is discharged fully, execute checks.

(Note2) Almost infinite value is indicated on no conducting.

With the effect of the smoothing capacitor, the inverter conducts instantly and an infinite value isn't indicated. Ohm-number 10 ohms is indicated on conducting.

The values indicated will not be exactly the same for each terminal, however they will be very close together. If there is a significant difference a problem may exist.

		Pole of tester		Measure value
		⊕ (Red)	⊖ (Black)	
Converter	D1	R	P1	No-conduct
		P1	R	Conduct
	D2	S	P1	No-conduct
		P1	S	Conduct
	D3	T	P1	No-conduct
		P1	T	Conduct
D4	R	N	Conduct	
	N	R	No-conduct	
D5	S	N	Conduct	
	N	S	No-conduct	
D6	T	N	Conduct	
	N	T	No-conduct	
Inverter	TR1	U	P	No-conduct
		P	U	Conduct
	TR2	V	P	No-conduct
		P	V	Conduct
	TR3	W	P	No-conduct
		P	W	Conduct
TR4	U	N	Conduct	
	N	U	No-conduct	
TR5	V	N	Conduct	
	N	V	No-conduct	
TR6	W	N	Conduct	
	N	W	No-conduct	
BR part	TR7	PR	P	No-conduct
		P	PR	Conduct
		PR	N	No-conduct
		N	PR	No-conduct

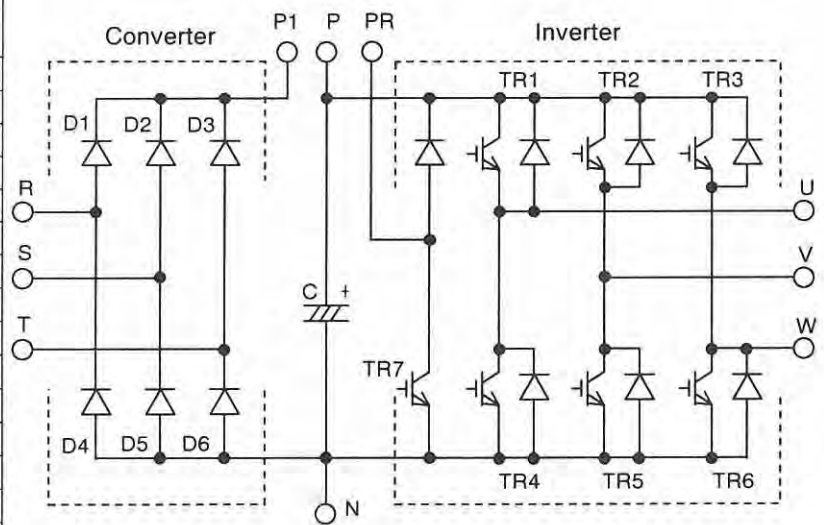

5.6 Capacitor Life Curve

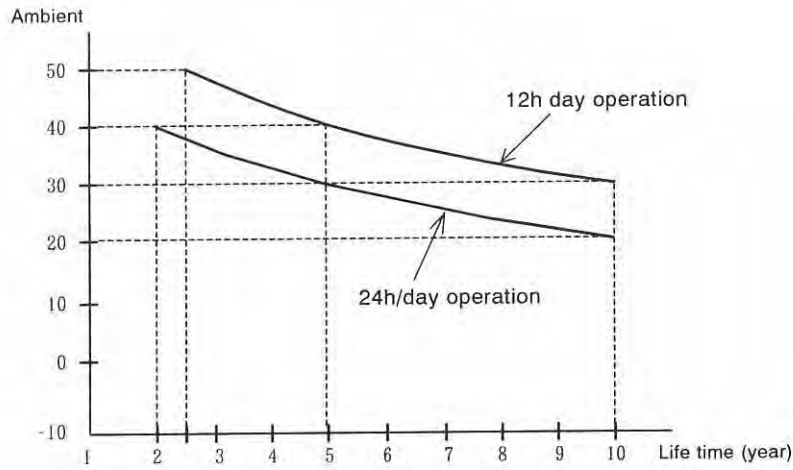

(Note1)

Ambient temperature means the surrounding temperature of the inverter. In case the inverter is installed in a cabinet, ambient temperature is the temperature of the internal air of the cabinet.

(Note2)

DC bus capacitors are recommended to be replaced every 5 years. And if the inverter is used in a worse condition, this recommended replacing period is reduced.

6.1 Standard specification list

(1) 200V class

Inverter Model		HF4302-5A5	HF4302-7A5	HF4302-011	HF4302-015	HF4302-022	HF4302-030	HF4302-037	HF4302-045	HF4302-055
Max. Applicable Motor 4P (kW)		5.5	7.5	11	15	22	30	37	45	55
Rated input Alternating (kVA)	200V	8.3	11.0	15.9	22.1	32.9	41.9	50.2	63.0	76.2
	240V	9.9	13.3	19.1	26.6	39.4	50.2	60.2	75.6	91.4
Rated input alternating voltage		Three-phase 200-240V(+10%)50Hz/60Hz								
Rated output voltage		Three-phase 200-240V (This corresponds to receiving voltage.)								
Rated output current (A)		24	32	46	64	95	121	145	182	220
Start- ing	Regenerative Control	DBTR circuit built-in			Regenerative unit is required					
	Minimum Resistance To be connected (OHM)	17	17	17	—	—	—	—	—	—

(2) 400V class

Inverter Model		HF4304-5A5	HF4304-7A5	HF4304-011	HF4304-015	HF4304-022	HF4304-030	HF4304-037	HF4304-045	HF4304-055
Max. Applicable Motor 4P (kW)		5.5	7.5	11	15	22	30	37	45	55
Rated input Alternating (kVA)	400V	8.3	11.0	15.9	22.1	33.2	40.1	51.9	62.3	76.2
	480V	9.9	13.3	19.1	26.6	39.9	48.2	62.3	74.8	91.4
Rated input alternating voltage		Three-phase 380-480V (+10%) 50Hz/60Hz								
Rated output voltage		Three-phase 380-480V (This corresponds to receiving voltage.)								
Rated output current (A)		12	16	23	32	48	58	75	90	110
Start- ing	Regenerative Control	DBTR circuit built-in			Regenerative unit is required					
	Minimum Resistance To be connected (OHM)	70	50	50	—	—	—	—	—	—

(3) Common specification for 200V/400V class

Inverter Model		HF430*-5A5	HF430*-7A5	HF430*-011	HF430*-015	HF430*-022	HF430*-030	HF430*-037	HF430*-045	HF430*-055	
Control system		Sine-wave modulation PWM system									
Output frequency range		0.1-400Hz									
Frequency accuracy		Digital command +/-0.01% for Max. frequency, analog frequency +/-0.2%(25+10C)									
Frequency resolving power		Digital setting : 0.01Hz, Analog setting : Max. frequency/4000									
Voltage/frequency characteristic		V/f option variable, V/f control, (constant torque, reduced torque), sensor-less vector control (base frequency 30-400Hz)									
Speed fluctuation		+0.5% (sensor-less vector control)									
Overload current rate		150% for 60 seconds, 200% for 0.5 second									
Acceleration/deceleration time		0.01-3600.0 seconds (straight or S-Curve on acceleration, deceleration is optional setting individually),									
Stating torque		200%/0.5Hz (sensor-less vector control) 150%/0Hz area torque (0Hz sensor-less vector control. At the time of 1 frame under motor connection)									
DC Braking		On starting and decelerating by stop command, inverter operates under operation setting frequency. Or inverter operates with external input (Braking power, time, frequency can be set.)									
input	Frequ- ency	Operator	Setting by key.								
		Volume	DC 0 to 5V, -5 to +5V, 0 to 10V, -10 to +10V (input impedance 10k ohm), 4-20mA (input impedance 100 ohm)								
		Extend Signal	Setting with RS485 communication								
	Run/ Stop	Operator	Run/Stop								
		Volume	Forward Run/Stop (1a connect), reverse command is impossible on assigning of terminal (selection of 1a, 1b is possible), input of 3 wires is possible.								
		Extend Signal	Setting with RS485 communication								
Multifunctional input terminal	Use by selecting terminals from; Reverse command (RH), multi-speed1-4 (DFL-DFHH), jogging (JOG), external dc braking (DB), B-mode control (BMD), acceleration2 (AD2), free-run stop (MBS), external trip (EXT), USP function (USP), commercial change (CS), software lock (SFT), analog input voltage / current / select (AUT), C-mode control (CMD), reset inverter (RST), 3 wire run (STA), 3 wire keep (STP), 3 wire direction selection (F/R), PID selection valid/invalid (PID), PID integrating reset (PIDC), control gain change (CAS), remote control up function (UP), remote control down function (DWN), remote control data clear (UDC), Compulsion operation (OPE) multi-speed bit 1-7(SF1-SF7), overload restriction change (OLR), torque limit exist or no (TL), Torque limit change 1 (TRQ1), Torque limit change 2 (TRQ2), P/PI change (P/PI), Brake confirmation (BOK) orientation (ORT), LAD cancel (LAC), Position deviation clear (PCLR), 90 degrees the phase difference permission (STAT), permissive input signal for FW/RV (ROK), no assign (NO)										
Thermistor input terminal	1 terminal										
Output	Multifunctional output terminal	Signal during run (DRV), Frequency arrival type 1 signal (UPF1), Frequency arrival type 2 signal (UPF2), Overload advance notice signal (OL), Output deviation for PID control (OD), Alarm signal (AL), Arrival signal for only setting frequency (UPF3), Over torque (OTO), Instantaneous stop signal (IP), Under voltage signal (UV), Torque limit (TRQ), RUN time over (RNT), ON time over (ONT), Thermal caution (THM), Brake opening (BRK), Brake error (BER), Zero speed detect signal (ZS), Speed deviation excessive (DSE), Positioning completion (POK), Arrival signal for over setting frequency 2 (UPF4), Arrival signal for only setting frequency 2 (UPF5), Overload advance notice signal 2 (OL2), Alarm cord 0-3 (AC0-AC3)									
	Multifunctional monitor output terminal	Analog voltage output, analog current output, pulse line output									
Display monitor		Output frequency, output current, frequency conversion value, trip history, input output terminal state, input electric power, output voltage, motor torque									
Other function		V/f free setting (7points), Upper / lower frequency limiter, Frequency jump, Curve adjustable speed, Manual torque boost level / Braking point, Analog meter adjustment, Starting frequency, Camer frequency adjustment, Electronic thermal free setting, External start/end (frequency/rate), Analog input selection, Trip rely, Reduced voltage start, Overload restriction, energy-saving operation, Restarting after an instantaneous power failure, Various kinds signal output, Initialization value setting, Automatic deceleration at the time of the power supply block, AVR function, Autotuning (Online/Offline)									
Camer frequency range		0.5 - 15kHz									
Protection function		Over-current, over-voltage, under-voltage, electronic thermal level, abnormal trouble, ground fault current on starting, instantaneous stop, USP error, open-phase error, control resistor overload, CT error, external trip, communication error									
Usage surround- ing	Frequency temperature/Preservation temperature/humidity	-10 to 50 degrees / -20 to 65 degrees / 20 to 90 % RH (installed with no dew condensation)									
	Vibration	5.9 m/s ² (0.6G), 10-55Hz					2.94 m/s ² (0.3G), 10-55Hz				
	Using place	Under 1,000m above sea level, indoors. (installed away from corrosive gasses dust)									
Option	Options	Vector control with sensor									
	Digital input option	4 column BCD, 16bit binary									
Other options		Remote operator, copy unit, cable for each operator, braking resistor, regenerative control unit, alternating reactor, D.C. reactor, EMC Mains filter, higher harmonic control unit, LC filter, applied control installation									
Schematic mass (kg)		3.5	5	5	12	12	20	30	30	50	

6.2 Dimension

HF4302-5A5、HF4304-5A5

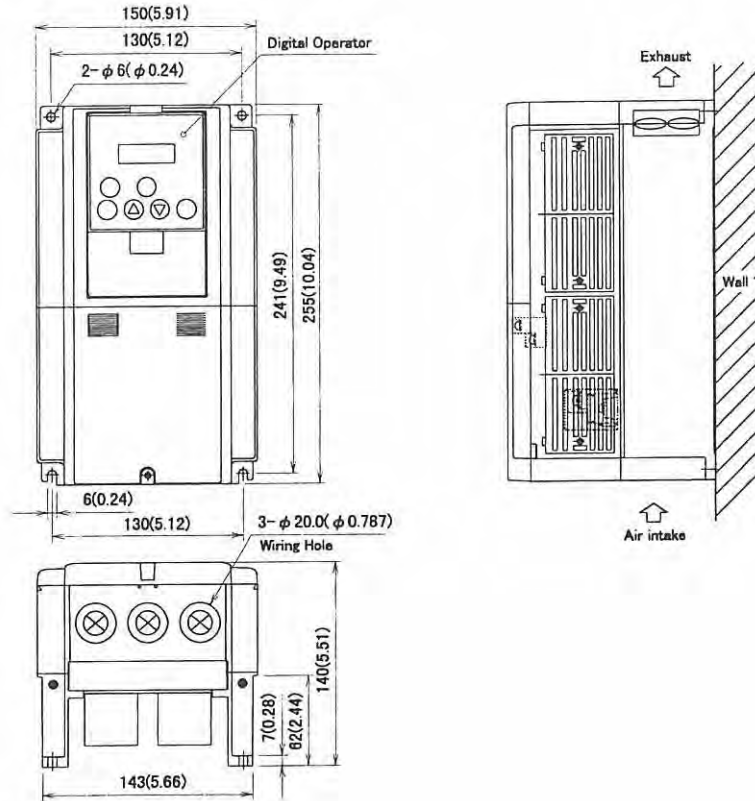

HF4302-7A5,011、HF4304-7A5,011

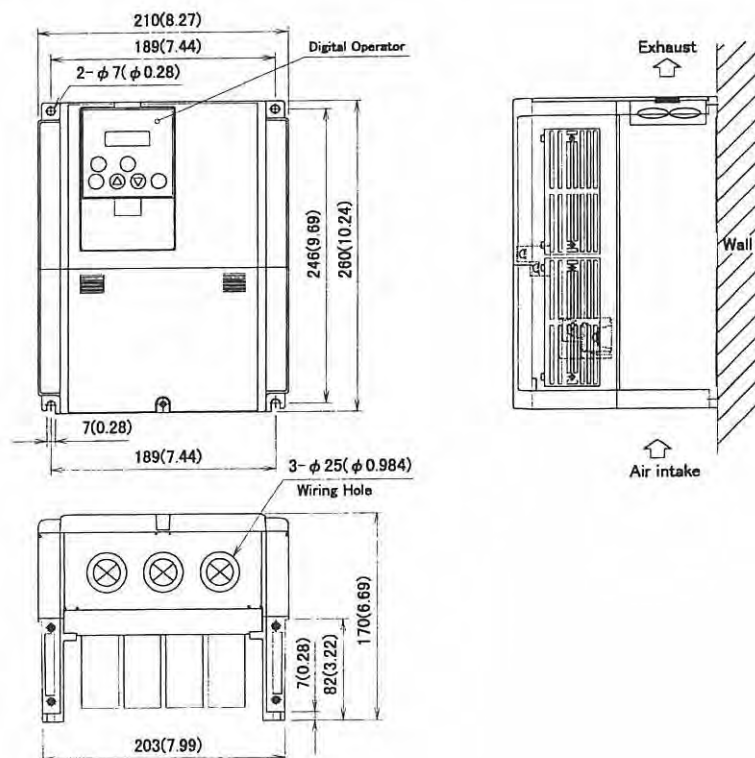

HF4302-015,022、HF4304-015,022

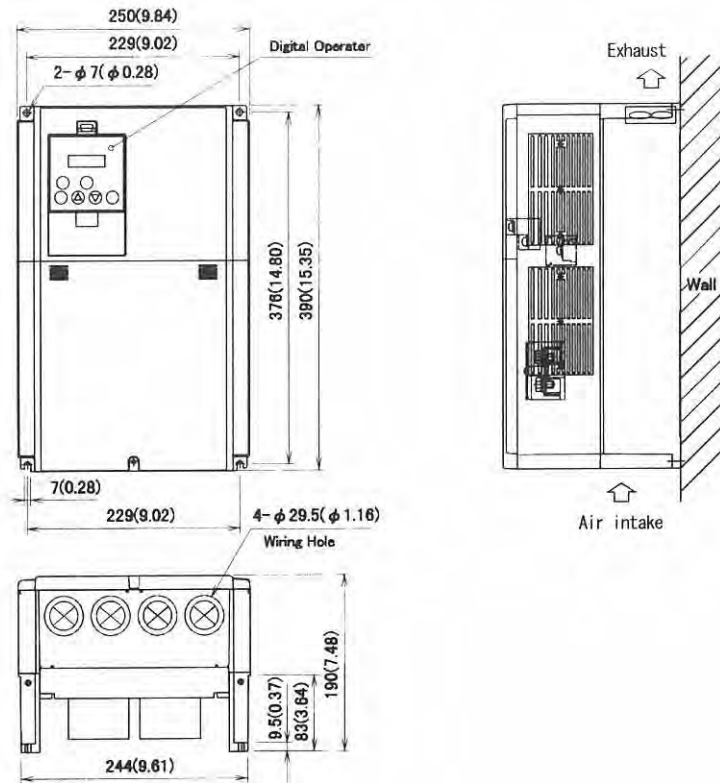

HF4302-030、HF4304-030

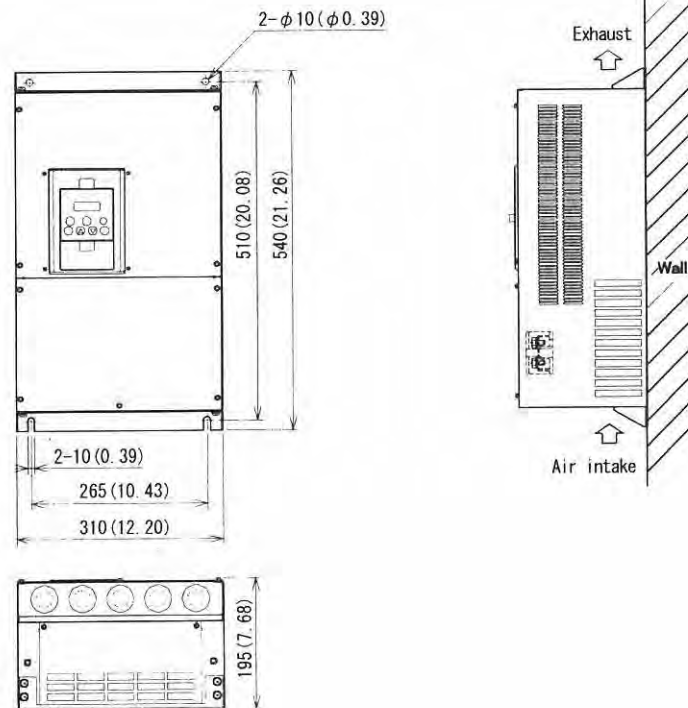

HF4302-037,045、HF4304-037,045,055

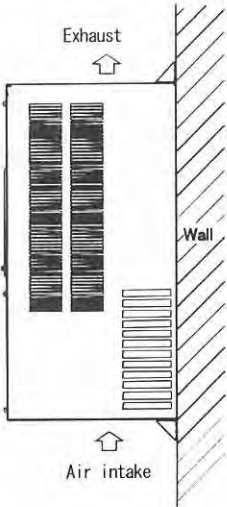
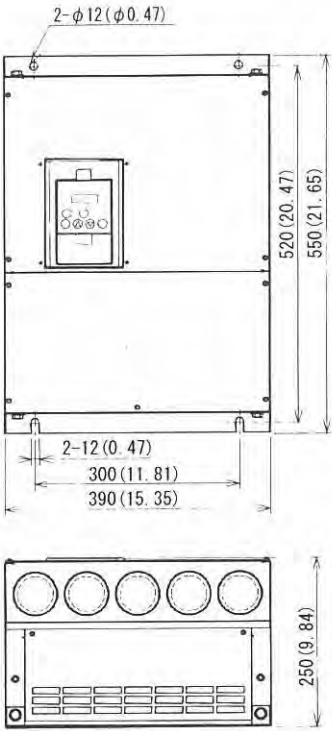

- Index -

A(a)

- a/b.....4-44, 4-53
- Acceleration pattern.....4-34
- Accumulated Run time.....4-56
- AD2.....4-33
- Adjustable time.....4-19
- AL.....4-53
- Alarm code output.....4-57
- AMI.....4-58
- AMV.....4-58
- Analogue input.....4-22
- Analogue input filter.....4-24
- AUT.....4-22
- Auto matic torque boost.....4-26
- AVR.....4-20

B(b)

- Base frequency.....4-20
- Base motor voltage.....4-20
- B-mode.....4-47
- BER.....4-53,62
- BOK.....4-53,62
- Braking control function.....4-62
- BRK.....4-53,62

C(c)

- C-mode.....4-47
- Carrier frequency.....4-21
- CAS.....4-43
- Check inverter.....5-4
- Code list.....4-5
- Communication function.....4-74
- Communication protocol.....4-76
- Control system.....4-25
- CS.....4-43
- Current detection.....4-39

D(d)

- DB.....4-27, 4-39
- DBTR.....4-42
- Deceleration pattern.....4-34
- DFL-DFHH.....4-44
- Dimension.....6-2
- Display selection.....4-60
- DRV.....4-7
- DSE.....4-53
- DWN.....4-51

E(e)

- Electronic thermal.....4-37
- Energy saving.....4-32
- Error history.....4-16
- ES.....4-43, 4-52
- Expranation of function.....4-13
- External thermistor.....4-59
- External trip.....4-52

F(f)

- F/R.....4-43, 4-52
- F-matching start.....4-35
- Fan setting.....4-42
- Force operation ope.....4-48
- Free run stop.....4-49
- FRQ.....4-57
- FRQ terminal.....4-57
- Frequency arrival signal.....4-54
- Frequency command selection.....4-17
- Frequency conversion monitor.....4-15
- Frequency jump.....4-30
- Frequency limiter.....4-29
- Frequency setting.....4-17
- Frequency start/end.....4-23
- Function mode.....4-6,4-17

I(l)

- Initialization setting.....4-59
- Input electric power monitor.....4-15
- Inspection.....5-2
- Instantaneous power failuer.....4-35
- Installation.....2-1
- IP.....4-35, 4-53
- IRF.....4-22

J(j)

- JOG.....4-43, 4-46

L(l)

- LAC.....4-19, 4-34, 4-43

M(m)

- Maintenance.....5-1
- Maximum frequency.....4-21
- MBS.....4-43,4-49
- Megger test.....5-3
- Monitor mode.....4-5,4-13
- Motor constant.....4-61
- Motor constant selection.....4-66
- Multifunctional input monitor.....4-14
- Multifunctional input terminal setting.....4-43
- Multifunctional output terminal setting.....4-53
- Multifunctional output monitor.....4-14
- Multi-speed.....4-44

N(n)

- no.....4-43
- NO/NC.....4-44, 4-53

O(o)

- OD.....4-53
- Offline autotuning function.....4-64
- OL,OL2.....4-39,4-40 4-53
- OLR.....4-39, 4-43
- Online autotuning function.....4-67
- ONT.....4-53, 4-56
- OPE.....4-43, 4-48
- Open phase protection.....4-37

- Operation command selection.....4-18
- Operation direction.....4-17
- Operation direction monitor.....4-13
- Operation selection on option error.....4-61
- ORT.....4-43
- OTQ.....4-53
- Output current monitor.....4-13
- Output frequency monitor.....4-13
- Output torque monitor.....4-15
- Output voltage monitor.....4-15
- Over torque.....4-56

P(p)

- PCLR.....4-43
- PID.....4-13,4-31
- PID feedback monitor.....4-13
- POK.....4-53
- Power on time.....4-56
- Power on time monitor.....4-16
- PPI.....4-43
- Protection function.....4-87

R(r)

- Reduced voltage start.....4-41
- Reset.....4-50
- RNT.....4-53, 4-56
- Run time monitor.....4-16
- RP.....4-74
- RS485.....4-74
- RST.....4-43, 4-50
- RR.....4-43

S(s)

- Sensorless vector control.....4-68
- Selection of STOP key.....4-18
- Selection on stop.....4-18
- SFT.....4-43, 4-48
- SF1-SF7.....4-43, 4-45
- Signal during run.....4-54
- SN.....4-74
- Software lock.....4-48
- SP.....4-74
- STA.....4-43, 4-52
- Stabilized factor.....4-61
- Stall prevention.....4-39
- Standard specification.....6-1
- STAT.....4-43
- STOP/RESET.....4-18
- STP.....4-43, 4-52
- Start frequency.....4-41

T(t)

- Terminal connection diagram.....2-6
- THM.....4-37, 4-53
- TL.....4-43
- Torque boost.....4-26
- Torque LADSTOP function.....4-73

Torque limit function	4-71	Zero speed signal	4-56
Torque monitor	4-15	ZS	4-53, 4-56
Torque monitor function	4-70		
Trip monitor display	4-89		
Trip time monitor	4-16		
TRQ	4-53		
TRQ1,TRQ2	4-43,4-72		
U(u)			
UDC	4-43, 4-51		
Unattended start protection	4-51		
UP	4-43,4-51		
UP/DOWN selection	4-51		
UPF1-UPF5	4-53, 4-54		
USP	4-43, 4-51		
UV	4-35, 4-53		
V(v)			
V/F	4-25		
VC	4-25		
VP	4-25		
VRF	4-22		
VRF2	4-22		
W(w)			
Warning monitor display	4-90		
Withstand voltage test	5-3		
Z(z)			
Zero Hz domain sensorless vector control	4-69		