



www.saftronics.com

GP10

**General Purpose
Open Loop
Vector AC Drive**



INSTRUCTION MANUAL

These instructions do not purport to cover all details or variations in equipment, nor to provide every possible contingency to be met during installation, operation, and maintenance. If further information is desired, or if particular problems arise that are not covered sufficiently for the purchaser's purpose, the matter should be referred to Safronics, Inc., Ft. Myers, FL

This document contains proprietary information of Safronics and is furnished to its customer solely to assist that customer in the installation, testing, operation, and/or maintenance of the equipment described. This document shall not be reproduced in whole or in part, nor shall its contents be disclosed to any third party without the written approval of Safronics.

WARNING:

This equipment contains a potential hazard of electric shock or burn. Only personnel who are adequately trained and thoroughly familiar with the equipment and the instructions should install, operate, or maintain this equipment.

Isolation of test equipment from the equipment under test presents potential electrical hazards. If the test equipment cannot be grounded to the equipment under test, the test equipment's case must be shielded to prevent contact by personnel.

To minimize hazard of electrical shock or burn, approved grounding practices and procedures must be strictly followed.

WARNING:

To prevent personal injury or equipment damage caused by equipment malfunction, only adequately trained personnel should modify any programmable machine.

Table of Contents

i. Preface	i		
Safety Instructions	iii	Setting Function Data	4-5
Model Numbering System Diagram	vii	Checking Function Data	4-7
Dimensions & Weights	viii	Monitoring Operating Status	4-7
		I/O Check	4-8
1. Before Using This Product	1-1	Maintenance Information	4-9
Receiving Instructions	1-1	Load Rate Measurement	4-10
Appearance	1-1	Alarm Information	4-11
Handling the Product	1-2	Alarm History and Factors	4-12
Carrying	1-3	Data Copy	4-13
Storage	1-3	Alarm Mode	4-15
Ratings Efficiency and Watts Loss	1-4		
		5. Function Selection	5-1
2. Installation Environment and Connection	2-1	Function Selection List	5-1
Operating Environment	2-1	Alphabetical Function List	5-5
Installation Method	2-1	Function Explanation	5-7
Connection	2-3	F: Fundamental Functions	5-7
Basic Connection Diagrams	2-4	E: Extensions Terminal Functions	5-18
Connecting the Main Circuit and Ground Terminals	2-8	C: Control Functions of Frequency	5-28
Connecting the Control Terminals	2-11		
Terminal Configuration	2-15	6. Protective Operations	6-1
Cable Size, Tightening Torque & Circuit Protection Rating	2-16	List of Protective Functions	6-1
DC Link Reactor	2-17	Alarm Reset	6-2
3. Operation	3-1	7. Troubleshooting	7-1
Inspection and Preparation Before Operation	3-1	Activation of Protective Function	7-1
Operation Method	3-1	Abnormal Motor Rotation	7-5
Trial Run	3-1		
		8. Maintenance and Inspection	8-1
4. Keypad Panel	4-1	Daily Inspections	8-1
Appearance of Keypad Panel	4-1	Periodic Inspections	8-1
Operation From the Keypad Panel	4-2	Main Circuit Measurements	8-4
Normal Operation	4-2	Insulation Test	8-5
Alarm Modes	4-2	Replacement Parts	8-5
Entering Data on the Keypad Panel	4-4		
Operation Mode	4-4	9. Warranty Parts and Service	9-1
Setting Digital Frequency	4-4	In-Warranty Failure Checklist	9-2
Switching to LED Digital Monitor	4-5		
Program Menu Screen	4-5		

10. Replacement Parts	10-1
<hr/>	
11. Specifications	11-1
<hr/>	
Standard Specifications	11-1
Common Specifications	11-5
Outline Dimensions	11-7
Keypad Mounting Hole.....	11-14
12. RS485 Modbus RTU Serial Communications	12-1
<hr/>	
Transmission Specification	12-1
Connection	12-1
Serial Interface Configuration.....	12-1
Modbus RTU Functions.....	12-1
Drive Function Code Access	12-2
Command and Monitor Data Registers	12-2
Data Format Specification	12-4
Communication Errors	12-8
13. Options	13-1
<hr/>	
Built-in Options	13-1
14. Electromagnetic Compatibility (EMC)	14-1
<hr/>	
General	14-1
Recommended Installation Instructions	14-1

Safety Instructions

Read this manual carefully before installing, connecting (wiring), operating, servicing, or inspecting the drive.

Familiarize yourself with all safety features before using the drive.

In this manual, safety messages are classified as follows:

WARNING	Improper operation may result in serious personal injury or death.
CAUTION	Improper operation may result in slight to medium personal injury or property damage.

Situations more serious than those covered by CAUTION will depend on prevailing circumstances.

Always follow instructions.

Instructions on Use

WARNING

- This drive is designed to drive a 3-phase induction motor and is not suitable for a single-phase or other types of motors.
- This drive may not be used as a component of a life-support system or other medical device directly affecting the personal welfare of the user.
- This drive is manufactured under strict quality control standards. However, safety equipment must be installed or the failure of this device may result in personal injury, property damage, or risk an accident.

Instructions on Installation

WARNING

- Mount this drive on an incombustible material such as metal, otherwise a risk of fire may result.
- Do not place combustible or flammable material near this drive, as fire may result.

CAUTION

- Do not hold or carry this drive by its cover. Do not drop the converter, as injury may result.
- Ensure that the drive and heat sink surfaces are kept free of foreign matter (lint, paper dust, small chips of wood or metal, and dust), as fire or accident may result.
- Do not install or operate a damaged drive or a drive with missing parts, as electric shock or injury may occur.

Instructions on Wiring

WARNING

- Connect the drive to power via a line-protection molded-case circuit breaker or fuse, as fire may result. Always connect a ground wire, as electric shock or fire may result.
- A licensed specialist must perform all wiring work, as electric shock may result.
- Turn off the power before wiring, as electric shock may result.
- Wire the drive after mechanical installation is complete, as electric shock or injury may occur.

CAUTION

- Confirm that the number of phases and rated voltage of this product match those of the AC power supply, otherwise injury may result.
- Do not connect the AC power supply to the output terminals (U, V, and W), as injury may result.
- Do not directly connect a braking resistor to the DC terminals (P(+) and N(-)), as fire may result.
- Ensure that the noise generated by the drive, motor, or wiring does not adversely affect peripheral sensors and equipment, as an accident may result.

Instructions on Operation

WARNING

- Be sure to install the cover before turning on the power. Do not remove the cover while power to the drive is turned on. Electric shock may occur.
- Do not operate switches with wet hands, as electric shock may result. When the retry function is selected, the drive may restart automatically after tripping. Design the machine to ensure personal safety in the event of restart. Accident may result.
- When the torque limiting function is selected, operating conditions may differ from preset parameters (acceleration/deceleration time or speed). In this case, personal safety must be assured. An accident may result.
- The STOP key is only effective when a function setting has been established. Install an independent emergency switch to disable the STOP key on the keypad panel when an operation is selected via the external signal terminal, otherwise an accident may result.
- Operations can start up suddenly, after an alarm is reset, if there is a run signal present. Confirm that the run signal input is not present before resetting the alarm. Accident may result.
- Do not touch drive terminals when energized, even if the drive has stopped. Electric shock may result.

CAUTION

- Do not start or stop the drive using the main circuit power. Failure may result.
- Do not touch the heat sink or braking resistor because they become very hot. Burns may result.
- Since the drive can reach high speed operation easily, carefully check the performance of motor or machine before changing any speed settings. Injury may result.
- Do not use the drive braking function for mechanical holding. Injury may result.

Instructions on Maintenance, Inspection, and Replacement

WARNING

- Wait a minimum of five minutes (30HP or less) or ten minutes (40HP or more) after power has been turned off (open) before starting inspection. Also confirm that the charge lamp is off and that DC voltage between terminals P(+) and N(-) does not exceed 25V. Electrical shock may result.
- Only authorized personnel should perform maintenance, inspection, and replacement operations. Remove all metal jewelry such as watches and rings. Use insulated tools only. Electric shock or injury may result.

Instructions on Disposal

CAUTION

- Treat as industrial waste when disposing of drive. Injury may result.

Instructions for UL/cUL Requirements

CAUTION

- Hazard of electrical shock. Disconnect incoming power before working on this control.
- Dangerous voltage exist until charge light is off.
- Type1 - indoor use only.
- Tightening torque and wire size for field wiring terminal are marked adjacent to the terminal or on the wiring diagram.
- The drive shall be connected with Listed Class J Fuse or Circuit Breaker rated 600V as shown in the Table 2-3-5 (30 HP or less).
- In case of using auxiliary control-power input, connect it by referring to the basic connection diagram (2-3-1).
- Suitable for use on a circuit capable of delivering not more than 5000rms symmetrical amperes, for 230V (230V series), 480V (460V series) maximum up to 30HP; 42000rms symmetrical amperes 230V (230V series), 480V (460V series) maximum 40HP and above.
- Use 60/75 °C CU wire only.
- A Class 2 circuit wired with Class 1 wire (30HP or less). Use Class 1 wire only (40HP or more).
- Field wiring connection must be made by a UL Listed and CSA Certified closed-loop terminal connector sized for the wire gauge involved. Connector must be fixed using the crimp tool specified by the connector manufacturer.
- Solid state motor overload protection is provided in each model.

Other Instructions

WARNING

- Never modify the product. Electric shock or injury may result.

Conformity to Low Voltage Directive in Europe

CAUTION

- The contact capacity of alarm output for any fault (30A, B, C) and relay signal output (Y5A, Y5C) is 0.5A at 48V DC, 0.3A - 250 VAC
- The ground terminal (G) should be connected to ground. Use a crimp terminal to connect a cable to the main circuit terminal or drive ground terminal.
- Where a residual-current protective device (RCD) is used for protection in case of direct or indirect contact, only a type B device is allowed on the supply side of this electrical equipment. Otherwise, another protective measure shall be applied such as separation of the electrical equipment from the environment by double or reinforced insulation or isolation of the electrical equipment and supply system by the transformer.
- Use a single cable to connect the (G) drive ground terminal. Do not use two or more drive ground terminals.
- Use only a molded-case circuit breaker (MCCB) or magnetic contactor (MC) that conform to EN or IEC standards.
- Operate the drive under over-voltage Category III conditions and maintain Pollution Degree 2 or better as specified in IEC664. To maintain Pollution Degree 2 or better, install the drive in a control panel structure (level NEMA 3 or higher) which is free from water, oil, carbon, dust, etc.
- For the input-output wiring of the drive, use cable diameter and type as specified in Appendix C in EN60204.
- To ensure safety, install an optional AC reactor, DC reactor, or external braking resistor as follows:
 - 1) Install inside an IP4X cabinet or barrier if electrical parts are exposed.
 - 2) Install inside an IP2X cabinet or barrier if electrical parts are not exposed.
- In case of external cooling system, cover the drive rear side in order not to touch the main capacitor and braking resistor.

General Instructions

For clarity, some figures in this manual may show the drive with covers and safety screens removed for explanation purposes. Do not operate the device until all such covers and screens have been replaced.

GP10™ Model Number Configurator

Description **GP10** **E1ST** **3** **4** **010** **A** **1**

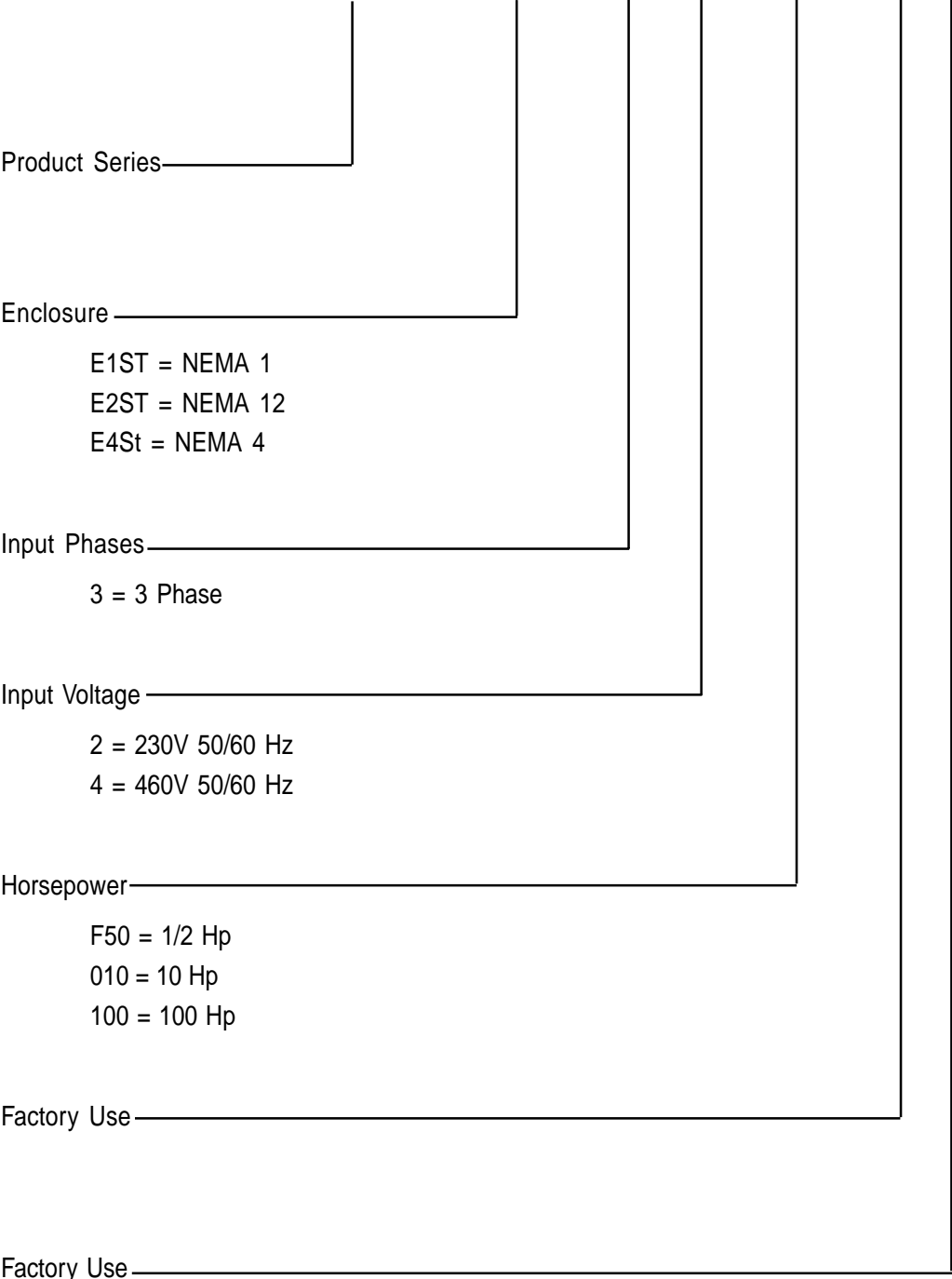

GP10 Dimensions & Weights

GP10 Variable Torque/Constant Torque (VT/CT)

HP Rating (VT/CT)	NEMA Enclosure	Rated Output Current (A)	Overload (110%/150% 1min.)	GP10 Model No.	Part No.	Dimensions H x W x D (inches)	Weight (lbs)
230VAC, 3 phase, 50/60Hz Input, NEMA 1							
0.25/0.25	1	1.5/1.5	1.7/2.3	GP10E1ST32F25**	GP102F25-1	10.24 x 4.33 x 5.12	4.8
0.5/0.5	1	3/3	3.3/4.5	GP10E1ST32F50**	GP102F50-1	10.24 x 4.33 x 5.12	4.8
1/1	1	5/5	5.5/7.5	GP10E1ST32001**	GP102001-1	10.24 x 4.33 x 5.71	5.5
2/2	1	8/8	8.8/12	GP10E1ST32002**	GP102002-1	10.24 x 5.91 x 5.71	8.4
3/3	1	11/11	12/17	GP10E1ST32003**	GP102003-1	10.24 x 5.91 x 5.71	8.4
5/5	1	17/17	19/26	GP10E1ST32005**	GP102005-1	10.24 x 5.91 x 5.71	8.4
7.5/5	1	22/17	24/26	GP10E1ST32007**	GP102007-1	10.24 x 8.66 x 7.68	12.6
10/7.5	1	29/25	32/38	GP10E1ST32010**	GP102010-1	10.24 x 8.66 x 7.68	12.6
15/10	1	42/33	46/50	GP10E1ST32015**	GP102015-1	10.24 x 8.66 x 7.68	12.6
20/15	1	55/45	61/69	GP10E1ST32020**	GP102020-1	15.75 x 9.84 x 7.68	22.0
25/20	1	68/59	75/89	GP10E1ST32025**	GP102025-1	15.75 x 9.84 x 7.68	22.0
30/25	1	80/74	88/110	GP10E1ST32030**	GP102030-1	15.75 x 9.84 x 7.68	23.1
40/30	1	115/87	127/131	GP10E1ST32040**	GP102040-1	29.7 x 13.5 x 10.0	70
50/40	1	145/115	160/173	GP10E1ST32050**	GP102050-1	29.7 x 13.5 x 10.0	70
60/50	1	180/145	198/218	GP10E1ST32060**	GP102060-1	33.1 x 14.9 x 10.6	86
75/60	1	215/180	215/180	GP10E1ST32075**	GP102075-1	38.0 x 14.9 x 10.6	106
100/75	1	283/215	283/215	GP10E1ST32100**	GP102100-1	38.0 x 14.9 x 10.6	110
125/100	1	346/283	346/283	GP10E1ST32125**	GP102125-1	41.3 x 21.0 x 11.2	172
150/125	1	415/346	415/346	GP10E1ST32150**	GP102150-1	50.4 x 26.9 x 14.2	282

230VAC, 3 phase, 50/60Hz Input, NEMA 4

0.25/0.25	4	1.5/1.5	1.7/2.3	GP10E4ST32F25**	GP102F25-4	10.24 x 4.33 x 5.12	4.8
0.5/0.5	4	3/3	3.3/4.5	GP10E4ST32F50**	GP102F50-4	10.24 x 4.33 x 5.12	4.8
1/1	4	5/5	5.5/7.5	GP10E4ST32001**	GP102001-4	10.24 x 4.33 x 5.71	5.5
2/2	4	8/8	8.8/12	GP10E4ST32002**	GP102002-4	10.24 x 5.91 x 5.71	8.4
3/3	4	11/11	12/17	GP10E4ST32003**	GP102003-4	10.24 x 5.91 x 5.71	8.4
5/5	4	17/17	19/26	GP10E4ST32005**	GP102005-4	10.24 x 5.91 x 5.71	8.4
7.5/5	4	22/17	24/26	GP10E4ST32007**	GP102007-4	10.24 x 8.66 x 7.68	12.6
10/7.5	4	29/25	32/38	GP10E4ST32010**	GP102010-4	10.24 x 8.66 x 7.68	12.6
15/10	4	42/33	46/50	GP10E4ST32015**	GP102015-4	10.24 x 8.66 x 7.68	12.6

230VAC, 3 phase, 50/60Hz Input, NEMA 12

20/15	12	55/45	61/69	GP10E2ST32020**	GP102020-2	15.75 x 9.84 x 7.68	22.0
25/20	12	68/59	75/89	GP10E2ST32025**	GP102025-2	15.75 x 9.84 x 7.68	22.0
30/25	12	80/74	88/110	GP10E2ST32030**	GP102030-2	15.75 x 9.84 x 7.68	23.1

230VAC, 3 phase, 50/60Hz Input, Open

40/30	Open	115/87	127/131	GP10E9ST32040**	GP102040-9	21.7 x 13.4 x 10.0	64
50/40	Open	145/115	160/173	GP10E9ST32050**	GP102050-9	21.7 x 13.4 x 10.0	64
60/50	Open	180/145	198/218	GP10E9ST32060**	GP102060-9	24.2 x 14.8 x 10.6	79
75/60	Open	215/180	237/270	GP10E9ST32075**	GP102075-9	29.1 x 14.8 x 10.6	97
100/75	Open	283/215	311/323	GP10E9ST32100**	GP102100-9	29.1 x 14.8 x 10.6	101
125/100	Open	346/283	381/425	GP10E9ST32125**	GP102125-9	29.5 x 20.9 x 11.2	154
150/125	Open	415/346	457/519	GP10E9ST32150**	GP102150-9	34.6 x 26.8 x 14.2	253

**Indicates factory use.

Note: Hp rating is shown for 230V and 460V nominal systems.

When applying at lower voltage, select the drive by rated current and not Hp rating.

GP10 Dimensions & Weights

GP10 Variable Torque/Constant Torque (VT/CT)

HP Rating (VT/CT)	NEMA Enclosure	Rated Output Current (A)	Overload (110%/150% 1min.)	GP10 Model No.	Part No.	Dimensions H x W x D (inches)	Weight (lbs)
230VAC, 3 phase, 50/60Hz Input, Open with NEMA 12 Heatsink							
40/30	Open	115/87	127/131	GP10E8ST32040 **	GP102040-8	21.7 x 13.4 x 10.0	64
50/40	Open	145/115	160/173	GP10E8ST32050 **	GP102050-8	21.7 x 13.4 x 10.0	64
60/50	Open	180/145	198/218	GP10E8ST32060 **	GP102060-8	24.2 x 14.8 x 10.6	79
75/60	Open	215/180	237/270	GP10E8ST32075 **	GP102075-8	29.1 x 14.8 x 10.6	97
100/75	Open	283/215	311/323	GP10E8ST32100 **	GP102100-8	29.1 x 14.8 x 10.6	101
125/100	Open	346/283	381/425	GP10E8ST32125 **	GP102125-8	29.5 x 20.9 x 11.2	154
150/125	Open	415/346	457/519	GP10E8ST32150 **	GP102150-8	34.6 x 26.8 x 14.2	253

460VAC, 3 phase, 50/60Hz Input, NEMA 1

0.5/0.5	1	1.5/1.5	1.7/2.3	GP10E1ST34F50 **	GP104F50-1	10.24 x 4.33 x 5.12	4.8
1/1	1	2.5/2.5	2.8/3.8	GP10E1ST34001 **	GP104001-1	10.24 x 4.33 x 5.71	5.5
2/2	1	3.7/3.7	4.1/5.6	GP10E1ST34002 **	GP104002-1	10.24 x 5.91 x 5.71	8.4
3/3	1	5.5/5.5	6.1/8.3	GP10E1ST34003 **	GP104003-1	10.24 x 5.91 x 5.71	8.4
5/5	1	9/9	9.9/14	GP10E1ST34005 **	GP104005-1	10.24 x 5.91 x 5.71	8.4
7.5/5	1	12.5/9	14/14	GP10E1ST34007 **	GP104007-1	10.24 x 8.66 x 7.68	13.4
10/7.5	1	16.5/13	18/20	GP10E1ST34010 **	GP104010-1	10.24 x 8.66 x 7.68	13.4
15/10	1	23/18	25/27	GP10E1ST34015 **	GP104015-1	10.24 x 8.66 x 7.68	13.4
20/15	1	30/24	33/36	GP10E1ST34020 **	GP104020-1	15.75 x 9.84 x 7.68	22.0
25/20	1	37/30	41/45	GP10E1ST34025 **	GP104025-1	15.75 x 9.84 x 7.68	22.0
30/25	1	44/39	48/59	GP10E1ST34030 **	GP104030-1	15.75 x 9.84 x 7.68	23.1
40/30	1	60/45	66/68	GP10E1ST34040 **	GP104040-1	29.7 x 13.5 x 10.0	70
50/40	1	75/60	83/90	GP10E1ST34050 **	GP104050-1	29.7 x 13.5 x 10.0	70
60/50	1	91/75	100/113	GP10E1ST34060 **	GP104060-1	29.7 x 14.9 x 10.6	82
75/60	1	112/91	123/137	GP10E1ST34075 **	GP104075-1	34.6 x 14.9 x 10.6	95
100/75	1	150/112	165/168	GP10E1ST34100 **	GP104100-1	34.6 x 14.9 x 10.6	97
125/100	1	176/150	194/225	GP10E1ST34125 **	GP104125-1	38.0 x 14.9 x 10.6	115
150/125	1	210/176	231/264	GP10E1ST34150 **	GP104150-1	38.0 x 21.0 x 12.4	174
200/150	1	253/210	278/315	GP10E1ST34200 **	GP104200-1	38.0 x 21.0 x 12.4	174
250/200	1	304/253	334/380	GP10E1ST34250 **	GP104250-1	53.1 x 21.0 x 14.2	245
300/250	1	377/304	415/456	GP10E1ST34300 **	GP104300-1	53.1 x 21.0 x 14.2	245
350/300	1	415/377	457/566	GP10E1ST34350 **	GP104350-1	55.1 x 26.9 x 14.2	337
400/350	1	485/415	534/623	GP10E1ST34400 **	GP104400-1	55.1 x 26.9 x 14.2	337
450/350	1	520/415	572/623	GP10E1ST34450 **	GP104450-1	55.1 x 26.9 x 14.2	337
500/400	1	650/520	715/780	GP10E1ST34500 **	GP104500-1	57.1 x 26.8 x 17.7	562
600/450	1	740/585	814/878	GP10E1ST34600 **	GP104600-1	57.1 x 26.8 x 17.7	562
700/500	1	840/650	924/975	GP10E1ST34700 **	GP104700-1	57.1 x 34.6 x 17.7	804
800/600	1	960/740	1056/1110	GP10E1ST34800 **	GP104800-1	57.1 x 34.6 x 17.7	804

460VAC, 3 phase, 50/60Hz Input, NEMA 4

0.5/0.5	4	1.5/1.5	1.7/2.3	GP10E4ST34F50##	GP104F50-4	10.24 x 4.33 x 5.12	4.8
1/1	4	2.5/2.5	2.8/3.8	GP10E4ST34001##	GP104001-4	10.24 x 4.33 x 5.71	5.5
2/2	4	3.7/3.7	4.1/5.6	GP10E4ST34002##	GP104002-4	10.24 x 5.91 x 5.71	8.4
3/3	4	5.5/5.5	6.1/8.3	GP10E4ST34003##	GP104003-4	10.24 x 5.91 x 5.71	8.4
5/5	4	9/9	9.9/14	GP10E4ST34005##	GP104005-4	10.24 x 5.91 x 5.71	8.4
7.5/5	4	12.5/9	14/14	GP10E4ST34007##	GP104007-4	10.24 x 8.66 x 7.68	13.4
10/7.5	4	16.5/13	18/20	GP10E4ST34010##	GP104010-4	10.24 x 8.66 x 7.68	13.4
15/10	4	23/18	25/27	GP10E4ST34015##	GP104015-4	10.24 x 8.66 x 7.68	13.4

**Indicates factory use.

Note: Hp rating is shown for 230V and 460V nominal systems.

When applying at lower voltage, select the drive by rated current and not Hp rating.

GP10 Dimensions & Weights

GP10 Variable Torque/Constant Torque (VT/CT)

HP Rating (VT/CT)	NEMA Enclosure	Rated Output Current (A)	Overload (110%/150% 1min.)	GP10 Model No.	Part No.	Dimensions H x W x D (inches)	Weight (lbs)
460VAC, 3 phase, 50/60Hz Input, NEMA 12							
20/15	12	30/24	33/36	GP10E2ST34020 **	GP104020-2	15.75 x 9.84 x 7.68	22.0
25/20	12	37/30	41/45	GP10E2ST34025 **	GP104025-2	15.75 x 9.84 x 7.68	22.0
30/25	12	44/39	48/59	GP10E2ST34030 **	GP104030-2	15.75 x 9.84 x 7.68	23.1

460VAC, 3 phase, 50/60Hz Input, Open

40/30	Open	60/45	66/68	GP10E9ST34040 **	GP104040-9	21.7 x 13.4 x 10.0	64
50/40	Open	75/60	83/90	GP10E9ST34050 **	GP104050-9	21.7 x 13.4 x 10.0	64
60/50	Open	91/75	100/113	GP10E9ST34060 **	GP104060-9	21.7 x 14.8 x 10.6	75
75/60	Open	112/91	123/137	GP10E9ST34075 **	GP104075-9	26.6 x 14.8 x 10.6	86
100/75	Open	150/112	165/168	GP10E9ST34100 **	GP104100-9	26.6 x 14.8 x 10.6	88
125/100	Open	176/150	194/225	GP10E9ST34125 **	GP104125-9	29.1 x 14.8 x 10.6	106
150/125	Open	210/176	231/264	GP10E9ST34150 **	GP104150-9	29.1 x 20.9 x 12.4	154
200/150	Open	253/210	278/315	GP10E9ST34200 **	GP104200-9	29.1 x 20.9 x 12.4	154
250/200	Open	304/253	334/380	GP10E9ST34250 **	GP104250-9	39.4 x 20.9 x 14.2	220
300/250	Open	377/304	415/456	GP10E9ST34300 **	GP104300-9	39.4 x 20.9 x 14.2	220
350/300	Open	415/377	457/566	GP10E9ST34350 **	GP104350-9	39.4 x 26.8 x 14.2	308
400/350	Open	485/415	534/623	GP10E9ST34400 **	GP104400-9	39.4 x 26.8 x 14.2	308
450/350	Open	520/415	572/623	GP10E9ST34450 **	GP104450-9	39.4 x 26.8 x 14.2	308
500/400	Open	650/520	715/780	GP10E9ST34500 **	GP104500-9	55.1 x 26.8 x 17.7	551
600/450	Open	740/585	814/878	GP10E9ST34600 **	GP104600-9	55.1 x 26.8 x 17.7	551
700/500	Open	840/650	924/975	GP10E9ST34700 **	GP104700-9	55.1 x 35.6 x 17.7	793
800/600	Open	960/740	1056/1110	GP10E9ST34800 **	GP104800-9	55.1 x 35.6 x 17.7	793

460VAC, 3 phase, 50/60Hz Input, Open with NEMA 12 Heatsink

40/30	Open	60/45	66/68	GP10E8ST34040 **	GP104040-8	21.7 x 13.4 x 10.0	64
50/40	Open	75/60	83/90	GP10E8ST34050 **	GP104050-8	21.7 x 13.4 x 10.0	64
60/50	Open	91/75	100/113	GP10E8ST34060 **	GP104060-8	21.7 x 14.8 x 10.6	75
75/60	Open	112/91	123/137	GP10E8ST34075 **	GP104075-8	26.6 x 14.8 x 10.6	86
100/75	Open	150/112	165/168	GP10E8ST34100 **	GP104100-8	26.6 x 14.8 x 10.6	88
125/100	Open	176/150	194/225	GP10E8ST34125 **	GP104125-8	29.1 x 14.8 x 10.6	106
150/125	Open	210/176	231/264	GP10E8ST34150 **	GP104150-8	29.1 x 20.9 x 12.4	154
200/150	Open	253/210	278/315	GP10E8ST34200 **	GP104200-8	29.1 x 20.9 x 12.4	154
200/150	Open	304/253	334/380	GP10E8ST34250 **	GP104250-8	39.4 x 20.9 x 14.2	220
250/200	Open	377/304	415/456	GP10E8ST34300 **	GP104300-8	39.4 x 20.9 x 14.2	220
300/250	Open	415/377	457/566	GP10E8ST34350 **	GP104350-8	39.4 x 26.8 x 14.2	308
350/300	Open	485/415	534/623	GP10E8ST34400 **	GP104400-8	39.4 x 26.8 x 14.2	308
400/350	Open	520/415	572/623	GP10E8ST34450 **	GP104450-8	39.4 x 26.8 x 14.2	308
500/400	Open	650/520	715/780	GP10E8ST34500 **	GP104500-8	55.1 x 26.8 x 17.7	551
600/450	Open	740/585	814/878	GP10E8ST34600 **	GP104600-8	55.1 x 26.8 x 17.7	551
700/500	Open	840/650	924/975	GP10E8ST34700 **	GP104700-8	55.1 x 35.6 x 17.7	793
800/600	Open	960/740	1056/1110	GP10E8ST34800 **	GP104800-8	55.1 x 35.6 x 17.7	793

** Indicates factory use.

Note: Hp rating is shown for 230V and 460V nominal systems.

When applying at lower voltage, select the drive by rated current and not Hp rating.



1. Before Using This Product

1.1 Receiving Instructions

Unpack and check the product as explained below.

If you have any questions about the product, contact Safronics or your local distributor.

1. Check the ratings nameplate to confirm that the delivered product is the one that was ordered.

SAFRONICS GP10		 		
Model No.		VT	Output	CT
Serial No.				
Volts	HP			
Amps	Volts			
Freq(Hz)	Freq. Range (Hz)			
Phase(s)	Amps			
		Overload		
NEMA Enclosure Type:		Made in Mexico		
Instruction Book				

SER. No. : 0110-00012M0001

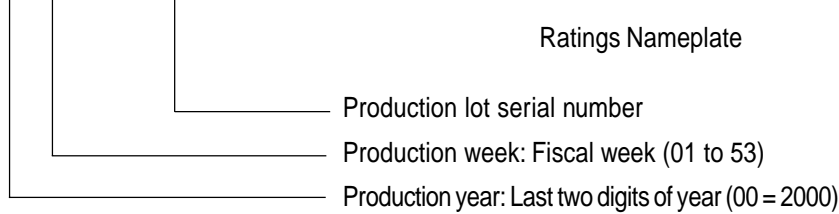

Ratings Nameplate

2. Check for damaged and/or missing parts upon delivery.
3. In addition to the drive unit and this manual, the package contains rubber bushings (for products with 30 Hp or less) and a terminating resistor (1/2 W, 120 ohm). The terminating resistors for products with 30 Hp or less are packaged separately. The terminating resistors for products with 40HP or more are installed internal to the drive unit. To connect the internal terminating resistor, place hardware jumper J2 to the "ON" position. This terminating resistor is required for RS485 RTU communication.
4. On drives rated 100 Hp and larger, a separately mounted DC Link Reactor is provided. The reactor should be checked for proper rating before installation.

1.2 Appearance

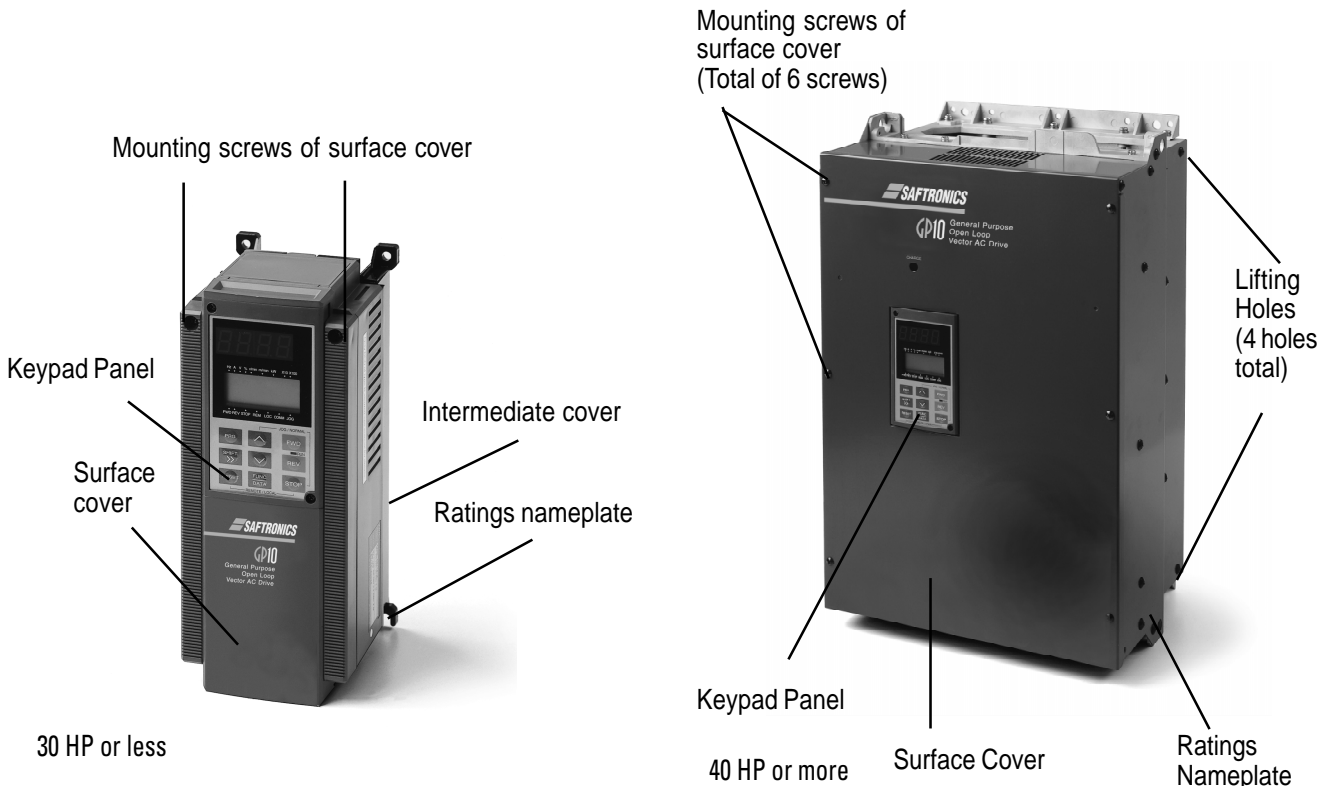

1.3 Handling the Product

(1) Removing the Cover

For drives 30HP or less, loosen the cover mounting screws, then remove the cover by pulling from the top (see Figure 1.3.1).

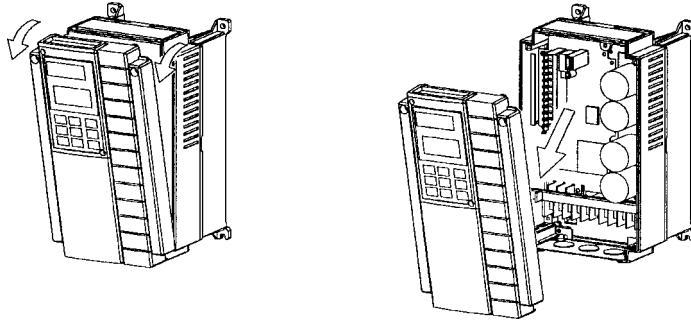

Fig.1-3-1 Removing the Cover (for drives of 30HP or less)

For drives 40HP or more, first remove the six cover mounting screws, then remove the cover.

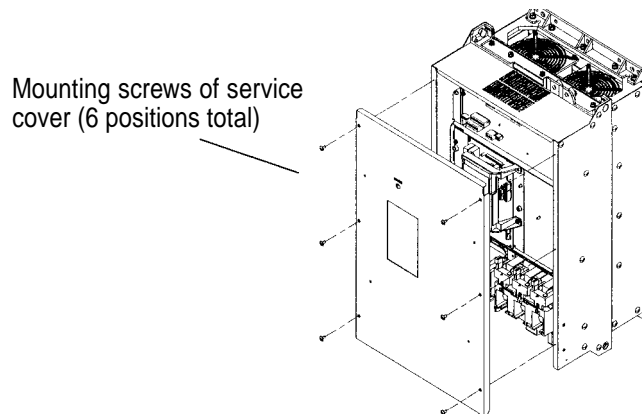

Fig.1-3-2 Removing the Cover (for drives of 40HP or more)

(2) Removing the Keypad Panel

After removing the cover as explained in (1), loosen the keypad panel mounting screws and remove as shown in Figure 1.3.3 for drives 30HP or less.

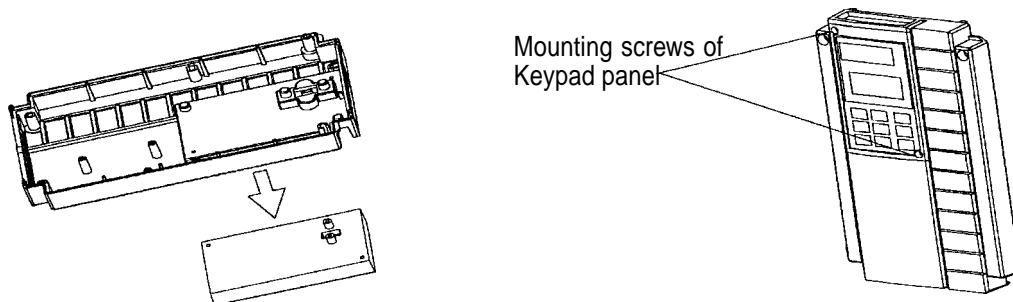
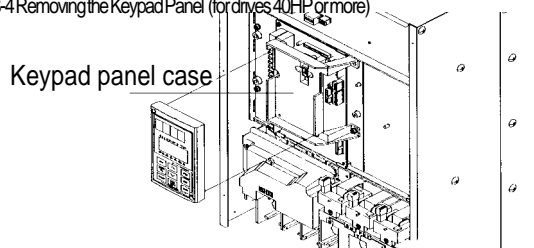

Fig.1-3-3 Removing the Keypad Panel (for drives of 30 HP or less)

For drives 40HP or more, loosen the keypad panel mounting screws and remove, using the finger holds on the keypad panel case.

Fig.1-3-4 Removing the Keypad Panel (for drives 40HP or more)



1.4 Carrying

Carry the product by the main unit. Do not carry the product by its cover or parts other than the main unit. Use a crane or hoist to carry a product equipped with hanging holes.

1.5 Storage

Temporary Storage

Temporary storage of this product must meet the conditions listed in Table 1-5-1.

Table 1-5-1 Storage Environment

Item		Specifications
Ambient Temperature	-10° to +50°C (+14° to +122°F)	Condensation or freezing, as a result of sudden temperature changes, must not occur.
Storage Temperature	-25° to +65°C ¹ (-4° to +149°F)	
Relative Humidity	5 to 95% ²	
Atmosphere	The standard product must not be exposed to dust, direct sunlight, corrosive gas, flammable gas, oil mist, vapor, water drops, or vibration. The salt content in the atmosphere should be minimized.	

Note 1: The storage temperature applies only to short periods of time, such as during transport. Refer to comments on extended storage guidelines.

Note 2: Since a large change in temperature within this humidity range may result in condensation or freezing, do not store where such temperature changes may occur.

1. Do not place this product directly on the floor.
2. To store the product in an extreme environment, pack in vinyl sheeting, etc.
3. If the product is stored in a high-humidity environment, insert a drying agent (e.g., silica gel) and pack the product in vinyl sheeting.

Long-term Storage

If the product is to be stored for an extended period of time after purchase, the method of storage depends primarily on the storage location.

The general long-term storage method is as follows:

1. The above conditions for temporary storage must be satisfied. If the storage period exceeds three months, the upper limit of ambient temperature must be reduced to 30°C (86°F) to prevent the deterioration of the electrolytic capacitors.
2. Pack the product thoroughly to eliminate exposure to moisture and include a drying agent to ensure a relative humidity of about 70% or less.
3. Do not leave the product mounted in a control panel and exposed to the elements like moisture or dust (particularly on a construction site). In this case, remove the product and store in a suitable environment.
4. Electrolytic capacitors will deteriorate if not provided with power for an extended period of time. Do not store electrolytic capacitors for one year or longer without providing power.

1.6 GP10 Drive Ratings Efficiency and Watts Loss

HP Rating	Rated Output Current (A)	Rated Output Power (KVA)	Efficiency at 2KHz (%)	Efficiency at 15KHz (%)	Watts Loss at 2KHz (W)	Watts Loss at 15KHz (W)	Internal DB (W)
230VAC							
0.25	1.5	0.59	92.0	90.5	25	30	N/A
0.5	3	1.1	93.5	91.7	35	45	N/A
1	5	1.9	94.9	94.0	50	60	N/A
2	8	3.1	95.7	94.1	80	110	N/A
3	11	4.3	95.9	94.9	110	140	N/A
5	17	6.7	96.2	95.4	170	210	N/A
7.5	22	8.7	96.2	95.2	210	280	N/A
10	29	11	96.5	95.3	290	370	N/A
15	42	16	96.4	95.2	410	550	N/A
20	55	21	96.9	95.9	500	670	N/A
25	67	26	96.8	95.8	630	840	N/A
30	78	31	96.5	95.5	770	1030	N/A
			2KHz (%)	10KHz (%)	2KHz (W)	10KHz (W)	
40	115	45	97.2	96.8	950	1100	N/A
50	145	57	97.0	96.7	1250	1400	N/A
60	180	71	97.1	96.6	1500	1750	N/A
75	215	85	97.3	96.6	1700	1950	N/A
100	283	112	97.4	97.0	2200	2500	N/A
			2KHz (%)	6KHz (%)	2KHz (W)	6KHz (W)	
125	346	137	97.4	97.2	2650	2800	N/A
150	415	165	97.4	97.3	3200	3350	N/A
460VAC							
0.5	1.5	1.1	93.5	89.3	35	60	N/A
1	2.5	1.9	95.4	91.7	45	85	N/A
2	3.7	2.9	96.7	94.1	60	110	N/A
3	5.5	4.3	97.0	94.5	80	150	N/A
5	9	7.1	97.1	95.0	130	230	N/A
7.5	12.5	9.9	97.3	95.3	160	290	N/A
10	16.5	13.1	97.3	95.4	210	370	N/A
15	23	18.3	97.6	95.9	300	520	N/A
20	30	23.9	97.9	96.5	360	610	N/A
25	37	29.4	97.8	96.4	460	770	N/A
30	44	35	97.8	96.4	530	870	N/A
			2KHz (%)	10KHz (%)	2KHz (W)	10KHz (W)	
40	60	47	97.8	96.9	750	1050	N/A
50	75	59	97.7	96.9	950	1300	N/A
60	91	72	97.8	97.0	1100	1550	N/A
75	112	89	97.8	97.0	1350	1900	N/A
100	150	119	97.8	97.1	1800	2450	N/A
			2KHz (%)	6KHz (%)	2KHz (W)	6KHz (W)	
125	176	140	98.1	97.8	1850	2200	N/A
150	210	167	98.0	97.8	2400	2750	N/A
200	253	202	98.0	97.7	2900	3350	N/A
250	304	242	98.1	97.8	3250	3800	N/A
300	377	300	98.1	97.8	4250	4900	N/A
350	415	330	98.2	97.9	4350	5100	N/A
400	485	386	98.1	97.8	5100	5900	N/A
450	520	414	98.1	97.8	5700	6650	N/A
500	650	518	98.2	97.9	6900	8050	N/A
600	740	590	98.1	97.8	8050	9350	N/A
700	840	669	98.2	97.9	8900	10400	N/A
800	960	765	98.1	97.8	10300	12100	N/A

2. Installation Environment and Connection

2.1 Operating Environment

Install this product in a location that meets the conditions listed in Table 2-1-1.

Table 2-1-1 Operating Environment

Item	Specifications
Location	Indoors
Ambient Temperature	-10° to +50°C (+14° to +122°F) - for products of 30 HP or less, the ventilating covers must be removed if ambient temperature exceeds +40°C (104°F), NEMA Type 4 & 12 Unit -10° to +40°C (+14° to +104°F)
Relative Humidity	5 to 95% (No condensation).
Atmosphere	The product must not be exposed to dust, direct sunlight, corrosive gas, oil mist, vapor, or water. There must be a minimum salt content in the atmosphere. Do not store where condensation may occur as a result of sudden changes in temperature.
Altitude	1000 m (3300 feet) or lower - For altitude above 1000 m (3300 feet), see Table 2-1-2.
Vibration	3mm peak from 2 to 9Hz, 9.8m/s ² from 9 to 20Hz, 2m/s ² from 20-55Hz, 1m/s ² from 55 to 200Hzs.

2.2 Installation Method

1. Securely fasten the product in an upright position on a solid structure with the logo facing the front. Do not turn the product upside down or install in a horizontal position. Fig. 2-2-1
2. Since heat is generated during drive operation, the spaces shown in Fig. 2-2-1 are required to ensure sufficient cooling. Do not install the product beneath a device sensitive to heat as heat radiates upward.
3. The heat sink may reach a temperature of 90°C (+194°F) during drive operation. Ensure that the material surrounding the product can withstand this temperature.

WARNING

Install this product on nonflammable material such as metal.

4. When installing this product in a control panel, consider ventilation to prevent the drive's ambient temperature from exceeding the specified value. Do not install the product in an area from which heat cannot be sufficiently released.
5. If two or more drives must be installed in the same device or control panel, arrange the units horizontally to minimize the effect of heat. If two or more drives must be installed vertically, place an insulated plate between the drives to minimize the effect of heat.
6. When shipped from the factory, drives provide internal cooling inside the panel. A drive of 30HP or less can be converted to external cooling simply by adding an optional mounting adapter.

CAUTION

Ensure that the drive and heat sink surfaces are kept free of foreign matter such as lint, paper dust, small chips of wood or metal, and dust. **Fire or accident may result.**

Table 2-1-2 Output current reduction rate based on altitude

Altitude	Output current reduction rate
3300 feet (1000m or lower)	1
3300-4950 feet (1000-1500m)	0.97
4950-6600 feet (1500-2000m)	0.95
6600-8250 feet (2000-2500m)	0.91
8250-9900 feet (2500-3000m)	0.88

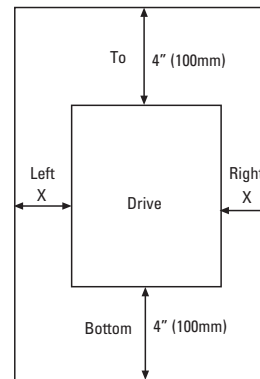

Fig. 2-2-1 30 HP or less: Gap X can be 0. (side-by-side installation) 40HP or more: Gap X >= 2.0" (50mm)

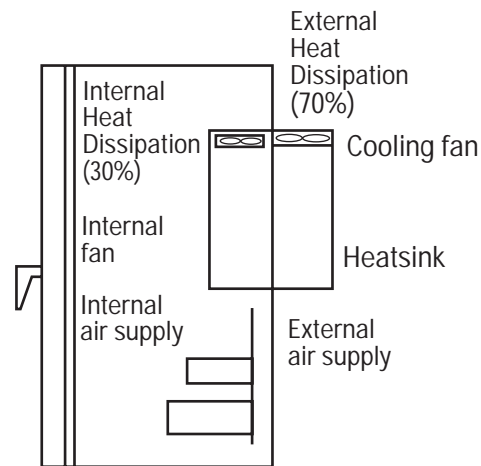

Fig. 2-2-2 Through Panel Mount

A drive of 40HP or more can be converted to external cooling simply by moving the upper and lower mounting brackets as shown in Fig. 2-2-3. Remove the M6 bracket screws, move the brackets, then secure the brackets using the M5 case mounting screws. (The bracket screws are no longer required after changing the bracket mounting position.)

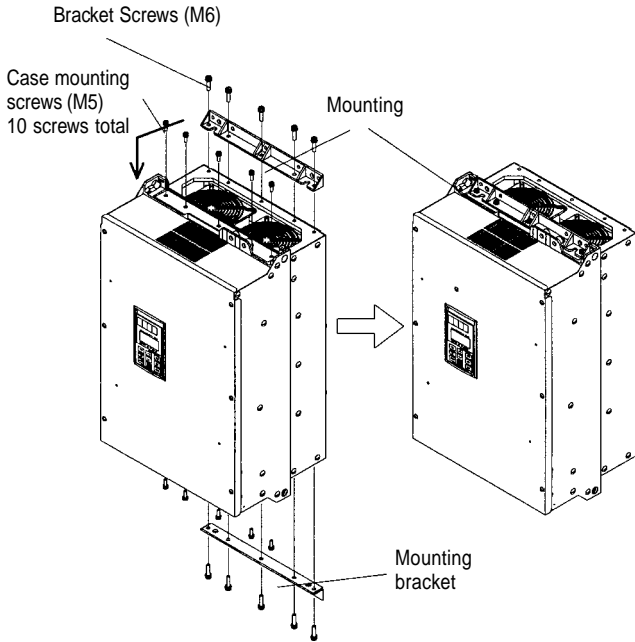

Fig. 2-2-3

In an external cooling system, a heat sink radiating about 70% of total drive heat (total loss) can be placed outside the device or control panel, as shown in Fig. 2-2-2.

7. For drives of 30HP or less, remove the ventilating covers if ambient temperature exceeds +40°C (104°F).

1. Removing the Ventilating Covers

One ventilating cover is mounted on top of the drive and two or three are mounted at the bottom. Remove the main cover and then remove ventilating covers by popping out the cover inserts as shown in Fig. 2-2-4.

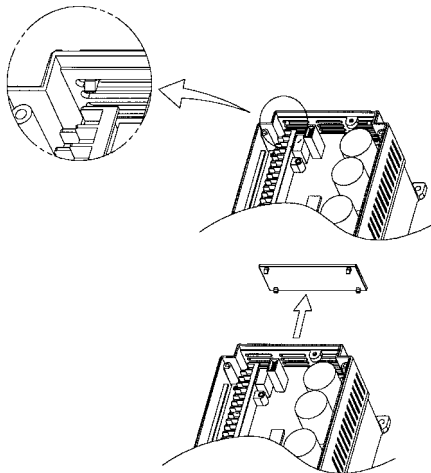

Fig. 2-2-4 Removing the ventilating cover

Installation of Open Type with NEMA 12 Heatsink Drive (40 Hp and above)

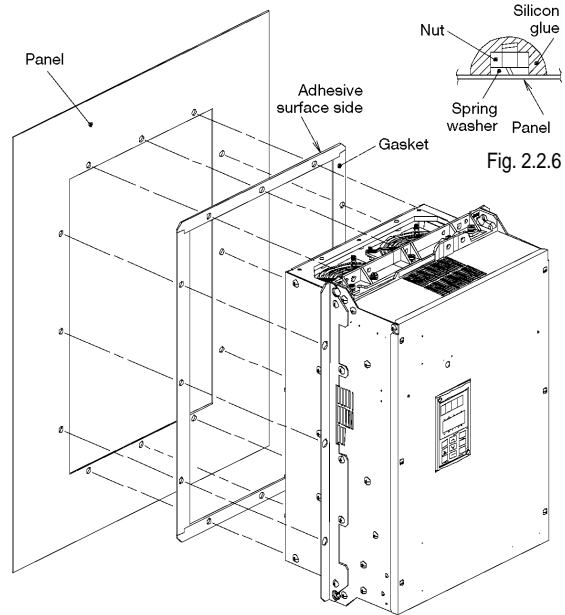

Fig.2.2.5

1. Remove adhesive protection strip from gasket and then mount gasket to panel/enclosure, carefully aligning cutout and mounting holes.
2. Install the drive unit and tighten the mounting bolt and nut. (Tightening torque: 119 lbs-inch [M8], 425 lbs-inch [M12]). Mounting hardware to be supplied by customer. (refer to figure 2.2.5)
3. After proper torque has been applied to all mounting hardware, seal the outside end of the hardware with silicon glue. Silicon glue to be supplied by the customer. (Refer to Fig. 2.2.6)

2.3 Connection

Remove the main cover before connecting the terminal blocks as follows.

2-3-1 Basic Connection

1. Always connect power to the L1/R, L2/S, and L3/T main circuit power terminals on the drive. Connecting power to another terminal will damage the drive. Check that the input voltage is within the maximum allowable voltage marked on the nameplate, etc.
2. Always wire the ground terminal to ground to prevent problems such as fire or electric shock and to minimize noise.
3. Use a reliable crimp terminal for connection between a power terminal and a power wire.
4. After terminating the wiring connection, confirm the following:
 - a. Confirm that the connection is correct.
 - b. Confirm that all necessary connections have been made.
 - c. Confirm that there is no short-circuit or ground fault between the terminals and wire.
5. Connection modification after power-on.

The smoothing capacitor in the direct current portion of the main circuit cannot be discharged immediately after the power is turned off. To insure safety, use a multimeter to check that the direct current (DC) voltage is lowered to the safety range (25V DC or less) after the charge lamp goes off. Also, confirm that the voltage is zero before short-circuiting. The residual voltage (electric charge) may cause sparks.

WARNING

Always connect a ground wire. Electric shock or fire may result. Ensure that a trained specialist performs all wiring. Confirm that the power is turned off (open) before beginning any wiring operations. Electrical shock may result.

2.3.1 Basic Connection Diagram (Sink Logic)

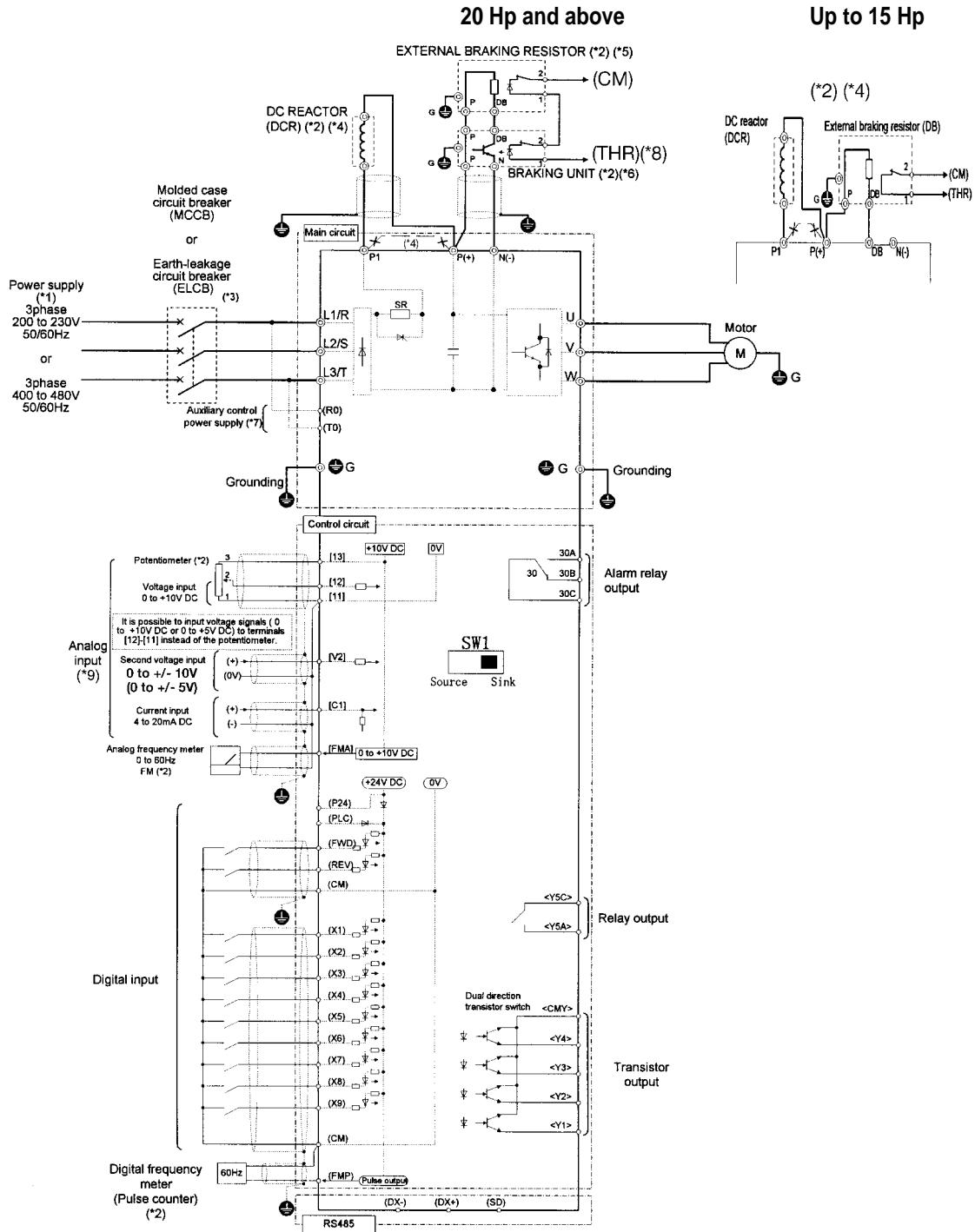

Note: The control circuit common terminals [11], (CM) and <CMY> are isolated

(*1) Use a drive with rated voltage matching the power supply voltage.

(*2) Use as required.

(*3) Use this peripheral device when necessary.

(*4) Remove the jumper wire between P1 and P(+) before connecting a DC REACTOR.

(*5) Be sure to use the braking unit (option) when connecting the external braking resistor (option)

(*6) Connect the braking unit to P(+) and N(-). The auxiliary terminals [1] and [2] have polarity.

Connect them as shown in the figure above.

(*7) The drive can be operated without connecting the auxiliary control power supply.

(*8) Terminal (X1) to (X9) can be set to 9 (THR) - Braking unit thermal trip input.

(*9) If using V2 or C1, as a reference signal, they must be used exclusively.

(*10) It is possible to input voltage signals (0 to +10 VDC or 0 to +5 VDC) to terminals [12] [11] instead of the potentiometer.

Basic Connection Diagram to PLC (Sink Logic)

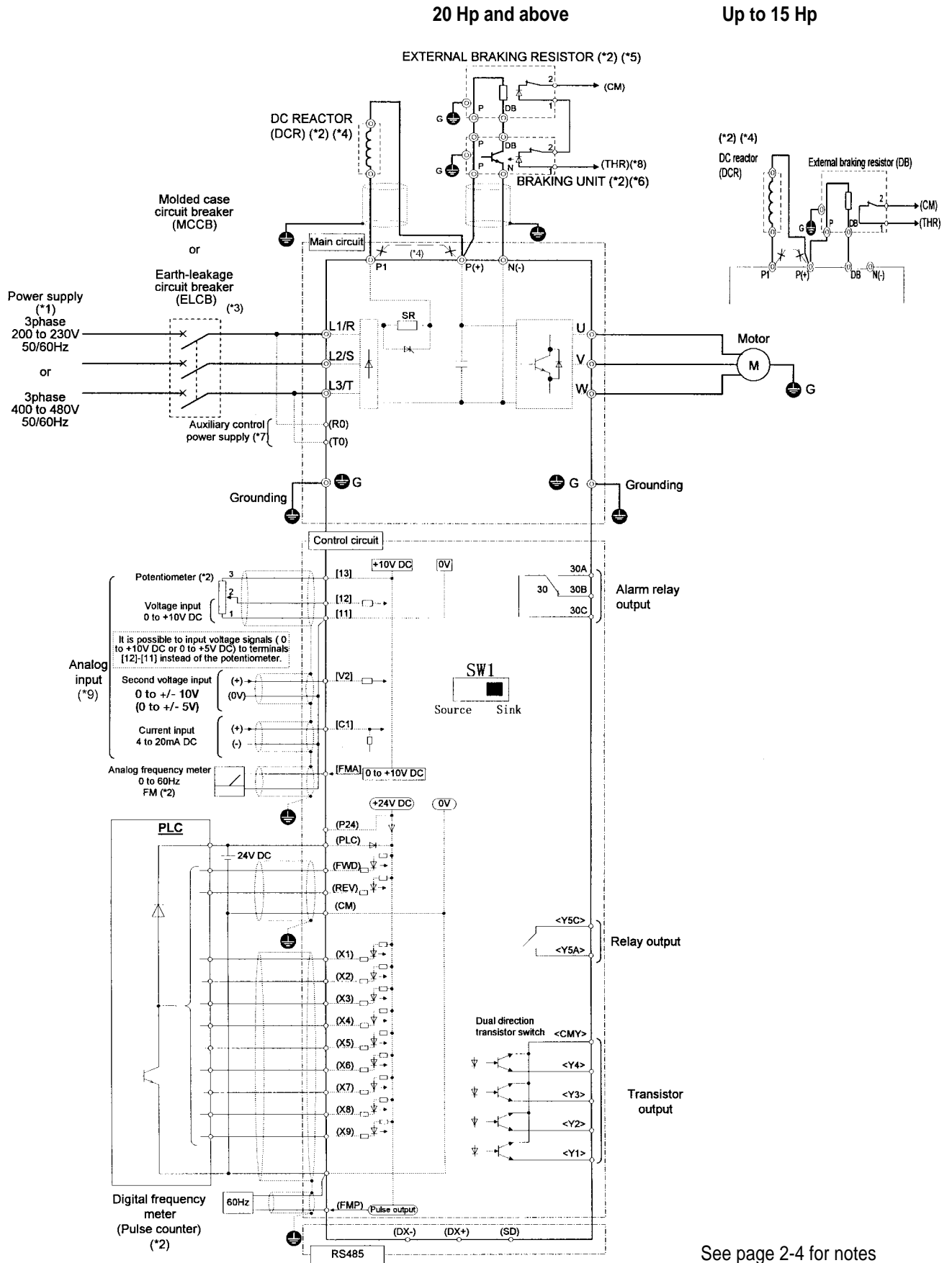

Basic Connection Diagram (Source Logic, Typically used in Europe)

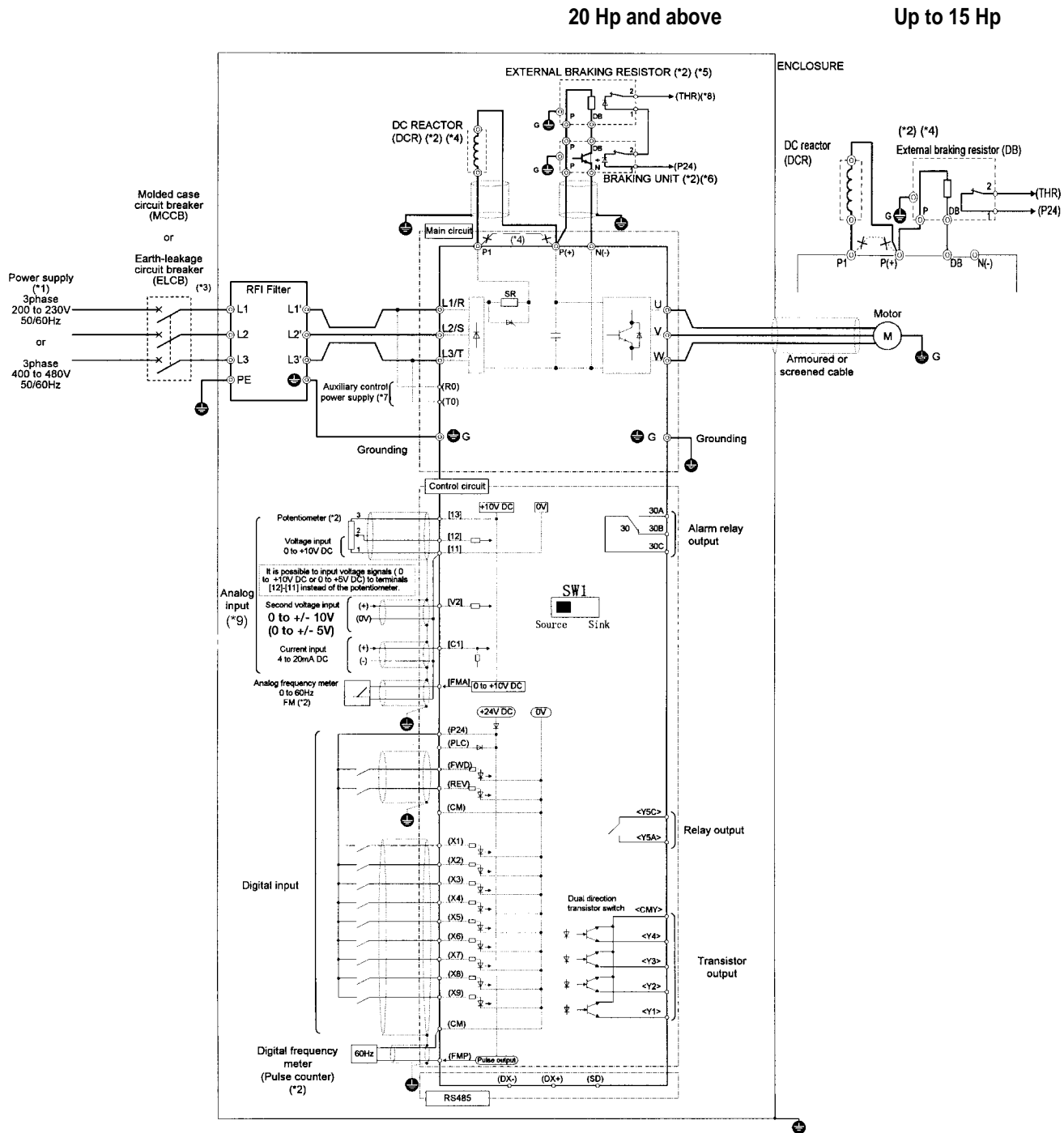

Note: The control circuit common terminals [11], (CM) and <CMY> are isolated

(*1) Use a drive with rated voltage matching the power supply voltage.

(*2) Use as required.

(*3) Use this peripheral device when necessary.

(*4) Remove the jumper wire between P1 and P(+) before connecting a DC REACTOR.

(*5) Be sure to use the braking unit (option) when connecting the external braking resistor (option).

(*6) Connect the braking unit to P(+) and N(-). The auxiliary terminals [1] and [2] have polarity.

Connect them as shown in the figure above.

(*7) The drive can be operated without connecting the auxiliary control power supply.

(*8) Terminal (X1) to (X9) can be set to 9 (THR) - Braking unit thermal trip input.

(*9) If using V2 or C1, as a reference signal, they must be used exclusively.

(*10) It is possible to input voltage signals (0 to +10 VDC or 0 to +5 VDC) to terminals [12] [11] instead of the potentiometer.

Basic Connection Diagram to PLC (Source logic, Typically used in Europe)

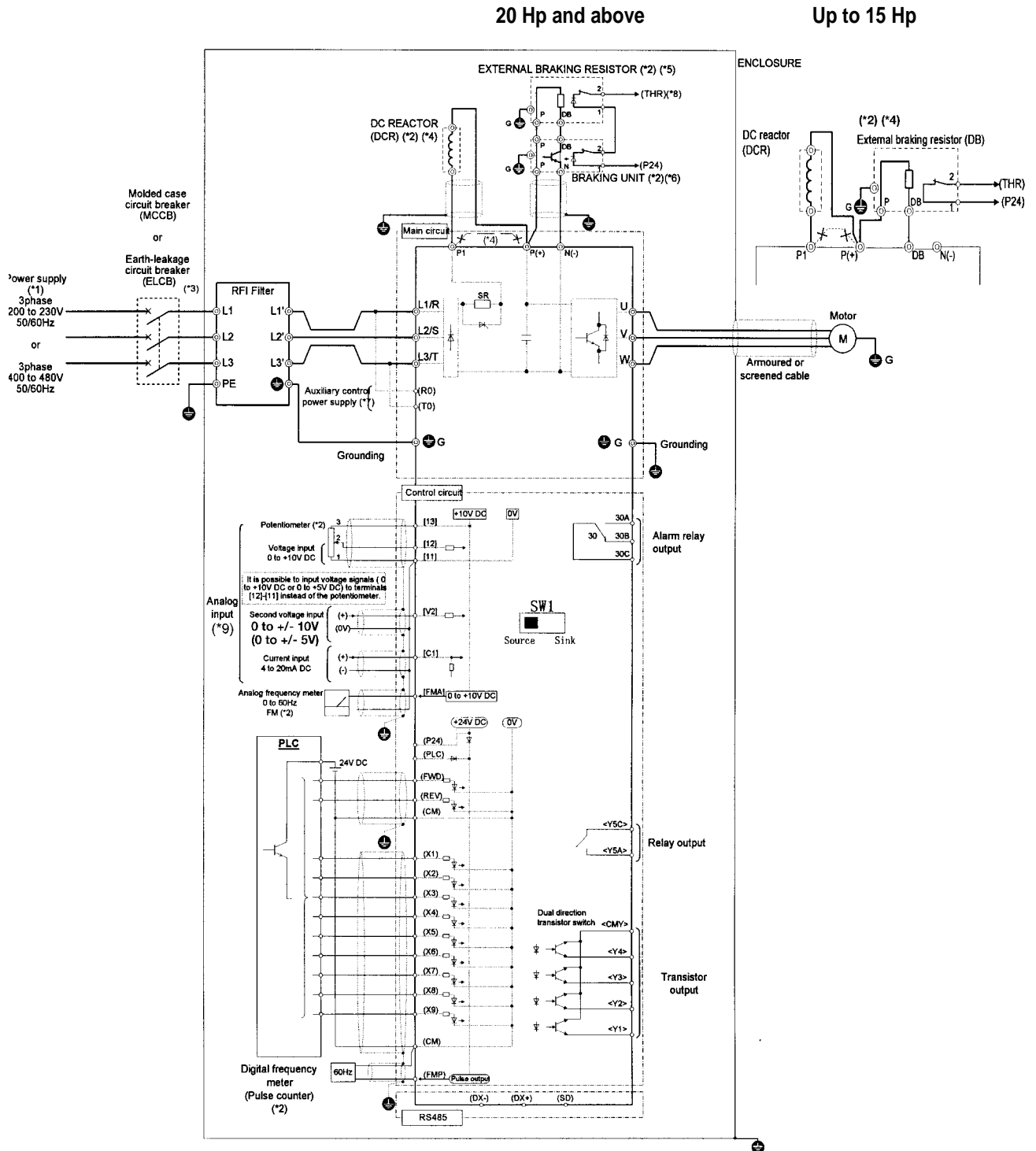

See page 2-6 for notes

2.3.2 Connecting the Main Circuit and Ground Terminals

Table 2.3.1 Functions of main circuit terminals and ground terminals

Symbol	Terminal Name	Description
L1/R,L2/S,L3/T	Main circuit power terminals	Connects a 3-phase power supply
U,V,W	Inverter output terminals	Connects a 3-phase motor
R0,T0	Input terminals for auxiliary control power	Connects a backup AC power supply to the control circuit (not supported for drives of 1 Hp or less)
P1,P(+)	DC reactor terminals	Connects the optional power correcting DC reactor
P(+),DB	Terminals for external braking resistor	Connects the optional external braking resistor (for drives of 15 Hp or less)
P(+),N(-)	Terminals for DC link circuit	Supplies DC link circuit voltage to the external braking unit (option) or power regeneration unit (option).
G	Ground terminal	Connects the drive chassis (case) to ground.

(1) Main circuit power terminals (L1/R, L2/S, L3/T)

1. Connect these terminals to the power supply via a molded-case circuit breaker or ground-leakage circuit breaker for circuit protection. Phase-sequence matching is unnecessary.
2. To insure safety, a magnetic contactor should be used to disconnect the drive from the power supply when the drive protective function activates.
3. Use control circuit terminal FWD/REV or the RUN/STOP key on the keypad panel to start or stop the drive. The main circuit power should be used to start or stop the drive only if absolutely necessary and then should not be used more than once every hour.
4. If you need to connect these terminals to a single-phase power supply, please contact the factory.

(2) Drive output terminals (U, V, W)

1. Connect these terminals to a 3-phase motor in the correct phase sequence. If the direction of motor rotation is incorrect, exchange any two of the U, V, and W phases.
2. Do not connect a power factor correction capacitor or surge absorber to the drive output.
3. If the cable from the drive to the motor is very long, a high-frequency current may be generated by stray capacitance between the cables and result in an overcurrent trip of the drive, an increase in leakage current, or a reduction in current indication precision.

When a motor is driven by a PWM-type drive, the motor terminals may be subject to surge voltage generated by drive element switching. If the motor cable (with 460V series motors, in particular) is particularly long, surge voltage will deteriorate motor insulation. To prevent this, use the following guidelines:

Drives 7.5 HP and larger			
Motor Insulation Level	1000V	1300V	1600V
460 VAC Input Voltage	66 ft (20 m)	328 ft (100 m)	1312 ft (400 m) *
230 VAC Input Voltage	1312 ft (400 m) *	1312 ft (400 m) *	1312 ft (400 m) *

Drives 5 HP and smaller			
Motor Insulation Level	1000V	1300V	1600V
460 VAC Input Voltage	66 ft (20 m)	165 ft (50 m) *	165 ft (50 m) *
230 VAC Input Voltage	328 ft (100 m) *	328 ft (100 m) *	328 ft (100 m) *

* For this case the cable length is determined by secondary effects and not voltage spiking.

Note: When a motor protective thermal O/L relay is inserted between the drive and the motor, the thermal O/L relay may malfunction (particularly in the 460V series), even when the cable length is 165 feet (50m) or less. To correct, insert a filter or reduce the carrier frequency. (Use function code "F26 Motor sound".)

(3) Input terminals for auxiliary control power (R0 and T0)

The drive operates even if power is not provided to these terminals. If a protective circuit operates, and the magnetic contactor on the drive's power is opened (off), the inverter control circuit power, the alarm output (30A, B, and C), and the keypad panel display goes off. To prevent this, the main circuit AC power must also be supplied as auxiliary control power to the auxiliary control power input terminals (R0 and T0).

1. To ensure effective noise reduction when using a radio noise filter, the output power from the filter must go to the auxiliary control power input terminals. If these terminals are connected to the input side of the filter, the noise reduction effect deteriorates.

(4) DC reactor terminals (P1 and P(+))

1. Before connecting a power factor correcting DC reactor (optional) to these terminals, remove the factory-installed jumper.
2. If a DC reactor is not used, do not remove the jumper.

Note: For drives of 100 Hp or more, the DC reactor is provided as a separate standard component and should always be connected to the terminals. DC reactor is provided as open type, enclosure to be provided by other.

CAUTION

A DC reactor does not come with drives rated less than 100 Hp, however, use a DC reactor or AC reactor under the following conditions otherwise the drive may be damaged or malfunction.

- 1) Used when the capacity of the power supply transformer exceeds 500k VA and exceeds the rated capacity of the drive tenfold.
2. Used when a thyristor converter is connected as a common load on the same transformer.
3. Used to prevent a drive OV trip from occurring when the power factor capacitor in the power line is switched on and off.
4. Used when the voltage imbalance exceeds 3%.

$$\text{Imbalance rate between phase [\%]} = \frac{(\text{Max. voltage [V]} - \text{Min. voltage [V]})}{3\text{-phase average voltage [V]}} \times 100\%$$

(5) Terminals for external braking resistor (P(+) and DB) (15 Hp or less)

The GP10 drive 15 Hp or less, does not contain a braking resistor. To improve braking performance, an external braking resistor must be installed.

1. Connect terminals P(+) and DB on the external braking resistor to terminals P(+) and DB on the drive.
2. The wiring length (twisted pair cables, etc.) should not exceed 16.5 feet (5m).

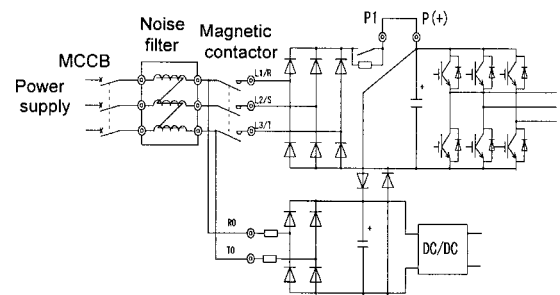

Fig. 2-3-2 Connection the auxiliary control-power input terminals

(6) Terminals for DC link circuit (P(+) and N(-))

The GP10 drive of 20 Hp or more, does not contain a drive circuit for the braking resistor. To improve braking performance, an external braking unit (option) and an external braking resistor (option) must be installed.

1. Connect terminals P(+) and N(-) on the braking unit to terminals P(+) and N(-) on the drive. The wiring length (twisted pair cables, etc.) should not exceed 16.5 feet (5m).
2. Connect terminals P(+) and DB on the braking resistor to terminals P(+) and DB on the braking unit. The wiring length (twisted pair cables, etc.) should not exceed 33 feet (10m). If terminals P(+) and N(-) on the drive are not used, leave the terminals open. If P(+) is connected to N(-), or the braking resistor is connected directly, the resistor will burn up.
3. Auxiliary contacts 1 and 2 of the braking unit have polarity.
4. Refer to DB unit instruction book for paralleled resistors.

Note: Braking units and resistors are rated on degree of braking, duration and system frequency of braking cycle. Verify units meet application requirements.

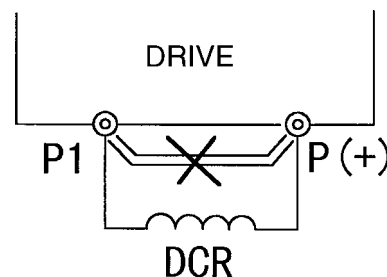

Fig. 2-3-3

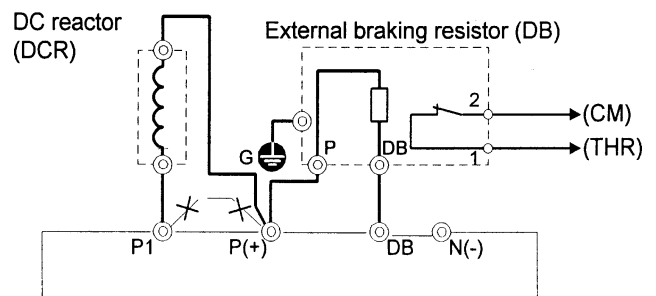

Fig. 2-3-4 Connection (15 Hp or less)

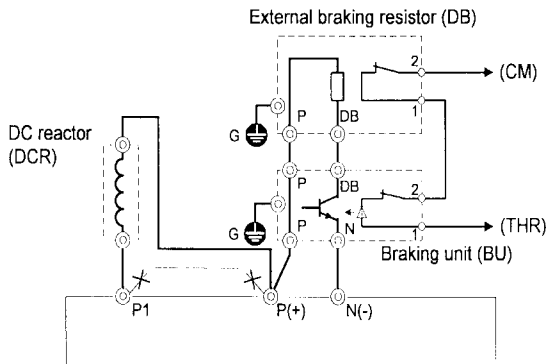

Fig. 2-3-5 Connection 20 Hp or more, 100 Hp or more parallel resistors, 200 Hp or more parallel braking units.

(7) Ground terminal

The grounding connector should be sized in accordance with the NEC or Canadian Electrical Code. The connection should be made by a UL listed or CSA certified closed-loop terminal connector sized for the wire gauge involved. The connector is to be fixed using the crimp tool specified by the connector manufacturer.

(8) Auxiliary power switching connector (CN UX) (for drives of 40 Hp or more)

When a drive of 40 Hp or more requires main circuit power voltage as listed in Table 2-3-3, disconnect the auxiliary power switching connector CN UX from U1 and connect to U2. For the switching method, see Fig. 2-3-7.

Table 2-3-3 Main Voltage Requiring Auxiliary Power Switching Connector

Frequency [Hz]	Power Voltage Range [VAC]
50	380 - 398
60	380 - 430

CAUTION

- Check that the number of phases and rated voltage match those of the AC power supply.
- Do not connect the AC power supply to the output terminals (U, V, W). Injury may result.
- Do not directly connect a braking resistor to the DC terminals (P[+] and N[-]). Fire may result.

The switching connectors are mounted on the power PCB above the control PCB as shown on the right.

Note: To remove a connector, unlock the connector (using the locking mechanism) and pull. To install, firmly push the connector until it clicks into place.

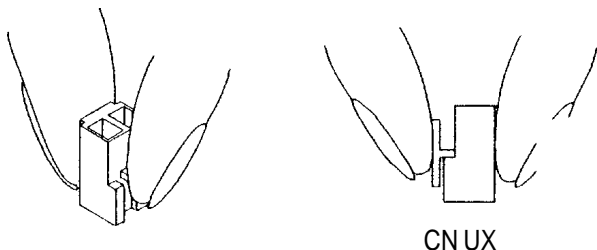

<Enlarged view of part A>

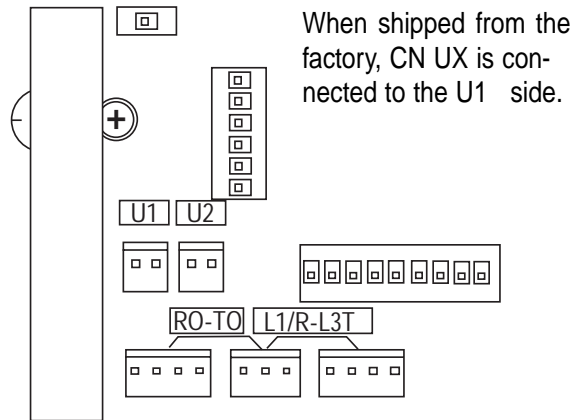

<3D view of part A>

Factory Shipment Status Connector CN UX: U1

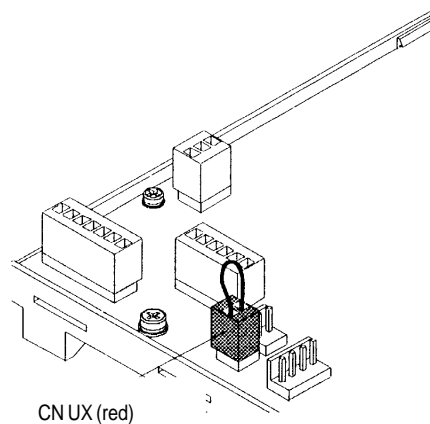
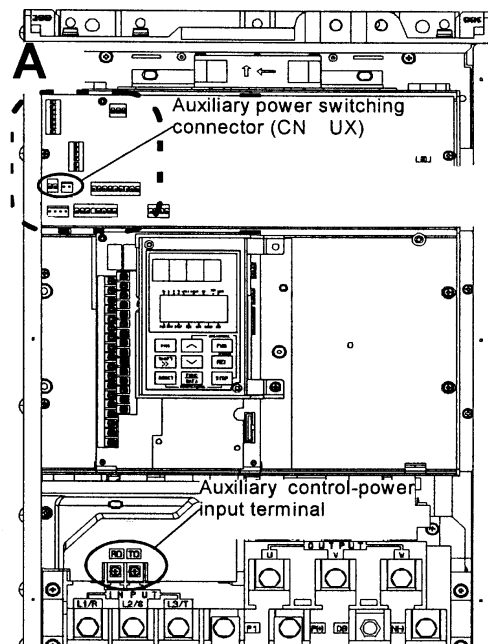

2.3.3 Connecting the Control Terminals

Table 2.3.3 lists the functions of the control circuit terminals. A control circuit terminal should be connected according to its function setting.

Table 2-3-3

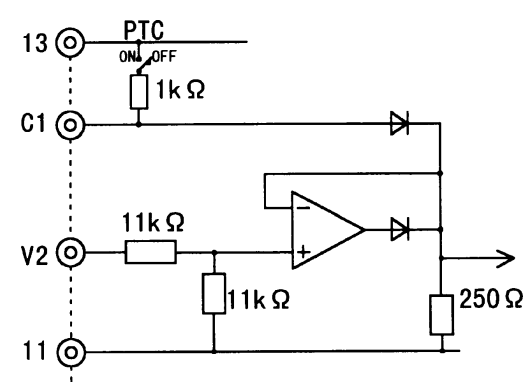
Classification	Terminal Symbol	Terminal Name	Function
Analog input	13	Potentiometer power supply	Used for +10V DC power supply for frequency setting POT (resistance of 1 to 5k Ohms)
	12	Voltage input	<ol style="list-style-type: none"> Frequency is set according to the analog input voltage supplied from an external circuit. <ul style="list-style-type: none"> - 0 to +10V DC / 0 to 100% - Reversible operation using positive and negative signals: 0 to +/- 10V DC / 0 to 100% - Reverse operation: +10 to 0V DC / 0 to 100% Input feedback signal for PID control is input. The analog input value from the external circuit is used for torque control <p>* Input resistance: 22 k Ohms</p>
	V2	Voltage input supplied from an external circuit.	<p>" Frequency is set according to the analog input voltage</p> <ul style="list-style-type: none"> - 0 to +10V DC/0 to 100% - Reverse operation: +10 to 0V DC/0 to 100% <p>* Use only one terminal - V2 or C1 Exclusively</p> <p>* Input resistance: 22 k Ohms</p>
	C1	Current input	<ol style="list-style-type: none"> Frequency is set according to the analog input current supplied from an external circuit. <ul style="list-style-type: none"> - 4 to 20mA DC / 0 to 100% - Reverse operation: 20 to 4mA DC / 0 to 100% The feedback signal for PID control is input. PTC thermistor input  <p>* Use only one terminal - V2 or C1 Exclusively</p> <p>* Input resistance: 250 Ohms</p> <p>* PTC switch is off when PTC function is not used</p>
	11	Analog input common	Common terminal for analog input signals

Transistor	Y1	Transistor output 1	A running signal, frequency equivalence signal, overload early warning output signal, and other signals from the drive are output (as transistor output) to arbitrary ports. For details, see "Setting the Terminal Functions E20 to E23" in Section 5.2 Function Explanation. * <Specifications of transistor output circuit>																								
	Y2	Transistor output 2																									
	Y3	Transistor output 3																									
	Y4	Transistor output 4																									
				<table border="1"> <thead> <tr> <th>Item</th> <th></th> <th>min.</th> <th>typ.</th> <th>max.</th> </tr> </thead> <tbody> <tr> <td rowspan="2">Operating voltage</td> <td>ON</td> <td>–</td> <td>1V</td> <td>2V</td> </tr> <tr> <td>OFF</td> <td>–</td> <td>24V</td> <td>27V</td> </tr> <tr> <td>Maximum load current</td> <td>ON</td> <td>–</td> <td>–</td> <td>50 mA</td> </tr> <tr> <td>Leakage current</td> <td>OFF</td> <td>–</td> <td>–</td> <td>0.1 mA</td> </tr> </tbody> </table>	Item		min.	typ.	max.	Operating voltage	ON	–	1V	2V	OFF	–	24V	27V	Maximum load current	ON	–	–	50 mA	Leakage current	OFF	–	–
Item		min.	typ.	max.																							
Operating voltage	ON	–	1V	2V																							
	OFF	–	24V	27V																							
Maximum load current	ON	–	–	50 mA																							
Leakage current	OFF	–	–	0.1 mA																							
CME	Transistor output common	Common terminal for transistor output signals. This terminal is insulated from terminals (CM) and [11].																									
Relay output	30A,30B,30C	Alarm outputs for any fault.	If the drive is stopped by an alarm (protective function), the alarm signal is output from the relay contact output terminal (1SPDT). Contact rating: 250 VAC, 0.3A,cosØ = 0.3, 48 VDC, 0.5A for CE Marking An excitation mode (excitation at alarm occurrence or at normal operation) can be selected.																								
	Y5A,Y5C	Multi-purpose signal	These signals can be output similar to the Y1 to Y4 signals above. The contact rating is the same as that of the alarm output above.																								
Communication	DX+,DX-	RTU communication	Input / output signal terminals for RTU communication input / output Up to 31 inverters can be connected using the daisy chain method.																								
	SD	Communication cable shield connection terminal	Terminal for connecting the cable shield. The terminal is electrically floating.-																								

(1) Analog input terminals (13, 12, C1, and 11)

1. These terminals receive low level analog signals that may be affected by external noise. The cables must be as short as possible (20 meters or less), must be shielded, and the shields must be grounded. If the cables are affected by external induction noise, the shielding effect may be improved by connecting the shield to terminal [11].
2. If contacts must be connected to these circuits, twin (bifurcated) contacts for handling low level signals must be used. A contact must not be connected to terminal [11].
3. If an external analog signal output device is connected to these terminals, it may malfunction as a result of drive noise. To prevent malfunction, connect a ferrite core or capacitor to the external analog signal output device.

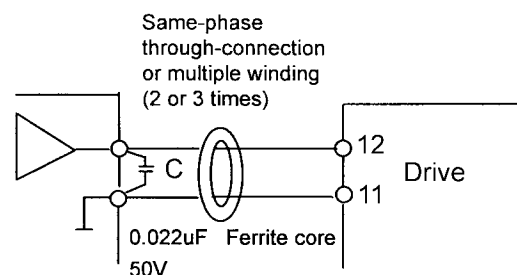
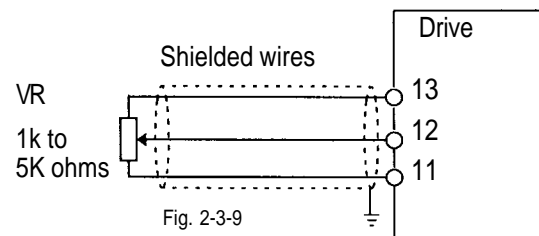

(2) Digital input terminals (FWD, REV, X1 to X9, PLC, and CM)

1. Digital input terminals (e.g., FWD, REV, X1 to X9) are generally turned on or off by connecting or disconnecting the line to or from the CM terminal.

If digital input terminals are turned on or off by switching the PLC's open collector output using an external power supply, a resulting bypass circuit may cause the drive to malfunction. To prevent a malfunction, connect the PLC terminal as shown in Fig. 2-3-11.

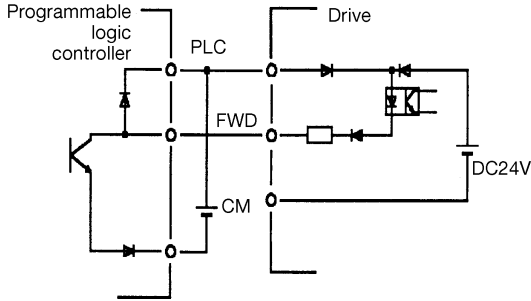

Fig. 2-3-11 Prevention of Bypass Current by External Power

2. When using a contact input, a high-quality relay with reliable contacts must be used.

(3) Transistor output terminals (Y1 to Y4, CME)

1. These terminals have a circuit configuration as shown in Table 2-3-3, "Transistor Output". Confirm the polarity of the external power supply.
2. To connect a control relay, connect a surge absorbing diode to both ends of its exciting coil.

(4) Sink or Source Logic Selection.

1. Set SW1 for Sink or Source Connection to the PLC. The factory default setting is Sink and this instruction manual explains Sink logic function only.
2. When you need to connect source type logic, refer to Basic Connection Diagram Fig. 2-3-3 and Fig. 2-3-4 and Technical Information Manual. (Sink Logic is commonly used in the USA and Source Logic is commonly used in Europe.)

(5) Others

1. To prevent a malfunction as a result of noise, control terminal cables must be placed as far as possible from the main circuit cables.
2. The control cables inside the inverter must be secured to prevent direct contact with the main circuit (e.g., main circuit terminal block).

(6) Wiring of control circuit (inverter of 40 Hp or more)

1. Pull out the control circuit wiring along the left panel as shown in Fig. 2-3-12.
2. Secure the cable to cable binding hole A (on the left wall of the main circuit terminal block) using a cable-tie (e.g., Insulock). The cable-tie must not exceed 0.14" (3.5mm) in width and 0.06" (1.5mm) in thickness.
3. When the optional PC board is mounted, the signal lines must be secured to cable binding hole B.

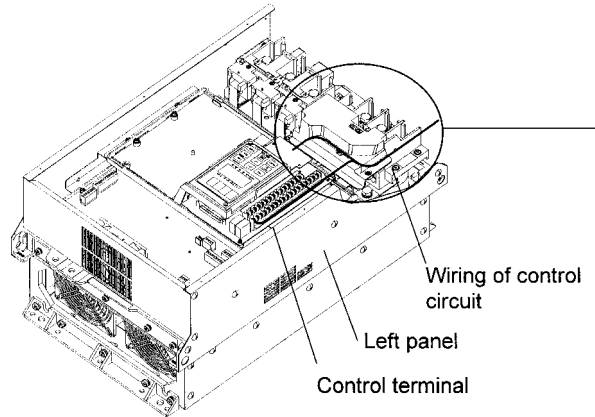

Fig. 2-3-12 The Control Wiring Route

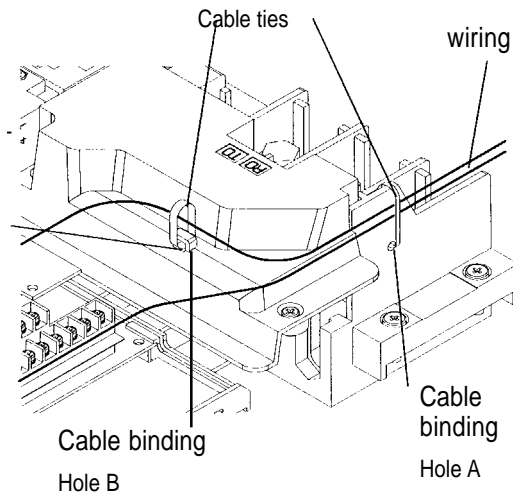

Fig. 2-3-13 Securing Positions for Inverter Control Circuit Wiring (40 HP or more)

WARNING

Control lines generally do not have enhanced insulation. If the insulation of a control line is damaged, the control signals may be exposed to high voltage in the main circuit. The Low Voltage Directive in Europe also restricts the exposure to high voltage. Electric shock may result

CAUTION

The inverter, motor, and cables generate noise. Check that the ambient sensors and devices do not malfunction. Accident may result.

2.3.4 Terminal Configuration

(1) Main circuit terminals

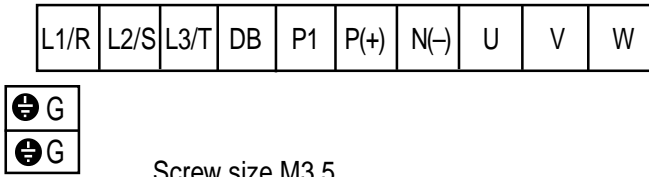
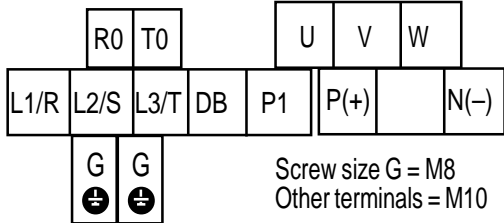
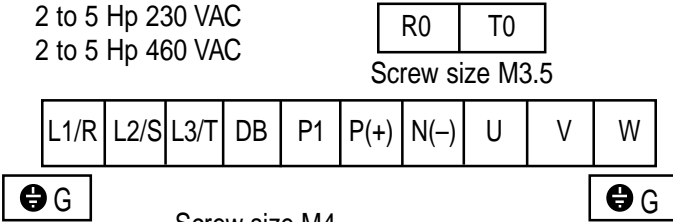
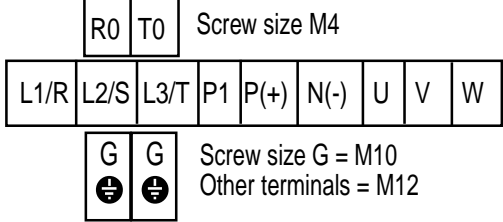
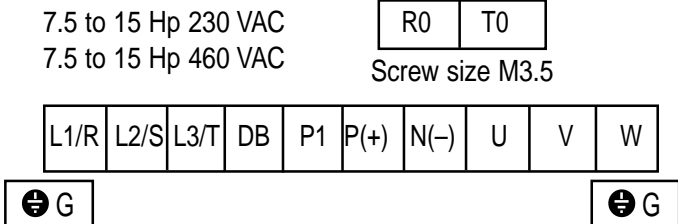
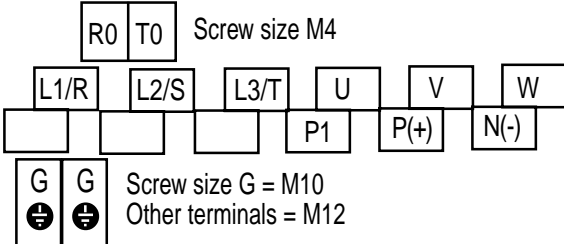
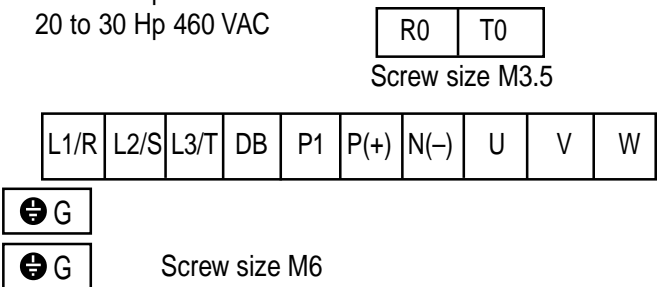
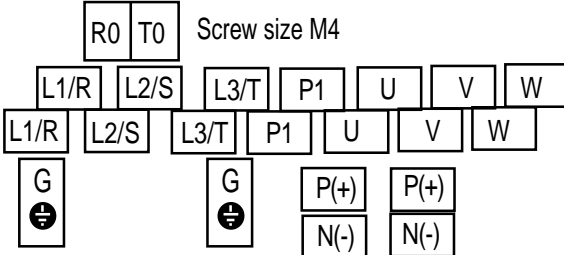
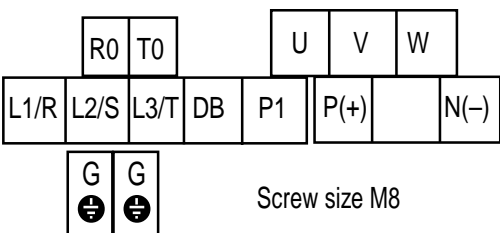
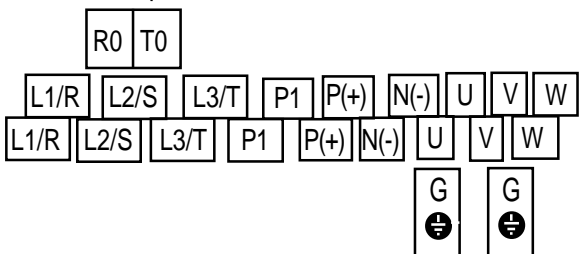
<p>1/4 to 1 Hp 230 VAC 1/2 to 1 Hp 460 VAC</p>  <p>Screw size M3.5</p>	<p>60 To 100 Hp 230 VAC 125 to 200 Hp 460 VAC</p>  <p>Screw size G = M8 Other terminals = M10</p>
<p>2 to 5 Hp 230 VAC 2 to 5 Hp 460 VAC</p>  <p>Screw size M4</p>	<p>125 Hp 230 VAC</p>  <p>Screw size G = M10 Other terminals = M12</p>
<p>7.5 to 15 Hp 230 VAC 7.5 to 15 Hp 460 VAC</p>  <p>Screw size M5</p>	<p>150 Hp 230 VAC 250 to 450 Hp 460 VAC</p>  <p>Screw size G = M10 Other terminals = M12</p>
<p>20 to 30 Hp 230 VAC 20 to 30 Hp 460 VAC</p>  <p>Screw size M6</p>	<p>500, 600 Hp 460 VAC</p>  <p>Screw size G = M10 Other terminals = M12</p>
<p>40 to 50 Hp 230 VAC 40 to 100 Hp 460 VAC Screw size M4</p>  <p>Screw size M8</p>	<p>700, 800 Hp 460 VAC</p>  <p>Screw size RO, TO = M4 G = M10 Other terminals = M12</p>

(2) Control circuit terminals

30A	Y5A	CMY	Y3	Y1	C1	FMA	FMP	PLC	X1	X2	X3	X4	X5	X6	X7	X8	X9
30C	30B	Y5C	Y4	Y2	11	12	13	V2	CM	CM	FWD	REV	P24	P24	DX-	DX+	SD

2.3.5 GP10 Drive Cable Size, Tightening Torque and Circuit Protection Rating

2-3-5 GP10-Variable Torque, Constant Torque Drive Cable Size, Tightening Torque and Circuit Protection Rating

HP	Incoming Device				Tightening Torque lb-Inch (Nm)						Cable size AWG					
	Input Fuse		Auxiliary Input R0, T0	Input Circuit Breaker (*1)	L1/R, L2/S, L3/T, U, V, W, P1, P(+)	E(G)	DB circuit (*2) P(+), N(-), DB	R0, T0	Control	L1/R, L2/S, L3/T	U, V, W	DC Reactor P1, P(+)	DB circuit (*2) P(+), N(-), DB	R0, T0		
	L1/R, L2/S, L3/T (Nominal)	L1/R, L2/S, L3/T (Maximum) (*1)														
230VAC Input																
0.25/0.25	3	3	3	15	10.6 (1.2)	10.6 (1.2)	-	6.2 (0.7)	16	16	-	-	-	-		
0.5/0.5	5	6	3	15												
1/1	10	15	3	20	20.8 (2.36)	20.8 (2.36)	10.6 (1.2)	-	14	14	-	-	-	14		
2/2	15	20	3	30												
3/3	20	30	3	40	31.0 (3.5)	31.0 (3.5)	-	-	10	10	-	-	-	10		
5/5	35	50	3	60												
7.5/5	60	80	3	100	51.3 (5.8)	51.3 (5.8)	-	-	8	8	-	-	-	8		
10/9.5	70	125	3	125												
15/10	100	150	3	175	119(13.5)	119 (13.5)	-	-	6	6	-	-	-	10		
20/15	125	200	3	225												
25/20	150	225	3	250	239(27)	239(27)	-	-	4	4	-	-	-	10		
30/25	175	250	3	300												
40/30	200	-	5	200	425(48)	425(48)	-	-	2	2	-	-	-	10		
50/40	225	-	5	225												
60/50	300	-	5	300	119(13.5)	119 (13.5)	-	-	1	1	-	-	-	10		
75/60	350	-	5	350												
100/75	300	-	5	300	239(27)	239(27)	-	-	Qty2 - 1	3/0	4/0	4/0	8	10		
125/100	400	-	5	400												
150/125	450	-	5	450	425(48)	425(48)	-	-	Qty2 - 2/0	4/0	Qty2 - 1	8	6	4		

460VAC Input

0.5/0.5	3	3	3	15	10.6 (1.2)	10.6 (1.2)	-	6.2 (0.7)	16	16	-	-	-	-
1/1	5	6	3	15										
2/2	10	10	3	15	20.8 (2.36)	20.8 (2.36)	10.6 (1.2)	-	14	14	-	-	-	14
3/3	15	15	3	20										
5/5	20	25	3	35	31.0 (3.5)	31.0 (3.5)	-	-	10	10	-	-	-	10
7.5/5	30	45	3	50										
10/7.5	40	60	3	70	51.3 (5.8)	51.3 (5.8)	-	-	8	8	-	-	-	8
15/10	50	90	3	90										
20/15	70	110	3	110	119(13.5)	119 (13.5)	-	-	6	6	-	-	-	10
25/20	80	125	3	150										
30/25	100	125	3	175	239(27)	239(27)	-	-	4	4	-	-	-	10
40/30	100	-	10	100										
50/40	125	-	10	125	425(48)	425(48)	-	-	2	2	-	-	-	10
60/50	175	-	10	175										
75/60	150	-	10	150	119(13.5)	119 (13.5)	-	-	1	1	-	-	-	10
100/75	175	-	10	175										
125/100	200	-	10	200	239(27)	239(27)	-	-	3/0	4/0	4/0	8	6	4
150/125	225	-	10	225										
200/150	300	-	10	300	425(48)	425(48)	-	-	Qty2 - 1/0	Qty2 - 1/0	Qty2 - 1/0	8	6	4
250/200	400	-	10	400										
300/250	450	-	10	450	119(13.5)	119 (13.5)	-	-	Qty2 - 3/0	Qty2 - 3/0	Qty2 - 4/0	6	4	10
350/300	500	-	10	500										
400/350	600	-	10	600	239(27)	239(27)	-	-	Qty2 - 250	Qty2 - 300	Qty2 - 350	4	4	10
450/350	700	-	10	700										
500/400	700	-	10	700	425(48)	425(48)	-	-	Qty2 - 350	Qty2 - 400	Qty2 - 500	4	4	10
600/450	1000	-	10	1000										
700/500	1000	-	10	1000	119(13.5)	119 (13.5)	-	-	Qty2 - 500	Qty2 - 500	Qty2 - 700	4	4	10
800/600	1200	-	10	1200										

(*1) Class J Fuse or Circuit Breaker rated 600V with the maximum current rating as shown in the above table shall be connected to the drive for 30HP and less.

(*2) Based on GE Fuji standard DB unit and DB resistor designs. Other rating require careful review.

(*3) Consult factory

Device ratings such as system coordination, short-circuit rating and type must be carefully reviewed by the user.

Wire size from NEC tables 310-16. Copper wire rated 60 Deg. C for 100amps or less, 75 Deg. C for over 100 amps in 30 Deg. C ambient and 1.25 times Drive rated amps.

2.3.6 DC Link Reactor

Dimensions in inches

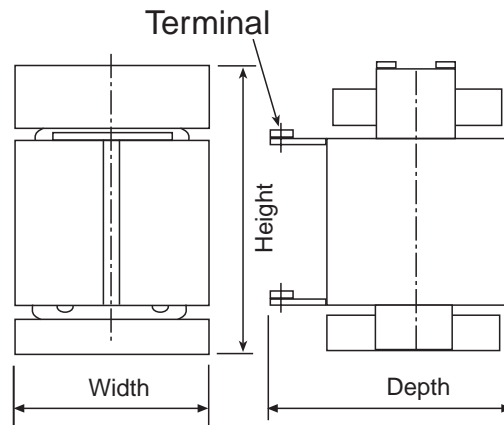

Hp	Model No.	Width	Depth	Height	Weight	Loss [W]
230V GP10-Variable Torque/Constant Torque						
100/75	DCR2-75B	7.87	10.63	7.09	37	55
125/100	DCR2-90B	7.09	11.02	8.46	37	57
150/125	DCR2-110B	7.48	12.99	9.05	46	67
460V GP10-Variable Torque/Constant Torque						
100/75	DCR4-75B	7.48	10.63	6.89	35	58
125/100	DCR4-90B	7.48	11.02	7.87	44	64
150/125	DCR4-110B	7.48	11.02	7.87	46	73
200/150	DCR4-132B	7.87	11.02	8.07	55	84
250/200	DCR4-160B	8.27	12.6	8.07	68	90
300/250	DCR4-200B	8.27	12.99	9.06	75	126
350/300	DCR4-220B	8.66	13.78	9.06	81	131
400/350	DCR4-280B	8.66	14.57	9.65	95	133
450/350	DCR4-280B	8.66	14.57	9.65	95	150
500/400	DCR4-355B	9.84	12.99	8.78	99	205
600/450	DCR4-400B	9.84	13.78	9.17	106	215
700/500	DCR4-450B	10.63	13.78	10.35	121	272
800/600	DCR4-500B	11.1	14.17	10.35	143	292

Note:

- GP10 Drives rated 100 Hp and above are furnished with a DC link reactor. This reactor must be installed between terminal P1 and P+ prior to commissioning of the Drive.
- The weight of the DC Link Reactor is not included with that of the Drive.
- DC Link Reactor is provided as open type and is separately mounted. Enclosure to be provided by others.

3. Operation

3.1 Inspection and Preparation Before Operation

Check the following before operation:

1. Check that the connections are correct.
In particular, check that the power supply is not connected to any of the U, V, or W output terminals and that the ground terminal is securely grounded.
2. Check for short circuits and ground faults between the terminals and sections under power.
3. Check for loose terminals, connectors, or screws.
4. Check that the motor is disconnected from the mechanical equipment.
5. Turn off switches before turning on power to ensure that the drive will not start or operate abnormally at power-on.
6. Check the following after power-on:
 - a. No alarm message is displayed on the keypad panel (see Figure 3-1-2).
 - b. The fan inside the drive is rotating. (For drives with 2Hp or more.)

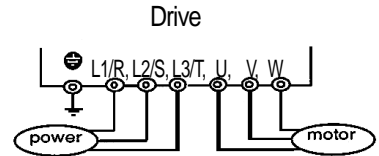

Fig. 3-1-1 Drive connection

3.2 Operation Method

There are various methods of operation. Select a method of operation

WARNING

Be sure to have the drive cover in place before turning on the power (closed). Never remove the cover while power is applied to the drive. To ensure safety, do not operate switches with wet hands. Electric shock may result.



Fig. 3-1-2 Display on keypad panel at power-on

according to the operating requirements and specifications; refer to Section 4-2 Operating the Keypad Panel, and Chapter 5 Function Selection. Table 3-2-1 lists general methods of operation.

3.3 Trial Run

Once inspection is completed (see Section 3-1), proceed with a trial run. The motor is initially disconnected and the drive is operated (factory setting) using the keypad panel.

1. Turn power on and confirm that the LED monitor display 0.00 Hz is blinking.
2. Set the frequency to about 5 Hz using **▲** key.
3. To start the run, press **FWD** key (for forward rotation) or **REV** key (for reverse rotation). To stop, press **STOP** key. Verify frequency increases from zero to the set point.

Connect motor and repeat steps 1-3

4. Check the following items:
 - a. Is the direction of rotation correct?
 - b. Is the rotation smooth (no buzzing or abnormal vibration)?
 - c. Are acceleration and deceleration smooth?
5. If no abnormality is detected, increase the frequency and check the above items again. If the results of the trial run are normal, start a formal run.

Operation Command	Frequency Setting	Operation Command
Operation using keypad panel	Keys on keypad panel ▲ ▼	FWD REV STOP
Operation using external terminal signals	▲ ▼ Frequency Setting POT(VR), analog voltage, analog current	Input from Terminals FWD-CM and REV-CM

Notes: If an error is detected in the drive or motor's operation, immediately stop and attempt to determine the cause of error by referring to Chapter 7 Troubleshooting.

Since voltage is still present at the main circuit terminals (L1/R, L2/S, L3/T) and auxiliary control power terminals (R0, T0), even when the output from the drive is terminated, do not touch the terminals. The smoothing capacitor in the drive is charged after the power is turned off and it is not discharged immediately. Before touching an electric circuit, confirm that the charge lamp is off or use a multimeter to check that the voltage has decreased below 25 VDC for low voltage at the DC (P-N) terminals.

4. Keypad Panel

The keypad panel has various functions for specifying operations such as frequency setting, run/stop command, confirming and changing function data, confirming status, and copying function code settings.

Review the use of each function before attempting to operate the drive from the keypad panel.

The keypad panel can also be removed or inserted during inverter operation. However, if the keypad panel is removed during keypad panel operation (e.g., run/stop, frequency setting), the drive stops and outputs an alarm.

4.1 Appearance of Keypad Panel



Control keys (valid during keypad panel operation):

Used for drive run and stop

FWD Forward operation command

REV Reverse operation

STOP Stop command

Operation keys:

Used for switching screens, data change, frequency setting, etc.

Operation Keys

Primary Function

PRG	Used to switch the current screen to the menu screen or switch to the initial screen in operation / trip mode.
FUNC DATA	Used to switch the LED monitor or to determine the entered frequency, function code, or data
▲ ▼	Used to change data, move the cursor up or down, or scroll the screen
SHIFT >>	Used to move the cursor horizontally at data change. When this key is pressed with the up or down key, the cursor moves to the next function block.
RESET	Used to cancel current input data and switch the displayed screen. If an alarm occurs, this key is used to reset the trip status (valid only when the initial alarm mode screen is displayed)
STOP + ▲	Used to switch normal operation mode to jogging operation mode or vice versa. The selected mode is displayed on the LCD monitor.
STOP + RESET	Switches operation mode (from keypad panel operation mode to terminal block operation mode or reverse). When these keys are operated, function F01 data is also switched from 0 to 3 or from 1-4 to 0. The selected mode is displayed on the LCD indicator.

LED monitor

4-digit display. Used to display data such as setting frequency, output frequency and alarm code.

Auxiliary Information Related to LED Monitor

Indicates selected units or multiple of the data shown on the LED monitor and is displayed on the top line of the LCD monitor. The **■** symbol indicates selected units or multiple number. The symbol **▲** indicates that there is an upper screen not currently displayed.

LCD Monitor:

Used to display various items of information such as operation status and function data. An operating guide message, is scrolled and displayed at the bottom of the LCD monitor. This LCD monitor has a backlight feature which turns on when the control power is applied or any keypad key is pressed, and stays on approximately 5 minutes after the last key stroke.

Status Indicators on LCD Monitor:

Displays current operating status:

FWD: Forward operation REV: Reverse operation

STOP: Stop

Displays the selected operating mode:

REM: terminal block

LOC: keypad panel

COMM: communication terminal

JOG: jogging mode

The symbol **▼** indicates that there is a lower screen not currently displayed.

RUN LED (valid during operation from keypad panel):

Indicates that an operation command was input by pressing the FWD or REV key.

4.2 Operation From the Keypad Panel (LCD Screen, Level Structure)

4.2.1 Normal Operation

The keypad panel operating system (screen transition, level structure) is structured as follows:

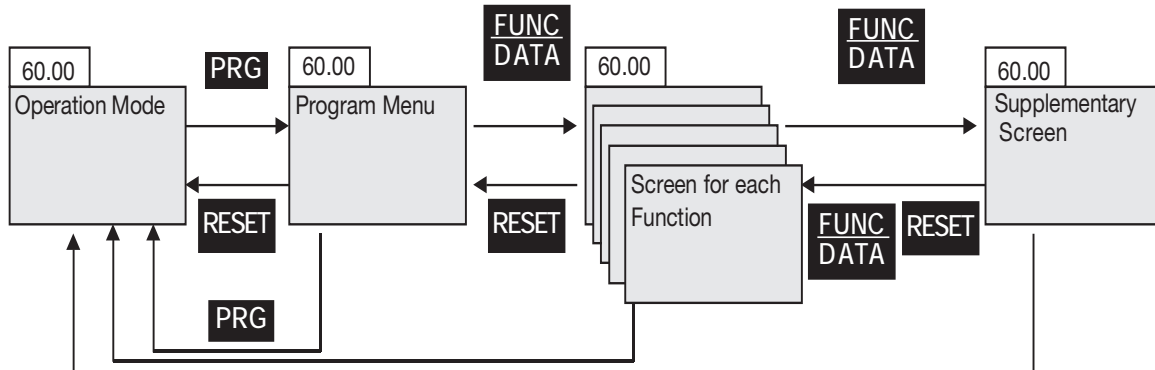

4.2.2 Alarm Modes

If an alarm is activated, operation is changed from normal keypad panel operation to an alarm mode operation. The alarm mode screen appears and alarm information is displayed.

The program menu, function screens, and supplementary screens remain unchanged as during normal operation, though the switching method from program menu to alarm mode is limited to PRG.

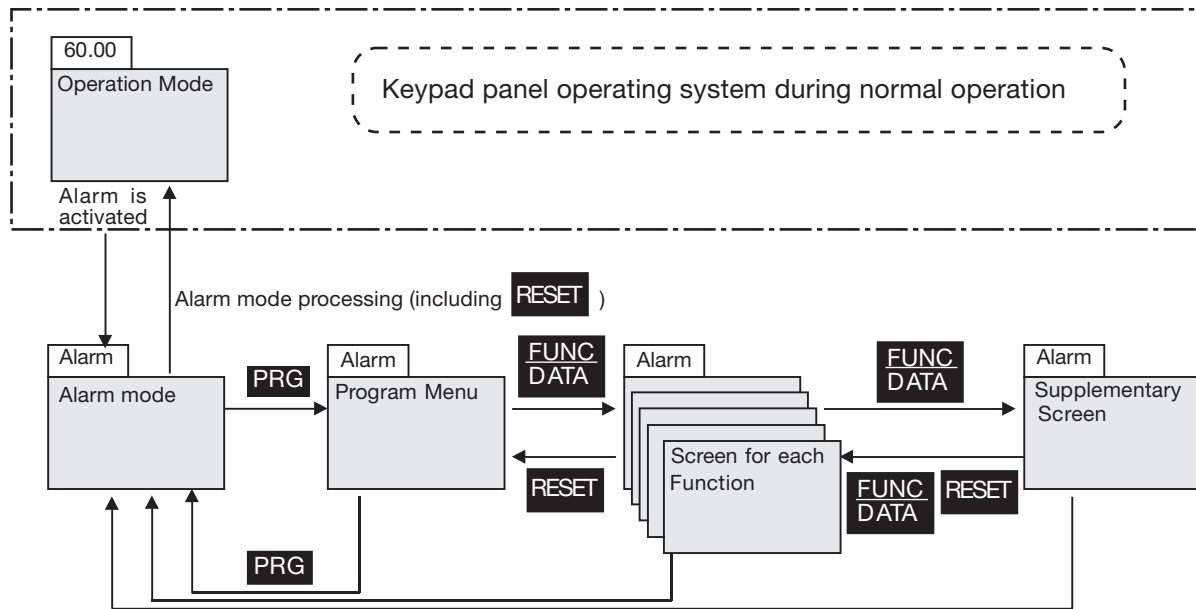



Table 4.2.1 Overview of Contents Displayed for each Level

No.	Level name	Content		
1	Operation Mode	This screen is for normal operation. Frequency setting from the keypad panel and LED monitor switching are possible only when this screen is displayed.		
2	Program Menu	Each function of the keypad panel is displayed in menu form and can be selected. By selecting the desired function from the list and pressing  the corresponding function screen is displayed. The following functions are available as keypad panel functions (menus).		
		No.	Menu Name	Purpose
		1	DATA SET	The code and name of the function are displayed. Selecting a function displays a data setting screen for checking or modifying data.
		2	DATA CHECK	The code and name of the function are displayed. Select a function to display a screen for checking data. Modifying data is possible as described above by going to the data setting screen.
		3	OPR	Can check various data on the operating status.
		4	I/O CHECK	Can check the status of analog and digital input/outputs for the inverter and options as an I/O checker.
		5	MAINTENANCE	Can check inverter status, life expectancy, communication error status, and ROM version information as maintenance information.
		6	LOAD FCTR	Can measure maximum and average current and average breaking force in load rate measurement.
		7	ALM INF	Can check the operating status and input/output status at the latest alarm occurrence.
		8	ALM CAUSE	Can check the latest alarm or simultaneously occurring alarms and alarm history. Selecting the alarm and pressing  displays alarm contents for troubleshooting.
9	DATA COPY	Places the function of one inverter in memory for copying to another drive.		
3	Screen for each Function	The function screen selected on the program menu appears, hence completing the function.		
4	Supplementary individual	Functions not completed (e.g., modifying function data, displaying alarm factors) onScreen function screens are displayed on the supplementary screen.		

4.3 Entering Data on the Keypad Panel

4.3.1 Operation Mode

The screen for normal inverter operation includes a screen for displaying drive operating status and a screen for graphically displaying the status in the form of a bar graph. The operator can switch between both screens by using the function (E45).

1) Operating Status (E45=0)

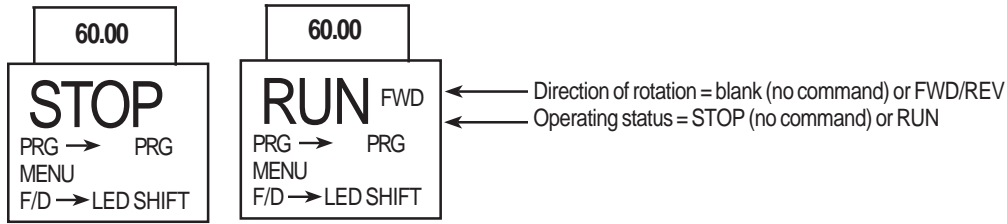

2) Bar Graph (E45=1)

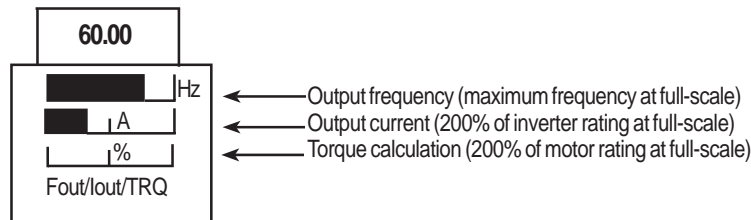

4.3.2 Setting Digital Frequency

On the operation mode screen, press **▲** or **▼** to display the set frequency on the LED. Data is increased or decreased in the smallest possible unit, depending on which key is pressed. The adjustments in data will occur rapidly if the operator holds down **▲** or **▼**. To select a digit use **SHIFT** and then data can be set directly. To save the frequency settings press **FUNC DATA**.

Press **RESET** and **PRG** to return to the operation mode. If keypad panel settings are not selected, the present frequency setting mode appears on the LCD. When selecting the PID function, the PID command can be set with a process value (refer to technical documentation for details).

1) Digital (keypad panel) settings (F01=0 or C30=0)

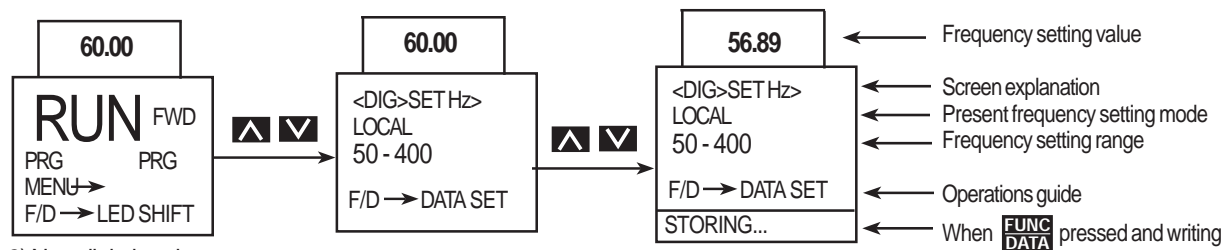

2) Non-digital setting

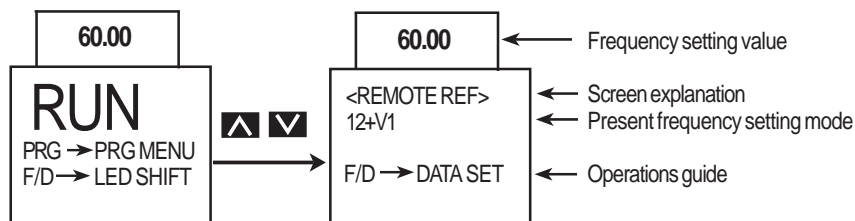

4.3.3 Switching to LED Digital Monitor

During normal operation, press **FUNC DATA** to switch to LED monitor display. When monitored data is switched, the LED monitor contents are displayed. When power is turned on, the monitor contents set by the function (E43) are displayed on the LED.

E43	When stopping		When running (E44 = 0.1)	Unit	Remarks
	(E44 = 0)	(E44 = 1)			
0	Setting frequency	Output frequency 1 (before slip compensation)		Hz	
1	Setting frequency	Output frequency 2 (after slip compensation)			
2	Setting frequency	Setting frequency			
3	Output current	Output current		A	
4	Output voltage (specified value)	Output voltage (specified value)		V	
5	Synchronous speed setting value	Synchronous speed		r/min.	For 4 digits or more, the last digits are cut, with x10, x100 marked on the indicator.
6	Line speed setting value	Line speed		m/min.	
7	Load rotation speed setting value	Load rotation speed		r/min.	
8	Torque calculation value	Torque calculation value		%	± indication
9	Power consumption	Power consumption		kW	
10	PID setting value	PID setting value		—	
11	PID remote setting value	PID remote setting value		—	Displayed only when PID is effective in PID operation selection.
12	PID feedback value	PID feedback value		—	

4.3.4 Program Menu Screen

The Program Menu screen is shown below. Only four items can be displayed simultaneously. Move the cursor with **▲** or **▼** to select an item, then press **FUNC DATA** to display the next screen.

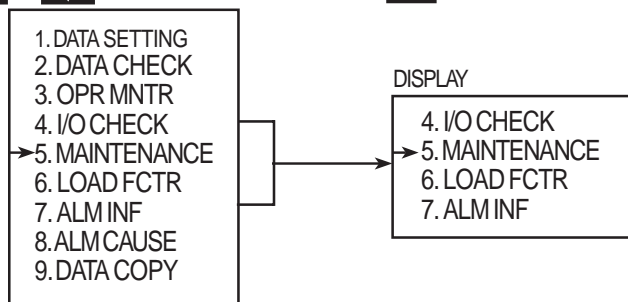

4.3.5 Setting Function Data

On the Program Menu screen, select **1. Data Setting**. The Function Select screen appears with function codes and names on it. Select the desired function.

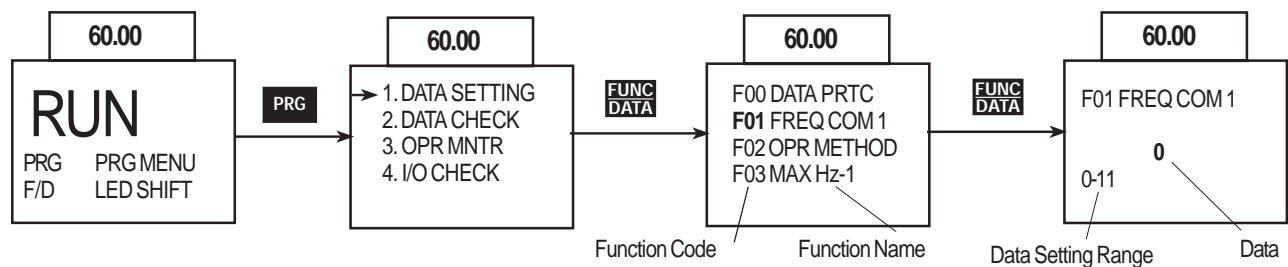

The function code consists of alphanumeric characters with unique letters assigned to each function group.

Table 4-3-1

Function Code	Function	Remarks
F00 - F42	Fundamental functions	
E01 - E47	Terminal Extension Functions	
C01 - C33	Frequency Control Functions	
P01 - P09	Motor Parameters	
H03 - H39	High Performance Functions	
A01 - A18	Alternative Motor Parameters	
o01 - o29	Optional Functions	Can only be selected with an option connected

To scroll the Function Select screen rapidly, use **>>** + **▲** or **>>** + **▼** to move the screen as a unit sorted alphabetically.



Select the desired function and press **FUNC DATA** to switch to the Data Setting screen.

On the Data Setting screen, the data values on the LCD can be increased or decreased in the smallest possible unit by pressing **▲** or **▼**. Holding down **▲** or **▼** causes the values to increase or decrease more rapidly. Otherwise, select the digit to be modified using **>>** and then set data directly. When data is modified, the value before modification will be displayed at the same time for reference purpose. To save the data, press **FUNC DATA**. Pressing cancels the changes made and returns control to the Function Select screen. The modified data will be effective in inverter operation after the data has been saved by **FUNC DATA**. If the data is not saved, there is no change to the inverter operation.

When data setting is disabled in the case of “Data protected” or “Data setting invalid during inverter running,” make the necessary changes as indicated in Table 4-3-2 below.

Table 4.3.2

Display	Reason for No Modification	Release Method
LINK ACTIVE	Currently writing from RS-485 / RTU option to function is being made	Send a cancel command to function writing from RS-485 RTU. Stops a “write” operation from the link
NO SIGNAL(WE)	The edit enabling command function is selected using a general-purpose input terminal	For functions E01 to E09, turn data terminal 19 (edit enabling command selection) ON
DATA PRTCTD	Data protection is selected for function F00.	Change function F00 to 0
INV RUNNING	An attempt was made to change a function that cannot be changed during inverter operation.	Stop inverter operation
FWD/REV ON	An attempt was made to change a function that cannot be changed with the FWD/REV command on.	Turn FWD/REV command off

4.3.6 Checking Function Data

Select 2. DATA CHECK on the Program Menu screen. The Function Select screen then appears with function codes and names.

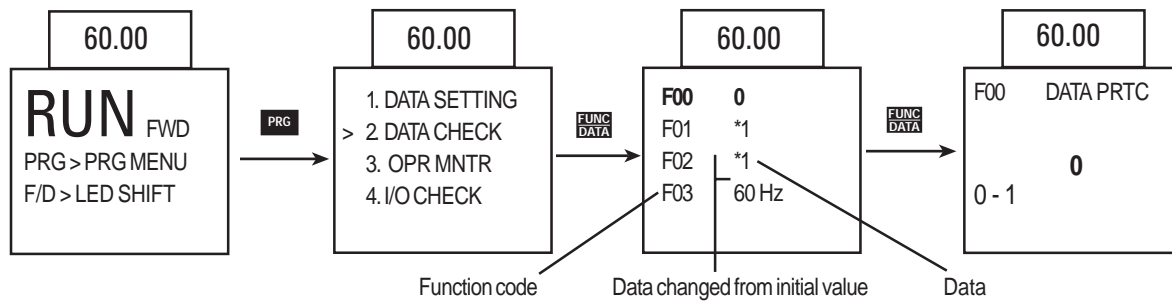

Select the desired function and press FUNC/DATA to check the function data. By pressing FUNC/DATA, the screen switches to the Data Setting screen, where data can be modified.

4.3.7 Monitoring Operating Status

Select 3. OPR MNTR on the Program Menu screen to display the current inverter operating status. Use and to switch between the four operation monitor screens.

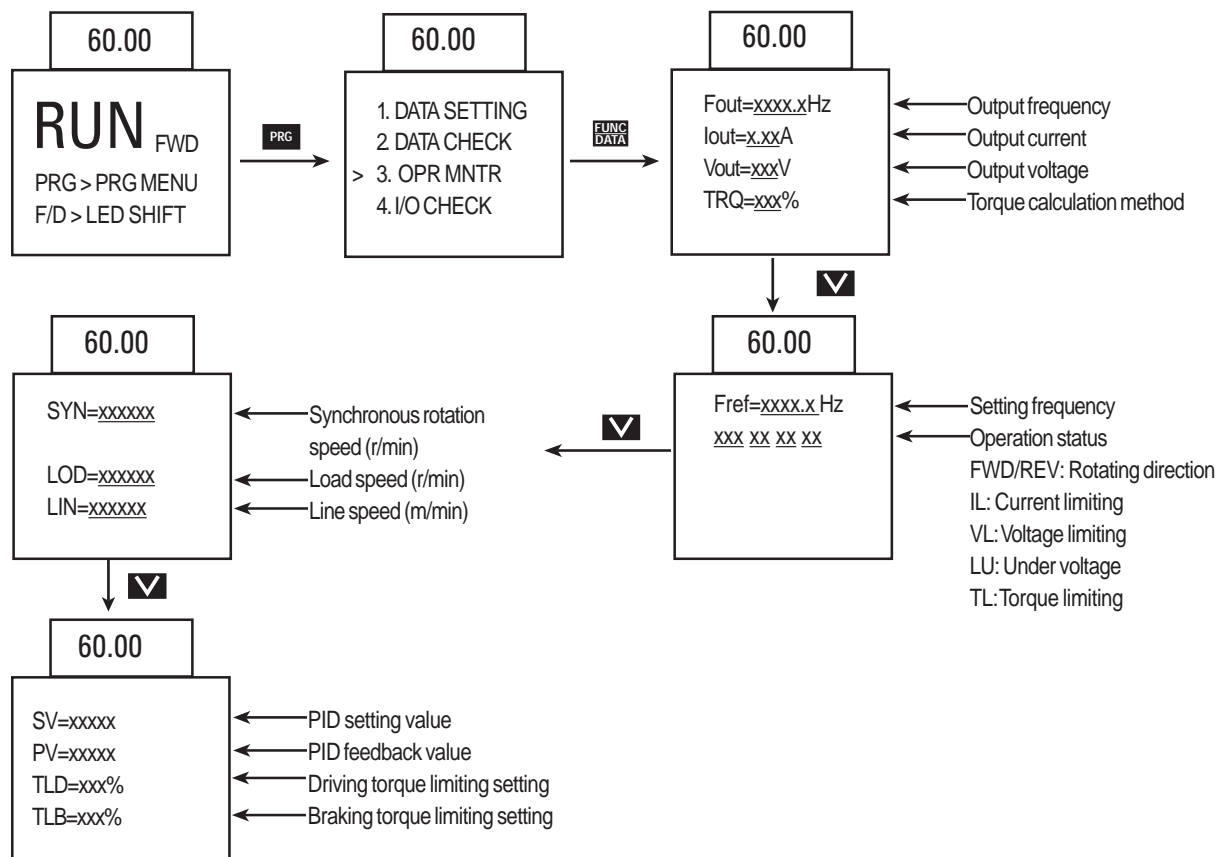

4.3.8 I/O Check



Select 4. I/O on the Program Menu screen. Check to display analog and digital input/output signal status for the drive and options. Use

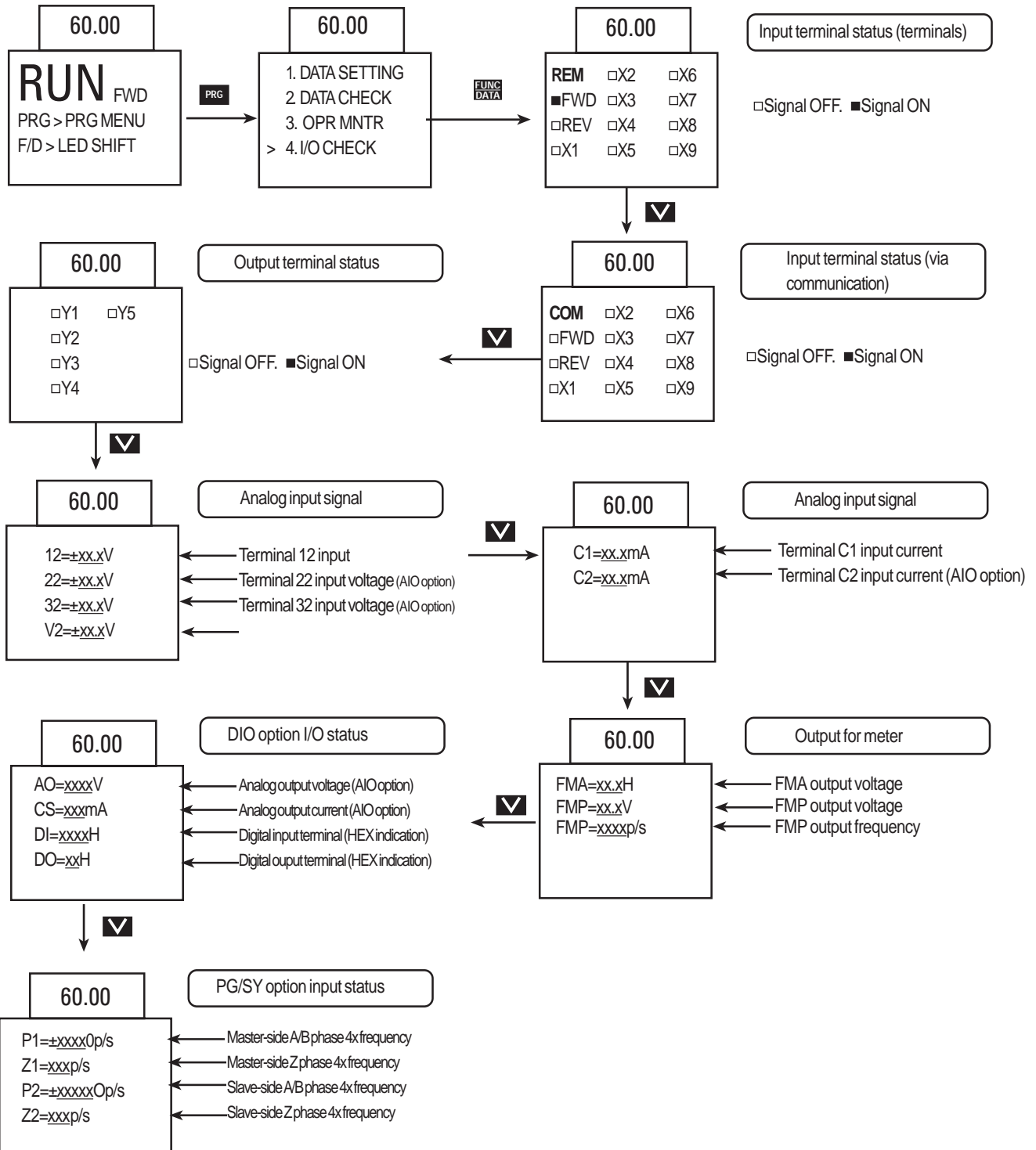

to switch between the seven screens of data.



4.3.9 Maintenance Information

Select 5. on the Program Menu screen. Maintenance to display information necessary for maintenance and inspection. Use  and  to switch between the five screens of data.

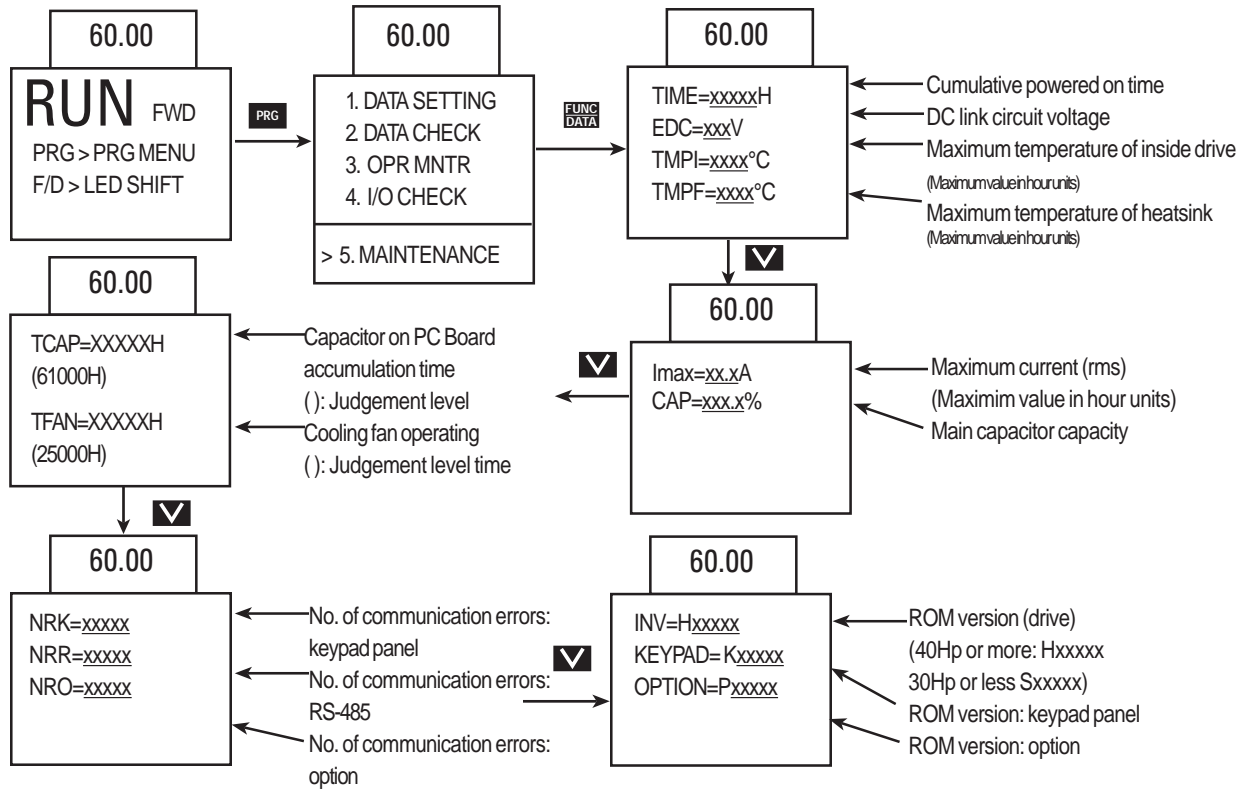

4.3.10 Load Rate Measurement

Select 6. Load Rate Measurement (LOAD FCTR) on the Program Menu screen. The maximum current, average current, and average braking power during the set measuring time are measured and displayed.

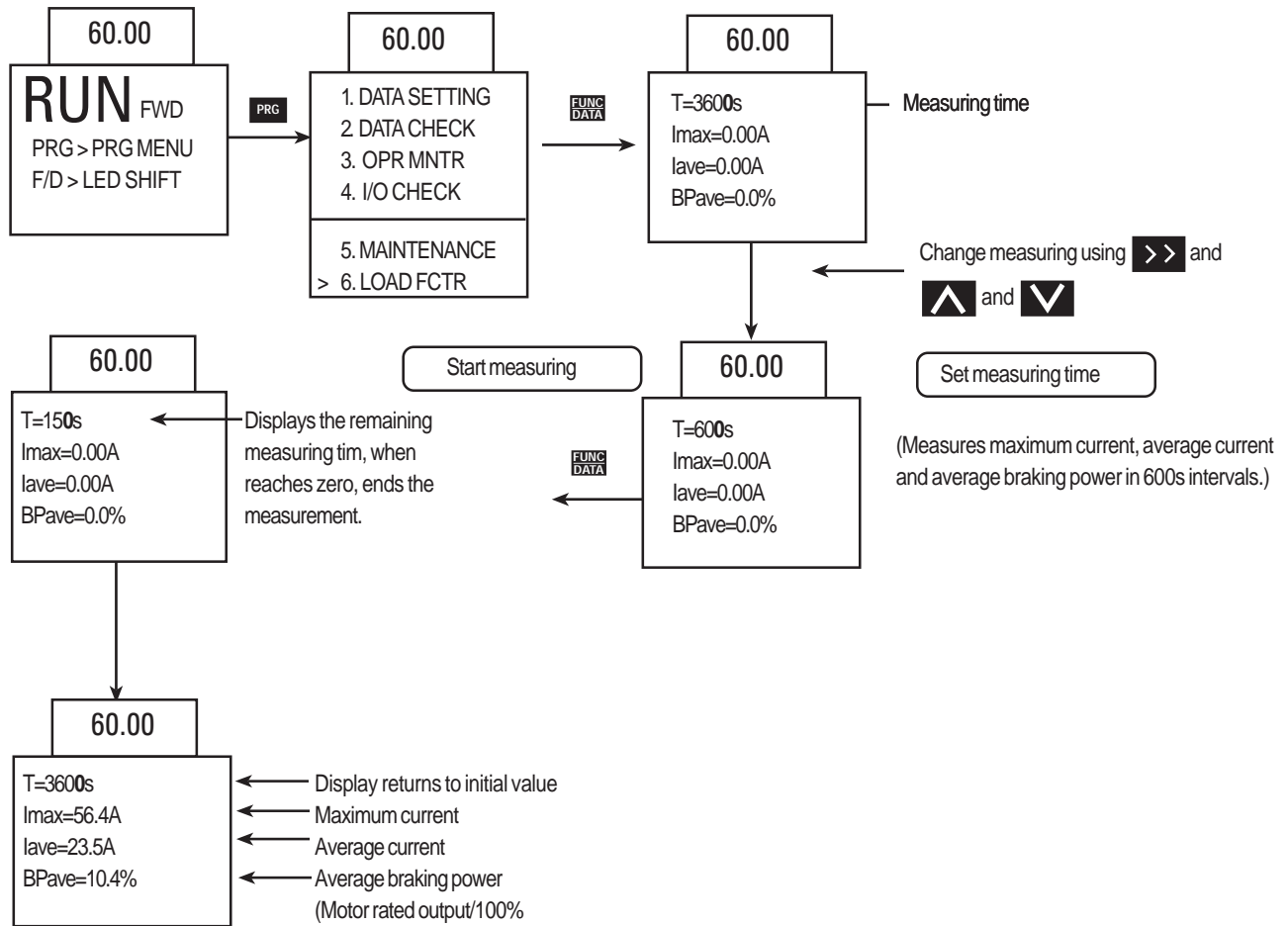

4.3.11 Alarm Information

Select 7. Alarm Information (ALM INF) on the Program Menu screen. A variety of operating data at the time the latest alarm occurred is displayed. Use UP and DOWN to switch between the nine screens of alarm information data.

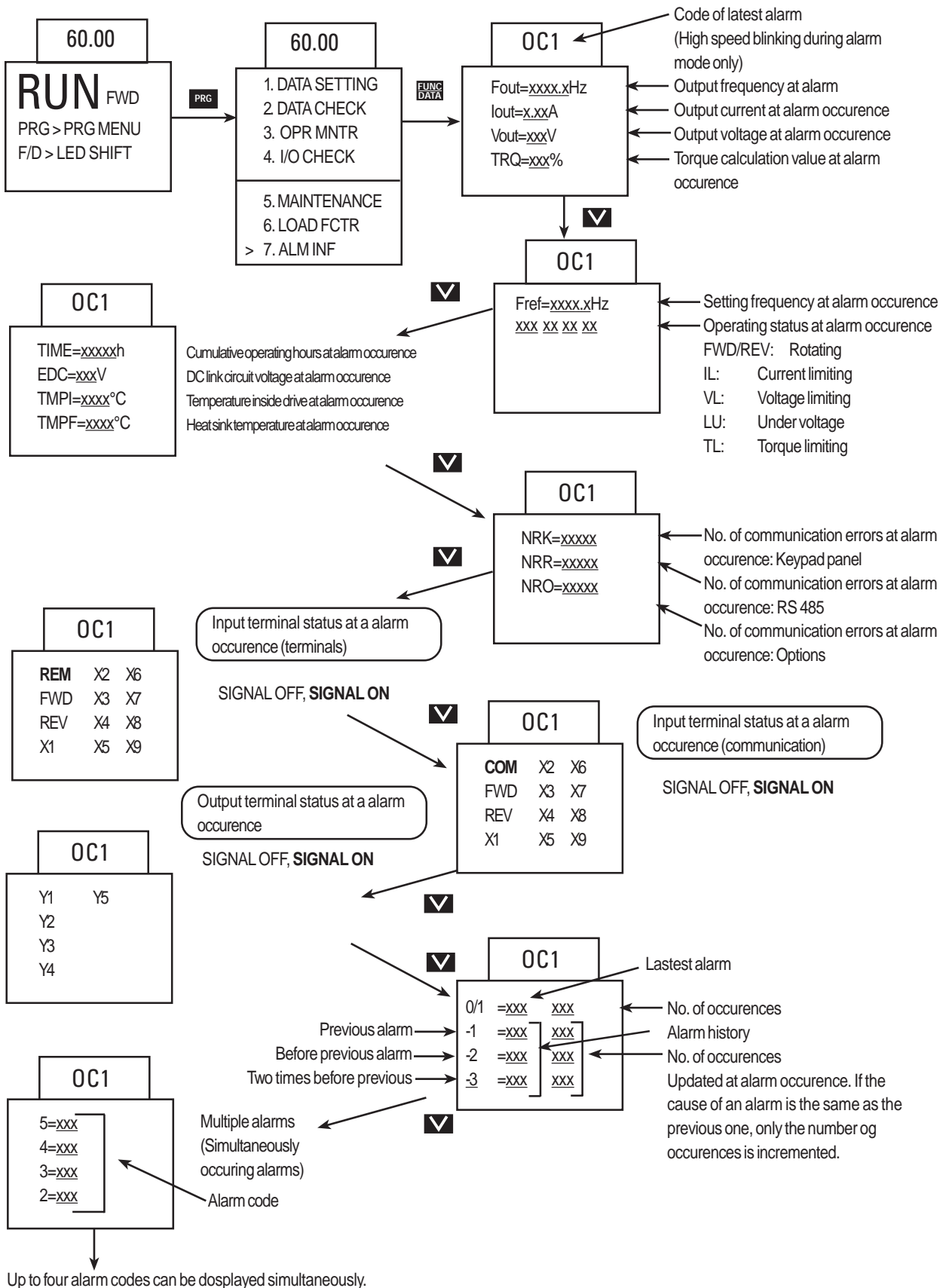

4.3.12 Alarm History and Factors

Select 8. Alarm Cause on the Program Menu screen, to display the alarm history.

Press FUNC/DATA to display troubleshooting information for the alarm selected.

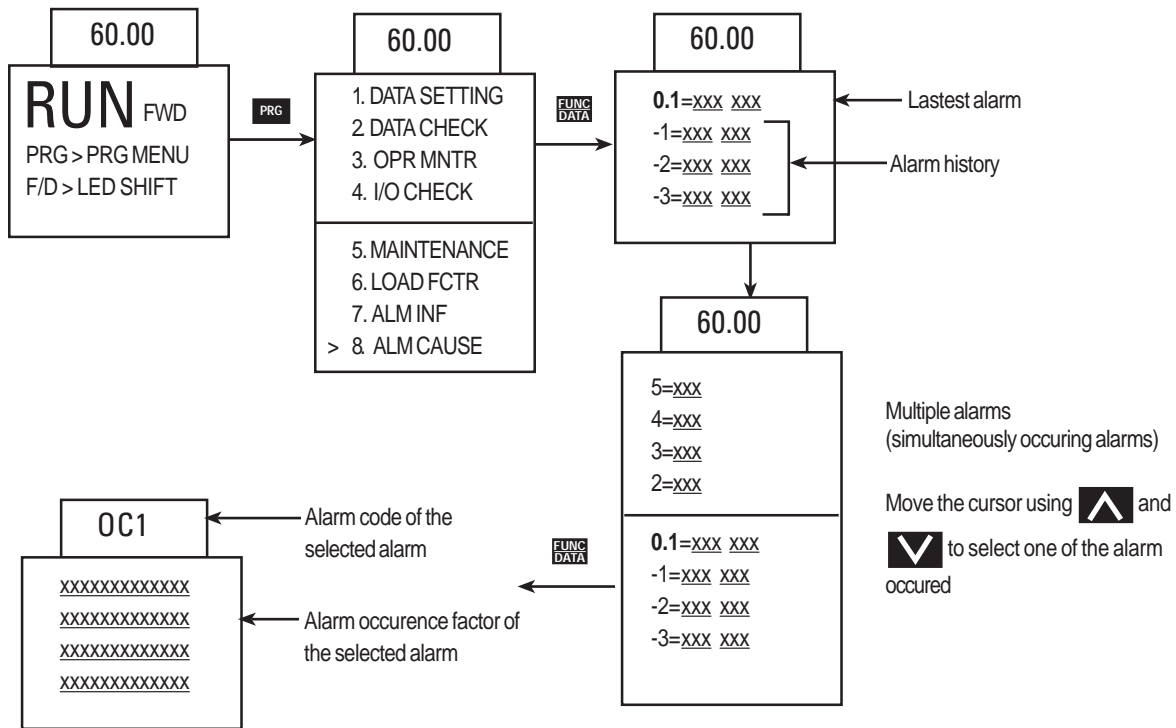

4.3.13 Data Copy

Select 9. Data Copy to display the Data Copy on the Program Menu screen. Read screen. A copy operation is then performed in the following order: function data is read from the first inverter, the keypad panel is removed and attached to a second inverter, the data from the first inverter is written to and stored in the second inverter.

The “verify” feature also makes it possible to compare and check differences in the data stored in the keypad panel and the data stored in the inverter.

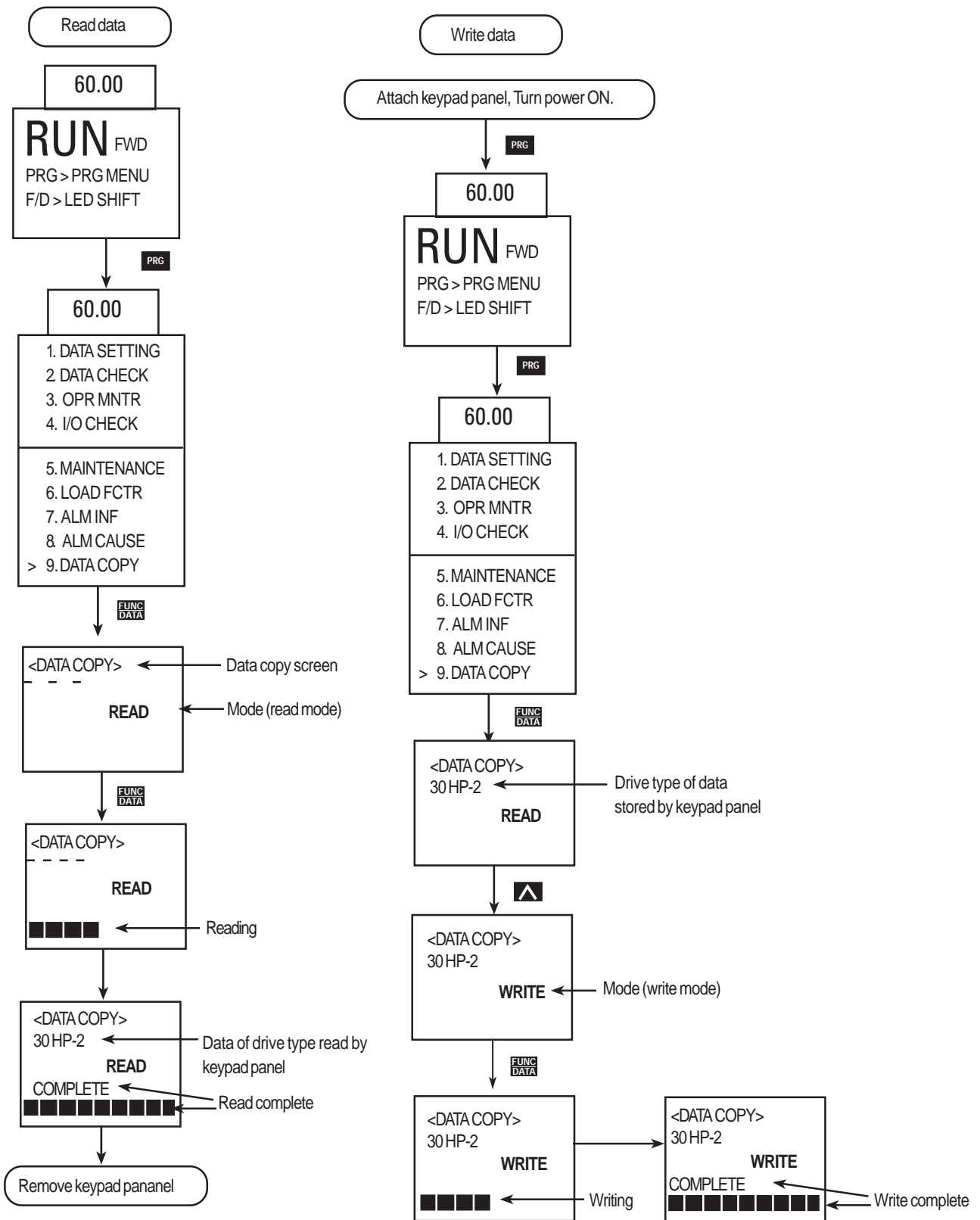

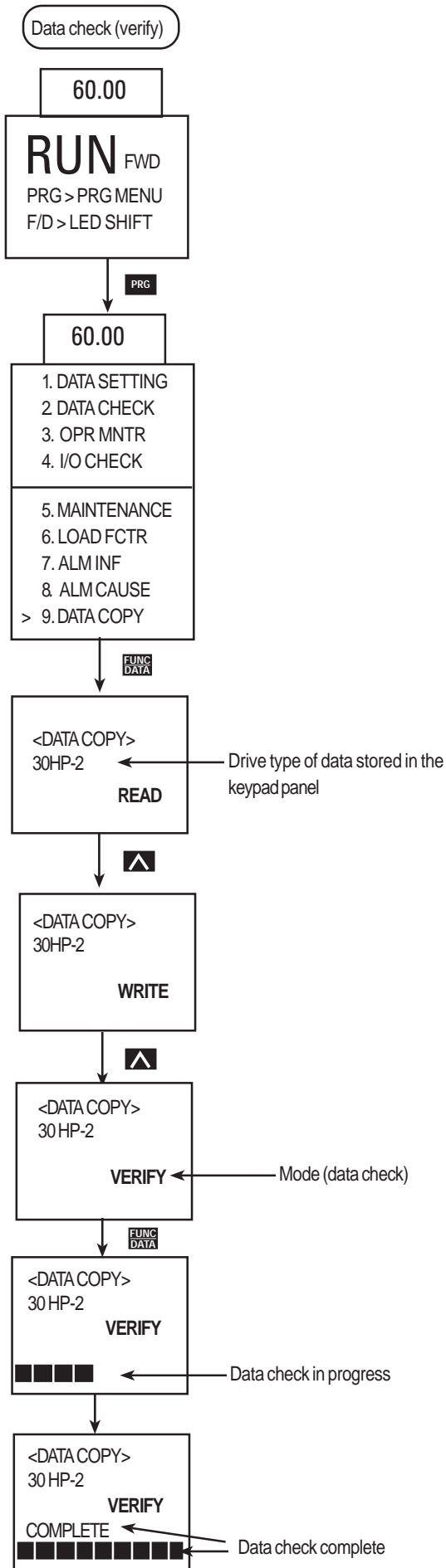

Error processing

1. Change disabled during operation

If a write operation is attempted during a drive operation, or vice versa, the error message below will appear. After stopping the drive and pressing **RESET** retry the write operation.

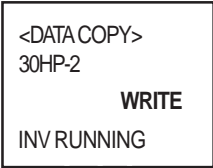

2. Memory error

If a write operation is attempted while data has not been saved (i.e. no data) in the keypad panel data memory during the read mode or when the drive type of data read by keypad panel is different from the drive type to which data is to be written, the following error message will appear.

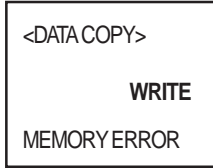

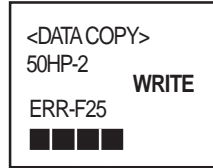

3. Verify error

During a data check (verify) operation, if data stored in the keypad panel differs from data stored in the drive, the following error message is displayed to indicate the function number. The data is suspended. To continue the data check and check for other mismatching data, press **FUNC DATA**. To stop the data check and switch to another operation, press **RESET**.





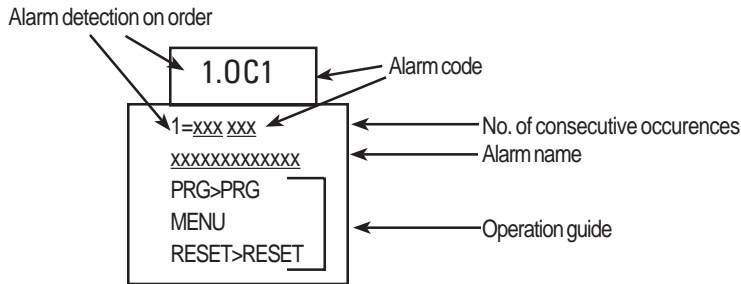

4.3.14 Alarm Mode

If an alarm occurs, the Alarm Screen indicating the alarm contents is displayed. Use  and  to display alarm history and multiple alarms (if more than two alarms occur simultaneously).



Alarm detection order

Operation method	LED display	LCD display	Description
   	5.	5	No. 5 alarm
	4.	4	No. 4 alarm
	3.	3	No. 3 alarm
	2.	2	No. 2 alarm
	1.	1	No. 1 alarm (more than two alarms occurred)
	Blank	0	Latest alarm (only one alarm occurred/alarm released)
	Blank	-1	Previous alarm history
	Blank	-2	Alarm history before previous alarm
	Blank	-3	Alarm history two times before previous alarm

Alarm code: See Table 6-1-1

5. Function Selection

5.1 Function Selection List

F: Fundamental Functions

Pg.	Func. No.	Name	LCD Display	Setting Range	Unit	Min.	Factory Setting		Data Formst	Change during op
							30 HP	40 HP		
5-7	F00	Data protection	F00 DATA PRTC	0, 1	-	-	0		1	N
	F01	Frequency command 1	F01 FREQ CMD 1	0 to 11	-	-	0		1	N
	F02	Operation method	F02 OPR METHOD	0 to 4	-	-	0		1	N
5-10	F03	Maximum frequency 1	F03 MAX Hz-1	50 to 120Hz	Hz	1	60		1	N
	F04	Base frequency 1	F04 BASE Hz-1	25 to 120Hz	Hz	1	60		1	N
	F05	Rated voltage 1 (at Base frequency 1)	F05 RATED V-1	0V: (Output voltage proportional to source voltage) 230V class: 80 to 240V 460V class: 320 to 480V	V	1	230: (230V class) 460: (460V class)		1	N
	F06	Maximum voltage 1 (at Maximum frequency 1)	F06 MAX V-1	230V class: 80 to 240V 460V class: 320 to 480V	V	1	230: (230V class) 460: (460V class)		1	N
	F07	Acceleration time 1	F07 ACC TIME1	0.01 to 3600 s	s	0.01	6.0	20.0	12	Y
	F08	Deceleration time 1	F08 DEC TIME1							
	5-11	F09	Torque boost 1	F09 TRQ BOOST1	0.0, 0.1 to 20.0	-	0.1	2.0		12
F10		Electronic (Select) (level)	F10 ELCTRN OL1	0, 1, 2	-	-	1		3	Y
F11		Thermal 1 (level)	F11 OL LEVEL1	20 to 135% of drive rated current	A	0.01	Motor rated current		1	Y
F12		(time constant)	F12 TIME CNST1	0.5 to 75.0 min	min	0.1	5.0	10.0	19	Y
F13		Electronic thermal overload relay (for braking resistor)	F13 DBR OL	[Up to 15 HP] 0, 1, 2 [20 HP and above] 0	-	-	1 0		3	Y
5-12	F14	Restart mode after momentary power failure	F14 RESTART	0 to 5	-	-	0		1	N
5-14	F15	Frequency (high)	F15 H LIMITER	0 to 120 Hz	Hz	1	70		1	Y
	F16	Limiter (low)	F16 L LIMITER				0		1	N
	F17	Gain (for frequency set signal)	F17 FREQ GAIN	0.0 to 200.0%	%	0.1	100.0		1	Y
	F18	Bias frequency	F18 FREQ BIAS	-120.0 to +120.0 Hz	Hz	0.1	0.0		1	Y
	F20	DC brake (starting frequency)	F20 DC BRK Hz	0.0 to 60.0 Hz	Hz	0.1	0.0		3	Y
	F21	(braking level)	F21 DC BRK LVL	0 to 80%	%	1	0		1	
F22	(braking time)	F22 DC BRK t	0.0s (inactive)	s	0.1	0.0		3		
5-15	F23	Starting frequency	F23 START Hz	0.1 to 60.0 Hz	Hz	0.1	0.5		3	N
	F24	(holding time)	F24 HOLDING t	0.0 to 10.0 s	s	0.1	0.0		3	
	F25	Stop frequency	F25 STOP Hz	0.1 to 6.0 Hz	Hz	0.1	0.2		1	
	F26	Motor sound (carrier freq.)	F26 MTR SOUND	0.75 to 15 kHz (6kHz)	kHz	1	2		1	
	F27	(sound tone)	F27 SOUND TONE	0 to 3	-	-	0		1	Y
	F30	FMA (voltage adjust)	F30 FMA V-ADJ	0 to 200%	%	1	100		1	Y
	F31	(function)	F31 FMA FUNC	0 to 10	-	-	0		1	Y
5-16	F33	FMP (pulse rate)	F33 FMP PULSES	300 to 6000 p/s (full scale)	p/s	1	1440		1	Y
	F34	(voltage adjust)	F34 FMP V-ADJ	0%, 1 to 200%	%	1	0		1	Y
	F35	(function)	F35 FMP FUNC	0 to 10	-	-	0		1	Y
	F36	30RY operation mode	F36 30RY MODE	0, 1	-	-	0		1	Y
	F40	Torque limiter1 (driving)	F40 DRV TRQ 1	20 to 150%, 999	%	1	999		1	Y
F41	(braking)	F41 BRK TRQ 1	0%, 20 to 150%, 999			999		1		
5-17	F42	Torque vector control 1	F42 TRQVECTOR1	0, 1	-	-	0		1	N

E: Terminal Extensions Functions

Pg.	Func. No.	Name	LCD Display	Setting Range	Unit	Min.	Factory Setting		Data Format	Change During op				
							30 HP	40 HP						
5-18/21	E01	X1 terminal function	E01 X1 FUNC	0 to 32				0	1	N				
	E02	X2 terminal function	E02 X2 FUNC								1	N		
	E03	X3 terminal function	E03 X3 FUNC								2	N		
	E04	X4 terminal function	E04 X4 FUNC								3	N		
	E05	X5 terminal function	E05 X5 FUNC								4	N		
	E06	X6 terminal function	E06 X6 FUNC								5	N		
	E07	X7 terminal function	E07 X7 FUNC								6	N		
	E08	X8 terminal function	E08 X8 FUNC								7	N		
	E09	X9 terminal function	E09 X9 FUNC								8	N		
5-22	E10	Acceleration time 2	E10 ACC TIME2	0.01 to 3600 s	s	0.01	6.00	20.00	12	Y				
	E11	Deceleration time 2	E11 DEC TIME2								6.00	20.00	12	Y
	E12	Acceleration time 3	E12 ACC TIME3								6.00	20.00	12	Y
	E13	Deceleration time 3	E13 DEC TIME3								6.00	20.00	12	Y
	E14	Acceleration time 4	E14 ACC TIME4								6.00	20.00	12	Y
	E15	Deceleration time 4	E15 DEC TIME4								6.00	20.00	12	Y
	E16	Torque limiter 2 (driving)	E16 DRV TRQ 2								20 to 150%, 999	%	1	999
E17	(braking)	E17 BRK TRQ 2	0%, 20 to 150%, 999	%	1	999	1	1	Y					
5-22/24	E20	Y1 terminal function	E20 Y1 FUNC	0 to 33				0	1	N				
	E21	Y2 terminal function	E21 Y2 FUNC								1	N		
	E22	Y3 terminal function	E22 Y3 FUNC								2	N		
	E23	Y4 terminal function	E23 Y4 FUNC								7	N		
	E24	Y5A, Y5C terminal function	E24 Y5 FUNC								10	N		
5-24	E25	Y5 RY operation mode	E25 Y5RY MODE	0,1	-	1	0	1	N					
5-25	E30	FAR function (Hysteresis)	E30 FAR HYSTR	0.0 to 10.0 Hz	Hz	0.1	2.5	3	Y					
	E31	FDT function (level)	E31 FDT1 LEVEL	0 to 120 Hz	Hz	1	60	1	Y					
	E32	signal (Hysteresis)	E32 FDT1 HYSTR	0.0 to 30.0 Hz	Hz	0.1	1.0	3	Y					
	E33	OL function (mode select)	E33 OL1 WARNING	0: Thermal calculation 1: Output current	-	-	0	1	Y					
	E34	signal (l) (level)	E34 OL1 LEVEL	5 to 150% of rated drive current	A	0.01	motor rated current	19	Y					
	E35	(timer)	E35 OL1 TIMER	0.1 to 60.0 s	s	0.1	10.0	3	Y					
	E36	FDT2 function (level)	E36 FDT2 LEVEL	0 to 120 Hz	Hz	1	60	1	Y					
E37	OL2 function (level)	E37 OL2 LEVEL	5 to 150% of rated drive current	A	0.01	motor rated current	19	Y						
5-26	E40	Display coefficient A	E40 COEF A	-999.00 to 999.00	-	0.01	0.01	12	Y					
	E41	Display coefficient B	E41 COEF B	-999.00 to 999.00	-	0.01	0.00	12	Y					
	E42	LED Display filter	E42 DISPLAY FL	0.0 to 5.0 s	s	0.1	0.5	3	Y					
	E43	LED Monitor (function)	E43 LED MNTR	0 to 12	-	-	0	1	Y					
	E44	(display in STOP mode)	E44 LED MNTR2	0, 1	-	-	0	1	Y					
5-27	E45	LCD Monitor (function)	E45 LCD MNTR	0, 1	-	-	0	1	Y					
	E46	(language)	E46 LANGUAGE	0 to 5	-	-	1	1	Y					
	E47	(contrast)	E47 CONTRAST	0(soft) to 10(hard)	-	-	5	1	Y					

C:Frequency Control Functions

5-28	C01	Jump (Jump freq. 1)	C01 JUMP Hz 1	0 to 120 Hz	Hz	1	0	1	Y		
	C02	frequency (Jump freq. 2)	C02 JUMP Hz 2							0	1
	C03	(Jump freq. 3)	C03 JUMP Hz 3							0	1
	C04	(Hysteresis)	C04 JUMP HYSTR							3	1
	C05	Multistep (Freq. 1)	C05 MULTI Hz-1	0.00 to 120.00 Hz	Hz	0.01	0.00	5	Y		
	C06	frequency (Freq. 2)	C06 MULTI Hz-2							0.00	5
	C07	setting (Freq. 3)	C07 MULTI Hz-3							0.00	5
	C08	(Freq. 4)	C08 MULTI Hz-4							0.00	5
	C09	(Freq. 5)	C09 MULTI Hz-5							0.00	5
	C10	(Freq. 6)	C10 MULTI Hz-6							0.00	5
	C11	(Freq. 7)	C11 MULTI Hz-7							0.00	5
	C12	(Freq. 8)	C12 MULTI Hz-8							0.00	5
	C13	(Freq. 9)	C13 MULTI Hz-9							0.00	5
	C14	(Freq. 10)	C14 MULTI Hz-10							0.00	5
	C15	(Freq. 11)	C15 MULTI Hz-11							0.00	5
	C16	(Freq. 12)	C16 MULTI Hz-12							0.00	5
	C17	(Freq. 13)	C17 MULTI Hz-13							0.00	5
	C18	(Freq. 14)	C18 MULTI Hz-14							0.00	5
	C19	(Freq. 15)	C19 MULTI Hz-15							0.00	5

Pg.	Func. No.	Name	LCD Display	Setting Range	Unit	Min.	Factory Setting		Data Format	Change during op
							30 HP	40 HP		
5-29	C20	JOG frequency	C20 JOG Hz	0.00 to 120.00 Hz	Hz	0.01	5.00		5	Y
	C21	PATTERN (mode select) operation	C21 PATTERN	0,1,2	-	-	0		1	N
5-29/30	C22	(Stage 1)	C22 STAGE 1	Operation time: 0.00 to 6000 s F1 to F4 and R1 to R4	s	0.01	0.00 F1		13	Y
	C23	(Stage 2)	C23 STAGE 2				0.00 F1		13	
	C24	(Stage 3)	C24 STAGE 3				0.00 F1		13	
	C25	(Stage 4)	C25 STAGE 4				0.00 F1		13	
	C26	(Stage 5)	C26 STAGE 5				0.00 F1		13	
	C27	(Stage 6)	C27 STAGE 6				0.00 F1		13	
	C28	(Stage 7)	C28 STAGE 7				0.00 F1		13	
5-30	C30	Frequency command 2	C30 FREQ CMD 2	0 to 11	-	-	2		1	N
	C31	Offset adjust (terminal [I2])	C31 BIAS 12	-100.0 to +100.0%	%	0.1	0.0		4	Y
	C32	(terminal [C1])	C32 GAIN 12	0.0 to +200.0%	%	0.1	100.0		3	Y
5-31	C33	Analog setting signal filter	C33 REF FILTER	0.00 to 5.00s	s	0.01	0.05		5	Y
P:Motor Parameters										
5-32	P01	Number of motor 1 poles	P01 M1 POLES	2 to 14	-	2	4		9	N
	P02	Motor 1 (capacity)	P02 M1-CAP	Up to 30 HP: 0.01 to 60 HP 40 HP and above: 0.01 to 600 HP	Hp	0.01	motor capacity		5	N
	P03	(rated current)	P03 M1-Ir	0.00 to 2000 A	A	0.01	motor rated current		19	N
	P04	(tuning)	P04 M1 TUN1	0, 1, 2	-	-	0		21	N
5-33	P05	(on-line tuning)	P05 M1 TUN2	0, 1	-	-	0		1	N
	P06	(no-load current)	P06 M1-lo	0.00 to 2000 A	A	0.01	standard rated value		19	N
	P07	(%R1 setting)	P07 M1-%R1	0.00 to 50.00%	%	0.01	standard rated value		5	Y
	P08	(%X setting)	P08 M1-%X	0.00 to 50.00%	%	0.01	standard rated value		5	Y
	P09	Slip compensation control	P09 SLIP COMP1	0.00 to 15.00 Hz	Hz	0.01	0.00		5	Y
H:High Performance Functions										
5-34	H03	Data initializing	H03 DATA INIT	0, 1	-	-	0		1	N
	H04	Auto-reset (times)	H04 AUTO-RESET	0, 1 to 10 times	-	1	0		1	Y
	H05	(reset interval)	H05 RESET INT	2 to 20 s	s	1	5		1	Y
	H06	Fan stop operation	H06 FAN STOP	0, 1	-	-	0		1	Y
5-35	H07	ACC/DEC pattern (mode select)	H07 ACC PTN	0,1,2,3	-	-	0		1	N
	H08	Rev. phase sequence lock	H08 REV LOCK	0, 1	-	-	0		1	N
	H09	Start mode	H09 START MODE	0, 1, 2	-	--	0		1	N
5-36	H10	Energy-saving operation	H10 ENERGY SAV	0, 1	-	-	1		1	Y
	H11	DEC mode	H11 DEC MODE	0, 1	-	-	0		1	Y
	H12	Instantaneous OC limiting	H12 INST CL	0, 1	-	-	1		1	N
	H13	Auto-restart (restart time)	H13 RESTART t	0.1 to 10.0 s	s	0.1	0.1	0.5	3	N
	H14	(freq. fall rate)	H14 FALL RATE	0.00 to 100.00 Hz/s	Hz/s	0.01	10.00		5	Y
H15	(holding DC voltage)	H15 HOLD V	3-phase, 230V class: 200 to 300V 3-phase, 460V class: 400 to 600V	V	1	200V class: 235V 400V class: 470V		1		
5-37	H16	(OPR command self hold time)	H16 SELFHOLD t	0.0 to 30.0 s, 999	s	0.1	999		3	N
	H19	Active drive	H19 AUT RED	0, 1	-	-	0		1	Y
	H20	PID control (mode select)	H20 PID MODE	0, 1, 2	--	-	0		1	N
5-38	H21	(feedback signal)	H21 FB SIGNAL	0, 1, 2, 3	-	-	1		1	N
5-39/40	H22	(P-gain)	H22 P-GAIN	0.01 to 10.00 times	-	0.01	0.1		5	Y
	H23	(I-gain)	H23 I-GAIN	0.0, 0.1 to 3600 s	s	0.1	0.0		3	Y
	H24	(D-gain)	H24 D-GAIN	0.00 s, 0.01 to 10.0 s	s	0.01	0.00		5	Y
5-41	H25	(feedback filter)	H25 FB FILTER	0.0 to 60.0 s	s	0.1	0.5		3	Y
	H26	PTC thermistor (mode select)	H26 PTC MODE	0, 1	-	-	0		1	Y
	H27	(level)	H27 PTC LEVEL	0.00 to 5.00V	V	0.01	1.60		5	Y
5-42	H30	Serial link (function select)	H30 LINK FUNC	0, 1, 2, 3	-	-	0		1	Y
	H31	Modbus-RTU (address)	H31 ADDRESS	0 (broadcast), 1 to 247	-	1	1		1	N
	H32	(mode select on no response error)	H32 MODE ON ER	0, 1, 2, 3	-	-	0		1	Y
	H33	(timer)	H33 TIMER	0.0 to 60.0 s	s	-	2.0		3	Y
	H34	(baud rate)	H34 BAUD RATE	0, 1, 2, 3	-	-	1		1	Y
	H35	(data length)	H35 LENGTH	0 (8-bit fixed)	-	-	0		1	Y
	H36	(parity check)	H36 PARITY	0, 1, 2	-	-	0		1	Y
	H37	(stop bits)	H37 STOP BITS	0 (2-bit), 1(1-bit)	-	-	0		1	Y
5-43	H38	(no response error detection time)	H38 NO RES t	0 (no detection), 1 to 60 s	s	1	0		1	Y
	H39	(response interval)	H39 INTERVAL	0.00 to 1.00 s	s	0.01	0.01		5	Y

A: Alternative Motor Parameters

Pg.	Func. No.	Name	LCD Display	Setting Range	Unit	Factory Setting		Data Format	Change During op	
						Min.	30 HP 40 HP			
5-44	A01	Maximum frequency 2	A01 MAX Hz-2	50 to 120 Hz	Hz	1	60		1	N
	A02	Base frequency 2	A02 BASE Hz-2	25 to 120 Hz	Hz	1	60		1	N
	A03	Rated voltage 2 (at Base frequency 2)	A03 RATED V-2	0 230V class: 80 to 240V 460V class: 320 to 480V	V	1	230V class: 230 460V class: 460		1	N
	A04	Maximum voltage 2	A04 MAX V-2	230V class: 80 to 240V 460V class: 320 to 480V	V	1	230V class: 230 460V class: 460		1	N
	A05	Torque boost 2	A05 TRQ BOOST2	0.0, 0.1 to 20.0	-	-	2.0		3	Y
	A06	Electronic (select)	A06 ELCTRN OL2	0, 1, 2	-	-	1		1	Y
	A07	thermal 2 (level)	A07 DL LEVEL2	20% to 135% if INV rated current	A	0.01	motor rated current		19	Y
	A08	(thermal time constant)	A08 TIME CNST2	0.5 to 75.0 min	min	0.1	5.0	10.0	3	Y
	A09	Torque vector control 2	A09 TRQVECTOR2	0, 1	-	-	0		1	N
	A10	Number of motor 2 poles	A10 M2 POLES	2 to 14 poles	pole	2	4		9	N
5-45	A11	Motor 2 (capacity)	A11 M2-CAP	Up to 30 HP: 0.01 to 60 HP 40 HP and above: 0.01 to 600 HP	HP	0.01	motor capacity		5	N
	A12	(rated current)	A12 M2-Ir	0.00 to 2000 A	A	0.01	motor rated current		19	N
	A13	(tuning)	A13 M2 TUN1	0, 1, 2	-	-	0		21	N
	A14	(on-line tuning)	A14 M2 TUN2	0, 1	-	-	0		1	N
	A15	(no-load current)	A15 M2-Io	0.00 to 2000 A	A	0.01	standard rated value		19	N
	A16	(%R1 setting)	A16 M2-%R1	0.00 to 50.00%	%	0.01	standard rated value		5	Y
	A17	(%X setting)	A17 M2-%X	0.00 to 50.00%	%	0.01	standard rated value		5	Y
	A18	(slip compensation control 2)	A18 SLIP COMP2	0.00 to 15.00 Hz	Hz	0.01	0.00		5	Y

5.2 Alphabetical Function List

PG.	NAME	LCD Display
5-16	30RY operation mode	F36 30RY MODE
5-10	Acceleration time 1	F07 ACC TIME1
5-22	Acceleration time 2	E10 ACC TIME2
5-22	Acceleration time 3	E12 ACC TIME3
5-22	Acceleration time 4	E14 ACC TIME4
5-34	ACC/DEC Pattern	H07 ACC PTN
5-37	Active Drive	H19 AUT RED
5-31	Analog setting signal filter	C33 REF FILTER
5-10	Base frequency 1	F04 BASE Hz-1
5-44	Base frequency 2	A02 BASE Hz-2
5-14	Bias frequency	F18 FREQ BIAS
5-34	Data initializing	H03 DATA INIT
5-7	Data protection	F00 DATA PRTC
5-14	DC brake (Braking level)	F21 DC BRK LVL
5-14	DC brake (Braking time)	F22 DC BRK t
5-14	DC brake (Starting freq.)	F20 DC BRK Hz
5-36	DEC mode	H11 DEC MODE
5-10	Deceleration time 1	F08 DEC TIME1
5-22	Deceleration time 2	E11 DEC TIME2
5-22	Deceleration time 3	E13 DEC TIME3
5-22	Deceleration time 4	E15 DEC TIME4
5-26	Display coefficient A	E40 COEF A
5-26	Display coefficient B	E41 COEF B
5-11	Electronic Thermal 1 (Level)	F11 OL LEVEL1
5-11	Electronic Thermal 1 (Select)	F10 ELCTR OL1
5-11	Electronic Thermal 1 (Thermal time constant)	F12 TIME CNST1
5-44	Electronic thermal 2 (Level)	A07 OL LEVEL2
5-44	Electronic thermal 2 (Select)	A06 ELCTR OL2
5-44	Electronic thermal 2 (Thermal time constant)	A08 TIME CNST2
5-11	Electronic thermal overload relay (for DB resistor)	F13 DBR OL
5-36	Energy-saving operation	H10 ENERGY SAV
5-34	Fan stop operation	H06 FAN STOP
5-25	FAR function (Hysteresis)	E30 FAR HYSTR
5-25	FDT function (Level)	E31 FDT1 LEVEL
5-25	FDT signal (Hysteresis)	E32 FDT1 HYSTR
5-25	FDT2 function (Level)	E36 FDT2 LEVEL
5-15	FMA (Voltage adjust)	F30 FMA V-ADJ
5-15	FMA (Function)	F31 FMA FUNC
5-16	FMP (Function)	F35 FMP FUNC
5-16	FMP (Pulse rate)	F33 FMP PULSES
5-16	FMP (Voltage adjust)	F34 FMP V-ADJ
5-7	Frequency command 1	F01 FREQ CMD 1
5-30	Frequency command 2	C30 FREQ CMD 2
5-14	Frequency limiter (High)	F15 H LIMITER
5-14	Frequency limiter (Low)	F16 L LIMITER
5-14	Gain (for freq set signal)	F17 FREQ GAIN
5-36	Instantaneous OC limiting	H12 INST CL
5-29	JOG frequency	C20 JOG Hz
5-28	Jump frequency (Hysteresis)	C04 JUMP HYSTR
5-28	Jump frequency (Jump freq 1)	C01 JUMP Hz 1
5-28	Jump frequency (Jump freq 2)	C02 JUMP Hz 2
5-28	Jump frequency (Jump freq 3)	C03 JUMP Hz 3
5-27	LCD Monitor (Contrast)	E47 CONTRAST
5-27	LCD Monitor (Function)	E45 LCD MNTR
5-27	LCD Monitor (Language)	E46 LANGUAGE
5-26	LED Display filter	E42 DISPLAY FL
5-26	LED Monitor (Function)	E43 LED MNTR

PG.	NAME	LCD Display
5-26	LED Monitor (Display @ STOP mode)	E44 LED MNTR2
5-10	Maximum frequency 1	F03 MAX Hz-1
5-44	Maximum frequency 2	A01 MAX Hz-2
5-10	Maximum voltage 1	F06 MAX V-1
5-44	Maximum voltage 2	A04 MAX V-2
5-42	Modbus-RTU (Address)	H31 ADDRESS
5-42	Modbus-RTU (Baud rate)	H34 BAUD RATE
5-42	Modbus-RTU (Data length)	H35 LENGTH
5-42	Modbus-RTU (Mode select on no response error)	H32 MODE ON ER
5-43	Modbus-RTU (No response error detection time)	H38 NO RES t
5-42	Modbus-RTU (Parity check)	H36 PARITY
5-43	Modbus-RTU (Response interval)	H39 INTERVAL
5-42	Modbus-RTU (Stop bits)	H37 STOP BITS
5-42	Modbus-RTU (Timer)	H33 TIMER
5-33	Motor 1 (%R1 setting)	P07 M1-%R1
5-33	Motor 1 (%X setting)	P08 M1-%X
5-32	Motor 1 (Capacity)	P02 M1 -CAP
5-33	Motor 1 (No-load current)	P06 M1-lo
5-33	Motor 1 (On-line Tuning)	P05 M1 TUN2
5-32	Motor 1 (Rated current)	P03 M1-lr
5-32	Motor 1 (Tuning)	P04 M1 TUN1
5-45	Motor 2 (%R1 setting)	A16 M2-%R1
5-45	Motor 2 (%X setting)	A17 M2-%X
5-44	Motor 2 (Capacity)	A11 M2-CAP
5-45	Motor 2 (No-load current)	A15 M2-lo
5-45	Motor 2 (On-line Tuning)	A14 M2 TUN2
5-44	Motor 2 (Rated current)	A12 M2-lr
5-45	Motor 2 (Slip compensation control 2)	A18 SLIP COMP2
5-45	Motor 2 (Tuning)	A13 M2 TUN1
5-15	Motor sound (Carrier freq.)	F26 MTR SOUND
5-15	Motor sound (Sound tone)	F27 SOUND TONE
5-28	Multistep frequency setting (Freq. 1)	C05 MULTI Hz-1
5-28	Multistep frequency setting (Freq. 2)	C06 MULTI Hz-2
5-28	Multistep frequency setting (Freq. 3)	C07 MULTI Hz-3
5-28	Multistep frequency setting (Freq. 4)	C08 MULTI Hz-4
5-28	Multistep frequency setting (Freq. 5)	C09 MULTI Hz-5
5-28	Multistep frequency setting (Freq. 6)	C10 MULTI Hz-6
5-28	Multistep frequency setting (Freq. 7)	C11 MULTI Hz-7
5-28	Multistep frequency setting (Freq. 8)	C12 MULTI Hz-8
5-28	Multistep frequency setting (Freq. 9)	C13 MULTI Hz-9
5-28	Multistep frequency setting (Freq. 10)	C14 MULTI Hz-10
5-28	Multistep frequency setting (Freq. 11)	C15 MULTI Hz-11
5-28	Multistep frequency setting (Freq. 12)	C16 MULTI Hz-12
5-28	Multistep frequency setting (Freq. 13)	C17 MULTI Hz-13
5-28	Multistep frequency setting (Freq. 14)	C18 MULTI Hz-14
5-28	Multistep frequency setting (Freq. 15)	C19 MULTI Hz-15

5.2 Alphabetical Function List (continued)

PG.	NAME		LCD Display
5-32	Number of motor 1 poles	P01	M1 POLES
5-44	Number of motor 2 poles	A10	M2 POLES
5-30	Offset adjust (terminal [12])	C31	BIAS 12
5-30	Offset adjust (terminal [C1])	C32	GAIN 12
5-25	OL function (Mode select)	E33	OL1 WARNING
5-25	OL function signal (Timer)	E35	OL1 TIMER
5-25	OL function signal (Level)	E34	OL1 LEVEL
5-25	OL2 function (Level)	E37	OL2 LEVEL
5-7	Operation method	F02	OPR METHOD
5-29	Pattern (Stage 1)	C22	STAGE 1
5-29	Pattern (Stage 2)	C23	STAGE 2
5-29	Pattern (Stage 3)	C24	STAGE 3
5-29	Pattern (Stage 4)	C25	STAGE 4
5-29	Pattern (Stage 5)	C26	STAGE 5
5-29	Pattern (Stage 6)	C27	STAGE 6
5-29	Pattern (Stage 7)	C28	STAGE 7
5-29	PATTERN operation (Mode select)	C21	PATTERN
5-39	PID control (D-gain)	H24	D-GAIN
5-41	PID control (Feedback filter)	H25	FB FILTER
5-38	PID control (Feedback signal)	H21	FB SIGNAL
5-39	PID control (I-gain)	H23	I-GAIN
5-37	PID control (Mode select)	H20	PID MODE
5-39	PID control (P-gain)	H22	P-GAIN
5-41	PTC thermistor (Level)	H27	PTC LEVEL
5-41	PTC thermistor (Mode select)	H26	PTC MODE
5-10	Rated voltage 1	F05	RATED V-1
5-44	Rated voltage 2 (at Base frequency 2)	A03	RATED V-2
5-12	Restart mode after momentary power failure	F14	RESTART
5-35	Rev. phase sequence lock	H08	REV LOCK
5-42	Serial link (Function select)	H30	LINK FUNC
5-33	Slip compensation control	P09	SLIP COMP1
5-35	Start mode	H09	START MODE
5-15	Starting frequency (Freq.)	F23	START Hz
5-15	Starting frequency (Holding time)	F24	HOLDING t
5-15	Stop frequency	F25	STOP Hz
5-11	Torque boost 1	F09	TRQ BOOST1
5-44	Torque boost 2	A05	TRQ BOOST2
5-16	Torque limiter 1 (braking)	F41	BRK TRQ 1
5-16	Torque limiter 1 (Driving)	F40	DRV TRQ 1
5-22	Torque limiter 2 (braking)	E17	BRK TRQ 2
5-22	Torque limiter 2 (Driving)	E16	DRV TRQ 2
5-177	Torque vector control 1	F42	TRQVECTOR1
5-44	Torque vector control 2	A09	TRQVECTOR2
5-18	X1 terminal function	E01	X1 FUNC
5-18	X2 terminal function	E02	X2 FUNC
5-18	X3 terminal function	E03	X3 FUNC
5-18	X4 terminal function	E04	X4 FUNC
5-18	X5 terminal function	E05	X5 FUNC
5-18	X6 terminal function	E06	X6 FUNC
5-18	X7 terminal function	E07	X7 FUNC
5-22	Y1 terminal function	E20	Y1 FUNC
5-22	Y2 terminal function	E21	Y2 FUNC
5-22	Y3 terminal function	E22	Y3 FUNC
5-22	Y4 terminal function	E23	Y4 FUNC
5-24	Y5 RY operation mode	E25	Y5RY MODE
5-22	Y5A, Y5C terminal func.	E24	Y5 FUNC

5.3 Function Explanation

F: Fundamental Functions

F00 Data protection

F 0 0 D A T A P R T C

Setting range 0 : data can be changed
1 : data cannot be changed

This function protects the system by blocking any data changes from the keypad panel.

Setting procedure:

0 to 1: Press the **STOP** and **▲** keys simultaneously to change the value from 0 to 1, then press

the **FUNC DATA** to validate the change.

1 to 0: Press the **STOP** and **▼** keys simultaneously to change the value from 1 to 0, then press

the **FUNC DATA** key to validate the change.

F01 Frequency setting 1

F 0 1 F R E Q C M D 1

This function determines the method to be used for setting frequency.

NOTE: Use only one terminal - V2 or C1, exclusively.

- 0: Keypad operation (**▼** or **▲** key)
- 1: Voltage input (terminal 12 and V2) (0 to +10 VDC, 0 to +5VDC)
- 2: Current input (terminal C1) (4 to 20 mA DC)
- 3: Voltage and current input (terminals 12 and C1)
- 4: Reversible operation with polarity (terminal 12) (0 to ± 10 VDC)
- 5: Reversible operation with polarity (terminal 12 and V2) (0 to ± 10 VDC)

Related functions E01 to E09 (Set values 21)

- 6: Inverse mode operation (terminal 12 and V2) (+10 to 0 VDC)
- 7: Inverse mode operation (terminal C1)(20 to 4 mA DC)
- 8: UP/DOWN control 1 (initial freq. = 0 Hz)
- 9: UP/DOWN control 2 (initial freq. = last value)

Related functions E01 to E09 (Set values 17, 18)

- 10. PATTERN operation

Related functions: C21 to C28

- 11: DI option or Pulse train input

For details, see instruction manual on options.

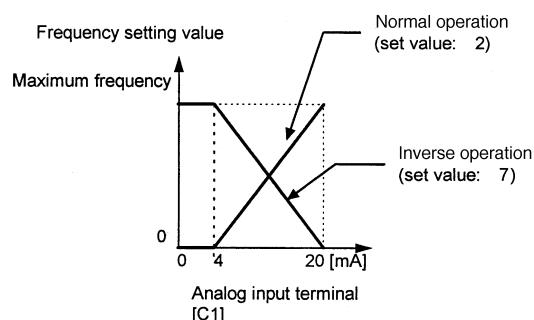
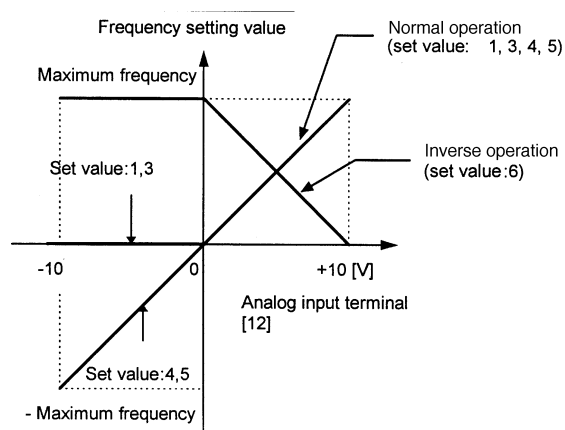

F02 Operation method

F 0 2 O P R M E T H O D

This function determines the input method for operation commands.

- 0: Keypad operation (**FWD** or **REV** or **STOP** key)
- 1: Terminal operation (**STOP** key active)
- 2: Terminal operation (**STOP** key inactive)
- 3: Terminal operation (**STOP** key active) through software
- 4: Terminal operation (**STOP** key inactive) through software

This function can only be changed when terminals **FWD** and **REV** are open.

REMOTE/LOCAL switching from the keypad panel automatically changes the set value from 0 to 3 of this function.

GE Start Software Selection During Terminal Operation

	Inactive: Setting 1 or 2	Active: Setting 3 or 4
POWER ON	<p>Timing diagram for Power On (Inactive: Setting 1 or 2). The signals are: POWER (high), FWD (high), OUTPUT (ramp up), and ALARM (low).</p>	<p>Timing diagram for Power On (Active: Setting 3 or 4). The signals are: POWER (high), FWD (high), OUTPUT (low), and ALARM (ER6 pulse).</p>
RESET	<p>Timing diagram for Reset (Inactive: Setting 1 or 2). The signals are: RESET (pulse), FWD (high), OUTPUT (ramp up), and ALARM (ER6 pulse).</p>	<p>Timing diagram for Reset (Active: Setting 3 or 4). The signals are: RESET (pulses), FWD (high), OUTPUT (ramp up), and ALARM (Multi Alarms* pulse).</p>
NETWORK MODE	<p>Timing diagram for Network Mode (Inactive: Setting 1 or 2). The signals are: NETWORK (LE-CM) (high), FWD (TERMINAL) (high), FWD (NETWORK) (high), OUTPUT (ramp up), and ALARM (low).</p>	<p>Timing diagram for Network Mode (Active: Setting 3 or 4). The signals are: NETWORK (LE-CM) (high), FWD (TERMINAL) (high), FWD (NETWORK) (high), OUTPUT (low), and ALARM (ER6 pulses). A RESET pulse is shown below the ALARM signal.</p>

* See Alarm Mode, page 4-15.

Note: Start Software does not work at AUTO RESET mode and PROGRAMMING mode

Stop Key Mode Selection During Terminal Operation

	Inactive: Setting 2 or 4	Active: Setting 1 or 3
STOP KEY TERMINAL MODE	<p>Timing diagram for Stop Key Terminal Mode (Inactive: Setting 2 or 4). The signals are: FWD (high), STOP (pulse), OUTPUT (ramp up), and ALARM (low).</p>	<p>Timing diagram for Stop Key Terminal Mode (Active: Setting 1 or 3). The signals are: FWD (high), STOP (pulse), OUTPUT (ramp up), and ALARM (ER6 pulse).</p>
STOP KEY NETWORK MODE	<p>Timing diagram for Stop Key Network Mode (Inactive: Setting 2 or 4). The signals are: NETWORK (LE-CM) (high), FWD (TERMINAL) (high), STOP (pulse), OUTPUT (ramp up), and ALARM (low).</p>	<p>Timing diagram for Stop Key Network Mode (Active: Setting 1 or 3). The signals are: NETWORK (LE-CM) (high), FWD (TERMINAL) (high), STOP (pulse), OUTPUT (ramp up), and ALARM (ER6 pulse).</p>

Frequency Setting Block Diagram

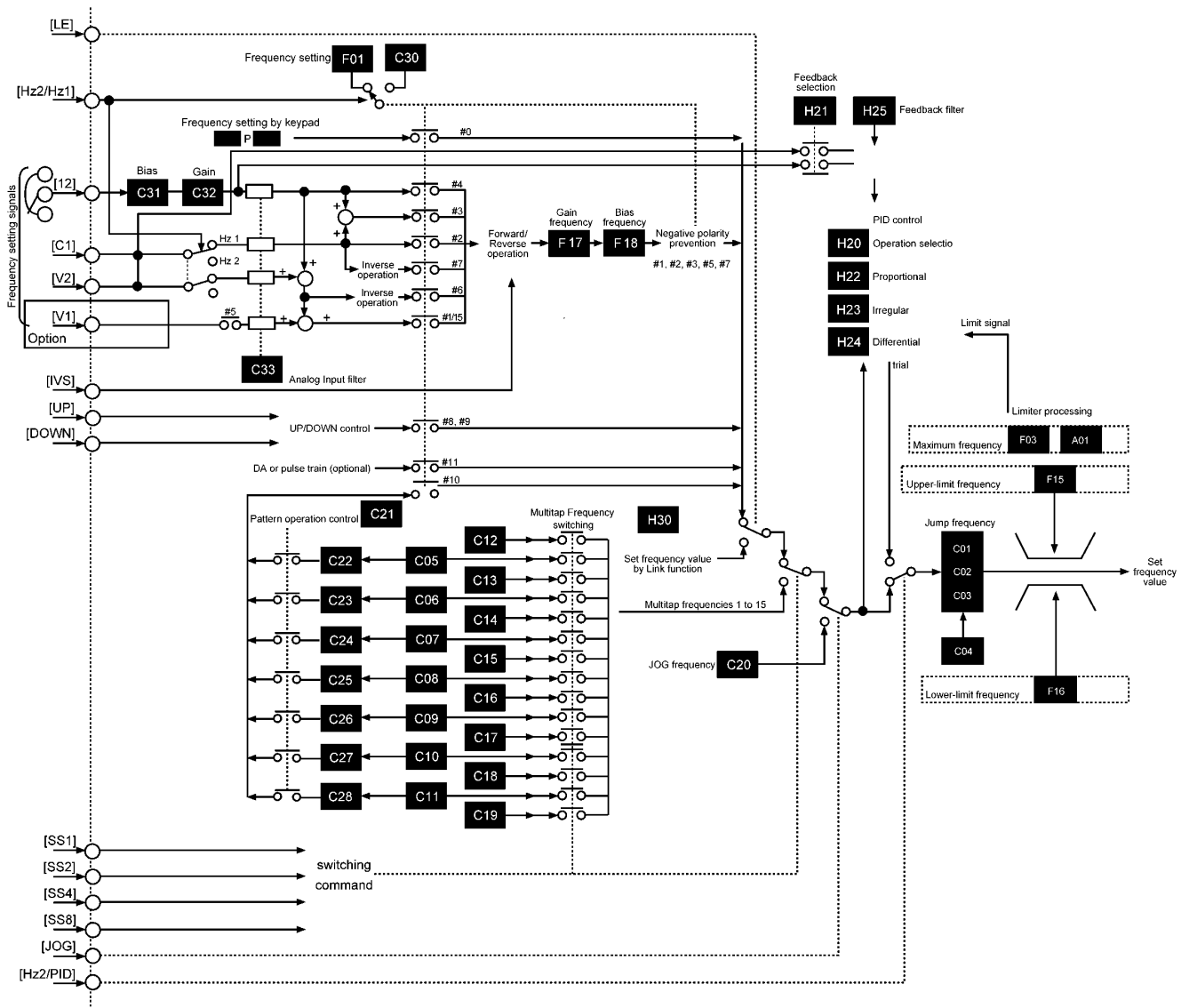

F03 Maximum output frequency 1

F 0 3 M A X H z - 1

Setting range 50 to 120 Hz

This function sets the maximum output frequency for Motor 1.

Setting a value higher than the rated value of the device to be driven may damage the motor or machine. Match the device rating when setting this function.

F04 Base frequency 1

F 0 4 B A S E H z - 1

Setting range 25 to 120Hz

This function sets the maximum output frequency in the constant torque range of Motor 1 or the output frequency at the rated output voltage. Match the motor rating.

Note: If the value of Base frequency 1 is set higher than that of Maximum output frequency 1, the output voltage does not increase to the rated voltage. The maximum frequency limits the output frequency.

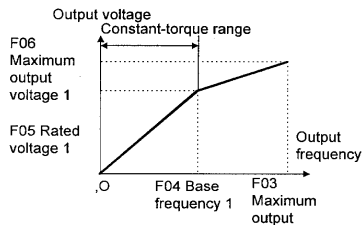

F05 Rated voltage 1

F 0 5 R A T E D V - 1

Setting range 230V AC series: 0, 80 to 240V
460 V series: 0, 320 to 480V

This function sets the rated value of the voltage output to Motor 1. Note that a voltage greater than the supply (input) voltage cannot be output.

Value 0 terminates operation of the voltage regulator function, thereby resulting in the output of a voltage proportional to the supply voltage.

Note: If the value of Rated voltage 1 is set higher than Maximum output voltage 1, the output voltage does not increase to the rated voltage. The maximum output voltage limits the output voltage.

F06 Maximum output voltage 1

F 0 6 M A X V - 1

Setting range 230 V AC series: 80 to 240 VAC
460 VAC series: 320 to 480 VAC

This function sets the maximum value of the voltage output for Motor 1. Note that a voltage higher than the supply (input) voltage cannot be output.

F07 Acceleration time 1

F08 Deceleration time 1

F 0 7 A C C T I M E 1
F 0 8 D E C T I M E 1

Setting range ACC TIME1: 0.01 to 3,600 seconds
DEC TIME1: 0.01 to 3,600 seconds

These functions set the acceleration time for the output frequency from startup to maximum frequency, as well as the deceleration time from maximum frequency to operation stop.

Acceleration and deceleration times are represented by the three most significant (high-order) digits.

Set acceleration and deceleration times with respect to maximum frequency. The relationship between the set frequency value and acceleration/deceleration times is as follows:

Set frequency = maximum frequency

The actual operation time matches the set value.

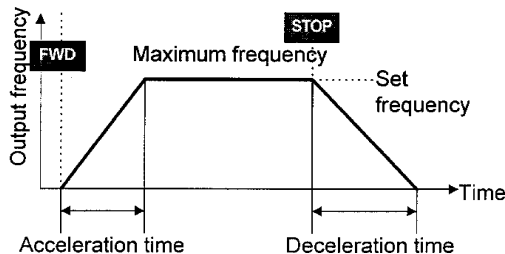

Set frequency < maximum frequency

The actual operation time differs from the set value.

Acceleration * deceleration operation time = set value x (set frequency / maximum frequency)

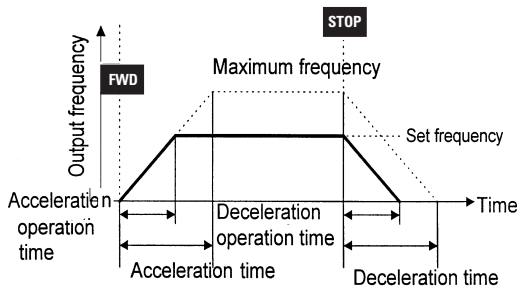

Note: If the set acceleration and deceleration times are set too low, even though the resistance torque and moment of inertia of the load are great, if the torque limiting functions or stall prevention function are activated, it prolongs the operation time beyond the set value.

F09 Torque Boost 1

F09TRQB00ST1

This is a Motor 1 function. The following can be selected:

Selection of load characteristics such as automatic torque boost, square law reduction torque load, proportional torque load, constant torque load.

Enhancement of torque (V/f characteristics), which is lowered during low-speed operation. Insufficient magnetic flux of the motor due to a voltage drop in the low-frequency range can be compensated.

Setting Range	Characteristics Selected
0.0	Automatic torque boost, where the torque boost value of a constant torque load (a linear change) is automatically adjusted.
0.1 to 0.9	Square law reduction torque for fan and pump loads
1.0 to 1.9	Proportional torque for middle class loads between square law reduction torque and constant torque (linear change)
2.0 to 20.0	Constant torque (linear change)

Torque characteristics

< Square law reduction torque >

Output voltage V

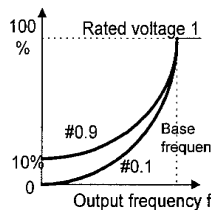

< Proportional torque >

Output voltage V

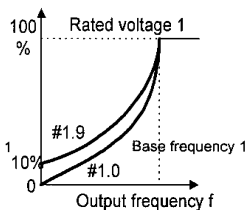

< Constant torque >

Since a large torque boost value creates over-excitation in the low-speed range, continued operation may cause the motor to overheat. Check the characteristics of the driven motor.

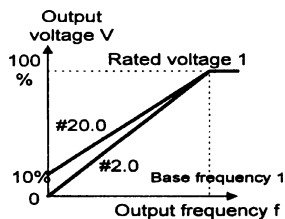

F10 Electric thermal O/L relay (operation selection)

F11 Electric thermal O/L relay (level)

F12 Electric thermal O/L relay (thermal time)

The electronic thermal O/L relay manages the output frequency, output current, and operation time of the inverter to prevent the motor from overheating when 150% of the set current value flows for the time set by F12 (thermal time constant).

F10ELCTRNO/L1

Setting range 0: Inactive
1: Active (for general-purpose motor)
2: Active (for forced air motor)

This function specifies whether to operate the electronic thermal O/L relay and selects the target motor. When a general-purpose motor is selected, the operation level is lowered in the low speed range according to the cooling characteristics of the motor.

F11OLLEVEL1

The setting range is 20 to 135% of the rated drive current.

This function sets the operation level current for the electronic thermal O/L relay. Enter a value from 1 to 1.1 times the rated motor current value.

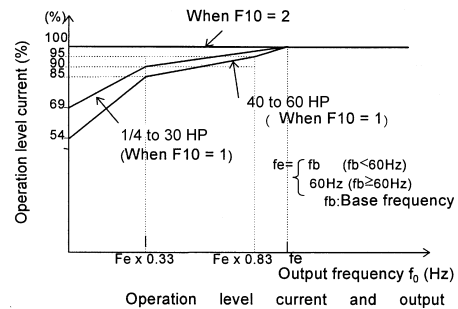

F12TIMECNST1

The setting range is 0.5 to 75.0 minutes (in 0.1 minute increments).

The time from when 150% of the operation level current flows continuously to when the electronic thermal O/L relay activates can be set with this function.

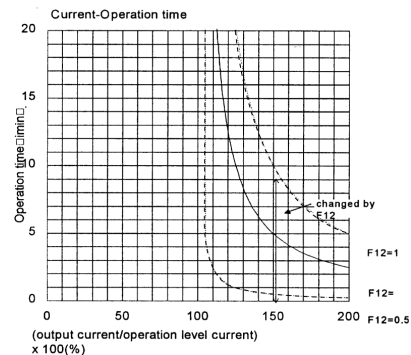

F13 Electric thermal O/L relay (for braking)

F13DBRO/L

This function controls the frequent use and continuous operating time of the braking resistor to prevent the resistor from overheating.

Drive Capacity	Operation
15 Hp or less	0: Inactive 1: Inactive 2: Active (external braking resistor)
20 Hp or more	0: Inactive

F14 Restart after momentary power failure (operation selection)

F 1 4 R E S T A R T

Setting range: 0 to 5

The following table lists the function details.

This function selects operation if a momentary power failure occurs.

The function for detecting power failure and activating protective operation (i.e., alarm output, alarm display, drive output cutoff) for undervoltage can be selected. The automatic restart function (for automatically restarting a coasting motor without stopping) when the supply voltage is recovered can also be selected.

Set Value	Function Name	Operation at Power Failure	Operation at Power Recovery
0	Inactive (intermediate drive trip)	If undervoltage is detected, the drive will immediately trip and an undervoltage fault (LU) is displayed. The drive output stops and the motor will coast to a stop.	The drive operation is not automatically restarted. Input a reset command and operation command to restart.
1	Inactive (drive trip at recovery)	If undervoltage is detected, the drive output stops and the motor will immediately coast to a stop. A drive fault is not activated.	An undervoltage fault (LU) is activated at power recovery. Drive operation is not automatically restarted. Input a reset command to restart operation.
2	Inactive (drive trip after deceleration to a stop at power failure)	When the DC bus voltage reaches the operation voltage level (H15), a controlled deceleration to a stop occurs. The drive collects the inertial energy of the load to maintain the DC bus voltage and controls the motor until it stops, then an undervoltage fault (LU) is activated. The drive will automatically decrease the deceleration time if necessary. If the amount of inertial energy from the load is small, and the undervoltage level is achieved before the motor stops, the undervoltage fault is immediately activated and the motor will coast to a stop.	The drive operation is not automatically restarted. Input a reset command and operation command to restart operation.
3	Active (operation ride-through; for high-inertia loads)	When the DC bus voltage reaches the operation voltage level (H15), energy is collected from the inertia of the load to maintain the DC bus voltage and extend the ride-through time. The drive will automatically adjust the deceleration rate to maintain DC bus voltage level. If undervoltage is detected, the protective function is not activated, but drive output stops and the motor coast to a stop.	Operation is automatically restarted. For power recovery during ride-through, the drive will accelerate directly to the original frequency. If undervoltage is detected, operation automatically restarts with the frequency selected at the time that the undervoltage was detected.
4	Active (restart with the frequency at the time of power failure)	If undervoltage is detected, the protective function is not activated. The drive output stops and the motor will coast to a stop.	Operation is automatically restarted with the frequency selected at the time of power failure.
5	Active (restart with start frequency; for low-inertia loads)	If undervoltage is detected, the protective function is not activated, but drive output stops.	Operation is automatically restarted with the frequency set by F23, "Starting frequency".

Note: Function codes H13 to H16 are provided to control a restart operation after momentary power failure. These functions should be understood and used. The pick-up (**speed search**) function can also be selected as a method of restarting when power is recovered after a momentary failure. (For setting details, see function code H09.) The pick-up function searches for the speed of the coasting motor to restart the motor without subjecting it to excessive shock.

In a high-inertia system, the reduction in motor speed is minimal even when the motor is coasting. A speed search time is required when the pick-up function is active. In such a case, the original frequency may be recovered sooner when the function is inactive and the operation is restarted with the frequency prior to the momentary power failure.

The pick-up function works in the range of 5 to 120 Hz. If the detected speed is outside this range, restart the motor using the regular restart function.

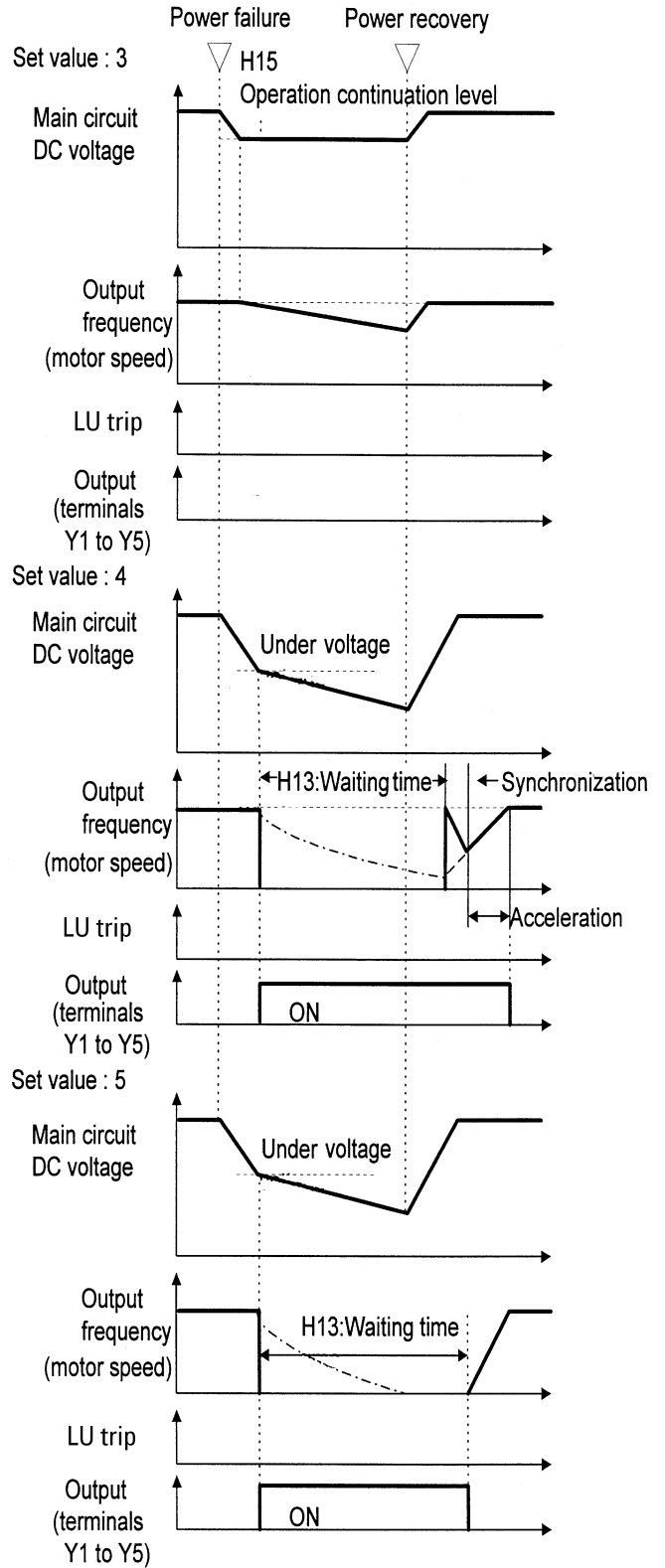
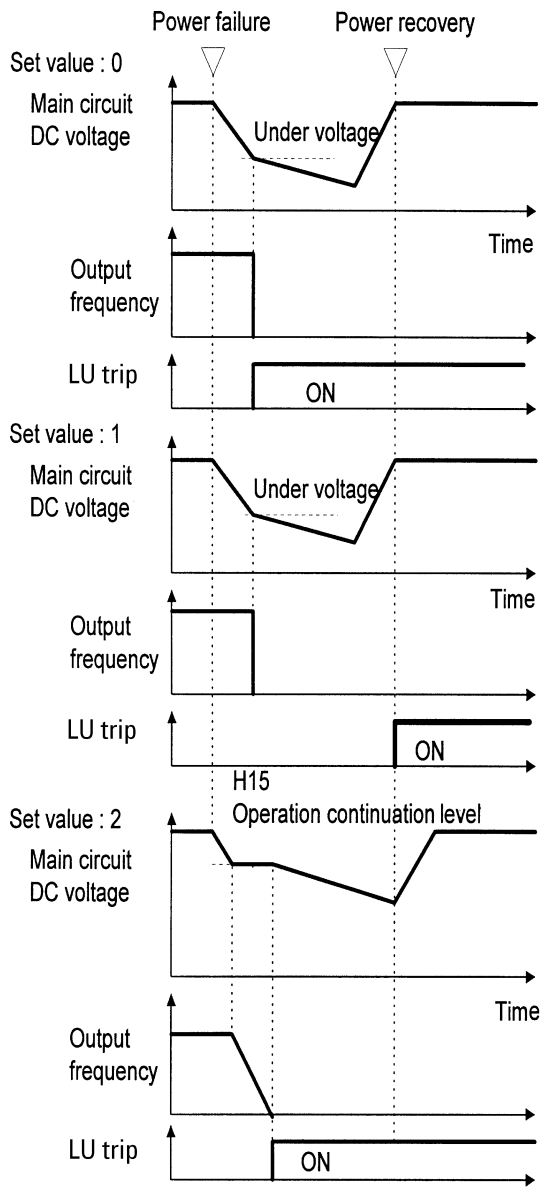

Note : Dotted-dashed lines indicate motor speed.

F15 Frequency limiter (High)

F16 Frequency limiter (Low)

F 1 5 H L I M I T E R
F 1 6 L L I M I T E R

Setting range 0 to 120 Hz

These functions are used to define the upper and lower limits of the set frequency.

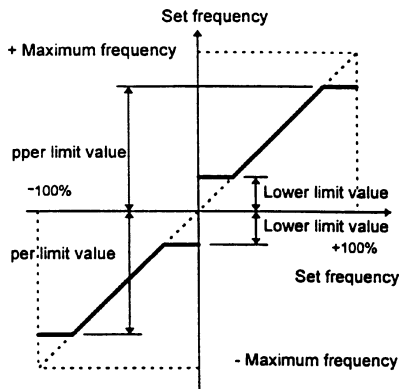

The drive output starts with the start frequency when operation begins, and stops with the stop frequency when operation ends.

If the upper limit value is less than the lower limit value, the upper limit value overrides the lower limit value.

F17 Gain

F 1 7 F R E Q G A I N

Setting range: 0.0 to 200.0%

This function assigns the rate of the set frequency value to analog input.

Operation follows the figure below.

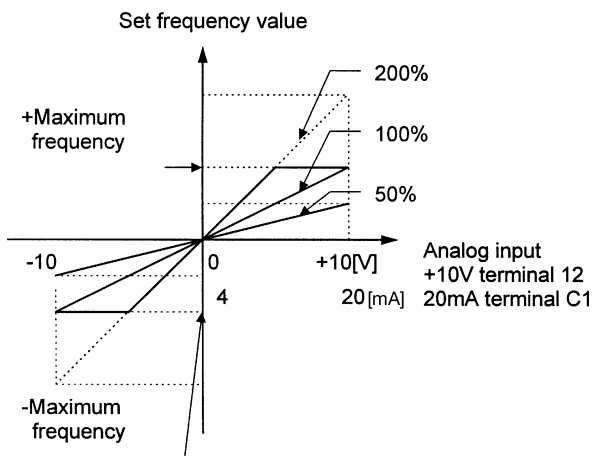

F18 Bias frequency

F 1 8 F R E Q B I A S

Setting range: -120.0 to 120.0 Hz

This function adds a bias frequency to the set frequency value from analog input.

The operation follows the figure below. If the bias frequency is higher than the +Maximum frequency or lower than the -Maximum frequency, it is limited to the +Maximum or -Maximum frequency.

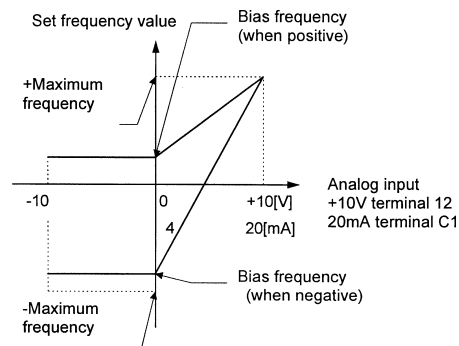

F20 DC injection Brake (starting)

F21 DC injection brake (operation level)

F22 DC injection brake (time)

F 2 0 D C B R K H z

Setting range: 0 to 60 Hz

Starting frequency: This function sets the frequency with which to start a DC injection brake in order to decelerate the motor to a stop.

F 2 1 D C B R K L V L

Setting range: 0 to 80%

Operation level: This function sets the output current level, when a DC injection brake is applied, as a percentage of the rated output current in 1% increments.

F 2 2 D C B R K t

Setting range: 0.0: Inactive

0.1 to 30.0 seconds

Time: This function sets the time for a DC injection brake operation.

CAUTION

Do not use the drive brake function for mechanical holding. **Injury may result.**

F23 Starting frequency (frequency)

F24 Start frequency (Holding time)

F25 Stop frequency

F 2 3 S T A R T H z

Setting range: 0.1 to 60 Hz

Frequency: This function sets the frequency at startup.

The starting frequency can be set to reserve the torque at startup and can be sustained until the magnetic flux of the motor is established.

F 2 4 H O L D I N G t

Setting range: 0.1 to 10.0 seconds

Holding time: This function sets the holding time during which the start frequency is sustained at startup.

- The holding time does not apply during switching between forward and reverse.
- The holding time is not included in the acceleration time.
- The holding time also applies when pattern operation (C21) is selected. The holding time is included in the timer value.

F 2 5 S T O P H z

Setting range: 0.1 to 6.0 Hz

This function sets the frequency at stop.

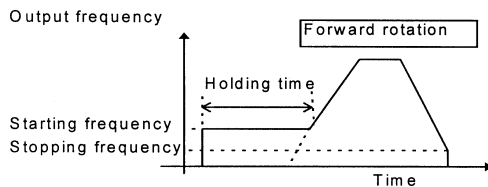

The operation will not start if the starting frequency is less than the stopping frequency or if the set frequency is less than the stopping frequency.

F26 Motor sound (carrier frequency)

F 2 6 M T R S O U N D

This function adjusts the carrier frequency to prevent resonance with the machine system, reduce motor and drive noise, and also reduce leakage current from output circuit wiring.

Drive Capacity	Setting Range
30 Hp or less	0.75 to 15kHz
40 to 100 Hp	0.75 to 10kHz
100 Hp or more	0.75 to 6kHz

Carrier frequency	Low — High
Motor noise	High — Low
Output current waveform	Bad — Good
Leakage current	Small amount — Large amount
Noise occurrence (RFI)	Extremely low — High

1. Reducing the set value adversely affects the output current waveform (i.e., higher harmonics), increases motor loss, and raises motor temperature. For example, at 0.75 kHz, reduce the motor torque by about 15%.
2. Increasing the set value increases drive losses and raises drive temperature.

F27 Motor sound (sound tone)

F 2 7 M T R T O N E

Setting range: 0, 1, 2, 3

The tone of motor noise can be altered if the carrier frequency is 7 kHz or lower. Use this function as required.

F30 FMA terminal (voltage adjustment)

F31 FMA terminal (function selection)

F 3 0 F M A V - A D J

Setting range: 0 to 200%

Monitor data (e.g., output frequency, output current) can be output to terminal FMA as a DC voltage. The amplitude of the output can also be adjusted.

This function adjusts the voltage value of the monitor item selected in F31 when the monitor amount is 100%. A value from 0 to 200% can be set in 1% increments.

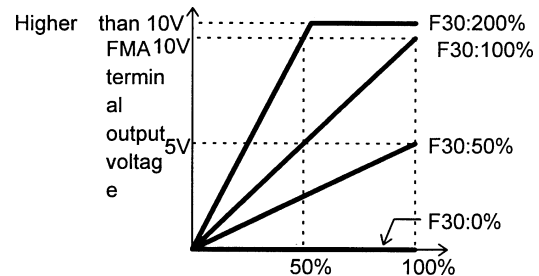

F 3 1 F M A F U N C

This function selects the monitor item to be output to Terminal FMA.

Value	Monitor Item	100% Monitor Amount
0	Output frequency 1 (before slip compensation)	Maximum output frequency
1	Output frequency 2 (after slip compensation)	Maximum output frequency
2	Output current	2x rated output current of drive
3	Output voltage	230V series: 250V 460V series: 500V
4	Output torque	2x rated motor torque
5	Load rate	2x rated load of motor
6	Output	2x rated drive output
7	PID feedback amount	Feedback amount at 100%
8	PG feedback amount (only when option is installed)	Synchronous speed at maximum frequency
9	DC link circuit voltage	230V series: 500V 460V series: 1,000V
10	Universal AO	Output from RS485 or Bus option

F33 FMP terminal (pulse rate)

F34 FMP terminal (voltage adjustment)

F35 FMP terminal (function selection)

Monitor data (e.g., output frequency, output current) can be output to terminal FMP as pulse voltage. Monitor data can also be sent to an analog meter as average voltage.

When sending data to a digital counter or other instrument as pulse output, set the pulse rate in F33 to any value and the voltage in F34 to 0%.

When data is sent to an analog meter or other instrument as average voltage, the voltage value set in F34 determines the average voltage, and F33 is fixed at 2670 (p/s).

F 3 3 F M P P L U S E S

Setting range 300 to 6,000 p/s, in 1 p/s increments

The F33 function sets the pulse frequency of the monitor item selected in F35.

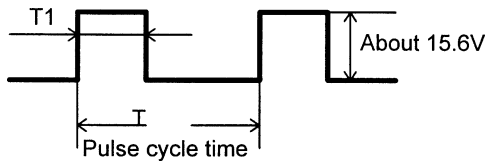

$$\text{Pulse frequency (p/s)} = 1/T$$

$$\text{Duty (\%)} = T1/T \times 100$$

$$\text{Average voltage (V)} = 15.6 \times T1/T$$

F 3 4 F M P V - A D J

Set value 0%: The pulse frequency varies depending on the amount of the monitor item selected in F35 (max. value is the value set in F33).

The F34 function sets the average voltage of pulse output to terminal FMP.

1 to 200%: Pulse frequency is fixed at 2,670 p/s. The average voltage of the monitor item selected in F35, when the monitor amount is 100%, is adjusted in the range 1 - 200%, in 1% increments (pulse duty varies).

F 3 5 F M P F U N C

The F35 function selects the monitor item to be output to terminal FMP.

The set value and monitor items are the same as those used for F31 (refer to table).

F36 30Ry operation mode

F 3 6 3 0 R Y M O D E

This function specifies whether to activate (excite) the alarm output relay (30Ry) for any fault at normal or alarm status.

Value	Operation	
0	Drive no power	30A - 30C: OFF, 30B - 30C: ON
	At normal	30A - 30C: OFF, 30B - 30C: ON
	At alarm	30A - 30C: ON, 30B - 30C: OFF
1	Drive no power	30A - 30C: OFF, 30B - 30C: ON
	At normal	30A - 30C: ON, 30B - 30C: OFF
	At alarm	30A - 30C: OFF, 30B - 30C: ON

If the set value is 1, contacts 30A and 30C are connected when the drive control voltage is established (about one second after power on).

F40 Torque limit 1 (drive)

F41 Torque limit 1 (brake)

F 4 0 D R V T R Q I

F 4 1 B R K T R Q I

The torque limit operation calculates motor torque from the output voltage, current and the primary resistance value of the motor, and controls the frequency so the calculated value does not exceed the limit. This operation enables the drive to continue operation under the limit even if a sudden change in load torque occurs.

Limits are set for driving torque and braking torque.

When this function is activated, acceleration and deceleration operation times are longer than the set values.

Function	Set Value	Operation
Torque limit (driving)	20% to 150%	The torque is limited to the set value.
	999	Torque limiting inactive
Torque limit (braking)	20% to 150%	The torque is limited to the set value.
	0	Automatically prevents OU2 trip due to power regeneration effect
	999	Torque limiting inactive

WARNING

When the torque limit function is selected, an operation may not match the set acceleration and deceleration time or set speed. The machine should be so designed that safety is ensured even when operation does not match the set values.

F42 Torque vector control 1

F 4 2 T R Q V E C T O R 1

To obtain the most efficient motor torque, the torque vector control calculates torque according to load, to adjust the voltage and current vectors to optimum values based on the calculated value.

Value	Operation
0	inactive
1	active

Related Functions P01 to P09

If F42 = 1 (active), the following functions are affected:

1. F09 Torque boost 1 is automatically set to 0.0 (automatic torque boosting).
2. P09 Slip compensation control is automatically activated. If set to 0.0, the amount of slip compensation for a standard 3-phase Fuji motor is applied. Otherwise, the set value is applied.

Use the torque vector control function under the following conditions:

1. There can only be one motor.
Connection of two or more motors makes accurate control difficult.
2. The function data (rated current P03, no-load current P06,, %R1 P07, and %X P08) for Motor 1 must be correct.
An auto-tuning operation should be performed for other motors.
3. The rated current of the motor must not be significantly less than the rated current of the drive. A motor two sizes lower in capacity than the nominal motor indicated for the drive is the smallest that should be used.
4. To prevent leakage current and ensure accurate control,, the length of the cable between the drive and motor should not exceed 50 m.
5. If a reactor is connected between the drive and the motor and wiring impedance cannot be disregarded, use P04 Auto tuning to reset data.

If these conditions are not satisfied, set F42 = 0 (Inactive).

E: Extension Terminal Functions

E01 Terminal X1

E09 Terminal X9

E	0	1	X	1	F	U	N	C			
E	0	2	X	2	F	U	N	C			
E	0	3	X	3	F	U	N	C			
E	0	4	X	4	F	U	N	C			
E	0	5	X	5	F	U	N	C			
E	0	6	X	6	F	U	N	C			
E	0	7	X	7	F	U	N	C			
E	0	8	X	8	F	U	N	C			
E	0	9	X	9	F	U	N	C			

Functions can be individually set from each of the digital input terminals X1 to X9.

Value	Function
0,1,2,3	Multi-step frequency selection (1 to 15 steps)
4,5	Acceleration and deceleration time selection (3 steps)
6	Self-hold selection (HLD)
7	Coast-to-stop command (BX)
8	Alarm reset (RST)
9	External alarm (THR)
10	Jogging (JOG)
11	Frequency setting 2 / Frequency setting 1 (Hz 2 / Hz1)
12	Motor 2 / Motor 1 (M2 / M1)
13	DC injection brake command (DCBRK)
14	Torque limit 2 / Torque limit 1 (TL2 / TL1)
15	Switching operation from line to drive (50 Hz) (SW50)
16	Switching operation from line to drive (60 Hz) (SW60)
17	UP command (UP)
18	DOWN command (DOWN)
19	Edit permission command (WE-KP)
20	PID control cancellation (Hz / PID)
21	Normal/Inverse switching (Terminals 12 and C1) (IVS)
22	Interlock (52-2) (IL)
23	Torque control cancellation (Hz/TRQ)
24	Link communication selection (LE)
25	Universal DI (U-DI)
26	Pick up start mode (STM)
30	Timed alarm stop command (STOP1)
31	Timed alarm stop command with Deceleration time 4 (STOP2)

Note: Values which are not set in the functions from E01 to E09 are assumed to be inactive.

Multi-step frequency selection

Value 0, 1, 2, 3: The frequency can be switched to a preset frequency in function codes C05 to C19 by switching the external digital input signal. Assign values 0 to 3 to the target digital input terminal. The combination of input signals determines the frequency.

Combination of Input Signals				Selected Frequency	Related Functions: C05-C19
3 (SS8)	2 (SS4)	1 (SS2)	0 (SS1)		
off	off	off	on	C05 MULTI Hz-1	Setting Range 0.00 to -400.00 Hz
off	off	on	off	C06 MULTI Hz-2	
off	off	on	on	C07 MULTI Hz-3	
off	on	off	off	C08 MULTI Hz-4	
off	on	off	on	C09 MULTI Hz-5	
off	on	on	off	C10 MULTI Hz-6	
off	on	on	on	C11 MULTI Hz-7	
on	off	off	off	C12 MULTI Hz-8	
on	off	off	on	C13 MULTI Hz-9	
on	off	on	off	C14 MULTI Hz-10	
on	off	on	on	C15 MULTI Hz-11	
on	on	off	off	C16 MULTI Hz-12	
on	on	off	on	C17 MULTI Hz-13	
on	on	on	off	C18 MULTI Hz-14	
on	on	on	on	C19 MULTI Hz-15	

Acceleration and Deceleration time selection

Value 4, 5: The acceleration and deceleration time can be switched to a preset time in function codes E10 to E15 by switching the external digital input signal. Assign values 4 and 5 to the target digital input terminal. The combination of input signals determines the acceleration and deceleration times.

Combination of Input Signals		Selected Acceleration / Deceleration Times	Related Functions E10-E15
5 (RT2)	4 (RT1)		
off	off	F07 ACC TIME1 F08 DEC TIME1	Setting Range 0.01 to 3600s
off	on	E10 ACC TIME2 E11 DEC TIME2	
on	off	E12 ACC TIME3 E13 DEC TIME3	
on	on	E14 ACC TIME4 E15 DEC TIME4	

Self-hold selection (HLD)

Value 6: This selection is used for 3-wire operation. The FWD or REV signal is self-held when HLD-CM is on, and this self-hold is cleared when HLD-CM is turned off. To use this HLD terminal function, assign 6 to the target digital input terminal.

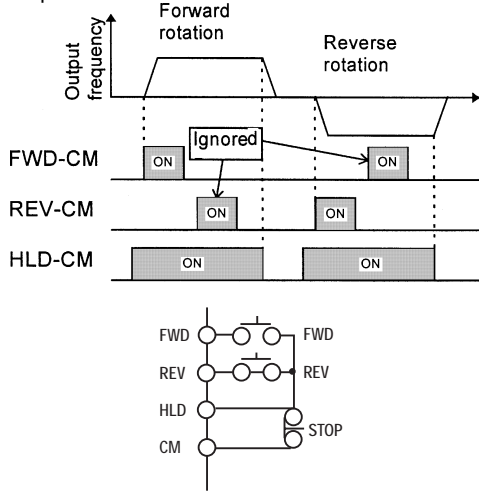

Coast-to-stop command (BX)

Value 7: When BX and CM are connected, drive output is cut off immediately, and the motor starts to coast to a stop. An alarm signal is neither output nor self-held. If BX and CM are disconnected when the operation command (FWD or REV) is on, operation begins at the start frequency. To use this BX terminal function, assign value 7 to the target digital input terminal.

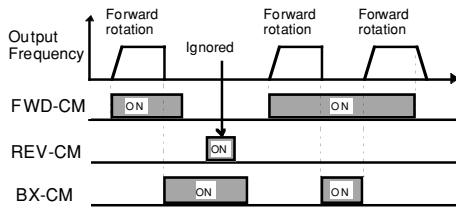

Alarm reset (RST)

Value 8: If a drive trip occurs, connecting RST to CM clears the alarm output (for any fault). Disconnecting them clears the trip indication and restarts operation. To use this RST terminal function, assign value 8 to the target digital input terminal.

External alarm (THR)

Value 9: Disconnecting THR and CM during operation cuts off drive output (i.e., motor starts to coast to a stop) and outputs alarm OH2, which is self-held internally and cleared by RST input. This function is used to protect an external brake resistor and other components from overheating. To use this THR terminal function, assign value 9 to the target digital input terminal. ON input is assumed if this terminal function is not set.

Jogging (JOG)

Value 10: This function is used for jogging operation to position a workpiece. When JOG and CM are connected, the

operation is performed with the jogging frequency set in function code C20 while the operation command (FWD-CM or REV-CM) is on. To use this JOG terminal function, assign 10 to the target digital input terminal.

Frequency setting 2/frequency setting 1

Value 11: This function switches the frequency setting method defined by function codes F01 and C30 using an external digital input signal.

Input Signal	Selected Frequency Setting
11	
off	F01 FREQ CMD1
on	C30 FREQ CMD2

Motor 2/Motor 1

Value 12: This function switches motor constants using an external digital input signal.

This input is effective only when the operation command to the drive is off and operation has stopped and does not apply to the operation at 0Hz.

Input Signal	Selected Motor
12	
off	Motor 1
on	Motor 2
Related Functions: A01-A18	

DC injection brake command (DCBRK)

Value 13: This function is used for DC Brake time control by digital input including extending braking operation during stopping as well as during start up into a rotating load. When the external digital input signal is on, DC injection braking starts when the drive's output frequency drops below the frequency preset in function code F20 after the operation command goes off. (The operation command goes off when the STOP key is pressed during keypad panel operation or when both terminals FWD and REV go off during terminal block operation.) The DC injection braking continues while the digital input signal is on. In this case, the longer of the following times is selected:

- The time set with function code F22
- The time during which the input signal is set ON

Input Signal	Selected Operation
13	
off	DC injection brake command not given
on	DC injection brake command given

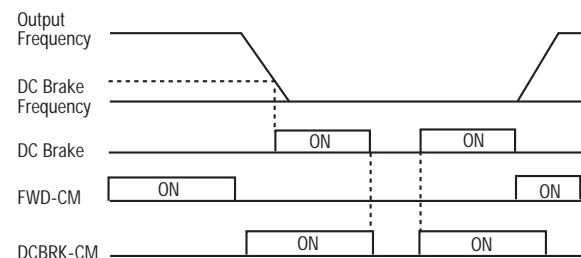

Torque limit 2/torque limit 1

Value 14: Frequency setting 2/frequency setting 1. This function switches the torque limit value set with function codes F40, F41, E16, and E17, using an external digital input signal.

Input Signal	Selected Torque Limit Value	
14		
off	F40 DRV TRQ1 F41 BRK TRQ1	Related Functions F40-F41, E16-E17
on	E16 DRV TRQ2 E17 DRV TRQ2	Setting Range DRV 20 to 200% ,999 BRK0, 20 to 200% ,999

Switching operation from line drive (60Hz)(SW60)/(50Hz)(SW50)

Value 15, 16: Motor operation can be switched from 60 Hz/50 Hz commercial power to drive operation without stopping the motor by switching the external digital input signal.

Input Signal	Function
16	
off → on	Drive operation to line operation (60 Hz)/(50 Hz)
on → off	Line operation to drive operation (60 Hz)/(50 Hz)

Following a momentary power failure, if the digital input signal goes off, 50 or 60 Hz (according to the input signal) is output after the restart waiting time (function code H13). The motor is then directed to drive operation.

UP command (UP)/DOWN command (DOWN)

Value 17, 18: When an operation command is input (on), the output frequency can be increased or decreased using an external digital input signal.

The change ranges from 0 to maximum frequency. Operation in the opposite direction, of the operation command is not allowed.

Combination of Input Signals		Selected Function (when operation command is on)
18	17	
off	off	Holds the output frequency
off	on	Increases the output frequency according to the acceleration time
on	off	Decreases the output frequency according to the deceleration time
on	on	Holds the output frequency

There are the two types of UP/DOWN operations as shown below. Select the desired type by setting the frequency (F01 or C30).

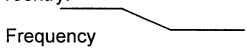
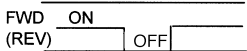
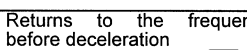
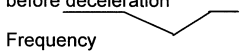
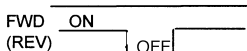
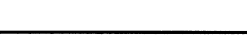
Frequency setting (F01 or C30)	Initial value at power input on	Operation command reentry during deceleration
8 (UP/DOWN1)	0Hz	Operates at the frequency at reentry. Frequency  FWD ON  (REV) OFF 
9 (UP/DOWN2)	Previous frequency	Returns to the frequency before deceleration Frequency  FWD ON  (REV) OFF 

Edit permission command (data change permission)(WE-KP) (data protection)

Value 19: This function allows the data to be changed only when input is received from an external signal, thereby preventing function code data changes.

19	Selected Function
off	Prohibit data changes
on	Allow data changes

Note: If a terminal is assigned the value 19, the data cannot be changed. To change data, turn the terminal on and change its setting to another number.

PID control cancellation (Hz/PID)

Value 20: The PID control can be disabled by an external digital input signal.

Input Signal	Selected Function
20	[Related Functions: H20-H25]
off	Enable PID control
on	Disable PID control

(When the PID control is disabled, the frequency is set from keypad panel)

Normal operation/inverse

Value 21: Analog input (Terminals 12 and C1) can be switched between normal and inverse operations using an external digital input signal.

Input Signal	Selected Function
21	[Related Function: F01]
off	Normal operation if normal operation is set and vice versa
on	Inverse operation if normal operation is set and vice versa

Interlock (52-2)

Value 22: When a contactor is installed on the output side of the drive, the contactor opens at the time of a momentary power failure. This prevents the reduction of the DC circuit voltage and may prevent the detection of a power failure and a correct restart operation after power is recovered. The restart operation, in the event of a momentary power failure, can be performed effectively with power failure information provided by an external digital input signal.

Input Signal	Function
22	
off	No momentary power failure detection by digital input
on	Momentary power failure detection by digital input

Torque control cancellation (Hz/TRQ)

Value 23: If function code **H18 Torque control** is set to active (value = 1 or 2), this operation can be cancelled externally by assigning 23 to the target digital input terminal and switching between active and inactive for this input signal.

Input Signal	Selected Function [Related Function: H18]
23	
off	Torque control function active – the input voltage to Terminal 12 is the torque command value
on	Torque control function inactive - the input voltage to Terminal 12 is the frequency command value. PID feedback amount when PID control operation is selected (H20 = 1 or 2).

Link Operation selection (LE)

Value 24: Frequency and operation commands from the data communications link can be enabled or disabled by switching the external digital input signal. Select the command source in **H30-Link function** and assign 24 to the target digital input terminal to enable or disable commands in this input signal state.

Input Signal	Selected Function [Related Function: H30]
24	
off	Link command disabled
on	Link command enabled

Universal DI (U-DI)

Value 25: Assigning 25 to a digital input terminal renders the terminal a universal DI terminal. The ON/OFF state of signal input to this terminal can be checked through the RS485 and BUS option.

This input terminal is only used to check for an incoming input signal through communication and does not affect drive operation.

Pick up start mode (STM)

Value 26: The (pick-up start mode): in function code H09 can be enabled or disabled by switching the external digital input signal. Assign 26 to the target digital input terminal to enable or disable the function in this input signal state.

Input Signal	Selected Function [Related Function: H09]
26	
off	Start characteristic function disabled
on	Start characteristic function enabled

Timed alarm stop command (STOP1)

Timed alarm stop command with deceleration time 4 (STOP2)

Value 30, 31: Disconnecting STOP1 and CM during operation, the drive decelerates and stops by a present deceleration time (STOP1)/deceleration time 4 (STOP2) setting and then outputs alarm Er6 which is latched internally and cleared by RST input. ON input is assumed when this terminal function is not set.

Digital Input	Value	Factory Settings at Shipment Description
Terminal X1	0	Multi-step frequency selection (SS1)
Terminal X2	1	Multi-step frequency selection (SS2)
Terminal X3	2	Multi-step frequency selection (SS4)
Terminal X4	3	Multi-step frequency selection (SS8)
Terminal X5	4	Acceleration and deceleration selection (RT1)
Terminal X6	5	Acceleration and deceleration selection (RT2)
Terminal X7	6	Self-hold selection (HLD)
Terminal X8	7	Coast-to-stop command (BX)
Terminal X9	8	Alarm reset (RST)

E10 Acceleration time 2

E11 Deceleration time 2

E12 Acceleration time 3

E13 Deceleration time 3

E14 Acceleration time 4

E15 Deceleration time 4

E	1	0	A	C	C	T	I	M	E	2	2
E	1	1	D	A	C	C	T	I	M	E	3
E	1	2	A	C	C	T	I	M	E	3	3
E	1	3	D	E	C	C	T	I	M	E	4
E	1	4	A	C	C	T	I	M	E	4	4
E	1	5	D	E	C	T	I	M	E	4	4

Acceleration time1 (F07) and Deceleration time1 (F08), as well as three other acceleration and deceleration times, can be selected.

The operation and setting ranges are the same as those for Acceleration time1 and Deceleration time1. See explanations for F07 and F08.

For switching acceleration and deceleration times, select any two terminals (from Terminal X1 in E01 to Terminal X9 in E09) as switching signal input terminals. Set the selected terminals to 4 (acceleration and deceleration time1) and 5 (acceleration and deceleration time2) and input a signal to each terminal to switch acceleration and deceleration times. Switching is possible during acceleration, deceleration, or constant speed operation.

Example: When Terminals X2 and X3 are set to 4 and 5:

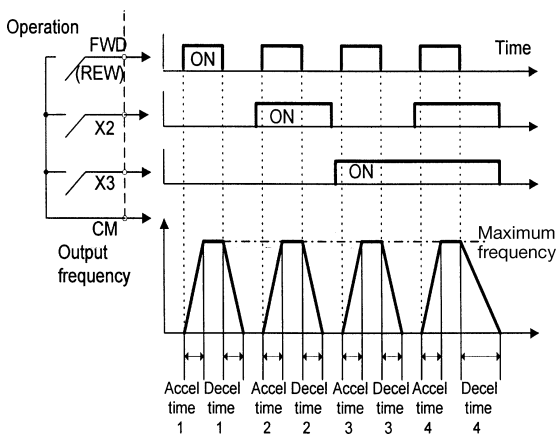

E16 Torque limit 2 (drive)

E17 Torque limit 2 (brake)

E	1	6	D	R	V	T	R	Q	2	2
E	1	7	B	R	K	T	R	Q	2	2

This function is used to switch the torque limit level set by F40 and F41, using an external control signal. Input an external signal by setting any of the digital input terminals (X1 to X9) to 14 for Torque limit 2 / Torque limit 1 in E01 to E09.

E20 Terminal Y1 (function selection)

E24 Terminals Y5A and Y5C (function selection)

E	2	0	Y	1	F	U	N	C			
E	2	1	Y	2	F	U	N	C			
E	2	2	Y	3	F	U	N	C			
E	2	3	Y	4	F	U	N	C			
E	2	4	Y	5	F	U	N	C			

Some control and monitor signals can be selected and output from terminals Y1 to Y5. Terminals Y1 to Y4 use transistor output; terminals Y5A and Y5C use relay contacts.

Value	Output Signal
0	Drive Running (RUN)
1	Frequency arrival (FAR)
2	Frequency detection (FDT1)
3	Stopping due to undervoltage (LV)
4	Torque polarity detection (B/D)
5	Torque limiting (TL)
6	Restart after momentary power failure (IPF)
7	Overload - early warning (OLI)
8	Keypad panel operation (KP)
9	Drive stopping (STP)
10	Ready for operation (RDY)
11	Switching between line and drive (SW88)
12	Switching between line and drive (SW52-2)
13	Switching between line and drive (SW52-1)
14	Motor 2 switching (SWM2)
15	Terminal AX function (AX)
16	Pattern operation stage change (TU)
17	Pattern operation cycle operation completed (TO)
18	Pattern operation stage number (STG1)
19	Pattern operation stage number (STG2)
20	Pattern operation stage number (STG4)
21	Alarm detail (AL1)
22	Alarm detail (AL2)
23	Alarm detail (AL4)
24	Alarm detail (AL8)
25	Cooling fan operating (FAN)
26	Retry function operating (TRY)
27	Universal DO (U-DO) *
28	Heat sink overheat - early warning (OH)
29	Synchronization completed by synchronous operation card (SY) *
30	unused
31	2nd Freq. level detection (FDT2)
32	2nd OL level early warning (OL2)
33	Terminal C1 off signal (C1OFF)

Note: For output signals marked *, refer to instruction manuals for RTU communication and the synchronous operation card.

Pattern operation cycle operation completed (T0)

Value 17: After the seven stages of a pattern operation have been completed, this function outputs a one-shot, 100 ms ON signal to report the completion of all stages.

Pattern operation stage number (STG1)(STG2)(STG4)

Value 18, 19, 20: During pattern operation, this function reports the stage (operation process) being operated.

Pattern Operation	Output Terminal		
	STG1	STG2	STG4
Stage No.			
Stage 1	on	off	off
Stage 2	off	on	off
Stage 3	on	on	off
Stage 4	off	off	on
Stage 5	on	off	on
Stage 6	off	on	on
Stage 7	on	on	on

When pattern operation is not activated (i.e., no stage has been selected), the terminals do not output a signal.

Alarm detail (AL1)(AL2)(AL4)(AL8)

Value 21, 22, 23, 24: This function reports the operating status of the drive protective function.

Alarm Detail (Drive Protective Function)	Output Terminal			
	AL1	AL2	AL4	AL8
Overcurrent, ground fault, blown fuse	on	off	off	off
Overvoltage	off	on	off	off
Undervoltage shortage, input phase failure	on	on	off	off
Motor 1 and Motor 2 overload	off	off	on	off
drive overload	on	off	on	off
Heat sink overheating, drive overheating internally	off	on	on	off
External alarm input, braking resistor overheating	on	on	on	off
Memory error, CPU error	off	off	off	on
Keypad panel communication error, option communication error	on	off	off	on
Option error	off	on	off	on
Output wiring error	off	off	on	on
RTU communication error	on	off	on	on
Overspeed, PG disconnection	off	on	on	on

Under normal operation, terminals do not output a signal

Cooling fan operating (FAN)

Value 25: When used with H06 Cooling fan ON/OFF control, this function outputs a signal while the cooling fan is operating.

Retry function operating (TRY)

Value 26: When H04 Retry operating is set to 1 or higher, the signal is output during the retry operation, if the drive protective function has been activated.

Universal DO(U-DO)

Value 27: Assigning a value of 27 to a transistor output terminal renders the terminal a universal DO terminal.

This function enables ON/OFF through the RS485 and BUS option.

This function serves only to turn the transistor output on or off through communication and is not related to drive operation.

Heat sink overheat early warning (OH)

Value 28: This function outputs an early warning signal when the heat sink temperature (overheat detection level) is within 10°C of the overtemp trip point.

2nd Freq. level detection (FDT2)

Value 31: This function sets the 2nd Freq. level detection. See the explanation of Function Code E36 and E37. Hysteresis width is same as FDT1 (E32).

2nd OL level early warning (OL2)

Value 32: This function sets the 2nd overload early warning. See the explanation of “overload early warning (OL)”, E37.

Terminal C1 off signal (C1OFF)

Value 33: This function outputs an ON signal, when the C1 current input is smaller than 2mA.

Y1-Y5 SETTINGS WHEN SHIPPED FROM THE FACTORY

Digital Output	Factory Setting at Shipment	
	Value	Description
Terminal Y1	0	Operating (RUN)
Terminal Y2	1	Frequency arrival (FAR)
Terminal Y3	2	Frequency detection (FDT)
Terminal Y4	7	Overload early warning (OL)
Terminal Y5	15	Terminal AX function (AX)

E25 Y5 Ry operation mode

E 2 5 Y 5 R Y M O D E

This function specifies whether to excite the Y5 relay at “ON signal mode” or “OFF signal mode”

Set Value	Operation
0	At “OFF signal mode” Y5A - Y5C: OFF At “ON signal mode” Y5A - Y5C: ON
1	At “OFF signal mode” Y5A - Y5C: ON At “ON signal mode” Y5A - Y5C: OFF

When the set value is 1, contacts Y5A and Y5C are connected when the drive control voltage is established (about one second after power on).

E30 Frequency arrival (detection width)

E 3 0 F A R H Y S T R

Setting range: 0.0 to 10.0 Hz

This function adjusts the detection width when the output frequency is the same as the set operating frequency. The detection width can be adjusted from 0 to ± 10 Hz of the setting frequency.

When the frequency is within the detection width, an ON signal can be selected and output from terminals [Y1] to [Y5]

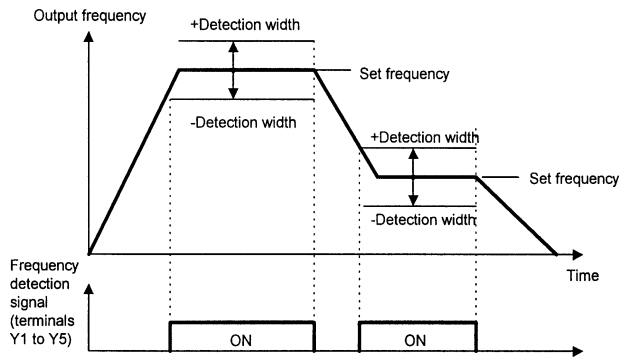

E31 Frequency detection (operation level)

E32 Frequency detection (hysteresis width)

E 3 1 F D T L E V E L
E 3 2 F D T H Y S T R

Setting range (Operation level): 0 to 120 Hz

These functions determine the operation level of the output frequency and hysteresis width for operation release. If the output frequency exceeds the set operation level, an ON signal can be output from terminals Y1 to Y5.

(Hysteresis width): 0.0 to 30.0 Hz

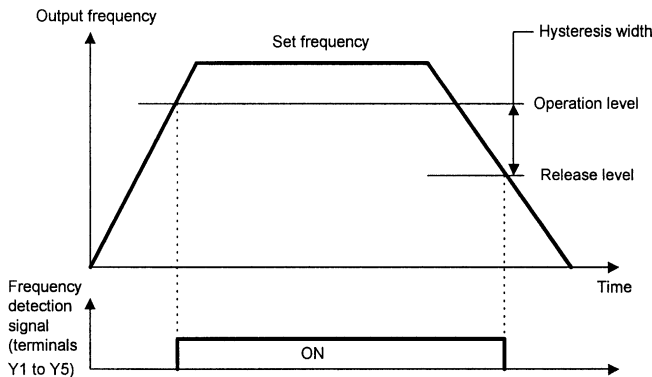

E33 Overload early warning (operation)

E 3 3 O L L E V E L

Setting range: 0: Electronic thermal O/L relay

Select one of the following two types of overload early warning: early warning by electronic thermal O/L relay function or early warning by output current.

1: Output current

Value	Function	Description
0	Electronic thermal O/L relay	Overload early warning by electronic thermal O/L relay (with inverse time characteristics) to output current. The operation selection and thermal time constant for the inverse time characteristics are the same as those of the electronic thermal O/L relay for motor protection (F10 and F12).
1	Output current	An overload early warning is issued when output current exceeds the set current value for the set time.

E34 Overload early warning (operation level)

E 3 4 O L 1 L E V E L

Setting range: Drive rated output current x (5 to 150%)

This function determines the operation level for the electronic thermal O/L relay or output current.

The operation release level is 90% of the set value.

E35 Overload early warning (operation time)

E 3 5 O L T I M E R

Setting range: 0.0 to 60.0 seconds

This function is used when E33 Overload early warning (operation selection) is set to 1.

Sets the time from when the operation level is attained until the overload early warning function is activated.

E36 Frequency detection 2 (operation level)

E 3 6 F D T 2 L E V E L

This function determines the operation (detection) level 2 of the output frequency for operation release. This function operates the same as "E31 Frequency detection 1 (operation level)". For details, see the explanation for E31.

E37 Overload early warning 2 (operation level)

E 3 7 O L 2 L E V E L

This function determines the operation level 2 of the output current. This function operates same as E33 output current and E35 setting.

E40 Display coefficient A

E41 Display coefficient B

E	4	0	C	O	E	F	A			
E	4	1	C	O	E	F	B			

Setting range:

Display coefficient A: -999.00 to 0.00 to +999.00

Display coefficient B: -999.00 to 0.00 to +999.00

These coefficients are conversion coefficients which are used to determine the load and line speed and the PID controller target value and feedback (process) amount displayed on the LED monitor.

Load and line speed

Use display coefficient A.

Displayed value = output frequency x (0.01 to 200.00)

Although the setting range is ± 999.00 , the effective range of display data is 0.01 to 200.00. Therefore, values smaller or larger than this range are limited to a minimum value of 0.01 or a maximum value of 200.00.

Target value and feedback amount of PID controller

Set the maximum value of display data in E40 Display coefficient A and the minimum value in E41 Display coefficient B.

Displayed value = (target value or feedback amount) x (Display coefficient A - B) + B

Displayed value

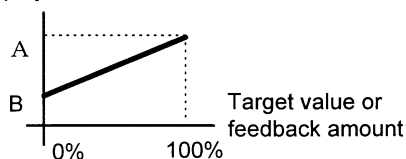

E42 Display filter

E	4	2	D	I	S	P	L	A	Y	F	L
---	---	---	---	---	---	---	---	---	---	---	---

Setting range: 0.0 to 5.0 seconds

Among data in E43 LED monitor (display selection), some data need not be displayed instantaneously when the data changes. For such data, a flicker suppression filter can be used.

Monitored items in E43 LED monitor (display selection)

Value	Display	Value	Display
3	Output current	8	Calculated torque value
4	Output voltage	9	Power consumption

E43 LED monitor (display selection)

E44 LED monitor (display at stopping)

E	4	3	L	E	D	M	N	T		
E	4	4	L	E	D	M	N	T	2	

The data during drive operation, stopping, at frequency setting, and at PID setting is displayed on the LED.

Display during running and stopping

During running, the items selected in E43 LED monitor (display selection) are displayed. In E44 LED monitor (display at stopping), specify whether to display selected items or the same items as during running.

Value of E43	E44 = 0		E44 = 1	
	at stopping	during running	at stopping	during running
0	set frequency value (Hz)	output frequency before slip compensation (Hz)		
1	set frequency value (Hz)	output frequency before slip compensation (Hz)		
2	set frequency value (Hz)			
3	output current (A)			
4	output voltage command value (V)			
5	synchronous speed set value (rpm)	synchronous speed (rpm)		
6	line speed set value (m/min)	line speed (m/min)		
7	set load speed (rpm)	load speed (rpm)		
8	calculated torque value (%)			
9	output power (kW)			
10	PID target value 1 (direct input from keypad panel)			
11	PID target value 2 (input from F02 Frequency 1)			
12	PID feedback amount			

Note: For E43 = 10 to 12, the data is displayed only if selected in H20 PID control (operation selection).

Display at frequency setting

When a set frequency is checked or changed by the keypad panel, the value shown below is displayed.

Select the display item by using E43 LED monitor (display selection). This display is not affected by E44 LED monitor (display at stopping).

Value of E43	Frequency Setting
0,1,2,3,4	set value of frequency (Hz)
5	set value of synchronous speed (rpm)
6	set value of line speed (m/min.)
7	set value of load speed (rpm)
8,9	set value of frequency (Hz)
10,11,12	set value of frequency (Hz)

Note: For E43 = 10 to 12 the data is displayed only if selected in H20 PID control (operation selection).

E45 LCD monitor (display selection)

E 4 5 L C D M N T R

This function selects the items to be displayed on the LCD monitor in operation mode.

Value	Display Items
0	Operation status, direction of rotation, operation guide
1	Output frequency before slip compensation, output current, calculated torque in bar graph

Set value: 0
During running

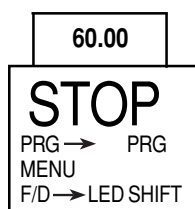

When stopping

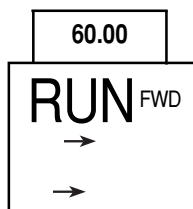

Set value: 1

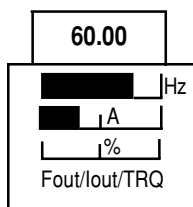

Full scale value of bar graph

Display item	Full scale
Output frequency	Maximum frequency
Output current	200% of drive rated value
Calculated torque value	200% of motor rated value

Note: The scale cannot be adjusted.

E46 LCD monitor (language)

E 4 6 L A N G U A G E

This function selects the language for data display on the LCD monitor.

Value	Language	Value	Language
0	Japanese	3	French
1	English	4	Spanish
2	German	5	Italian

Note: English language is used for all LCD screens in this manual.

E47 LCD monitor (contrast adjustment)

E 4 7 C O N T R A S T

This function adjusts the LCD contrast. Increase the set value to raise contrast and decrease to lower contrast.

	←————→
Value	0, 1, 2 ••••• 8, 9, 10
Screen	Low High

C: Control Functions of Frequency

C01 Jump frequency 1

C02 Jump frequency 2

C03 Jump frequency 3

C04 Jump frequency hysteresis

C01	JUMP	Hz	1
C02	JUMP	Hz	2
C03	JUMP	Hz	3

Setting range: 0 to 120 Hz in 1Hz increments (min.)

C04	JUMP	HYS	R
-----	------	-----	---

Setting range: 0 to 30 Hz in 1Hz increments (min.)

This function makes the set frequency jump so that the drive's output frequency does not match the mechanical resonance point of the load.

Up to three jump points can be set.

This function is ineffective if jump frequencies 1 to 3 are set to 0 Hz.

A jump does not occur during acceleration or deceleration.

If a jump frequency setting range overlaps another range, both ranges are added to determine the actual jump area.

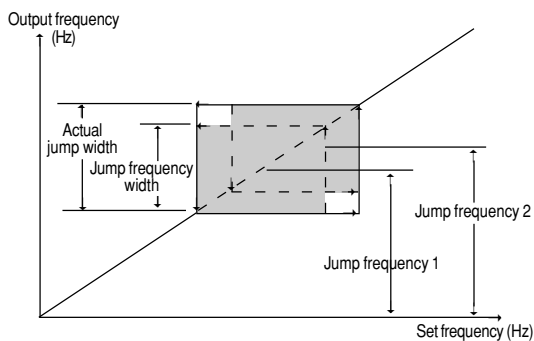
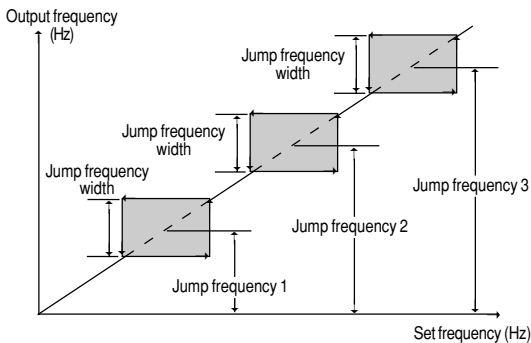

C05-C19 Multi-step frequency 1 to 15

C05	MULTI	Hz	1
C06	MULTI	Hz	2
C07	MULTI	Hz	3
C08	MULTI	Hz	4
C09	MULTI	Hz	5
C10	MULTI	Hz	6
C11	MULTI	Hz	7
C12	MULTI	Hz	8
C13	MULTI	Hz	9
C14	MULTI	Hz	10
C15	MULTI	Hz	11
C16	MULTI	Hz	12
C17	MULTI	Hz	13
C18	MULTI	Hz	14
C19	MULTI	Hz	15

Setting range: 0 to 120 Hz In 0.01 Hz increments (min.)

Multistep frequencies 1 to 15 can be switched by turning terminal functions SS1, SS2, SS4, and SS8 on and off. (See E01 to E09 for terminal function definitions.)

OFF is the default value any undefined SS1, SS2, SS4, and SS8 terminals.

Related functions: E01 to E09 (Set value: 0 to 3)

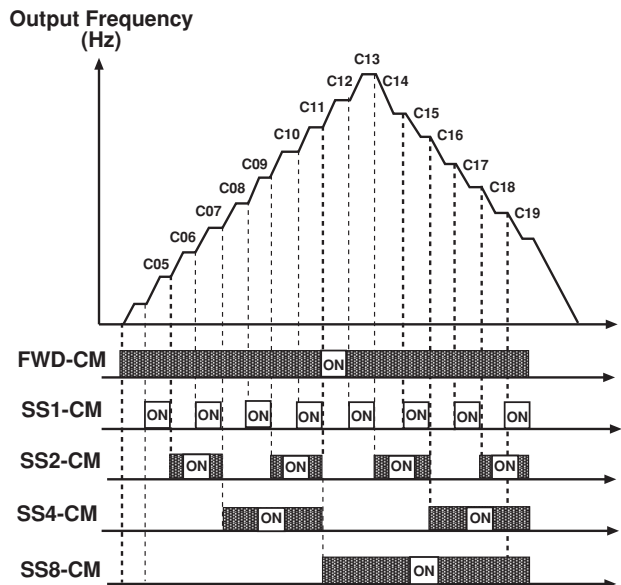

C20 Jog frequency

C 2 0 J O G H z

Setting range: 0.00 to 120.00 Hz

This function sets a frequency for the motor jogging operation, which is different from the normal operation.

The jogging frequency is used for operation when the jogging mode signal is received from the keypad panel or control terminal. For details, see the explanations of E01 Terminal X1 to E09 Terminal X9.

C21 Pattern operation (operation selection)

C 2 1 P A T T E R N

Pattern operation is an automatic operation according to a preset operation time, direction of rotation, acceleration and deceleration time, and frequency.

When using this function, set **F01 Frequency setting** to 10 (pattern operation).

[Related Functions: F01, C30 = 10]

The following operation patterns can be selected.

Value	Operation Pattern
0	Perform a pattern operation cycle, then stop operation.
1	Perform pattern operation repeatedly. Operation is stopped by the STOP operation.
2	Perform a pattern operation cycle, then continue operation at the last set frequency.

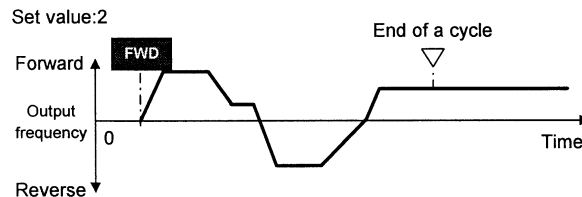
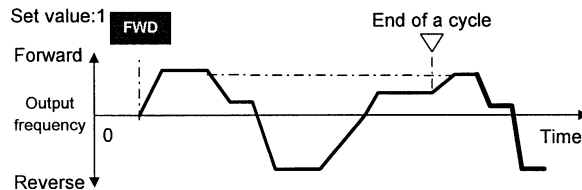
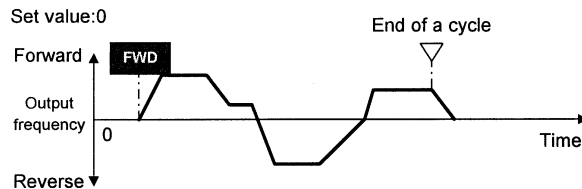

C22-C28 Pattern operation (stage 1 to 7)

C 2 2 S T A G E 1
C 2 3 S T A G E 2
C 2 4 S T A G E 3
C 2 5 S T A G E 4
C 2 6 S T A G E 5
C 2 7 S T A G E 6
C 2 8 S T A G E 7

Seven stages are operated in order of function codes, according to the values set in C22 Pattern operation (stage 1) to C28 Pattern operation (stage 7). Each function sets the operation time and the direction of rotation for each stage and assigns values to acceleration and deceleration time.

Set or assign item	Value range
Operation time	0. 00 to 6000s
Rotation direction	F: Forward (counterclockwise) R: Reverse (clockwise)
Acceleration and deceleration time	1: Acceleration time 1 (F07) Deceleration time 1 (F08) 2: Acceleration time 2 (E10) Deceleration time 2 (E11) 3: Acceleration time 3 (E12) Deceleration time 3 (E13) 4: Acceleration time 4 (E14) Deceleration time 4 (E15)

Note: The operation time is represented by the three most significant digits, hence, can be set with only three high-order digits.

Setting example

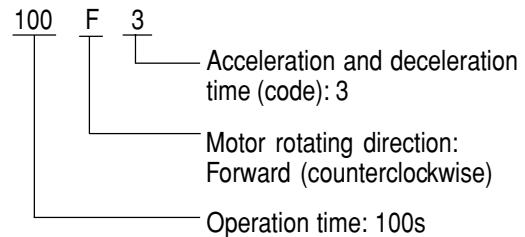

Set the operation time to 0.00 for any unused stages, which are skipped during operation.

In regard to the set frequency value, the multi-step frequency function is assigned according to the table below. Seven frequencies can be set for C05 Multi-step frequency 1 to C11 Multi-step frequency 7.

Stage No.	Operation Frequency
Stage 1	Multi-step frequency 1 (C05)
Stage 2	Multi-step frequency 2 (C06)
Stage 3	Multi-step frequency 3 (C07)
Stage 4	Multi-step frequency 4 (C08)
Stage 5	Multi-step frequency 5 (C09)
Stage 6	Multi-step frequency 6 (C10)
Stage 7	Multi-step frequency 7 (C11)

Pattern operation example

Function Value / Operation Frequency

C21	1	Selects function
C22 (stage 1)	60.0F2	Multi-step frequency 1 (C05)
C23 (stage 2)	100F1	Multi-step frequency 2 (C06)
C24 (stage 3)	65.5R4	Multi-step frequency 3 (C07)
C25 (stage 4)	55.0R3	Multi-step frequency 4 (C08)
C26 (stage 5)	50.0F2	Multi-step frequency 5 (C09)
C27 (stage 6)	72.0F4	Multi-step frequency 6 (C10)
C28 (stage 7)	35.0F2	Multi-step frequency 7 (C11)

The following diagram shows this operation.

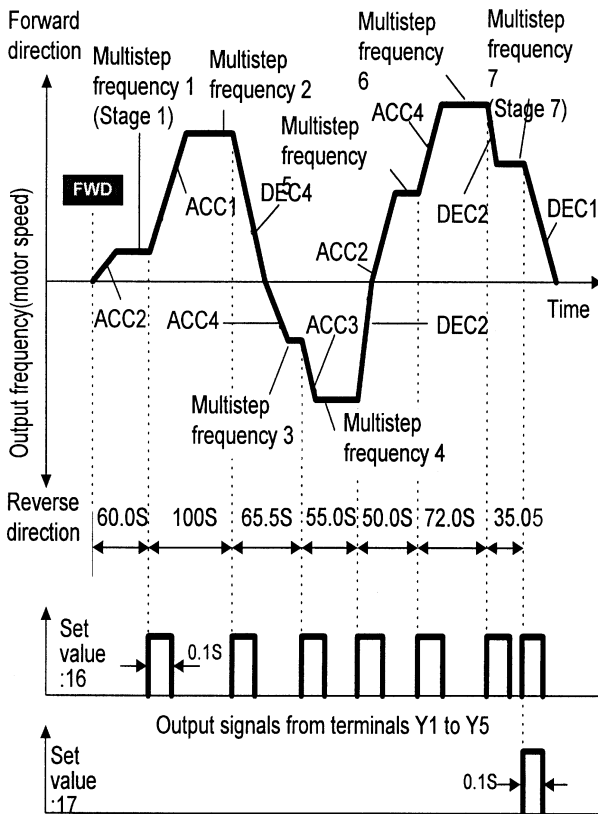

Running and stopping are controlled by pressing the STOP or FWD keys or by opening and closing the control terminals.

When using the keypad panel, the FWD key starts operation. The STOP key pauses stage advance. Pressing the FWD key again will restart operation from the stop point according to the stages. If an alarm stop occurs, press the RESET key to release the drive protective function, then press the FWD key to restart stage advance.

If operation is to restart from the first stage, **C22 Pattern operation (stage 1)**, enter a STOP command and press the RESET key.

If an alarm stop occurs, press the RESET key to release the protective function, then press the RESET key again.

Notes:

1. The direction of rotation cannot be reversed by a command issued from the REV key on the keypad panel or Terminal REV. Any reverse rotation commands entered will be canceled. Select forward or reverse rotation by the data in each stage. If the control terminals are used for operation, the self-hold function will not work. Select an alternate type switch when using control terminals.
2. At the end of a cycle, the motor decelerates to stop according to the value set in F08 Deceleration time 1.

C30 Frequency setting 2

C 3 0 F R E Q C M D 2

For the setting method, see the explanation for F01.

Notes: Setting 2, 3, and 7 are inactive. (C1 signals)

This function determines the frequency setting method.

C31 Analog input bias adjustment

The setting range is -100.0 to +100.0% (in 0.1% increments) of the maximum output frequency.

C32 Analog input gain adjustment

The gain adjustment range is 0.0 to 200%.

C 3 1 B I A S
C 3 2 G A I N

These functions set the gain and bias for analog input Terminals 12, in conjunction with functions F17 (freq. gain) and F18 (freq. bias).

For details, see the explanation for F17 and F18.

C33 Analog setting signal

C 3 3 R E F F I L T E R

Setting range: 0.00 to 5.00 seconds

Analog signals input from Terminals 12, V2 or C1 may contain noise which renders the control unstable. This function adjusts the time constant of the input filter to remove the effects of noise.

A value that is set too large delays control response although stabilizing the control. A value that is set too small speeds up control response but renders the control unstable.

If the optimum value is not known, adjust the setting if the control is unstable or response is delayed.

Note:

The set value is commonly applied to Terminals 12, V2 and C1. For input of PID feedback, the PID control feedback filter (H25) is used.

Motor 1 (P: Motor Parameters)

P01 Number of motor 1 poles

P 0 1 M 1 P O L E S

Setting range:: 2, 4, 6, 8, 10, 12, 14

This function sets the number of poles in Motor 1. If this setting is not made, an incorrect motor speed (synchronous speed) is displayed on the LED.

P02 Motor 1 (capacity)

P 0 2 M 1 - C A P

Set values for models with nominal motor capacity of 30Hp or less: 0.01 to 60Hp

Set values for models with nominal motor capacity of 40Hp or more: 0.01 to 800Hp

The nominal motor capacity is set at the factory. This setting should only be changed when driving a motor with a different capacity.

Set the nominal motor capacity listed in 9-1 Standard Specifications. A value in the range from two ratings lower to one rating higher than the nominal motor capacity can be set. If a value outside this range is set, accurate control cannot be guaranteed. If a value between two nominal motor capacities is set, data for the lower capacity is automatically stored for related function data.

If this function setting is changed, the following related functions are automatically set to data values for the Fuji 3-phase standard motor.

- P03 Motor 1 (rated current)
- P06 Motor 1 (no-load current)
- P07 Motor 1 (% R1)
- P08 Motor 1 (% X1)

Note:

The values for the 3-phase standard motor are 230V, 60Hz, 4 poles for the 230V series; 460V, 60Hz, 4 poles for the 460V series.

P03 Motor 1 (rated current)

P 0 3 M 1 - L R

Setting range: 0.00 to 2,000 A

This function sets the rated current value for Motor 1.

P04 Motor 1 (Tuning)

P 0 4 M 1 T U N 1

This function measures and automatically stores motor data.

Value	Operation
0	Inactive
1	Measure the motor's primary resistance (%R1) and base frequency leakage reactance (%X) when the motor is stopping and automatically store both values in P07 and P08.
2	Measure the motor's primary resistance (%R1) and base frequency leakage reactance (%X) when the motor is stopping, measure the no-load current (I _o) when the motor is running, and automatically store these values in P06, P07, and P08.

Perform auto tuning if the previously stored data in P06 No-load current, P07 %R1, and P08 %X differs from the actual motor data. Some typical examples are listed below. Auto tuning improves control and calculation accuracy.

- When a motor other than the GE standard 3-phase motor is used, and accurate data is required for close control.
- When output-side impedance cannot be ignored, e.g. when the cable between the drive and the motor is too long or when a reactor is connected.
- When %R1 or %X is unknown, e.g. when a non-standard or special motor is used.

Tuning Procedure

1. Adjust the voltage and frequency according to motor data. Adjust functions F03 Maximum output frequency, F04 Base frequency, F05 Rated voltage, and F06 Maximum output voltage.
2. First enter motor constants that cannot be tuned. Set functions P02 Capacity, P03 Rated current, and P06 No-load current (no-load current setting is not required if P04=2).
3. When tuning the no-load current, beware of motor rotation.
4. Set function P04 Auto tuning = 1 (motor stop) or 2 (motor rotation). Press the FUNC/DATA key to store the set value and press the FWD key or REV key. Tuning will start.
5. Tuning may take several seconds. If P04=2, the motor accelerates up to half the base frequency according to acceleration time, is tuned for the no-load current, and decelerates according to the deceleration time. The total tuning time varies depending on the settings for acceleration and deceleration time.
6. Press the STOP key, and the procedure will end.

Note: Use function A13 Motor 2 (auto tuning) to tune Motor 2. In this case, the set values described in (1) and (2) above are for functions A01, etc. corresponding to Motor 2.

WARNING

If the auto tuning value is set to 2, the motor rotates at a maximum of half the base frequency. Beware of motor rotation as injury may result.

P05 Motor 1 (On-line Tuning)

P 0 5 M 1 T U N 2

Long-time operation affects motor temperature and motor speed. On-line tuning minimizes speed changes related to these temperature changes.

Value	Operation
0	Inactive
1	Active

P06 Motor 1 (no-load current)

P 0 6 M 1 - I O

Setting range: 0.00 to 2,000 A

This function sets the no-load current (exciting current) for Motor 1.

P07 Motor 1 (%R1 setting)

P08 Motor 1 (%X setting)

P 0 7 M 1 % R 1
P 0 8 M 1 % X

These functions are used to set data if using a motor other than the GE standard 3-phase motor and when the motor constant and the impedance between the drive and motor are known.

Calculate %R1 using the following formula:

$$\%R1 = \frac{R1 + \text{CableR}}{V / (\sqrt{3} \cdot I)} \times 100 [\%]$$

R1: Primary coil resistance value of the motor [W]

Cable R: Output-side cable resistance value [W]

V: Rated voltage [V] I: Rated current [A]

Rated current

$$\%X = \frac{X1 + X2 \cdot XM / (X2 + XM) + \text{Cable X}}{V / (\sqrt{3} \cdot I)} \times 100 [\%]$$

X1: Primary leakage reactance of the motor [W]

X2: Secondary leakage reactance (converted to a primary value) of the motor [W]

XM: Exciting reactance of the motor [W]

Cable X: Output-side cable reactance [W]

V: Rated voltage [V]

I: Rated current [A]

Note:

For reactance, use a value from the data stored in F04 Base frequency 1.

When connecting a reactor or filter to the output circuit, add its value. Use value 0 for cable values that can be ignored.

P09 Slip compensation control

P 0 9 S L I P C O M P 1

Setting range: 0.00 to 15.00 Hz

Changes in load torque affect motor slippage, thus causing variations in motor speed. The slip compensation control adds a frequency, proportional to motor torque, to the drive output frequency. This will minimize variations in motor speed due to changes in torque.

Calculate the amount of slip compensation using the following formula:

$$= \text{Base frequency} \times \frac{\text{Slippage [r/min.]}}{\text{Synchronous speed [r/min.]}} [\text{Hz}]$$

Slippage = Synchronous speed - Rated speed

H: High Performance function

H03 Data initializing

H 0 3 D A T A I N I T

Setting range: 0: Disabled
1: Initializes data

This function returns all function data changed by the customer to the original factory settings (initialization).

To perform initialization, press the STOP and ^ keys together to set H03=1, then press the FUNC/DATA key. The values for all functions are initialized. The set value in H03 automatically returns to 0 following the end of initialization.

H04 Auto-reset (Times)

H05 Auto-reset (Reset interval)

H 0 4 A U T O - R E S E T

H 0 5 R E S E T I N T

Set the protective function release count and waiting time from its startup to release.

Setting range:
(Count) : 0, 1 to 10
(Waiting time) : 2 to 20 seconds

When a drive protective function which invokes the retry operation is activated, these functions release operation of the protective function and restarts operation without issuing an alarm or terminating output.

To disable the retry function, set H04 Retry (count) = 0.

Drive protective functions that can invoke the retry function:

OC1, OC2, OC3: Overcurrent	dBH: braking resistor overheating
OV1, OV2, OV3: Overvoltage	OL1: Motor 1 overload
OH1: Heat sink overheating	OL2: Motor 2 overload
OH3: Drive overheating internally	OLU: Drive overload

If the value of H04 Retry (count) is set from 1 to 10, a drive run command is immediately entered following the wait time set in H05 Retry (wait time) and the startup of the retry operation. If the cause of the alarm has been removed at this time, the drive starts without switching to alarm mode. If the cause of the alarm still remains, the protective function is reactivated according to the wait time set in H05 Retry (waiting time). This operation is repeated until the cause of the alarm is removed. The restart operation switches to alarm mode when the retry count exceeds the value set in H04 Retry (count). The operation of the retry function can be monitored from terminals Y1 to Y5.

WARNING

When the retry function is selected, operation will automatically restart, depending on the cause of the stop. (The machine should be designed to ensure safety during a restart.) When the retry function is selected, GE start software (F02 set 3 or 4) does not work.

When retry succeeded

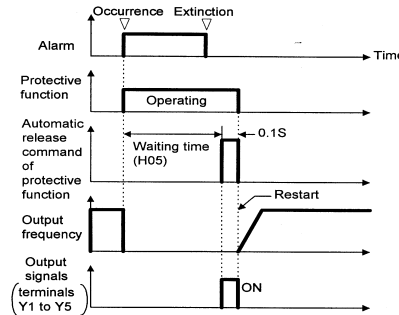

retry failed

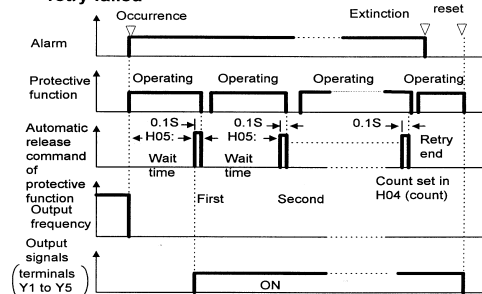

H06 Fan stop operation

H 0 6 F A N S T O P

Setting range: 0: ON/OFF control disabled
1: ON/OFF control enabled

This function specifies whether ON/OFF control for the cooling fan is automatic. While power is applied to the drive, the automatic fan control detects the temperature of the heatsink and turns the fan on or off. When this control is not selected, the cooling fan rotates continuously.

The cooling fan operating status can be monitored from terminals Y1 to Y5.

H07 ACC/DEC (Mode select) pattern

H 0 7 A C C P T N

Setting range: 0: Inactive (linear acceleration and deceleration)

- 1: S-shape acceleration and deceleration (mild)
- 2: S-shape acceleration and deceleration (sharp)
- 3: Curvilinear acceleration and deceleration

This function selects the acceleration and deceleration pattern.

S-shape Acceleration and Deceleration

This pattern reduces shock by mitigating output frequency changes at the beginning and end of acceleration and deceleration.

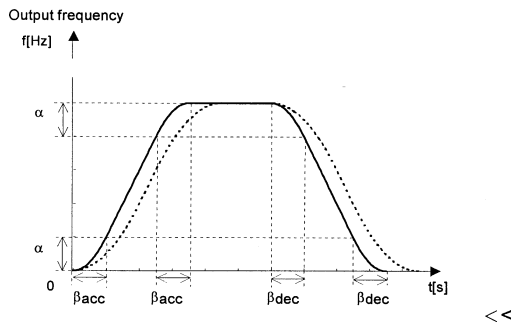

Pattern constants>

	When 1 is selected in H07 (mid S-shape pattern)	When 2 is selected in H07 (mid S-shape pattern)
Range of S-shaped	0.05 x maximum output frequency (Hz)	0.10 x maximum output frequency (Hz)
Time for S-shaped at acceleration	0.10 x acceleration time (s)	0.20 x acceleration time (s) *
Time for S-shaped at deceleration	0.10 x deceleration (s)	0.20 x deceleration (s)

When acceleration and deceleration times are very long or short, acceleration and deceleration are almost linear.

Curvilinear Acceleration and Deceleration

This function is used to minimize motor acceleration and deceleration times in the range that includes a constant output range.

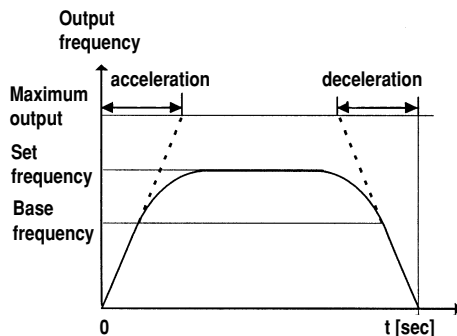

H08 Rev. phase sequence lock

H 0 8 R E V L O C K

Setting range: 0: Inactive
1: Active

If accidental reversing could result in a malfunction, this function can be set to prevent reversal.

This function prevents a reversing operation resulting from a connection between the REV and CM terminals, inadvertent activation of the REV key, or negative analog input from Terminals 12 or V1.

H09 Start mode

H 0 9 S T A R T M O D E

Setting range 0, 1, 2

This function smoothly catches a spinning motor which is coasting after a momentary power failure or after the motor has been subject to external force, without stopping the motor, i.e. windmilling fan.

At startup, this function detects the motor speed and outputs the corresponding frequency, thereby enabling a shock-free motor startup. The normal startup method is used if the coasting speed of the motor is 120 Hz or more as a drive frequency and if the value of F03 Maximum frequency exceeds the value of F15 Frequency limiter (upper limit).

Value	Normal startup	Restart after a momentary power failure	Line-to-drive switching
0	Inactive	Inactive	Inactive
1	Inactive	Active	Active
2	Active	Active	Active

Explanation

- This function is effective if F14 Restart after momentary power failure (operation selection) is set to 3, 4, or 5. This function is also effective when operation is switched from the line to the drive. The motor is started with the same frequency as the current coasting speed (speed search).
- In addition to restarting following a momentary power failure and switching between the line and the drive, this function detects the coasting speed of the motor and starts the motor at the same frequency as all startups (including when an ON operation command is entered).

By assigning 26 (start characteristics selection) to terminals X1 to X9, this function can be externally selected as the normal startup method whenever an ON operation command is entered.

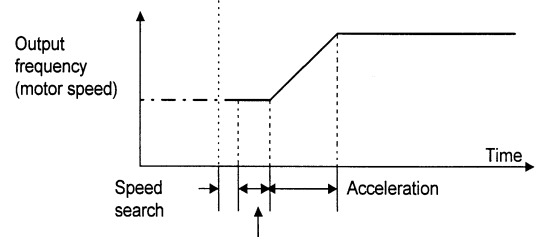
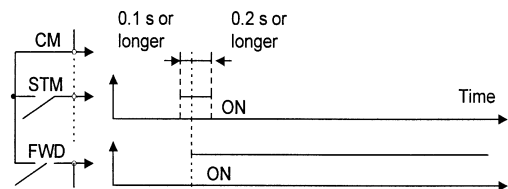

Note: The dotted-dashed line indicates motor speed.

H10 Energy-saving operation

H10 ENERGY SAV

Setting range: 0: Inactive 1: Active

With constant-speed operation at light loads (fixed output frequency), this function automatically reduces the output voltage while minimizing the product of voltage and current (power).

[Exception: If F09 Torque boost 1 = 0.0]

Notes:

Use this function for variable torque loads (e.g., fans, pumps). If used for a constant torque load or rapidly changing load, this function causes a delay in control response.

The energy-saving operation automatically stops during acceleration and deceleration or when the torque limiting function is activated.

H11 DEC mode

H11 DEC MODE

Setting range: 0: Deceleration-to-stop based on data set with H07 Non-linear acceleration and deceleration
1: Coasting-to-stop

This function determines the drive stopping method when a STOP command is entered.

Note:

This function is effective only when a STOP command is entered and, therefore, is ineffective if the motor is stopped by lowering the set frequency.

H12 Instantaneous overcurrent limiting

H12 INST CL

Setting range: 0: Inactive 1: Active

An overcurrent trip generally occurs when current flows above the drive protective level, following a rapid change in motor load. The instantaneous overcurrent limiting function controls drive output and prohibits the flow of a current exceeding the protective level, even if the load changes.

Since the operation level of the instantaneous overcurrent limiting function cannot be adjusted, the torque limiting function must be used.

Motor generation torque may be reduced when instantaneous overcurrent limiting is applied. Set this function to be inactive for equipment such as elevators, which are adversely affected by reduced motor generation torque, in which case an overcurrent trip occurs when the current flow exceeds the drive protective level. A mechanical brake should be used to ensure safety.

H13 Auto-restart (Restart time)

H13 RESTART T

Setting range: 0.1 to 10.0 seconds

Instantaneous switching to another power line (when the power of an operating motor is cut off or power failure occurs) creates a large phase difference between the line voltage and the voltage remaining in the motor, which may cause electrical or mechanical failure. To rapidly switch power lines, store the remaining voltage attenuation time to wait for the voltage remaining in the motor to attenuate. This function operates at restart after a momentary power failure.

If the momentary power failure time is shorter than the wait time value, a restart occurs following the wait time. If the power failure time is longer than the wait time value, a restart occurs when the drive is ready to operate (after about 0.2 to 0.5 seconds).

H14 Auto-restart (freq. fall rate)

H14 FALL RATE

Setting range: 0.00, 0.01 to 100.00 Hz/s

If H14 = 0.00, the frequency is reduced according to the set deceleration time.

This function determines the reduction rate of the output frequency for synchronizing the drive output frequency with the motor speed. This function is also used to reduce the frequency and thereby prevent stalling under a heavy load during normal operation.

Note:

A frequency reduction rate that is set too large may temporarily increase the regeneration energy from the load and invoke the overvoltage protective function. Conversely, a rate that is too small extends the operation time of the current limiting function and may invoke the drive overload protective function.

H15 Auto-restart (holding DC voltage)

H15 HOLD V

Setting range 230V series: 200 to 300V
460 V series: 400 to 600V

This function is used when **F14 Restart after momentary power failure (operation selection)** is set to 2 (deceleration-to-stop at power failure) or 3 (operation continuation). Either function starts a control operation if the main circuit DC voltage drops below the set operation continuation level.

If power supply voltage to the drive is high, control can be stabilized even under an excessive load by raising the operation continuation level. However, if the level is too high, this function activates during normal operation and causes unexpected motion. Please contact Safronics before changing the factory default value.

H16 Auto-restart (OPR command selfhold time)

H 1 6 S E L F H O L D T

Setting range: 0.0 to 30.0 seconds, 999

Since the power to an external operation circuit (relay sequence) and the main power to the drive is generally cut off at a power failure, the operation command issued to the drive is also cut off. This function sets the time an operation command is to be held in the drive. If a power failure lasts beyond the self-hold time, power-off is assumed, automatic restart mode is released, and the drive starts operation at normal mode when power is applied again. (This time can be considered to be the allowable power failure time.)

If H16 = 999, an operation command will be held until control power in the drive is established or until the main circuit DC voltage is about 0.

H19 Active drive

H 1 9 A U T R E D

Setting range: 0: Inactive
1: Active

This function automatically extends accelerating time by 60 seconds or longer to prevent an inverter trip resulting from a temperature rise in the inverter due to overcurrent.

(If the active drive function is activated, the acceleration time will be three times the selected time.)

H20 PID control (mode select)

H 2 0 P I D M O D E

Setting range: 0: No operation
1: Normal operation
2: Inverse operation

PID control detects the amount of feedback from a sensor and compares it with the target value (e.g., reference temperature). If the values differ, this function produces an output to eliminate the deviation. In other words, this control matches the feedback amount with the target value.

This function can be used for flow control, pressure control, temperature control, and other process controls.

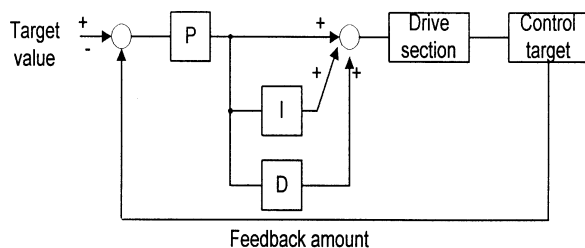

Forward or reverse operations can be selected for PID controller output. This enables motor revolutions to be faster or slower according to PID controller output.

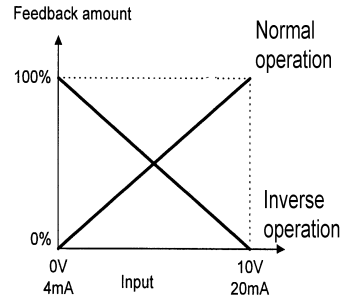
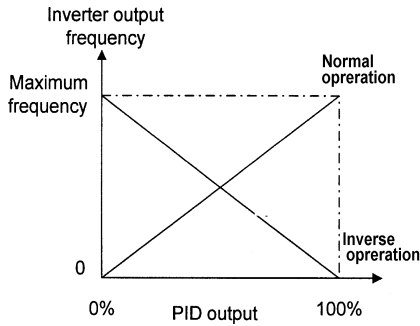

The target value can be entered using F01, Frequency setting 1, or directly from the keypad panel.

For entry from F01, Frequency setting 1, input a signal to the selected terminal. For direct entry from the keypad panel, turn on keypad operation. Select any of the digital Terminals X1 (E01) to X9 (E09) and assign a value of 11 (frequency setting switching).

NOTE: For the target value and feedback amount, the process amount can be displayed according to the values set in E40 Display coefficient A, and E41 Display coefficient B.

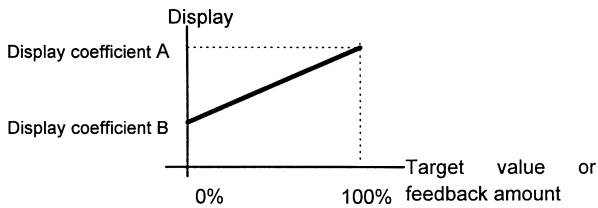

Only positive values can be input for this feedback amount of PID control. Negative values (e.g., 0 to -10V, -10 to 0V) cannot be input, thereby the function cannot be used for a reverse operation by an analog signal.

Feedback signal setting (H21) must be different from the type of setpoint value.

H21 PID control (feedback signal)

H 2 1 F B S I G N A L

This function selects the terminal, direction of operation, and feedback input. Select a value from the table below according to sensor specifications.

Value	Description
0	Terminal 12, forward operation, 0 to 10V voltage input
1	Terminal C1, forward operation, 4 to 20mA current input
2	Terminal 12, reverse operation, 10 to 0V voltage input
3	Terminal C1, reverse operation, 20 to 4mA current input

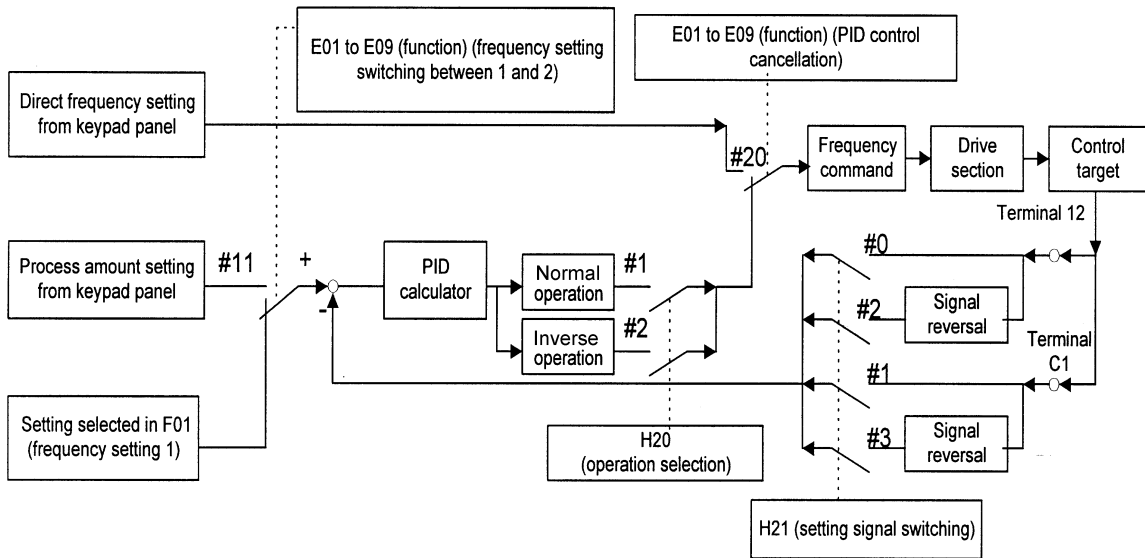

H22 PID control (P-gain)

H23 PID control (I-gain)

H24 PID control (D-gain)

These functions are not generally used alone but are combined like **P** control, **PI** control, **PD** control, and **PID** control.

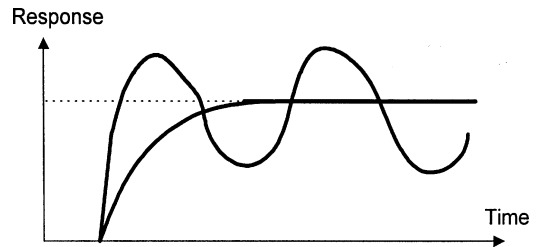

P-gain operation

An operation using an output frequency proportional to deviation is called **P** operation, which outputs an operation amount proportional to deviation, though it cannot eliminate deviation alone.

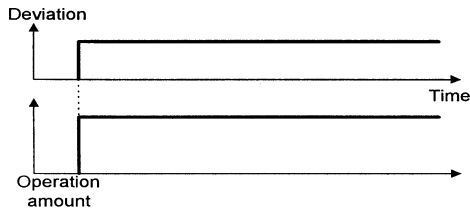

H 2 2 P - G A I N

Setting range: 0.01 to 10.0 times

P (gain) is the parameter that determines the response level for the deviation of **P** operation. Although an increase in gain speeds up response, an excessive gain causes vibration, and a decrease in gain delays response.

I-gain operation

An operation where the change speed of the output frequency is proportional to the deviation is called an **I** operation. An **I** operation outputs an operation amount as the integral of deviation and, therefore, has the effect of matching the feedback control amount to the target value (e.g., set frequency), though it deteriorates response for significant changes in deviation.

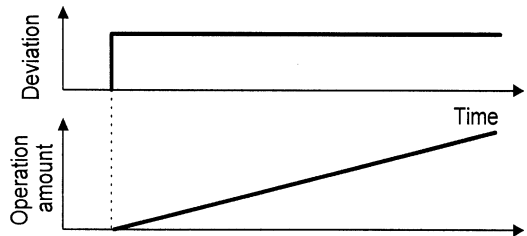

H 2 3 I - G A I N

Setting range: 0.0 (Inactive), 0.1 to 3600 seconds

H23 I-gain is used as a parameter to determine the effect of I operation. A longer integration time delays response and weakens resistance to external elements. A shorter integration time speeds up response, but an integration time that is too short causes vibration.

D-gain operation

An operation where the output frequency is proportional to the deviation differential is called a D operation. It outputs an operation amount as the deviation differential and, therefore, is capable of responding to sudden changes.

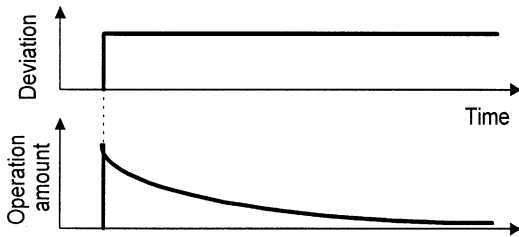

H 2 4 D - G A I N

Setting range: 0.00 (Inactive), 0.01 to 10.0 seconds

H24 D-gain is used as a parameter to determine the effect of a D operation. A longer differentiation time causes vibration by P operation quickly attenuating at the occurrence of deviation. Excessive differentiation time could cause vibration. Shortening the differentiation time reduces attenuation at the occurrence of deviation.

PI control

P operation alone does not remove deviation completely. P + I control (where I operation is added to P operation) is normally used to remove the remaining deviation. PI control always operates to eliminate deviation, even when the target value is changed or there is a constant disturbance. When I operation is strengthened, however, the response for rapidly changing deviation deteriorates. P operation can also be used individually for loads containing an integral element.

PD control

If deviation occurs under PD control, an output frequency larger than that of D operation alone occurs rapidly and prevents the deviation from expanding. For a small deviation, P operation is restricted. When the load contains an integral element, P operation alone may allow responses to vibrate due to the effect of the integral element, in which case PD control is used to attenuate the vibration of P operation and stabilize responses. In other words, this control is applied to loads in processes without a braking function.

PID control

PID control combines the P operation, the I operation which removes deviation, and the D operation which suppresses vibration. This control achieves deviation-free, accurate, and stable responses.

Adjusting PID value

Adjust the PID value while monitoring the response waveform on an oscilloscope or other instrument, if possible. Proceed as follows:

Increase the value of H22 P-gain without generating vibration.

Decrease the value of H23 I-gain without generating vibration.

Increase the value of H24 D-gain without generating vibration.

Adjust the response waveform as follows:

To remove the overshoot, increase the value of H23 I-gain, then decrease the value of H24 D-gain.

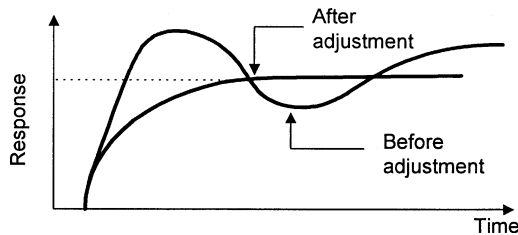

To stabilize response quickly, allowing for min. overshoot, decrease the value of H23 I-gain or increase the value of H24 D-gain.

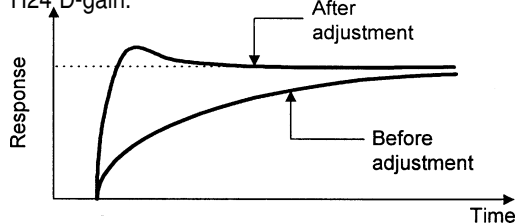

To suppress vibration with a period longer than the value of H23 I-gain, increase the value of H23.

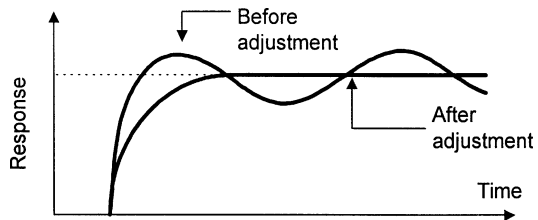

To suppress vibration with a frequency roughly equivalent to the value H24 D-gain, decrease the value of H24. If there is residual vibration with 0.0, decrease the value of H22 P-gain.

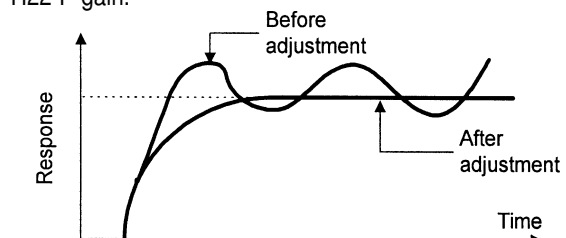

H25 PID control (Feedback filter)

H 2 5 F B F I L T E R

Setting range: 0.0 to 60.0 seconds

This filter is for feedback signal input from Terminals 12 or C1. This filter stabilizes operation of the PID control system. A set value that is too large, however, deteriorates response.

H26 PTC thermistor (mode select)

H 2 6 P T C M O D E

Setting range: 0: Inactive
1: Active

Set this function active when the motor has a PTC thermistor for overheat protection

Connect the PTC thermistor as shown in the figure below. Turn on switch PTC on the control PCB. The trip mode is activated by OH2: External thermal relay tripped.

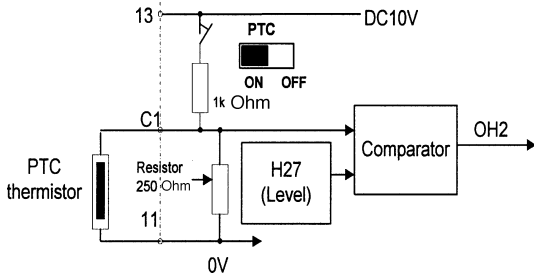

Note: Must be 0 setting when using 4-20mA reference or feedback signal and the PTC switch must be off.

H27 PTC thermistor (level select)

H 2 7 P T C L E V E L

Setting range: 0.00 to 5.00V

The voltage input to Terminal C1 is compared to the set voltage level. If the input voltage is equal to or greater than the set voltage, H26 PTC thermistor (Mode select) starts.

The PTC thermistor has its own alarm temperature. The internal resistance value of the thermistor largely changes at the alarm temperature. The operation voltage level is set using this change in the resistance value.

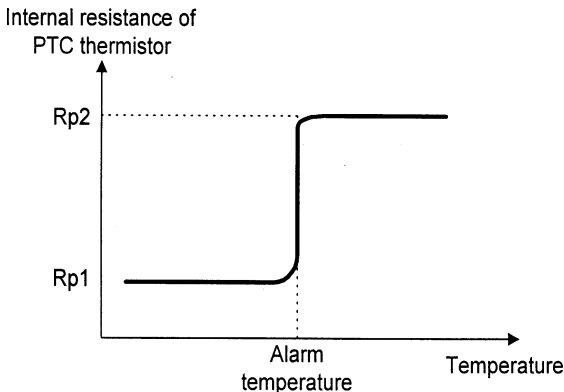

The figure above for H26 PTC thermistor (Mode select) shows that a 250Ω resistor and the thermistor (resistance value Rp) are connected in parallel. Hence, voltage Vc1 at Terminal C1 can be calculated using the following formula:

$$V_{C1} = \frac{250 \cdot R_p}{250 + R_p} \times 10 \text{ [V]}$$

$$1000 + \frac{250 \cdot R_p}{250 + R_p}$$

The operation level can be set by bringing Rp in the Vc1 calculation formula into the following range.

$$R_{p1} < R_p < R_{p2}$$

To calculate Rp, use the following formula:

$$R_p = \frac{R_{p1} + R_{p2}}{2} \text{ [Ohm]}$$

H28 Droop operation

H 2 8 D R O O P

Setting range: -9.9Hz to 0.0Hz

When two or more drive motors operate a single machine, a higher load is placed on the motor that is rotating the fastest. Droop operation achieves a good load balance by applying drooping characteristics to speed against load variations.

Calculate the droop amount using the following formula:

$$\text{Droop amount} = \text{Base frequency X} \frac{\text{Speed droop at rated torque [r/min.]} \text{ [Hz]}}{\text{Synchronous speed [r/min.]}}$$

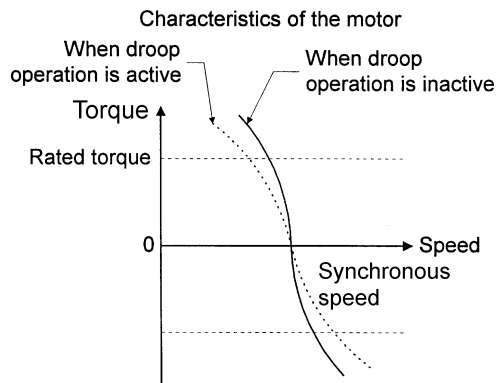

H30 Serial link (Function select)

H 3 0 L I N K F U N C

Setting range: 0 to 3

The link function (communication) provides a standard RS485 serial interface and optional fieldbus connections.

The serial link function includes:

- 1) Monitoring (data monitoring, function data check)
- 2) Frequency setting
- 3) Operation command (FWD, REV, and other commands for digital input)
- 4) Write function data

Communication can be enabled and disabled by a digital input. This function sets the serial link function when communication is enabled.

Value	Frequency	Operation
	Command	Command
0	Disabled	Disabled
1	Enabled	Disabled
2	Disabled	Enabled
3	Enabled	Enabled

The data monitoring and write functions are always enabled. Disabling communication by a digital input produces the same results as if this function were set to 0. If the bus option is installed, this setting selects the bus function, and the RS485 interface is restricted to monitoring and writing function data. If the bus option is not installed, this setting selects the RS485 function.

H31 RS485 (Address)

H39 RS485 (Response interval)

These functions set the conditions for RS485 RTU serial communication. Set the conditions according to the host device.

H 3 1 A D D R E S S

Setting range: 1 to 247

This function sets the station address of RTU. Maximum connected devices is 31 for an RS-485 network.

H 3 2 M O D E O N E R

Setting range: 0 to 3

These functions configure the drive behavior in the event of a communication error.

Value	Processing at Communication Error
0	Immediate Er 8 trip (forced stop)
1	Continue operation within timer time, Er 8 trip after time expires
2	Continue operation and retry within timer time, then invoke an Er 8 trip if a communication error occurs. If an error does not occur, continue operation.
3	Continue operation.

H 3 3 T I M E R

Setting range: 0 to 60.0 sec.

This function sets the error processing timer value.

H 3 4 B A U D R A T E

Setting range: 0 to 3

This function sets the baud rate.

Value	Baud Rate
0	19200 bits/s
1	9600 bits/s
2	4800 bits/s
3	2400 bits/s

H 3 5 L E N G T H

This function sets data length.

Value	Data Length
0	8 bit

H 3 6 P A R I T Y

This function sets the parity bit

Value	Parity Bit
0	None
1	Even
2	Odd

H 3 7 S T O P B I T S

This function sets the stop bit

Value	Stop Bit
0	2 bits
1	1 bit

The stop bit is automatically configured by the value of the parity bit. For parity "NONE" the stop bit is 2 bits. For parity "EVEN" or "ODD" the stop bit is 1 bit.

H38 NO RES T

Setting range: 0 (no detection)
1 to 60 seconds

In a system where the drive is continuously polled within a specific time, this function detects that access was stopped due to an open circuit or other network fault and results in an Er 8 trip.

H39 INTERVAL

Setting range: 0.00 to 1.00 second

This function sets the time from when a request is issued from the host device to when a response is returned.

A: Alternative Motor Parameters (Motor 2)

A01 Maximum frequency 2

A 0 1 M A X H z - 2

This function sets the maximum frequency for Motor 2 output by the drive. It operates the same as F03 Maximum frequency 1. For details, see the explanation for F03.

A02 Base frequency 2

A 0 2 B A S E H z - 2

This function sets the maximum output frequency in the constant torque area for Motor 2 (i.e., output frequency at rated output voltage). It operates the same as F04 Base frequency 1. For details, see the explanation for F04.

A03 Rated Voltage 2

A 0 3 R A T E D V 2

This function sets the rated voltage output to Motor 2. It operates the same as F05 Rated voltage 1. For details, see the explanation for F05.

A04 Maximum Voltage 2

A 0 4 M A X V - 2

This function sets the maximum drive output voltage for Motor 2. It operates the same as F06 Maximum voltage 1. For details, see the explanation for F06.

A05 Torque boost 2

A 0 5 T R Q B O O S T 2

This function sets the torque boost function for Motor 2. It operates the same as F09 Torque boost 1. For details, see the explanation for F09.

A06 Electronic thermal relay 2 (select)

A07 Electronic thermal relay 2 (level)

A08 Electronic thermal relay 2 (Thermal time constant)

A 0 6 E L C T R N O L 2
A 0 7 O L L E V E L 2
A 0 8 T I M E C N S T 2

These functions set the function of the electronic thermal overload relay for Motor 2. They operate the same as F10 to F12 Electronic thermal overload relay 1. For details, see the explanations for F10 to F12.

A09 Torque vector control 2

A 0 9 T R Q V E C T O R 2

This function sets the torque vector function for Motor 2. It operates the same as F42 Torque vector control 1. For details, see the explanation for F42.

A10 Number of motor-2 poles

A 1 0 M 2 P O L E S

This function sets the number of poles to be driven by Motor 2. It operates the same as P01 Number of Motor 1 poles. For details, see the explanation for P01.

A11 Motor 2 (capacity)

A 1 1 M 2 - C A P

This function sets the capacity of Motor 2. It operates the same as P02 Motor 1 (Capacity). For details, see the explanation for P02. However, the related motor data functions change to A12 Motor 2 (Rated current), A15 Motor 2 (No-load current), A16 Motor 2 (%R1 setting), and A17 Motor 2 (%X setting).

A12 Motor 2 (Rated current)

A 1 2 M 2 - L R

This function sets the rated current for Motor 2. It operates the same as P03 Motor 1 (Rated current). For details, see the explanation for P03.

A13 Motor 2 (Tuning)

A	1	3	M	2		T	U	N	1			
---	---	---	---	---	--	---	---	---	---	--	--	--

This function sets online tuning for Motor 2. It operates the same as for P04 Motor 1 (Tuning). For details, see the explanation for P04.

A14 Motor 2 (On-line tuning)

A	1	4	M	2		T	U	N	2			
---	---	---	---	---	--	---	---	---	---	--	--	--

This function sets online tuning for Motor 2. It operates the same as P05 Motor 1 (On-line tuning). For details, see the explanation for P05.

A15 Motor 2 (No-load current)

A	1	5	M	2		I	O					
---	---	---	---	---	--	---	---	--	--	--	--	--

This function sets the no-load current for Motor 2. It operates the same as P06 Motor 1 (No-load current). For details, see the explanation for P06.

A16 Motor 2 (%R1 setting)

A17 Motor 2 (%X setting)

A	1	6	M	2	-	%	R	1				
A	1	7	M	2	-	%	X					

These functions set %R1 and %X for Motor 2. It operates the same as P07 Motor 1 (%R1 setting) and P08 Motor 1 (%X setting). For details, see the explanations for P07 and P08.

A18 Slip compensation control 2

A	1	8	S	L	I	P		C	O	M	P	2
---	---	---	---	---	---	---	--	---	---	---	---	---

This function sets the amount of slip compensation for Motor 2. It operates the same as P09 Slip compensation control. For details, see the explanation for P09.

6. Protective Operations

6.1 List of Protective Functions

In the event of an abnormality in the inverter's operation, the protective function will activate immediately to trip the inverter and display the alarm name on the LED monitor while the motor coasts to a stop. A list of the alarms with their explanations is included in the table below, and troubleshooting charts in Section 7.

Table 6.1.1 List of Alarms and Causes

Alarm Name	Keypad Panel Display		Cause of Activation	
	LED	LCD		
Overcurrent	OC1	OC DURING ACC	During acceleration	If the inverter output current momentarily exceeds the overcurrent detection level, due to an overcurrent in the motor, or a short-circuit or ground fault in the output circuit, the protective function is activated during heavy load.
	OC2	OC DURING DEC	During deceleration	
	OC3	OC AT SET SPD	Running at constant speed	
Ground fault	EF	GROUND FAULT	If a ground fault in the inverter output circuit is detected, the protective function is activated (for 40 Hp or more only). If a ground fault occurs in an inverter rated at 30 Hp or less, the inverter is protected by the overcurrent protection. If protection against personal injury or property damage is required, install a separate ground-fault protective relay or ground leakage circuit breaker.	
Overvoltage	OU1	OV DURING ACC	During acceleration	If the DC link voltage in the main circuit exceeds the overvoltage detection level (230V series: 400V DC, 460V series: 800V DC), due to an increase in the regenerating current from the motor, the output is shut down. However, protection against inadvertent overvoltage (e.g., high-voltage line) may not be provided
	OU2	OV DURING DEC	During deceleration	
	OU3	OV AT SET SPD	Running at constant speed	
Undervoltage	LU	UNDERVOLTAGE	If the DC link voltage in the main circuit falls below the undervoltage detection level (230V series: 400V DC, 460V series: 800V DC) due to a lowered power supply, the output is shut down. If function F14 Restart after momentary power failure was selected, an alarm is not displayed. In addition, if the supply voltage falls to a level unable to maintain control power, an alarm may not be displayed.	
Input phase loss	Lin	PHASE LOSS	If input power L1/R, L2/S and L3/T has any phase of the 3 phase power "OPEN" or if there is a significant disparity between the phases, the rectifying diodes or smoothing capacitors may be damaged. An Alarm is displayed and the protective function is activated during heavy load.	
Overheating of heat sink	OH1	FIN OVERHEAT	If the temperature of the heat sink rises due to a cooling fan failure, or the temperature of the heatsink is too low, the protective function is activated during heavy load.	
External alarm	OH2	EXT ALARM	If the external alarm contacts on the braking unit, braking resistor, or external thermal O/L relay are connected to the control circuit terminals (THR), the contacts will be actuated according to contact signals.	
Overheating internally	OH3	HIGH AMB TEMP	If the temperature inside the inverter rises due to poor ventilation, etc., the protective function is activated.	
Overheating of braking resistor	dbH	DBR OVERHEAT	If electronic thermal O/L relay (for braking resistor) function F13 is selected, the protective function is activated to prevent the resistor from burning due to overheating caused by frequent use of the braking resistor.	
Motor 1 overload	OL1	MOTOR1 OL	The protective function is activated if the motor current exceeds the preset level, provided that electronic thermal O/L relay 1 function F10 has been selected.	
Motor 2 overload	OL2	MOTOR2 OL	If the second motor current exceeds the preset level when the operation is switched to drive the second motor, the protective function is activated, provided that electronic thermal O/L relay 2 of function A04 was selected.	
Drive overload	OLU	INVERTER OL	If the output current exceeds the rated overload current, the protective function is activated to provide thermal protection against overheating of the semiconductor elements in the inverter's main circuit.	
Blown fuse	FUS	DC FUSE OPEN	If the fuse in the inverter is blown out following a short-circuit or damage to the internal circuit, the protective function is activated (for 40 Hp or more only).	
Memory error	Er1	MEMORY ERROR	If a memory error occurs, such as missing or invalid data, the protective function is activated.	
Keypad panel communication error	Er2	KEYPD COM ERR	If a communication error or interrupt between the keypad panel and control circuit is detected, the protective function is activated.	
CPU error	Er3	CPU ERROR	If a CPU error occurs due to noise, etc., the protective function is activated.	
Option error	Er4	OPTN COM ERR	Error occurred while using an optional unit.	
	Er5	OPTION ERROR		
Operating error	Er6	OPR PROCD ERR	Detects drive operating procedure error during drive startup. FWD or REV connected to terminal CM when Main power is applied to drive (F02 setting 3 or 4). Stop key on keypad is pressed in terminal operation (F02 setting 1 or 3). Detected timed alarm stop command.	
Output wiring error	Er7	TUNING ERROR	If there is an open circuit or connection error in the inverter output wiring during an auto-tuning procedure, the protective function is activated.	
Modbus RTU error	Er8	RS485 COM ERR	If an error occurs while using Modbus-RTU, the protective function is activated.	

Note: Number in front of Alarm Code indicates multiple alarms. See page 4-15.

6.2 Alarm Reset

To release the trip status, enter the reset command by pressing the RESET key on the keypad panel or sending the appropriate signal to the RST terminal after removing the cause of the trip. Since the reset command is an edge operation, input a command sequence such as OFF-ON-OFF as shown in Fig.6-2-1.

When releasing the trip status, set the operation command to OFF. If the operation command is set to ON, inverter will start operation after resetting.

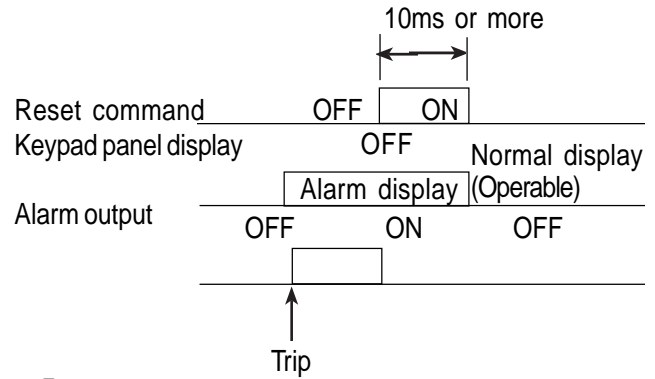

Fig.6-2-1

WARNING

If the alarm reset is activated with the operation signal ON, the inverter will restart suddenly, which may be dangerous. To ensure safety, disable the operating signal when releasing the trip status, as accident may result.

7. Troubleshooting

7.1 Activation of Protective Function

(1) Overcurrent

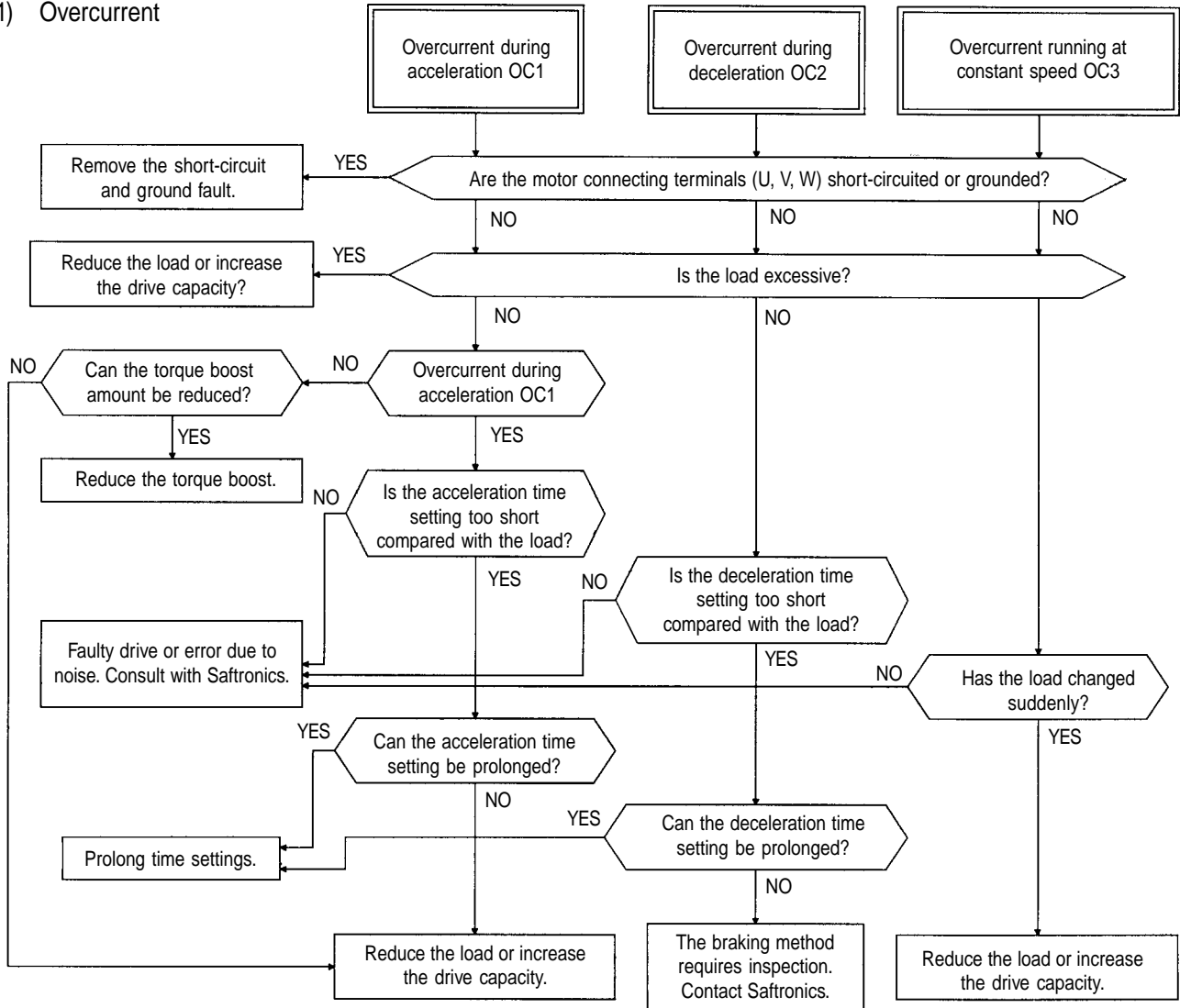

(2) Ground fault

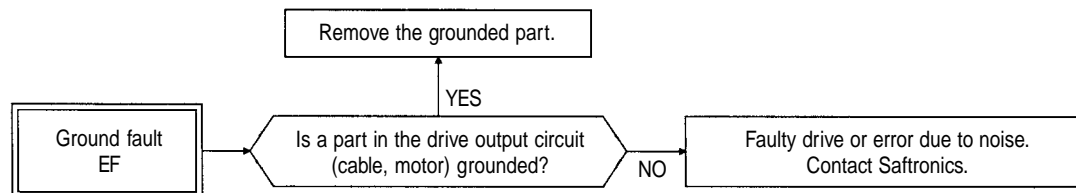

Note: The ground fault protective function is provided only for drive for nominal applied motors rated at 40 HP or more.

(3) Fuse blown

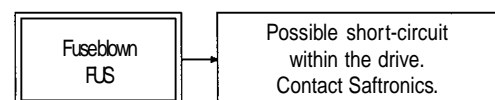

(4) Overvoltage

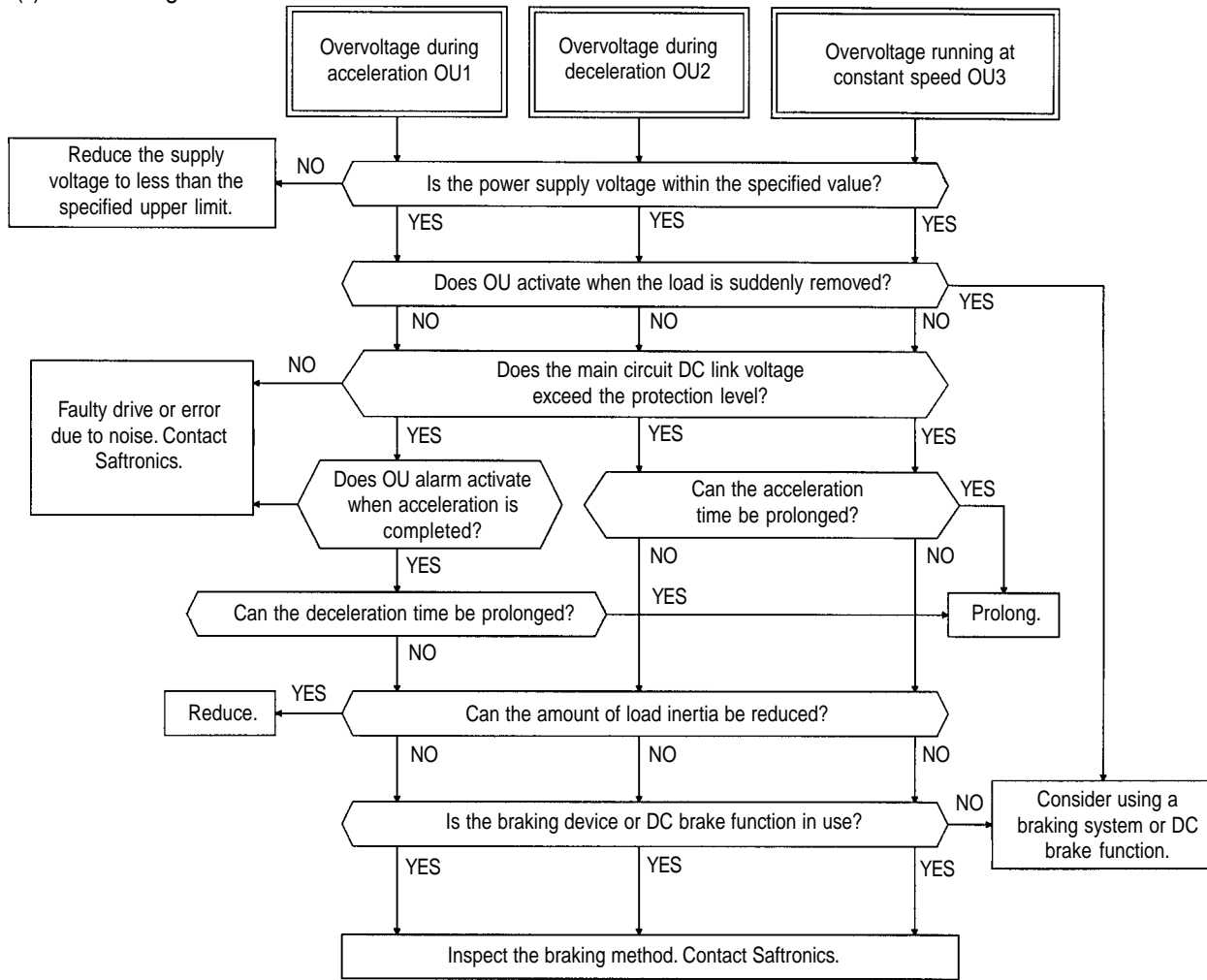

(5) Low voltage

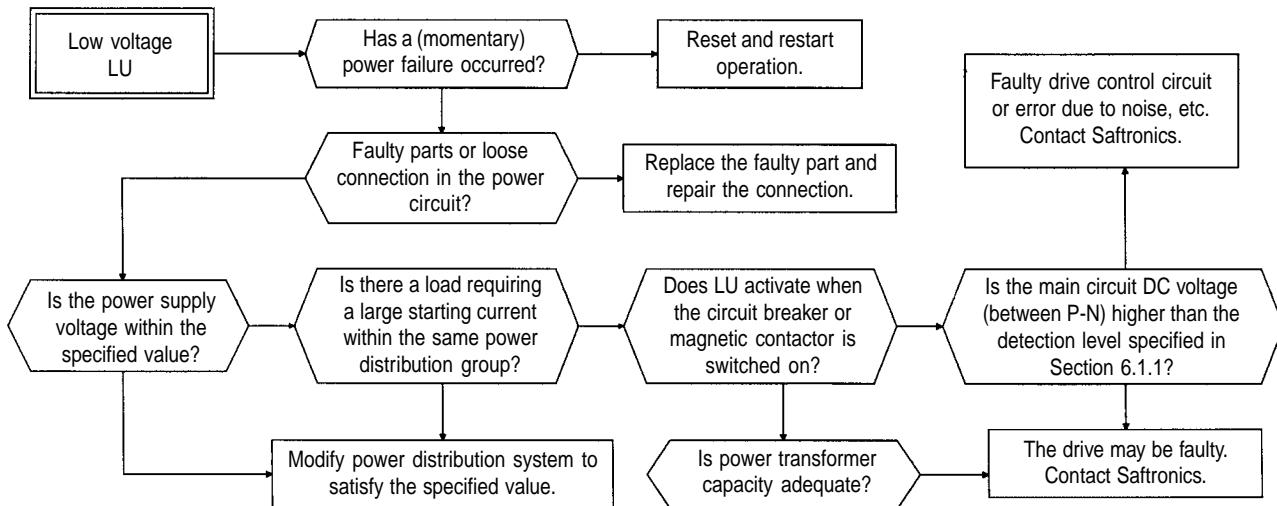

(6) Overheating internally and overheating of heat sink

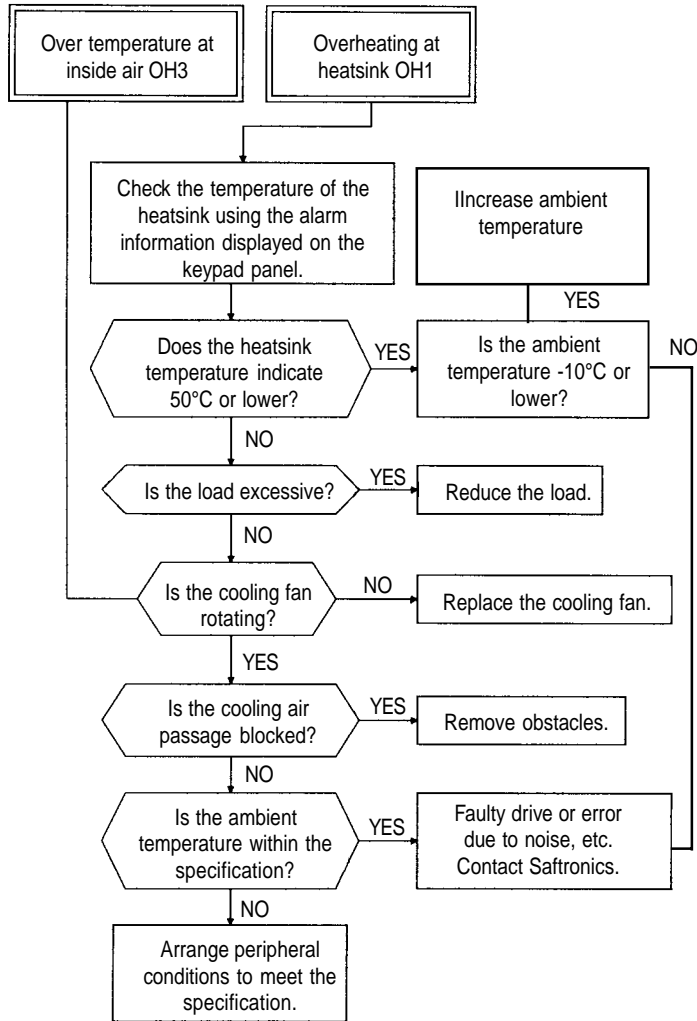

(7) External thermal relay tripped

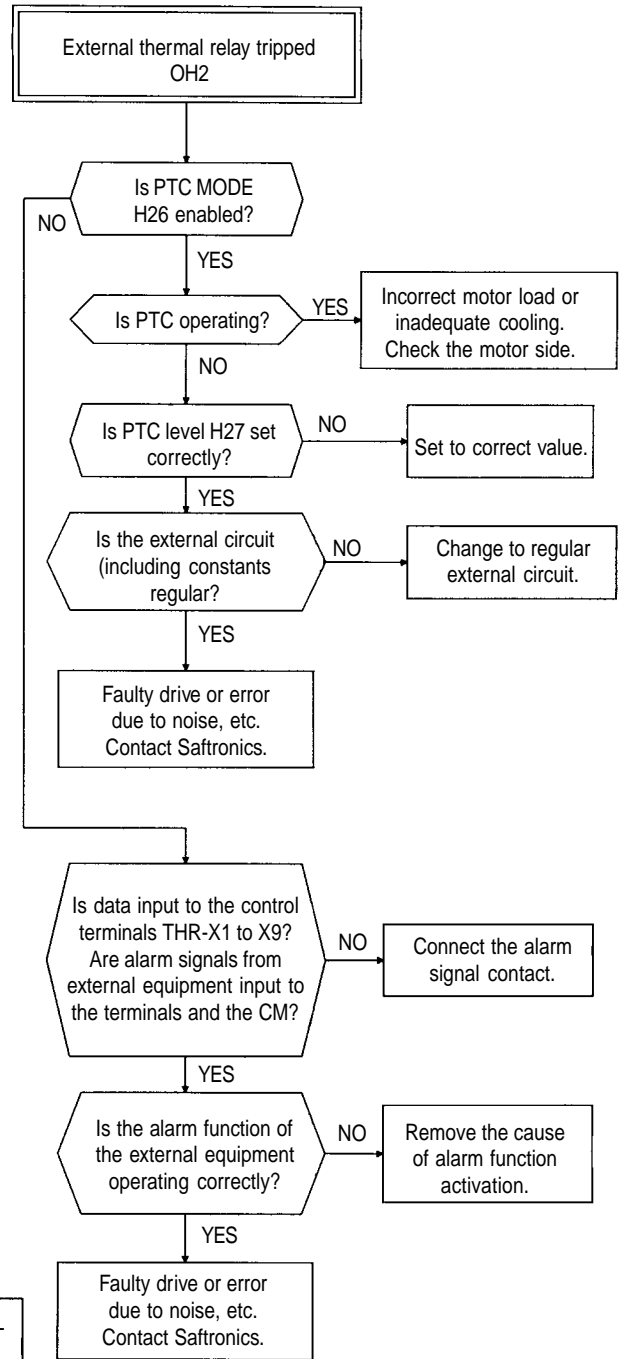

(8) Drive overload and motor overload

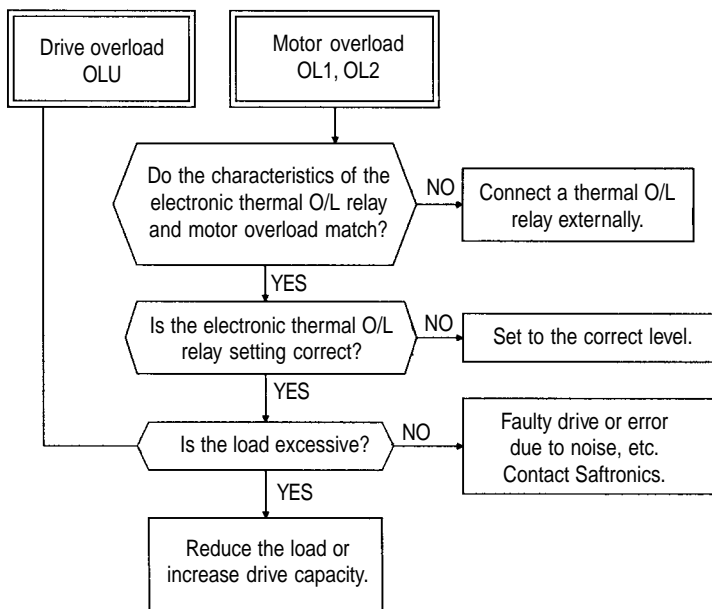

(9) Memory error Er1,
Keypad panel communication error Er2,
CPU error Er3

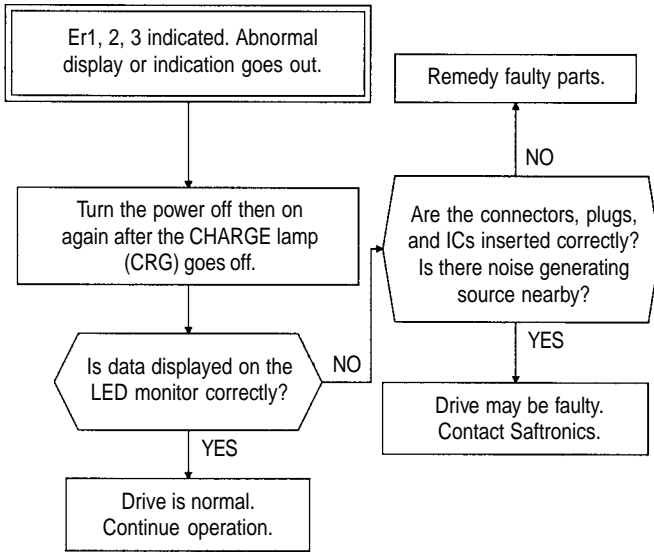

(10) Output wiring error

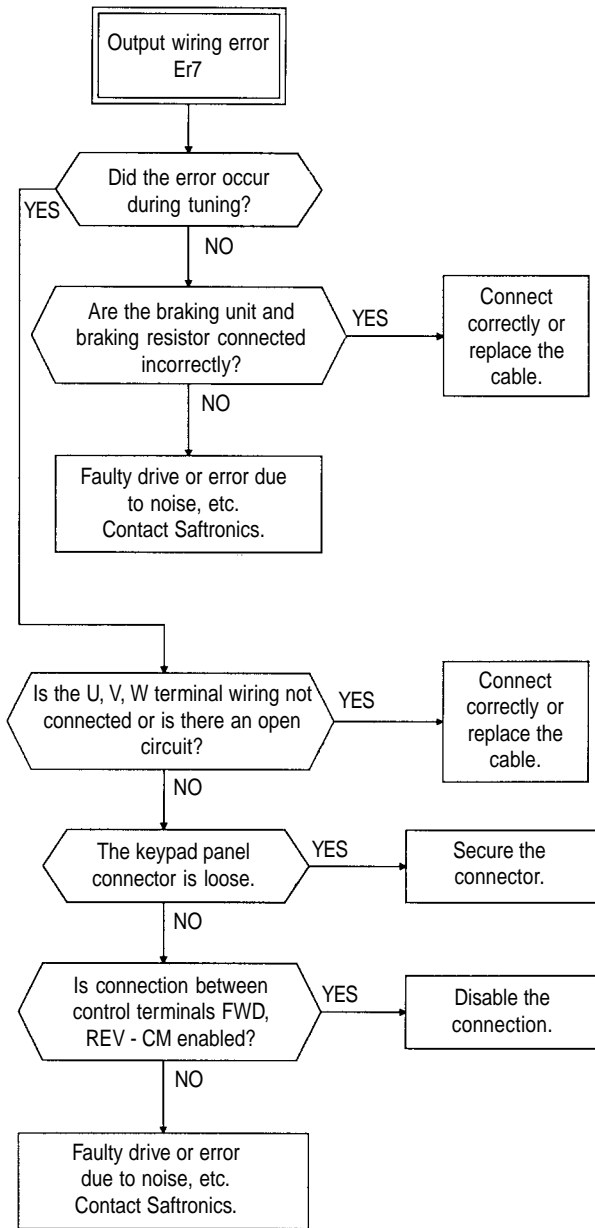

(11) Input Phase/Loss

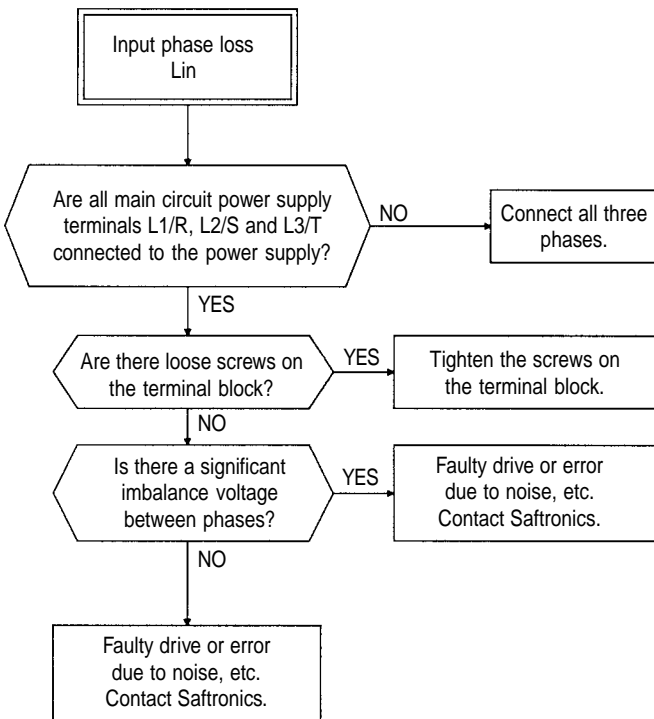

7.2 Abnormal Motor Rotation

(1) If motor does not rotate

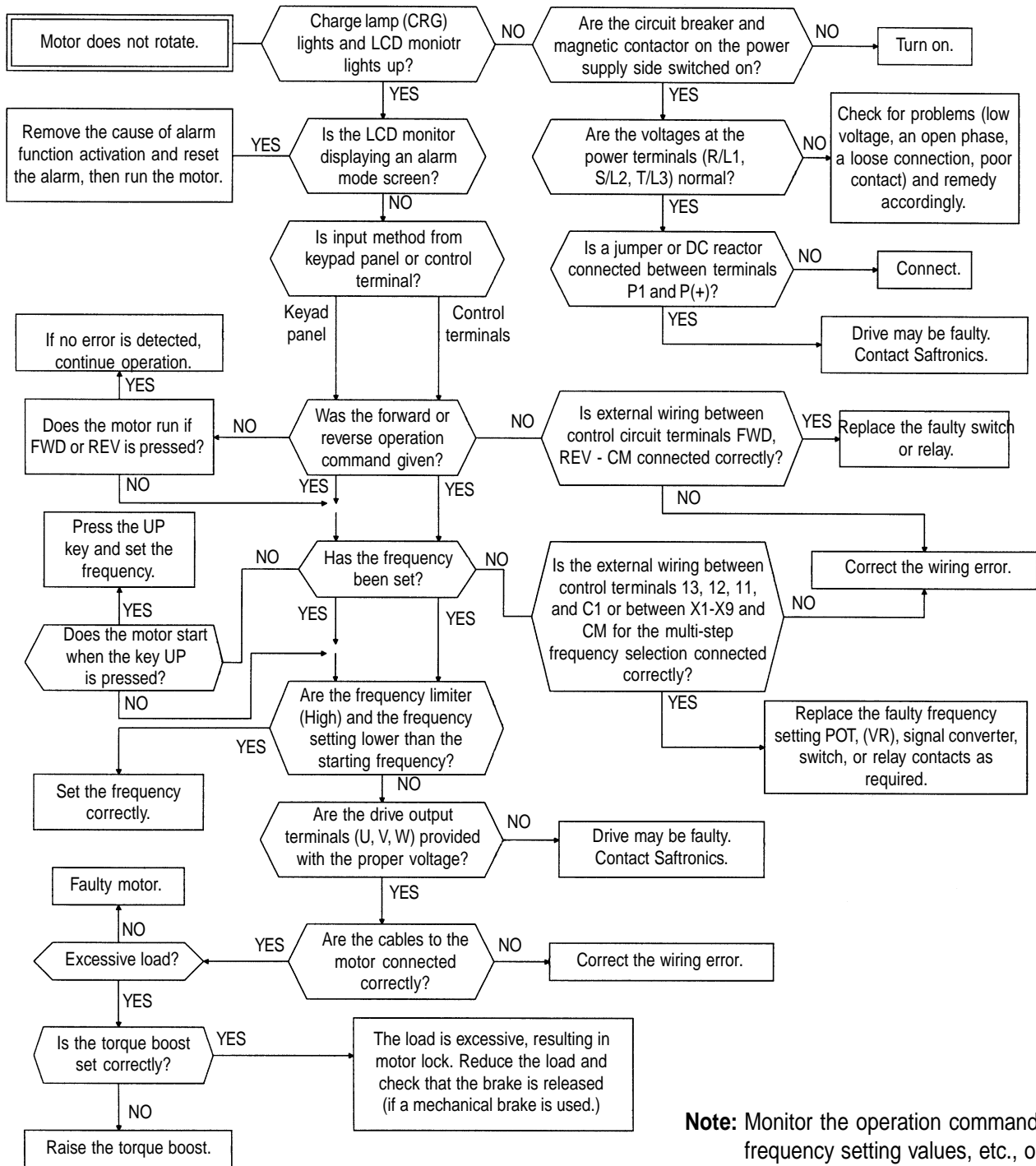

Note: Monitor the operation command or frequency setting values, etc., on the LED or LCD monitor after selecting the respective functions.

The motor does not rotate if the following commands are issued.

- An operation command is issued while the coast-to-stop or DC braking command is output.
- A reverse operation command is issued with the • H08 Rev. phase sequence lock• value set of 1.

(2) If the motor rotates but the speed does not change

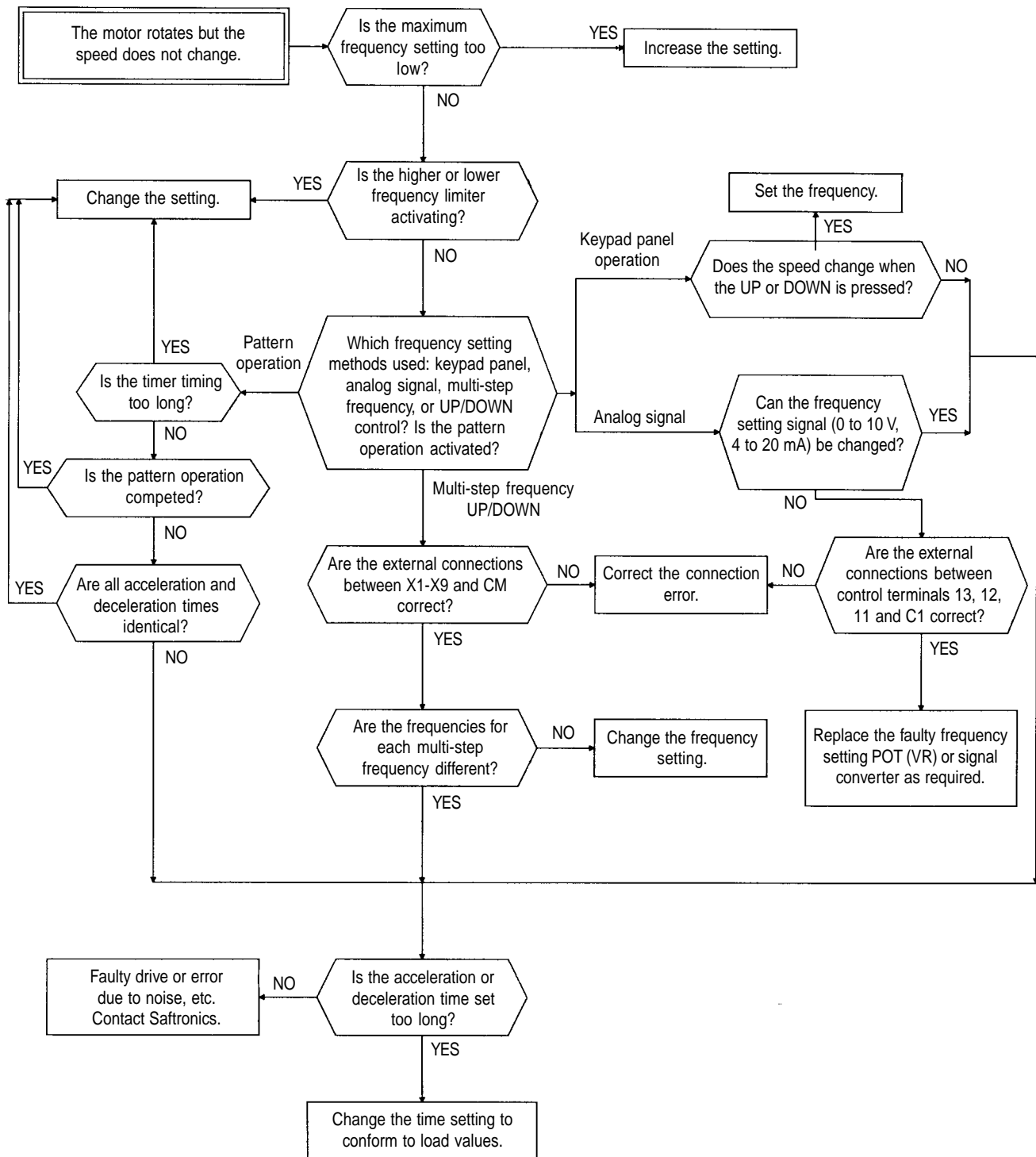

In the following cases, changing the motor speed is also restricted.

- Signals are input from control terminals both 12 and C1 when “F01 Frequency command 1” and “C30 Frequency command 2” are set to 3, and there is no significant change in the added value.
- The load is excessive, and the torque limiting and current limiting functions are activated.

(3) If the motor stalls during acceleration

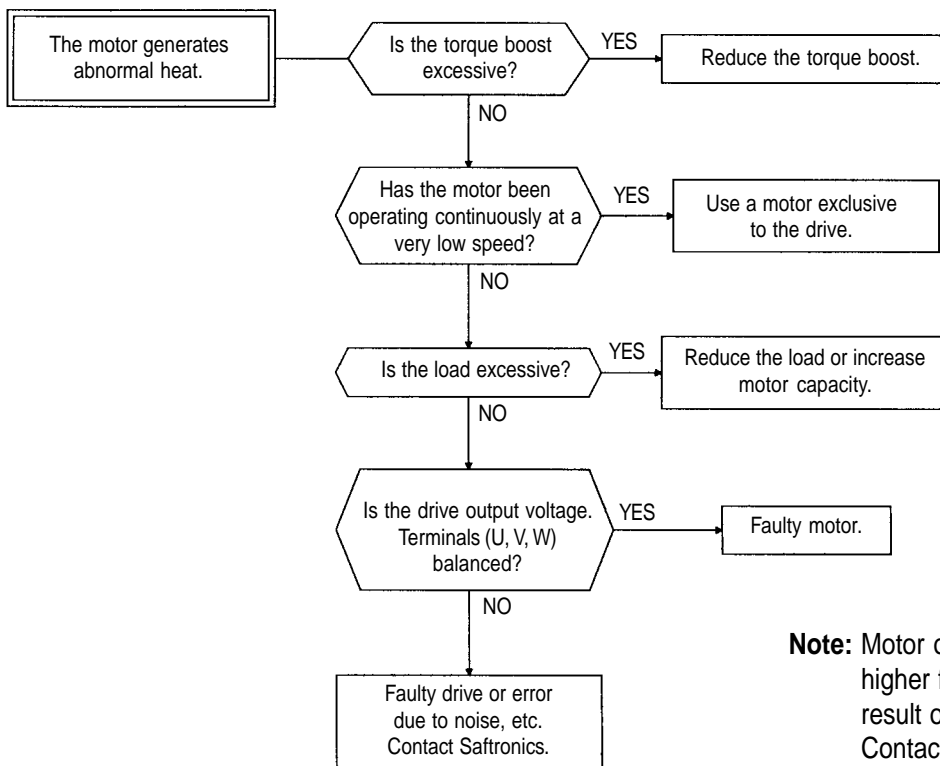
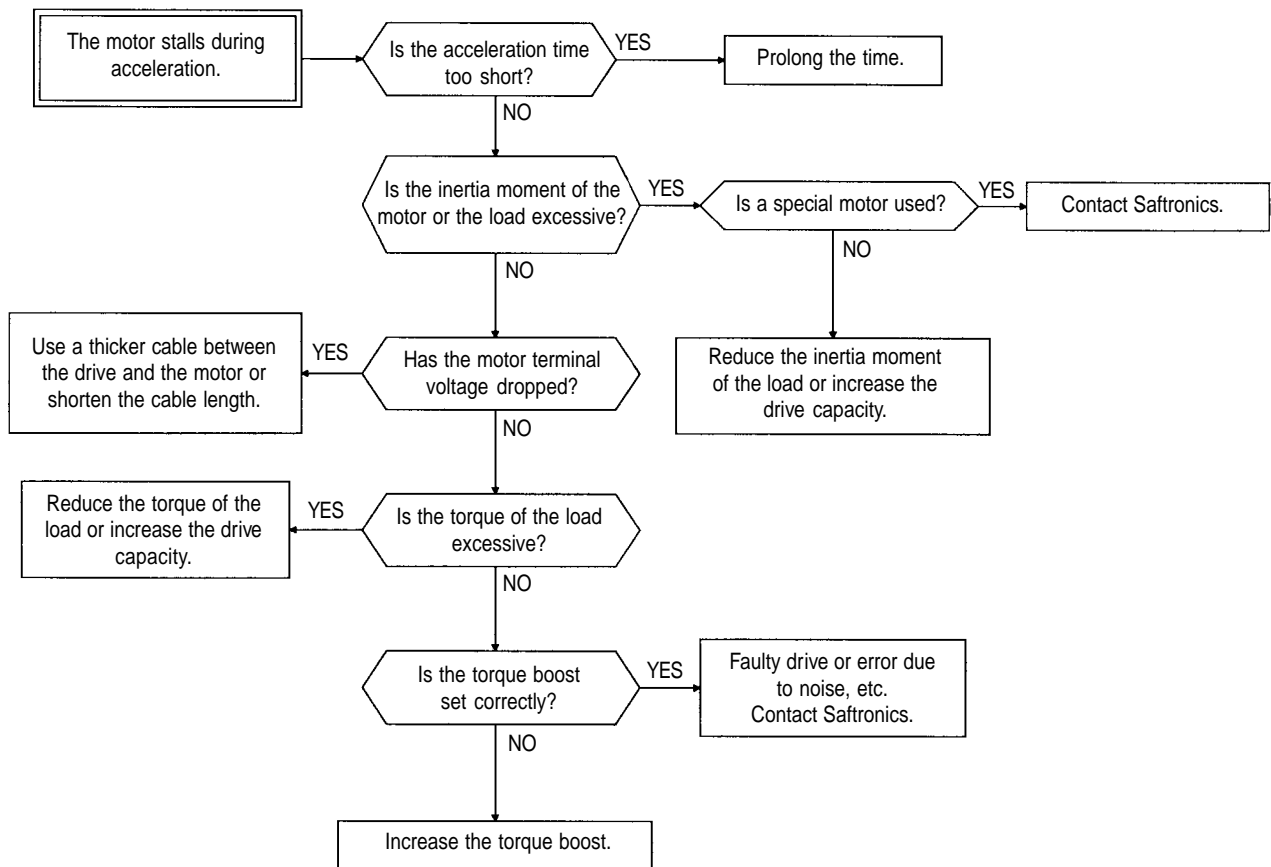

Note: Motor overheating following a higher frequency setting is likely the result of the current wave form. Contact Safronics.

8. Maintenance and Inspection

Proceed with daily inspection and periodic inspection to prevent malfunction and ensure long-term reliability. Some tips regarding things to look for during these inspections are listed below.

8.1 Daily Inspections

During operation, a visual inspection for abnormal operation can take place externally without removing the covers.

The inspection should cover the following areas:

- (1) The performance, according to standard specifications, is as expected.
- (2) The environment conforms to standard specifications.
- (3) The keypad panel display is normal.
- (4) There are no abnormal sounds, vibrations, or odors.
- (5) There are no indications of overheating or discoloration.

8.2 Periodic Inspections

Periodic inspections should be made after stopping operations, cutting off the power source, and removing the surface cover.

Note that after turning off the power, the smoothing capacitors in the DC section of the main circuit take time to discharge. To prevent electric shock, confirm with a multimeter that the voltage has dropped below the safety value (25 V DC or below) after the charge lamp (CRG) goes off.

WARNING

- Start the inspection at least five minutes after turning off the power supply for inverters rated at 30 Hp or less. Wait at least ten minutes for inverters rated at 40 Hp or more. Check that the charge lamp (CRG) went off and that the voltage is 25V DC or less between terminals P(+) and N(-). Electric shock may result.
- Only authorized personnel should perform maintenance and component replacement operations. Remove metal jewelry such as watches and rings, and always use insulated tools.
- Never modify the drive. Electric shock or injury may result.

Area to Check	Items to Check	How to inspect	Evaluation Criteria	
Environment	<ol style="list-style-type: none"> 1) Check the ambient temperature, humidity, vibration, atmosphere (dust, gas, oil mist, water drops). 2) Is the area surrounding the equipment free of foreign objects. 	<ol style="list-style-type: none"> 1) Conduct a visual inspection and use appropriate meters. 2) Visual inspection 	<ol style="list-style-type: none"> 1) Results comply with all standard specifications. 2) The area is clear. 	
Voltage	Are the voltages in the main circuit and the control circuit normal?	Measure with a multi-meter.	Results comply with all standard specifications.	
Keypad panel	<ol style="list-style-type: none"> 1) Is the display hard to read? 2) Are the characters complete? 	<ol style="list-style-type: none"> 1) Visual inspection 2) Visual inspection 	1), 2) The display can be easily read and characters are normal.	
Structure (frame or cover)	<ol style="list-style-type: none"> 1) Is there abnormal sound or vibration? 2) Are nuts or bolts loose? 3) Is there deformation or damage? 4) Is there discoloration as a result of overheating? 5) Are there stains or dust? 	<ol style="list-style-type: none"> 1) Visual and aural inspection 2) Tighten 3), 4), 5) Visual inspection 	1), 2), 3), 4), 5) No abnormalities	
Main Circuit	Common	<ol style="list-style-type: none"> 1) Are there loose or missing nuts or bolts? 2) Are there deformations, cracks, damage, or discoloration due to overheating or deterioration in the equipment and insulation? 3) Are there stains and dust? 	<ol style="list-style-type: none"> 1) Tighten. 2), 3) Visual inspection 	1), 2), 3) No abnormalities Note: Discoloration of the bus bar does not indicate a problem.
	Conductors and wiring	<ol style="list-style-type: none"> 1) Is there discoloration or distortion of a conductor due to overheating? 2) Are there cracks, crazing or discoloration of the cable sheath? 	1), 2) Visual inspection	1), 2) No abnormalities
	Terminal block	Is there damage?	Visual inspection	No abnormalities
	Smoothing capacitor	<ol style="list-style-type: none"> 1) Is there electrolyte leakage, discoloration, crazing, or swelling in the case? 2) Is the safety valve not protruding, or are valves protruding too far? 3) Measure the capacitance if necessary. 	<ol style="list-style-type: none"> 1), 2) Visual inspection 3) *Estimate life expectancy from maintenance information and from measurements using capacitance measuring equipment. 	<ol style="list-style-type: none"> 1), 2) No abnormalities 3) Capacitance is within 85% of initial value
	Resistor	<ol style="list-style-type: none"> 1) Is there any unusual odor or damage to the insulation by overheating? 2) Is there an open circuit? 	<ol style="list-style-type: none"> 1) Visual and olfactory inspection 2) Conduct a visual inspection or use a multi-meter by removing the connection on one side. 	<ol style="list-style-type: none"> 1) No abnormalities 2) Less than about $\pm 10\%$ of the indicated resistance value
	Transformer and reactor	Is there abnormal buzzing or an unpleasant smell?	Aural, olfactory, and visual inspection	No abnormalities
	Magnetic conductor and relay	<ol style="list-style-type: none"> 1) Is there a rattling noise during operation? 2) Are the contacts rough? 	<ol style="list-style-type: none"> 1) Aural inspection. 2) Visual inspection. 	1), 2) No abnormalities
Control Circuit	Control PC board and connector	<ol style="list-style-type: none"> 1) Are there any loose screws or connectors? 2) Is there an unusual odor or discoloration? 3) Are there cracks, damage, deformation, or excessive rust? 4) Is there electrolyte leakage or damage to the capacitor? 	<ol style="list-style-type: none"> 1) Aural inspection. 2) Visual and olfactory inspection 3) Visual inspection 4) *Estimate life expectancy by visual inspection and maintenance information 	1), 2), 3), 4) No abnormalities
Cooling System	Cooling fan	<ol style="list-style-type: none"> 1) Is there abnormal sound or vibration? 2) Are nuts or bolts loose? 3) Is there discoloration due to overheating? 	<ol style="list-style-type: none"> 1) Aural and visual inspection. Turn manually (confirm the power is off). 2) Tighten. 3) Visual inspection 4) *Estimate life expectancy by maintenance information 	<ol style="list-style-type: none"> 1) The fan must rotate smoothly. 2), 3) No abnormalities
	Ventilation	Is there foreign matter on the heat sink or intake and exhaust ports?	Visual inspection	No abnormalities

See additional notes on following page.

Note: If equipment is stained, wipe with a clean cloth. Use a vacuum to remove dust. *Estimate of life expectancy based on maintenance information.

The maintenance information is stored in the drive keypad panel. It indicates the electrostatic capacitance of the main circuit capacitors and the life expectancy of the electrolytic capacitors on the control PC board and the cooling fans. Use this data as the basis to estimate the life expectancy of parts.

1) Determining the capacitance of the main circuit capacitors

This drive is equipped with a function to automatically indicate the capacitance of the capacitors installed in the main circuit when powering up the drive after disconnecting the power according to the prescribed conditions.

The initial capacitance values are set in the drive when shipped from the factory, and the decrease ratio (%) to those values can be displayed.

Use this function as follows:

- (1) Remove any option boards from the inverter. Disconnect the DC bus connections to the main circuit [Terminals P(+) and N(-)] from the braking unit or other inverters, if connected. The power factor correcting reactor (DC reactor) does not need be disconnected.

A power supply introduced to the auxiliary input [Terminals R0, T0] that provides control power should be isolated.

- (2) Disable all the digital inputs (FWD, REV, X1-X9) on the control terminals. Also disconnect RS485 serial communication, if used.

Turn on the main power supply. Confirm that the cooling fan is rotating and that the inverter is not operating. (There is no problem if the "OH2 External thermal relay tripped" function is activated by the digital input terminal.)

- (3) Turn the main power off.
- (4) Turn on the main power again after verifying that the charge lamp is completely off.
- (5) Open the maintenance information on the keypad panel and confirm the capacitance values of the built-in capacitors.

2) Life expectancy of the PC control board

The actual capacitance of a capacitor is not measured in this case. However, the integrated operating hours for the control power supply, multiplied by the life expectancy coefficient as defined by the temperature inside the inverter, will be displayed. Hence, the hours displayed may not agree with the actual operating hours, depending on the operational environment.

Since the integrated hours are counted in unit hours, power input for less than one hour will be disregarded.

3) Life expectancy of cooling fan

The integrated operating hours of the cooling fan are displayed. Since the integrated hours are counted in unit hours, power input for less than one hour will be disregarded.

The displayed value should be considered a rough estimate because the actual life of a cooling fan is influenced significantly by the temperature.

Table 8.-2 Rough estimate of life expectancy using maintenance information

Parts	Recommended Level
Capacitor in main circuit	85% or less of the initial value
Electrolytic capacitor on control PC board	61,000 hours
Cooling fan	40,000 hours (5 Hp or less), 25,000 hours (Over 7.5 Hp)*

* Estimated life expectancy of a ventilation-fan at inverter ambient temperature of 40°C







8.3 Main Circuit Measurements

The indicated values depend on the type of meter, because the harmonic component is included in the voltage and current of the main circuit power (input) and the output (motor) side of the inverter. If measuring with a meter for commercial power frequency use, use the meters shown in Table 8.3.1.

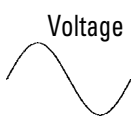
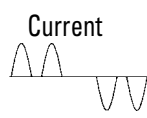
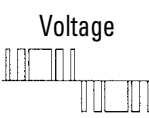
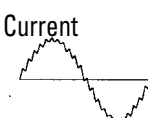
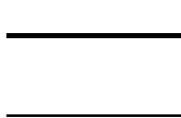
The power factor cannot be measured using power factor meters currently available on the market, which measure the phase difference between voltage and current. If power factors must be measured, measure the power, voltage, and current on the input side and output side, then calculate the power factor using the following formula:

$$\text{Power factor} = \frac{\text{Power [W]}}{\sqrt{3} \times \text{Voltage [V]} \times \text{Current [A]}} \times 100 [\%]$$

Table 8.3-. Meters for Measuring Main Circuit

Item	Input (power supply) Side			Output (motor) Side			DC Link Circuit Voltage P(+) - N(-)
							
Meter name	Ammeter AR,S,T	Voltmeter VR,S,T	Powermeter WR,S,T	Ammeter AU,V,W	Voltmeter VU,V,W	Powermeter WU,V,W	DC Voltmeter V
Meter type	Moving iron type	Rectifier or moving-iron type	Digital power meter	Moving iron type	Rectifier type	Digital power meter	Moving coil type
Symbol							

Note: If the output voltage is measured with a rectifier type meter, an error may occur. Use a digital AC power meter to ensure accuracy.

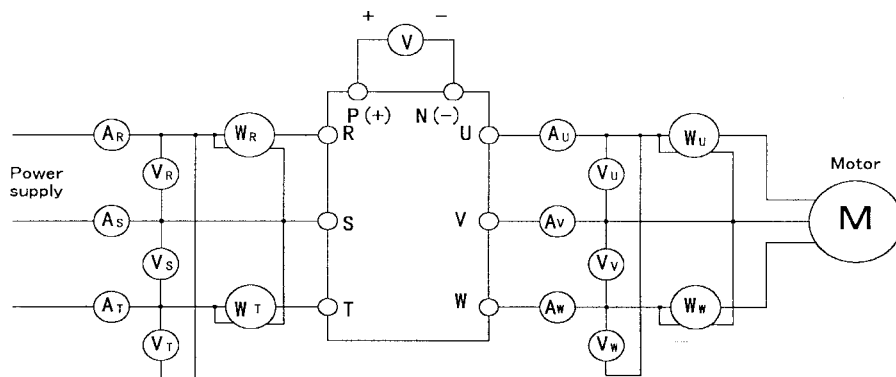

8.4 Insulation Test

Avoid megger testing on an drive since an insulation test was completed at the factory. If a megger test must be completed, proceed as described below. Incorrect testing methods may result in product damage.

If the specifications for the dielectric strength test are not followed, the drive may be damaged. If a dielectric strength test must be completed, contact your local distributor or nearest Fuji Electric sales office.

(1) Megger test for the main circuit

1. Use a 500V DC megger and isolate the main power before starting measurement.
2. If the test voltage is connected to the control circuit, remove all connection cables to the control circuit.
3. Connect the main circuit terminals using common cables, as shown in Fig. 8-4-1.
4. Perform the megger test only between the common cables connected to the main circuit and ground (Terminal \ominus).
5. A megger indicating 5M Ohm or more is normal. (This is the value measured with only the drive connected.)

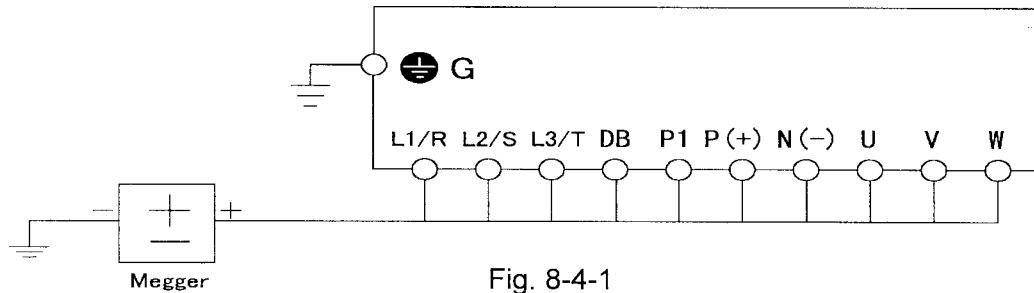

Fig. 8-4-1
Megger test

(2) Insulation test in the control circuit

Megger and dielectric strength tests are not performed on the control circuit. Use a resistance multimeter with a high resistance range to check the control circuit.

1. Remove all external cables from the control circuit terminals.
2. Conduct a continuity test between grounds. A result of 1M Ohm or more is normal.

(3) Exterior main circuit and sequence control circuit

Remove all cables from drive terminals to ensure that test voltage is not applied to the drive.

8.5 Replacement Parts

The life expectancy of a part depends on the type of part, the environment, and operating conditions. Parts should be replaced as shown in Table 8-5-1.

Table 8-5-1 Part replacement

Part name	Standard period for replacement	Comments
Cooling fan	3 years	Exchange for a new part
Smoothing capacitor	5 years	Exchange for a new part (determine after checking)
Electrolytic capacitor on the PC board	7 years	Exchange for a new PC board (determine after checking)
Fuse	10 years	Exchange for a new part
Other parts	—	Determine after checking

9. Warranty Parts and Service

The purpose of this section is to provide specific instructions to the user of the standard drive referenced in this book regarding warranty administration and how to obtain assistance on both in-warranty and out-of-warranty equipment.

For all warranty procedures, refer to section 10 of this instruction manual to identify the part or assembly.

If assistance is required to determine warranty status, identify defective parts, or obtain the name of your local distributor, call:

Saftronics, Inc.

Technical Support

5580 Enterprise Parkway

Ft. Myers, FL 33905

Phone: 941-693-7200

Fax: 941-693-2431

Before calling the number at left to determine warranty status, the drive serial number will be required. This is located on the drive nameplate. If the drive is still under warranty, further information will be required per the "In-Warranty Failure Checklist" shown on page 9-2 of this instruction manual. Please complete and return the Warranty Registration Card located inside back cover.

OUT-OF-WARRANTY PROCEDURES

When the defective part has been identified, contact your local authorized Saftronics drives distributor to order replacement parts.

IN-WARRANTY FAILURE CHECKLIST

To assist with warranty troubleshooting, the following information is required. This data is needed to evaluate the cause in an effort to eliminate any further failures.

Model No.: _____

Serial No.: _____

Start-Up Date: _____

Failure Date: _____

Status When Failure Occurred (check one):

Power-Up _____ Running _____ Accel _____ Decel _____

Explanation of Failure _____

Application Information (check Yes or No)

Input Transformer: Yes _____ No _____

If Yes: KVA _____

L1 Volts _____ L2 Volts _____ L3 Volts _____

Power Factor Correction Capacitors: Yes _____ No _____

If Yes: Microfarrad _____

Other Equipment on Same Power Yes _____ No _____

If Yes, what?

Line Reactor on Input Yes _____ No _____

Input Starter Yes _____ No _____

Output Starter Yes _____ No _____

Motor Overloads Yes _____ No _____

Control Terminals Used (circle if used)

	30A	Y5A	CMY	Y3	Y1	C1	FMA	FMP	PLC	X1	X2	X3	X4	X5	X6	X7	X8	X9
30C	30B	Y5C	Y4	Y2	11	12	13	V2	CM	CM	FWD	REV	P24	P24	DX	DX	SD	

Function Codes Different From Factory Settings

Function Code	Setting	Function Code	Setting
_____	_____	_____	_____
_____	_____	_____	_____
_____	_____	_____	_____

Failure Message (see Section 4)

Latest Fault _____ Previous Faults: No Message _____

Hz _____ 1. _____

A _____ 2. _____

V _____ 3. _____

After all of the Checklist information is acquired, contact the following number for assistance: (941) 693-7200

When returning failed parts, reference the RMA# on the shipping documents that came with the replacement parts and ship failed parts to: Saftronics. Mark RMA# on carton.

10. Replacement Parts

Catalog No.	Rating	Drive HP & Quantity per drive											
		1/4	1/2	1	2	3	5	7.5	10	15	20	25	30
GP10 230VAC, 30HP and Below													
Main Control Card													
SG11CPCBB1		1	1	1	1	1	1	1	1	1	1	1	1
Gate Driver & Power Supply Card													
SG11PPCBG2002		1											
SG11PPCBG2004			1										
SG11PPCBG2008				1									
SG11PPCBG2015					1								
SG11PPCBG2022						1							
SG11PPCBG2037							1						
SG11PPCBG2055								1	1				
SG11PPCBG2075										1			
SG11PPCBG2110											1		
SG11PPCBG2150												1	
SG11PPCBG2185													1
KEYPAD PANEL (Only one type per drive)													
STPAG11S	NEMA Type1	1	1	1	1	1	1	1	1	1	1	1	1
STPAG11S4	NEMA Type4	1	1	1	1	1	1	1	1	1	1	1	1
CAPACITOR UNIT													
SG11CAP01	PCB	*	*	*									
SG11CAP02	PCB				1		1						
SG11CAP03	PCB							1					
SG11CAP09	2700 μ Fx1								1	1		2	
SG11CAP10	3900 μ Fx1										1		2
SG11CAP11	4700 μ Fx2												2
* Located on Gate drive & Power supply Card													
FAN													
SG11FAN01					1	1	1						
SG11FAN202								1	1	1	2	2	2
POWER MODULE													
SPS11046	30A 600V	*	*	*	1	1							
SPS11047	50A 600V						1						
S6MBP75RS060	75A 600V							1	1				
S6MBP100RS060	100A 600V									1			
S6MBP150RS060	150A 600V										1	1	
S6MBP200RS060	200A 600V												1
* Located on Gate drive & Power supply Card													
RECTIFIER MODULE													
SPVC758	75A 800V	*	*	*	*	*	*			1	1	1	
SCLK120AA80	120A 800V											1	1
SCLK180AA80	180A 800V												1
* Located on Gate drive & Power supply Card													
CHARGE RESISTOR													
S30W66	30W 6.6WJ	*	*	*	*	*	*			1	1	1	
S80W25	80W 2.5WJ											1	1
* Located on Gate drive & Power supply Card													
FRONT COVER													
SG11UPCG008P		1	1	1									
SG11UPCG040P					1	1	1						
SG11UPCG075P								1	1	1			
SG11UPCG220P											1	1	1
INTERNAL DB RESISTOR													
SG11DBR0082	100W 40W	1	1	1									
SG11DBR0372	40W 80W				1	1	1						
SG11DBR0752								1	1				

Catalog No.	Rating	Drive HP & Quantity per drive						
		40	50	60	75	100	125	150
GP10 230 VAC, 40HP and Above								
Main Control Card								
SEP4113B1		1	1	1	1	1	1	1
Gate Driver & Power Supply Card								
SEP3956C1		1	1					
SEP3956C2				1				
SEP3956C3					1	1		
SEP3957C1							1	
SEP3957C2								1
KEYPAD PANEL								
STPAG11S4		1	1	1	1	1	1	1
DC CAPACITOR								
SLNT2G302MSMAFF	400V 3000 μ F	4	4					
SHCGHA2G362N3K	400V 3600 μ F			4				
SHCGHA2G452NE3K	400V 4500 μ F				4			
SHCGHA2G592N3K	400V 5900 μ f					4	5	6
FAN								
SFBA09A24H1B0 (Standard)		1	1	1	2	2	2	4
S4715PS22TB30		2	2					
2750MTP15				2	2		3	4
S6250MG1 (For NEMA12 Heatsink)	80W 7.5ohm					2		
SUHS4556MLOT1		2	2					
S2750MTP15OT1				2	2		3	4
SU6250MKG1LTPOT1						2		
IGBT MODULE								
S2MBi300NB060		3	3					
SCM400DU12H206				3				
S2MBi300NB06001					6	6	9	12
RECTIFIER MODULE								
SPD1008AC		3	3	6	6	9	9	9
CHARGE RESISTOR								
SHF5C5504		1	1	1	1	1	2	2
DC CONTACTOR								
SFC3UL	AC220VAUX2B	1	1					
SFC1UL	AC220VAUX2B			2	2	2		
SFC4UL	AC220VAUX2B						2	
SSC7NUL	AC200-240V							1
DC FUSE								
SCR2L260UL		1	1	1				
SCR2L400UL					1	1		
SA50P6004							1	1
INPUT MODULE CARD								
SEP3985C1		1	1	1	1	1		
SEP3985C3							1	1

Catalog No.	Rating	Drive HP & Quantity per drive										
		1/2	1	2	3	5	7.5	10	15	20	25	30

GP10 460 VAC, 30HP and Below

Main Control Card

SG11CPCBB1		1	1	1	1	1	1	1	1	1	1	1	1
------------	--	---	---	---	---	---	---	---	---	---	---	---	---

Gate Driver & Power Supply Card

SG11PPCBG4004		1											
SG11PPCBG4008			1										
SG11PPCBG4015				1									
SG11PPCBG4022					1								
SG11PPCBG4037						1							
SG11PPCBG4055							1	1					
SG11PPCBG4075									1				
SG11PPCBG4110										1			
SG11PPCBG4150											1		
SG11PPCBG4185												1	

KEYPAD PANEL (Only one type per drive)

STPAG11S	NEMA Type1	1	1	1	1	1	1	1	1	1	1	1	1
STPAG11S4	NEMA Type4	1	1	1	1	1	1	1	1	1	1	1	1

CAPACITOR UNIT

		*	*										
SG11CAP04	PCB			1									
SG11CAP05	PCB				1								
SG11CAP06	PCB					1							
SG11CAP07	1500 μ Fx2						2	2					
SG11CAP08	2000 μ Fx2								2				
SG11CAP09	2700 μ Fx2									2			
SG11CAP10	3900 μ Fx2										2		
SG11CAP11	4700 μ Fx2											2	

* Located on Gate drive & Power supply Card

FAN

SG11FAN01				1	1	1							
SG11FAN02							1	1	1	2	2	2	

POWER MODULE

		*	*										
SPS12046	15A 1200V			1	1								
SPS12047	25A 1200V					1							
S6MBP50RS120	50A 1200V						1	1	1				
S6MBP75RS120	75A 1200V									1	1		
S6MBP100RS120	100A 1200V											1	

* Located on Gate drive & Power supply Card

RECTIFIER MODULE

		*	*	*	*	*							
SPVC7516	75A 1600V						1	1	1				
SCLK70AA160	70A 1600V									1	1		
SCLK100AA160	100A 1600V											1	

* Located on Gate drive & Power supply Card

CHARGE RESISTOR

		*	*	*	*	*							
S30W200	30W 20WJ						1	1	1				
S80W100	80W 10WJ									1	1	1	

* Located on Gate drive & Power supply Card

FRONT COVER

SG11UPCG008P		1	1										
SG11UPCG040P				1	1	1							
SG11UPCG075P							1	1	1				
SG11UPCG220P										1	1	1	

Catalog No.	Rating	Drive HP & Quantity per drive															
		40	50	60	75	100	125	150	200	250	300	350	400	450	500	600	700

GP10 460VAC, 40HP and Above

Main Control Card

SEP4113B1		1	1	1	1	1	1	1	1	1	1	1	1	1	1	1	1	1
-----------	--	---	---	---	---	---	---	---	---	---	---	---	---	---	---	---	---	---

Gate Driver & Power Supply Card

SEP3959C1		1	1															
SEP3959C2				1														
SEP3959C3					1	1												
SEP3959C4							1											
SEP3959C5								1	1									
SEP3957C3										1	1							
SEP3957C4												1	1	1				
SEP3957C5															1	1	1	1

GATE DRIVE AMPLIFIER CARD

SEP4142															3	3	3	3
---------	--	--	--	--	--	--	--	--	--	--	--	--	--	--	---	---	---	---

KEYPAD PANEL

STPAG11S4		1	1	1	1	1	1	1	1	1	1	1	1	1	1	1	1	1
-----------	--	---	---	---	---	---	---	---	---	---	---	---	---	---	---	---	---	---

DC CAPACITOR

SLNT2G302MSMAFF	400V 3000μF	4	4															
SHCGHA2G362N3K	400V 3600μF			4														
SHCGHA2G452NE3K	400V 4500μF				4			6										
SHCGHA2G592N3K	400V 5900μF					4	4		6	8		12						
SHCGHA2G742N3K	400V 7400μF										8		12	12				
SHCGHA2G932N3KG	400V 9300μF														20	20	26	26

FAN UNIT

SFBA09A24H1B0		1	1	1	1	1	2	2	2	3	3	4	4	4	4	4		
SMRS18-DUL															3	3	4	4
STHB1-UHS4556M																	4	4
S(Standard)																		
S4715PS22TB30		2	2															
S2750MTP15				2	2			3	3									
S6250MG1						2	2			3	3	4	4	4				
(For NEMA12 Heatsink)																		
SUHS4556MLOT1		2	2															
S2750MTP15OT1				2	2			3	3									
SU6250MKG1LTPOT1						2	2			3	3	4	4	4				

IGBT MODULE

S2MBi150PC14002		3	3															
SCM200DU24H203				3														
S2MBi300P14002					3	3												
SCM200DU24H202							6											
S2MBi300P14003								6	6	9	9	12	12	12	18	18	24	24

RECTIFIER MODULE

SPD6016A		3	3	3						12	12							
SPD10016A					3	3	6	6	6			12	12	12	24	24	30	30

Catalog No.	Rating	Drive HP & Quantity per drive															
		40	50	60	75	100	125	150	200	250	300	350	400	450	500	600	700

GP10 460VAC, 40HP and Above

IGBT MODULE

S2MBi150PC14002		3	3															
SCM200DU24H203				3														
S2MBi300p14002					3	3												
SCM200DU24H202							6											
S2MBi300P14003								6	6	9	9	12	12	12	18	18	24	24

RECTIFIER MODULE

SPD6016A		3	3	3						12	12							
SPD10016A					3	3	6	6	6			12	12	12	24	24	30	30

CHARGE RESISTOR

SHF5C5504	80W 7.5ohm	1	1	1	1	1	1	2	2	2	3	3	4	4				
SGRZG400															2	2	2	2

DC CONTACTOR

SFC1UL	AC220VAUX2B	1	1	1	1	1	2	2	2									
SFC4UL	AC220VAUX2B									2	2							
SSC7NUL	AC200-240V											1						
SSC8NUL	AC200-240V												1	1				
SSCN8	AC200-240V														2	2	2	2

DC FUSE

SCR6L150UL	600V 150A	1	1	1														
SCR6L200UL	600V 200A				1													
SCR6L300UL	600V 300A					1	1											
SA70Q4004								1	1									
SA70Q5004										1								
SA70Q6004											1	1						
SA70QS8004													1	1				
SA70P16004TA															1	1		
SA70P20004																	1	1

TRANSFORMER

SHF5C55025512VA		1	1															
SHF5C550312524VA				1	1	1	1											
SHF5B661330016VA								1	1	1	1	1	1	1				
SHF5B395170020VA															1	1	1	1

INPUT MODULE CARD

SEP3985C2		1	1	1	1	1	1	1	1									
SEP3985C4										1	1	1	1	1	1	1	1	1

11. Specifications

11.1 Standard Specifications

Three-phase 230V series - Variable Torque																					
Type designation																					
GP10E1ST32_** (NEMA Type1)																					
GP10E2ST32_** (NEMA Type2)																					
GP10E4ST32_** (NEMA Type4)																					
GP10E8ST32_** (Open, Type 12 Heatsink)																					
GP10E9ST32_** (Open)																					
** Indicates product revision																					
Nominal 230V system applied mot	HP	/41	1/2	1	2	3	5	7.5	10	15	20	25	30	40	50	60	75	100	125	150	
Output ratings	kVA	0.59	1.1	1.9	3.1	4.3	6.7	8.7	11	16	21	26	31	45	57	71	85	112	137	165	
Rated Voltage *2)	V	3-phase, 200V /50Hz; 200V /220V /230V /60Hz																			
Rated Current *3)	A	1.5	3.0	5.0	8.0	11	17	22	29	42	55	67	78	115	145	180	215	283	346	415	
Overload Capability	110% of rated current for 1min																				
Rated Frequency	Hz	50, 60Hz																			
Phases, Voltage, Frequency	3-phase, 200 to 230V , 50/60Hz																				
Voltage / frequency variations	-Voltage : +10 to -15% (Voltage unbalance *5) : 2% or less																				
Momentary voltage dip capability *6)	When the input voltage is 165V or more, the inverter can be operated continuously. If the AC Line voltage is below rated, the drive will not provide the 15ms ride-thru. The smooth recovery method is selectable.																				
Output frequency	Maximum Freq.	50 to 120Hz																			
	Base Freq.	25 to 120Hz																			
	Setting	0.1 to 60Hz . Continuous time : 0.0 to 10.0s																			
	Starting Freq.	0.75 to 15kHz																			
	Carrier Freq. *8)	The minimum carrier frequency changes depend on maximum output frequency. 0.75 to 10kHz																			
	Accuracy (Stability)	-Analog setting : ±0.2% of Maximum frequency (at 25 ±10 degrees C) -Digital setting : ±0.01% of Maximum frequency (at -10 to +50 degrees C)																			
	Setting resolution	-Analog setting : 1/3000 of Maximum frequency ex.) 0.02Hz at 60Hz , 0.04Hz at 120Hz -Digital setting : 0.01Hz at Maximum frequency of up to 99.99Hz (0.1Hz at Maximum frequency of 100Hz and above)																			
		-Link setting : Two methods are selectable. 1/20000 of Maximum frequency ex. 0.003Hz at 60Hz 0.01Hz (Fixed)																			
Control	Volt/Freq Characteristic	80 to 240V (with AVR control) at base and maximum frequency. adjustable																			
	Torque boost	Constant torque load Variable torque load																			
	Automatic (setting code)	0.0																			
	Manual (setting code)	2.0 to 20.0 0.1 to 1.9																			
Enclosure		NEMA Type1, Type4																			
Cooling method		Natural																			
Standards		NEMA Type1, Type12 Fan cooling																			
		-EMC directive																			
		-LOW VOLTAGE directive																			
		-IEC 61800-2 (Rating, specifications for low voltage adjustable frequency a.c. power drive systems) -IEC 61800-3 (EMC product standard including specific test methods)																			

NOTES

- *1) Inverter output capacity [kVA] at 230V.
- *2) Output voltage is proportional to the power supply voltage and can't exceed the power supply voltage.
- *3) Current derating may be required in case of low impedance load such as high frequency motor.
- *5) Reference to the IEC 61800-3(5.2.3)

$$\text{Unbalance in power supply voltage [\%]} = \frac{(\text{Maximum voltage[V]} - \text{Minimum voltage[V]})}{3\text{-phase averaging voltage[V]}} \times 100 \text{ [\%]}$$

- *6) 85% load
- *8) If carrier frequency is set at more than 10kHz and an overheat condition (detected by internal thermal sensor) occurs, drive will automatically reduce carrier frequency to 8kHz , in order to avoid trip. (Available up to 30HP unit)

Three-phase 460V series - Variable Torque

Type designation	HP	1	2	3	5	7.5	10	15	20	25	30	35	40	50	60	75	91	112	150	176	210	304	304	377	415	485	520	650	740	840	960	
GP10E1ST34_** (NEMA Type1)																																
GP10E2ST34_** (NEMA Type12)																																
GP10E4ST34_** (NEMA Type 4)																																
GP10E8ST34_** (Open, Type 12 Heatsink)																																
GP10E9ST34_** (Open)																																
Nominal 460V system applied motor	HP	1/2	1	2	3	5	7.5	10	15	20	25	30	35	40	50	60	75	91	112	150	176	210	304	304	377	415	485	520	650	740	840	960
Rated Capacity *1)	kVA	1.1	1.9	2.9	4.3	7.1	9.3	13.1	18.3	23.9	29.4	35.0	47	59	72	89	119	140	167	242	242	242	242	300	330	386	414	578	590	669	765	
Rated Voltage *2)	V	3-phase, 380V, 400V, 415V/50Hz, 380V, 400V, 440V, 460V/60Hz																														
Rated Current *3)	A	1.5	2.5	3.7	5.5	9.0	12.5	16.5	23	30	37	44	60	75	91	112	150	176	210	304	304	304	304	377	415	485	520	650	740	840	960	
Overload Capability	110% of rated current for 1min, 110% of rated current for 1min, 3-phase, 380 to 440V/50Hz, 380 to 480V/60Hz * 380V/50Hz and 380 to 415V/60Hz *4)																															
Rated Frequency	Hz	50, 60Hz																														
Phases, Voltage, Frequency	3-phase, 380 to 480V, 50/60Hz																															
Input ratings	Voltage / frequency variations Momentary voltage dip capability*6) -Voltage: +10 to +15% (Voltage unbalance *5); 2% or less When the input voltage is 310V or more, the inverter can be operated continuously. If the AC line voltage is below rated, the drive will not provide the 15ms ride-thru. The smooth recovery method is selectable.																															
Output frequency	Maximum Freq. : 0.75 to 10kHz Base Freq. : 0.1 to 60Hz, Continuous time: 0.0 to 10.0s Starting Freq. : 0.75 to 15kHz Carrier Freq. *8) : 0.75 to 10kHz The minimum carrier frequency changes depend on maximum output frequency. -Analog setting : ±0.2% of Maximum frequency (at 25 ±10 degrees C) -Digital setting : ±0.01% of Maximum frequency (at -10 to +50 degrees C) -Analog setting : 1/2000 of Max. frequency ex.) 0.02Hz at 60Hz, 0.04Hz at 120Hz -Digital setting : 0.01Hz at Maximum frequency of up to 99.99Hz (0.1Hz at Maximum frequency of 100Hz and above) -Link setting : Two methods are selectable. 1/20000 of Maximum frequency ex. 0.006Hz at 60Hz 0.01Hz (Fixed)																															
Control	Voll/Freq Characteristic : 320 to 480V (with AVR control) at base and maximum frequency, adjustable Torque boost : Automatic (setting code) : 0.0 Manual (setting code) : 2.0 to 20.0 Variable torque load 0.1 to 1.9 NEMA Type1_Type4 : NEMA Type1_Type12 : Open, Open with NEMA Type 12 Heatsink, NEMA Type 1 Fan cooling																															
Enclosure	Natural																															
Cooling method	-UL/cUL -IEC 61800-2 (Rating, specifications for low voltage adjustable frequency a.c. power drive systems) -IEC 61800-3 (EMC product standard including specific test methods)																															
Standards	-EMC directive																															

NOTES
 *1) Inverter output capacity (kVA) at 460V.
 *2) Output voltage is proportional to the power supply voltage and can't exceed the power supply voltage.
 *3) Current derating may be required in case of low impedance load such as high frequency motor.
 *4) Change the tap of auxiliary transformer.
 380V/50Hz and 380 to 415V/60Hz: Change over CN UX connector from U1 part to U2 part. (Reference to the instruction manual)

Input voltage	CN UX connector
400 to 440V/50Hz, 440 to 480V/60Hz	U1 (Factory setting)
380V/50Hz, 380V or smaller)	U2
380 to 415V/60Hz (430V or smaller)	

*5) Reference to the IEC 61800-3(5.2.3)
 Unbalance in power supply voltage [%] = (Maximum voltage[V] - Minimum voltage[V]) / 3-phase averaging voltageV * 100 [%]

*6) 95% load
 *8) If carrier frequency is set at more than 10kHz and an overheat condition (detected by internal thermal sensor) occurs, drive will automatically reduce carrier frequency to 8kHz, in order to avoid trip. (Available up to 30HP unit)

Three-phase 230V series - Constant Torque

Type designation (* * indicate product revision)		F25	F50	001	002	003	005 007	010	015	020	025	030	040	050	060	075	100	125	150		
Nominal 230V system applied motor		HP	1/4	1/2	1	2	3	5	7.5	10	15	20	25	30	40	50	60	75	100	125	150
Output ratings	Rated Capacity *1)	kVA	0.59	1.1	1.9	3.1	4.3	6.7	9.9	13	18	23	29	34	45	57	71	85	112	137	
	Rated Voltage *2)	V	3-phase, 200V /50Hz , 200V ,220V ,230V /60Hz																		
	Rated Current *3)	A	1.5	3.0	5.0	8.0	11	17	25	33	46	59	74	87	115	145	180	215	283	346	
	Overload Capability	150% of rated current for 1min , 200% of rated current for 0.5s													150% of rated current for 1min , 180% of rated current for 0.5s						
Rated Frequency		Hz	50, 60Hz																		
Input ratings	Phases, Voltage, Frequency	3-phase, 200 to 230V , 50/60Hz												3-phase, 200 to 220V /50Hz, 200 to 230V /60Hz * 220 to 230V /50Hz *4),							
	Voltage / frequency variations	-Voltage : +10 to -15% (Voltage unbalance *5) : 2% or less)												-Frequency :+5 to -5%							
	Momentary voltage dip capability *6)	When the input voltage is 165V or more, the inverter can be operated continuously. When the input voltage drops below 165V from rated voltage, the inverter can be operated for 15ms . (within 85% load of nominal applied motors) The smooth recovery method is selectable.																			
Output frequency	Setting	Maximum Freq.	50 to 120Hz *11)																		
		Base Freq.	25 to 120Hz *11)																		
		Starting Freq.	0.1 to 60Hz, Continuous time : 0.0 to 10.0s																		
		Carrier Freq. *8)	0.75 to 15kHz The minimum carrier frequency changes depend on maximum output frequency.												0.75 to 10kHz			0.75 to 6kHz			
Accuracy (Stability)		-Analog setting : ±0.2% of Maximum frequency (at 25 ±10 degrees C) -Digital setting : ±0.01% of Maximum frequency (at -10 to +50 degrees C)																			
Setting resolution		-Analog setting : 1/3000 of Maximum frequency ex.) 0.02Hz at 60Hz -Digital setting : 0.01Hz at Maximum frequency of up to 99.99Hz (0.1Hz at Maximum frequency of 100Hz and above) -Link setting : Two methods are selectable. • 1/20000 of Maximum frequency ex.) 0.003Hz at 60Hz • 0.01Hz (Fixed)																			
Control	Volt/Freq Characteristic	80 to 240V (with AVR control) at base and maximum frequency, adjustable																			
	Torque boost	Constant torque load Automatic (setting code) : 0.0 Manual (setting code) : 2.0 to 20.0 Variable torque load - 0.1 to 1.9 *9)																			
Starting torque		200% (with Dynamic torque vector control selected)												180% (with Dynamic torque vector control selected)							
Braking	Standard	Braking torque	150%					100%					20% *10)			15 to 10% *10)					
		Time	10	5	5			2			3	2	No limit								
	Duty cycle	10	5	3	5	3	2	3	2	No limit											
	Options	Braking torque	150%																		
		Time	90	45	45	45	30	20			10			8			1			0	
Duty cycle		37	22	18	10	7	5			5			5			10					
DC injection braking		Starting frequency : 0.1 to 60.0Hz , Braking time : 0.0 to 30.0s , Braking level : 0 to 100% of rated current																			
Enclosure		NEMA Type1, Type4						NEMA Type1, Type12						Open, Open with NEMA Type 12 Heatsink, NEMA 1							
Cooling method		Natural						Fan cooling													
Standards		-UL/cUL						-LOW VOLTAGE directive -IEC 61800-2 (Rating, specifications for low voltage adjustable frequency a.c. power drive						-EMC directive -IEC 61800-3 (EMC product standard including specific test methods)							

NOTES

- *1) Inverter output capacity [kVA] at 230V.
- *2) Output voltage is proportional to the power supply voltage and can't exceed the power supply voltage.
- *3) Current derating may be required in case of low impedance load such as high frequency motor.
- *4) 220 to 230V/50Hz : Order individually
- *5) Reference to the IEC 61800-3(5.2.3)

$$\text{Unbalance in power supply voltage [\%]} = \frac{(\text{Maximum voltage[V]} - \text{Minimum voltage[V]})}{3\text{-phase averaging voltage[V]}} \times 100 \text{ [\%]}$$

*6) Input power : 85%

*8) If carrier frequency is set at more than 10kHz and an overheat condition (detected by internal thermal sensor) occurs, inverter will automatically reduce carrier frequency to 8kHz in order to avoid trip. (Available up to 30HP unit)

*9) When setting into 0.1, the starting torque gets 50%

*10) With a nominal applied motor. (Average torque when the motor decelerates and stops from 60Hz. It may change according to the motor loss.)

*11) Above 120Hz application, please contact the factory.

Three-phase 460V series-Constant Torque

Type designation (* * * indicate product revision)	HP	1/2	1	2	3	5	7.5	10	15	20	25	30	40	50	60	75	91	112	150	176	210	253	304	377	415	520	585	650	740	800
GP10E1ST34-*** (NEMA Type1)																														
GP10E2ST34-*** (NEMA Type12)																														
GP10E4ST34-*** (NEMA Type 4)																														
GP10E8ST34-*** (Open, Type 12 Heatsink)																														
GP10E9ST34-*** (Open)																														
Nominal 460V system applied motor																														
Rated Capacity *1)	kVA	1.1	1.9	2.9	4.3	7.1	10	14	19	23	31	35	47	59	72	89	119	140	176	210	253	304	377	415	520	585	650	740	800	
Rated Voltage *2)	V	3-phase, 380V, 400V, 415V/50Hz, 380V, 400V, 440V, 460V/60Hz																												
Rated Current *3)	A	1.5	2.5	3.7	5.5	9.0	13	18	24	30	39	45	60	75	91	112	150	176	210	253	304	377	415	520	585	650	740	800		
Overload Capability	110% of rated current for 1min, 200% of rated current for 0.5s																													
Rated Frequency	Hz	50, 60Hz																												
Phases, Voltage, Frequency	3-phase, 380 to 480V, 50/60Hz																													
Voltage/frequency variations	Voltage: -10 to +15% (Voltage unbalance *5): 2% or less)																													
Minimum voltage dip capability *6)	When the input voltage is 310V or more, the inverter can be operated continuously. When the input voltage drops below 310V from rated voltage, the inverter can be operated for 15ms. (less than 85% load of nominal applied motors) The smooth recovery method is selectable.																													
Maximum Freq.	50 to 120Hz *10)																													
Base Freq.	0.1 to 60Hz, Continuous time: 0.0 to 10.0s																													
Starting Freq.	0.75 to 15kHz																													
Carrier Freq. *8)	The minimum carrier frequency changes depend on maximum output frequency. -Analog setting : +0.2% of Maximum frequency (at 25 to 10 degrees C) -Digital setting : +0.01% of Maximum frequency (at -10 to +50 degrees C) -Analog setting : 1/3000 of Max. frequency, ex) 0.02Hz at 60Hz, 0.15Hz at 400Hz -Digital setting : 0.01Hz at Maximum frequency of up to 99.99Hz (0.1Hz at Maximum frequency of 100Hz and above) -Link setting : Two methods are selectable. 1. 20000 of Maximum Frequency ex.) 0.003Hz at 60Hz, 0.01Hz at 400Hz 0.01Hz (Fixed)																													
Accuracy (Stability)	0.75 to 10kHz																													
Setting resolution	0.75 to 6kHz																													
Volt/Freq Characteristic	320 to 480V (with AVR control) at base and maximum frequency, adjustable																													
Torque boost	Automatic (setting code) 0.0 Manual (setting code) 2.0 to 20.0																													
Starting torque	200% (with Dynamic torque vector control selected)																													
Braking torque	150% 5 100% 20% *11)																													
Standards	5 3 5 3 2 3 2 No limit No limit																													
Duty cycle	150%																													
Braking torque	45 30 20 10 8																													
Time	22 10 7 5 5																													
Duty Cycle	Starting frequency: 0.1 to 60.0Hz, Braking time: 0.0 to 30.0s, Braking level: 0 to 100% of rated current																													
DC injection braking	NEMA Type1, Type 4 NEMA Type1, Type12 Open, Open with NEMA Type 12 Heatsink, NEMA Type 1																													
Enclosure	Natural																													
Cooling method	-UL/ULC -LOW VOLTAGE directive -IEC 61800-2 Rating. -EMC directive -IEC 61800-3 (EMC product specifications for low voltage adjustable frequency a.c. standard including specific test methods) power drive systems)																													
Standards	Fan cooling																													

Notes:

- *1) Inverter output capacity (kVA) at 460V.
- *2) Output voltage is proportional to the power supply voltage and can't exceed the power supply voltage.
- *3) Current derating may be required in case of low impedance load such as high frequency motor.
- *4) Change the tap of auxiliary transformer. 380V/50Hz and 380 to 415V/60Hz. Change over CN LUX connector from U1 part to U2 part. (Reference to the instruction manual)

Input voltage	Input voltage	Input voltage
400 to 440V/50Hz, 440 to 480V/60Hz	CN LUX connector	
380V/50Hz (98W or smaller)	U1 (factory setting)	
380 to 415V/60Hz (430V or smaller)	U2	

*5) Reference to the IEC 61800-3 (5.2.3)

Unbalance in power supply voltage \rightarrow (Maximum voltage/V) - Minimum voltage/V) X 1.00 I %
3-phase averaging voltage/V

*6) Input power: 85%

*7) Carrier frequency is set at more than 10kHz and an overheat condition (detected by internal thermal sensor) occurs, inverter will automatically reduce carrier frequency to 8kHz.

*8) In order to avoid trip, (Available up to 30HP unit)

*9) When setting into 0.1, the starting torque gets 50%

*10) Above 120Hz application, please contact the factory

*11) With a nominal applied motor. (Average torque when the motor decelerates and stops from 60Hz. It may change according to the motor loss.)

NOTES

*1) Inverter output capacity (kVA) at 460V.
*2) Output voltage is proportional to the power supply voltage and can't exceed the power supply voltage.
*3) Current derating may be required in case of low impedance load such as high frequency motor.
*4) Change the tap of auxiliary transformer. 380V/50Hz and 380 to 415V/60Hz. Change over CN LUX connector from U1 part to U2 part. (Reference to the instruction manual)

Input voltage	Input voltage
400 to 440V/50Hz, 440 to 480V/60Hz	CN LUX connector
380V/50Hz (98W or smaller)	U1 (factory setting)
380 to 415V/60Hz (430V or smaller)	U2

*5) Reference to the IEC 61800-3 (5.2.3)

Unbalance in power supply voltage \rightarrow (Maximum voltage/V) - Minimum voltage/V) X 1.00 I %
3-phase averaging voltage/V

*6) Input power: 85%

*7) Carrier frequency is set at more than 10kHz and an overheat condition (detected by internal thermal sensor) occurs, inverter will automatically reduce carrier frequency to 8kHz.

*8) In order to avoid trip, (Available up to 30HP unit)

*9) When setting into 0.1, the starting torque gets 50%

*10) Above 120Hz application, please contact the factory

*11) With a nominal applied motor. (Average torque when the motor decelerates and stops from 60Hz. It may change according to the motor loss.)

11.2 Common Specifications

Item		Explanation	
Control	Control Method	Sinusoidal wave PWM control (with V/F control, torque vector control.)	
	Output frequency	Maximum frequency	50 to 120 Hz variable setting
		Base frequency	25 to 120 Hz variable setting
		Starting frequency	0.1 to 60 Hz variable setting Holding time: 0.0 to 10.0 s
		Carrier frequency	0.75 to 15k Hz (30 HP or less) 0.75 to 10k Hz (40-100 HP) 0.75 to 6kHz (125HP or more)
		Accuracy (stability)	Analog setting: +/- 0.2% or less of the max. frequency (at 25 +/- 10°C) Digital Setting: +/- 0.01% or less of the max frequency (-10 to +50°C)
		Setting resolution	Analog setting: 1/3000 of max. frequency (e.g. 0.02 Hz / 60 Hz, 0.05 Hz / 150 Hz) Digital setting: 0.01 Hz (99.99 Hz or less), 0.1 Hz (100.0 Hz or more)
	Voltage/frequency Characteristics	Output voltage at base frequency can be adjusted separately, such as 80 to 240V (200V series) or 320 to 480V (400V series)	
	Torque Boost	Auto: Optimum control corresponding to the load torque. Manual: 0.1 to 20.0 code setting (energy savings reduced torque, constant torque (strong) etc.)	
	Accelerating/decelerating time	0.01 to 3600s Four accelerating and decelerating time settings are possible independent of each other by selecting digital input signals. In addition to linear acceleration and deceleration, either S-shaped acceleration/deceleration (weak/strong) or curvilinear acceleration/deceleration	
Function equipped		Starting frequency: 0.0 to 60 Hz, braking time: 0.0 to 30.0s Braking levels: 0 to 80%	
		Frequency upper and lower limiter, bias frequency, frequency gain, jump frequency, pick-up operation, restart after momentary power failure, switching operation from line to drive, slip compensation control, automatic energy saving operation, regeneration avoiding control, droop control, torque limiting (2-strp), torque control, PID control, second motor switching, cooling fan ON/OFF control.	
Operation	Operation method	Keypad panel: Run by FWD REV keys, stop by STOP key. Terminal input: Forward/Stop command, Reverse/Stop command, Coast-to-Stop command, Alarm reset, acceleration/deceleration selection, multistep frequency	
	Frequency setting	Keypad panel: setting by UP and DOWN keys External potentiometer: External freq. Setting POT (VR) (1 to 5k ohm) Analog input: 0 to +10V (0 to 5V), 4 to 20 mA, 0 to ± 10V (FWD/REV operation) +10 to 0 (reverse operation), 20 to 4 mA (reverse operation) UP/DOWN control: Frequency increases or decreases as long as the digital input signals are turned on Multistep frequency selection: Up to 15 steps are selectable by a combination of digital input signals (four kinds) Link operation: Operation by RS485 (standard) Program operation: Pattern operation by program Jogging operation: Jogging operation by FWD, REV key or digital input signals.	
	Operation status signal	Transistor output (4 signals): Running, frequency, arrival, frequency detection, overload early warning, etc. Relay output (2 signals): Alarm output (for any fault), multi-purpose output signals Analog output (1 signal): Output frequency, output current, output voltage, output torque, power consumption, etc. Pulse output (1 signal): Output frequency, output current, output power, output torque, power consumption, etc.	

11.2 Common Specifications (continued)

		Item	Explanation
Indication		Digital display LED	Output frequency, setting frequency, output current, output voltage, motor synchronous speed, line speed, load rotation speed, calculated PID value, PID command value, PID feedback value, alarm code.
		Liquid crystal display	Operation information, operational guide, functional code/name/setting data, alarm information, tester function, motor load rate measuring function (Maximum/average current (rms) during measuring period, maintenance information (integrated operation hours, capacitance measurement for main circuit capacitors, heatsink temperature, etc.
		Language	Six languages (Japanese, English, German, French, Spanish, Italian)
		Lamp display	Charging (voltage residual), operation indication
		Protective function	Overcurrent, short-circuit, ground fault, overvoltage, undervoltage, overload, overheating, blown fuse, motor overload, external alarm, input open-phase, output open0phase (when tuning), braking resistor protection, CPU and memory error, keypad panel communications error, PTC thermistor protection, surge protection, stall prevention, etc.
Environment		Installation location	Indoor, altitude less than 3300 feet (1000m), free from corrosive gas, dust and direct sunlight.
		Ambient temperature	-10 to +50°C (+14 to 122°F) (ventilating cover must be removed under conditions exceeding +40°C (+104°F) for models rated at 30 HP or less)
		Vibration	3mm peak from 2-9 Hz, 9.8 m/s ² from 9-20 Hz, 2m/s ² from 20-55 Hz, 1 m/s ² from 55-200 Hz,
	Storage	Ambient temperature	-25 to 65°C (-13 to 149°F)
	Ambient humidity	5 to 95% (no condensation)	

11.3 Outline Dimensions-Variable Torque, Constant Torque

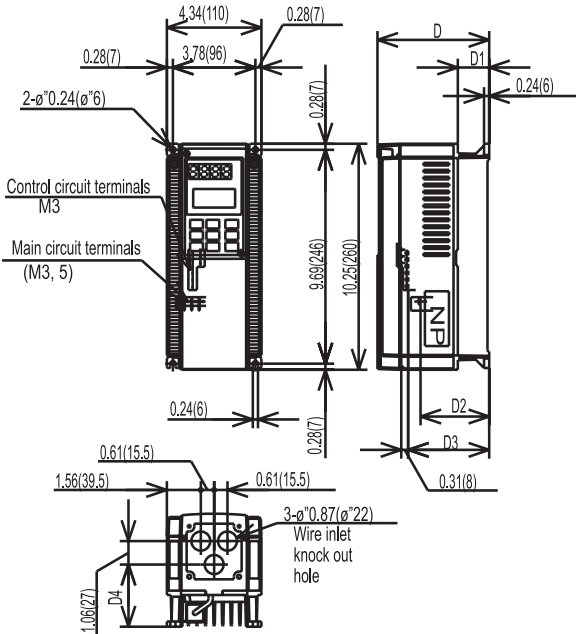

Type	D	D1	D2	D3	D4
1/4, 1/2 Hp	5.12 (130)	1.44 (26.5)	3.15 (80)	3.7 (94)	2.81 (71.5)
1 Hp	5.71 (145)	2.03 (51.5)	3.74 (95)	4.29 (109)	3.41 (86.5)

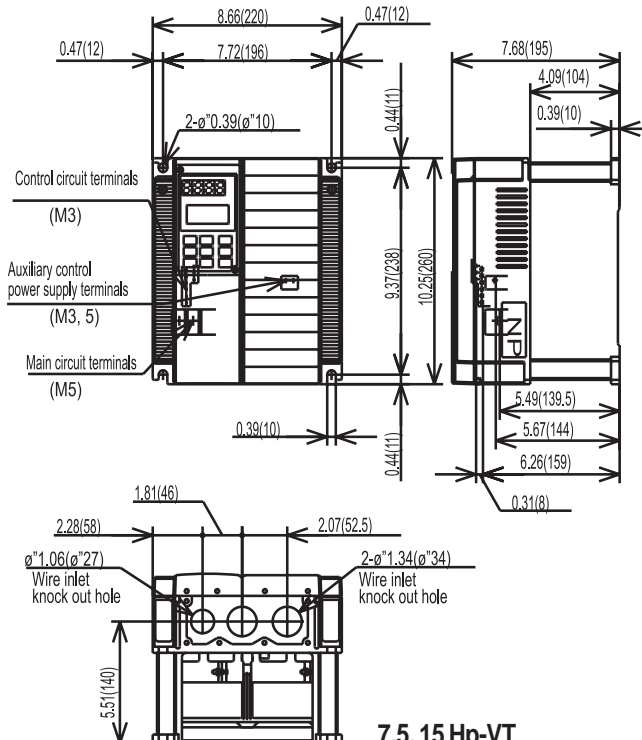
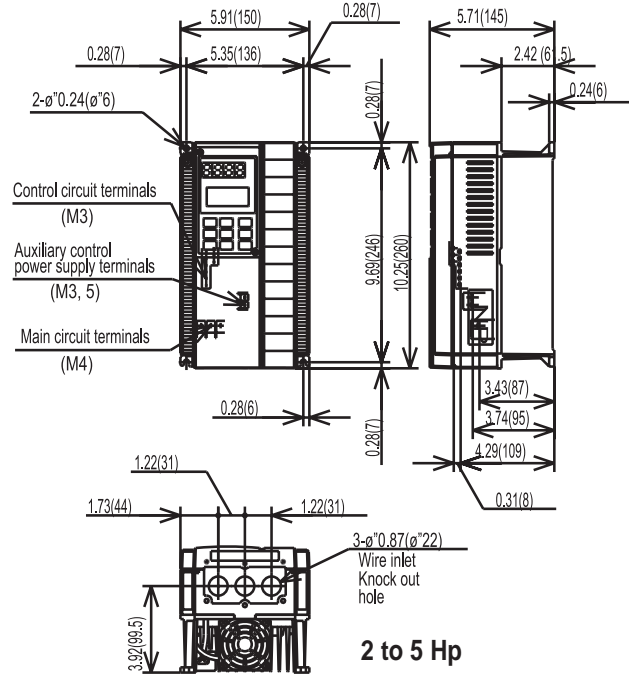

7.5, 15 Hp-VT
7.5, 10 Hp-CT

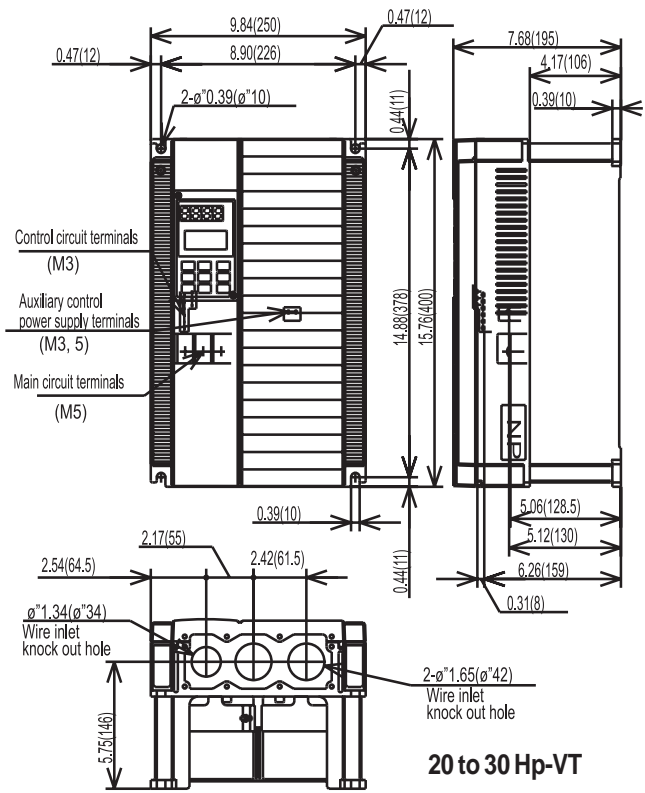

20 to 30 Hp-VT
15 to 30 Hp-CT

11.3.1 Outline Dimensions NEMA 1-Variable/Torque, Constant Torque

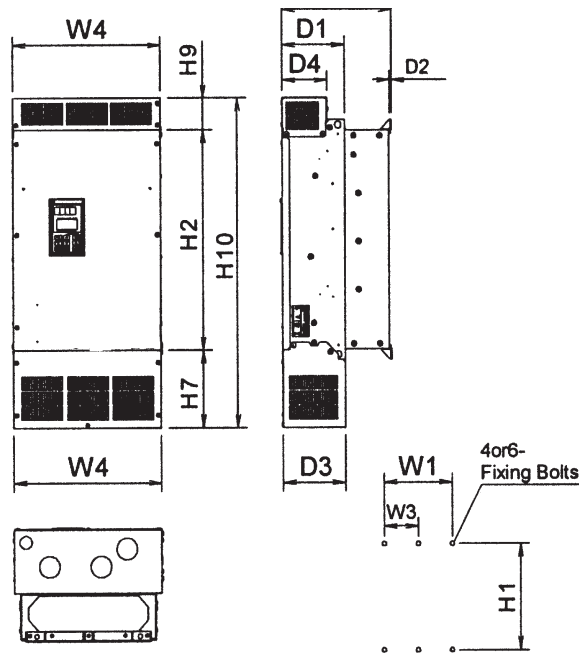

230V Series NEMA 1-Variable/Torque, Constant Torque

Hp	DIMENSIONS inches (mm)														Mtg. Bolts	Wt. Lb (kg)
	W1	W3	W4	H1	H2	H3	H6	H7	H9	H10	D	D2	D3	D4		
40/30	9.4	-	13.5	20.9	19.7	20.2	0.4	7.1	3	29.7	10	0.2	5.7	4.1	M8	70
50/40	(240)		(342)	(530)	(500)	(512)	(9)	(180)	(75)	(755)	(255)	(4)	(145)	(105)		86
60/50	10.8		14.9	23.4	22.2	22.7		7.9		33.1	10.6					106
75/65	(275)		(377)	(595)	(565)	(577)		(200)		(840)	(270)					(48)
100/75				28.3	27.2	27.6				38						110
125/100	16.9		21	27	27.4	27.6	0.5	11.1	3.3	41.3	11.2			3.6	M12	172
	(430)		(533)	(685)	(695)	(702)	(13)	(283)	(83)	(1050)	(285)			(91)		(78)
150/125	22.8	11.4	26.9	33.5	32.1	32.5		15.1		50.4	14.2		8.7	6.5		282
	(580)	(290)	(683)	(850)	(815)	(825)		(383)		(1280)	(360)		(220)	(166)		(128)

460V Series NEMA 1-Variable/Torque, Constant Torque

Hp	DIMENSIONS inches (mm)														Mtg. Bolts	Wt. Lb (kg)
	W1	W3	W4	H1	H2	H3	H6	H7	H9	H10	D	D2	D3	D4		
40/30	9.4	-	13.5	20.9	19.7	20.2	0.4	7.1	3	29.7	10	0.2	5.7	4.1	M8	70
50/40	(240)		(342)	(530)	(500)	(512)	(9)	(180)	(75)	(755)	(255)	(4)	(157)	(105)		82
60/50	10.8		14.9							10.6						(37)
75/65	(275)		(377)	25.8	24.6	25.1				34.6						95
100/75				(655)	(625)	(637)				(880)						(43)
125/100				28.3	27.2	27.6		7.9		38					97	
				(720)	(690)	(702)		(200)		(965)					(44)	
150/125	16.9		21	28	26.6	27	0.5	8.2	3.3		12.4		6.9	4.7	M12	174
200/150	(430)		(533)	(710)	(675)	(685)	(13)	(208)	(83)		(315)		(175)	(121)		(79)
250/200				38	37	37		13		53.1	14.2		8.7	7		245
300/250				(970)	(935)	(945)		(333)		(1350)	(360)		(220)	(166)		(111)
350/300	22.8	11.4	26.9					15.1		55.1						337
400/350	(580)	(290)	(683)					(383)		(1400)						(153)
450/350																

Surface Mount

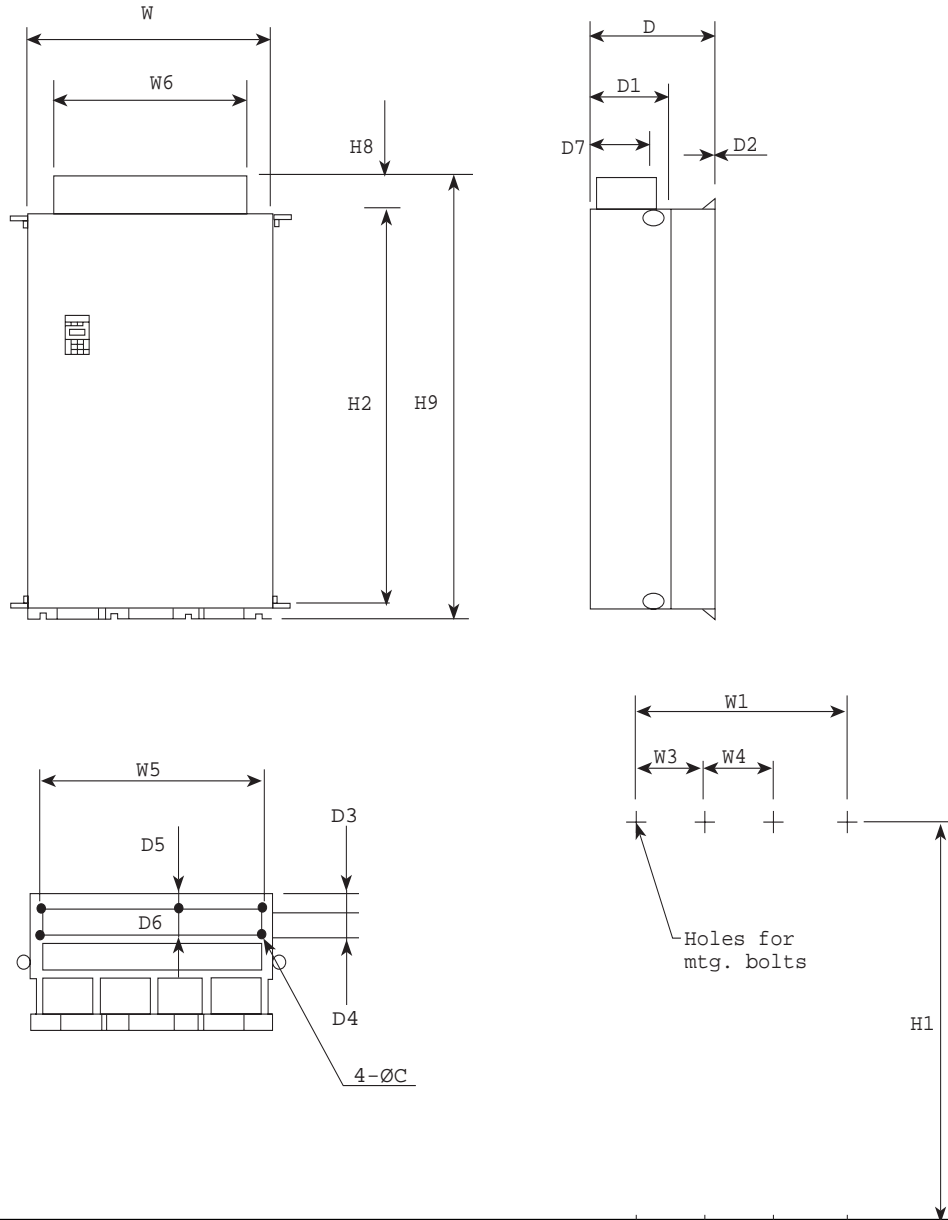

460V Series NEMA 1-Variable Torque, Constant Torque

Hp	DIMENSIONS inches (mm)												
	W	W1	W3	W4	W5	W6	H1	H2	H4	H8	H9	D	D1
500/400	26.8	22.8	11.4	-	24.0	21.9	53.9	52.4	52.6	3.3	57.1	17.7	11.2
600/450	(680)	(580)	(290)		(610)	(555)	(1370)	(1330)	(1335)	(084)	(1450)	(450)	(285)
700/500	34.6	30.7	10.2	10.2	31.9	29.7							
800/600	(880)	(780)	(260)	(260)	(810)	(755)							

Hp	DIMENSIONS inches (mm)							Mtg. Bolts	Wt. Lb (kg)
	D2	D3	D4	D5	D6	D7			
500/400	0.3	2.0	3.9	1.4	4.5	8.7	M12	562	
600/450	(6)	(50)	(100)	(35)	(115)	(220)		(255)	
700/500								804	
800/600								(365)	

11.3.2 Outline Dimensions Open Type-Variable Torque/ Constant Torque

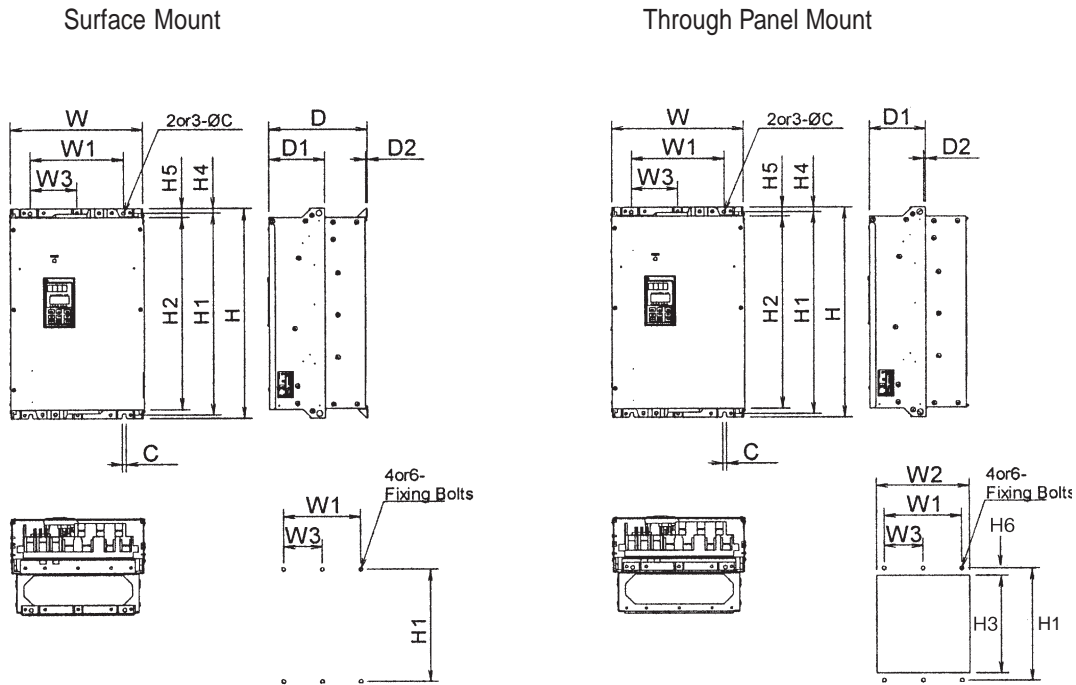

230V Series-Variable Torque, Constant Torque																	
Hp	DIMENSION Inch (mm)															Mtg. Bolts	Weight Lb (kg)
230V	W	W1	W2	W3	H	H1	H2	H3	H4	H5	H6	D	D1	D2	C		
40/30	13.4	9.4	12.8		21.7	20.9	19.7	20.2	0.5	1	0.4	10	5.7	0.2	0.4	M8	64
50/40	(340)	(240)	(326)		(550)	(530)	(500)	(512)	(12)	(25)	(9)	(255)	(145)	(4)	(10)		(29)
60/50	14.8	10.8	14.2		24.2	23.4	22.2	22.7				10.6					79
	(375)	(275)	(361)		(615)	(595)	(565)	(577)				(270)					(36)
75/65					29.1	28.3	27.2	27.6									97
					(740)	(720)	(690)	(702)									(44)
100/75																	101
																	(46)
125/100	20.9	16.9	20.1		29.5		27	27.4	0.6	1.3	0.5	11.2			0.6	M12	154
	(530)	(430)	(510)		(750)		(685)	(695)	(16)	(33)	(13)	(285)			(15)		(70)
150/125	26.8	22.8	26		34.6	33.5	32.1	32.5				14.2	8.7				253
	(680)	(580)	(660)		(880)	(850)	(815)	(825)				(360)	(220)				(115)
460V Series-Variable Torque, Constant Torque																	
Hp	DIMENSION Inch (mm)															Mtg. Bolts	Weight Lb (kg)
460V	W	W1	W2	W3	H	H1	H2	H3	H4	H5	H6	D	D1	D2	C		
40/30	13.4	9.4	12.8		21.7	20.9	19.7	20.2	0.5	1	0.4	10	5.7	0.2	0.4	M8	64
50/40	(340)	(240)	(326)		(550)	(530)	(500)	(512)	(12)	(25)	(9)	(255)	(145)	(4)	(10)		(29)
60/50	14.8	10.8	14.2									10.6					75
	(375)	(275)	(361)									(270)					(34)
75/65					26.6	25.8	24.6	25.1									86
					(675)	(655)	(625)	(637)									(39)
100/75																	88
																	(40)
125/100					29.1	28.3	27.2	27.6									106
					(740)	(720)	(690)	(702)									(48)
150/125	20.9	16.9	20.1			28	26.6	27	0.6	1.3	0.5	12.4	6.9		0.6	M12	154
200/150	(530)	(430)	(510)			(710)	(675)	(682)	(16)	(33)	(13)	(315)	(175)		(15)		(70)
250/200					39.4	38.2	36.8	37.2				14.2	8.7				220
300/250					(1000)	(970)	(935)	(945)				(360)	(220)				(100)
350/300	26.8	22.8	26	11.4													308
400/350	(680)	(580)	(660)	(290)													(140)
450/350																	

Alternative Through Panel Mount (bottom bracket support by customer supply.

Surface Mount

Through Panel Mount

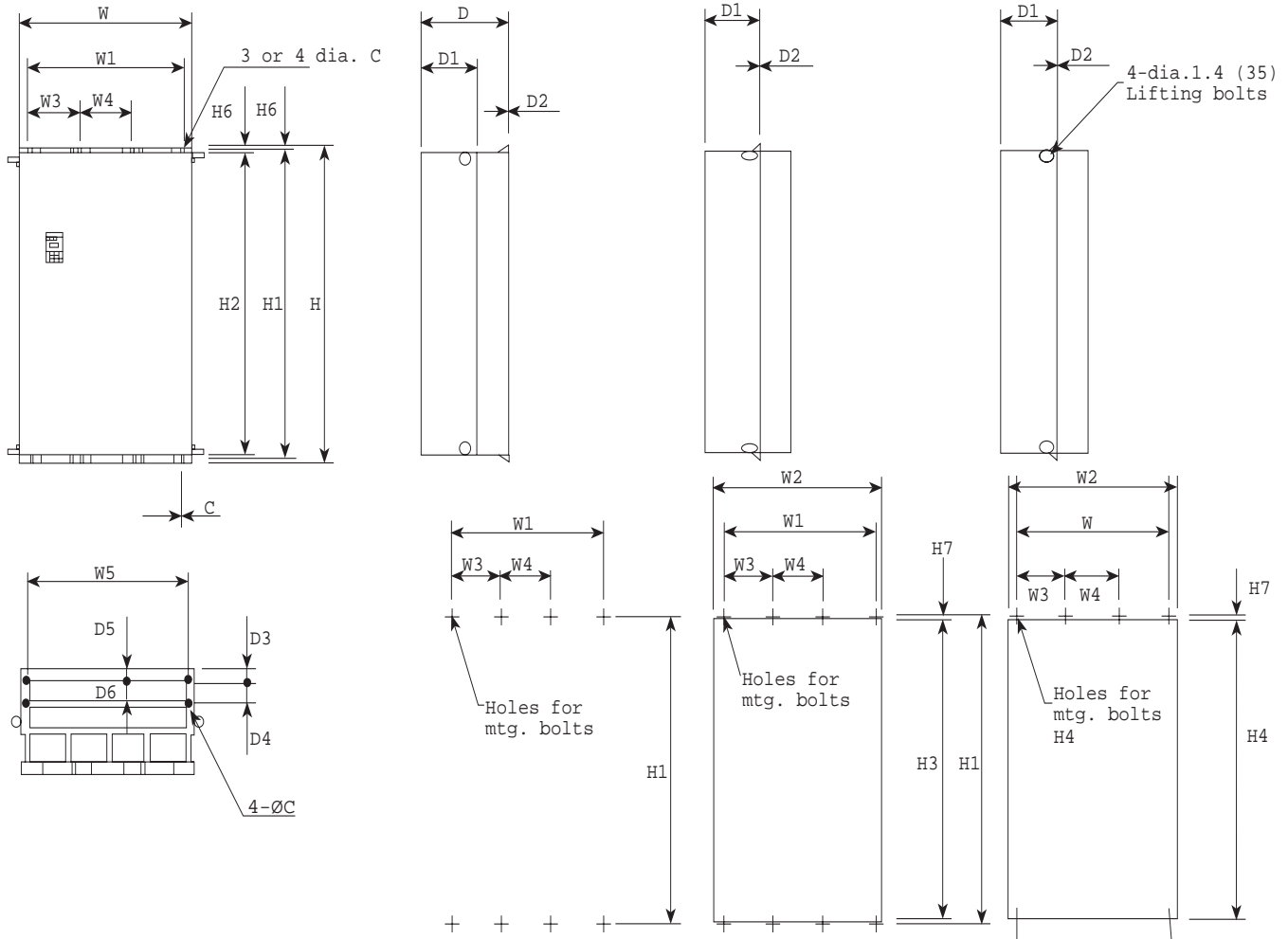

460V Series Open Type-Variable Torque, Constant Torque

Hp	DIMENSIONS inches (mm)															
	W	W1	W2	W3	W4	W5	H	H1	H2	H3	H4	H5	H6	H7	D	D1
500/400	26.8	22.8	26.0	11.4	-	24.0	55.1	53.9	52.4	52.8	52.6	0.6	1.4	0.6	17.7	11.2
600/450	(680)	(580)	(660)	(290)	-	(610)	(1400)	(1370)	(1330)	(1340)	(1335)	(016)	(035)	(015)	(450)	(285)
700/500	34.6	30.7	33.8	10.2	10.2	31.9										
800/600	(880)	(780)	(860)	(260)	(260)	(810)										

Hp	DIMENSIONS inches (mm)						Mtg. Bolts	Wt. Lb (kg)
	D2	D3	D4	D5	D6	C		
500/400	0.3	2	3.9	1.4	4.5	0.6	M12	551
600/450	(6)	(50)	(100)	(35)	(115)	(015)		(250)
700/500								793
800/600								(360)

11.3.3 Outline Dimensions Open Type with NEMA 12 Heatsink

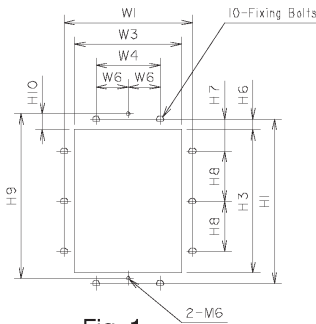
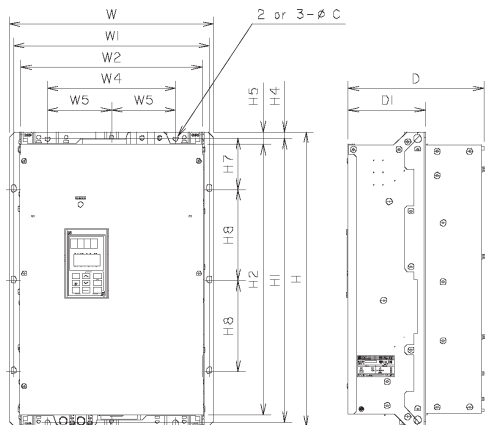

Fig. 1

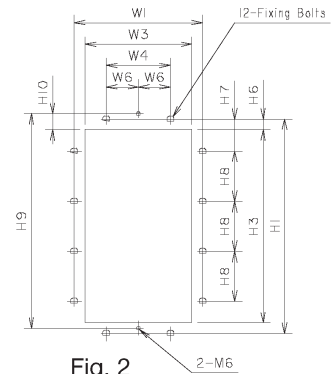

Fig. 2

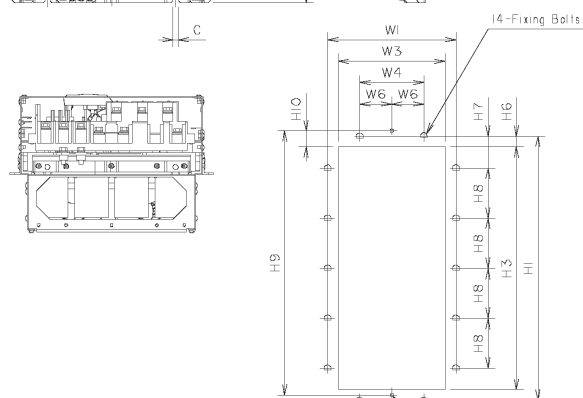

Fig. 3

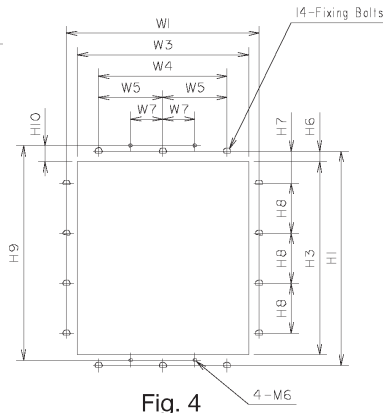

Fig. 4

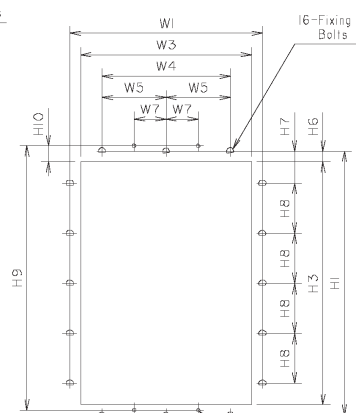

Fig. 5

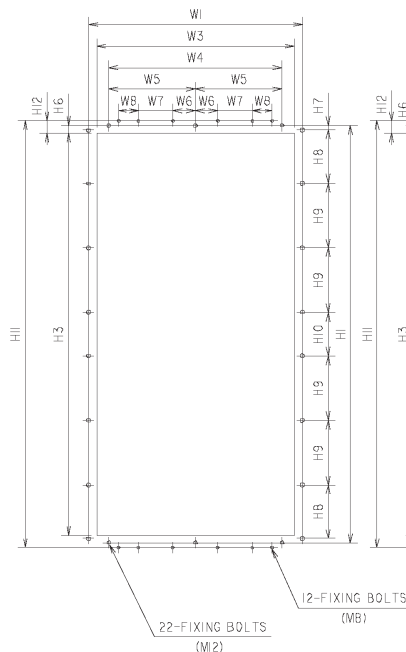
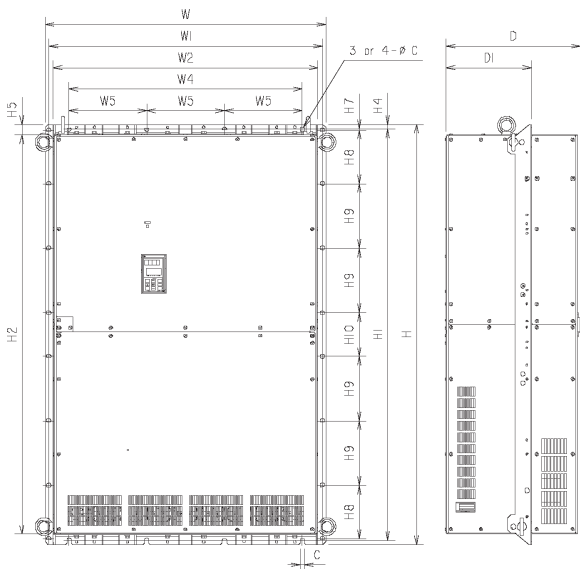

Fig. 6

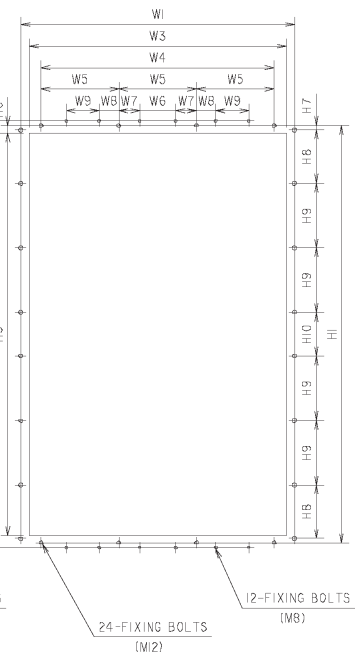
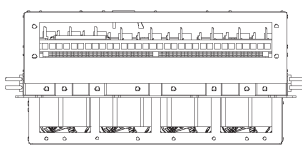
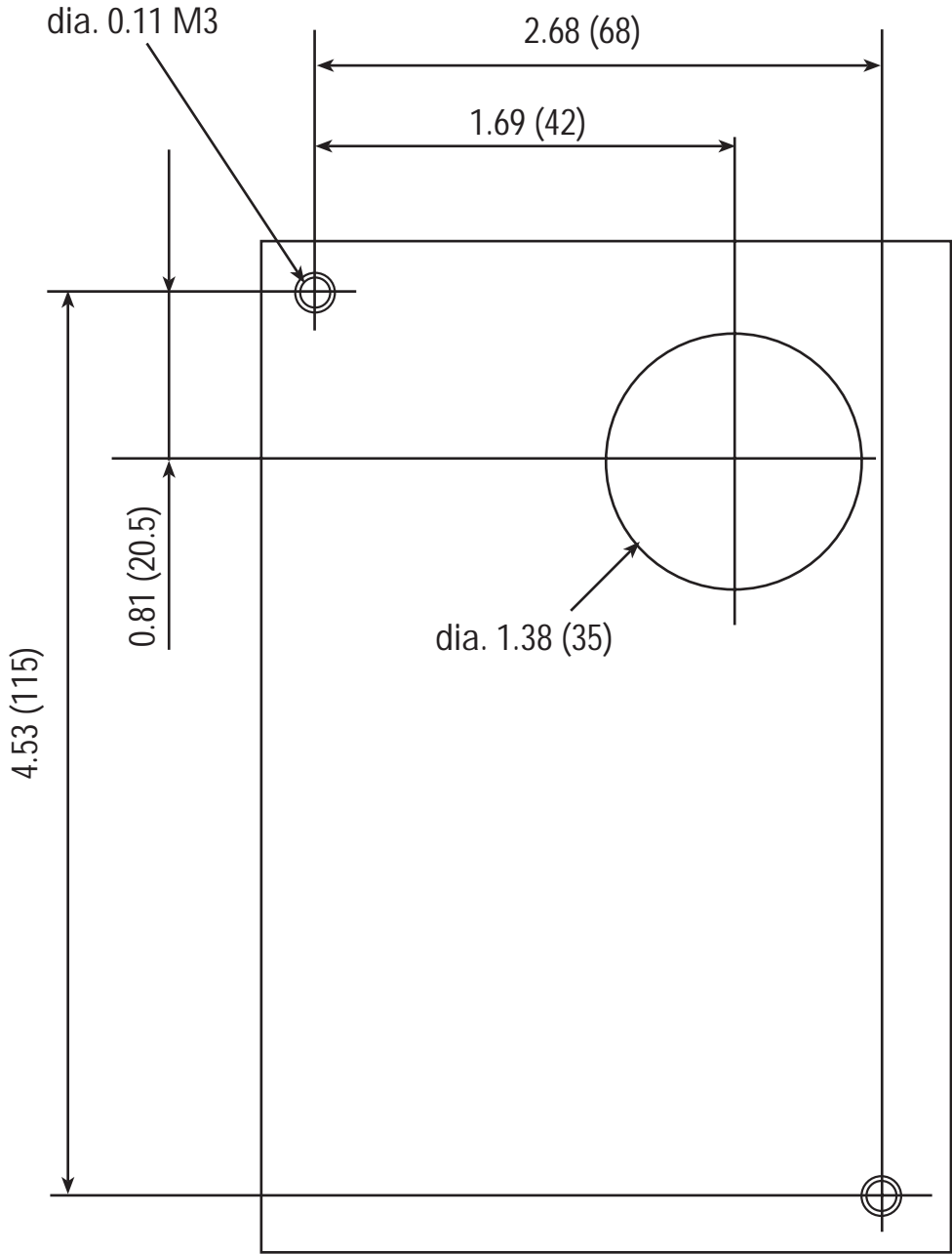

Fig. 7



Keypad Mounting Hole (Panel Cutting)

Dimensions in inches (mm)



12. RS485 Modbus RTU Serial Communications

The serial interface supports operation, configuration and monitoring of drive functions through an EIA/RS485 connection. The serial interface is based on Modbus RTU protocol. This protocol allows the drive to function as an RTU slave on an industrial network.

12.1 Transmission Specification

Item	Specification
Physical level	EIA/RS485
Transmission distance	500 m max.
Number of nodes	32 total
Transmission speed	19200, 9600, 4800, 2400 [bits/s]
Transmission mode	Half duplex
Transmission protocol	Modbus RTU
Character code	Binary
Character length	8 bits
Error check	CRC

12.2 Connection

Connection method

Use shielded wire and connect to the control terminals (DX-, DX+ and SD). A termination resistor should be added between the data lines on the each end of the network. The value of the termination resistor depends on the characteristic impedance of the cable. A common value for termination resistors is 120 ohms.

Control terminals

Terminal marking	Terminal name	Function description
DX+	RS485 communication data (+)	Input/output terminals for RS485 communication.
DX-	RS485 communication data (-)	
SD	Cable shield	Electrically floating

12.3 Serial Interface Configuration

Drive function codes H30 to H39 are used to configure the serial interface parameters, such as device address, baud rate and error response.

12.4 Modbus RTU Functions

The following RTU functions are supported. The maximum number of consecutive parameters for function 03 and 16 messages is 16.

Code	Description
03	Read Holding Registers (16 registers maximum)
06	Preset Single Register
16	Preset Multiple Registers (16 registers maximum)

12.5 Drive Function Code Access

All of the drive function codes are accessible through the RS485 serial interface. Drive function codes are mapped to RTU holding registers. A drive function code RTU address is 2 bytes in length. The high byte corresponds to a code that represents the drive parameter sort (F–M). The low byte corresponds to the drive parameter number within the sort (0 - 99).

Code	Sort	Name	Code	Sort	Name
0	F	Basic function	5	A	Motor 2 function
1	E	Terminal function	6	o	Option function
2	C	Control function	7	S	Command/function data
3	P	Motor 1 function	8	M	Monitor data
4	H	High level function			

For example, drive function code M11, output current, is addressed as RTU parameter number 080B hexadecimal or 2059 decimal.

high byte	low byte
drive parameter sort code	drive parameter number

12.6 Command and Monitor Data Registers

The command and monitor function codes are used to control the operation of the drive and monitor the status variables through the serial interface. The command and monitor function codes are not accessible from the drive keypad interface. Drive parameter H30 and digital input signal LE must be enabled to operate the drive from the Modbus interface. If LE is not assigned to a digital input (X1-X9), the signal will default to ON.

Frequency Setting Registers

Address	Code	Name	Unit	Variable Range	Min. unit	Read/Write	Data Format
1793	S01	Frequency command	-	-20000–20000 (max. frequency at ± 20000)	1	R/W	2
1797	S05	Frequency command	Hz	0.00–400.00	0.01	R/W	5

Note:

- 1) If both S01 and S05 are set, the drive will ignore the setting of S05.
- 2) A data setting that exceeds the setting range is possible, but the actual action will be limited by the drive configuration.

Operation command data Registers

Address	Code	Name	Unit	Variable Range	Min. unit	Read/Write	Data Format
1798	S06	Operation command	-	Refer to the data format [14]	-	R/W	14
1799	S07	Universal Do	-	Refer to the data format [15]	-	R/W	15
1804	S12	Universal Ao	-	-20000–20000 (100% output at ± 20000)	1	R/W	2

Note:

- 1) Since X1–X9 are configurable input commands, it is necessary to set the functions by E01–E09.
- 2) The alarm reset is executed, when RST signal changes from ON to OFF even if there are no alarms.
- 3) Universal Do is a function that utilizes the drive's digital outputs via communication.

Function data Registers

Address	Code	Name	Unit	Variable range	Min. unit	Read/Write	Data Format
1800	S08	Acceleration time F07	s	0.1–3600.0	0.1	R/W	3
1801	S09	Deceleration time F08	s	0.1–3600.0	0.1	R/W	3
1802	S10	Torque limit level 1 (driving) F40	%	-20.00 –200.00, 999	1	R/W	5
1803	S11	Torque limit level 2 (braking) F41	%	0.00, 20.00–200.00, 999	1	R/W	5

Note:

- 1) The writing of data out of range is treated as out of range error.
- 2) Use a value of 7FFF_h to enter 999 for torque limit functions.

Monitoring parameter registers

Address	Code	Description	Unit	Range	Min. unit	Read / Write	Data Format
2049	M01	Frequency command (final command)	-	- 20000–20000 (max. frequency at ± 20000)	1	R	2
2053	M05	Frequency command (final command)	Hz	0–400.00	0.01	R	5
2054	M06	Actual frequency	-	- 20000–20000 (max. frequency at ± 20000)	1	R	2
2055	M07	Actual torque value	%	- 200.00–200.00	0.01	R	6
2056	M08	Torque current	%	- 200.00–200.00	0.01	R	6
2057	M09	Output frequency	Hz	0.00–400.00	0.01	R	5
2058	M10	Motor output (input electric power)	%	0.00–200.00	0.01	R	5
2059	M11	Output current r. m. s.	%	0.00–200.00 (inverter rating at 100.00)	0.01	R	5
2060	M12	Output voltage r. m. s.	V	0.0–600.0	1	R	3
2061	M13	Operation command (final command)	-	Refer to data format [14]	-	R	14
2062	M14	Operating state	-	Refer to data format [16]	-	R	16
2063	M15	Universal output terminal data	-	Refer to data format [15]	-	R	15
2064	M16	Fault memory 0	-	Refer to data format [10]	-	R	10
2065	M17	Fault memory 1	-				10
2066	M18	Fault memory 2	-				10
2067	M19	Fault memory 3	-				10
2068	M20	Integrated operating time	h	0–65535	1	R	1
2069	M21	DC link voltage	V	0–1000	1	R	1
2071	M23	Type code	-	Refer to data format [17]	-	R	17
2072	M24	Drive capacity code	-	Refer to data format [11]	-	R	11
2073	M25	ROM version	-	0–64999	1	R	1
2074	M26	Transmission error processing code	-	Refer to data format [20]	-	R	20
2075	M27	Frequency command at alarm (final command)	-	- 20000–20000 (max. frequency at ± 20000)	1	R	2
2079	M31	Frequency command at alarm (final command)	Hz	0–400.00	0.01	R	5
2080	M32	Actual frequency at alarm	-	- 20000–20000 (max. frequency at ± 20000)	1	R	2
2081	M33	Actual torque at alarm	%	- 200.00 – 200.00	0.01	R	6
2082	M34	Torque current at alarm	%	- 200.00 – 200.00	0.01	R	6
2083	M35	Output frequency at alarm	Hz	0.00 – 400.	0.01	R	5
2084	M36	Motor output at alarm (input power)	%	0.00–200.00	0.01	R	5
2085	M37	Output current r.m.s. at alarm	%	0.00 – 200.00 (inverter rating at 100.00)	0.01	R	5
2086	M38	Output voltage effective value at alarm	V	0.0 – 600.0	1	R	3
2087	M39	Operation command at alarm	-	Refer to data format [14]	-	R	14
2088	M40	Operating state at alarm	-	Refer to data format [16]	-	R	16
2089	M41	Universal output terminal data at alarm	-	Refer to data format [15]	-	R	15
2090	M42	Integrated operation time at alarm	h	0–65535	1	R	1
2091	M43	DC link voltage at alarm	V	0–1000	1	R	1
2092	M44	Inverter internal air temp. at alarm	°C	0–120	1	R	1
2093	M45	Cooling fin temp. at alarm	°C	0–120	1	R	1
2094	M46	Life of main circuit capacitor.	%	0.0–100.0	0.1	R	3
2095	M47	Life of printed circuit board capacitor.	h	0–65535	1	R	1
2096	M48	Life of cooling fan.	h	0–65535	1	R	1

12.7 Data Format Specification

All data in the data field of communication frame shall be represented by a 16 bit length word.

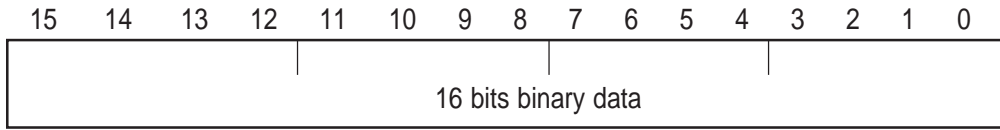

Data format [1] Unsigned Integer data (Positive): Min. unit 1

Example If F15 (Frequency limit, upper)= 60Hz

60 = 003C_H

Data format [2] Integer data (Positive, negative): Min. unit 1

Example data = -20

-20 = FFEC_H

Data format [3] Unsigned Decimal data (Positive): Min. unit 0.1

Example: If F17 (frequency gain setting signal) = 100.0%

100.0 X 10 = 1000 = 03E8_H

Data format [4] Decimal data (Positive, negative): Min. unit 0.1

Example If: C31 (Analog input offset adjust, terminal12) = - 5.0%

- 5.0 X 10= - 50 = FFCE_H

Data format [5] Unsigned Decimal data (Positive): Min. unit 0.01

Example: If C05 (multi-step frequency 1) = 50.25Hz

50.25 X 100 = 5025 = 13A1_H

Data format [6] Decimal data (Positive, negative): Min. unit 0.01

Example: If M07 (actual torque value)= - 85.38%

- 85.38 X 100= - 8538=DEA6_H

Data format [7] Unsigned Decimal data (Positive): Min. unit 0.001

Example: If o05 (follow - up side ASR 1 constant) = 0.105s

0.105 X 1000 = 105 = 0069_H

Data format [8] Decimal data (Positive, negative): Min. unit 0.001

Example: Data = -1.234

- 1.234 X 1000 = - 1234 = FB2E_H

Data format [9] Unsigned Integer data (Positive): Min. unit 2

Example If P01 (Motor 1 number of poles) =2pole

2 = 0002_H

Data format [10] Alarm Code

Code	Description	Code	Description
0	No alarm	---	22 Overheat, DB resistor dbH
1	Overcurrent, during acceleration (INV output)	OC1	23 Overload, motor 1 OL1
2	Overcurrent, during deceleration (INV output)	OC2	24 Overload, motor 2 OL2
3	Overcurrent, during steady state operation (INV output)	OC3	25 Overload, drive OLU
5	Ground fault	EF	27 Overspeed OS
6	Overvoltage, during acceleration	OU1	28 PG wire break Pg
7	Over voltage, during deceleration	OU2	31 Memory error Er1
8	Overvoltage, during steady state operation	OU3	32 Keypad error Er2
10	DC undervoltage	LU	33 CPU error Er3
11	Power supply open phase	Lin	34 Option comm error Er4
14	Blown DC fuse	FUS	35 Option error Er5
16	Output wiring error	Er7	36 PL error Er6
17	Overheat, heat sink, inverter	OH1	37 Output wiring error Er7
18	Overheat, outside thermal	OH2	38 RS485 comm error Er8
19	Overheat, unit inside temp	OH3	

Data format [11] Capacity code

Code	Capacity (HP)	Code	Capacity (HP)	Code	Capacity (HP)
7	0.07 (spare)	2000	20	17500	175
15	0.15 (spare)	2500	25	20000	200
25	0.25	3000	30	25000	250
50	0.5	4000	40	30000	300
100	1	5000	50	35000	350
200	2	6000	60	40000	400
300	3	7500	75	45000	450
500	5	10000	100	50000	500
750	7.5	12500	125	60600	600
1000	10	15000	150	60700	700
1500	15			60800	800

Data format [12] Index data (ACC/DEC time, display coefficient)

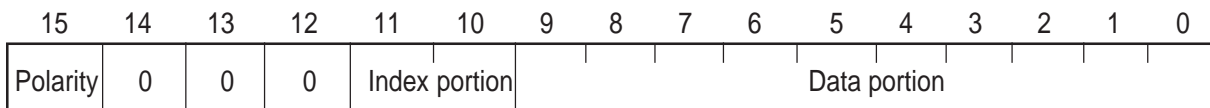

1: Negative (-)	0: 0.01 X	001-999	(0.00-9.99)
0: Positive (+),	1: 0.1 X	00-999	(10.0-99.9)
	2: 1 X	100-999	(100-999)
	3: 10 X	100-999	(1000-9990)

Example: If F07 (acceleration time 1) = 20.0 s
 10.0 < 20 < 99.9 index = 1
 20.0 = 0.1 X 200 0400_H + 00C8_H = 04C8_H

Data format [13] Pattern operation

15	14	13	12	11	10	9	8	7	6	5	4	3	2	1	0
Direction of rotation	0	Time		Index portion	Data portion										

	0: 1 st ACC/DEC time	0: 0.01	X		001-999	(0.00-9.99)
0: FWD	1: 2 nd ACC/DEC time	1: 0.1	X		100-999	(10.0-99.9)
1: REV	2: 3 rd ACC/DEC time	2: 1	X		100-999	(100-999)
	3: 4 th ACC/DEC time	3: 10	X		100-999	(1000-9990)

Example) If C22 (Stage1) = 10.0s R2 (10s, reverse rotation, acceleration time 2/deceleration time 2)
 Since $10.0 = 0.1 \times 100 > 9000_H + 0400_H + 0064_H = 9464_H$

Data format [14] Operation command

15	14	13	12	11	10	9	8	7	6	5	4	3	2	1	0
RST	0	0	0	0	X9	X8	X7	X6	X5	X4	X3	X2	X1	REV	FWD

(All bit are ON by 1)
 Example) If S06 (operation command) = FWD, X1 and X5 = ON
 $0000\ 0000\ 0100\ 0101_b = 0045_H$

Data format [15] Universal output terminal

15	14	13	12	11	10	9	8	7	6	5	4	3	2	1	0
0	0	0	0	0	0	0	0	0	0	0	Y5	Y4	Y3	Y2	Y1

(All bit are ON by 1)
 Example) If M15 (Universal output terminal)=Y1 and Y5 = ON
 $0000\ 0000\ 0001\ 0001_b = 0011_H$

Data format [16] Operating state

15	14	13	12	11	10	9	8	7	6	5	4	3	2	1	0
BUSY	WR	RL	ALM	DEC	ACC	IL	VL	TL	NUV	BRK	INT	EXT	REV	FWD	

(All bit are ON or active by 1)

FWD:	Forward operation	IL:	Current limiting
REV:0:	Reverse operation	ACC:	Under acceleration
EXT:	DC braking active (or pre-excitation)	DEC:	Under deceleration
		ALM:	Drive fault
INT:	No Output	RL:	Transmission valid
BRK:	Braking active	WR:	Function writing privilege
NUV:	DC link voltage is established (undervoltage at 0)	0:	Keypad panel
		1:	RS485
TL:	Torque limiting	2:	Fieldbus (option)
VL:	Voltage limiting	BUSY:	Processing data write

Data format [17] Type code

15	14	13	12	11	10	9	8	7	6	5	4	3	2	1	0
Type				Generation				Series				Voltage series			

Code	Type	Generation	Series	Voltage series
1	-	VG10	-	-
2	VG10	-	-	-
3	GP10	-	-	230V three phase
4	-	-	-	460V three phase
5	-	-	USA	575V three phase
6	-	-	-	-

Data format [18] Code setting (1–4 figures)

15	14	13	12	11	10	9	8	7	6	5	4	3	2	1	0
Data 4				Data 3				Data 2				Data 1			

Data format [19] Amperage value Decimal data (positive):
Min. unit 0.01 inverter capacity is not more than 30HP
Min unit 0.01 for not less than 40HP

Example) If F11 (electronics thermal overload relay 1 level)107.0A (40HP)
 $107.0 \times 10 = 1070 = 042E_H$
 If F11 (electronics thermal overload relay 1 level)=3.60A (1HP)
 Since $3.60 \times 100 = 360 = 0168_H$

Data format [20] Transmission error code

Code	Description	Code	Description
1	FC (function code) error	71	CRC error (no response)
2	Illegal address	72	Parity error (no response)
3	Illegal address (Data range error)	73	Other errors (no response) -Framing error -Overrun error -Buffer full error
7	NAK -Priority for comm -No privilege for writing error -Forbidden writing error		

Data format [21]**Auto tuning**

15	14	13	12	11	10	9	8	7	6	5	4	3	2	1	0
0	0	0	0	0	0	REV	FWD								

0: Without forward rotation command
 1: With forward rotation command.
 0: Without reverse rotation command.
 1: With reverse rotation command.

Example) If P04 (motor 1 auto - tuning)=1: Forward rotation
 0000 0001 0000 0001_b=0101_H

12-7 Communication Errors**Exception Response**

When the drive receives a message that does not contain communication errors but the message can not be processed, the drive will return an exception response. The exception response contains an error sub-code in the data field that represents the problem.

Exception Response Errors

Sub-Code	Name	Causes
1	Illegal Function	Received RTU Function other than 03, 06 or 16
2	Illegal Data Address	<ul style="list-style-type: none"> The starting parameter address is an unused drive parameter.. The starting parameter address plus the offset refers to drive parameter greater than the last parameter in a Function Code sort. The number of registers is greater than 16.
3	Illegal Data Value	Data contains an out of range value for a drive parameter
7	Negative Acknowledge	<ul style="list-style-type: none"> Requested data cannot be changed while the drive is running. The drive parameter function is owned by the network interface option card and cannot be changed.

Communication errors

Communication errors occur when the drive receives an invalid message. The drive will not return a response to a communication error. A code that represents the last communication error is stored in drive parameter M26. Typical communication message errors include parity, framing, and CRC errors.

13. Options

13.1 Built-in Options

The drive supports two internally mounted cards. One option card is mounted under the main cover (Location A) and the other option card is mounted in a special adapter under the keypad (Location B). Only one card can be mounted in these locations. There are two different types of option cards, Type 1 and Type 2. You cannot use two Type 1 or Two Type 2 cards but you can mix any combination of Type 1 and Type 2 provided you only have one option per mounting location. Each option card must be mounted in the designated location. The chart below lists the option card, their types, and their mounting locations.

Name	Type	Loc	2nd Option Type/Loc	Function
SOPCG11SRV (Relay output card)	1	A	2/B	<ul style="list-style-type: none"> Relay output card <p>The transistor output from the drive control output terminals Y1 and Y4 are converted to the relay output (1SPDT).</p>
SOPCG11SDIO (Digital interface card)	2	A	None	<ul style="list-style-type: none"> Frequency setting by binary code (max. 16 bits) Monitoring (8 bits) of frequency, output current, and output voltage
SOPCG11SA0 (Analog interface card)	2	A	None	<ul style="list-style-type: none"> Auxiliary input for analog frequency setting (0 to +/-10 V) Monitoring of drive output frequency, current, and torque in analog voltage, analog output 0-10 VDC and 4-20mA
SOPCG11S00 (Interface card)	1	A	2/B	<ul style="list-style-type: none"> 115 VAC Control input, an isolation amplifier, relay output, PG encoder, analog output 4-20mA
SOPCG11SLON (Communication card)	2	B	1/A	<ul style="list-style-type: none"> Serial communication card for LonWorks
SOPCG11SPDP (Communication card)	2	B	1/A	<ul style="list-style-type: none"> Serial communication card for Profibus-DP
SOPCG11SDEV (Communication card)	2	B	1/A	<ul style="list-style-type: none"> Serial communication card for Device Net
SOPCG11SCOP (Communication card)	2	B	1/A	<ul style="list-style-type: none"> Serial communication card for CAN
SOPCG11SMBP (Communication card)	2	B	1/A	<ul style="list-style-type: none"> Serial communication card for Modbus plus
SOPCG11SIBS (Communication card)	2	B	1/A	<ul style="list-style-type: none"> Serial communication card for Interbus-S
SHE300GEN150 (Communication card)	2	B	1/A	<ul style="list-style-type: none"> Serial communication card for Genius

Name	Digital I/O interface card	
Type	SOPCG11SDIO	
Function	4 digital inputs: Binary code input of max. 16 bits or BCD input (Sink/Source changeable) 3 digital outputs: Binary code output of max. 8 bits.	
Specifications	Input	Digital signal input (4 points) by short-circuiting terminals L1, L16 and M1 <Sink> ON operation current: 4.5mA max. OFF operation voltage: 27V max. <Source> ON operation current: 4.5mA max. OFF operation voltage: 27V max. Related function code: o19, o20
	Output	Digital signal output (3 points) by short-circuiting terminals between O1 to O6, and M2 <Sink> ON operation current: 50mA max. OFF operation voltage: 27V max. <Source> ON operation current: -50mA max. OFF operation voltage: 27V max. Related function code: o21
	Power Source	+24 VDC (3.2mA x 4 + 12.8mA)

Connection diagram

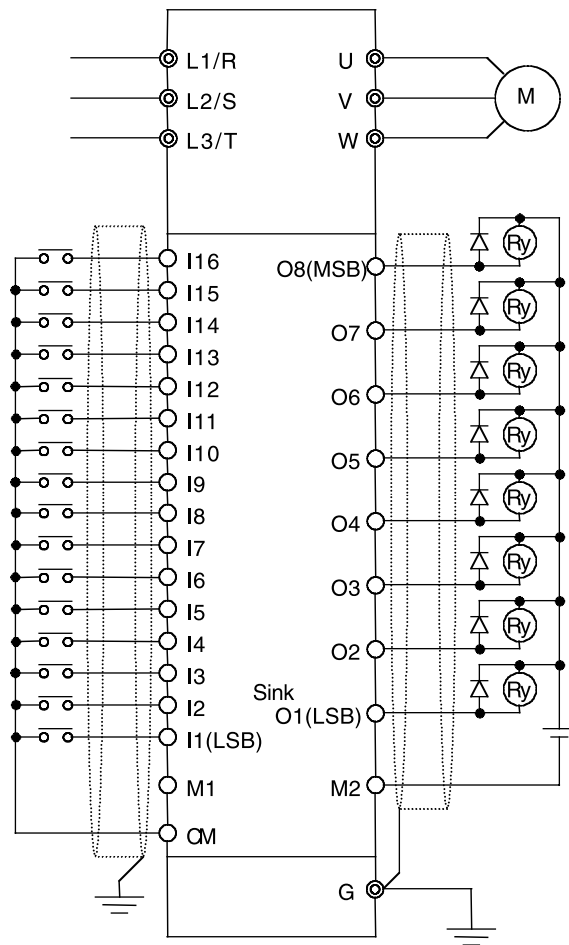

Remarks

Name	Analog I/O Interface Card	
Type	SOPCG11SAIO	
Function	3 analog inputs (2 voltage inputs and 1 current input): Torque limiting value (driving, braking), frequency setting, ratio setti can be input respectively. 2 analog outputs (1 voltage output and 1 current output): 11 types of data can be output.	
Specifications	Input	Analog signal input (3 points) 32 and 31, 22 and 21, C2 and 21. Terminal 32: Voltage input (both sides): 0 to ±10 VDC / 0 to ±100%, input impedance: 22k ohm. Terminal 22: Voltage input (both sides): 0 to +10 VDC / 0 to +100%, input impedance: 22k ohm. Terminal C2: Current input: 4 to + 20mADC / 0 to +100%, input impedance: 250k ohm. For voltage input, power supply terminal for variable resistor (P10) should be connected. Related function code o22
	Output	Analog signal input (2 points) between AO+ and AO-, CS+ and CS- Terminal AO+: Voltage output: 0 to ±10 VDC, for max. 2 voltmeters, input impedance: 10k ohm Terminal AO-: Voltage output common. Terminal CS+: Current output: 4 to 20mAdc, max. 500 ohm Terminal CS-: Current output common (Terminal CS- is isolated from terminal 21, 31 and AO-) Related function code o23

Connection diagram

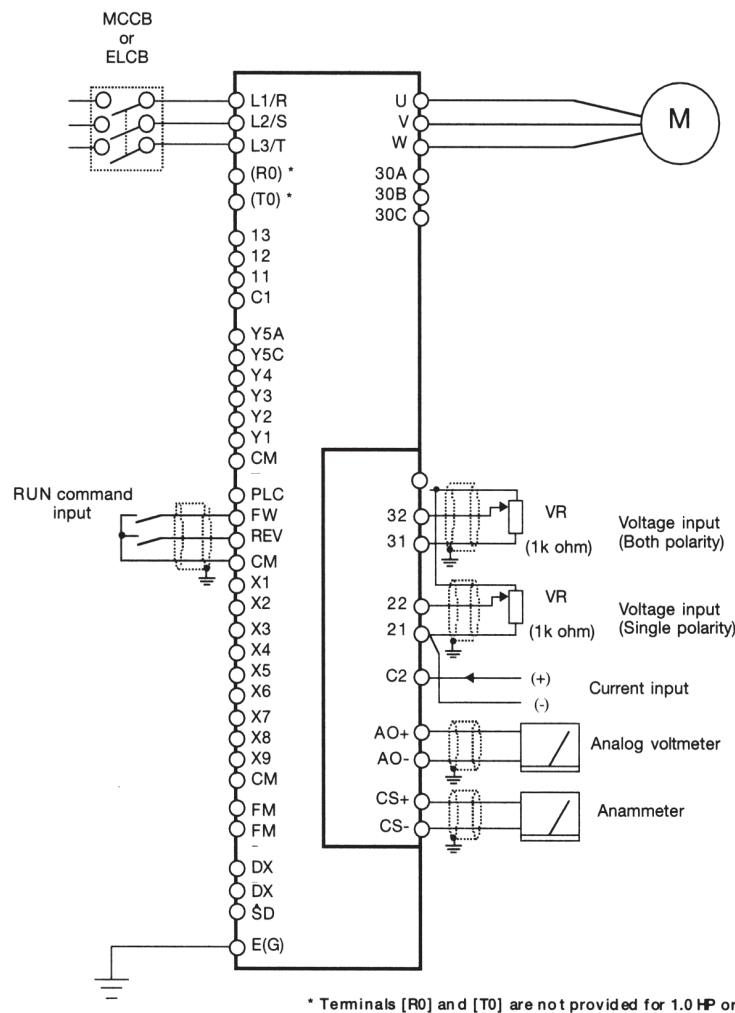

Remarks

Name		Relay Output Card
Type	Card type Unit type	SOPCG11SRY
Function	¥ Includes 4 relay output circuits ¥ Converts transistor output signals from drive control output terminals Y1 to Y4 to relay (1SPDT) output signals.	
Specifications	Input	None
	Output	Four-channel contact (12 terminals from Y1A to Y4C) 250 VAC, 0.3A, ocs dia. = 0.3
	Power source	The power source to drive the relay card is supplied from the drive.

Connection diagram

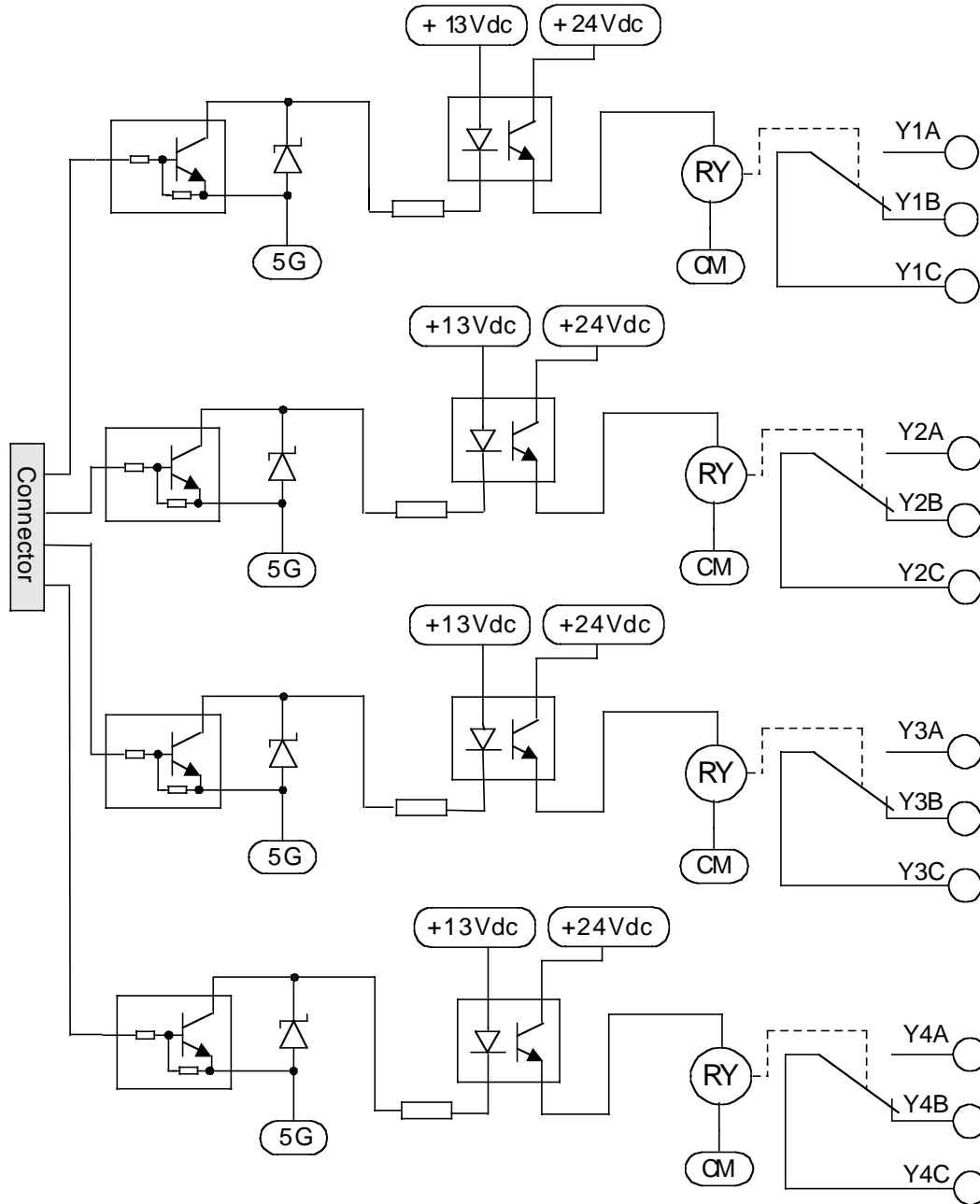

Remarks

14. Electromagnetic Compatibility (EMC)

14.1 General

In accordance with the provisions described in the European Commission Guidelines Document on Council Directive 89/336/EEC, these drives are classified as “Complex Components”.

Classification as a “Complex Components” allows a product to be treated as an “apparatus”, and thus permits compliance with the essential requirements of the EMC Directive to be demonstrated to both an integrator of GP10 drives and to his customer or the installer and the user.

GP10 drive is supplied ‘CE-marked’, signifying compliance with EC Directive 89/336/EEC when fitted with specified filter units installed and earthed in accordance with this sheet.

This Specification requires the following performance criteria to be met.

EMC product standard EN61800-13/1997

Immunity: Second environment (Industrial environment)
Emission: First environment (Domestic environment)

Finally, it is the customer's responsibility to check whether the equipment conforms to EMC directive.

14.2 Recommended Installation Instructions

It is necessary that to conform to the EMC Directive, these instructions must be followed.

Follow the usual safety procedures when working with electrical equipment. All electrical connections to the filter, Drive and motor must be made by a qualified electrical technician.

- 1) Use the correct filter according to Table on page 6-39.
- 2) Install the Drive and filter in the electrically shielded metal wiring cabinet.
- 3) The back panel of the wiring cabinet should be prepared for the mounting dimensions of the filter. Care should be taken to remove any paint etc. from the mounting holes and face area of the panel. This will ensure the best possible grounding of the filter.
- 4) Use the shield cable for the control , motor and other main wiring which are connected to the Drive. These shields should be securely grounded.
- 5) It is important that all wire lengths are kept as short as possible and that incoming mains and outgoing motor cables are kept well separated.

“ To minimize the conducted radio disturbance in the power distribution systems, the length of the motor-cable should be as short as possible. “

- 6) In the case where a ferrite ring is provided with the filter, fit the ferrite ring so the conductors pass through the center of the ferrite. Wire the cable according to Fig.6 or Fig.7 , paying attention to the applied Drive type.

Applied Drive GP10

[Hp] Max. rated voltage 3 Phase 230 VAC

G11	Filter Type (Fuji model #)	Rated Current	Tested Motor Cable Length		RFI Filter Data					Note
			EN55011 Class B	EN55011 Class A	Dimensions L x W x H (mm)	Mount. Dim. Y x X (mm)	Ferrite Ring (Qty)	Total Wt. (lb)	Watt loss [W]	
0.25 0.5 1	EFL075SP2 (EFL-0.75SP-2)	6A	—	164 ft (50m)	9.57 x3.35x3.66 (243x85x93)	8.98x2.32 (228x59)	OF1 [1]	3.3	0.4 1.4 5.1	Fig. 1 Separate Type
2 3 5	EFL370SP2 (EFL-3.7SP-2)	25A			9.17x4.13x5.35 (233x105x136)	8.46x 3.15 (215x80)	OF2 [1]	5.5	3.9 8.2 21	
7.5 10	EFL750SP2 (EFL-7.5SP-2)	50A			10.75x4.72x6.22 (273x120x158)	10x3.74 (254x95)	OF2 [1]	11.0	24 40	
15 20	EFL150SP2 (EFL-15SP-2)	100A			20.2x8.07x7.6 (513x205x193)	19.17x6.30 (487x160)	OF3 [1]	44.1	42	
25 30	EFL220SP2 (EFL-22SP-2)	150A							68 74 99	
40	RF3180F11 (RF3180-F11)	180A	—	328 Ft (100m)	19.49x7.87x6.3 (495x200x160)	18.4x6.53 (468x166)	—	48.7	60	Fig. 3 Separate Type
50 60	RF3280F11 (RF3280-F11)	280A			—	48.7	120	Fig. 4 Separate Type		
75 100 125 150	RF3400F11 (RF3400-F11)	400A			—	110	220			

[HP] Max. rated voltage 3 Phase 480 VAC

0.5 1	EFL075G114 (EFL-0.75G11-4)	5A	33 ft (10m)	164 ft (50m)	12.6x4.56x1.65 (320x116x42)	11.54x3.54 (293x90)	—	2.0	0.8 3.1	Fig. 2 Separate/ Integral Type
2 3 5	EFL400G114 (EFL-4.0G11-4)	12A			12.6x6.1x1.77 (320x155x45)	11.54x4.13 (293x105)	—	2.6	3.1 6.9 18	
7.5 10	EFL750G114 (EFL-7.5G11-4)	35A			13.43x8.86x1.87 (341x225x47.5)	12.24x6.57 (311x167)	—	4.0	10 17 24	
15 20	EFL150G114 (EFL-15G11-4)	50A			19.69x9.84x2.76 (500x250x70)	17.68x7.28 (449x185)	—	7.9	29 49	
25 30	EFL220G114 (EFL-22G11-4)	72A						8.8	47 62	
40	RF3100F11 (RF3100-F11)	100A	—	328 ft (100m)	17.13x7.87x5.19 (435x200x130)	16.06x6.54 (408x166)	—	28.6	21	Fig. 3 Separate Type
50 60 75 100 125	RF3180F11 (RF3180-F11)	180A			19.49x7.87x6.3 (495x200x160)	18.4x6.53 (468x166)	—	48.7	60	
150 200	RF3280F11 (RF3280-F11)	280A			23.11x9.84x8.07 (587x250x205)	22.05x3.35 (560x85)	—	84.8	120	Fig. 4 Separate Type
250 300 350	RF3400F11 (RF3400-F11)	400A						110	220	
400 450	RF3880F11 (RF3880-F11)	800A						27.09x14.33x7.09 (688x364x180)	25.51x5.91 (648x150)	—
500 600 700 800					F200 160 [3]	142	180			

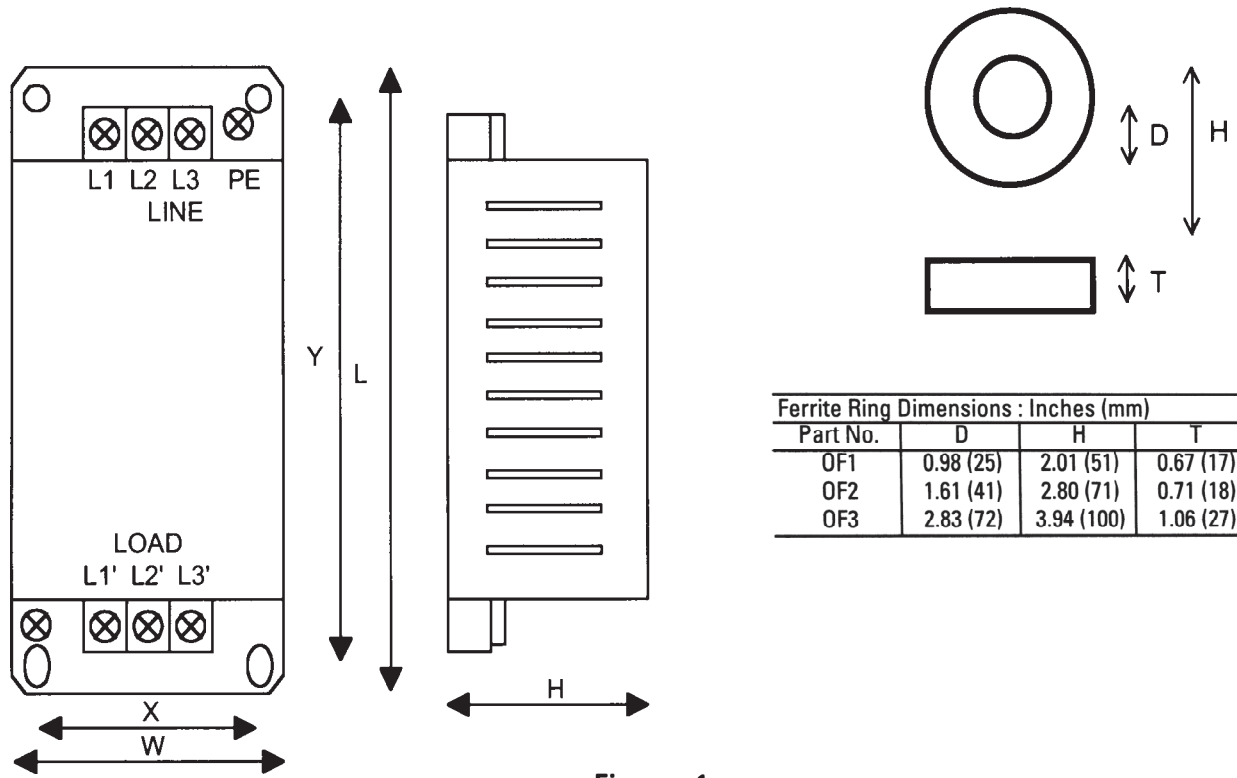

Figure 1

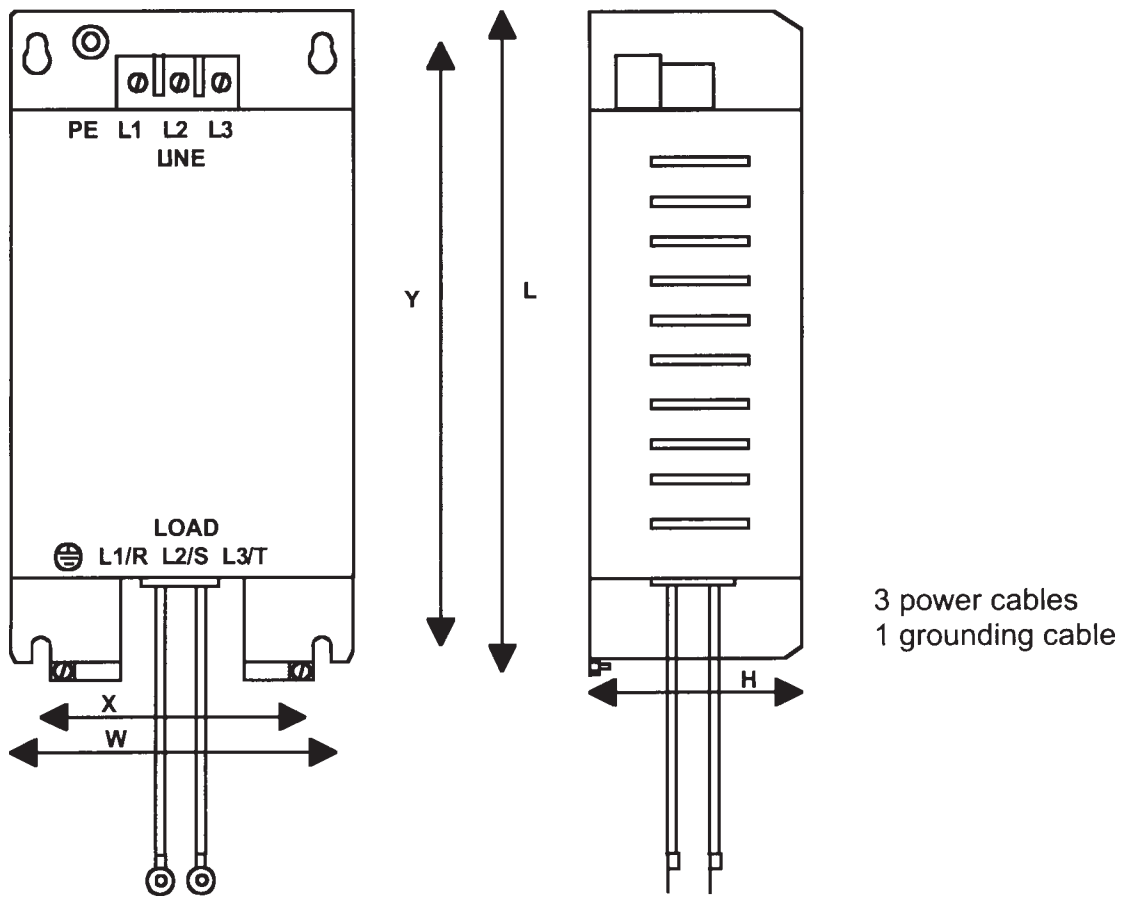
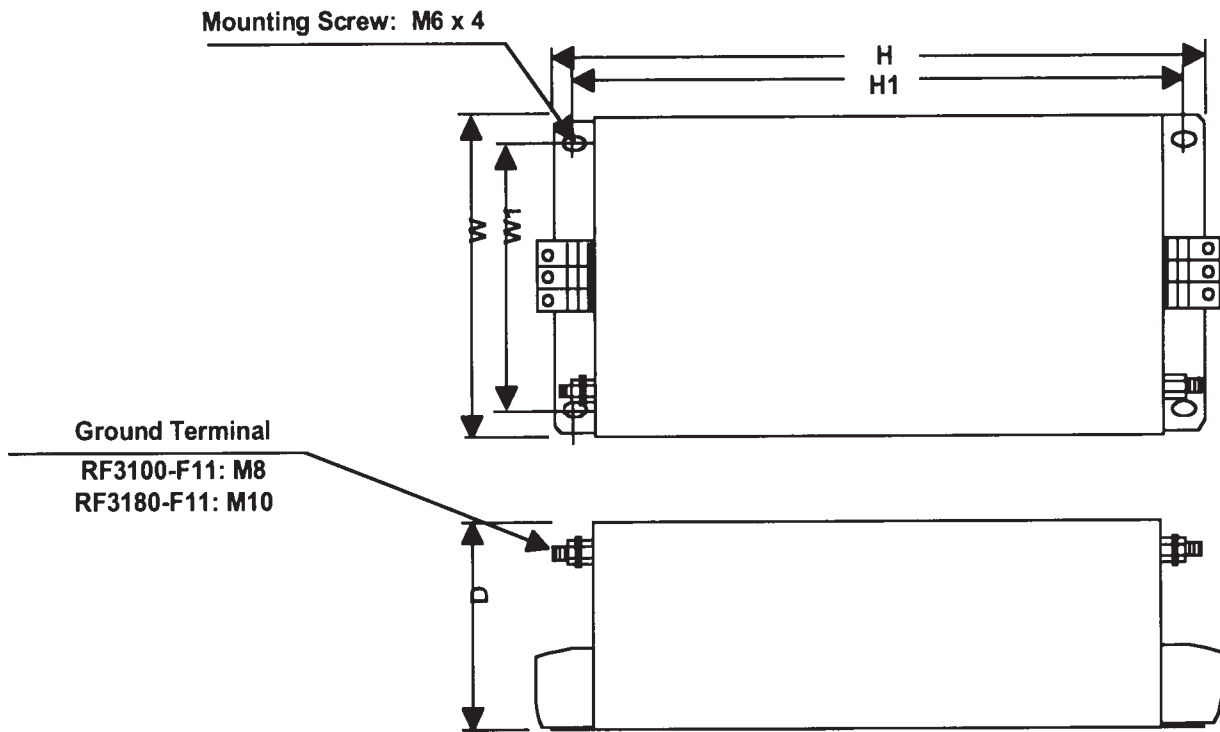

Figure 2



Filter Type	Dimensions : Inches (mm)				
	W	W1	H	H1	D
RF3100-F11	7.87 (200)	6.54 (166)	17.1 (435)	16.1 (408)	5.12 (130)
RF3180-F11	7.87 (200)	6.54 (166)	19.5 (495)	18.4 (468)	6.30 (160)

Figure 3 Outline Dimensions (RF3100-F11, RF3180-F11)

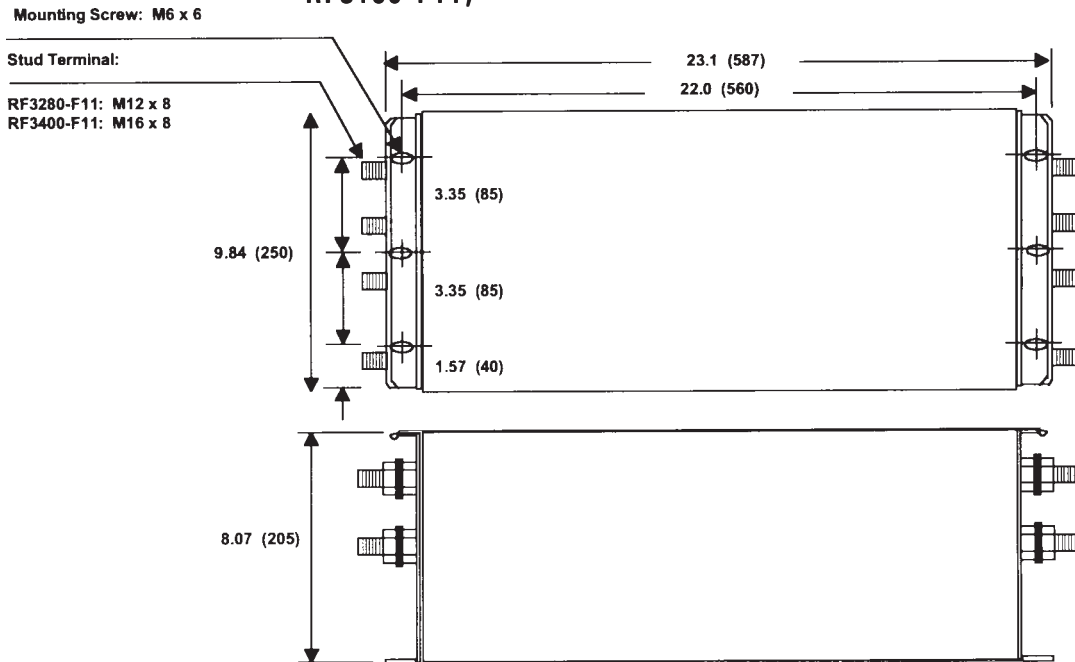

Figure 4 Outline Dimensions (RF3280-F11, RF3400-F11)

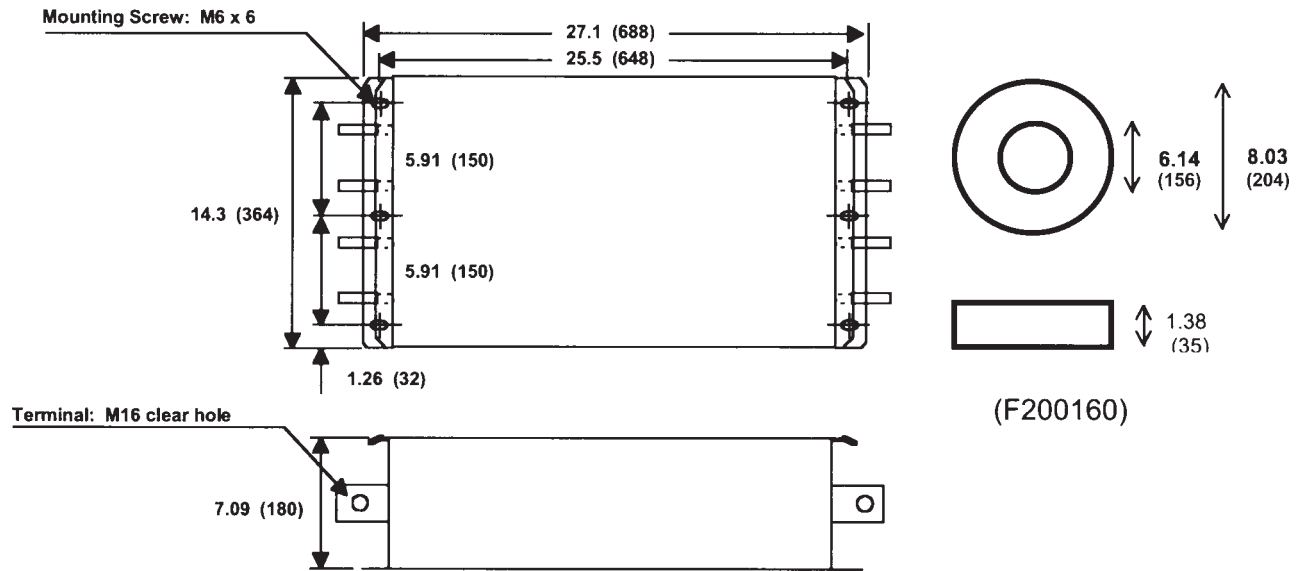

Figure 5 Outline Dimensions (RF3880-F11)

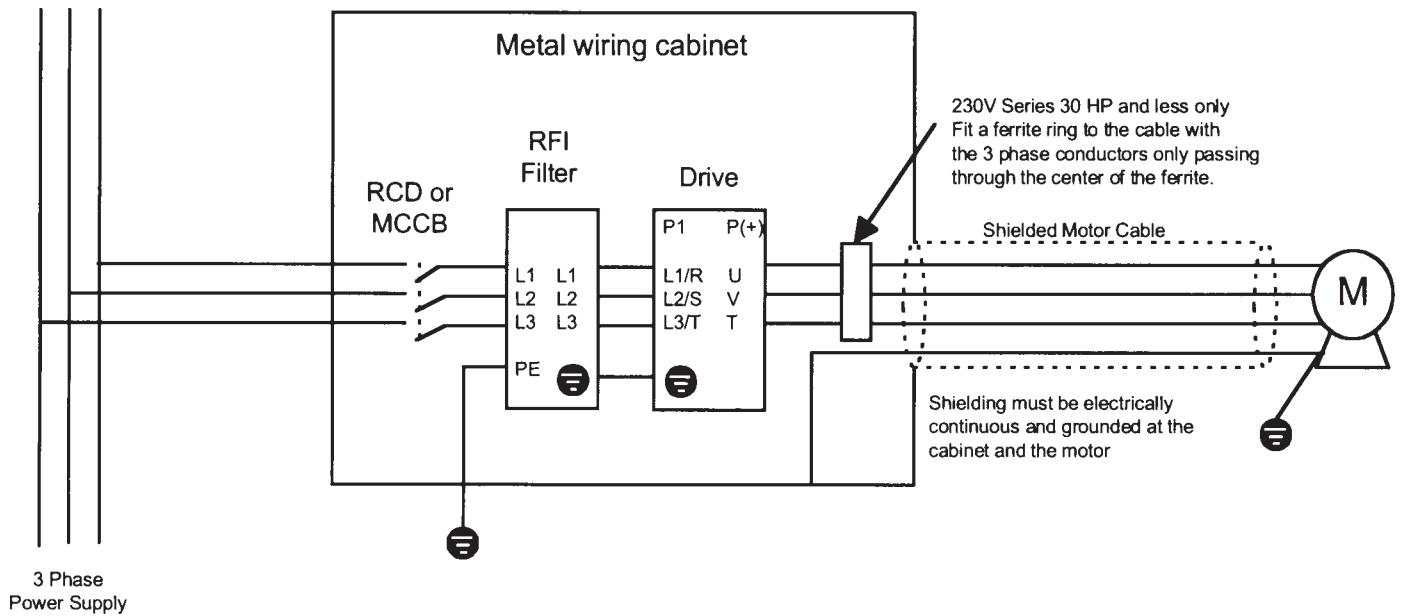

Figure 6 230V all Hp
460V less than 350 Hp

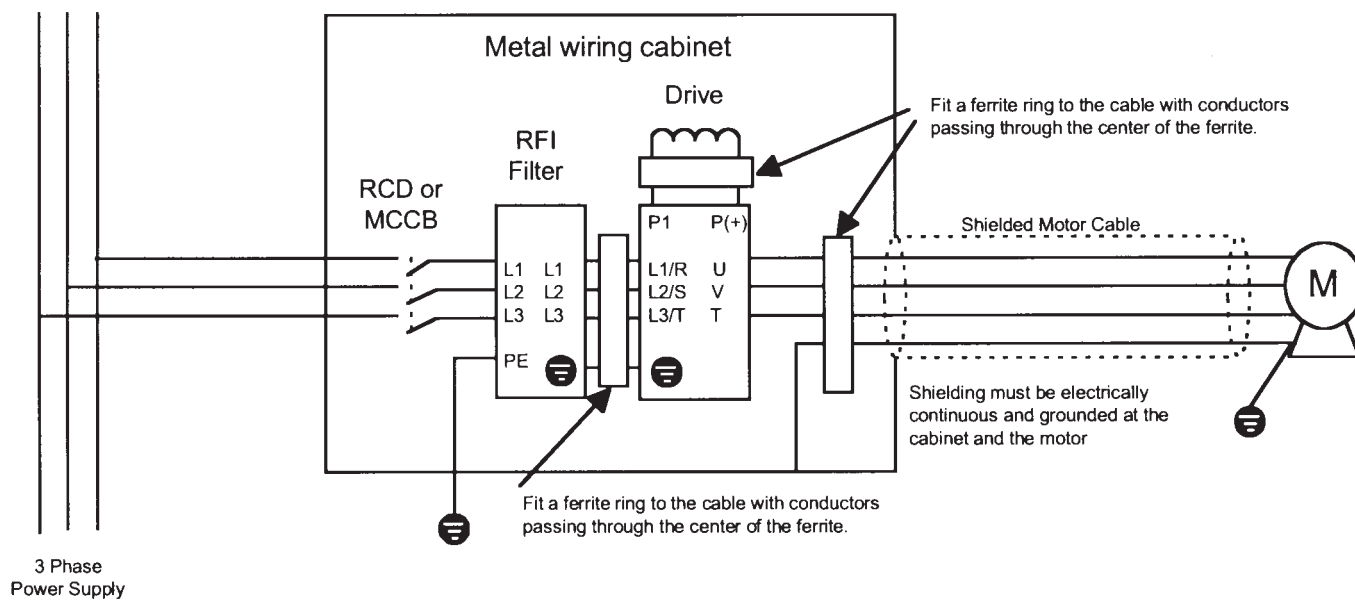

Figure 7 GP10 460V 400 Hp and higher

5580 Enterprise Parkway, Fort Myers, Florida 33905 • Telephone (941) 693-7200 • Fax (941) 693-2431