

OSP-U100
OSP-U10

MacMan

INSTRUCTION MANUAL (1st Edition)

Pub. No. 4201-E (SE34-007-R1) March 1998



SAFETY PRECAUTIONS

The NC unit that features the IGF function is equipped with a variety of safety devices to protect personnel and the machine from hazards arising as a result of unforeseen accidents while operating the machine. However, incorrect use of the function can lead to serious accidents and injuries. In order to prevent such accidents, read this manual and related manuals carefully so that you can use the IGF function correctly.

The points presented below are those that require particular attention when using the IGF function. Be sure to read this information and follow the instructions in it. The cautions below and the warning signs attached to the machine cover only those hazards which can be predicted. Be aware that they do not cover all possible hazards.

1. Precautions on Reading This Manual

This manual only provides information relating to the IGF function: in addition to this manual, manuals relating to the operation of the machine and NC unit, the parameters, alarms/errors, maintenance, etc., are also provided.

Read these manuals before actually using the IGF function or running an NC program created using the IGF function.

2. Precautions on Use

2-1. Starting up the IGF Function

For details on the turning on the power and selecting the operation mode before starting up the IGF function, refer to the manuals relating to operation of the machine and NC unit. Strictly observe the cautions given in these manuals.

2-2. Operations while Using the IGF Function

If any alarm or error occurs while using the IGF function, determine its exact nature and take corrective action by referring to this manual and the manuals relating to alarms and errors.

2-3. Running NC Programs Created Using the IGF Function

- (1) Use the simulation function of the IGF function to check the operation before running an NC program created using the IGF function to perform actual machining.
- (2) Never run a program created using the IGF function to perform actual machining without checking its operation. Run the program with no workpiece and make sure that there is no interference, then cut a workpiece in the single block mode. If no problems are discovered, automatic operation may be started.
- (3) Confirm safety before performing operations involving spindle rotation or axis motion.
- (4) Never touch the moving parts of the machine, chips, or the workpiece during machine operation.
- (5) Check the tool offset values.
- (6) Check the zero offset values.

- (7) Make sure that all override settings on the machine operation panel are set to 100%. Or, if necessary, use a lower override.
- (8) If using a machine with a cover, always close the cover before starting operation. Do not operate the machine with any safety cover removed.
- (9) Check carefully that the spindle speed, feedrates, infeeds, etc. specified in created programs are within the permissible ranges for the tools, chuck, fixture, etc., used during operation.

3. On Finishing Work

- (1) On finishing work, clean the vicinity of the machine.
- (2) Return all devices to their predetermined retraction positions.
- (3) Always turn off the power to the machine before leaving it.
- (4) Always quit the IGF function before turning off the power.
- (5) To turn off the power, turn off the CONTROL ON switch on the operation panel first, then the main power disconnect switch.

4. When Performing Maintenance Inspections/When Trouble Occurs

- (1) To execute an emergency stop, press the emergency stop button on the operation panel.
- (2) Consult the person responsible for maintenance to determine what corrective measures need to be taken.
- (3) Before contacting the service center after an alarm or error has occurred, write down all the relevant alarm and error messages displayed.
- (4) Carefully read this manual and the manuals relating to alarms and errors, machine and NC unit operation, and parameters, etc., before taking corrective action during a maintenance inspection or in response to trouble. Strictly observe the cautions in these manuals.

5. Symbols Used in Manual

The following warning indications are used in this manual to draw attention to information of particular importance. Read the instructions marked with these symbols carefully and follow them.

 **DANGER** : Indicates an imminent hazard which, if not avoided, will result in death or serious injury.

 **WARNING** : Indicates hazards which, if not avoided, could result in death or serious injury.

 **CAUTION** : Indicates hazards which, if not avoided, could result in minor injuries or damage to devices or equipment.

 **NOTICE** : Indicates precautions relating to operation or use.

TABLE OF CONTENTS

	<u>PAGE</u>
SECTION 1 MACMAN	1
1. OVERVIEW	1
1-1. MacMan Provides the Live Production Status Information	1
1-2. MacMan Slashes Down Time	4
1-3. MacMan Streamlines In-process Setup Time	5
1-4. List of MacMan Operations	6
SECTION 2 MACMAN MAIN SCREEN	10
2-1. Machining Status	11
2-2. Today's Machining Report	12
2-3. Today's Operating Report	14
2-4. Changing the Reason of Not-operating Status	16
SECTION 3 DOCUMENT DISPLAY	20
SECTION 4 MEMO DISPLAY	22
4-1. Displaying a Memo File	23
4-2. Reading a Memo File	25
4-3. Selecting a File from Directory	28
SECTION 5 JOB PROCEDURE DISPLAY	32
5-1. Display a Job Procedure File	32
5-2. Reading a Job Procedure File	33
SECTION 6 MACHINING PREPARATION	34
6-1. Display of Operation Files and Preparation Files	35
6-2. Reading a Machining Program File	36

SECTION 7	REPORT INFORMATION DISPLAY	40
SECTION 8	MACHINING REPORT DISPLAY	46
8-1.	Daily Machining Report (Today)	46
8-2.	Daily Machining Report (Pre Day)	49
8-3.	Period Machining Report	51
8-4.	Outputting the Machining Report to Floppy Disk	53
8-5.	Outputting the Machining Report to Printer	55
SECTION 9	OPERATING REPORT	56
9-1.	Daily Operating Report (Daily)	56
9-2.	Daily Operating Report (Pre Day)	58
9-3.	Period Operating Report (To-Today)	60
9-4.	Outputting the Operating Report to Floppy Disk	63
9-5.	Outputting the Operating Report to Printer	64
SECTION 10	OPERATING HISTORY	65
10-1.	Daily Operating History (Today)	65
10-2.	Daily Operating History (Pre Day)	67
10-3.	Outputting the Operating History to Floppy Disk	69
10-4.	Outputting the Operating History to Printer	70
SECTION 11	TROUBLESHOOTING INFORMATION	71
SECTION 12	NC STATUS AT ALARM	75
12-1.	Selecting the Alarm for Output	76
12-2.	Outputting the NC Status at Alarm to Floppy Disk	77
12-3.	Outputting the NC Status at Alarm to Printer	79
SECTION 13	CURRENT NC STATUS	80
13-1.	Selecting the Output Data	81
13-2.	List of Output Data	84

	<u>PAGE</u>
13-3. Outputting the Current NC Status to Floppy Disk	87
13-4. Outputting the Current NC Status to Printer	89
 SECTION 14ALARM HISTORY	 90
14-1. Displaying the Alarm History	91
14-2. Outputting the Alarm History to Floppy Disk	92
14-3. Outputting the Alarm History to Printer	94
 SECTION 15OPERATION HISTORY	 95
15-1. Operation History - Console Line	95
15-2. Operation History - Operation Panel	97
15-3. Operation History - I/O Signals	101
15-4. Outputting the Operation History to Floppy Disk	103
15-5. Outputting the Operation History to Printer	105
 SECTION 16VARIABLE HISTORY	 106
16-1. Displaying the Variable History	107
16-2. Outputting the Variables History to Floppy Disk	110
16-3. Outputting the Variables History to Printer	112
 SECTION 17PREFERENCE SETTINGS	 113
17-1. REPORT/PRINTER Screen	118
17-2. INPUT DATA Screen	121
17-3. OUTPUT DATA Screen	123
17-4. I/O Signals	127
17-5. VARIABLES-A Screen to VARIABLES-D Screen	130
 SECTION 18LIST OF OUTPUT MESSAGES	 133
 SECTION 19OUTPUT FILES	 137

SECTION 1 MacMan

1. OVERVIEW

The MacMan has been developed by focusing on the following problems among a variety of problems to be solved:

- What should we do to improve operation efficiency of the machine tools and other production equipment?
- What should we do to shorten lead time to output products?

Higher operation efficiency and shorter lead time are both the key themes to be achieved to successfully shift the production style to small lot production with a large number of workpiece kinds and then to variable lot size production.

The MacMan will provide you the information necessary for finding solutions to these themes.

1-1. MacMan Provides the Live Production Status Information

If you want to run the production equipment more efficiently, the first step you must take is to "find" the actual operating efficiency. Here, the term "find" does not mean "seeing", but it includes the processing to "digitize" the information. Similarly, to shorten the lead time, you must "find" the status how the production progresses. To "find" the actual status is the first step to improvements.

The MacMan collects and outputs the continuously changing actual status of production.

- It outputs the actual status to the NC screen. Improvements at the production field by an operator is possible by viewing the actual status.
- It outputs the actual status to the printer. The accurate production report can be output in one-touch operation.
- It outputs the actual status to the MS-DOS format floppy disk. Production field management by using a personal computer is possible.

(1) Machining Report

Job progress status is displayed for each of the selected main programs.

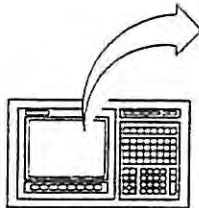

MacMan						
START	OPERATING	MAINTENANCE				
MACH NAME:MC. NAME /						
DAILY MACHINING REPORT (TODAY)					92/07/17	PAGE : 1
MAIN PROGRAM	START DAY	START TIME	NO. OF WORK	OPERATING %		
PART045-L4392. MIN	93/07/17	12:12:09	8	43		
PART045-L4393. MIN	93/07/17	10:58:54	10	65		
PART328-L0032. MIN	93/07/17	9:34:21	12	36		
PART004-L0482. MIN	93/07/17	8:19:23	4	52		
SUM						
	93/07/17	8:19:23	34	45		
PART045-L4393. MIN OP004						
=						
DAILY (TODAY)	DAILY (PRE)	PERIOD	PRINTER OUTPUT	DATA OUTPUT	QUIT	

(2) Operating Report

Operating status is displayed in bar graph.

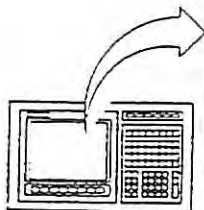

MacMan							
START	OPERATING	MAINTENANCE					
MACH NAME:MC. NAME							
DAILY OPERATING REPORT (TODAY)					93/07/17 13:32:56		
92/07/17							
	[H: M: S]	[%]	0%	25%	50%	75%	100%
RUNNING	4:34:21	100	[Bar graph showing 100% progress]				
OPERATING	3:58:23	53	[Bar graph showing 53% progress]				
CUTTING	2:59:43	24	[Bar graph showing 24% progress]				
NOT OPERATING	1:37:16	41	[Bar graph showing 41% progress]				
IN-PRO SETUP	1:10:10	32	[Bar graph showing 32% progress]				
NO OPERATOR	27:06	15	[Bar graph showing 15% progress]				
PART WAITING	0	0	[Bar graph showing 0% progress]				
MAINTENANCE	0	0	[Bar graph showing 0% progress]				
OTHER	0	0	[Bar graph showing 0% progress]				
SPINDLE RUN	2:37:16	48	[Bar graph showing 48% progress]				
EXTRNL INPUT	1:37:16	41	[Bar graph showing 41% progress]				
ALARM ON	0	0	[Bar graph showing 0% progress]				
=							
DAILY (TODAY)	DAILY (PRE)	PERIOD	PRINTER OUTPUT	DATA OUTPUT	QUIT		

(3) Operating History

Operating status is displayed in time chart.

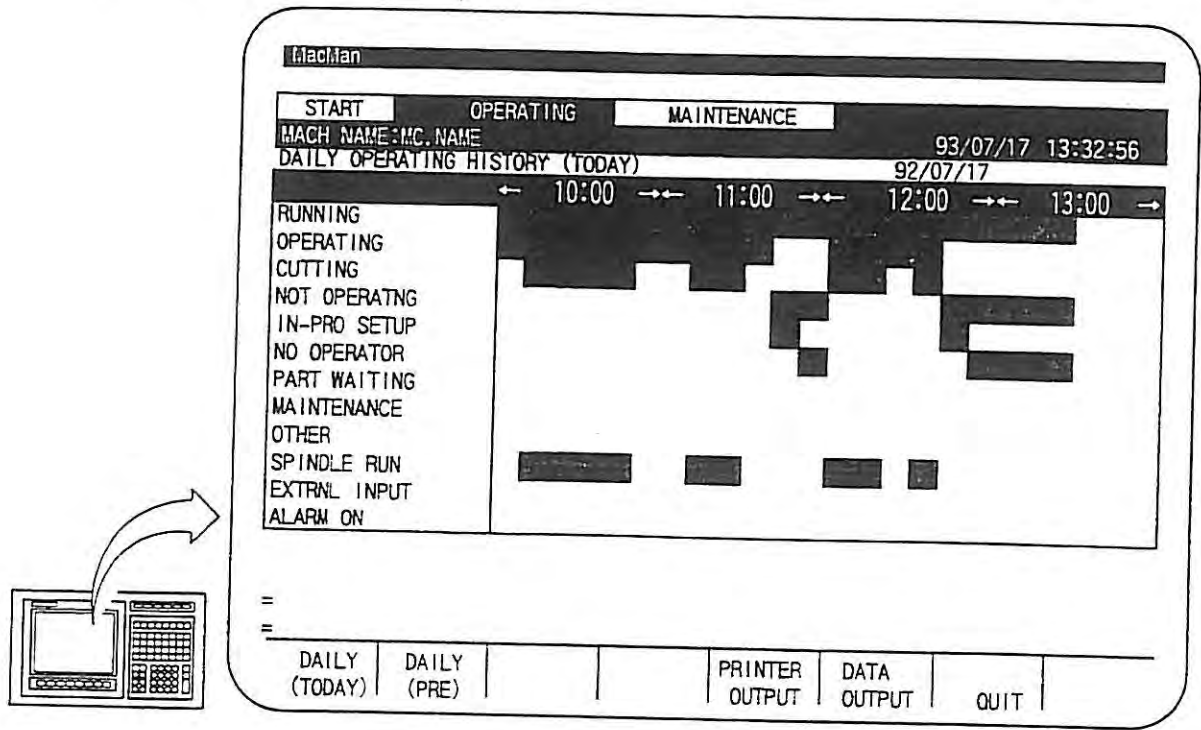

1-2. MacMan Slashes Down Time

Precise understanding of the situation of a trouble is the key to pin-pointed troubleshooting and quick recovery of the machine operation.

Using the MacMan, you can get the information necessary for troubleshooting either from a printer or on MS-DOS format floppy disk.

- Telefax the print out to Okuma service center. You are not bothered with time consuming telephone call to explain the service technician "what happened" any more.
- If you output the information to the floppy disk, the information can be analyzed by using a personal computer by either yourself or Okuma service technician.

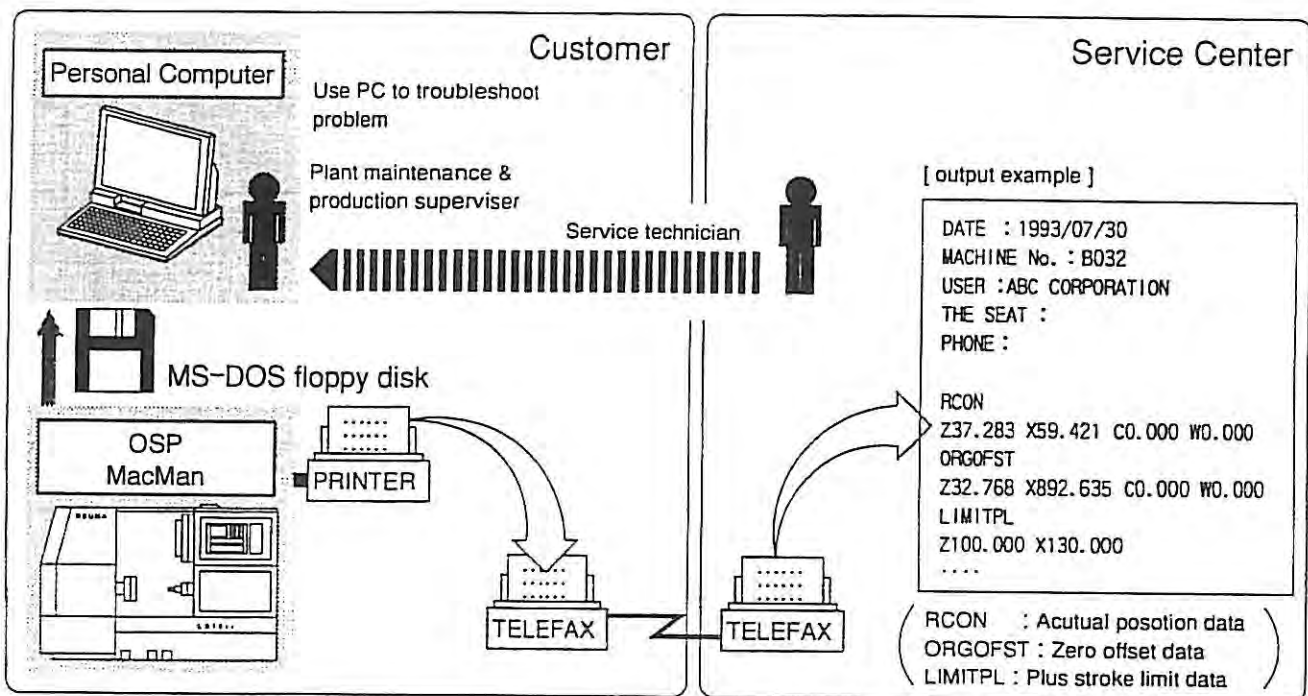

- (1) If you are in trouble due to alarm, switch the display to **NC STATUS AT ALARM**.

The status of the NC (actual position, zero offset data, travel limit data, etc.) when an alarm has occurred is output to the printer or floppy disk.

- (2) If you are in trouble although an alarm has not occurred, switch the display to **CURRENT NC STATUS**.

The current status of the NC (actual position, zero offset data, travel limit data, etc.) is output to the printer or floppy disk.

- (3) If you want to know about the operation, switch the screen to **OPERATION HISTORY**.

The operations you have done, "what operation has been made, when and what time", "what key has been pressed, when and what time", etc. are output to the printer or floppy disk.

1-3. MacMan Streamlines In-process Setup Time

As ordinary production style shifts from mass production to small lot production, the data used for machining must be changed frequently in response to frequent change in workpiece kinds. Imagine your supervisor talks to you "This is the program for the workpieces to be machined next" and you receive floppy disk. The process to start machining after that is not simple; first you have to store the program into the NC memory from the floppy disk. Then, you are required to select the program after changing the NC mode to automatic.

The MacMan allows you to store and select the program very simply.

- The same procedure can be used to read and store the program for the floppy disk of different format (OSP or MS-DOS). Because the format is not visible, there may be cases that an alarm message is displayed insisting you to return to the first step of operation if you follow the procedure for reading the OSP format floppy disk while the floppy disk is MS-DOS format or vice versa when the required procedure differs between OSP format floppy disk and MS-DOS format floppy disk.
- When selecting the program having been read and stored, you do not have to specify the file name. Simply press the function key, and the read program is selected.

To carry out set-up work quickly while machining data or other data must be changed frequently, document such as job instruction are necessary.

The MacMan displays the texts created using a personal computer on the NC screen. You can make and display your own job instructions such as set-up change procedure, alarm list, and G/M code table.

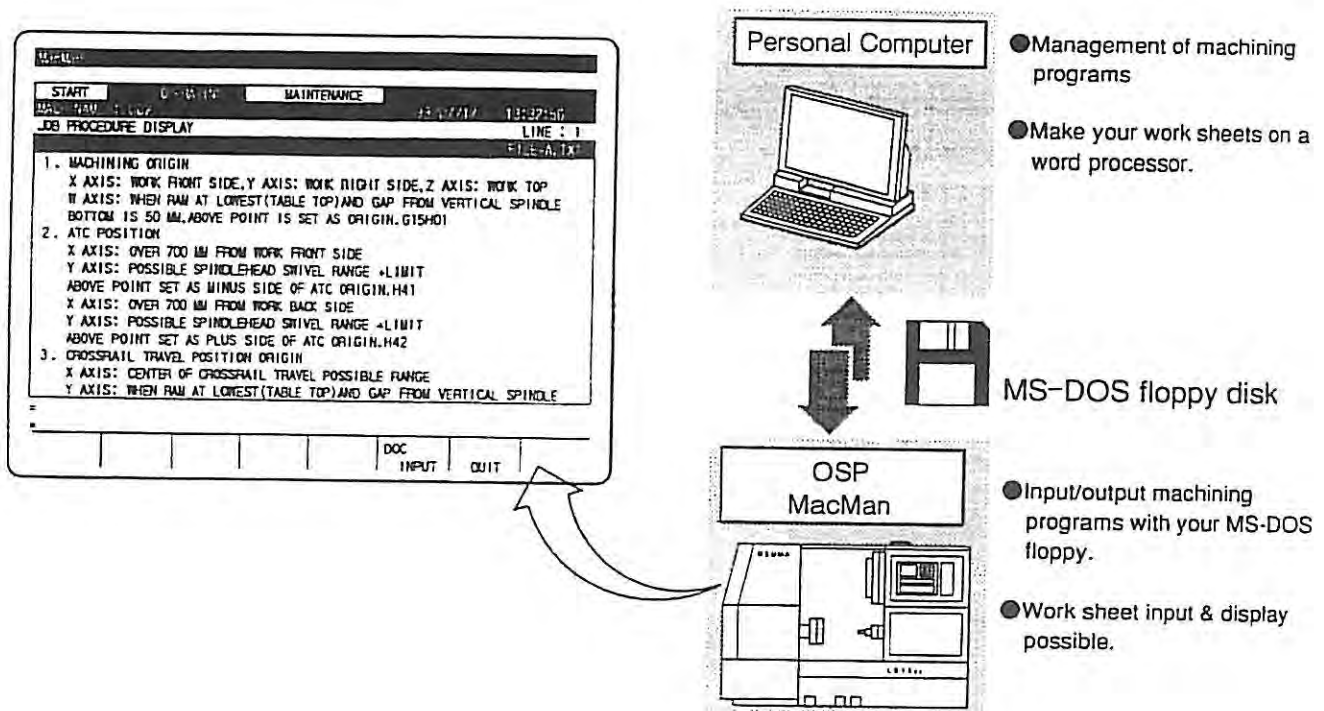

1-4. List of MacMan Operations

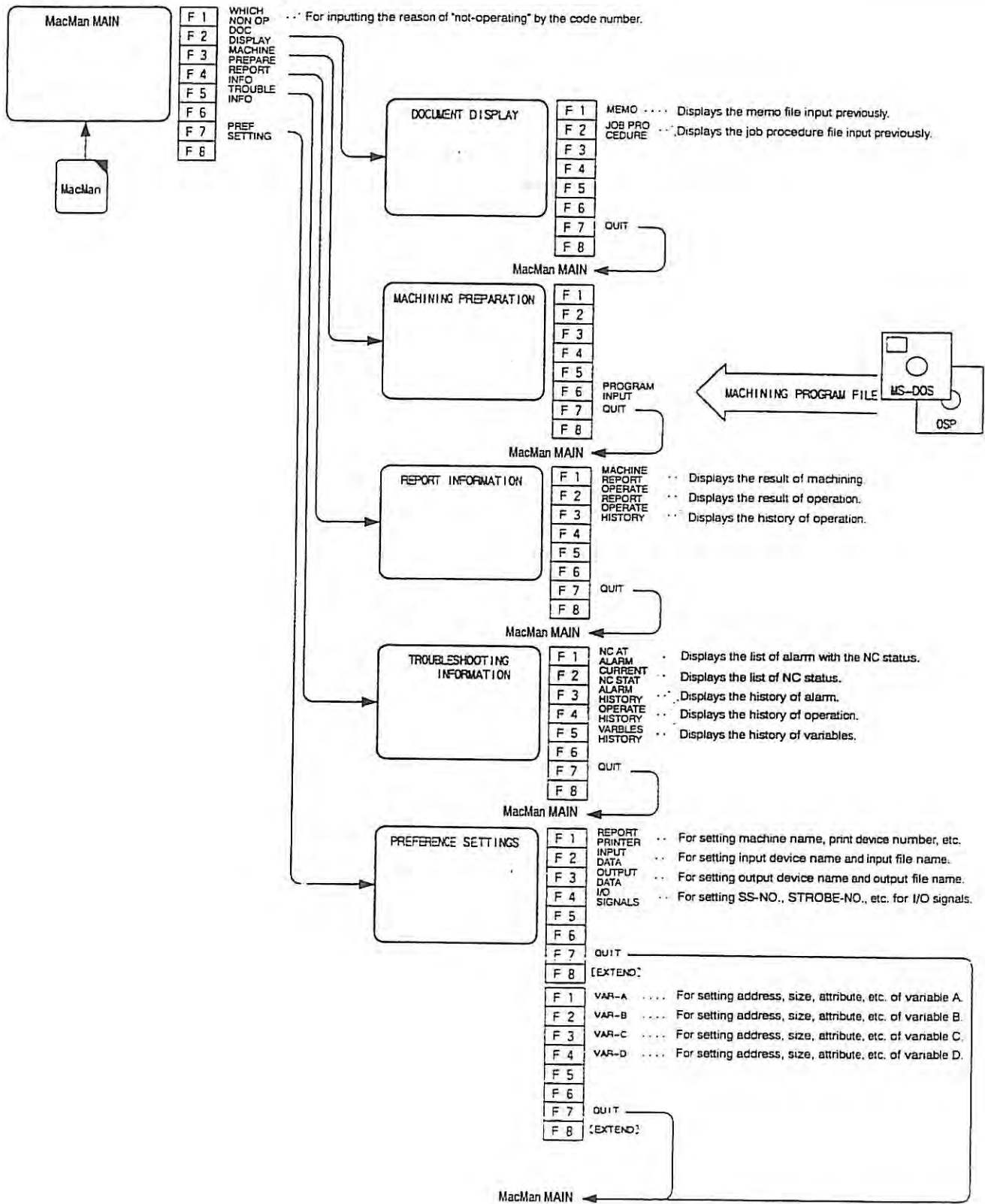

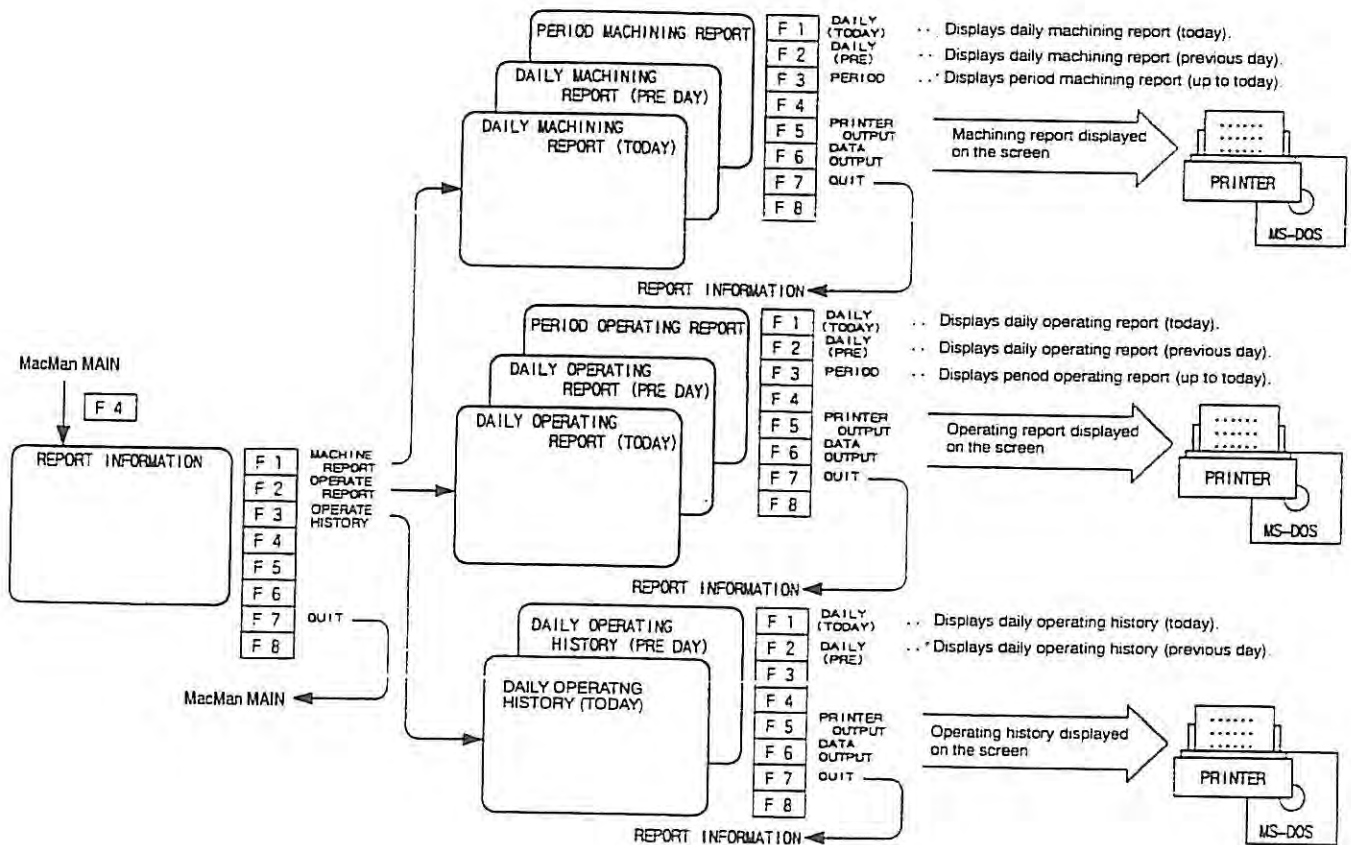
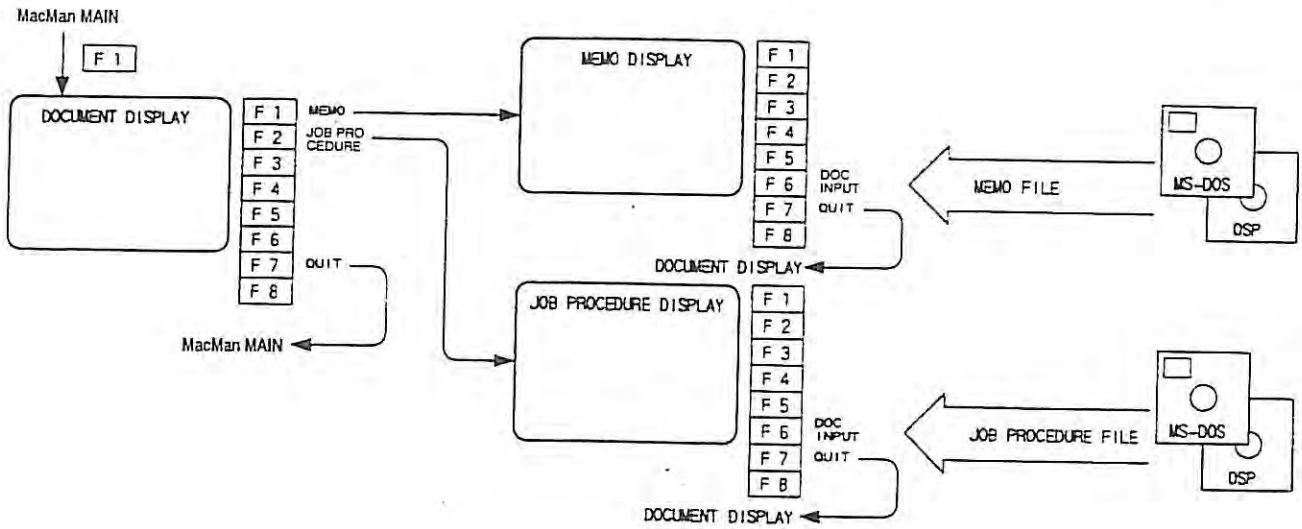

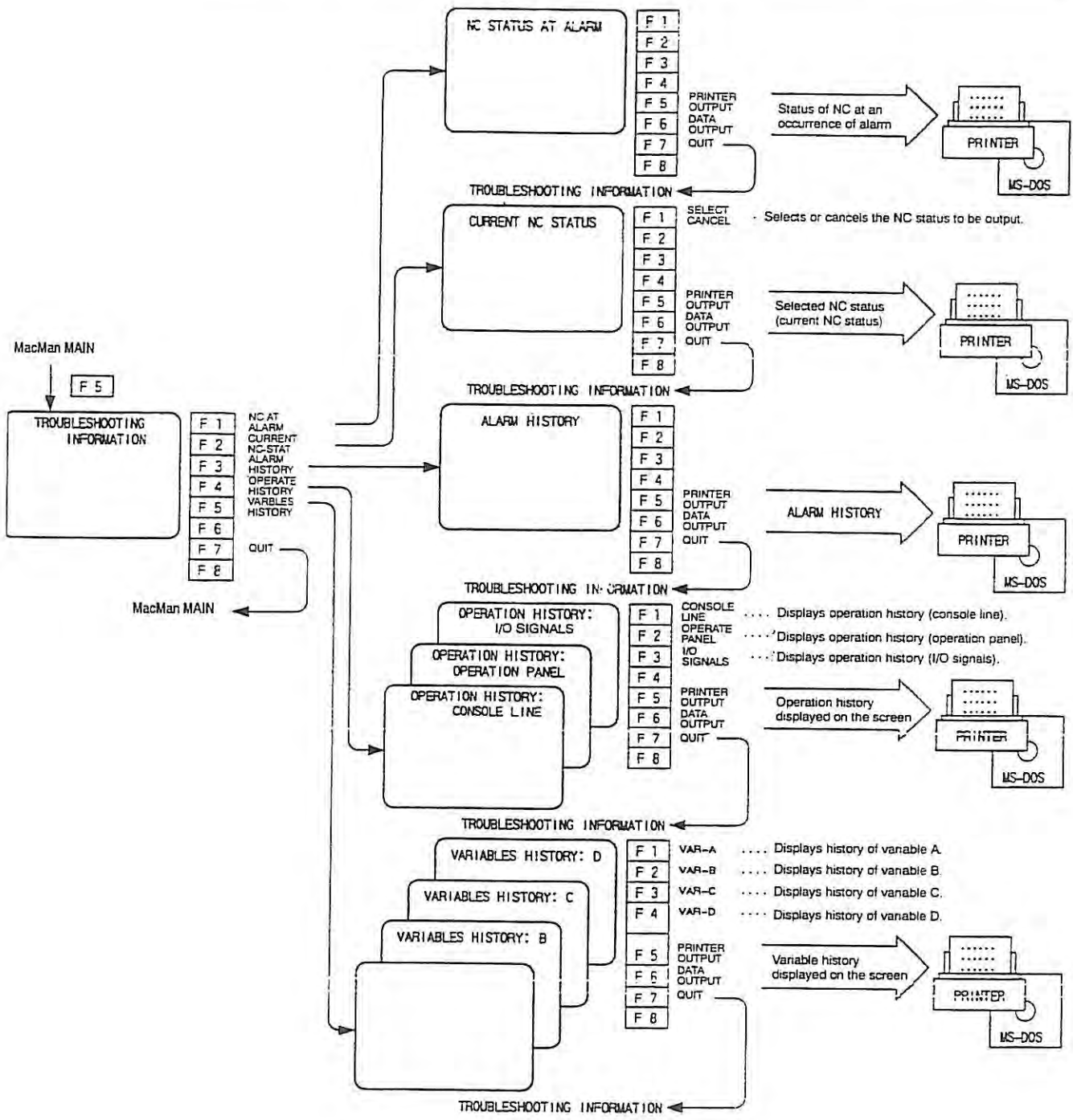

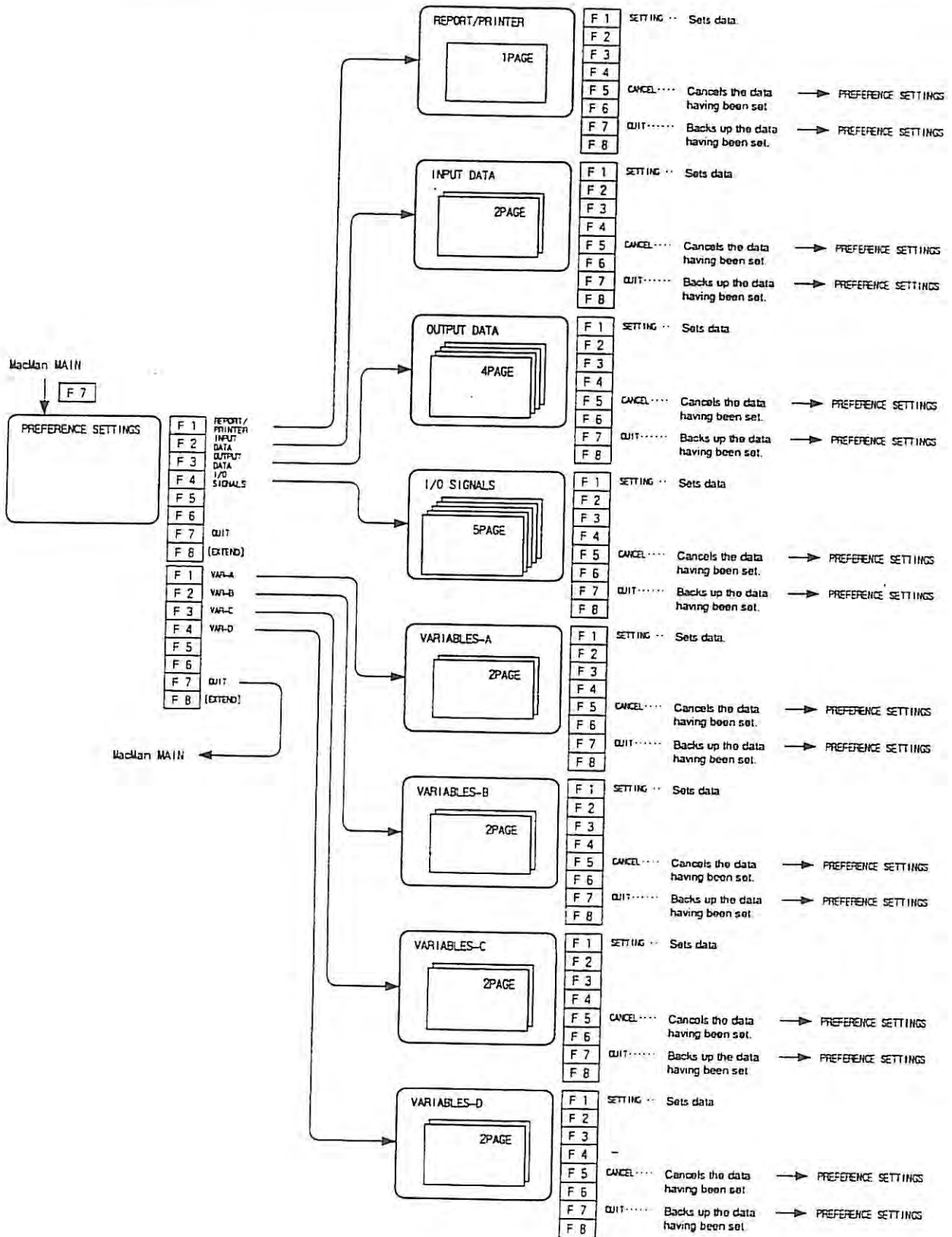

SECTION 2 MacMan MAIN SCREEN

MacMan

MACH NAME:MC.NAME 93/07/17 13:32:56

TODAY'S MACHINING REPORT

MAIN PROGRAM	START DAY	START TIME	NO. OF WORK	OPERATING %
PART045-L4392.MIN	93/07/17	12:12:09	8	43
SUM	93/07/17	8:19:23	34	45

PART045-L4392.MIN OPO23

TODAY'S OPERATING REPORT

	[H: M: S]	[%]	0%	25%	50%	75%	100%
RUNNING	4:34:21	100					
OPERATING	3:58:23	53					
CUTTING	2:59:43	24					
NOT OPERATING	1:37:16	41					
IN-PRO SETUP	1:10:10	32					
NO OPERATOR	27:06	15					
PART WAITING	0	0					
MAINTENANCE	0	0					
OTHER	0	0					

WHICH NON OP	DOC DISPLAY	MACHINE PREPARE	REPORT INFO	TROUBLE INFO	PREF SETTING
-----------------	----------------	--------------------	----------------	-----------------	-----------------

- F1

F2

F3

F4

F5

F6

F7

F8

2-1. Machining Status

On the screen, whether or not a program has been selected is indicated by "START" and whether or not a program is being executed is indicated by "OPERATING".

The area indicating the status explained above is common to all display screens.

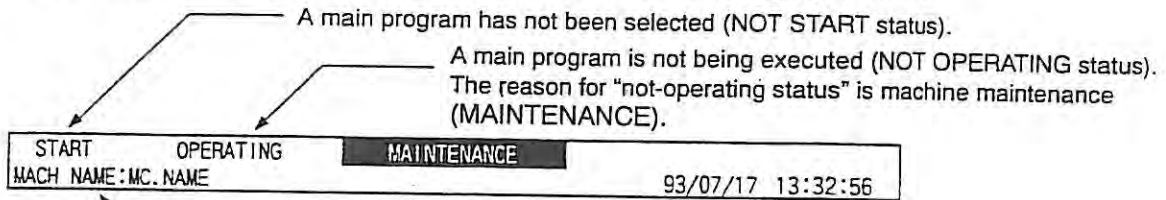

To be set by selecting "REPORT/PRINTER" on the PREFERENCE SETTING screen. The default machine name is "MC.NAME".

Date and time (today, current time)

Selecting a program

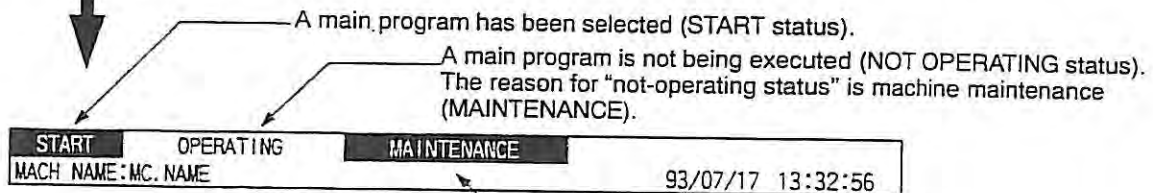

Reason for "not-operating" is displayed here:
IN-PRO SETUP, NO OPERATOR, PART WAITING, MAINTENANCE, or OTHER

Executing the program

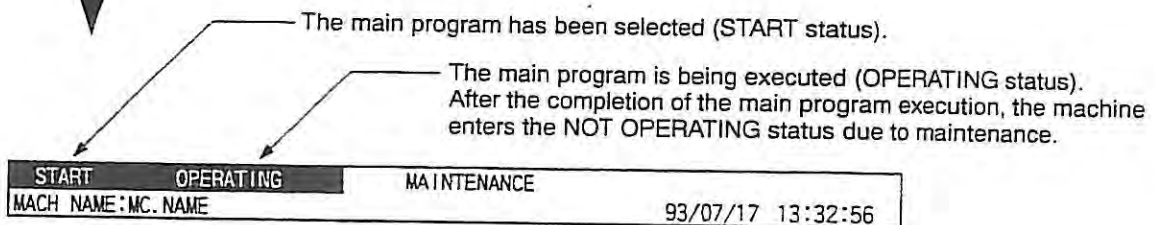

2-2. Today's Machining Report

- (1) Today's machining report is displayed.

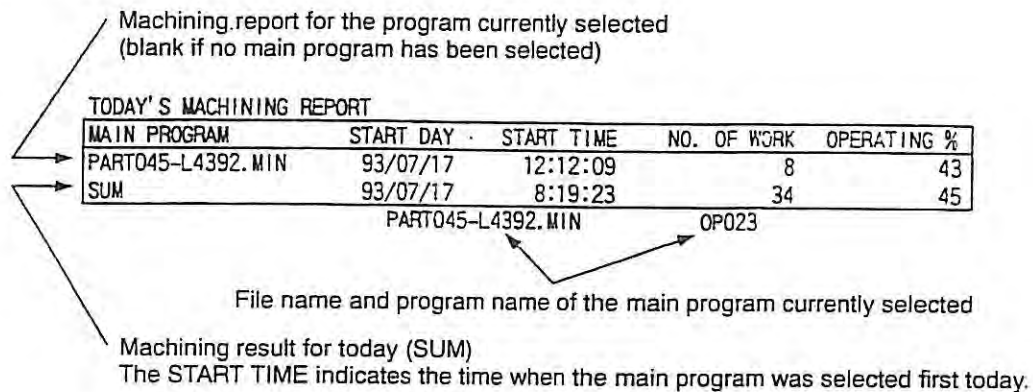

Item	Contents
MAIN PROGRAM	The file name of the main program having been selected
START DAY	Date of the main program selection [year/month/day]
START TIME	Time of the main program selection [hour:minute:second]
NO. OF WORK	The number of times the M02 or M30 command has been executed Execution of the M02 or M30 command in the machine lock mode operation and dry run mode operation (NC lathe) is not counted.
OPERATING %	Percentage of machine operating time in reference to power ON time [%] (Operating % = Machine operating time (OPERATING) / Power ON time (RUNNING) × 100)
RUNNING	Length of time for which power supply to the NC has been ON [hours:minutes:seconds] (Length of time for which main program has been selected)
OPERATING	Length of time for which a main program has been executed [hours:minutes:seconds] Length of time the main program has been executed in the machine lock mode or dry run mode (NC lathe) is not counted.
CUTTING	Length of time for which an axis has been moved at a cutting feedrate [hours:minutes:seconds] Length of time an axis has been moved at a cutting feedrate in the machine lock mode or dry run mode (NC lathe) is not counted.
CYCLE TIME	Length of time for which power has been ON for producing one piece of workpiece [hours:minutes:seconds/pc.] (Cycle time = Power on time (RUNNING) / No. of workpieces (NO. OF WORK))
MACHINING	Length of operating time used for producing one piece of workpiece [hours:minutes:seconds/pc.] (Machining time = Operating time (RUNNING) / No. of workpieces (NO. OF WORK))

The items of report are scrolled right or left by pressing the "right" or "left" cursor key (1 item/cursor key operation). Note that the MAIN PROGRAM is not shifted.

TODAY'S MACHINING REPORT

MAIN PROGRAM	START DAY	START TIME	NO. OF WORK	OPERATING %
PART045-L4392.MIN	93/07/17	12:12:09	8	43
SUM	93/07/17	8:19:23	34	45



TODAY'S MACHINING REPORT

MAIN PROGRAM	START TIME	NO. OF WORK	OPERATING %	RUNNING
PART045-L4392.MIN	12:12:09	8	43	4:32:46
SUM	8:19:23	34	45	8:25:32



TODAY'S MACHINING REPORT

MAIN PROGRAM	NO. OF WORK	OPERATING %	RUNNING	OPERATING
PART045-L4392.MIN	8	43	4:32:46	1:57:38
SUM	34	45	8:25:32	3:47:31



TODAY'S MACHINING REPORT

MAIN PROGRAM	OPERATING %	RUNNING	OPERATING	CUTTING
PART045-L4392.MIN	43	4:32:46	1:57:38	1:02:51
SUM	45	8:25:32	3:47:31	2:05:24



TODAY'S MACHINING REPORT

MAIN PROGRAM	RUNNING	OPERATING	CUTTING	CYCLE TIME
PART045-L4392.MIN	4:32:46	1:57:38	1:02:51	34:05
SUM	8:25:32	3:47:31	2:05:24	14:52



TODAY'S MACHINING REPORT

MAIN PROGRAM	OPERATING	CUTTING	CYCLE TIME	MACHINING
PART045-L4392.MIN	1:57:38	1:02:51	34:05	14:39
SUM	3:47:31	2:05:24	14:52	6:41

2-3. Today's Operating Report

- (1) Today's operating report is displayed.

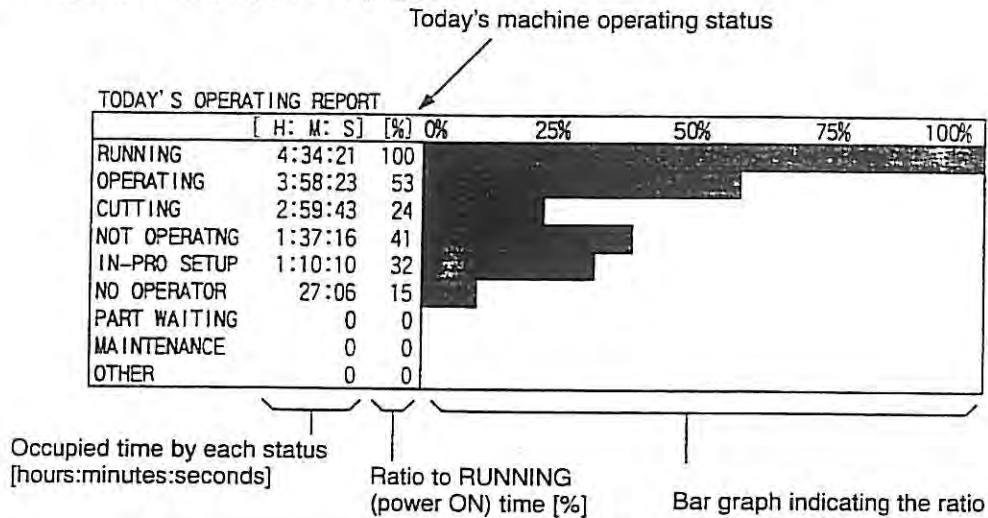

Item	Contents
RUNNING	Length of time for which power supply to the NC has been ON [hours:minutes:seconds] (Power ON (RUNNING) = OPERATING + NOT OPERATING)
OPERATING	Length of time for which a main program has been executed Length of time the main program has been executed in the machine lock mode or dry run mode (NC lathe) is not counted. (OPERATING = CUTTING + Not cutting)
CUTTING	Length of time for which an axis has been moved at a cutting feedrate [hours:minutes:seconds] Length of time an axis has been moved at a cutting feedrate in the machine lock mode or dry run mode (NC lathe) is not counted.
NOT OPERATING	Length of time for which a main program has not been executed (NOT OPERATING = IN-PRO SETUP + NO OPERATOR + PART WAITING + MAINTENANCE + OTHER)
IN-PRO SETUP	Constituent of not-operating time: machine has not been operating due to in-process setup.
NO OPERATOR	Constituent of not-operating time: machine has not been operating due to no operator attendance.
PART WAITING	Constituent of not-operating time: machine has not been operating due to waiting for workpiece to be machined.
MAINTENANCE	Constituent of not-operating time: machine has not been operating due to machine maintenance.
OTHER	Constituent of not-operating time: machine has not been operating due to reasons not classified into the items indicated above.
SPINDLE RUN	Length of time for which the spindle has been rotating Length of time the spindle has been rotating in the machine lock mode is not counted.
EXTERNAL INPUT	Length of time for which an external input signal has been ON
ALARM ON	Length of time for which the NC has been in an alarm state (alarm A, alarm B, alarm C)

The items of report are scrolled up or down by pressing the "up" or "down" cursor key (1 item/cursor key operation).

TODAY'S OPERATING REPORT

	[H: M: S]	[%]	0%	25%	50%	75%	100%	
RUNNING	4:34:21	100	████████████████████					
OPERATING	3:58:23	53	████████████████					
CUTTING	2:59:43	24	██████████					
NOT OPERATNG	1:37:16	41	██████████					
IN-PRO SETUP	1:10:10	32	██████████					
NO OPERATOR	27:06	15	██████████					
PART WAITING	0	0						
MAINTENANCE	0	0						
OTHER	0	0						

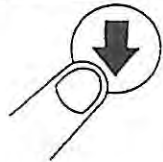

TODAY'S OPERATING REPORT

	[H: M: S]	[%]	0%	25%	50%	75%	100%	
OPERATING	3:58:23	53	████████████████					
CUTTING	2:59:43	24	██████████					
NOT OPERATNG	1:37:16	41	██████████					
IN-PRO SETUP	1:10:10	32	██████████					
NO OPERATOR	27:06	15	██████████					
PART WAITING	0	0						
MAINTENANCE	0	0						
OTHER	0	0						
SPINDLE RUN	3:03:21	48	████████████████					

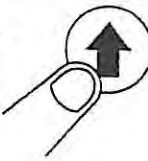
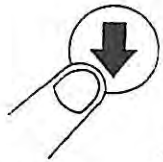

TODAY'S OPERATING REPORT

	[H: M: S]	[%]	0%	25%	50%	75%	100%	
CUTTING	2:59:43	24	██████████					
NOT OPERATNG	1:37:16	41	██████████					
IN-PRO SETUP	1:10:10	32	██████████					
NO OPERATOR	27:06	15	██████████					
PART WAITING	0	0						
MAINTENANCE	0	0						
OTHER	0	0						
SPINDLE RUN	3:03:21	48	████████████████					
EXTRNL INPUT	0	0						

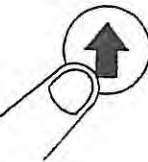

TODAY'S OPERATING REPORT

	[H: M: S]	[%]	0%	25%	50%	75%	100%	
NOT OPERATNG	1:37:16	41	██████████					
IN-PRO SETUP	1:10:10	32	██████████					
NO OPERATOR	27:06	15	██████████					
PART WAITING	0	0						
MAINTENANCE	0	0						
OTHER	0	0						
SPINDLE RUN	3:03:21	48	████████████████					
EXTRNL INPUT	0	0						
ALARM ON	27:06	15	██████████					

2-4. Changing the Reason of Not-operating Status

The current reason is in-process setup. Now, you are starting maintenance and the reason must be changed to maintenance accordingly.

MacMan

START	OPERATING	IN-PRO SETUP	93/07/17 13:32:56				
MACH NAME:MC_NAME							
TODAY'S MACHINING REPORT							
MAIN PROGRAM	START DAY	START TIME	NO. OF WORK	OPERATING %			
PART045-L4392.WIH	93/07/17	12:12:09	8	43			
SUM	93/07/17	8:19:23	34	45			
PART045-L4392.WIH OPO23							
TODAY'S OPERATING REPORT							
	H: M: S	(%)	OK	25%	50%	75%	100%
RUNNING	4:34:21	100					
OPERATING	3:58:23	53					
CUTTING	2:59:43	24					
NOT OPERATING	1:37:16	41					
IN-PRO SETUP	1:10:10	32					
NO OPERATOR	27:06	15					
PART WAITING	0	0					
MAINTENANCE	0	0					
OTHER	0	0					

WHICH NOT OPERATING? :

WHICH NON OP	DOC DISPLAY	MACHINE PREPARE	REPORT INFO	TROUBLE INFO	PREF SETTING
--------------	-------------	-----------------	-------------	--------------	--------------

F1 F2 F3 F4 F5 F6 F7 F8

The selected reason "MAINTENANCE" is displayed here.

MacMan

START	OPERATING	IN-PRO SETUP	93/07/17 13:32:56				
MACH NAME:MC_NAME							
TODAY'S MACHINING REPORT							
MAIN PROGRAM	START DAY	START TIME	NO. OF WORK	OPERATING %			
PART045-L4392.WIH	93/07/17	12:12:09	8	43			
SUM	93/07/17	8:19:23	34	45			
PART045-L4392.WIH OPO23							
TODAY'S OPERATING REPORT							
	H: M: S	(%)	OK	25%	50%	75%	100%
RUNNING	4:34:21	100					
OPERATING	3:58:23	53					
CUTTING	2:59:43	24					
NOT OPERATING	1:37:16	41					
IN-PRO SETUP	1:10:10	32					
NO OPERATOR	27:06	15					
PART WAITING	0	0					
MAINTENANCE	0	0					
OTHER	0	0					

(0=IN-PROCESS SETUP, 1=NO OPERATOR, 2=PART WAIT, 3=MAINT, 4=OTHER)
WHICH NOT OPERATING? :

WHICH NON OP	DOC DISPLAY	MACHINE PREPARE	REPORT INFO	TROUBLE INFO	PREF SETTING
--------------	-------------	-----------------	-------------	--------------	--------------

MacMan

START	OPERATING	MAINTENANCE	93/07/17 13:32:56				
MACH NAME:MC_NAME							
TODAY'S MACHINING REPORT							
MAIN PROGRAM	START DAY	START TIME	NO. OF WORK	OPERATING %			
PART045-L4392.WIH	93/07/17	12:12:09	8	43			
SUM	93/07/17	8:19:23	34	45			
PART045-L4392.WIH OPO23							
TODAY'S OPERATING REPORT							
	H: M: S	(%)	OK	25%	50%	75%	100%
RUNNING	4:34:21	100					
OPERATING	3:58:23	53					
CUTTING	2:59:43	24					
NOT OPERATING	1:37:16	41					
IN-PRO SETUP	1:10:10	32					
NO OPERATOR	27:06	15					
PART WAITING	0	0					
MAINTENANCE	0	0					
OTHER	0	0					

WHICH NOT OPERATING? :

WHICH NON OP	DOC DISPLAY	MACHINE PREPARE	REPORT INFO	TROUBLE INFO	PREF SETTING
--------------	-------------	-----------------	-------------	--------------	--------------

Find the code number heading the reason in the line just above "WHICH NOT OPERATING?!" message.

WRITE

Because you want to change the reason to maintenance, press 3 and WRITE key.

(1) Reasons for Not-operating Status

The MacMan provides five categories for the reasons for not-operating status.

(a) IN-PROCESS SETUP

Setup is largely classified into two categories, the one which requires the machine to be stopped and the other which can be carried out without stopping the machine.

Select "0 = IN-PROCESS SETUP" for the setup which requires the machine to be stopped.

(b) NO OPERATOR

There are cases that an operator takes care of two or more machines. In this case, if operator's attendance is required for more than one machine, the machine(s) will not be able to continue operating while an operator takes care of one machine.

Select "1 = NO OPERATOR" if the machine has to be stopped in such status.

(c) PART WAIT

If a workpiece, cutting tool(s), and/or a workpiece holding device is not ready or is not supplied to the machine on time, the machine will not be able to operate until all of them are supplied to it.

Select "2 = PART WAIT" if the machine has to be stopped in such status.

(d) MAINTENANCE

Select "3 = MAINTENANCE" if the machine has to be stopped due to maintenance.

(e) OTHER

Select "4 = OTHER" if the machine has to be stopped due to the reasons not given above.

(2) Changing the Reason Manually

If you want to change the reason for not-operating status, press function key [F1] (WHICH NON OP) and input the code number heading the reason to be selected. For example, change the reason to "MAINTENANCE" before you begin maintenance.

Note 1: After pressing function key [F1] (WHICH NON OP), if you do not want to change the reason, simply press the [WRITE] key without keying in a code number.

Note 2: It is possible to change the reason for not-operating status while the machine is operating. If you have to leave the machine while it is operating to take care of other machine, you can change the reason to "NO OPERATOR" before you leave the machine.

(3) Changing the Reason Automatically

The MacMan can determine the reason for not-operating status automatically. If you select "IN-PROCESS SETUP" for the reason, you are not requested to change the reason while the machine is operating continuously.

- (a) Ordinary not-operating status, due to such as changing workpieces and removing chips, is classified into "IN-PROCESS SETUP".

- (b) Assume that you leave the machine, without changing the reason:

While you are not attending the machine, that situation is recognized by the NC from the fact that none of keys on the NC operation panel has not been pressed for a period longer than the parameter-set time. Upon recognition of this, the NC automatically changes to reason from "IN-PROCESS SETUP" to "NO OPERATOR".

- (c) If you come back to the machine for which the reason for not-operating has been changed to "NO OPERATOR":

The NC recognizes that you have returned to the machine from the fact that a key on the NC operation panel has been pressed. Then, the NC automatically switches the reason back to "IN-PROCESS SETUP".

If the reason for not-operating status is "PART WAITING", "MAINTENANCE", or "OTHER", the automatic change function is not valid. If the machine has to be stopped, due to any of these reasons, change the reason manually. When the machine restarts, change the reason for not-operating status manually again.

Note: To use the automatic change function for the not-operating status reasons, change the setting for the corresponding parameters on the "REPORT/PRINTER" screen in the "PREFERENCE SETTINGS" function.

Parameter	Default
USE NOT OPERATING ITEM FOR AUTO DECISION (0=NO,1=YES)	0 (No)
TIME ALLOWED BEFORE DETERMINING NO OPERATOR PRESENT (hh:mm:ss)	00:20:00 (20 minutes)

MacMan		
START	OPERATING	MAINTENANCE
MACH NAME: MC. NAME	93/07/17 13:32:56	
PREFERENCE SETTINGS: REPORT/PRINTER		
MACHINE NAME		
MC. NAME		
PERIOD OPERATING REPORT—CLEAR DATE (YYYY/MM/DD)		
1980/01/01		
USE NOT OPERATING ITEM FOR AUTO DECISION (0=NO, 1=YES)		
1		
TIME ALLOWED BEFORE DETERMINING NO OPERATOR PRESENT (hh:mm:ss)		
00:20:00		
PRINT DEVICE NO. (0=CNO, 1=CN1, 2=CN2, 3=CN3, 4=CN4), 5=PR)		
0		
=		
=		
SETTING	CANCEL	QUIT

- If the current reason is "IN-PROCESS SETUP":
The reason is changed to "NO OPERATOR" if a key on the NC operation panel has not been pressed for more than 20 minutes (00:20:00).
- If the current reason is "NO OPERATOR":
The reason is changed to "NO OPERATOR" if any of the keys on the NC operation panel is pressed.
- If the current reason is "PART WAITING", "MAINTENANCE", or "OTHER":
The reason is not changed automatically.

SECTION 3 DOCUMENT DISPLAY

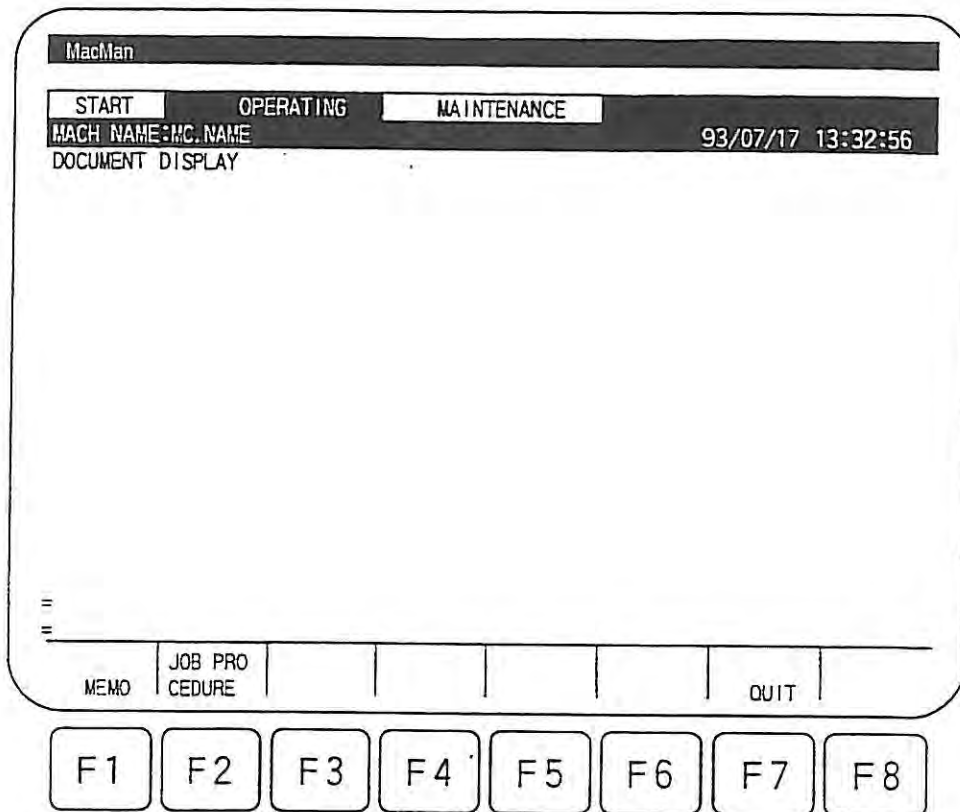

- (1) A document created using word processor software and saved to floppy disk (MS-DOS format, or OSP format) can be read into the OSP to be displayed on the NC screen.
 - OSP format
 - MS-DOS format: 2DD-640/720 KB
2HC-1.20 MB
2HD-1.23 MB
2HD-1.44 MB
- (2) Switch the document to be displayed by pressing function keys [F1] (MEMO) and [F2] (JOB PROCEDURE).
 - (a) On the MEMO DISPLAY screen displayed in response to the pressing of function key [F1] (MEMO), the document file called memo file is handled. This operation is provided to use the floppy disk stored information for communications.
 - (b) On the JOB PROCEDURE DISPLAY screen displayed in response to the pressing of function key [F2] (JOB PROCEDURE), the document file called job procedure file is handled. This operation is provided to use the floppy disk as the media to display the job instructions.
 - (c) The memo file and job procedure file are handled as an independent file from each other. Therefore, if you make changes to one of these document files, the other file is not influenced by the changes.

- (3) Just after the screen is changed, the document file read last is displayed.
 - (a) The file name of the document file presently displayed is displayed at the upper right area of the screen. This file is registered as the "memo file" or "job procedure file" and stored in the NC memory like machining programs.
 - (b) Since the document file displayed on the screen is stored in the NC memory, the file is displayed when the MEMO DISPLAY or JOB PROCEDURE DISPLAY screen is accessed even after the power supply to the NC is turned off and on. However, when the machine is shipped, no document file is stored in the NC memory and nothing is displayed even when the MEMO DISPLAY or JOB PROCEDURE DISPLAY screen is accessed.
- (4) When you let the NC read a document file, it is displayed on the NC screen upon completion of reading.
 - (a) When a new document file is read while the NC has the document file previously stored, the existing document file is automatically deleted and the new document file is registered as the memo file or job procedure file.
 - (b) Since the existing document file is automatically deleted when a new document file is read, the NC memory always holds only one document file even when document files are read repeatedly.

SECTION 4 MEMO DISPLAY

The image shows a terminal window titled "MacMan" with a menu bar containing "START", "OPERATING", and "MAINTENANCE". Below the menu bar, the text "MACH NAME:MG.NAME" is on the left and "93/07/17 13:32:56" is on the right. The main display area shows "MEMO DISPLAY" on the left, "LINE 1" on the right, and "MESSAGE, TXT" at the bottom right. The message content is as follows:

```
MEETING NOTICE FROM QUALITY MANAGEMENT DEPT..  
TITLE : QUALITY IMPROVEMENT MEETING  
DATE  : July 17, 1993  
TIME  : 13:00  
ROOM  : #503 MEETING ROOM  
  
PLEASE ATTEND THE MEETING.
```

Below the terminal window is a row of eight function keys labeled F1 through F8. The F6 key has "DOC INPUT" written above it and "QUIT" written below it.

4-1. Displaying a Memo File

Scrolling

(1) One line scrolling

If the memo file is large and cannot be displayed in one page, you can scroll the screen line by line by using the "up" and "down" cursor keys.

Note 1: When a memo file is displayed within 14 lines, the screen is not scrolled if you press a cursor key.

Note 2: If the last page of the memo file is displayed on the screen, the screen is not scrolled even if you press the "up" or "down" cursor key.

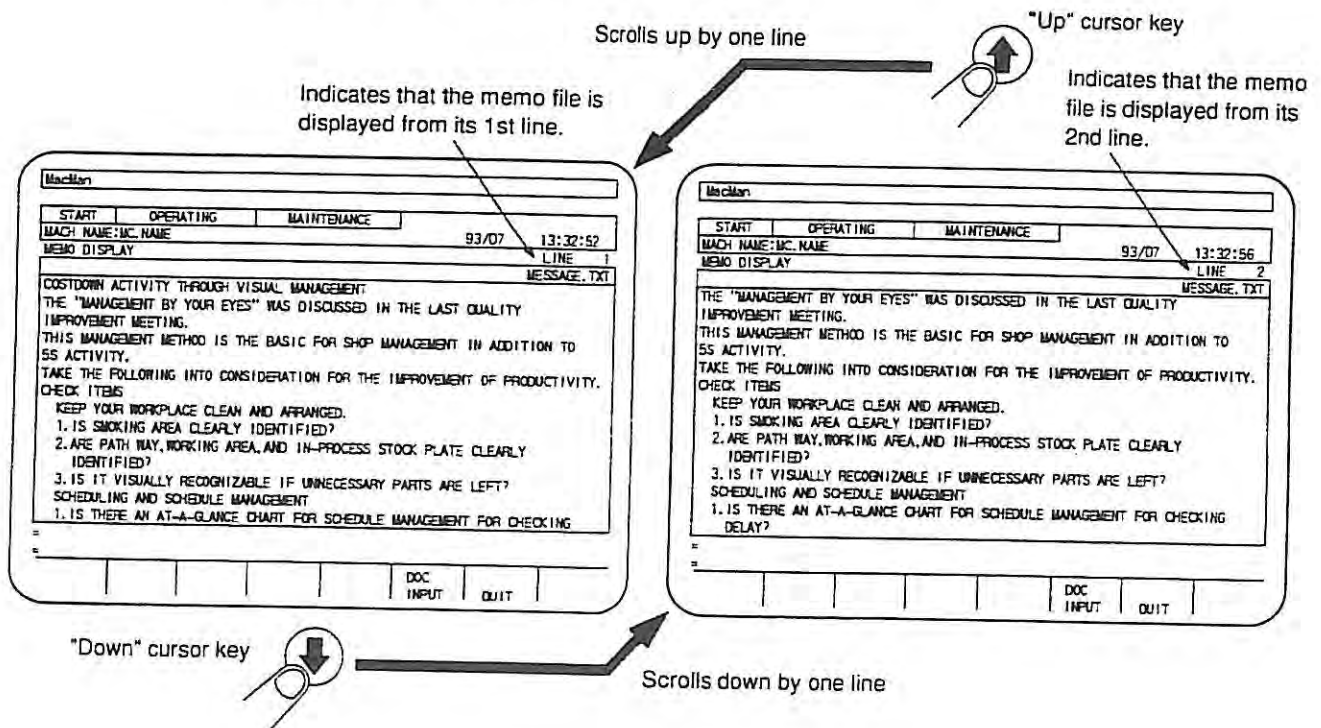

(2) One Page Scrolling

When you use a page key, the screen is scrolled in units of pages.

Note 1: When a memo file is displayed within 14 lines, the screen is not scrolled if you press a page key.

Note 2: If the last page of the memo file is displayed on the screen, the screen is not scrolled even when you press a page key.

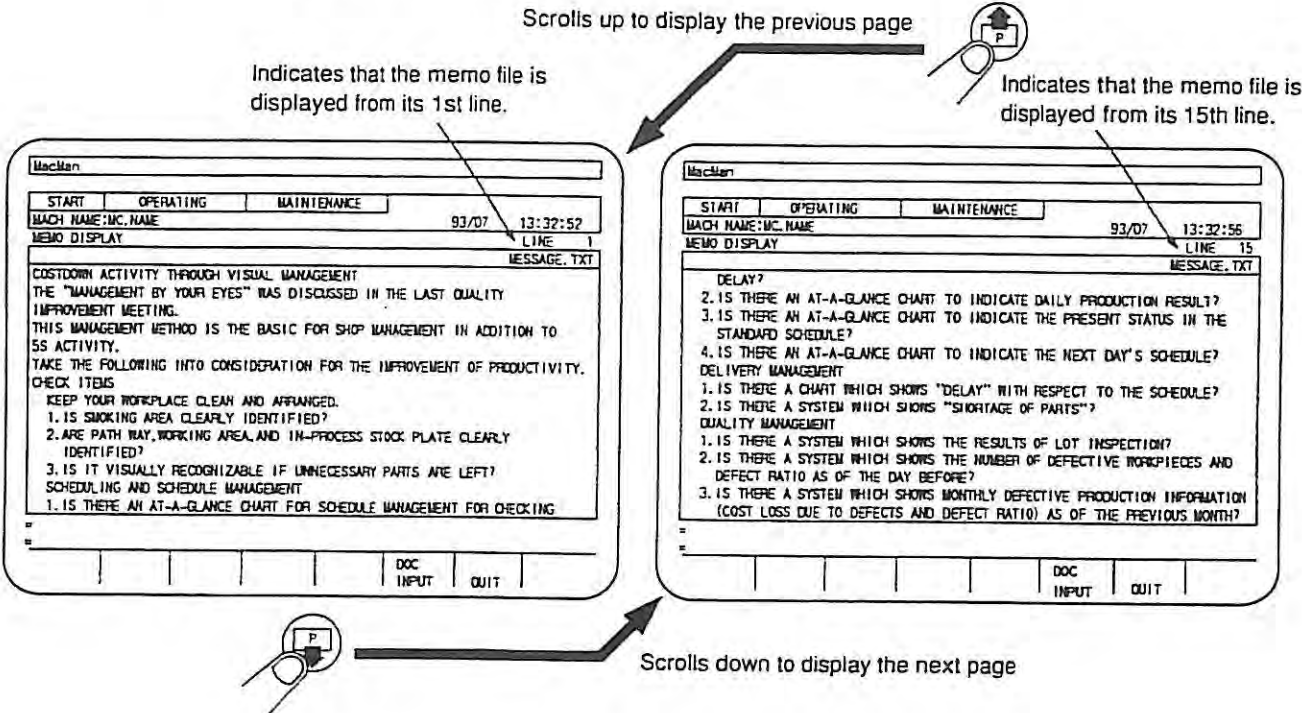

4-2. Reading a Memo File

- (1) Follow the procedure given below to store the memo file, saved in a floppy disk (MS-DOS format, OSP format), to the memory after inserting it to the floppy disk drive.

(MEMO DISPLAY screen)

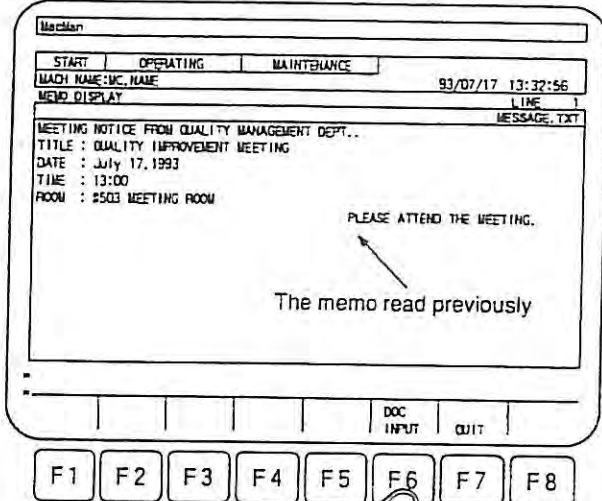

(MEMO DISPLAY screen)

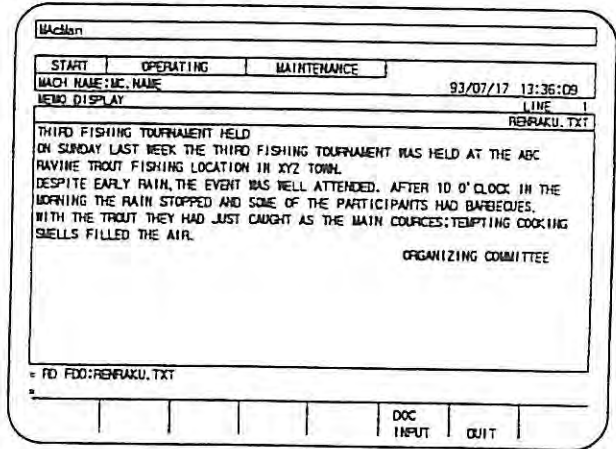

Blinks on and off while a file is being read.

Completion of reading

(COMMAND creation screen)

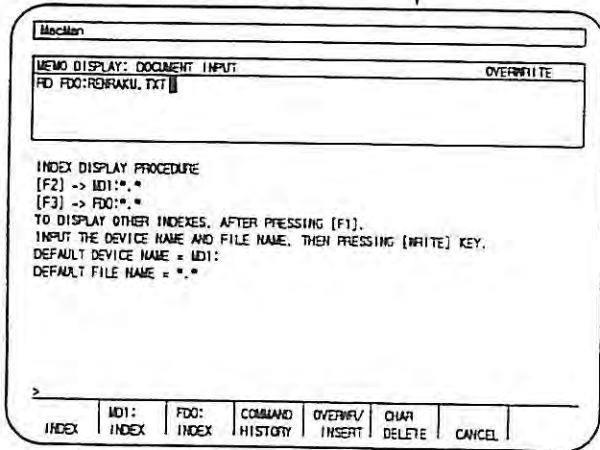

Enter the file name of the text to be read, following prompt "RD".

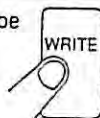

(MEMO DISPLAY screen)

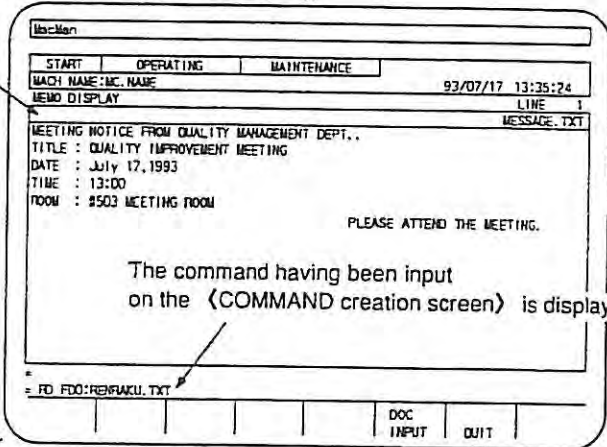

- (2) For the media to input a memo file may be MS-DOS format floppy disk or OSP format floppy disk. The OSP automatically recognizes to which format the floppy disk has been initialized.
- MS-DOS format
Text files created using word processor software can be read.
 - OSP format
Text files created using the OSP or TM-APT can be read.
- (3) Selection of the file to be read can be made by specifying the file following prompt "RD".
- (a) RD [WRITE]
When you press function key [F6] (DOC INPUT), prompt "RD" followed by the file name of the memo currently displayed is displayed.
- (b) RD ABC.TXT [WRITE]
If you press the [WRITE] key without entering a device name, the specified file "ABC.TXT" saved to floppy disk placed in "FD0:" is read.
- Note: If you omit the entry of a device name, the default device is automatically selected. The default device name is set on the INPUT DATA screen of the PREFERENCE SETTINGS function.*
- Before the shipping of the NC, default device setting is for "FD0:". Therefore, if you used "FD0:" to read a file from the floppy disk, it is not necessary to specify the device name.
- (c) RD FD1:ABC.TXT [WRITE]
File "ABC.TXT" is read from device "FD1:".
- (d) RD FD1:
The entry is not allowed. If you specify a device name, you must enter a file name following the device name.
- (e) RD MD1:ABC.TXT
The device which can be used to read a memo file is floppy disk drive only. Therefore, specification of the NC memory as the device to read a memo file is not allowed.
- (4) If you use MS-DOS format floppy disk, path name can be used when specifying a file name.
- (a) RD \ABC.TXT [WRITE]
File "\ABC.TXT" is read from device "FD1:".
- (b) RD FD1:\PATH1\PATH2\ABC.TXT [WRITE]
File "FD1:\PATH1\PATH2\ABC.TXT" is read from device "FD1:".
- Note: Path name cannot be specified when OSP format floppy disk is used.*

- (5) If a path name begins with a back slash code "\", it is recognized as an absolute path. If "\" is not placed at the beginning of a path name, it is recognized as a relative path beneath the default path name.

The default path name is set on the INPUT DATA screen of the PREFERENCE SETTINGS function.

Before the shipping of the NC, default path name is set for "\".

Note: When reading a file just beneath the root directory, it is not necessary to specify a path name.

- (6) How the memo file is read in response to the setting of "\PATH1\" for the default path name:

- (a) RD FD0:ABC.TXT [WRITE]

File "\PATH1\ABC.TXT" is read from device "FD0:".

- (b) RD FD0:\ABC.TXT [WRITE]

File "\ABC.TXT" is read from device "FD0:".

- (c) RD FD1:PATH2\ABC.TXT [WRITE]

File "\PATH1\PATH2\ABC.TXT" is read from "FD1:".

- (d) RD FD1:\PATH2\ABC.TXT [WRITE]

File "\PATH2\ABC.TXT" is read from "FD1:".

- (7) Since a memo file is stored in the NC memory in the same manner as a machining program, the file name must follow the OSP rule.

File name configuration: ** ~ **.***

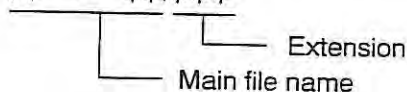

OSP rule:

- A main file name should be within 16 alphanumeric (A to Z, 0 to 9), beginning with an alphabetic letter (A to Z).
- An extension should be within 3 alphanumeric (A to Z, 0 to 9) and is separated from a main file name with a period ".".
- An extension must not be omitted.

4-3. Selecting a File from Directory

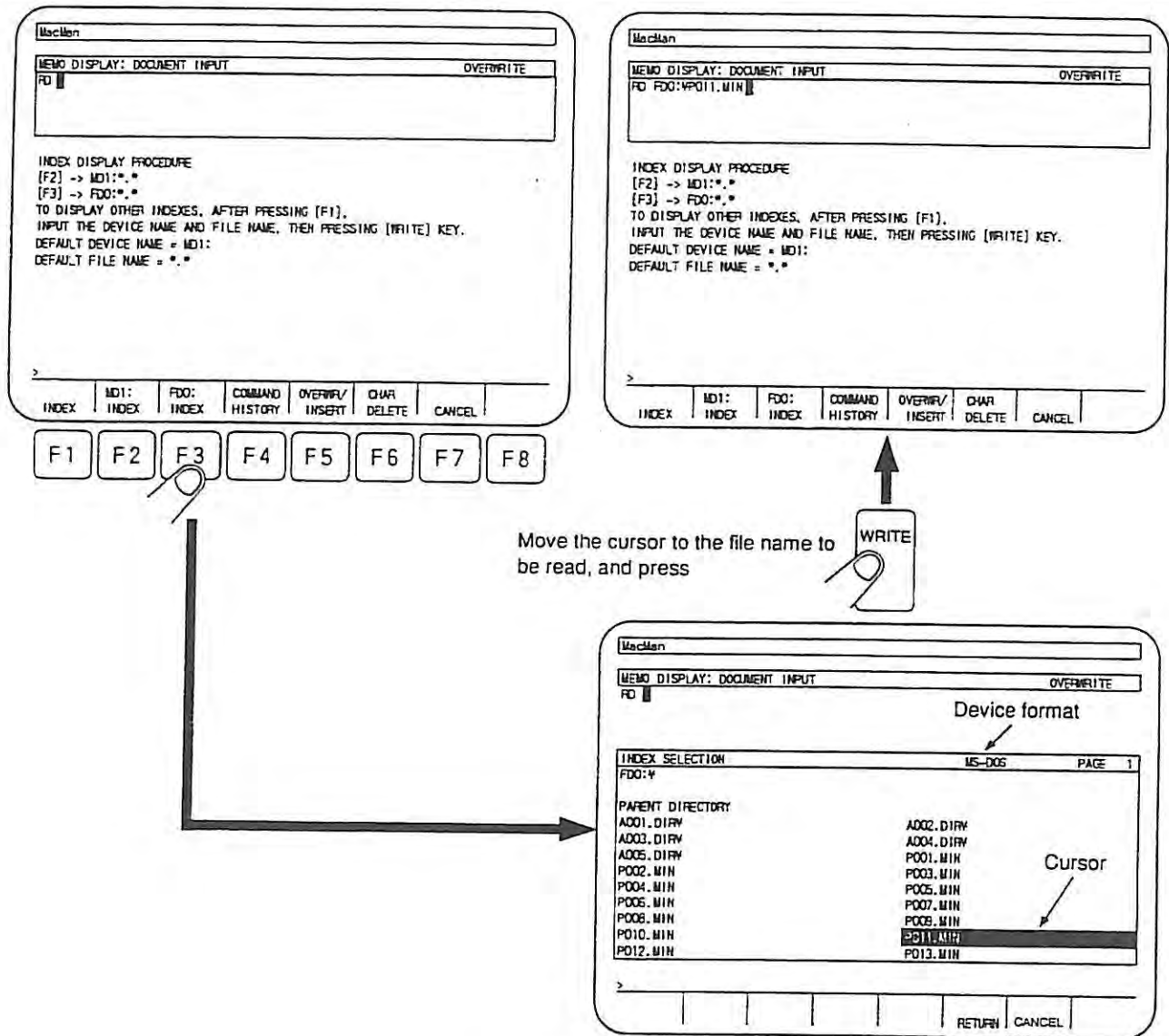

- (1) Directory is displayed by simply pressing function key [F3] (FDO: INDEX).

The directory of the files saved to floppy disk placed in "FDO:" is displayed.

The file names displayed on the screen conform to the default file name, which is set on the INPUT DATA screen of the PREFERENCE SETTINGS function.

If "*.*" is set for the default file name, all file names are displayed. Before shipping of the NC, default file name setting is "*.*".

If "*.TXT" is set for the default file name, file names having extension TXT are displayed.

- (2) When you press function key [F1] (INDEX), prompt ">ISO" appears in the console line. You can enter a device name following this prompt.

(a) ISO [WRITE]

If you press the [WRITE] key without entering a device name, the directory of the files saved to floppy disk placed in "FD0:" is displayed.

Note: If you omit the entry of a device name, the default device is automatically selected. The default device name is set on the INPUT DATA screen of the PREFERENCE SETTINGS function.

Before the shipping of the NC, default device setting is for "FD0:". Therefore, if you use "FD0:" to read a file from the floppy disk, it is not necessary to specify the device name.

(b) ISO FD1: [WRITE]

If you press the [WRITE] key after entering the device name of "FD1:", the directory of the files saved to floppy disk placed in "FD1:" is displayed.

- (3) When you press function key [F1] (INDEX), prompt ">ISO" appears in the console line. You can enter a file name following this prompt.

(a) ISO FD0: [WRITE]

The directory of all files saved to the floppy disk in "FD0:" is displayed.

Note: If you omit the entry of a file name, the default file name is automatically selected. The default file name is set on the INPUT DATA screen of the PREFERENCE SETTINGS function.

Before the shipping of the NC, default file name setting is for "*.*". Therefore, if you want to display the directory of all files, it is not necessary to specify the file name.

(b) ISO FD0:*.TXT [WRITE]

The directory of files having extension ".TXT" is displayed.

(c) ISO FD0:AB*.TXT [WRITE]

The directory of files beginning with AB and having extension ".TXT" is displayed.

(d) ISO FD0:AB??.TXT [WRITE]

The directory of files having four characters of main file name which begins with AB and having extension ".TXT" is displayed.

- (4) When you press function key [F1] (INDEX), prompt ">ISO" appears in the console line. You can enter a path name following this prompt if you are using MS-DOS format floppy disk.

(a) ISO FD0:*.* [WRITE]

The directory beneath the root directory is displayed.

Note: If you omit the entry of a path name, the default file name is automatically selected. The default path name is set on the INPUT DATA screen of the PREFERENCE SETTINGS function.

Before the shipping of the NC, default path name is for "\".

Note: When displaying the directory of files just beneath the root directory, it is not necessary to specify a path name.

(b) ISO FD0:\PATH1*.* [WRITE]

The directory of files beneath the directory "\PATH1\" is displayed.

- (5) If you are using MS-DOS format floppy disk, the screen displays both the directory names and file names.

If you press the [WRITE] key after moving the cursor to "PARENT DIRECTORY", the current directory is changed to the parent directory.

If you press the [WRITE] key after moving the cursor to a directory name (followed by "\" code), the current directory is changed to the selected directory.

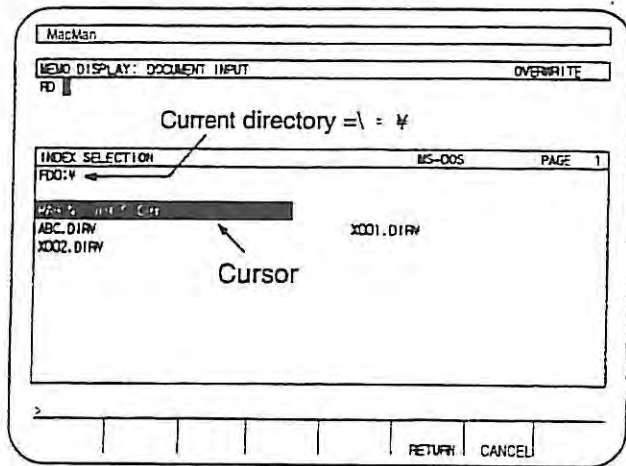

Move the cursor to
"ABC.DIR\'"

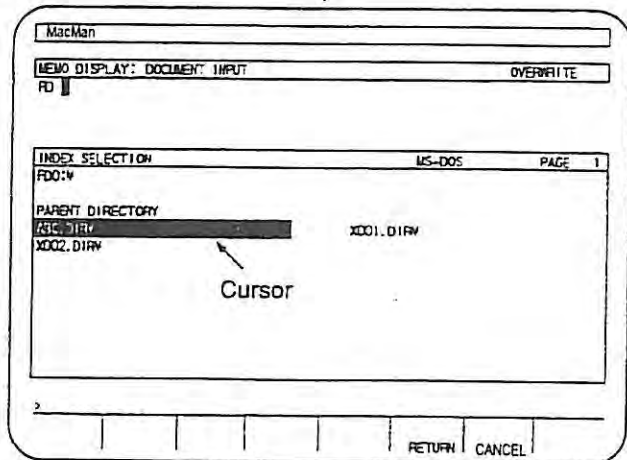

Change directory

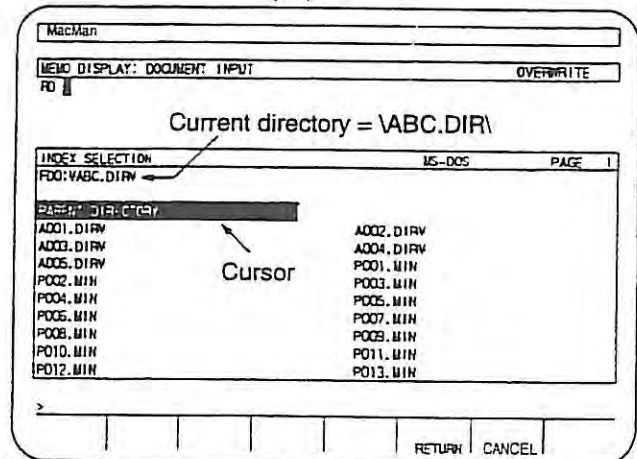

SECTION 5 JOB PROCEDURE DISPLAY

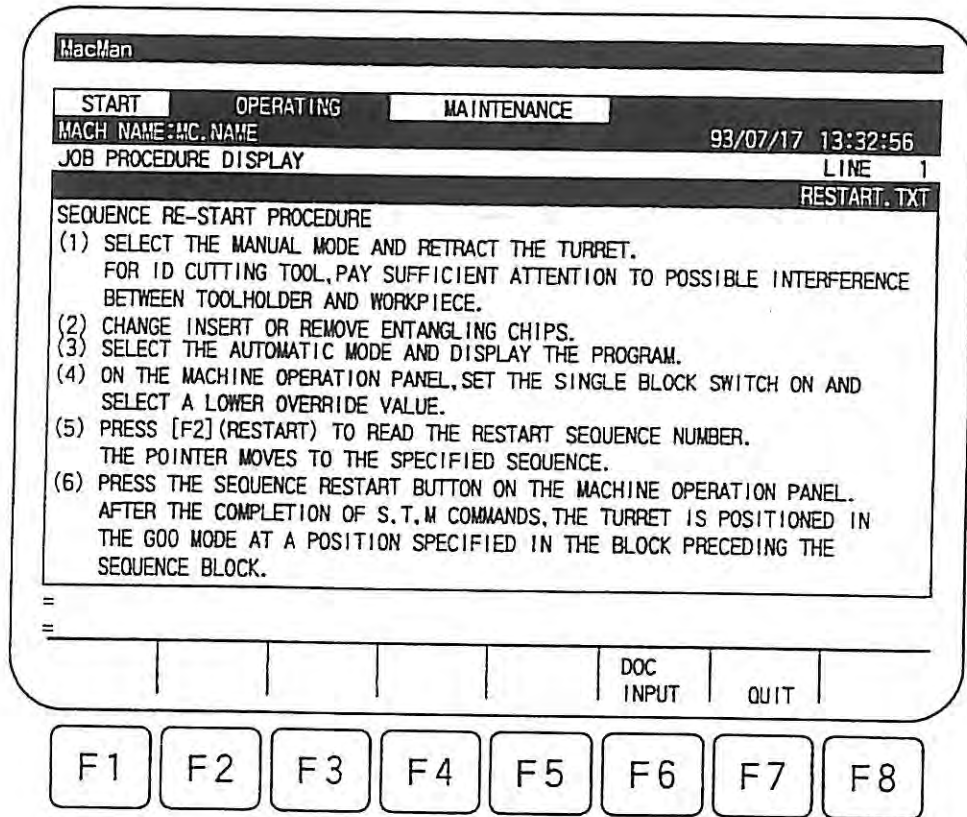

5-1. Display a Job Procedure File

Scrolling:

The display can be scrolled by pressing the cursor keys or page keys. If you use a cursor key, the screen is scrolled line by line, and if you use a page key, the screen is scrolled in units of pages.

For details of scrolling operation, refer to Section 4-1. "Displaying A Memo File".

5-2. Reading a Job Procedure File

Follow the procedure given below to store the job procedure file saved in a floppy disk (MS-DOS format, OSP format) after inserting it to the floppy disk drive.

⟨JOB PROCEDURE DISPLAY screen⟩

⟨JOB PROCEDURE DISPLAY screen⟩

Blinks on and off while a file is being read.

Completion of reading

⟨COMMAND creation screen⟩

⟨JOB PROCEDURE DISPLAY screen⟩

Enter the file name of the text to be read, following prompt "RD".

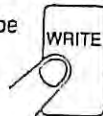

The command having been input on the ⟨COMMAND creation screen⟩ is displayed.

SECTION 6 MACHINING PREPARATION

MacMan							
START	OPERATING	MAINTENANCE					
MACH NAME :MC_NAME		93/07/17 13:32:56					
MACHINING PREPARATION							
OPERATION FILE							
SCHEDULE PROGRAM	SCHEDULE.SDF						
MAIN PROGRAM	PART045-L4392.MIN	OP023					
SUB PROGRAM	PART045.SUB						
PREPARATION FILE		PAGE 1					
PART045-L4392.MIN	PART045-L4393.MIN	PART328-L0032.MIN					
PART004-L0482.MIN	PART003-L4032.MIN	PART114-L0592.MIN					
PART005-L0042.MIN	PART045-L4391.MIN	PART045-L4392.MIN					
PART328-L0031.MIN	PART004-L0481.MIN	PART003-L4031.MIN					
PART114-L0591.MIN							
PROGRAM INPUT QUIT							
F1	F2	F3	F4	F5	F6	F7	F8

6-1. Display of Operation Files and Preparation Files

File name of the schedule program currently selected
 File name and program name of the main program currently selected
 File name of subprogram currently selected

MACHINING PREPARATION		
OPERATION FILE		
SCHEDULE PROGRAM	SCHEDULE. SDF	
MAIN PROGRAM	PART045-L4392. MIN	OP023
SUB PROGRAM	PART045. SUB	
PREPARATION FILE		PAGE 1
PART045-L4392. MIN	PART045-L4393. MIN	PART328-L0032. MIN
PART004-L0482. MIN	PART003-L4032. MIN	PART114-L0592. MIN
PART005-L0042. MIN	PART045-L4391. MIN	PART045-L4392. MIN
PART328-L0031. MIN	PART004-L0481. MIN	PART003-L4031. MIN
PART114-L0591. MIN		

Current page number of list display

List of files stored to the NC memory

One page can contain up to 30 file names. If more than 30 file names are stored to the NC memory, press the page key to display other file names.

The list display changes to the previous page.

Indicates that the first page of the list is displayed.

Indicates that the second page of the list is displayed.

MacMan

START	OPERATING	MAINTENANCE
MACH NAME: MC NAME 93/07/17 13:32:56		
MACHINING PREPARATION		
OPERATION FILE		
SCHEDULE PROGRAM	SCHEDULE. SDF	
MAIN PROGRAM	PART045-L4392. MIN	OP023
SUB PROGRAM	PART045. SUB	
PREPARATION FILE		PAGE 1
PART045-L4392. MIN	PART045-L4393. MIN	PART328-L0032. MIN
PART004-L0482. MIN	PART003-L4032. MIN	PART114-L0592. MIN
PART005-L0042. MIN	PART045-L4391. MIN	PART045-L4392. MIN
PART328-L0031. MIN	PART004-L0481. MIN	PART003-L4031. MIN
PART114-L0591. MIN		
PART456-L0528. MIN	PART196-L2073. MIN	PART058-L7957. MIN
PART037-L0269. MIN	PART196-L3091. MIN	PART058-L7954. MIN
PART292-L7188. MIN	PART037-L0730. MIN	PART001-L0088. MIN
PART719-L0369. MIN	PART038-L0917. MIN	PART004-L3421. MIN
PART563-L3574. MIN	PART073-L0037. MIN	PART223-L6067. MIN
	PART091-L7039. MIN	PART000-L8790. MIN

PROGRAM INPUT QUIT

MacMan

START	OPERATING	MAINTENANCE
MACH NAME: MC NAME 93/07/17 13:32:56		
MACHINING PREPARATION		
OPERATION FILE		
SCHEDULE PROGRAM	SCHEDULE. SDF	
MAIN PROGRAM	PART045-L4392. MIN	OP023
SUB PROGRAM	PART045. SUB	
PREPARATION FILE		PAGE 2
PART041-L4392. MIN	PART085-L4393. MIN	PART308-L0036. MIN
PART003-L0482. MIN	PART403-L4032. MIN	PART154-L0392. MIN
PART002-L0042. MIN	PART245-L4391. MIN	PART245-L3592. MIN
PART324-L0031. MIN	PART044-L0481. MIN	PART053-L7431. MIN
PART117-L0591. MIN		

PROGRAM INPUT QUIT

The list display changes to the next page.

6-2. Reading a Machining Program File

- (1) Follow the procedure given below to store the machining program file saved in a floppy disk (MS-DOS format, OSP format) after inserting it to the floppy disk drive.

(MACHINING PREPARATION screen)

START	OPERATING	MAINTENANCE
MACH NAME: MC NAME		
MACHINING PREPARATION 93/07/17 13:32:56		
OPERATION FILE		
SCHEDULE PROGRAM	SCHEDULE.SDF	
MAIN PROGRAM	PART045-L4392.M1H	OP023
SUB PROGRAM	PART045.SUB	
PREPARATION FILE PAGE 1		
PART045-L4392.M1H	PART045-L4393.M1H	PART328-L0032.M1H
PART004-L0482.M1H	PART003-L4032.M1H	PART114-L0592.M1H
PART005-L0042.M1H	PART045-L4391.M1H	PART045-L4392.M1H
PART328-L0031.M1H	PART004-L0481.M1H	PART003-L4031.M1H
PART114-L0591.M1H		

(MACHINING PREPARATION screen)

File name of the files having been read are displayed.

Blinks on and off while a file is being read.

Completion of reading

(COMMAND creation screen)

INDEX DISPLAY PROCEDURE
[F2] -> MD1:*. *
[F3] -> F00:*. *
TO DISPLAY OTHER INDEXES, AFTER PRESSING [F1].
INPUT THE DEVICE NAME AND FILE NAME, THEN PRESSING [WRITE] KEY.
DEFAULT DEVICE NAME = MD1:
DEFAULT FILE NAME = *. *

(MACHINING PREPARATION screen)

The command having been input on the (COMMAND creation screen) is displayed.

Enter the file name of the text to be read, following prompt "RP".

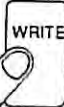

- (2) For the media to input a machining program file may be MS-DOS format floppy disk or OSP format floppy disk. The OSP automatically recognizes to which format the floppy disk has been initialized.
- MS-DOS format
Text files created using word processing software can be read.
 - OSP format
Text files created using the OSP or TM-APT can be read.
- (3) Selection of the file to be read can be made by specifying the file name following prompt "RP".
- (a) RP ABC.TXT [WRITE]
If you press the [WRITE] key without entering a device name, the specified file "ABC.TXT" which is saved to floppy disk placed in "FD0:" is read.
- Note: If you omit the entry of a device name, the default device is automatically selected. The default device name is set on the INPUT DATA screen of the PREFERENCE SETTINGS function.*
- Before the shipping of the NC, default device setting is for "FD0:". Therefore, if you use "FD0:" to read a file from the floppy disk, it is not necessary to specify the device name.
- (b) RP FD1:ABC.TXT [WRITE]
File "ABC.TXT" is read from device "FD1:".
- (c) RP
RP FD0:
This entry is not allowed. You cannot not omit a file name.
- (d) RP MD1:ABC.TXT
The device which can be used to read a machining program file is floppy disk drive only. Therefore, specification of the NC memory as the device to read a machining program file is not allowed.
- (4) If you use MS-DOS format floppy disk, path name can be used when specifying a file name.
- (a) RP \ABC.TXT [WRITE]
File "\ABC.TXT" is read from device "FD0:".
- (b) RP FD1:\PATH1\PATH2\ABC.TXT [WRITE]
File "\PATH1\PATH2\ABC.TXT" is read from device "FD1:".
- Note: Path name cannot be specified when OSP format floppy disk is used.*

- (5) If a path name begins with a back slash code "\", it is recognized as an absolute path. If "\" is not placed at the beginning of a path name, it is recognized as a relative path beneath the default path name.

The default path name is set on the INPUT DATA screen of the PREFERENCE SETTINGS function.

Before the shipping of the NC, default path name is set for "\".

Note: When reading a file just beneath the root directory, it is not necessary to specify a path name.

- (6) How the machining program file is read in response to the setting of "\PATH1\" for the default path name is explained below.

- (a) RP FD0:ABC.TXT [WRITE]

File "\PATH1\ABC.TXT" is read from device "FD0:".

- (b) RP FD0:\ABC.TXT [WRITE]

File "\ABC.TXT" is read from device "FD0:".

- (c) RP FD1:PATH2\ABC.TXT [WRITE]

File "\PATH1\PATH2\ABC.TXT" is read from "FD1:".

- (d) RP FD1:\PATH2\ABC.TXT [WRITE]

File "\PATH2\ABC.TXT" is read from "FD1:".

- (7) Since a machining program file is stored in the NC memory, the file name must follow the OSP rule.

File name configuration: ** ~ **.*

OSP rule:

- A main file name should be within 16 alphanumeric (A to Z, 0 to 9), beginning with an alphabetic letter (A to Z).
- An extension should be within 3 alphanumeric (A to Z, 0 to 9) and is separated from a main file name with a period ".".
- An extension must not be omitted.

- (8) A file name can be selected from the directory.

The procedure to be used for selecting a file from the directory is the same as used for selecting a memo file. For details, refer to Section 4-3. "Selecting A File from Directory".

- (9) To select the main program, having been read using the MACHINING PREPARATION screen, in the automatic operation mode, you do not have to enter the file name. The program can be selected in one-touch operation.

If you select a program without entering a file name, the main program which was read using the MACHINING PREPARATION screen is selected.

Note 1: If program selection is made without entering a file name just after switching ON power to the NC, main program "A.MIN" is selected.

Note 2: To select a program such as a schedule program and a subprogram which is not a main program, a file name must be specified.



Let's start reading of a machining program

MacMan						
START	OPERATING	MAINTENANCE				
MACH. NAME: NC. NAME		93/07/17 13:32:56				
TODAY'S MACHINING REPORT						
MAIN PROGRAM	START DAY	START TIME	NO. OF WORK	OPERATING %		
PART045-L4392.MIN	93/07/17	12:12:09	8	43		
SUB	93/07/17	8:19:23	34	45		
PART045-L4392.MIN OPO23						
TODAY'S OPERATING REPORT						
	H: M: S	(%) OK	25%	50%	75%	100%
RUNNING	4:34:21	100				
OPERATING	3:58:23	53				
CUTTING	2:59:43	24				
NOT OPERATING	1:37:16	41				
IN-PRG SETUP	1:10:10	32				
NO OPERATOR	27:06	15				
PART WAITING	0	0				
MAINTENANCE	0	0				
OTHER	0	0				

F1 F2 F3 F4 F5 F6 F7 F8

Display MACHINING PREPARATION to read a machining program.

MacMan					
START	OPERATING	MAINTENANCE			
MACH. NAME: NC. NAME		93/07/17 13:32:56			
MACH. MAN					
OPERATION FILE					
SCHEDULE PROGRAM	SCHEDULE.SDF				
MAIN PROGRAM	PART045-L4392.MIN	OPO23			
SUB PROGRAM	PART045.SUB				
PREPARATION FILE					
PROGRAM.MIN	PAGE 1				
Completion of reading machining program PROGRAM.MIN has been read.					

F1 F2 F3 F4 F5 F6 F7 F8

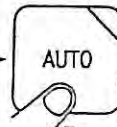

Start of operation
Let's select the program having been read.

AUTO OPERATION						
XA	700.000					
ZA	600.000					
XB	700.000					
ZB	600.000					
PROGRAM SELECT ACTUAL POSIT. PART PROGRAM BLOCK DATA TOOL LAYOUT CHECK DATA [EXTEND]						

F1 F2 F3 F4 F5 F6 F7 F8

AUTO OPERATION	
PROGRAM SELECT	
PS	OVERWRITE
INDEX DISPLAY PROCEDURE	
[F2] -> MD1:*. *	
[F3] -> F00:*. *	
TO DISPLAY OTHER INDEXES, AFTER PRESSING [F1],	
INPUT THE DEVICE NAME AND FILE NAME, THEN PRESSING [WRITE] KEY.	
DEFAULT DEVICE NAME = MD1:	
DEFAULT FILE NAME = *. *	
INDEX MD1: INDEX F00: COMMAND OVERVIEW/ CHAR	
INDEX INDEX INDEX HISTORY INSERT DELETE CANCEL	

Simply press → PROGRAM.MIN is automatically selected.
(File name is not required.)

SECTION 7 REPORT INFORMATION DISPLAY

MacMan

START	OPERATING	MAINTENANCE
MACH NAME:MC.NAME		93/07/17 13:32:56
REPORT INFORMATION		

=

MACHINE REPORT	OPERATE REPORT	OPERATE HISTORY				QUIT	
-------------------	-------------------	--------------------	--	--	--	------	--

F1

F2

F3

F4

F5

F6

F7

F8

- (1) Press function key [F1], [F2], or [F3], and the corresponding machining or operation report screen is displayed.

(a) Machining Report

The report shows the progress of each of the selected main programs.

Program progress report:

Item	Contents
MAIN PROGRAM	The file name of the main program having been selected.
START DAY	Date of the main program selection [year/month/day]
START TIME	Time of the main program selection [hour:minute:second]
NO. OF WORK	The number of times the M02 or M30 command has been executed Execution of the M02 or M30 command in the machine lock mode operation and dry run mode operation (NC lathe) is not counted.
OPERATING %	Percentage of machine operating time in reference to power ON time [%] (Operating % = Machine operating time (OPERATING) / Power ON time (RUNNING))
RUNNING	Length of time for which power supply to the NC has been ON [hours:minutes:seconds] (Length of time for which main program has been selected)
OPERATING	Length of time for which a main program has been executed [hours:minutes:seconds] Length of time the main program has been executed in the machine lock mode or dry run mode (NC lathe) is not counted.
CUTTING	Length of time for which an axis has been moved at a cutting feedrate [hours:minutes:seconds] Length of time an axis has been moved at a cutting feedrate in the machine lock mode or dry run mode (NC lathe) is not counted.
CYCLE TIME	Length of time for which power has been ON for producing one piece of workpiece [hours:minutes:seconds/pc.] (Cycle time = Power on time (RUNNING) / No. of workpieces (NO. OF WORK))
MACHINING	Length of operating time used for producing one piece of workpiece [hours:minutes:seconds/pc.] (Machining time = Operating time (RUNNING) / No. of workpieces (NO. OF WORK))

(b) Operating Report

The report shows the operating status of the machine.

Machine operating report:

Item	Contents
RUNNING	Length of time for which power supply to the NC has been ON [hours:minutes:seconds] (Power ON (RUNNING) = OPERATING + NOT OPERATING)
OPERATING	Length of time for which a main program has been executed Length of time the main program has been executed in the machine lock mode or dry run mode (NC lathe) is not counted. (OPERATING = CUTTING + Not cutting)
CUTTING	Length of time for which an axis has been moved at a cutting feedrate [hours:minutes:seconds] Length of time an axis has been moved at a cutting feedrate in the machine lock mode or dry run mode (NC lathe) is not counted.
NOT OPERATING	Length of time for which a main program has not been executed (NOT OPERATING = IN-PRO SETUP + NO OPERATOR + PART WAITING + MAINTENANCE + OTHER)
IN-PRO SETUP	Constituent of not-operating time: machine has not been operating due to in-process setup.
NO OPERATOR	Constituent of not-operating time: machine has not been operating due to no operator attendance.
PART WAITING	Constituent of not-operating time: machine has not been operating due to waiting for workpiece to be machined.
MAINTENANCE	Constituent of not-operating time: machine has not been operating due to machine maintenance.
OTHER	Constituent of not-operating time: machine has not been operating due to reasons not classified into the items indicated above.
SPINDLE RUN	Length of time for which the spindle has been rotating Length of time the spindle has been rotating in the machine lock mode is not counted.
EXTERNAL INPUT	Length of time for which an external input signal has been ON
ALARM ON	Length of time for which the NC has been in an alarm state (alarm A, alarm B, alarm C)

(c) Operating History

The operating history shows the operating status (ON/OFF) of the machine using the time chart in intervals of 10 minutes.

Machine history:

Item	Contents
RUNNING	Length of time for which power supply to the NC has been ON [hours:minutes:seconds]
OPERATING	Length of time for which a main program has been executed Length of time the main program has been executed in the machine lock mode or dry run mode (NC lathe) is not counted.
CUTTING	Length of time for which an axis has been moved at a cutting feedrate [hours:minutes:seconds] Length of time an axis has been moved at a cutting feedrate in the machine lock mode or dry run mode (NC lathe) is not counted.
NOT OPERATING	Length of time for which a main program has not been executed
IN-PRO SETUP	Constituent of not-operating time: machine has not been operating due to in-process setup.
NO OPERATOR	Constituent of not-operating time: machine has not been operating due to no operator attendance.
PART WAITING	Constituent of not-operating time: machine has not been operating due to waiting for workpiece to be machined.
MAINTENANCE	Constituent of not-operating time: machine has not been operating due to machine maintenance.
OTHER	Constituent of not-operating time: machine has not been operating due to reasons not classified into the items indicated above.
SPINDLE RUN	Length of time for which the spindle has been rotating Length of time the spindle has been rotating in the machine lock mode is not counted.
EXTERNAL INPUT	Length of time for which an external input signal has been ON
ALARM ON	Length of time for which the NC has been in an alarm state (alarm A, alarm B, alarm C)

- (2) You can output the report information to the floppy disk.
- (a) Simply press function key [F6] (DATA OUTPUT), and the report information is output to the floppy disk. The information presently displayed is output. The device name and the file name are set on the OUTPUT DATA screen of the PREFERENCE SETTINGS function. With the setting made at the shipping, date is entered to the file name.
- (b) The report information is output to the MS-DOS format floppy disk.
- 2DD-640/720 KB
 - 2HC-1.20 MB
 - 2HD-1.23 MB
 - 2HD-1.44 MB
- (c) The report information is output in either the text file format or the work sheet file format. The default setting is the text file format.

Text file format : You can analyze the information by using word processor software.

Work sheet file format : You can analyze the information by using data base software.

	English Characters	Other Language
Text file	Alphabetic characters only	Characters displayed on the screen are included
Work sheet file	Alphabetic characters only Lotus 1-2-3 R2	Alphabetic characters only Lotus 1-2-3 R2

- (d) Which of the file format (text file / work sheet file) is used for outputting the report information to the floppy disk is determined by the extension of file name set on the OUTPUT DATA screen of the PREFERENCE SETTINGS function.

File name configuration: ** ~ **.***

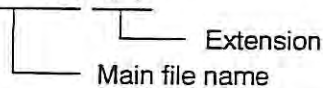

	English Characters	Other Language
Extension = WJ2	Text file	Text file
Extension = WK1	Work sheet file	Work sheet file
Extension ≠ WJ2	Text file	Text file
Extension ≠ WK1		

- (3) You can output the report information to a printer.
- (a) The information output to the floppy disk can be printed using a personal computer. If a printer is connected to the OSP, it is possible to print the report directly from the OSP.
- (b) The characters which are printed are shown in the table below. Use the printer which can print the indicated characters.

	English Characters	Other Language
Machining report	Alphabetic characters only	Alphabetic characters only
Operating report		
Operating history		

- (c) Connect the printer to the RS232C (serial) interface or centronics (parallel) interface. Which of the interfaces should be used is set on the PREFERENCE SETTING screen.
- (d) For printing, the following protocol is used.

ESC/P (EPSON)

SECTION 8 MACHINING REPORT DISPLAY

8-1. Daily Machining Report (Today)

MacMan

START	OPERATING	MAINTENANCE		
MACH NAME:HC. NAME		93/07/17 13:32:56		
DAILY MACHINING REPORT (TODAY)		92/07/17	PAGE	1
MAIN PROGRAM	START DAY	START TIME	NO. OF WORK	OPERATING %
PART045-L4392.MIN	93/07/17	12:12:09	8	43
PART045-L4393.MIN	93/07/17	10:58:54	10	65
PART328-L0032.MIN	93/07/17	9:34:21	12	36
PART004-L0482.MIN	93/07/17	8:19:23	4	52
SUM	93/07/17	8:19:23	34	45
		PART045-L4393.MIN	OP004	

≡
≡

DAILY (TODAY)	DAILY (PRE)	PERIOD	PRINTER OUTPUT	DATA OUTPUT	QUIT
---------------	-------------	--------	----------------	-------------	------

F1

F2

F3

F4

F5

F6

F7

F8

(1) Display Order of the Selected Main Programs

The machining result of the main programs selected today is displayed for each main program in the order the main programs selected later (START TIME).

Note 1: The first line in the first page shows the machining result of the main program presently selected.

Note 2: When the screen is changed to the MACHINING REPORT screen, the DAILY MACHINING REPORT (TODAY) screen is displayed. Date (today) Page No.

DAILY MACHINING REPORT (TODAY)					92/07/17	PAGE	1
MAIN PROGRAM	START DAY	START TIME	NO. OF WORK	OPERATING %			
PART045-L4392. MIN	93/07/17	12:12:09	8	43			
PART045-L4393. MIN	93/07/17	10:58:54	10	65			
PART328-L0032. MIN	93/07/17	9:34:21	12	36			
PART004-L0482. MIN	93/07/17	8:19:23	4	52			
SUM	93/07/17	8:19:23	34	45			
		PART045-L4393. MIN	OP004				

The first main program selection time (today)

Total daily machining result (today)

(2) Scrolling the Display (One Item)

The machining report consists of a main program file name and nine items showing the progress of the main program. Since one line in the display screen is able to show a main program file name and four items, use the "left" and "right" cursor keys to scroll the screen to display the other items. Note that the main program file name stays displayed at the same column even when the display of the items is scrolled.

Display of the report items is shifted left by one item



"Left" cursor key

START	OPERATING	MAINTENANCE					
MACH NAME: MC. NAME		93/07/17 13:32:56					
DAILY MACHINING REPORT (TODAY)		92/07/17 PAGE 1					
MAIN PROGRAM	START DAY	START TIME	NO. OF WORK	OPERATING %			
PART045-L4392. MIN	93/07/17	12:12:09	8	43			
PART045-L4393. MIN	93/07/17	10:58:54	10	65			
PART328-L0032. MIN	93/07/17	9:34:21	12	36			
PART004-L0482. MIN	93/07/17	8:19:23	4	52			
SUM	93/07/17	8:19:23	34	45			
		PART045-L4393. MIN	OP004				

START	OPERATING	MAINTENANCE					
MACH NAME: MC. NAME		93/07/17 13:32:56					
DAILY MACHINING REPORT (TODAY)		92/07/17 PAGE 1					
MAIN PROGRAM	START TIME	NO. OF WORK	OPERATING %	RUNNING			
PART045-L4392. MIN	12:12:09	8	43	1:20:47			
PART045-L4393. MIN	10:58:54	10	65	1:18:15			
PART328-L0032. MIN	9:34:21	12	36	1:24:33			
PART004-L0482. MIN	8:19:23	4	52	1:14:58			
SUM	8:19:23	34	45	5:13:23			
		PART045-L4393. MIN	OP004				

"Right" cursor key

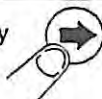

Display of the report items is shifted right by one item

(3) Changing the Machining Report Display Pages

One page of the machining report display page shows the information on 12 main programs. If you have selected more than 12 main programs for a day, press the page key to display the other pages.

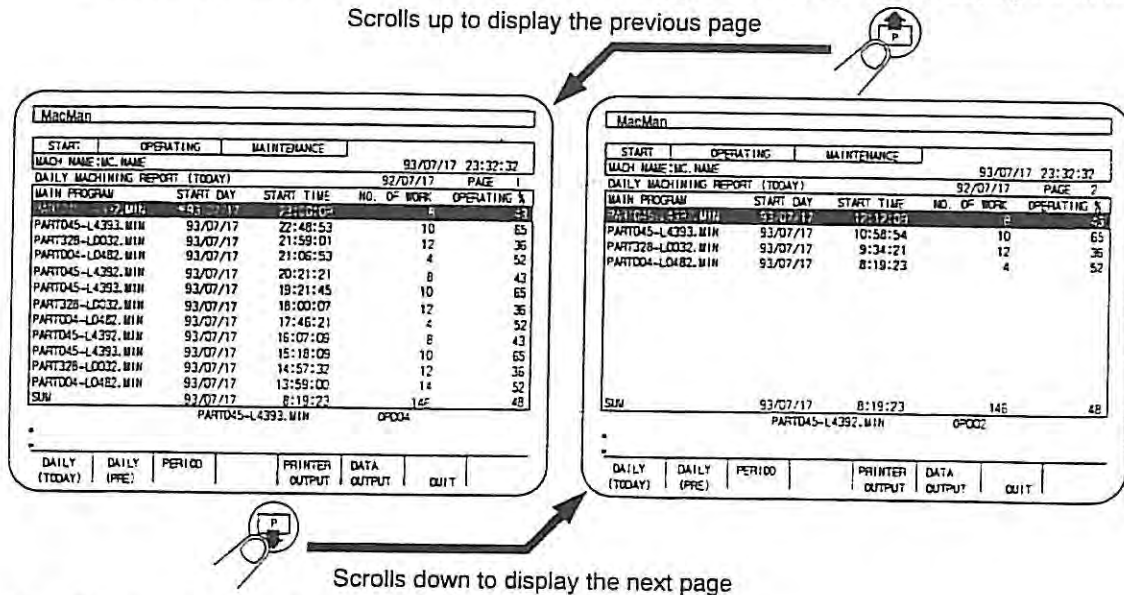

(4) Display of the Main Program File Names

At the MAIN PROGRAM item column on the DAILY MACHINING REPORT (TODAY) screen, the file name of the selected main programs is displayed. In this column, a file name of the first 16 characters can be displayed.

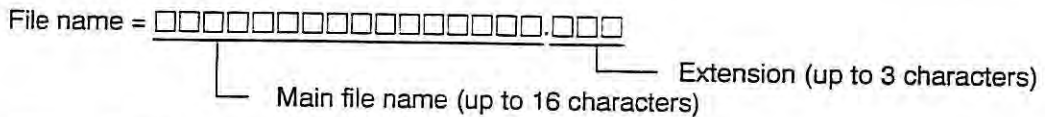

Note: If the file name of the selected main program exceeds 16 characters, see the file name which is displayed below the report display area. In this area, the file name (up to 20 characters) and the program name of the main program indicated by the cursor are displayed.

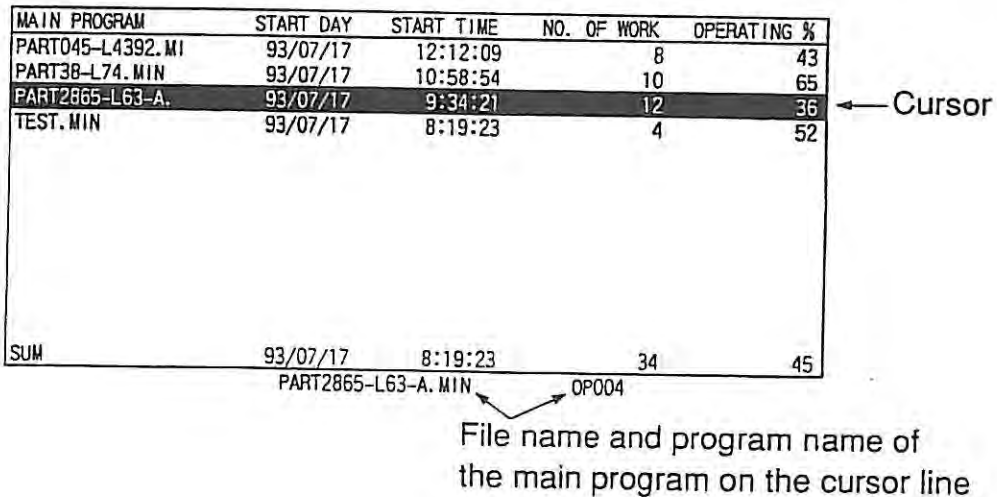

8-2. Daily Machining Report (Pre Day)

MacMan						
START	OPERATING	MAINTENANCE				
MACH NAME:MC. NAME		93/07/17 13:32:56				
DAILY MACHINING REPORT (PRE DAY)				92/07/16	PAGE	1
MAIN PROGRAM	START DAY	START TIME	NO. OF WORK	OPERATING %		
PART003-L4032.MIN	93/07/16	18:31:52	32	43		
PART114-L0592.MIN	93/07/16	15:05:24	42	65		
PART005-L0042.MIN	93/07/16	13:43:04	23	36		
SUM						
	93/07/16	13:43:04	97	45		
	PART114-L0592.MIN		OP231			
=						
=						
DAILY (TODAY)	DAILY (PRE)	PERIOD	PRINTER OUTPUT	DATA OUTPUT	QUIT	
F1	F2	F3	F4	F5	F6	F7
F8						

(1) Display Order of the Selected Main Programs

The machining result of the main programs selected in the previous day is displayed for each main program in the order the main programs selected later (START TIME).

Note 1: The term previous day does not always mean "yesterday". It indicates the last day the NC was operated. If the NC had been stopped for two days, say Saturday and Sunday, and assume that you turned it ON on Monday, the previous day refers to Friday in the last week, or the day three days before today.

Note 2: The functions of the cursor keys and the page keys are the same as those used in the MACHINING REPORT (TODAY) screen.

Date (previous day) Page No.

92/07/16 PAGE 1

DAILY MACHINING REPORT (PRE DAY)				
MAIN PROGRAM	START DAY	START TIME	NO. OF WORK	OPERATING %
PART003-L4032.MIN	93/07/16	18:31:52	32	43
PART114-L0592.MIN	93/07/16	15:05:24	42	65
PART005-L0042.MIN	93/07/16	13:43:04	23	36
The first main program selection time (previous day)				
SUM	93/07/16	13:43:04	97	45
PART114-L0592.MIN OP231				
File name and program name of the main program on the cursor line				

Cursor →

→ Total daily machining result (previous day)

8-3. Period Machining Report

MacMan

START	OPERATING	MAINTENANCE		
MACH NAME: MC. NAME		93/07/17 13:32:56		
PERIOD MACHINING REPORT				PAGE 1
MAIN PROGRAM	START DAY	START TIME	NO. OF WORK	OPERATING %
PART045-L4392. MIN	93/07/17	12:12:09	8	43
PART045-L4393. MIN	93/07/17	10:58:54	10	65
PART328-L0032. MIN	93/07/17	9:34:21	12	36
PART004-L0482. MIN	93/07/17	8:19:23	4	52
PART003-L4032. MIN	93/07/16	18:31:52	32	43
PART114-L0592. MIN	93/07/16	15:05:24	42	65
PART005-L0042. MIN	93/07/16	13:43:04	23	36
PART045-L4391. MIN	93/07/15	15:05:24	12	43
PART045-L4392. MIN	93/07/15	12:12:09	4	65
PART328-L0031. MIN	93/07/15	10:58:54	32	36
PART004-L0481. MIN	93/07/15	9:34:21	42	52
PART003-L4031. MIN	93/07/14	8:19:23	23	43
PART114-L0591. MIN	93/07/14	18:31:52	8	65
PART045-L4393. MIN			OP004	
=				
=				

DAILY (TODAY)	DAILY (PRE)	PERIOD		PRINTER OUTPUT	DATA OUTPUT	QUIT
---------------	-------------	--------	--	----------------	-------------	------

F1

F2

F3

F4

F5

F6

F7

F8

(1) Display Order of the Selected Main Programs

The machining result of the main programs having been selected up to today is displayed for each main program in the order the main programs selected later (START TIME).

Note 1: The first line in the first page shows the machining result of the main program presently selected.

Note 2: One page of the report display shows the machining report of up to 13 main programs. In this report, total information is not given.

Note 3: If the total number of the selected main programs exceeds 13, the report is given on the following pages which are accessible by pressing a cursor key or a page key. The functions of the cursor keys and the page keys are the same as those used in the MACHINING REPORT (TODAY) screen.

Page No. 1

PERIOD MACHINING REPORT					PAGE	1
MAIN PROGRAM	START DAY	START TIME	NO. OF WORK	OPERATING %		
PART045-L4392.MIN	93/07/17	12:12:09	8	43		
PART045-L4393.MIN	93/07/17	10:58:54	10	65		
PART328-L0032.MIN	93/07/17	9:34:21	12	36		
PART004-L0482.MIN	93/07/17	8:19:23	4	52		
PART003-L4032.MIN	93/07/16	18:31:52	32	43		
PART114-L0592.MIN	93/07/16	15:05:24	42	65		
PART005-L0042.MIN	93/07/16	13:43:04	23	36		
PART045-L4391.MIN	93/07/15	15:05:24	12	43		
PART045-L4392.MIN	93/07/15	12:12:09	4	65		
PART328-L0031.MIN	93/07/15	10:58:54	32	36		
PART004-L0481.MIN	93/07/15	9:34:21	42	52		
PART003-L4031.MIN	93/07/14	8:19:23	23	43		
PART114-L0591.MIN	93/07/14	18:31:52	8	65		

PART045-L4393.MIN OP004

File name and program name of the main program on the cursor line

(2) Report Storing Capacity

The period machining report function is able to store the machining result information for up to 91 main programs, including the main program selected presently.

Note 1: If the memory has already stored the machining result information for 91 main programs, selection of a new main program will cause the machining result information of the oldest main program among the stored 91 main programs to be deleted. The machining report of the newly selected main program is created instead.

Note 2: The machining report (today) is created by extracting the machining report of the main programs for which the START DAY is today from the period machining report.

Note 3: The machining report (pre day) is created by extracting the machining report of the main programs for which the START DAY is previous day from the period machining report.

8-4. Outputting the Machining Report to Floppy Disk

You can save the machining report displayed on the screen by outputting it to floppy disk.

(1) Operating Procedure

Insert an MS-DOS format floppy disk to the floppy disk drive. The machining report displayed on the screen is output to the floppy disk.

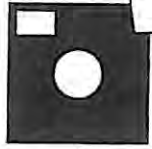
MS-DOS format  Machining report displayed on the screen
(Text file, work sheet file)

Blinks on and off while the report is output.
Data collection is suspended during output.
Data collection restarts after the completion of data output.

START	OPERATING	MAINTENANCE			
MACH NAME:MC NAME		93/07/17 13:32:56			
DAILY MACHINING REPORT (TODAY) 92/07/17 PAGE 1					
MAIN PROGRAM	START DAY	START TIME	NO. OF WORK	OPERATING %	
PART045-L4392.WIN	93/07/17	12:12:09	8	43	
PART045-L4393.WIN	93/07/17	10:58:54	10	65	
PART328-L0032.WIN	93/07/17	9:34:21	12	36	
PART004-L0482.WIN	93/07/17	8:19:23	4	52	
SUM		93/07/17 8:19:23	34	45	
		PART045-L4393.WIN	OP004		
DAILY (TODAY)	DAILY (PRE)	PERIOD	PRINTER OUTPUT	DATA OUTPUT	QUIT

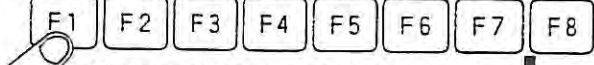

The machining result on the screen is output.
Select the screen displaying the required machining report.

START	OPERATING	MAINTENANCE			
MACH NAME:MC NAME		93/07/17 13:32:56			
DAILY MACHINING REPORT (TODAY) 92/07/17 PAGE 1					
MAIN PROGRAM	START DAY	START TIME	NO. OF WORK	OPERATING %	
PART045-L4392.WIN	93/07/17	12:12:09	8	43	
PART045-L4393.WIN	93/07/17	10:58:54	10	65	
PART328-L0032.WIN	93/07/17	9:34:21	12	36	
PART004-L0482.WIN	93/07/17	8:19:23	4	52	
SUM		93/07/17 8:19:23	34	45	
		PART045-L4393.WIN	OP004		
DAILY (TODAY)	DAILY (PRE)	PERIOD	PRINTER OUTPUT	DATA OUTPUT	QUIT

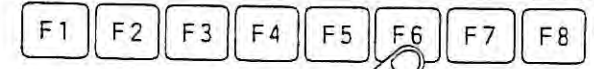

START	OPERATING	MAINTENANCE			
MACH NAME:MC NAME		93/07/17 13:32:56			
DAILY MACHINING REPORT (TODAY) STOP 92/07/17 PAGE 1					
MAIN PROGRAM	START DAY	START TIME	NO. OF WORK	OPERATING %	
PART045-L4392.WIN	93/07/17	12:12:09	8	43	
PART045-L4393.WIN	93/07/17	10:58:54	10	65	
PART328-L0032.WIN	93/07/17	9:34:21	12	36	
PART004-L0482.WIN	93/07/17	8:19:23	4	52	
SUM		93/07/17 8:19:23	34	45	
		PART045-L4393.WIN	OP004		
DAILY (TODAY)	DAILY (PRE)	PERIOD	PRINTER OUTPUT	DATA OUTPUT	QUIT

START	OPERATING	MAINTENANCE			
MACH NAME:MC NAME		93/07/17 13:32:56			
DAILY MACHINING REPORT (TODAY) 92/07/17 PAGE 1					
MAIN PROGRAM	START DAY	START TIME	NO. OF WORK	OPERATING %	
PART045-L4392.WIN	93/07/17	12:12:09	8	43	
PART045-L4393.WIN	93/07/17	10:58:54	10	65	
PART328-L0032.WIN	93/07/17	9:34:21	12	36	
PART004-L0482.WIN	93/07/17	8:19:23	4	52	
SUM		93/07/17 8:19:23	34	45	
		PART045-L4393.WIN	OP004		
DAILY (TODAY)	DAILY (PRE)	PERIOD	PRINTER OUTPUT	DATA OUTPUT	QUIT

After making sure that a floppy disk is set, press [Y] and 

OUTPUT DATA? (Y/N)				
DAILY (TODAY)	DAILY (PRE)	PERIOD		

(2) Output Device and File Name

The machining report displayed on the screen can be output to the floppy disk by simply pressing function key [F6] (DATA OUTPUT). The device name and the file name are set on the OUTPUT DATA screen of the PREFERENCE SETTINGS function.

Note 1: Output device name

The machining report is output to the device set for DEFAULT DEVICE NAME on the PREFERENCE SETTINGS screen. The initial setting for DEFAULT DEVICE NAME is "FD0:". Therefore, to output the machining report to a floppy disk set in the FD0:, you do not have to set the output device name.

Note 2: Output file name

The machining report to be output to the floppy disk is assigned the file name which is set for DEFAULT FILE NAME on the PREFERENCE SETTINGS screen. The initial setting for DEFAULT FILE NAME is:

*DW*Y*M*D.TXT for daily machining report file*

*TW*Y*M*D.TXT for period machining report file.*

If today is April 12, 1993 and the previous day is April 07, 1993, the actual file names to be assigned are:

Daily machining report (today) DW930412.TXT

Daily machining report (pre day) DW930407.TXT

Period machining report TW930412.TXT

(3) Output Format of the Machining Report

If you output the machining report to the floppy disk (MS-DOS format), it is output in either the text file or work sheet file.

Refer to Section 19. "OUTPUT FILES".

- If the report information is output in the text file, it can be displayed or analyzed using word processor software. The default setting is "output in text file".
- If the report information is output in the work sheet file, it can be displayed or analyzed using data base software.

8-5. Outputting the Machining Report to Printer

- (1) The information output to the floppy disk can be printed using a personal computer. If a printer is connected to the OSP, it is possible to print the report directly from the OSP.
- (2) The contents to be printed with the printer connected to the OSP are the same as those printed using the floppy disk saving the machining report in the text file.

Refer to Section 19. "OUTPUT FILES":

Machining report displayed on the screen
Daily machining report (today), in this case

START	OPERATING	MAINTENANCE		
MACH NAME:MC NAME 93/07/17 13:32:56				
DAILY MACHINING REPORT (TODAY) 92/07/17 PAGE 1				
MAIN PROGRAM	START DAY	START TIME	NO. OF WORK	OPERATING %
PART045-L4392.MIN	93/07/17	17:11:09	8	43
PART328-L0032.MIN	93/07/17	9:34:21	12	36
PART004-L0482.MIN	93/07/17	8:19:23	4	52
SUM 93/07/17 8:19:23 34 45				
PART045-L4392.MIN OP004				

Blinks on and off while the report is output.

START	OPERATING	MAINTENANCE		
MACH NAME:MC NAME 93/07/17 13:32:56				
DAILY MACHINING REPORT (TODAY) 92/07/17 PAGE 1				
MAIN PROGRAM	START DAY	START TIME	NO. OF WORK	OPERATING %
PART045-L4392.MIN	93/07/17	12:12:09	8	43
PART328-L0032.MIN	93/07/17	9:34:21	12	36
PART004-L0482.MIN	93/07/17	8:19:23	4	52
SUM 93/07/17 8:19:23 34 45				
PART045-L4392.MIN OP004				

The machining result on the screen is output.
Select the screen displaying the required machining report.

START	OPERATING	MAINTENANCE		
MACH NAME:MC NAME 93/07/17 13:32:56				
DAILY MACHINING REPORT (TODAY) 92/07/17 PAGE 1				
MAIN PROGRAM	START DAY	START TIME	NO. OF WORK	OPERATING %
PART045-L4392.MIN	93/07/17	12:12:09	8	43
PART328-L0032.MIN	93/07/17	9:34:21	12	36
PART004-L0482.MIN	93/07/17	8:19:23	4	52
SUM 93/07/17 8:19:23 34 45				
PART045-L4392.MIN OP004				

After making sure that the printer is ready, press [Y] and

START	OPERATING	MAINTENANCE		
MACH NAME:MC NAME 93/07/17 13:32:56				
DAILY MACHINING REPORT (TODAY) 92/07/17 PAGE 1				
MAIN PROGRAM	START DAY	START TIME	NO. OF WORK	OPERATING %
PART045-L4392.MIN	93/07/17	12:12:09	8	43
PART328-L0032.MIN	93/07/17	9:34:21	12	36
PART004-L0482.MIN	93/07/17	8:19:23	4	52
SUM 93/07/17 8:19:23 34 45				
PART045-L4392.MIN OP004				

PRINT OUT DATA? (Y/N)

WRITE

SECTION 9 OPERATING REPORT

9-1. Daily Operating Report (Daily)

MacMan

START OPERATING MAINTENANCE

MACH NAME: MC. NAME 93/07/17 13:32:56

DAILY OPERATING REPORT (TODAY) 92/07/17

	[H: M: S]	[%]	0%	25%	50%	75%	100%
RUNNING	4:34:21	100					
OPERATING	3:58:23	53					
CUTTING	2:59:43	24					
NOT OPERATING	1:37:16	41					
IN-PRO SETUP	1:10:10	32					
NO OPERATOR	27:06	15					
PART WAITING	0	0					
MAINTENANCE	0	0					
OTHER	0	0					
SPINDLE RUN	2:37:16	48					
EXTRNL INPUT	1:37:16	41					
ALARM ON	0	0					

=

=

DAILY (TODAY)	DAILY (PRE)	PERIOD		PRINTER OUTPUT	DATA OUTPUT	QUIT
---------------	-------------	--------	--	----------------	-------------	------

F1

F2

F3

F4

F5

F6

F7

F8

(1) Today's machine operating report is displayed.

When the screen is changed to the daily operating report screen, the DAILY OPERATING REPORT (TODAY) screen is displayed.

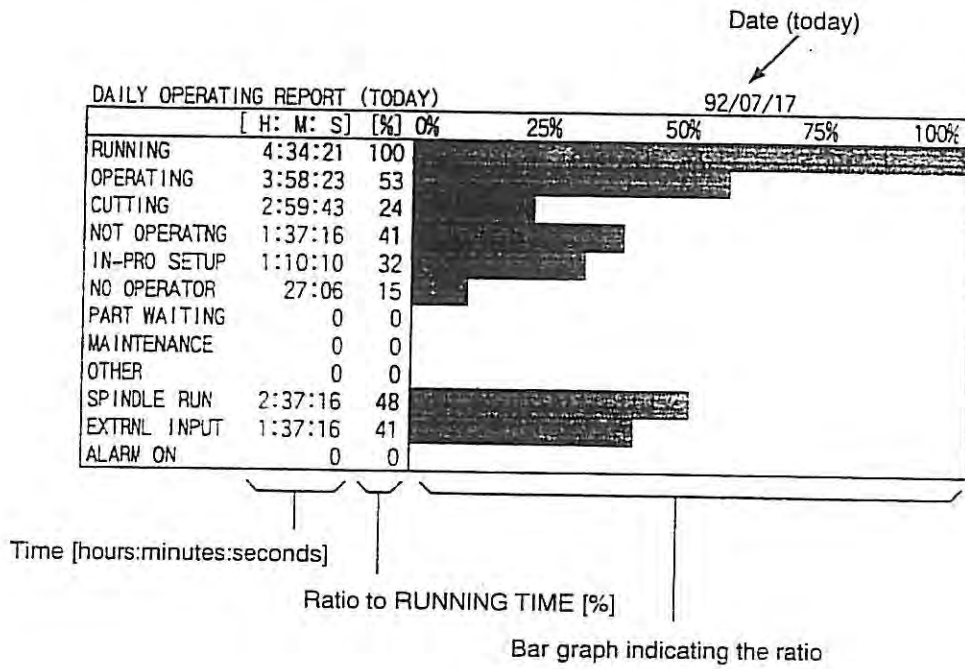

9-2. Daily Operating Report (Pre Day)

MacMan

START	OPERATING	MAINTENANCE
MACH NAME: MC.NAME		93/07/17 13:32:56
DAILY OPERATING REPORT (PRE DAY)		92/07/16
	H: M: S	[%] 0% 25% 50% 75% 100%
RUNNING	4:34:21 100	
OPERATING	3:58:23 53	
CUTTING	2:59:43 24	
NOT OPERATING	1:37:16 41	
IN-PRO SETUP	1:10:10 32	
NO OPERATOR	27:06 15	
PART WAITING	0 0	
MAINTENANCE	0 0	
OTHER	0 0	
SPINDLE RUN	2:37:16 48	
EXTRNL INPUT	1:37:16 41	
ALARM ON	0 0	

=

=

DAILY (TODAY)	DAILY (PRE)		PRINTER OUTPUT	DATA OUTPUT	QUIT
---------------	-------------	--	----------------	-------------	------

F1

F2

F3

F4

F5

F6

F7

F8

(1) The machine operating report of the previous day is displayed.

The term previous day does not always indicate yesterday. If the NC is turned on after it has been stopped for two days, the previous day means the day two days before yesterday.

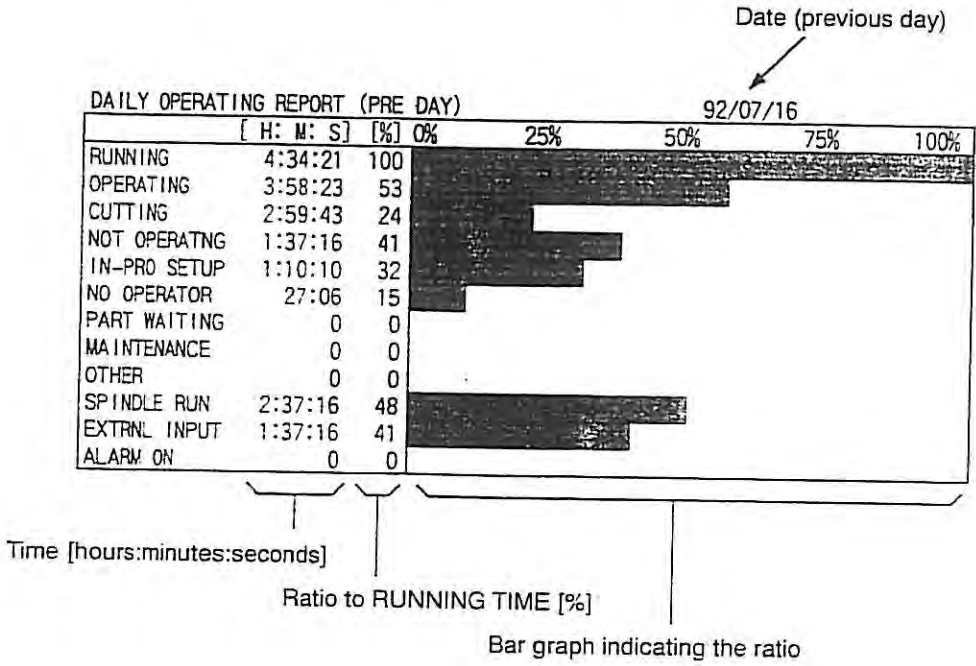

9-3. Period Operating Report (To-Today)

MacMan

START	OPERATING	MAINTENANCE
MACH NAME: MC. NAME		93/07/17 13:32:56
PERIOD OPERATING REPORT (TO-TODAY)		92/07/01
	[H: M] [%]	0% 25% 50% 75% 100%
RUNNING	36:34 100	
OPERATING	27:58 53	
CUTTING	18:59 24	
NOT OPERATING	9:37 41	
IN-PRO SETUP	9:10 32	
NO OPERATOR	4:03 15	
PART WAITING	0 0	
MAINTENANCE	0 0	
OTHER	0 0	
SPINDLE RUN	18:37 48	
EXTRNL INPUT	9:37 41	
ALARM ON	0 0	

=

=

DAILY (TODAY)	DAILY (PRE)	PERIOD		PRINTER OUTPUT	DATA OUTPUT	QUIT
---------------	-------------	--------	--	----------------	-------------	------

F1

F2

F3

F4

F5

F6

F7

F8

(1) The total machine operating report is displayed.

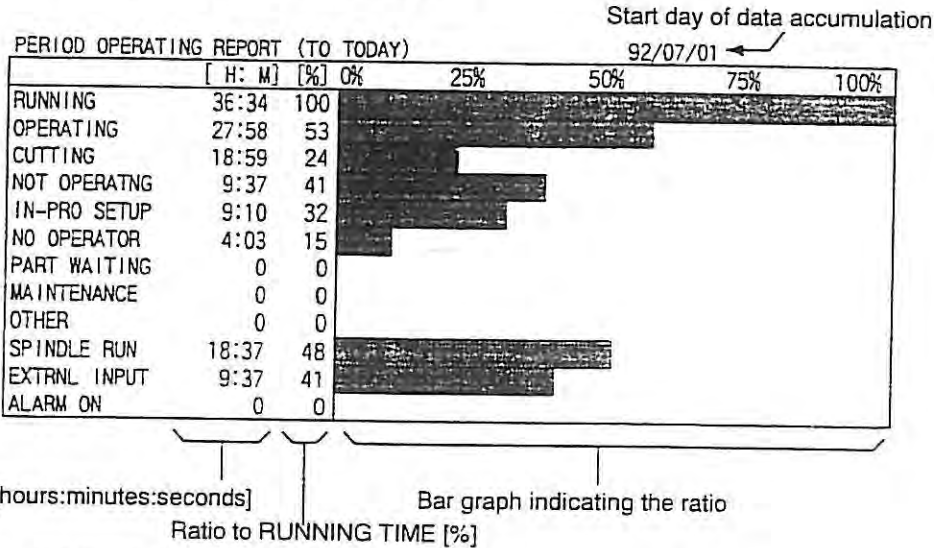

(2) Operating Time in the Period Operating Report

The operating time of each item displayed on the period operating report is the accumulated time from the day the period operating report was cleared last. When the NC is turned on in the same day set as the clear date, the period operating report is cleared and the operating time is accumulated from "0".

Note 1: The period operating report clear date is set for PERIOD OPERATING REPORT CLEAR DATE on the REPORT/PRINTER screen of the PREFERENCE SETTINGS function.

Note 2: The period operating report is cleared at the first power on operation to the NC on the same day as set for the report clear date. The report is not cleared in the succeeding power on operation.

Note 3: Make sure that the date set for PERIOD OPERATING REPORT CLEAR DATE is not a holiday. Unless the NC is turned on in the set report clear date, the period operating report is not cleared.

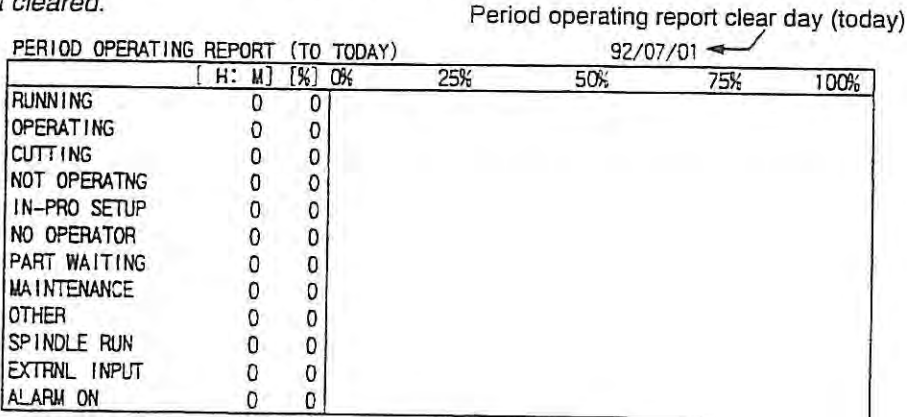

Example: Setting the period operating report clear date

- To use the period operating report as the weekly report, set the date of Monday of the next week (Tuesday, if Monday is holiday) for PERIOD OPERATING REPORT CLEAR DATE.
- To use the period operating report as the monthly report, set the first day of the next month (the second day if the first day is holiday) for PERIOD OPERATING REPORT CLEAR DATE.
- To collect the result of improvements in operation, set the next day on the day when improvement preparation has been finished.

9-4. Outputting the Operating Report to Floppy Disk

You can save the operating report displayed on the screen by outputting it to floppy disk.

(1) Operating Procedure

Insert an MS-DOS format floppy disk to the floppy disk drive and follow the same procedure as explained indicated in Section 8-4. "Outputting the Machining Report to Floppy Disk". The operating report displayed on the screen is output to the floppy disk.

Note: Use an MS-DOS format floppy disk to output the machining report.

(2) Output Device and File Name

The operating report displayed on the screen can be output to the floppy disk by simply pressing function key [F6] (DATA OUTPUT). The device name and the file name are set on the OUTPUT DATA screen of the PREFERENCE SETTINGS function.

Note 1: Output device name

The machining report is output to the device set for DEFAULT DEVICE NAME on the PREFERENCE SETTINGS screen. The initial setting for DEFAULT DEVICE NAME is "FD0:". Therefore, to output the machining report to a floppy disk set in the FD0:, you do not have to set the output device name.

Note 2: Output file name

The machining report to be output to the floppy disk is assigned the file name which set for DEFAULT FILE NAME on the OUTPUT DATA screen of the PREFERENCE SETTINGS function. The initial setting for DEFAULT FILE NAME is:

*DM*Y*M*D.TXT for daily machining report file*

*TM*Y*M*D.TXT for period machining report file.*

If today is April 12, 1993 and the previous day is April 07, 1993, the actual file names to be assigned are:

Daily machining report (today) DM930412.TXT

Daily machining report (pre day) DM930407.TXT

Period machining report TM930412.TXT

(3) Output Format of the Operating Report

If you output the operating report to the floppy disk (MS-DOS format), it is output in either the text file or work sheet file.

Refer to Section 19. "OUTPUT FILES".

- If the report information is output in the text file, it can be displayed or analyzed using word processor software. The default setting is "output in text file".
- If the report information is output in the work sheet file, it can be displayed or analyzed using data base software.

9-5. Outputting the Operating Report to Printer

- (1) The information output to the floppy disk can be printed using a personal computer. If a printer is connected to the OSP, it is possible to print the report directly from the OSP.

The output procedure is the same as outputting the machining report. Refer to Section 8, 8-5. "Outputting the Machining Report to Printer".

- (2) The contents to be printed with the printer connected to the OSP are the same as those printed using the floppy disk saving the machining report in the text file.

Refer to Section 19. "OUTPUT FILES".

SECTION 10 OPERATING HISTORY

10-1. Daily Operating History (Today)

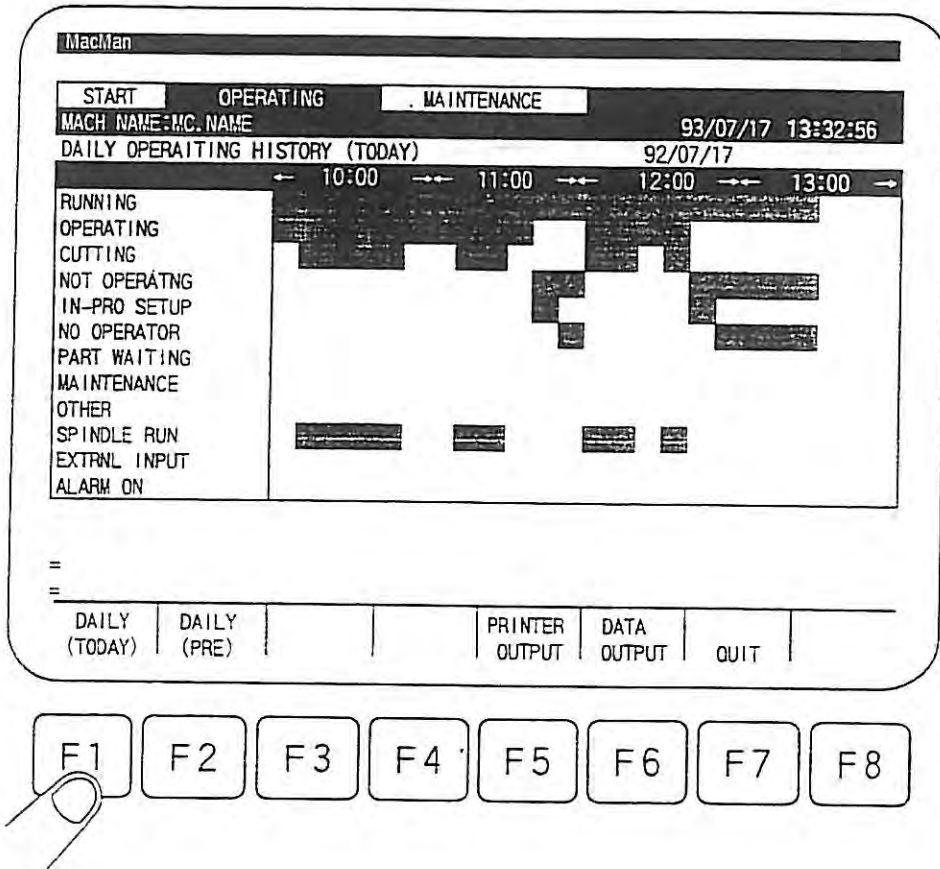

(1) Display

The machine operating status for one day (today) is displayed in time chart.

The operating status of the machine (ON/OFF) is checked in every 10 minutes and the results of the check are displayed on the screen in time chart.

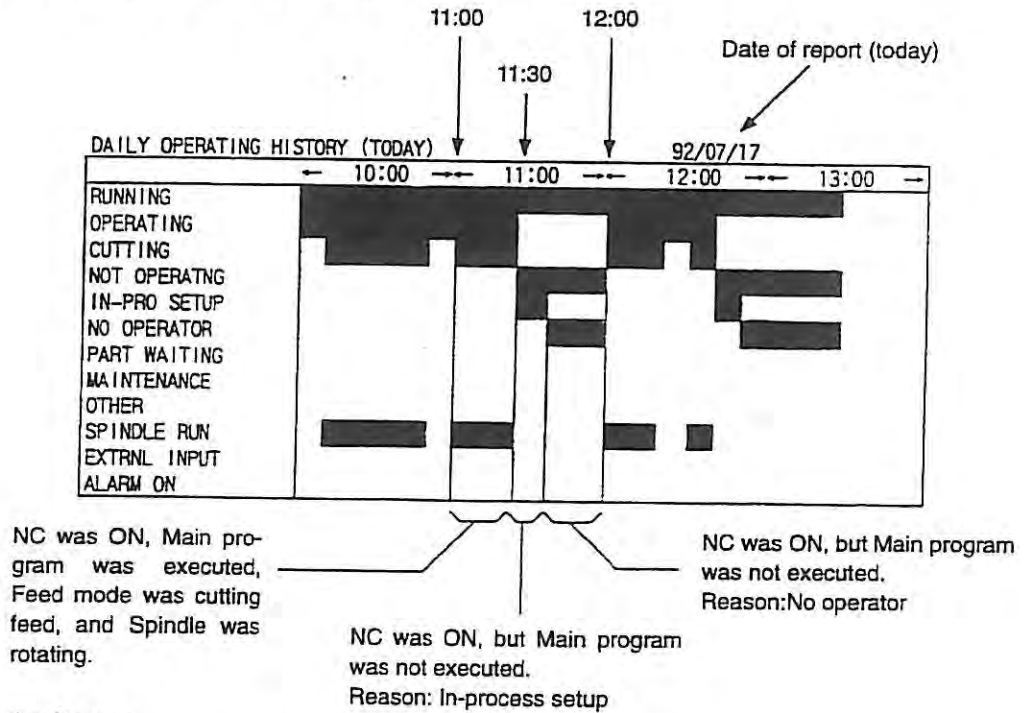

(2) Scrolling the Screen

The operating history for four hours is displayed on the screen. The display can be scrolled to view the history of other operating hours by using the "left" and "right" cursor keys.

The screen scrolls to display the time chart of the previous one hour.

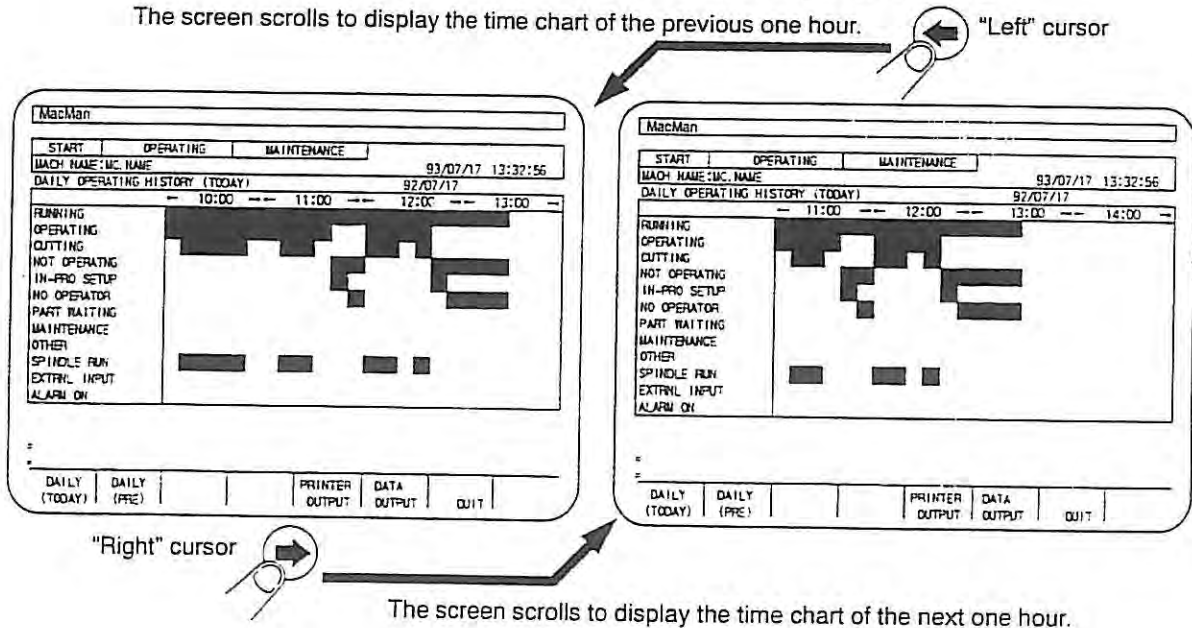

10-2. Daily Operating History (Pre Day)

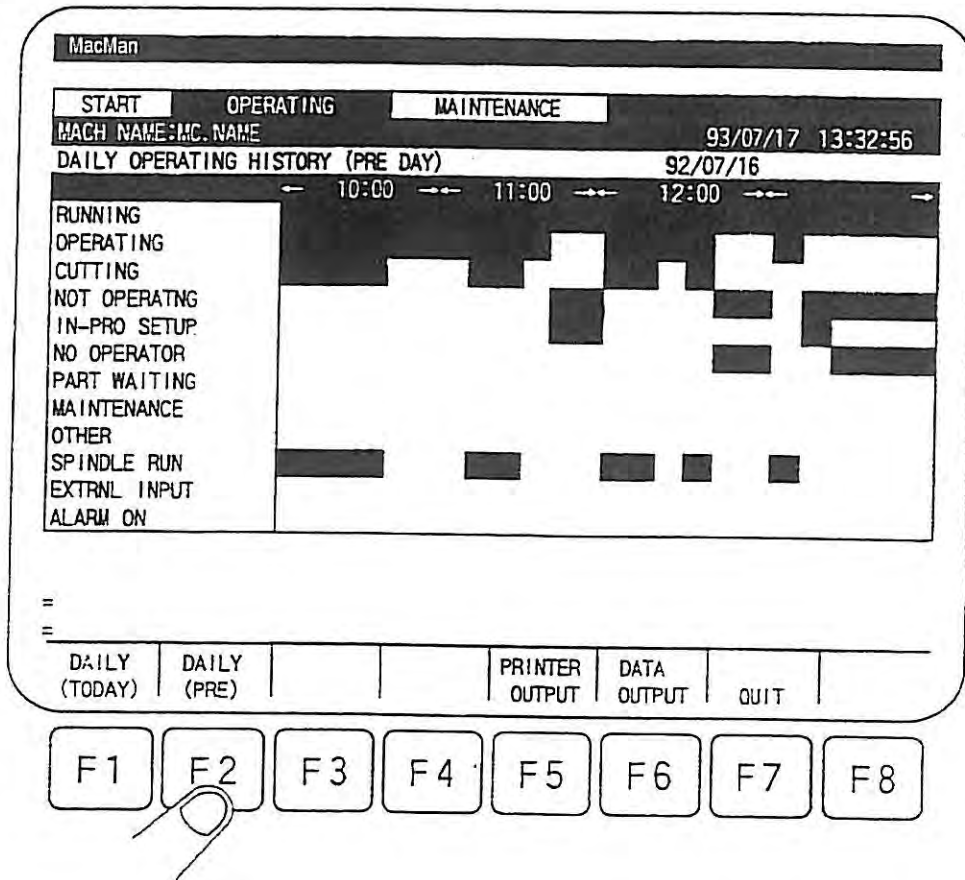

(1) Display

The machine operating status for one day (previous day) is displayed in time chart.

The operating status of the machine (ON/OFF) is checked in every 10 minutes and the results of the check are displayed on the screen in time chart.

Note 1: The term previous day does not always indicate yesterday. If the NC is turned on after it has been stopped for two days, the previous day means the day three days before yesterday.

Note 2: The operating history for four hours is displayed on the screen. The display can be scrolled to view the history of other operating hours by using the "right" and "left" cursor keys.

You can scroll the screen in the same manner as explained in 10-1. "Daily Operating History (Today)".

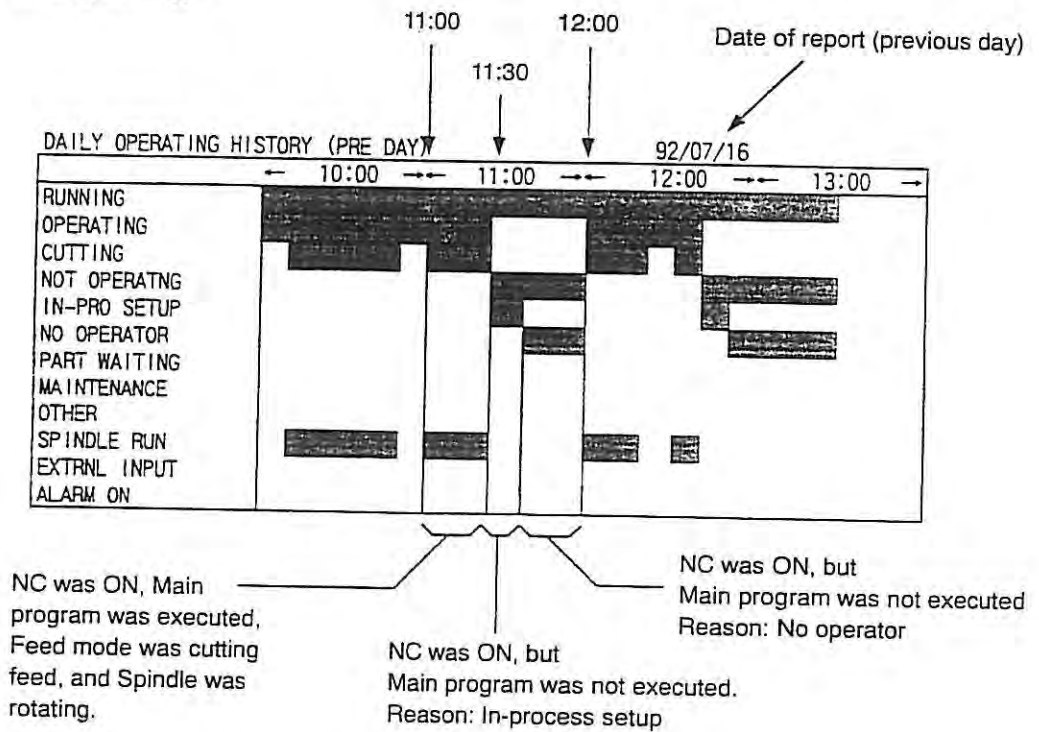

10-3. Outputting the Operating History to Floppy Disk

You can save the operating history displayed on the screen by outputting it to floppy disk.

(1) Operating Procedure

Insert an MS-DOS format floppy disk to the floppy disk drive and follow the same procedure as explained in indicated in Section 8-4. "Outputting the Machining Report to Floppy Disk". The operating history displayed on the screen is output to the floppy disk.

Note: Use an MS-DOS format floppy disk to output the operating history.

(2) Output Device and File Name

The operating report displayed on the screen can be output to the floppy disk by simply pressing function key [F6] (DATA OUTPUT). The device name and the file name are set on the OUTPUT DATA screen of the PREFERENCE SETTINGS function.

Note 1: Output device name

The machining report is output to the device set for DEFAULT DEVICE NAME on the OUTPUT DATA screen of the PREFERENCE SETTINGS function. The initial setting for DEFAULT DEVICE NAME is "FD0:". Therefore, to output the operating history to a floppy disk set in the FD0:, you do not have to set the output device name.

Note 2: Output file name

*The operating history to be output to the floppy disk is assigned the file name which set for DEFAULT FILE NAME on the OUTPUT DATA screen of the PREFERENCE SETTINGS function. The initial setting for DEFAULT FILE NAME is:
DH*Y*M*D.TXT for daily operating history file*

If today is April 12, 1993 and the previous day is April 07, 1993, the actual file names to be assigned are:

Daily operating history (today) DH930412.TXT

Daily operating report (pre day) DH930407.TXT

(3) Output Format of the Operating History

If you output the operating history to the floppy disk (MS-DOS format), it is output in either the text file or work sheet file.

Refer to Section 19. "OUTPUT FILES".

- If the report information is output in the text file, it can be displayed or analyzed using word processor software. The default setting is "output in text file".
- If the report information is output in the work sheet file, it can be displayed or analyzed using data base software.

10-4. Outputting the Operating History to Printer

- (1) The information output to the floppy disk can be printed using a personal computer. If a printer is connected to the OSP, it is possible to print the report directly from the OSP.

The output procedure is the same as outputting the machining report. Refer to Section 8-5. "Outputting the Machining Report to Printer".

- (2) The contents to be printed with the printer connected to the OSP are the same as those printed using the floppy disk saving the machining report in the text file.

Refer to Section 19. "OUTPUT FILES".

SECTION 11 TROUBLESHOOTING INFORMATION

MacMan

START
OPERATING
MAINTENANCE

MACH NAME:MC. NAME
93/07/17 13:32:56

TROUBLESHOOTING INFORMATION

NC AT ALARM	CURRENT NC STAT	ALARM HISTORY	OPERATE HISTORY	VARBLES HISTORY		QUIT
-------------	-----------------	---------------	-----------------	-----------------	--	------

F1

F2

F3

F4

F5

F6

F7

F8

- (1) On the TROUBLESHOOTING INFORMATION screen, press function keys [F1] to [F5] according to the function you want to call. The information which will help you check and troubleshoot the problem is displayed.

- To check the NC status at the time the alarm occurred : NC AT ALARM
- To check the current NC status : CURRENT NC STAT
- To check the alarm occurrence time and nature of alarm : ALARM HISTORY
- To check the alarm occurrence time and type of operation involved : OPERATE HISTORY
- To check the value of a specific variable at a specific time : VARBLES HISTORY

(a) [F1] (NC AT ALARM)

If alarm A occurs, the data such as actual position, zero offset, and limit position are automatically collected. Since the data is collected when an alarm occurs, the collected data represents the "NC status at an occurrence of alarm". In this manual the data is simply referred to as "NC status at alarm" which is displayed as the title of the screen.

Press function key [F1] (NC AT ALARM) and the alarm history is displayed. The "NC status at alarm" is saved to the memory for all the alarms displayed on the screen. You can know the NC status at alarm by printing it or saving it to the floppy disk after selecting the alarm number or alarm code of the alarm which you want to investigate.

(b) [F2] (CURRENT NC STAT)

In response to the pressing of function key [F2] (CURRENT NC STAT), the menu is displayed on the screen. The menu shows the list of the names of the data which can be output to the printer.

Request the data output by selecting the data name from the menu; the selected data is output to the printer or the floppy disk. Since the data are collected after your request is recognized, the collected data represent the "current NC status" and are referred to as the "current NC status".

(c) [F3] (ALARM HISTORY)

The alarm history is displayed on the screen. At each occurrence of an alarm, the data which identify the alarm are logged - date, time, alarm number, alarm code, and alarm character string.

It is possible to output the alarm history to the printer or the floppy disk.

(d) [F4] (OPERATE HISTORY)

Three types of operation history are displayed on the screen, and you can output the history either to the printer or the floppy disk.

1) CONSOLE LINE

The messages which were displayed on the screen.

2) OPERATION PANEL

The NC operation panel keys which were pressed.

3) I/O SIGNALS

The ON/OFF status of the I/O signals

(e) [F5] (VARBLES HISTORY)

Four types of variable history (A, B, C, D) are displayed on the screen. If the setting for a variable is changed, the details of the change are stored to the memory - date and time when the setting was changed, and the new setting.

It is possible to output the variable history to the printer or the floppy disk.

(2) You can output the trouble information to the floppy disk.

(a) Simply press function key [F6] (DATA OUTPUT), and the trouble information is output to the floppy disk. The information presently displayed is output. The device name and the file name are set on the PREFERENCE SETTING screen. With the setting made at the shipping, date is entered to the file name.

(b) The report information is output to the MS-DOS format floppy disk.

- 2DD-640/720 KB
- 2HC-1.20 MB
- 2HD-1.23 MB
- 2HD-1.44 MB

(c) The trouble information is output in the text file format.

You can analyze the information by using word processor software.

	English Characters	Other Language
OPERATIN PANEL	Alphabetic characters only	Characters displayed on the screen are included
I/O SIGNALS		
VARBLES HISTORY		
NC AT ALARM		
CURRENT NC STAT		
ALARM HISTORY		
CONSOLE LINE		

- (3) You can output the trouble information to a printer.
- (a) The information output to the floppy disk can be printed using a personal computer. If a printer is connected to the OSP, it is possible to print the report directly from the OSP.
- (b) The characters which are printed are shown in the table below. Use the printer which can print the indicated characters.

	English Characters	Other Language
OPERATION PANEL	Alphabetic characters only	Alphabetic characters only
I/O SIGNALS		
VARIABLES HISTORY		
NC AT ALARM		Characters displayed on the screen are included
CURRENT NC STAT		
ALARM HISTORY		
CONSOLE LINE		

- (c) Connect the printer to the RS232C (serial) interface or centronics (parallel) interface. Which of the interfaces should be used is set on the PREFERENCE SETTING screen.
- (d) For printing, the following protocol is used.
ESC/P (EPSON)

- (4) The following numbers of data can be collected:

NC AT ALARM:	Up to 5
ALARM HISTORY:	Up to 84
CONSOLE LINE:	Up to 200
OPERATION PANEL:	Up to 200
I/O SIGNALS:	Up to 200
VARIABLES HISTORY (A):	Up to 98
VARIABLES HISTORY (B):	Up to 28
VARIABLES HISTORY (C):	Up to 14
VARIABLES HISTORY (D):	Up to 14

SECTION 12 NC STATUS AT ALARM

MacMan

START OPERATING MAINTENANCE

MACH NAME: NC NAME 93/07/17 13:32:56

NC STATUS AT ALARM PAGE 1

DATE	TIME	ALARM NO.	ALARM CODE	ALARM CHAR STRINGS
93/07/17	10:24:12	422	23	BCID
93/07/12	13:56:32	543		X
93/07/12	8:12:59	901		

PRINTER OUTPUT DATA OUTPUT QUIT

F1 F2 F3 F4 F5 F6 F7 F8

12-1. Selecting the Alarm for Output

- (1) If alarm A occurs, the data such as actual position, zero offset, and limit position are automatically collected. Since the data is collected when an alarm occurs, the collected data represents the "NC status at an occurrence of alarm". In this manual the data is simply referred to as "NC status at alarm" which is displayed as the title of the screen.
- (2) Displaying the NC AT ALARM Screen

Press function key [F1] (NC AT ALARM) and the alarm history is displayed. The "NC status at alarm" has been saved to the memory for all the alarms displayed on the screen.

The "NC status at alarm" which was collected at 10:24:12 in July 13th in 1993

NC STATUS AT ALARM					PAGE	1
DATE	TIME	ALARM NO.	ALARM CODE	ALARM CHAR	STRINGS	Cursor
93/07/17	10:24:12	422	23	BCID		
93/07/12	13:56:32	543		X		
93/07/12	8:12:59	901				

The "NC status at alarm" which was collected at 08:12:59 in July 12th in 1993

The "NC status at alarm" which was collected at 13:56:32 in July 13th in 1993

- (3) Selecting the Alarm

Select the alarm, for which you want to know the NC status, by moving the cursor. The NC status when the selected alarm occurred is output to the printer or the floppy disk.

Note 1: Use the "up" or "down" cursor key to move the cursor up and down.

Note 2: While in alarm state

If the NC is in the alarm state, the first line in the screen indicates the current alarm.

Note 3: Alarm A, B, and C _____

On this screen, the list of only alarm A is displayed. For alarm B and C, no NC data are collected when an alarm occurs.

12-2. Outputting the NC Status at Alarm to Floppy Disk

You can save the NC status at alarm displayed on the screen by outputting it to floppy disk.

(1) Operating Procedure

Insert an MS-DOS format floppy disk to the floppy disk drive and follow the procedure indicated below. The status of the NC when the designated alarm occurred is output to the floppy disk.

Note: Use an MS-DOS format floppy disk to output the NC status at alarm.

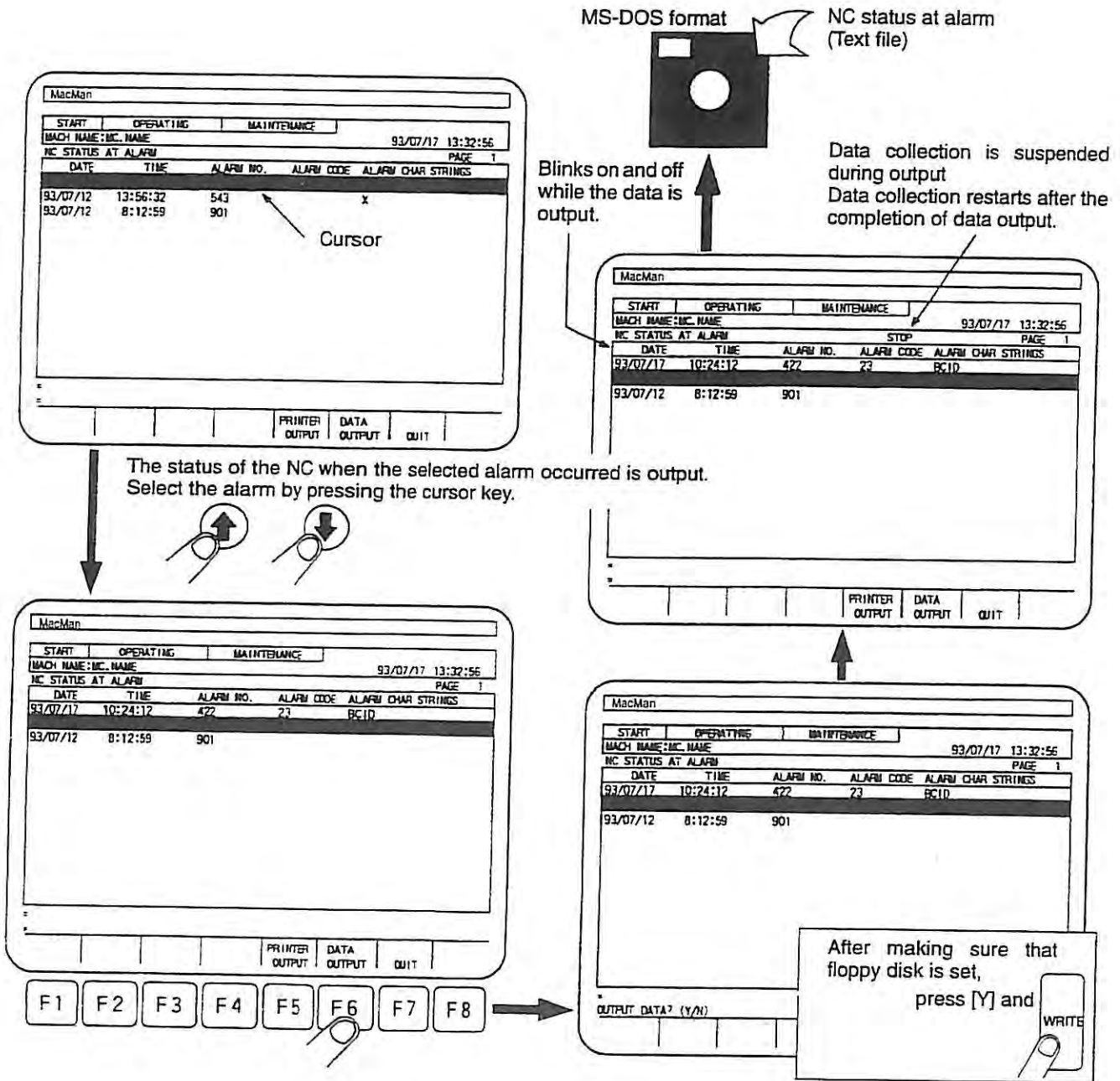

(2) Output Format of the NC Status at Alarm

If you output the NC status at alarm to the floppy disk (MS-DOS format), it is output in the text file. It can be displayed or analyzed using word processor software.

Refer to Section 19. "OUTPUT FILES".

(3) Output Device and File Name

The NC status at alarm can be output to the floppy disk by simply pressing function key [F6] (DATA OUTPUT). The device name and the file name are set on the OUTPUT DATA screen of the PREFERENCE SETTINGS function.

Note 1: Output device name

The NC status at alarm is output to the device set for DEFAULT DEVICE NAME on the PREFERENCE SETTINGS screen. The initial setting for DEFAULT DEVICE NAME is "FD0:". Therefore, to output the NC status at alarm to a floppy disk set in the FD0:, you do not have to set the output device name.

Note 2: Output file name

The NC status at alarm to be output to the floppy disk is assigned the file name which is set for DEFAULT FILE NAME on the PREFERENCE SETTINGS screen. The initial setting for DEFAULT FILE NAME is:

*AN*h*m*s.D*D*

If function key [F6] (DATA OUTPUT) is pressed at 13:30:48 in April 12, 1993, the actual file name to be assigned is:

AN133048.D12

12-3. Outputting the NC Status at Alarm to Printer

- (1) The information output to the floppy disk can be printed using a personal computer. If a printer is connected to the OSP, it is possible to print the report directly from the OSP.
- (2) The contents to be printed with the printer connected to the OSP are the same as those printed using the floppy disk saving the machining report in the text file.

Refer to Section 19. "OUTPUT FILES":

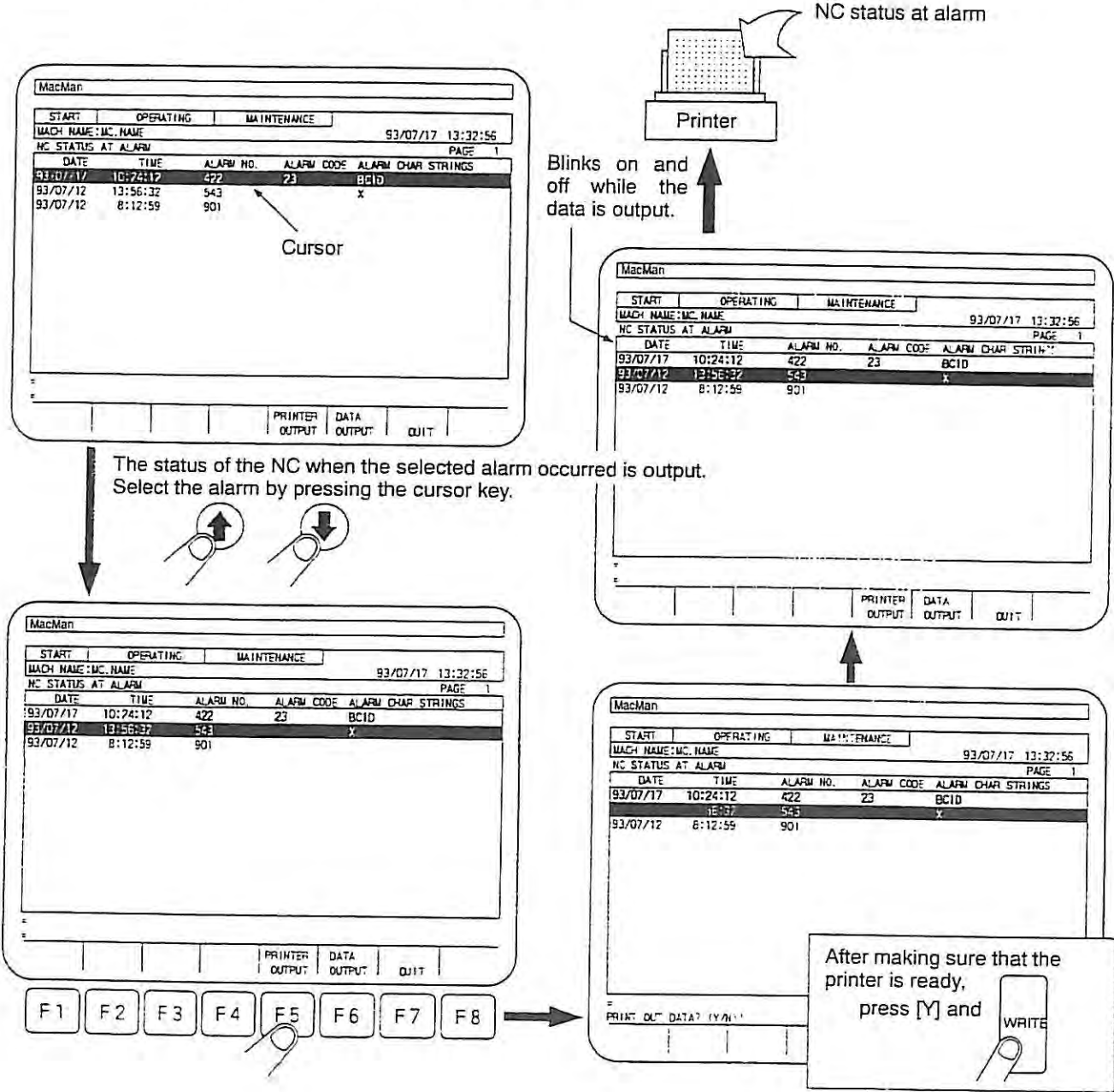

SECTION 13 CURRENT NC STATUS

MacMan

START	OPERATING	MAINTENANCE
-------	-----------	-------------

MACH NAME: MC_NAME 93/07/17 13:32:56
CURRENT NC STATUS PAGE 1

*01000:NC	-NTRT-ALRM	01001:NC	-NTRT-TL IV
01002:NC	-NTRT-CEJM	01003:NC	-NTRT-TLFM
01004:NC	-NTRT-LWS	01005:NC	-NTRT-LW1L
01006:NC	-NTRT-LW2L	01007:NC	-NTRT-MSRS
01008:NC	-NTRT-COMN	01009:NC	-NTRT-OPPL
01010:NC	-NTRT-OPPW	01011:NC	-NTRT-OPPB
01012:NC	-NTRT-MAPS	01013:NC	-NTRT-MSCT
01014:NC	-NTRT-WKCT	01015:NC	-NTRT-NCAT
01016:NC	-NTRT-CCB	*02000:NC	-1TRT-NSPN-ALRM
02001:NC	-1TRT-NSPN-TLOS	02002:NC	-1TRT-NSPN-NOSR
02003:NC	-1TRT-NSPN-TLLF	02004:NC	-1TRT-NSPN-TLLG
02005:NC	-1TRT-NSPN-MGCR	02006:NC	-1TRT-NSPN-TLFG
02007:NC	-1TRT-NSPN-SYSP	02008:NC	-1TRT-NSPN-TRTP
02009:NC	-1TRT-NSPN-TIVP	02010:NC	-1TRT-NSPN-CCBT

=

SELECT/ CANCEL			PRINTER OUTPUT	DATA OUTPUT	QUIT
-------------------	--	--	-------------------	----------------	------





F1 F2 F3 F4 F5 F6 F7 F8

13-1. Selecting the Output Data

When you selected the CURRENT NC STATUS screen, the list of the names of the data which can be output is displayed.

(1) Selecting the Data Name

From the list of data names, selects the name of the data to be output using the cursor keys and function key [F1] (SELECT/CANCEL).

Move the cursor to the required data name by using the cursor key ( ,  ,  , ).

The cursor moves left.

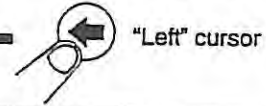

START	OPERATING	MAINTENANCE
MACH NAME: NC NAME 93/07/17 13:32:56		
CURRENT NC STATUS PAGE 1		
*01000:NC -NTRT-ALRM	01001:NC -NTRT-TLIV	
01002:NC -NTRT-CEJM	01003:NC -NTRT-TLPM	
01004:NC -NTRT-LWS	01005:NC -NTRT-LWLL	
01006:NC -NTRT-LXZL	01007:NC -NTRT-MSRS	
01008:NC -NTRT-COMN	01009:NC -NTRT-OPPL	
01010:NC -NTRT-OPPM	01011:NC -NTRT-OPPB	
01012:NC -NTRT-MAPS	01013:NC -NTRT-MSCT	
01014:NC -NTRT-NKCT	01015:NC -NTRT-NCAT	
02000:NC -1TRT-NSPN-ALRM		
02001:NC -1TRT-NSPN-TLOS	02002:NC -1TRT-NSPN-NOSR	
02003:NC -1TRT-NSPN-TLLF	02004:NC -1TRT-NSPN-TLLG	
02005:NC -1TRT-NSPN-MGCR	02006:NC -1TRT-NSPN-TLFG	
02007:NC -1TRT-NSPN-SYSP	02008:NC -1TRT-NSPN-TRTP	
02009:NC -1TRT-NSPN-TIVP	02010:NC -1TRT-NSPN-CCBT	

START	OPERATING	MAINTENANCE
MACH NAME: NC NAME 93/07/17 13:32:56		
CURRENT NC STATUS PAGE 1		
*01000:NC -NTRT-ALRM	01001:NC -NTRT-TLIV	
01002:NC -NTRT-CEJM	01003:NC -NTRT-TLPM	
01004:NC -NTRT-LWS	01005:NC -NTRT-LWLL	
01006:NC -NTRT-LXZL	01007:NC -NTRT-MSRS	
01008:NC -NTRT-COMN	01009:NC -NTRT-OPPL	
01010:NC -NTRT-OPPM	01011:NC -NTRT-OPPB	
01012:NC -NTRT-MAPS	01013:NC -NTRT-MSCT	
01014:NC -NTRT-NKCT	01015:NC -NTRT-NCAT	
01016:NC -NTRT-CCB	02000:NC -1TRT-NSPN-ALRM	
02001:NC -1TRT-NSPN-TLOS	02002:NC -1TRT-NSPN-NOSR	
02003:NC -1TRT-NSPN-TLLF	02004:NC -1TRT-NSPN-TLLG	
02005:NC -1TRT-NSPN-MGCR	02006:NC -1TRT-NSPN-TLFG	
02007:NC -1TRT-NSPN-SYSP	02008:NC -1TRT-NSPN-TRTP	
02009:NC -1TRT-NSPN-TIVP	02010:NC -1TRT-NSPN-CCBT	

The cursor moves down.



"UP" cursor

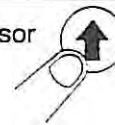

The cursor moves up.

START	OPERATING	MAINTENANCE
MACH NAME: NC NAME 93/07/17 13:32:56		
CURRENT NC STATUS PAGE 1		
*01000:NC -NTRT-ALRM	01001:NC -NTRT-TLIV	
01002:NC -NTRT-CEJM	01003:NC -NTRT-TLPM	
01004:NC -NTRT-LWS	01005:NC -NTRT-LWLL	
01006:NC -NTRT-LXZL	01007:NC -NTRT-MSRS	
01008:NC -NTRT-COMN	01009:NC -NTRT-OPPL	
01010:NC -NTRT-OPPM	01011:NC -NTRT-OPPB	
01012:NC -NTRT-MAPS	01013:NC -NTRT-MSCT	
01014:NC -NTRT-NKCT	01015:NC -NTRT-NCAT	
01016:NC -NTRT-CCB	*02000:NC -1TRT-NSPN-ALRM	
02001:NC -1TRT-NSPN-TLOS	02002:NC -1TRT-NSPN-NOSR	
02003:NC -1TRT-NSPN-TLLF	02004:NC -1TRT-NSPN-TLLG	
02005:NC -1TRT-NSPN-MGCR	02006:NC -1TRT-NSPN-TLFG	
02007:NC -1TRT-NSPN-SYSP	02008:NC -1TRT-NSPN-TRTP	
02009:NC -1TRT-NSPN-TIVP	02010:NC -1TRT-NSPN-CCBT	

START	OPERATING	MAINTENANCE
MACH NAME: NC NAME 93/07/17 13:32:56		
CURRENT NC STATUS PAGE 1		
*01000:NC -NTRT-ALRM	01001:NC -NTRT-TLIV	
01002:NC -NTRT-CEJM	01003:NC -NTRT-TLPM	
01004:NC -NTRT-LWS	01005:NC -NTRT-LWLL	
01006:NC -NTRT-LXZL	01007:NC -NTRT-MSRS	
01008:NC -NTRT-COMN	01009:NC -NTRT-OPPL	
01010:NC -NTRT-OPPM	01011:NC -NTRT-OPPB	
01012:NC -NTRT-MAPS	01013:NC -NTRT-MSCT	
01014:NC -NTRT-NKCT	01015:NC -NTRT-NCAT	
01016:NC -NTRT-CCB	*02000:NC -1TRT-NSPN-ALRM	
02001:NC -1TRT-NSPN-TLOS	02002:NC -1TRT-NSPN-NOSR	
02003:NC -1TRT-NSPN-TLLF	02004:NC -1TRT-NSPN-TLLG	
02005:NC -1TRT-NSPN-MGCR	02006:NC -1TRT-NSPN-TLFG	
02007:NC -1TRT-NSPN-SYSP	02008:NC -1TRT-NSPN-TRTP	
02009:NC -1TRT-NSPN-TIVP	02010:NC -1TRT-NSPN-CCBT	

"Right" cursor



The cursor moves right.

(2) Confirming Your Selection

After moving the cursor to the name of the data to be output, press function key [F1] (SELECT/CANCEL). An asterisk (*) is displayed at the left if the selected data name.

To cancel the selected status of the data, press function key [F1] (SELECT/CANCEL) after moving the cursor on it. When the selection is canceled, the asterisk (*) is deleted.

Canceling the selection ("*" symbol is deleted)

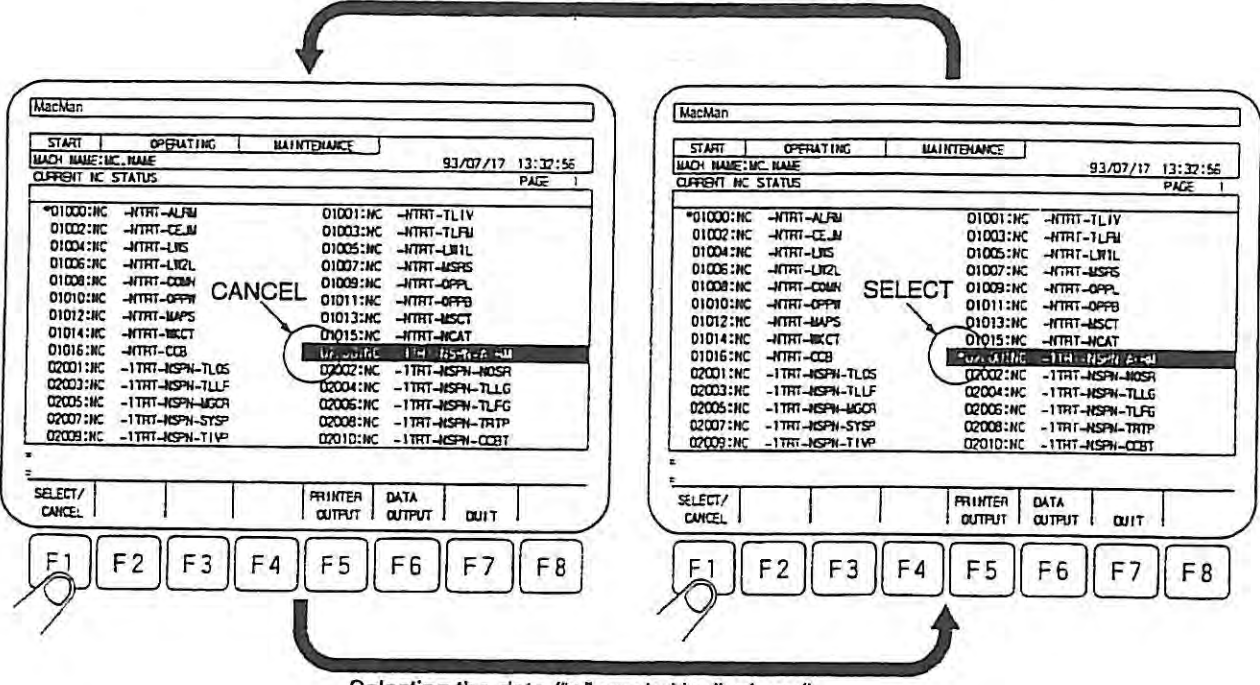

Selecting the data ("*" symbol is displayed)

(3) Changing the Display Pages

A total of 28 data names is displayed in one page. Press the page key to view the other lists by changing the display page.

The page returns to the previous page.

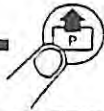

MacMan			
START	OPERATING	MAINTENANCE	
MACH NAME: NC NAME			93/07/17 13:32:56
CURRENT NC STATUS			PAGE 1
01002:NC	-NTRT-CEM	01001:NC	-NTRT-TLIV
01004:NC	-NTRT-LMS	01003:NC	-NTRT-TLPM
01006:NC	-NTRT-LM2L	01005:NC	-NTRT-LM1L
01008:NC	-NTRT-COMH	01007:NC	-NTRT-MSPH
01010:NC	-NTRT-OPPH	01009:NC	-NTRT-OPPL
01012:NC	-NTRT-MAPS	01011:NC	-NTRT-OPPB
01014:NC	-NTRT-MKCT	01013:NC	-NTRT-MJCT
01016:NC	-NTRT-CCB	01015:NC	-NTRT-MCAT
02001:NC	-1TRT-MSPH-TLOS	*02000:NC	-1TRT-MSPH-ALRM
02003:NC	-1TRT-MSPH-TLLF	02002:NC	-1TRT-MSPH-MOSP
02005:NC	-1TRT-MSPH-MGOR	02004:NC	-1TRT-MSPH-TLLG
02007:NC	-1TRT-MSPH-SYSP	02006:NC	-1TRT-MSPH-TLLG
02009:NC	-1TRT-MSPH-TIVP	02008:NC	-1TRT-MSPH-TRTP
02010:NC		02010:NC	-1TRT-MSPH-CCBT

Page No.

MacMan			
START	OPERATING	MAINTENANCE	
MACH NAME: NC NAME			93/07/17 13:32:56
CURRENT NC STATUS			PAGE 2
03001:NC	-1TRT-MSPH-ZERO	03000:NC	-1TRT-MSPH-ALRM
04000:NC	-1TRT-SSPH-ALRM	04001:NC	-1TRT-SSPH-ZERO
04002:NC	-1TRT-SSPH-USFP	05000:NC	-2TRT-MSPH-ALRM
05001:NC	-2TRT-MSPH-TLOS	05002:NC	-2TRT-MSPH-MOSP
05003:NC	-2TRT-MSPH-TLLF	05004:NC	-2TRT-MSPH-TLLG
05005:NC	-2TRT-MSPH-MGOR	05006:NC	-2TRT-MSPH-TLLG
05007:NC	-2TRT-MSPH-SYSP	05008:NC	-2TRT-MSPH-TRTP
05009:NC	-2TRT-MSPH-TIVP	*05010:NC	-2TRT-MSPH-CCBT
05011:NC	-2TRT-MSPH-MOSP	06000:NC	-2TRT-MSPH-ALRM
06001:NC	-2TRT-MSPH-ZERO	06002:NC	-2TRT-MSPH-USFP
07000:NC	-2TRT-SSPH-ALRM	07001:NC	-2TRT-SSPH-ZERO
07002:NC	-2TRT-SSPH-USFP		



The page advances to the next page.

13-2. List of Output Data

The contents of the data are summarized below.

Note: The data actually displayed depends on your machine and NC specifications.

(1) NC Lathes

01000:NC-NTRT-ALRM	Data necessary for troubleshooting the NC
01001:NC-NTRT-TLIV	Tool interference data
01002:NC-NTRT-CEJM	CEJmatic measurement data
01003:NC-NTRT-TLFM	ATC tool geometry data
01004:NC-NTRT-LWS	Load monitoring data - reference data
01005:NC-NTRT-LW1L	Load monitoring data - 1st limit data
01006:NC-NTRT-LW2L	Load monitoring data - 2nd limit data
01007:NC-NTRT-MSRS	Post-process gaging data - RS232C channel
01008:NC-NTRT-COMN	Common variable data
01009:NC-NTRT-OPPL	Optional parameter (long word)
01010:NC-NTRT-OPPW	Optional parameter (word)
01011:NC-NTRT-OPPB	Optional parameter (bit)
01012:NC-NTRT-MAPS	Spindle orientation position parameter data
01013:NC-NTRT-MSCT	Gaging counter data
01014:NC-NTRT-WKCT	NC work counter data
01015:NC-NTRT-NCAT	NC operating time data
01016:NC-NTRT-CCB	Chuck/tailstock barrier data
02000:NC-1TRT-NSPN-ALRM	Data necessary for troubleshooting turret A
02001:NC-1TRT-NSPN-TLOS	Turret A: Tool offset data
02002:NC-1TRT-NSPN-NOSR	Turret A: Nose R offset data
02003:NC-1TRT-NSPN-TLLF	Turret A: Tool life management information table data
02004:NC-1TRT-NSPN-TLLG	Turret A: Tool life management group information table data
02005:NC-1TRT-NSPN-MGCR	Turret A: Post-process gaging automatic offset data
02006:NC-1TRT-NSPN-TLFG	Turret A: Tool geometry data
02007:NC-1TRT-NSPN-SYSP	Turret A: System parameter data
02008:NC-1TRT-NSPN-TRTP	Turret A: Turret position offset data
02009:NC-1TRT-NSPN-TIVP	Turret A: Tool interference parameter data
02010:NC-1TRT-NSPN-CCBT	Turret A: Chuck/tailstock barrier turret data
02011:NC-1TRT-NSPN-HOMP	Turret A: Home position data
03000:NC-1TRT-MSPN-ALRM	Data necessary for troubleshooting turret A spindle
03001:NC-1TRT-MSPN-ZERO	Turret A spindle: Zero point data
03002:NC-1TRT-MSPN-USRP	Turret A spindle: User parameter data
04000:NC-1TRT-SSPN-ALRM	Data necessary for troubleshooting turret A sub-spindle
04001:NC-1TRT-SSPN-ZERO	Turret A sub-spindle: Zero point data
04002:NC-1TRT-SSPN-USRP	Turret A sub-spindle: User parameter data

05000:NC-2TRT-NSPN-ALRM Data necessary for troubleshooting turret B
05001:NC-2TRT-NSPN-TLOS Turret B: Tool offset data
05002:NC-2TRT-NSPN-NOSR Turret B: Nose R offset data
05003:NC-2TRT-NSPN-TLLF Turret B: Tool life management information table data
05004:NC-2TRT-NSPN-TLLG Turret B: Tool life management group information table data
05005:NC-2TRT-NSPN-MGCR Turret B: Post-process gaging automatic offset data
05006:NC-2TRT-NSPN-TLFG Turret B: Tool geometry data
05007:NC-2TRT-NSPN-SYSP Turret B: System parameter data
05008:NC-2TRT-NSPN-TRTP Turret B: Turret position offset data
05009:NC-2TRT-NSPN-TIVP Turret B: Tool interference parameter data
05010:NC-2TRT-NSPN-CCBT Turret B: Chuck/tailstock barrier turret data
05011:NC-2TRT-NSPN-HOMP Turret B: Home position data
06000:NC-2TRT-MSPN-ALRM Data necessary for troubleshooting turret B spindle
06001:NC-2TRT-MSPN-ZERO Turret B spindle: Zero point data
06002:NC-2TRT-MSPN-USRP Turret B spindle: User parameter data
07000:NC-2TRT-SSPN-ALRM Data necessary for troubleshooting turret B sub-spindle
07001:NC-2TRT-SSPN-ZERO Turret B sub-spindle: Zero point data
07002:NC-2TRT-SSPN-USRP Turret B sub-spindle: User parameter data

- (2) Machining Centers
 - 01000:NC-ALRM Data necessary for troubleshooting the NC
 - 01001:NC-ZERO Zero offset data
 - 01002:NC-TLLN Tool length offset data
 - 01003:NC-TLRD Cutter diameter offset data
 - 01004:NC-TLNM Tool management number data
 - 01005:NC-TLDT Tool management data
 - 01006:NC-COMN Common variable data
 - 01007:NC-SYSP System parameter data
 - 01008:NC-HOMP Home position data
 - 01009:NC-USRP User parameter data
 - 01010:NC-SCRP Screw pitch error compensation data
 - 01011:NC-OPPL NC optional parameter (long word)
 - 01012:NC-OPPW NC optional parameter (word)
 - 01013:NC-OPPB NC optional parameter (bit)
 - 11000:EC-ALRM Data necessary for troubleshooting the machine
 - 11001:EC-OPUL Machine user parameter (long word)
 - 11002:EC-OPSL Machine system parameter (long word)
 - 11003:EC-OPUW Machine user parameter (word)
 - 11004:EC-OPSW Machine system parameter (word)
 - 11005:EC-OPUB Machine user parameter (bit)
- (3) Common to NC Lathes and Machining Centers
 - 60001:FN-IODT I/O signal data of Fieldnet

13-3. Outputting the Current NC Status to Floppy Disk

You can save the current NC status displayed on the screen by outputting it to floppy disk.

(1) Operating Procedure

Insert MS-DOS format floppy disk to the floppy disk drive and follow the procedure indicated below. The current status of the NC which is identified by an asterisk (*) is output to the floppy disk.

Since the data to be output are collected in response to the pressing of function key [F6] (DATA OUTPUT), the collected data are called the "current NC status".

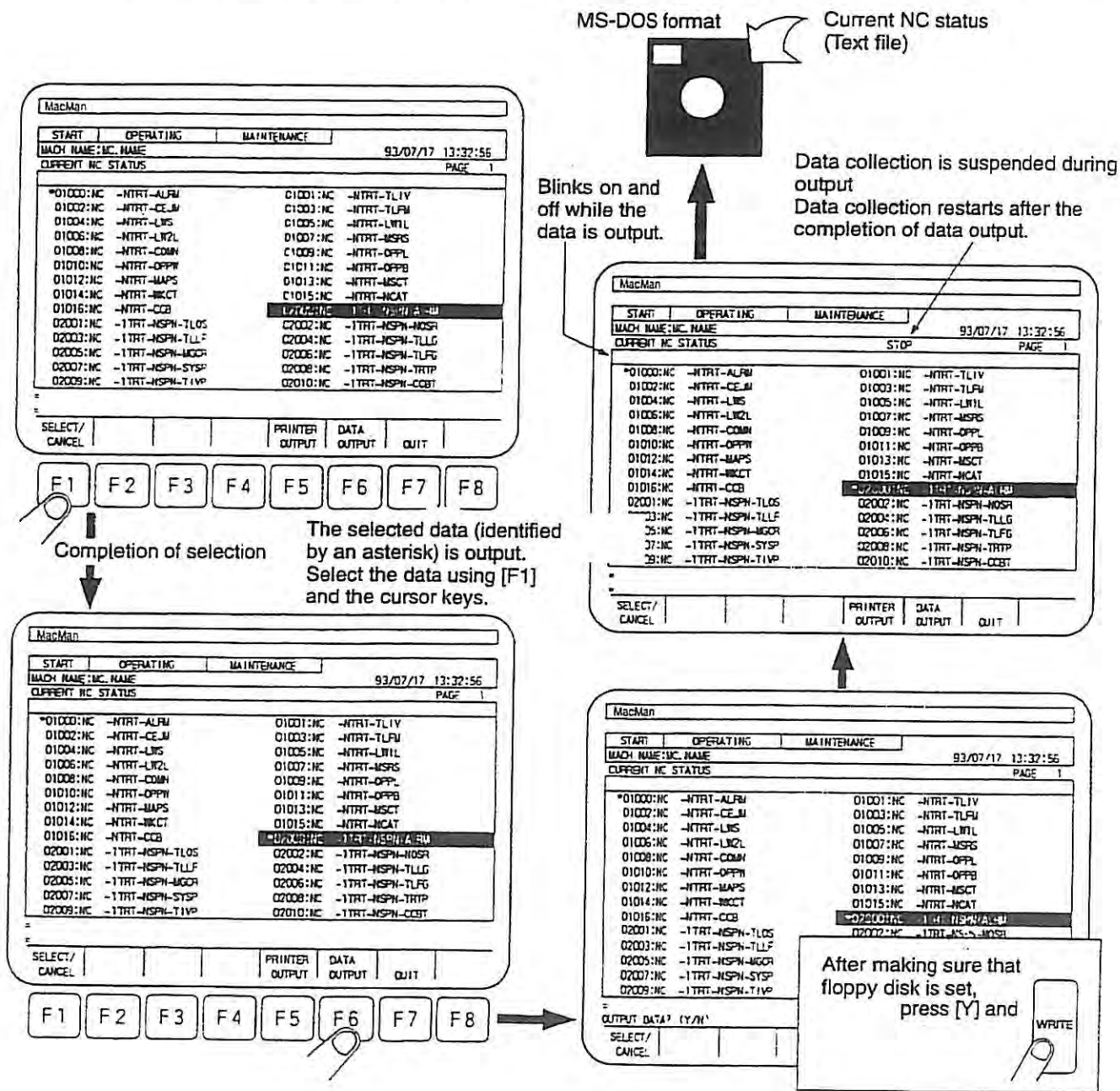

- (2) If you output the current NC Status to the floppy disk (MS-DOS format), it is output in the text file.

It can be displayed or analyzed using word processor software.

Refer to Section 19. "OUTPUT FILES".

- (3) Output Device and File Name

The (current NC) status can be output to the floppy disk by simply pressing function key [F6] (DATA OUTPUT). The device name and the file name are set on the OUTPUT DATA screen of the PREFERENCE SETTINGS function.

Note 1: Output device name

The current NC status is output to the device set for DEFAULT DEVICE NAME on the PREFERENCE SETTINGS screen. The initial setting for DEFAULT DEVICE NAME is "FD0:". Therefore, to output the current NC status to a floppy disk set in the FD0:, you do not have to set the output device name.

Note 2: Output file name

The current NC status to be output to the floppy disk is assigned the file name which is set for DEFAULT FILE NAME on the PREFERENCE SETTINGS screen. The initial setting for DEFAULT FILE NAME is:

*CN*h*m*s.D*D*

If function key [F6] (DATA OUTPUT) is pressed at 13:30:48 in April 12, 1993, the actual file name to be assigned is:

CN133048.D12

- (4) After the completion of output of current NC status (text file), the following message is displayed to ask you whether or not the file necessary for I/O signal analysis should be output.

DATA HAS BEEN OUTPUT.

OUTPUT FILE REQUIRED FOR I/O SIGNAL ANALYSIS?(Y/N)

For the current NC status (only when 60001:FN-IODT is selected), the ON/OFF status of the I/O signals is described in hexadecimal.

This file is necessary to analyze the I/O signals in the same manner as the check data display in automatic operation.

If there is more than one file which is necessary for I/O signal analysis, the following message is displayed for the second and later files.

OUTPUT FILE REQUIRED FOR I/O SIGNAL ANALYSIS?(Y/N)

13-4. Outputting the Current NC Status to Printer

- (1) You can print the current NC status saved to the floppy disk using a personal computer. If you connect a printer directly to the OSP, it is possible to print the data of the item identified by an asterisk (*).

Since the data to be output to the printer are collected in response to the pressing of function key [F5] (PRINTER OUTPUT), the collected data are called the "current NC status".

- (2) The contents to be printed with the printer connected to the OSP are the same as those printed using the floppy disk saving the current NC status in the text file.

Refer to Section 19. "OUTPUT FILES".

Current NC status

START	OPERATING	MAINTENANCE
MACH NAME:MC_NAME 93/07/17 13:32:56		
CURRENT NC STATUS PAGE 1		
*01000:NC -NTRT-ALRM	01001:NC -NTRT-TLIV	
01002:NC -NTRT-CELM	01003:NC -NTRT-TLFW	
01004:NC -NTRT-LNS	01005:NC -NTRT-LNLL	
01006:NC -NTRT-LN2L	01007:NC -NTRT-MSRS	
01008:NC -NTRT-COMN	01009:NC -NTRT-OPPL	
01010:NC -NTRT-OPPN	01011:NC -NTRT-OPPB	
01012:NC -NTRT-MAPS	01013:NC -NTRT-MSCT	
01014:NC -NTRT-MKCT	01015:NC -NTRT-MCAT	
01016:NC -NTRT-CCB	*02003:NC -1TRT-NSPN-TLLF	
02001:NC -1TRT-NSPN-TLOS	02002:NC -1TRT-NSPN-NOSR	
02003:NC -1TRT-NSPN-TLLF	02004:NC -1TRT-NSPN-TLLG	
02005:NC -1TRT-NSPN-MGCR	02006:NC -1TRT-NSPN-TLFG	
02007:NC -1TRT-NSPN-SYSP	02008:NC -1TRT-NSPN-TRTP	
02009:NC -1TRT-NSPN-TIVP	02010:NC -1TRT-NSPN-CCBT	

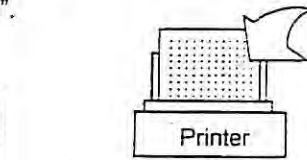

Blinks on and off while the data is output.

START	OPERATING	MAINTENANCE
MACH NAME:MC_NAME 93/07/17 13:32:56		
CURRENT NC STATUS PAGE 1		
*01000:NC -NTRT-ALRM	01001:NC -NTRT-TLIV	
01002:NC -NTRT-CELM	01003:NC -NTRT-TLFW	
01004:NC -NTRT-LNS	01005:NC -NTRT-LNLL	
01006:NC -NTRT-LN2L	01007:NC -NTRT-MSRS	
01008:NC -NTRT-COMN	01009:NC -NTRT-OPPL	
01010:NC -NTRT-OPPN	01011:NC -NTRT-OPPB	
01012:NC -NTRT-MAPS	01013:NC -NTRT-MSCT	
01014:NC -NTRT-MKCT	01015:NC -NTRT-MCAT	
01016:NC -NTRT-CCB	*02003:NC -1TRT-NSPN-TLLF	
02001:NC -1TRT-NSPN-TLOS	02002:NC -1TRT-NSPN-NOSR	
02003:NC -1TRT-NSPN-TLLF	02004:NC -1TRT-NSPN-TLLG	
02005:NC -1TRT-NSPN-MGCR	02006:NC -1TRT-NSPN-TLFG	
02007:NC -1TRT-NSPN-SYSP	02008:NC -1TRT-NSPN-TRTP	
02009:NC -1TRT-NSPN-TIVP	02010:NC -1TRT-NSPN-CCBT	

Completion of selection

The selected data (identified by an asterisk) is output. Select the data using [F1] and the cursor keys.

START	OPERATING	MAINTENANCE
MACH NAME:MC_NAME 93/07/17 13:32:56		
CURRENT NC STATUS PAGE 1		
*01000:NC -NTRT-ALRM	01001:NC -NTRT-TLIV	
01002:NC -NTRT-CELM	01003:NC -NTRT-TLFW	
01004:NC -NTRT-LNS	01005:NC -NTRT-LNLL	
01006:NC -NTRT-LN2L	01007:NC -NTRT-MSRS	
01008:NC -NTRT-COMN	01009:NC -NTRT-OPPL	
01010:NC -NTRT-OPPN	01011:NC -NTRT-OPPB	
01012:NC -NTRT-MAPS	01013:NC -NTRT-MSCT	
01014:NC -NTRT-MKCT	01015:NC -NTRT-MCAT	
01016:NC -NTRT-CCB	*02003:NC -1TRT-NSPN-TLLF	
02001:NC -1TRT-NSPN-TLOS	02002:NC -1TRT-NSPN-NOSR	
02003:NC -1TRT-NSPN-TLLF	02004:NC -1TRT-NSPN-TLLG	
02005:NC -1TRT-NSPN-MGCR	02006:NC -1TRT-NSPN-TLFG	
02007:NC -1TRT-NSPN-SYSP	02008:NC -1TRT-NSPN-TRTP	
02009:NC -1TRT-NSPN-TIVP	02010:NC -1TRT-NSPN-CCBT	

After making sure that the printer is ready, press [M] and

WRITE

START	OPERATING	MAINTENANCE
MACH NAME:MC_NAME 93/07/17 13:32:56		
CURRENT NC STATUS PAGE 1		
*01000:NC -NTRT-ALRM	01001:NC -NTRT-TLIV	
01002:NC -NTRT-CELM	01003:NC -NTRT-TLFW	
01004:NC -NTRT-LNS	01005:NC -NTRT-LNLL	
01006:NC -NTRT-LN2L	01007:NC -NTRT-MSRS	
01008:NC -NTRT-COMN	01009:NC -NTRT-OPPL	
01010:NC -NTRT-OPPN	01011:NC -NTRT-OPPB	
01012:NC -NTRT-MAPS	01013:NC -NTRT-MSCT	
01014:NC -NTRT-MKCT	01015:NC -NTRT-MCAT	
01016:NC -NTRT-CCB	*02003:NC -1TRT-NSPN-TLLF	
02001:NC -1TRT-NSPN-TLOS	02002:NC -1TRT-NSPN-NOSR	
02003:NC -1TRT-NSPN-TLLF	02004:NC -1TRT-NSPN-TLLG	
02005:NC -1TRT-NSPN-MGCR	02006:NC -1TRT-NSPN-TLFG	
02007:NC -1TRT-NSPN-SYSP	02008:NC -1TRT-NSPN-TRTP	
02009:NC -1TRT-NSPN-TIVP	02010:NC -1TRT-NSPN-CCBT	

SECTION 14 ALARM HISTORY

MacMan

START OPERATING MAINTENANCE

MACH NAME:MC. NAME 93/07/17 13:32:56

ALARM HISTORY PAGE 1

DATE	TIME	ALARM NO.	ALARM CODE	ALARM CHAR STRINGS
93/07/17	10:24:12	422	23	BCID
93/07/12	13:56:32	543		X
93/07/12	8:12:59	901		
93/06/28	17:03:05	117-Y	77	
93/06/21	11:12:05	428	6300	
93/06/18	21:13:51	404	63	

=

=

PRINTER OUTPUT DATA OUTPUT QUIT

F1 F2 F3 F4 F5 F6 F7 F8

14-1. Displaying the Alarm History

You can back track the occurrence of alarms.

- (1) At each occurrence of an alarm, the data which identify the alarm are logged and displayed on the screen. The information which identifies individual alarms consists of the date, time, alarm number, alarm code, and alarm character string.
- (2) On the ALARM HISTORY screen, up to 14 sets of alarm information are displayed. To view other alarms which are not displayed on the screen, press the page key.

The display page returns to the previous page.



MacMan					
START	OPERATING	MAINTENANCE			
MACH NAME: MC_NAME 93/09/17 13:32:56					
ALARM HISTORY PAGE 1					
DATE	TIME	ALARM NO.	ALARM CODE	ALARM CHAR STRINGS	
93/08/21	11:12:05	428	6300		
93/08/16	21:13:51	404	63		
93/08/17	10:24:12	422	23	BCID	
93/08/12	13:56:32	543		X	
93/08/12	8:12:59	901			
93/08/06	17:03:05	117-Y	77		
93/08/08	11:12:05	428	6300		
93/08/07	21:13:51	404	63		
93/08/07	10:24:12	422	23	BCID	
93/08/05	13:56:32	543		X	
93/08/05	8:12:59	901			
93/07/30	17:03:05	117-Y	77		
93/07/30	11:12:05	428	6300		
93/07/15	21:13:51	404	63		

Page number

MacMan					
START	OPERATING	MAINTENANCE			
MACH NAME: MC_NAME 93/07/17 13:32:56					
ALARM HISTORY PAGE 2					
DATE	TIME	ALARM NO.	ALARM CODE	ALARM CHAR STRINGS	
93/07/17	10:24:12	422	23	BCID	
93/07/12	13:56:32	543		X	
93/07/12	8:12:59	901			
93/06/28	17:03:05	117-Y	77		
93/06/21	11:12:05	428	6300		
93/06/18	21:13:51	404	63		

Date and time at which the alarm occurred



The display page advances to the next page.

14-2. Outputting the Alarm History to Floppy Disk

You can save the alarm history by outputting it to floppy disk.

(1) Operating Procedure

Insert an MS-DOS format floppy disk to the floppy disk drive and follow the procedure indicated below.

The alarm history is output to the floppy disk by simply pressing function key [F6] (DATA OUTPUT).

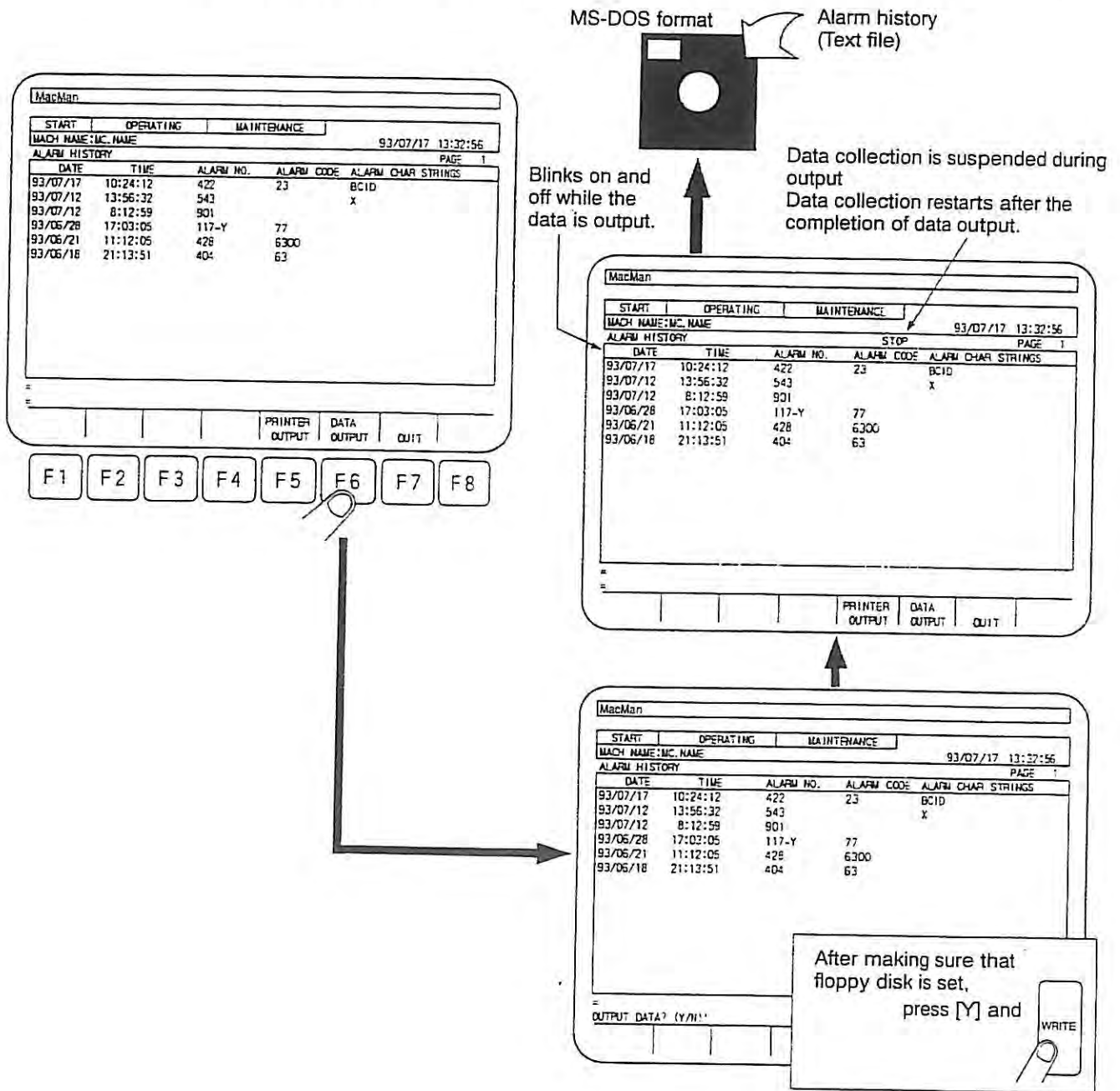

(2) Output Format of the Alarm History

If you output the machining report to the floppy disk (MS-DOS format), it is output in the text file.

It can be displayed or analyzed using word processor software.

Refer to Section 19. "OUTPUT FILES".

(3) Output Device and File Name

The alarm history can be output to the floppy disk by simply pressing function key [F6] (DATA OUTPUT). The device name and the file name are set on the OUTPUT DATA screen of the PREFERENCE SETTINGS function.

Note 1: Output device name

The alarm history is output to the device set for DEFAULT DEVICE NAME on the PREFERENCE SETTINGS screen. The initial setting for DEFAULT DEVICE NAME is "FD0:". Therefore, to output the alarm history to a floppy disk set in the FD0:, you do not have to set the output device name.

Note 2: Output file name

The alarm history to be output to the floppy disk is assigned the file name which is set for DEFAULT FILE NAME on the PREFERENCE SETTINGS screen. The initial setting for DEFAULT FILE NAME is:

*AL*h*m*s.D*D*

If function key [F6] (DATA OUTPUT) is pressed at 13:30:48 in April 12, 1993, the actual file name to be assigned is:

AL133048.D12

14-3. Outputting the Alarm History to Printer

- (1) The information output to the floppy disk can be printed using a personal computer. If a printer is connected to the OSP, it is possible to print the report directly from the OSP.
- (2) The contents to be printed with the printer connected to the OSP are the same as those printed using the floppy disk saving the machining report in the text file.

Refer to Section 19. "OUTPUT FILES".

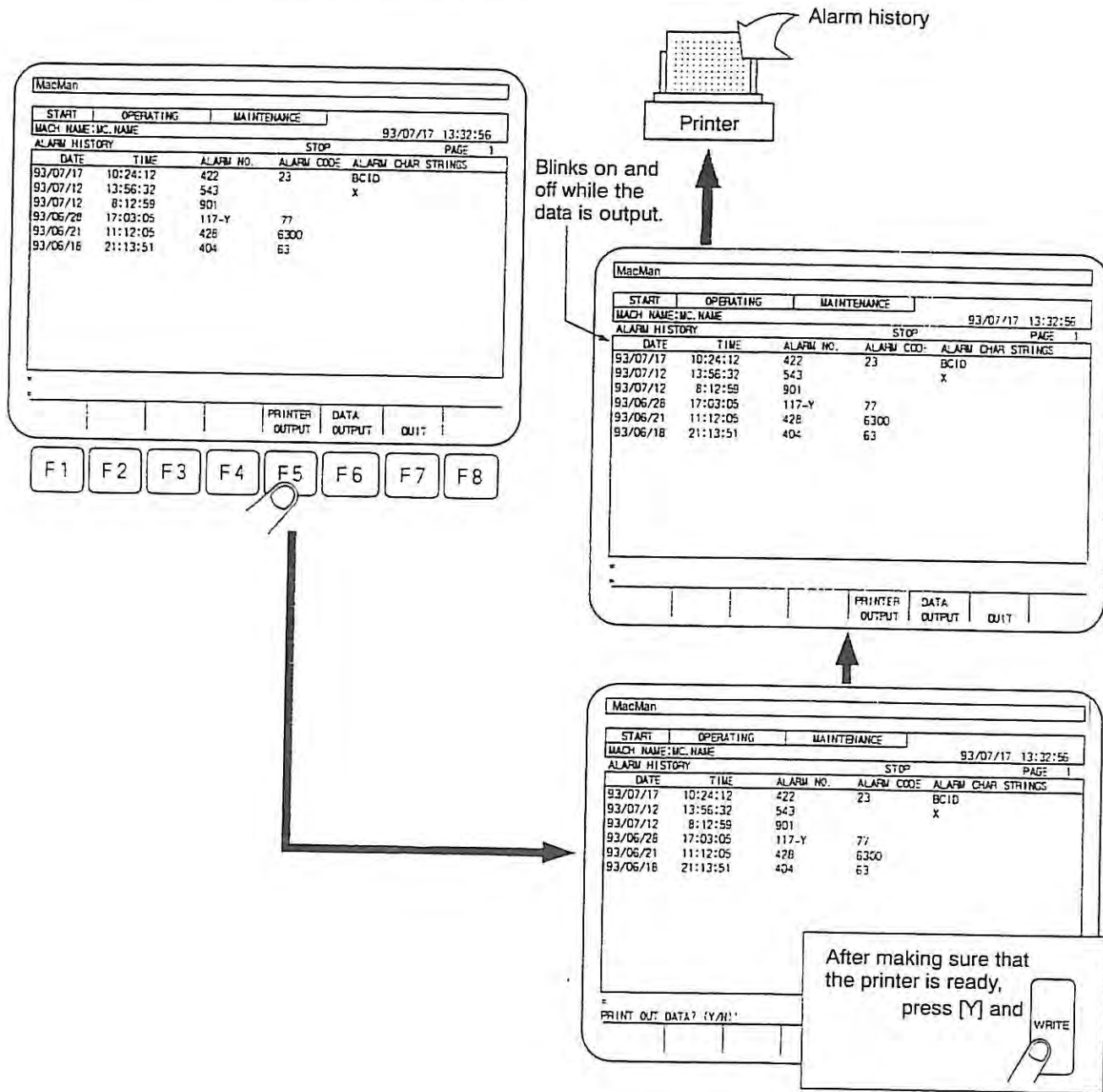

SECTION 15 OPERATION HISTORY

15-1. Operation History - Console Line

MacMan

START	OPERATING	MAINTENANCE
-------	-----------	-------------

MACH NAME: MC. NAME 93/07/17 13:32:56

OPERATION HISTORY: CONSOLE LINE PAGE 1

DATE	TIME	
93/07/17	13:24:12	=SET 2000
93/07/17	13:23:20	306 COMMAND CHARACTER ERROR
93/07/17	13:23:20	=SE 2000
93/07/17	13:23:00	IB
93/07/17	13:23:00	IB
93/07/17	13:22:59	ABORT CONTROL-C RESET
93/07/17	13:22:50	=IN GOX100
93/07/17	13:21:23	=CA 4,20000
93/07/17	13:20:49	=CH
93/07/17	13:20:36	330 FLOPPY DISK READ/WRITE ERROR
93/07/17	13:20:32	>CP FDO:PROGRAM.MIN
93/07/17	12:33:56	312 FLOPPY UNINITIALIZED ERROR
93/07/17	12:33:53	>CP FD1:PROGRAM.MIN
93/07/17	12:32:41	=PIP

CONSOLE LINE	OPERATE PANEL	I/O SIGNALS		PRINTER OUTPUT	DATA OUTPUT	QUIT
-----------------	------------------	----------------	--	-------------------	----------------	------

F1

F2

F3

F4

F5

F6

F7

F8

(1) Contents of Operation History - Console Line

The messages having been displayed in the console line of the NC screen are stored in the memory including the date and time of display.

MacMan

START	OPERATING	MAINTENANCE					
MACH NAME:MC.NAME		93/07/17 13:28:35					
TODAY'S MACHINING REPORT							
MAIN PROGRAM	START DAY	START TIME	NO. OF WORK	OPERATING %			
PART045-L4392.MIN	93/07/17	12:12:09	8	43			
SUM	93/07/17	8:19:23	34	45			
PART045-L4392.MIN		OP023					
TODAY'S OPERATING REPORT							
	[H: M: S]	[%]	0%	25%	50%	75%	100%
RUNNING	4:34:21	100	████████████████████				
OPERATING	3:58:23	53	██████████████████				
CUTTING	2:59:43	24	██████████████				
NOT OPERATING	1:37:16	41	██████████				
IN-PRO SETUP	1:10:10	32	████████				
NO OPERATOR	27:06	15	██████				
PART WAITING	0	0					
MAINTENANCE	0	0					
OTHER	0	0					

(0=IN-PROCESS SETUP, 1=NO OPERATOR, 2=PART WAIT, 3=MAINT, 4=OTHER)
WHICH NOT OPERATING? ! 3

WHICH	DOC	MACHINE	REPORT	TROUBLE	PREF
NON OP	DISPLAY	PREPARE	INFO	INFO	SETTING

Console line

OPERATION HISTORY: CONSOLE LINE PAGE 1

DATE	TIME	
93/07/17	13:32:45	=OHS
93/07/17	13:32:40	=TRBL
93/07/17	13:28:35	WHICH NOT OPERATING? ! 3
93/07/17	13:28:32	(0=IN-PROCESS SETUP, 1=NO OPERATOR, 2=PART WAIT, 3=MAINT)
93/07/17	13:24:12	=SET 2000
93/07/17	13:23:20	306 COMMAND CHARACTER ERROR
93/07/17	13:23:20	=SE 2000
93/07/17	13:23:00	IB
93/07/17	13:23:00	IB
93/07/17	13:22:59	ABORT CONTROL-C RESET
93/07/17	13:22:50	=IN GOX100
93/07/17	13:21:23	=CA 4, 20000
93/07/17	13:20:49	=CH
93/07/17	13:20:36	330 FLOPPY DISK READ/WRITE ERROR

15-2. Operation History - Operation Panel

MacMan

START	OPERATING	MAINTENANCE
MACH NAME: MC NAME		93/07/17 13:32:56
OPERATION HISTORT: OPERATION PANEL		PAGE 1
DATE	TIME	
93/07/17	13:24:12	[F1]
93/07/17	13:23:20	[F4]
93/07/17	13:23:20	MODE [EF]
93/07/17	13:23:00	MODE [E8]
93/07/17	13:23:00	TURRET [E6]
93/07/17	13:22:59	PAGE [E4]
93/07/17	13:22:50	PAGE [E4]
93/07/17	13:21:23	CURSOR [E0]
93/07/17	13:20:49	CONTROL [00]
93/07/17	13:20:36	MODE [E7]
93/07/17	13:20:32	PAGE [E5]
93/07/17	12:33:56	PAGE [E5]
93/07/17	12:33:53	[31]
93/07/17	12:32:41	[32]

=

CONSOLE LINE	OPERATE PANEL	I/O SIGNALS	PRINTER OUTPUT	DATA OUTPUT	QUIT
--------------	---------------	-------------	----------------	-------------	------

F1 F2 F3 F4 F5 F6 F7 F8











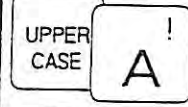
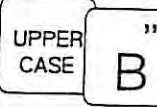

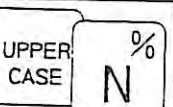
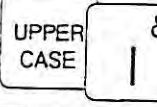







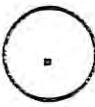

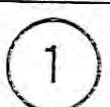





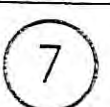

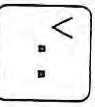
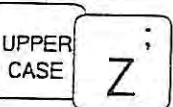
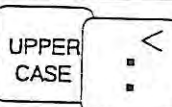
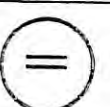
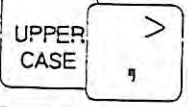
(1) Contents of Operation History - Operation Panel

Key operations having been made on the operation panel of the NC unit are stored in the memory by the code, which represents the key, including the date and time of key operation.

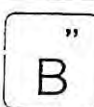
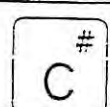
The codes which represent individual keys are summarized below:

Key code

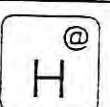
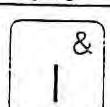
[20] 	[21] 	[22] 	[23] 	[24] 	[25] 
[26] 	[27] 	[28] 	[29] 	[2A] 	[2B] 
[2C] 	[2D] 	[2E] 	[2F] 	[30] 	[31] 
[32] 	[33] 	[34] 	[35] 	[36] 	[37] 
[38] 	[39] 	[3A] 	[3B] 	[3C] 	[3D] 
[3E] 	[3F] 	[40] 	[41] 	[42] 	[43] 
[44] 	[45] 	[46] 	[47] 	[48] 	[49] 

[4A]	[4B]	[4C]	[4D]	[4E]	[4F]
J	K [?]	L	HT M	N [%]	O
[50]	[51]	[52]	[53]	[54]	[55]
P [¥]	Q	R	S [!]	T [^]	U []]
[56]	[57]	[58]	[59]	[5A]	[5B]
V ⁻	W ⁻	X [!]	Y [!]	Z [;]	UPPER CASE T [^]
[5C]	[5D]	[5E]	[5F]	[60]	[7B]
UPPER CASE P [¥]	UPPER CASE U []]	UPPER CASE R	UPPER CASE V ⁻	UPPER CASE L	UPPER CASE X [!]
[7C]	[7D]	[7E]	[7F]	CURSOR [E0]	CURSOR [E1]
UPPER CASE S [!]	UPPER CASE Y [!]	UPPER CASE W	UPPER CASE DEL E	↓	↑
CURSOR [E2]	CURSOR [E3]	PAGE [E4]	PAGE [E5]	TURRET [E6]	TURRET [E7]
→	←	P ↓	↑ P	A	B
MODE [E8]	MODE [E9]	MODE [EA]	MODE [EB]	MODE [EC]	MODE [ED]
MacMan	TOOL DATA	ZERO SET	PARAMETER	EDIT AUX	MANUAL
MODE [EE]	MODE [EF]	CONTROL [08]	CONTROL [09]	CONTROL [0D]	CONTROL [18]
AUTO	MDI	BS	UPPER CASE HT M	WRITE	CAN

[F0]	[F1]	[F2]	[F3]	[F4]	[F5]
F1	F2	F3	F4	F5	F6
[F6]	[F7]				
F7	F8				
CONTROL [00]	CONTROL [01]	CONTROL [02]	CONTROL [03]	CONTROL [04]	CONTROL [05]
CTRL =	CTRL A!	CTRL B"	CTRL C#	CTRL D\$	CTRL DEL E
CONTROL [06]	CONTROL [07]	CONTROL [08]	CONTROL [09]	CONTROL [0A]	CONTROL [0B]
CTRL F'	CTRL G')	CTRL H@	CTRL I&	CTRL J'	CTRL K?
CONTROL [0C]	CONTROL [0D]	CONTROL [0E]	CONTROL [0F]	CONTROL [10]	CONTROL [11]
CTRL L'	CTRL M ^{HT}	CTRL N%	CTRL O	CTRL P [¥]	CTRL Q
CONTROL [12]	CONTROL [13]	CONTROL [14]	CONTROL [15]	CONTROL [16]	CONTROL [17]
CTRL R [˘]	CTRL S ^l	CTRL T ^l	CTRL U ^l	CTRL V ⁻	CTRL W ⁻
CONTROL [18]	CONTROL [19]	CONTROL [1A]	CONTROL [1B]	CONTROL [1C]	CONTROL [1D]
CTRL X ^l	CTRL Y ^l	CTRL Z ^l	CTRL *	CTRL /	CTRL +
CONTROL [1E]	CONTROL [1F]				
CTRL -	CTRL =				

15-3. Operation History - I/O Signals

MacMan

START	OPERATING	MAINTENANCE			
MACH NAME: MC. NAME			93/07/17	13:32:56	
OPERATION HISTORY: I/O SIGNALS					PAGE 1
DATE	TIME				
93/07/17	13:24:12	INPUT	0300C200	12FFA005	330012FF 78CC920C
93/07/17	13:23:20	INPUT	0300C200	12GJA008	330012FF 78CC920C
93/07/17	13:23:18	OUTPUT	0300C202	12FFA005	330012FF 78CC920C
93/07/17	13:23:00	INPUT	0300C200	12FFA005	33001300 78CC920C
93/07/17	13:22:58	OUTPUT	0300C200	12FFA005	330012FF 78CF920C
93/07/17	13:22:59	INPUT	0300C200	12FFA105	330012FF 78CC920C
93/07/17	13:22:50	INPUT	0300C200	12FFA005	330012FF 78CC920C
93/07/17	13:21:23	OUTPUT	0300C200	12FFA005	530012FF 78CC920C
93/07/17	13:20:49	OUTPUT	0300C200	12FFA005	540012FF 78CC920C
93/07/17	13:20:36	INPUT	0300C200	12FFA005	330012FF 78CC920C
93/07/17	13:20:32	INPUT	0300C200	12FFA005	330012FF 78CC920B
93/07/17	12:33:56	INPUT	0300C200	12FFA005	330012FF 78CC920B
93/07/17	12:33:53	INPUT	0300C200	12FFA005	330012FF 78AC920B
93/07/17	12:32:41	INPUT	0300C200	12FFA005	330012FF 78BC920B

=
=

CONSOLE LINE	OPERATE PANEL	I/O SIGNALS		PRINTER OUTPUT	DATA OUTPUT	QUIT
-----------------	------------------	----------------	--	-------------------	----------------	------

F1

F2

F3

F4

F5

F6

F7

F8

(1) 16-byte signals (128 signals) are scanned for inputs and outputs, respectively, and if ON/OFF status of any of the I/O signal has been changed, it is recorded.

(2) The recorded I/O signals are displayed in the following format. □□ corresponds to 1-byte signal (8 signals).

INPUT □□□□□□□□ □□□□□□□□ □□□□□□□□ □□□□□□□□
OUTPUT □□□□□□□□ □□□□□□□□ □□□□□□□□ □□□□□□□□

(3) The signals to be scanned are defined on the I/O SIGNALS screen of the PREFERENCE SETTINGS function. The signal scan mode is determined by the contents of definition.

(a) The signals are scanned by setting the slave station number, strobe number, and bit on the I/O SIGNALS screen of the PREFERENCE SETTINGS function.

(b) The status of the I/O signals are not recorded even if the ON/OFF status of them is changed.

(2) Output Format of the Operation History

If you output the machining report to the floppy disk (MS-DOS format), it is output in the text file . It can be displayed or analyzed using word processor software.

Refer to Section 19. "OUTPUT FILES".

(3) Output Device and File Name

The alarm history can be output to the floppy disk by simply pressing function key [F6] (DATA OUTPUT). The device name and the file name are set on the OUTPUT DATA screen of the PREFERENCE SETTINGS function.

Note 1: Output device name

The operation history is output to the device set for DEFAULT DEVICE NAME on the PREFERENCE SETTINGS screen. The initial setting for DEFAULT DEVICE NAME is "FD0:". Therefore, to output the operation history to a floppy disk set in the FD0:, you do not have to set the output device name.

Note 2: Output file name

The operation history to be output to the floppy disk is assigned the file name which is set for DEFAULT FILE NAME on the PREFERENCE SETTINGS screen. The initial setting for DEFAULT FILE NAME is:

*Operation history: Console line CS*h*m*s.D*D*

*Operation history: Operation panel OP*h*m*s.D*D*

*Operation history: I/O signals MP*h*m*s.D*D*

If function key [F6] (DATA OUTPUT) is pressed at 13:30:48 in April 12, 1993, the actual file names to be assigned are:

Operation history: Console line CS133048.D12

Operation history: Operation panel OP133048.D12

Operation history: I/O signals MP133048.D12

(4) After the completion of output of operation history (text file), the following message is displayed to ask you whether or not the file necessary for I/O signal analysis should be output.

DATA HAS BEEN OUTPUT.

OUTPUT FILE REQUIRED FOR I/O SIGNAL ANALYSIS?(Y/N)

For the operation history (I/O signals), the ON/OFF status of the I/O signals is described in hexadecimal.

This file is necessary to analyze the I/O signals in the same manner as the check data display in automatic operation.

If there is more than one file which is necessary for I/O signal analysis, the following message is displayed for the second and later files.

OUTPUT FILE REQUIRED FOR I/O SIGNAL ANALYSIS?(Y/N)

15-5. Outputting the Operation History to Printer

- (1) The information output to the floppy disk can be printed using a personal computer. If a printer is connected to the OSP, it is possible to printer the report directly from the OSP.

The output procedure is the same as ouputting the machining report. Refer to Section 8, 8-5. "Outputting the Machining Report to Printer".

- (2) The contents to be printed with the printer connected to the OSP are the same as those printed using the floppy disk saving the machining report in the text file.

Refer to Section 19. "OUTPUT FILES".

Operation history displayed on the screen
Console history in this example

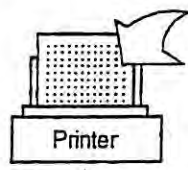

Blinks on and off while the data is output.

MacMan		
START	OPERATING	MAINTENANCE
MACH NAME:MC NAME 93/07/17 13:32:56		
OPERATION HISTORY: CONSOLE LINE PAGE 1		
DATE	TIME	
93/07/17	13:24:12	=OIS
93/07/17	13:23:20	=OP
93/07/17	13:23:20	=IP
93/07/17	13:23:00	=OHS
93/07/17	13:23:00	=TREL
93/07/17	13:22:59	ABORT CONTROL-C RESET
93/07/17	13:22:50	=IH G0X100
93/07/17	13:21:23	=CA 4,20000
93/07/17	13:20:49	=OH
93/07/17	13:20:36	330 FLOPPY DISK READ/WRITE ERROR
93/07/17	13:20:32	>CP FDD:PROGRAM.M3H
93/07/17	12:33:56	312 FLOPPY UNINITIALIZED ERROR
93/07/17	12:33:53	>CP FDI:PROGRAM.M3H
93/07/17	12:32:41	=PIP

F1 F2 F3 F4 F5 F6 F7 F8

The operation history displayed on the screen is output.
Change the screen to the one displaying the history to be output.

MacMan		
START	OPERATING	MAINTENANCE
MACH NAME:MC NAME 93/07/17 13:32:57		
OPERATION HISTORY: CONSOLE LINE PAGE 1		
DATE	TIME	
93/07/17	13:32:56	=OIS
93/07/17	13:24:12	=OIS
93/07/17	13:23:20	=OP
93/07/17	13:23:20	=IP
93/07/17	13:23:00	=OHS
93/07/17	13:23:00	=TREL
93/07/17	13:22:59	ABORT CONTROL-C RESET
93/07/17	13:22:50	=IH G0X100
93/07/17	13:21:23	=CA 4,20000
93/07/17	13:20:49	=OH
93/07/17	13:20:36	330 FLOPPY DISK READ/WRITE ERROR
93/07/17	13:20:32	>CP FDD:PROGRAM.M3H
93/07/17	12:33:56	312 FLOPPY UNINITIALIZED ERROR
93/07/17	12:33:53	>CP FDI:PROGRAM.M3H
=OIS		

F1 F2 F3 F4 F5 F6 F7 F8

MacMan		
START	OPERATING	MAINTENANCE
MACH NAME:MC NAME 93/07/17 13:33:30		
OPERATION HISTORY: CONSOLE LINE STOP PAGE 1		
DATE	TIME	
93/07/17	13:32:59	PRINT OUT DATA? (Y/N)!
93/07/17	13:32:57	=PRH
93/07/17	13:32:56	=OIS
93/07/17	13:24:12	=OIS
93/07/17	13:23:20	=OP
93/07/17	13:23:20	=IP
93/07/17	13:23:00	=OHS
93/07/17	13:23:00	=TREL
93/07/17	13:22:59	ABORT CONTROL-C RESET
93/07/17	13:22:50	=IH G0X100
93/07/17	13:21:23	=CA 4,20000
93/07/17	13:20:49	=OH
93/07/17	13:20:36	330 FLOPPY DISK READ/WRITE ERROR
93/07/17	13:20:32	>CP FDD:PROGRAM.M3H
PRINT OUT DATA? (Y/N)!		

MacMan		
START	OPERATING	MAINTENANCE
MACH NAME:MC NAME 93/07/17 13:32:59		
OPERATION HISTORY: CONSOLE LINE PAGE 1		
DATE	TIME	
93/07/17	13:32:57	=PRH
93/07/17	13:32:56	=OIS
93/07/17	13:24:12	=OIS
93/07/17	13:23:20	=OP
93/07/17	13:23:20	=IP
93/07/17	13:23:00	=OHS
93/07/17	13:23:00	=TREL
93/07/17	13:22:59	ABORT CONTROL-C RESET
93/07/17	13:22:50	=IH G0X100
93/07/17	13:21:23	=CA 4,20000
93/07/17	13:20:49	=OH
93/07/17	13:20:36	330 FLOPPY
93/07/17	13:20:32	>CP FDD:PR
93/07/17	12:33:56	312 FLOPPY
=PRH		
PRINT OUT DATA? (Y/N)!		

After making sure that the printer is ready, press [Y] and

WRITE

SECTION 16 VARIABLE HISTORY

MacMan

START
OPERATING
MAINTENANCE

MACH NAME: MC NAME 93/07/17 13:32:56

VARIABLES HISTORY: A PAGE 1

DATE	TIME	VAR-A1	VAR-A2	VAR-A3	VAR-A4
93/07/17	13:24:12	1	1	1	0
93/07/17	13:23:20	1	1	0	0
93/07/17	13:23:20	1	0	0	0
93/07/17	13:23:00	1	0	0	2
93/07/17	13:23:00	1	0	0	1
93/07/17	13:22:59	1	0	0	4
93/07/17	13:22:50	1	1	0	4
93/07/17	13:21:23	1	1	1	4
93/07/17	13:20:49	1	1	0	4
93/07/17	13:20:36	1	0	0	4
93/07/17	13:20:32	0	0	0	4
93/07/17	12:33:56	0	0	0	3

ADDRESS 0010C080 0010C081 0010C082 0010C083
 SAMPLE CYCLE (SEC) 1.0000

=

VAR-A	VAR-B	VAR-C	VAR-D	PRINTER OUTPUT	DATA OUTPUT	QUIT
-------	-------	-------	-------	-------------------	----------------	------

F1
F2
F3
F4
F5
F6
F7
F8

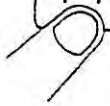

16-1. Displaying the Variable History

(1) Periodical Scanning

The variables in the NC are scanned in fixed intervals and if the value set for a variable is changed, the date and time of change and the new variable value are stored.

(2) Four Types of Variable Histories

The NC uses four types of variables and the screen displaying the history of each type of the variables can be selected by pressing a proper function key ([F1] to [F4]).

(a) Variables history: A

The variables (variable A1, variable A2, variable A3, and variable A4) in the NC are scanned in fixed intervals and if the value set for any of variable A1, variable A2, variable A3, and variable A4 is changed, the date and time of change and the new variable value are stored.

(b) Variables history: B

The variables (variable B1, variable B2, variable B3, and variable B4) in the NC are scanned in fixed intervals and if the value set for any of variable B1, variable B2, variable B3, and variable B4 is changed, the date and time of change and the new variable value are stored.

(c) Variables history: C

The variables (variable C1, variable C2, variable C3, and variable C4) in the NC are scanned in fixed intervals and if the value set for any of variable C1, variable C2, variable C3, and variable C4 is changed, the date and time of change and the new variable value are stored.

(d) Variables history: D

The variables (variable D1, variable D2, variable D3, and variable D4) in the NC are scanned in fixed intervals and if the value set for any of variable D1, variable D2, variable D3, and variable D4 is changed, the date and time of change and the new variable value are stored.

(3) Defining the Variables

The variables are defined by "address", "size", "attribute", and "attribute for display".

- Variables of "VARIABLES HISTORY: A" are set at the VARIABLES-A screen of the PREFERENCE SETTINGS function.
- Variables of "VARIABLES HISTORY: B" are set at the VARIABLES-B screen of the PREFERENCE SETTINGS function.
- Variables of "VARIABLES HISTORY: C" are set at the VARIABLES-C screen of the PREFERENCE SETTINGS function.
- Variables of "VARIABLES HISTORY: D" are set at the VARIABLES-D screen of the PREFERENCE SETTINGS function.

(4) Sampling Cycle

As explained above, the variables are scanned in fixed intervals. This scanning intervals are set for SAMPLING CYCLE (SEC) on the same screen as used to set the variables. The sampling cycle can be set for each variable history.

- (5) The history information (machining report, alarm history, operation history, variable history) is usually displayed in the order of latest date and time. However, in the case of the variable history, it is possible to display the history in the state it is stored in the memory (in the order of address).

DS [WRITE] The display format is changed alternately between the order of date and the order of address.

(6) Default Setting

By the default setting, variables history A checks the variables which represent the machine operating status. Variables history B to D do not check the variables.

(a) Variables history A

Cause of not-operating
(0=in-process setup, 1=no operator, 2=part waiting, 3=maintenance, 4=other)

Cutting status (0=not cutting, 1=cutting)

Operating status (0=not operating, 1=operating)

Start status (0=not started, 1=started)

VARIABLES HISTORY: A		VAR-A1	VAR-A2	VAR-A3	VAR-A4
DATE	TIME				
93/07/17	13:24:12	1	1	1	0
93/07/17	13:23:20	1	1	0	0
93/07/17	13:23:20	1	0	0	0
93/07/17	13:23:00	1	0	0	2
93/07/17	13:23:00	1	0	0	1
93/07/17	13:22:59	1	0	0	4
93/07/17	13:22:50	1	1	0	4
93/07/17	13:21:23	1	1	1	4
93/07/17	13:20:49	1	1	0	4
93/07/17	13:20:36	1	0	0	4
93/07/17	13:20:32	0	0	0	4
93/07/17	12:33:56	0	0	0	3

ADDRESS 0010C080 0010C081 0010C082 0010C083

SAMPLE CYCLE (SEC) 1.0000

The function checks the value for each variables.

Address of variable A1

Address of variable A2

Address of variable A3

Address of variable A4

(b) Variables history B to D

VARIABLES HISTORY: B

DATE	TIME	VAR-B1	VAR-B2	VAR-B3	VAR-B4

ADDRESS

SAMPLE CYCLE (SEC) 0.0000

16-2. Outputting the Variables History to Floppy Disk

You can save the variables history by outputting it to floppy disk.

(1) Operating Procedure

Insert an MS-DOS format floppy disk to the floppy disk drive and follow the procedure indicated below.

The variables history displayed on the screen is output to the floppy disk by simply pressing function key [F6] (DATA OUTPUT).

START	OPERATING	MAINTENANCE	93/07/17 13:32:56			
MACH NAME: MC NAME						
VARIABLES HISTORY: A						
DATE	TIME	VAR-A1	VAR-A2	VAR-A3	VAR-A4	PAGE
93/07/17	13:24:12	1	1	1	0	1
93/07/17	13:23:20	1	1	0	0	0
93/07/17	13:23:20	1	0	0	0	0
93/07/17	13:23:00	1	0	0	0	2
93/07/17	13:23:00	1	0	0	0	1
93/07/17	13:22:59	1	0	0	0	4
93/07/17	13:22:50	1	1	0	0	4
93/07/17	13:21:23	1	1	1	0	4
93/07/17	13:20:49	1	1	0	0	4
93/07/17	13:20:36	1	0	0	0	4
93/07/17	13:20:32	0	0	0	0	4
93/07/17	12:33:56	0	0	0	0	3

ADDRESS 0010C8C 0010C8E 0010C8F 0010C83
SAMPLE CYCLE (SEC) 1.0000

VAR-A VAR-B VAR-C VAR-D PRINTER OUTPUT DATA OUTPUT QUIT

F1 F2 F3 F4 F5 F6 F7 F8

The variables history displayed on the screen is output. Change the screen to the one displaying the history to be output, and press [F6].

START	OPERATING	MAINTENANCE	93/07/17 13:32:56			
MACH NAME: MC NAME						
VARIABLES HISTORY: A						
DATE	TIME	VAR-A1	VAR-A2	VAR-A3	VAR-A4	PAGE
93/07/17	13:24:12	1	1	1	0	1
93/07/17	13:23:20	1	1	0	0	0
93/07/17	13:23:20	1	0	0	0	0
93/07/17	13:23:00	1	0	0	0	2
93/07/17	13:23:00	1	0	0	0	1
93/07/17	13:22:59	1	0	0	0	4
93/07/17	13:22:50	1	1	0	0	4
93/07/17	13:21:23	1	1	1	0	4
93/07/17	13:20:49	1	1	0	0	4
93/07/17	13:20:36	1	0	0	0	4
93/07/17	13:20:32	0	0	0	0	4
93/07/17	12:33:56	0	0	0	0	3

ADDRESS 0010C8C 0010C8E 0010C8F 0010C83
SAMPLE CYCLE (SEC) 1.0000

SAMPLING STOPPED. RESTART SAMPLING? (Y/N):

VAR-A VAR-B VAR-C VAR-D PRINTER OUTPUT DATA OUTPUT QUIT

MS-DOS format

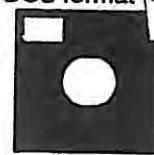

Variables history displayed on the screen
Variables history A in this example
(Text file)

Completion of output

Blinks on and off while the data is output.

Data collection is suspended during output

START	OPERATING	MAINTENANCE	93/07/17 13:32:56			
MACH NAME: MC NAME						
VARIABLES HISTORY: A						
DATE	TIME	VAR-A1	VAR-A2	VAR-A3	VAR-A4	PAGE
93/07/17	13:24:12	1	1	1	0	1
93/07/17	13:23:20	1	1	0	0	0
93/07/17	13:23:20	1	0	0	0	0
93/07/17	13:23:00	1	0	0	0	2
93/07/17	13:23:00	1	0	0	0	1
93/07/17	13:22:59	1	0	0	0	4
93/07/17	13:22:50	1	1	0	0	4
93/07/17	13:21:23	1	1	1	0	4
93/07/17	13:20:49	1	1	0	0	4
93/07/17	13:20:36	1	0	0	0	4
93/07/17	13:20:32	0	0	0	0	4
93/07/17	12:33:56	0	0	0	0	3

ADDRESS 0010C8C 0010C8E 0010C8F 0010C83
SAMPLE CYCLE (SEC) 1.0000

OUTPUT DATA? (Y/N):

VAR-A VAR-B VAR-C

After making sure that floppy disk is set, press [Y] and WRITE

START	OPERATING	MAINTENANCE	93/07/17 13:32:56			
MACH NAME: MC NAME						
VARIABLES HISTORY: A						
DATE	TIME	VAR-A1	VAR-A2	VAR-A3	VAR-A4	PAGE
93/07/17	13:24:12	1	1	1	0	1
93/07/17	13:23:20	1	1	0	0	0
93/07/17	13:23:20	1	0	0	0	0
93/07/17	13:23:00	1	0	0	0	2
93/07/17	13:23:00	1	0	0	0	1
93/07/17	13:22:59	1	0	0	0	4
93/07/17	13:22:50	1	1	0	0	4
93/07/17	13:21:23	1	1	1	0	4
93/07/17	13:20:49	1	1	0	0	4
93/07/17	13:20:36	1	0	0	0	4
93/07/17	13:20:32	0	0	0	0	4
93/07/17	12:33:56	0	0	0	0	3

ADDRESS 0010C8C 0010C8E 0010C8F 0010C83
SAMPLE CYCLE (SEC) 1.0000

STOP

VAR-A VAR-B VAR-C VAR-D PRINTER OUTPUT DATA OUTPUT QUIT

(2) Output Format of the Variables History

If you output the machining report to the floppy disk (MS-DOS format), it is output the text file.
Refer to Section 19. "OUTPUT FILES".

It can be displayed or analyzed using word processor software.

(3) Output Device and File Name

The variables history can be output to the floppy disk by simply pressing function key [F6] (DATA OUTPUT). The device name and the file name are set on the OUTPUT DATA screen of the PREFERENCE SETTINGS function.

Note 1: Output device name

The variables history is output to the device set for DEFAULT DEVICE NAME on the PREFERENCE SETTINGS screen. The initial setting for DEFAULT DEVICE NAME is "FD0:". Therefore, to output the variables history to a floppy disk set in the FD0:, you do not have to set the output device name.

Note 2: Output file name

The variables history to be output to the floppy disk is assigned the file name which is set for DEFAULT FILE NAME on the PREFERENCE SETTINGS screen. The initial setting for DEFAULT FILE NAME is:

*Variables history: A VA*h*m*s.D*D*

*Variables history: B VB*h*m*s.D*D*

*Variables history: C VC*h*m*s.D*D*

*Variables history: D VD*h*m*s.D*D*

If function key [F6] (DATA OUTPUT) is pressed at 13:30:48 in April 12, 1993, the actual file names to be assigned are:

Variables history: A VA133048.D12

Variables history: B VB133048.D12

Variables history: C VC133048.D12

Variables history: D VD133048.D12

(4) Data collection is suspended while the data is being output to the printer or floppy disk. At the completion of data output, the screen displays the message "SAMPLING STOPPED, RESTART SAMPLING (Y/N)!" in the console line asking you if you want to restart sampling.

You can simply input [Y] or [N] depending on whether you want to restart data collection or not.

The following commands may also be used to start or stop collection of the variables history:

NS [WRITE] Data collection restarts for the history of the displayed variables.

NE [WRITE] Data collection is stopped for the history of the displayed variables.

NS;A [WRITE] Data collection restarts for all the variables histories.

NE;A [WRITE] Data collection is stopped for all the variables histories.

16-3. Outputting the Variables History to Printer

- (1) The information output to the floppy disk can be printed using a personal computer. If a printer is connected to the OSP, it is possible to print the report directly from the OSP.
- (2) The contents to be printed with the printer connected to the OSP are the same as those printed using the floppy disk saving the machining report in the text file.

Refer to Section 19. "OUTPUT FILES".

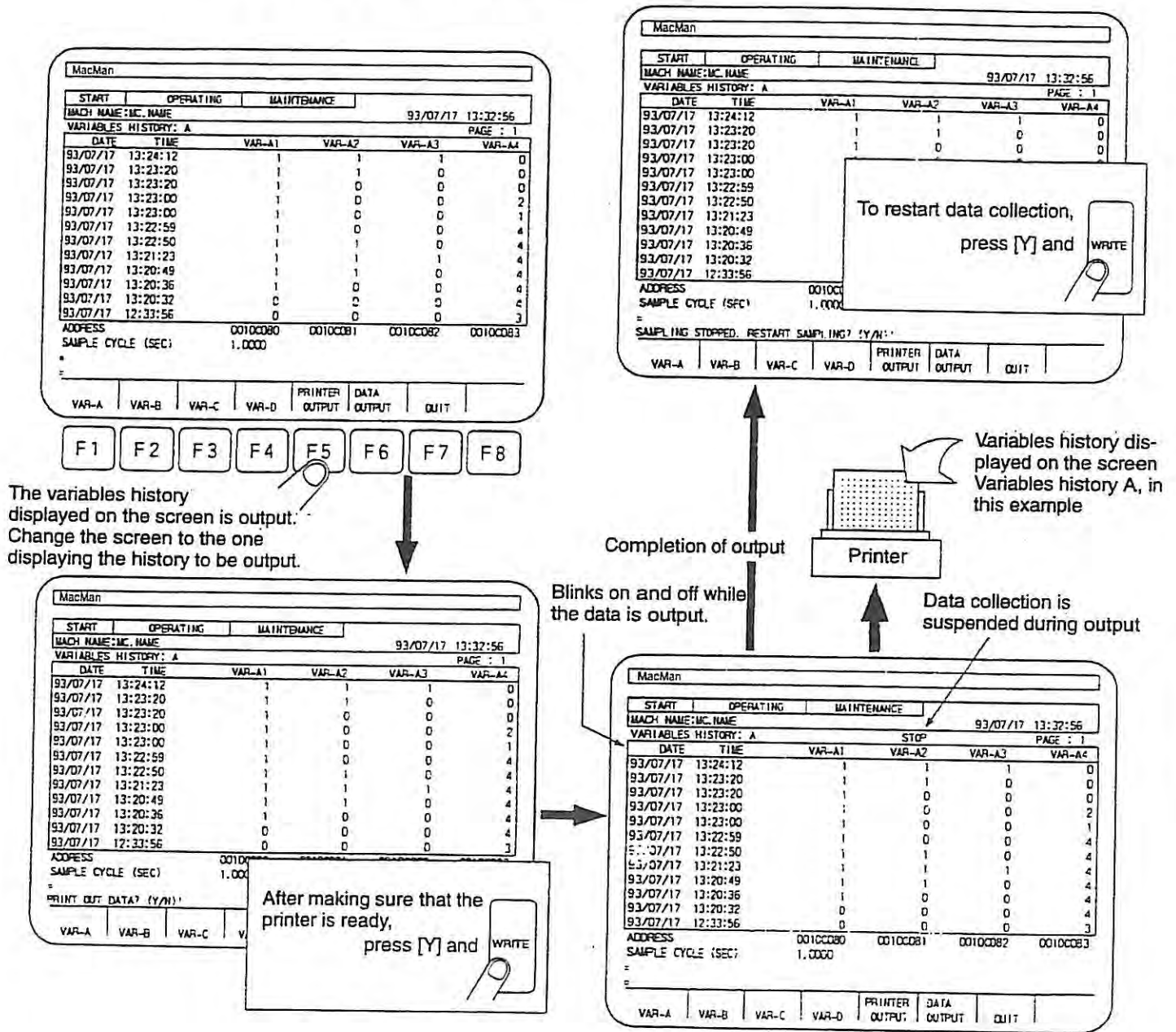

SECTION 17 PREFERENCE SETTINGS

MacMan							
START	OPERATING		MAINTENANCE				
MACH NAME:MC.NAME					93/07/17 13:32:56		
PREFERENCE SETTINGS							
=							
=							
REPORT/ PRINTER	INPUT DATA	OUTPUT DATA	I/O SIGNALS			QUIT	[EXTEND]

MacMan							
START	OPERATING		MAINTENANCE				
MACH NAME:MC.NAME					93/07/17 13:32:56		
PREFERENCE SETTINGS							
=							
=							
VAR-A	VAR-B	VAR-C	VAR-D			QUIT	[EXTEND]

F1	F2	F3	F4	F5	F6	F7	F8
----	----	----	----	----	----	----	----



(f) VAR-B

The following is set for the four variables (variable B1, variable B2, variable B3, variable B4) which are checked on the variables history B screen:

- Address
- Size
- Attribute
- Display attribute

The sampling period is also set.

(g) VAR-C

The following is set for the four variables (variable C1, variable C2, variable C3, variable C4) which are checked on the variables history C screen:

- Address
- Size
- Attribute
- Display attribute

The sampling period is also set.

(h) VAR-D

The following is set for the four variables (variable D1, variable D2, variable D3, variable D4) which are checked on the variables history D screen:

- Address
- Size
- Attribute
- Display attribute

The sampling period is also set.

(2) [F5] (CANCEL) and [F7] (QUIT) keys

[F7] (QUIT):

To confirm the data which you have set, press function key [F7]. The previous setting is updated to the new data, or the new data is saved.

[F5] (CANCEL):

To cancel the data which you have set so that the previous data is restored, press function [F5]. The new data is canceled and the previous data is not updated.

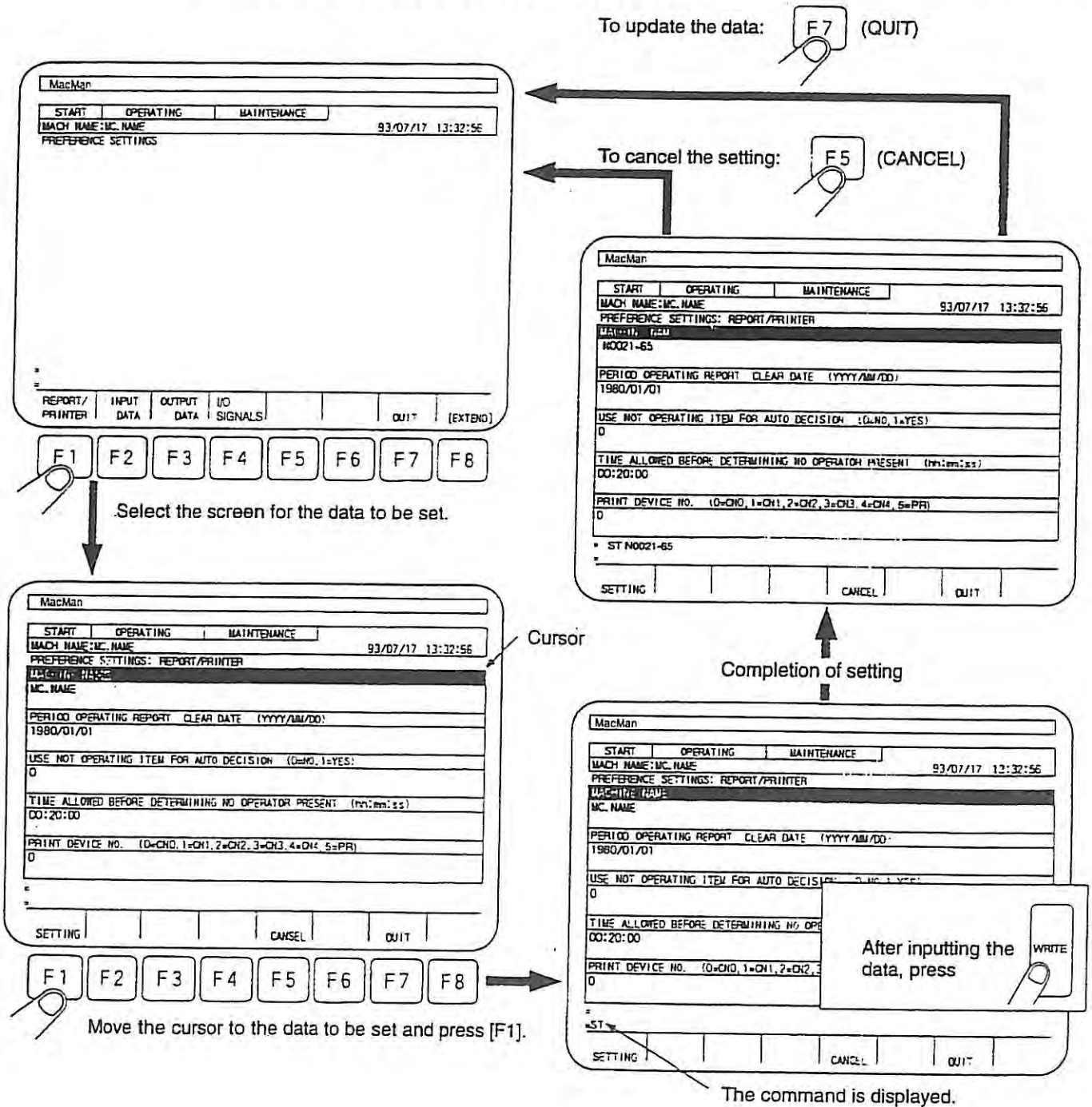

- (3) The information (machining report, trouble information) stored in the NC memory is cleared by executing the following commands.

Command	Information to be cleared
CLEAR [WRITE]	Machining report (today, pre day, period) Operating report (today, pre day, period) Operating history (today, pre day) NC status at alarm Alarm history Operation history (console line, operation panel, I/O signal) Variable history (A - D)
CLEAR 2 [WRITE]	Operating report (today, pre day, period)
CLEAR 3 [WRITE]	Machining report (today, pre day, period)
CLEAR 4 [WRITE]	Operating history (today, pre day)
CLEAR 5 [WRITE]	Operation history (console line, operation panel, I/O signals)
CLEAR 6 [WRITE]	Variable history (A - D)
CLEAR 7 [WRITE]	NC status at alarm Alarm history

These commands are valid only on the PREFERENCE SETTINGS screens.

Upon completion of clear, collection of machining information and trouble information begins.

17-1. REPORT/PRINTER Screen

MacMan							
START		OPERATING			MAINTENANCE		
MACH NAME: MC. NAME				93/07/17 13:32:56			
PREFERENCE SETTINGS: REPORT/PRINTER							
MACHINE NAME							
MC. NAME							
PERIOD OPERATING REPORT CLEAR DATE (YYYY/MM/DD)							
1980/01/01							
USE NOT OPERATING ITEM FOR AUTO DECISION (0=NO 1=YES)							
0							
TIME ALLOWED BEFORE DETERMINING NO OPERATOR PRESENT (hh:mm:ss)							
00:20:00							
PRINT DEVICE NO. (0=CN0, 1=CN1, 2=CN2, 3=CN3, 4=CN4, 5=PR)							
0							
=							
=							
SETTING				CANCEL		QUIT	
F1	F2	F3	F4	F5	F6	F7	F8

The parameters which are set on the REPORT/PRINTER screen are explained below.

(1) MACHINE NAME

Explanation	Setting
The machine name set here is displayed on all screens of the cell operation management function. The machine name is described in the file when outputting the report or troubleshooting information to a floppy disk. When outputting the report or troubleshooting information to a printer, the machine name is printed at the head of the print-out.	Within eight alphanumeric characters

(2) PERIOD OPERATING REPORT CLEAR DATE

Explanation	Setting
If the date of today agrees with the date set for "PERIOD OPERATING REPORT CLEAR DATE", the operating report in the memory is cleared when the NC is turned on.	Ten characters (fixed) If the number of digits of a number used to express the month or day is not two, prefix "0" to the number. Examples: 1993/07/30 Acceptable 1993/7/30 Not acceptable

(3) USE NOT OPERATING ITEM FOR AUTO DECISION

(4) TIME ALLOWED BEFORE DETERMINING NO OPERATOR PRESENT

Explanation	Setting
If you set "1" for "USE NOT OPERATING ITEM FOR AUTO DECISION", the reasons for not-operating status are automatically determined as follows: - If a key on the NC operation panel has not been pressed for the period set for "TIME ALLOWED BEFORE DETERMINING NO OPERATOR PRESENT", the reason for not-operating status is changed to "NO OPERATOR". Note that this automatic change is made only when the current reason is "IN-PRO SETUP". - If a key on the NC operation panel is pressed, the reason for not-operating is automatically changed to "IN-PRO SETUP". Note that this automatic change is made only when the current reason is "NO OPERATOR".	Eight characters (fixed) If the number of digits of a number used to express the time is not two, prefix "0" to the number. Examples: 08:59:00 Acceptable 8:59:00 Not acceptable

(5) PRINT DEVICE NO.

Explanation	Setting
<p>Set the channel where the report or troubleshooting information should be output to the printer. Output is possible to RS-232C or Centronics interface.</p> <p>Note that the setting simply specifies the channel and the status of the printer is not checked. This means the printer may not be connected to the specified channel.</p>	<p>Set any of the following numbers (0 to 5).</p> <p>0 to 4: RS-232C interface (serial) 5: Centronics (parallel)</p>

17-2. INPUT DATA Screen

MacMan							
START		OPERATING		MAINTENANCE			
MACH NAME: MC. NAME				93/07/17 13:32:56			
PREFERENCE SETTINGS: INPUT DATA						PAGE : 1	
DEFAULT DEVICE NAME							
FDD:							
MEMO FILE:		DEFAULT PATH (MS-DOS)					
¥							
JOB PROCEDURE FILE:		DEFAULT PATH (MS-DOS)					
¥							
MACHINING PROGRAM FILE:		DEFAULT PATH (MS-DOS)					
¥							
=							
=							
SETTING				CANCEL		QUIT	
F1	F2	F3	F4	F5	F6	F7	F8

The default device name and path (file) names, used to input a file from the floppy disk, which are set on the INPUT DATA screen are explained below.

Page 1:

(1) DEFAULT DEVICE NAME

Explanation: The default name of the device where the file is read if no device name is specified for file reading operation is set. This device name is also used as the default device for displaying the directory.

The set default device name is used for inputting any of the memo file, job procedure file, and machining program files.

Note that the setting simply specifies the device name and the status of the floppy disk drive is not checked. This means the floppy disk drive may not be installed even if the setting is made.

Setting: FD0: to FD9:

- (2) MEMO FILE: DEFAULT PATH (MS-DOS)
- (3) JOB PROCEDURE FILE: DEFAULT PATH (MS-DOS)
- (4) MACHINING PROGRAM FILE: DEFAULT PATH (MS-DOS)

Explanation: These default path names are used to input a file from the MS-DOS format floppy disk. These specify which directory should be used for reading the file if file input is specified without a path name. They are also used to specify the directory for which the file directory should be displayed if path name is omitted. The default path name can be specified for each of the files (memo file, job procedure file, and machining program file).

Setting: Within 65 characters of alphanumeric; preceded and followed by the back slash code (\). The directory beneath the specified path must conform with the rule of the MS-DOS.

\PART13.DIR\WORK954.DIR\

Page 2:

- (5) MEMO FILE: DEFAULT FILE (MS-DOS)
- (6) JOB PROCEDURE FILE: DEFAULT FILE (MS-DOS)
- (7) MACHINING PROGRAM FILE: DEFAULT FILE (MS-DOS)

Explanation: These default path names are used to display the directory of the files in the floppy disk. If the display of directory is specified without specifying a file name, the directory of the file specified by the default file name is displayed. The default file name can be specified for each of the files (memo file, job procedure file, and machining program file).

Setting: The main file name is fixed to "*", in other words, you can use only "*" for the main file name. The extension is either "*" or alphanumeric characters (within three characters).

.

*.TXT

17-3. OUTPUT DATA Screen

MacMan							
START		OPERATING			MAINTENANCE		
MACH NAME: MC.NAME					93/07/17 13:32:56		
PREFERENCE SETTINGS: OUTPUT DATA							PAGE 1
DEFAULT DEVICE NAME							
FDD:							
DAILY MACHINING REPORT FILE: DEFAULT FILE NAME							
%DW*Y*M*D.TXT							
DAILY OPERATING REPORT FILE: DEFAULT FILE NAME							
%DM*Y*M*D.TXT							
DAILY OPERATING HISTORY FILE: DEFAULT FILE NAME							
%DH*Y*M*D.TXT							
PERIOD MACHINING REPORT FILE: DEFAULT FILE NAME							
%TW*Y*M*D.TXT							
=							
=							
SETTING				CANCEL		QUIT	
F1	F2	F3	F4	F5	F6	F7	F8

The default device name and file names, used to output a file to the floppy disk, which are set on the OUTPUT DATA screen are explained below.

Page 1:

(1) DEFAULT DEVICE NAME

Explanation: The default name of the device where the file is output if no device name is specified for file output operation is set.

Note that the setting simply specifies the device name and the status of the floppy disk drive is not checked. This means the floppy disk drive may not be installed even if the setting is made.

Setting: FD0: to FD9:

Page 1 - 4:

- | | |
|------------------------------------|-------------------|
| (2) DAILY MACHINING REPORT FILE: | DEFAULT FILE NAME |
| (3) DAILY OPERATING REPORT FILE: | DEFAULT FILE NAME |
| (4) DAILY OPERATING HISTORY FILE: | DEFAULT FILE NAME |
| (5) PERIOD MACHINING REPORT FILE: | DEFAULT FILE NAME |
| (6) PERIOD OPERATING FILE: | DEFAULT FILE NAME |
| (7) NC STATUS AT ALARM FILE: | DEFAULT FILE NAME |
| (8) CURRENT NC STATUS FILE: | DEFAULT FILE NAME |
| (9) ALARM HISTORY FILE: | DEFAULT FILE NAME |
| (10) CONSOLE HISTORY FILE: | DEFAULT FILE NAME |
| (11) OPERATION PANEL HISTORY FILE: | DEFAULT FILE NAME |
| (12) I/O SIGNALS HISTORY FILE: | DEFAULT FILE NAME |
| (13) VARIABLES A HISTORY FILE: | DEFAULT FILE NAME |
| (14) VARIABLES B HISTORY FILE: | DEFAULT FILE NAME |
| (15) VARIABLES C HISTORY FILE: | DEFAULT FILE NAME |

(16) VARIABLES D HISTORY FILE: DEFAULT FILE NAME

Explanation: The default names of the files used to output the report or troubleshooting information to the floppy disk. Since the report and troubleshooting information are output to the MS-DOS format floppy disk, the default file names to be set must conform to the rule of MS-DOS.

Setting: For a path name, within 65 characters of alphanumeric characters which are preceded and followed by the back slash code (\) can be input. Set a file name following the path name. Note that the directory name and path name must conform to the MS-DOS rule.

\ ABCDEFGH.TXT
 _____ File name
 _____ Path name

\PART13.DIR\WORK954.DIR\RP.TXT
 _____ File name
 _____ Path name

If you specify a specific character (Y, M, D, h, m, s) following an asterisk (*), it is replaced with a two-digit number.

*Y : Year (Example: 1993, July 30 → 93)
 *M : Month (Example: 1993, July 30 → 07)
 *D : Date (Example: 1993, July 30 → 30)
 *h : Hour (Example: 8:34:52 → 08)
 *m : Minute (Example: 8:34:52 → 34)
 *s : Second (Example: 8:34:52 → 52)

Year/month/day: Today if DAILY REPORT (TODAY) or PERIOD REPORT is output.
 Previous day if DAILY REPORT (PRE DAY) is output.

Hour/minute/second: The time at which the file is output.

Example 1: To output DAILY OPERATING REPORT (TODAY) in July 30th of 1993

DW*Y*M*D.TXT → DW930730.TXT

Example 2: To output DAILY OPERATING REPORT (PRE DAY) in July 30th of 1993 (date of previous day: July 29th)

DW*Y*M*D.TXT → DW930729.TXT

Example 3: To output the ALARM HISTORY at 13:30:48 in July 30th of 1993

AL*h*m*s.D*D → AL133048.D30

Note: For the report files (1) to (6), the file format is determined according to the default extension of file name.

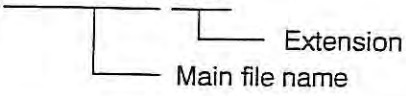
File name configuration: ** ~ **.***

	English Characters	Other Language
Extension = WJ2	Text file	Text file
Extension = WK1	Work sheet file	Work sheet file
Extension ≠ WJ2	Text file	Text file
Extension ≠ WK1		

17-4. I/O Signals

MacMan

START OPERATING MAINTENANCE

MACH NAME:MC. NAME 93/07/17 13:32:56

PREFERENCE SETTINGS: I/O SIGNALS PAGE 1

MAKE SETTING ON NEXT PAGE VALID? (0=NO,1=YES)

0

==

SETTING CANCEL QUIT

MacMan

START OPERATING MAINTENANCE

MACH NAME:MC. NAME 93/07/17 13:32:56

PREFERENCE SETTINGS: I/O SIGNALS PAGE 2

INPUT	SS-NO.	STROBE-NO.	BIT
**	3	3	A8
**	0	0	00
**	128	2	FF
**	1	4	0F
**	24	1	FE
**	100	2	3A
**	90	3	B4
**	82	4	01

SS-NO. : 1-128 (IF "0", DATA IGNORED)
STROBE-NO. : 0-4 (IF "0", DATA IGNORED)
BIT (HEXA) : 00-FF (ONLY HISTORY-RECORDED BITS CHANGED TO "1")

==

SETTING CANCEL QUIT

F1 F2 F3 F4 F5 F6 F7 F8

Page 1

(1) MAKE SETTING ON NEXT PAGE VALID? (0=NO, 1=YES)

Explanation: You can specify whether or not you want to check the I/O signals which are set on the following pages.

Setting: 0 The status of the I/O signals are not recorded even if the ON/OFF status of them are changed.

1 The I/O signals set on page 2 and later are scanned and if ON/OFF status of any of these signals is changed, the new status is recorded.

Page 2 - Page 5

For the operation history, 16-byte signals (128 signals) are scanned for input and output respectively, and if ON/OFF status of any of the I/O signal has been changed, it is displayed in the following format. □□ corresponds to 1-byte signal (8 signals) (□ = 0 - 9, A - F)

```

INPUT  □□□□□□□□ □□□□□□□□ □□□□□□□□ □□□□□□□□
        1  2  3  4  5  6  7  8  9 10 11 12 13 14 15 16

OUTPUT □□□□□□□□ □□□□□□□□ □□□□□□□□ □□□□□□□□
        1  2  3  4  5  6  7  8  9 10 11 12 13 14 15 16
    
```

On pages 2 and 3, input signals are set and on pages 4 and 5, output signals are set.

```

**----- Set the I/O signal which corresponds to (1) above.
--**----- Set the I/O signal which corresponds to (2) above.
---**----- Set the I/O signal which corresponds to (3) above.
----**----- Set the I/O signal which corresponds to (4) above.
-----**----- Set the I/O signal which corresponds to (5) above.
----- **----- Set the I/O signal which corresponds to (6) above.
----- --**----- Set the I/O signal which corresponds to (7) above.
----- ---**----- Set the I/O signal which corresponds to (8) above.
----- ----**----- Set the I/O signal which corresponds to (9) above.
----- -----**----- Set the I/O signal which corresponds to (10) above.
----- -----**----- Set the I/O signal which corresponds to (11) above.
----- -----**----- Set the I/O signal which corresponds to (12) above.
----- -----**----- Set the I/O signal which corresponds to (13) above.
----- -----**----- Set the I/O signal which corresponds to (14) above.
----- -----**----- Set the I/O signal which corresponds to (15) above.
----- -----**----- Set the I/O signal which corresponds to (16) above.
    
```

(2) SS-NO.

Explanation: The slave station where I/O signals are scanned is set.

Setting: The slave station is selected by a number (1 - 128). If "0" is set, I/O signals of that slave station are not scanned.

(3) STROBE-NO.

Explanation: One strobe corresponds to 1-byte signal (8 signals). Since a slave station has four strobes, it is necessary to specify the strobe to scan.

Setting: The strobe is selected by a number (1 - 4). If "0" is set, I/O signals (8 signals) of the corresponding strobe are not scanned.

(4) BIT (HEXA)

Explanation: Which of the signal of the strobe specified in (2) should be scanned is set.

This setting can be effectively used to ignore the signals whose I/O status changes frequently under normal operating conditions, blinking LEDs for example, or to select only specific signals to be scanned within a strobe.

Setting: This setting is designated in hexadecimal notation (00 to FF). Set the bit value of a signal to be scanned to "1" and the bit value of a signal which is not to be scanned to "0".

Note: If you press function key [F7] (QUIT) after carrying out the following operation, the history data of the operation history (I/O signals) is cleared.

- *The setting on page 1 (MAKE SETTING ON NEXT PAGE VALID?) is changed.*
- *The setting on any of pages 2 to 5 is changed while the setting on page 1 remains unchanged.*

If function key [F5] (CANCEL) is pressed, pages 1 to 5 revert to the previous state and the history data of the operation history (I/O signals) is not cleared.

The sampling cycle (scanning intervals), data input method, and detailed information on the individual variables, which are set on the VARIABLES screen, are explained below.

Page 1:

(1) SAMPLING CYCLE (SEC)

Explanation: The variables history is created by scanning the variables in the NC in fixed intervals. The scanning interval is set for "SAMPLING CYCLE (SEC)".

Setting: Set the scanning interval in units of seconds (up to four digits right to a decimal point).

If the set value is smaller than the base control cycle, sampling is executed in the base control cycle.

If the set value is not a multiple of the base control cycle, sampling is executed in the intervals of a multiple of base control cycle.

(2) DATA INPUT

Explanation: The variables to be scanned can be specified; whether the variables which are set on page 2 should be scanned or those predetermined should be scanned.

The predetermined variables:

Variable 1 Variable which represents the start status (0=not started, 1=started)

Variable 2 Variable which represents the operating status (0=not operating, 1=operating)

Variable 3 Variable which represents the cutting status (0=not cutting, 1=cutting)

Variable 4 Variable which represents the reason for not-operating (0=in-process setup, 1=no operator, 2=waiting for part, 3=maintenance, 4=others)

Setting: 0 Variables set on page 2 are checked.

1 Predetermined variables are checked.

Page 2:

(3) ADDRESS

Explanation: The addresses of variables ?1 - ?D (?=A - D) are set. Remember that whether the address can be referenced or not is not checked.

If "*****" is displayed for the address on the variables history screen, it indicates that the set address cannot be referenced.

Setting: The address should be set in hexadecimal. If "0" is set, the corresponding variable is not checked.

(4) SIZE

Explanation: The sizes of variables ?1 - ?D (?=A - D) are set.

Setting: The size should be set in the number of bytes. Input the data following the instructions displayed on the screen.

(5) FORM

Explanation: The attributes of variables ?1 - ?D (?=A - D) are set.

Setting: Input the data following the instructions displayed on the screen.

(6) DISPLAY

Explanation: How the variables ?1 - ?D (?=A - D) are displayed is set.

Setting: Input the data following the instructions displayed on the screen.

Note 1: If combination of the setting of Form, Size, and Display is incorrect, the function cannot be ended even when function key [F7] (QUIT) is pressed. (Correct combination)

Form	Size	Display
1: Integer	1	1: Binary 2: Decimal 3: Hexadecimal 4: Decimal with decimal point
1: Integer	2 4	2: Decimal 3: Hexadecimal 4: Decimal with decimal point
2: Floating-point number 3: Double precision floating-point number	8	2: Decimal 4: Decimal with decimal point

Note 2: If function key [F7] (QUIT) is pressed, the history data of variable history is cleared unconditionally. Use function key [F5] (CANCEL) if you have not changed the data.

SECTION 18 LIST OF OUTPUT MESSAGES

On the Main Screen:

- (1) (0=IN-PROCESS SETUP, 1=NO OPERATOR, 2=PART WAIT, 3=MAINT, 4=OTHER)
WHICH NOT OPERATING

If you press function key [F1] (WHICH NON OP) at the main screen of the cell operation management function, this message is displayed. Input the number heading the corresponding item using the number key. To cancel the inputting of the reason for not-operating status, simply press the WRITE key. The processing restarts without changing the reason for not-operating status.

On the MEMO DISPLAY, JOB PROCEDURE DISPLAY, and MACHINING PREPARATION Screens:

- (1) CANNOT DETERMINE THE NAME OF MEMO FILE.

This message is displayed if you switch the display to the MEMO DISPLAY screen before reading any memo files. When the screen is changed to the MEMO DISPLAY screen, the system attempts to read the previously read memo file. The system fails to read in this attempt if no memo files have been read. Once a memo file is read, this message will not appear. However, if you clear the file registered as the memo file by selecting the program operation mode, this message will be displayed when you switch the display to the MEMO DISPLAY screen.

- (2) CANNOT DETERMINE THE NAME OF JOB PROCEDURE FILE.

This message is displayed if you switch the display to the JOB PROCEDURE DISPLAY screen before reading any job procedure files. When the screen is changed to the JOB PROCEDURE DISPLAY screen, the system attempts to read the previously read job procedure file. The system fails to read in this attempt if no job procedure files have been read. Once a job procedure file is read, this message will not appear. However, if you clear the file registered as the job procedure file by selecting the program operation mode, this message will be displayed when you switch the display to the JOB PROCEDURE DISPLAY screen.

- (3) CANNOT DISPLAY MAXIMUM NUMBER OF LINES EXCEEDED.

This message is displayed if the file (memo file or job procedure file) currently read exceeds 1280 pages (17920 lines). When this message is displayed while the screen is scrolled, scrolling toward the end of the file is disabled. In this case, however, scrolling to the start of the file is allowed.

- (4) ERROR IN INPUT DATA.

This message is displayed if a command, not conforming to the format, is given while a file is read. For example, the message is displayed if you execute the previous command which was created in other screen. When this message is displayed, it is necessary to create a correct command.

- (5) FILE NAME NEEDED TO READ MACHINING PROGRAM.

This message is displayed if you omit a file name when reading a machining program file by displaying the MACHINING PREPARATION screen. In the MEMO DISPLAY and JOB PROCEDURE DISPLAY screens, if you omit a file name, the file previously read is re-displayed. However, the file name must be specified when reading a machining program.

(6) ERROR IN SPECIFIED FILE NAME.

This message is displayed if you specify a device name other than the floppy disk drive or a path or file name which does not conform to MS-DOS rule when reading a file. It is also displayed when a file name does not conform to the OSP rule because the read file is stored to the NC memory. If this message is displayed, create the correct command.

(a) Device name

FD0: to FD9: Other device name is not acceptable.

(b) Path name

- 1) Alphanumeric characters of up to 56 characters, preceded and followed by the back slash (\) code. The directory beneath the specified path must conform to the MS-DOS rule.
- 2) Lower case characters are not acceptable.

(c) File name

- 1) A main file name is alphanumeric characters of up to 16 characters, beginning with an alphabetic letter.
- 2) An extension is alphanumeric characters of up to 3 characters, beginning with an alphabetic letter. An extension is specified following a main file name using a period for a delimiter.
- 3) Lower case characters are not acceptable.

(7) SPECIFIED FILE DOESN'T EXIST.

This message is displayed if you specify a file name or path name which does not exist when reading a file. If this message is displayed, check and correct the command.

(8) ERROR DURING FILE INPUT.

This message is displayed if the system fails to read a file. Probable cause is defective floppy disk; change the floppy disk to a new one.

(9) CANNOT INPUT SELECTED FILE.

This message may be displayed if you specify the same file name as the one used for the main program selected presently when reading a file (for machining centers). If this message is displayed, change the file name to be read.

(10) SPECIFIED FILE ALREADY EXISTS. OVERWRITE? (Y/N)

This message is displayed if you specify the same file name as the one used for the file resident in the NC memory (MD1:).

If the existing file may be updated, input Y, or if the existing file should be remained in the memory, input N. Then, press the WRITE key.

(11) FLOPPY DISK FORMAT IS INCOMPATIBLE.

This message is displayed if the floppy disk is neither MS-DOS format nor OSP format when reading a file from the floppy disk.

Use the floppy disk formatted in MS-DOS or OSP.

(12) CANNOT INPUT WRITE PROTECT.

This message is displayed if you specify the same file name as the name of the write-protected file. If this message is displayed, change the file name of the file to be read.

On the REPORT and TROUBLESHOOTING INFORMATION Screens:

(1) PRINT OUT DATA? (Y/N)!

This message is displayed requesting your confirmation when you pressed function key [F5] (PRINTER OUTPUT).

To output the data to the printer, first make sure that the printer is ready and press [Y] and WRITE keys. If you do not want to output the data to the printer, press [N] and WRITE keys.

(2) OUTPUT DATA? (Y/N)!

This message is displayed requesting your confirmation when you press function key [F6] (DATA OUTPUT).

To output the data to the floppy disk, first make sure that a floppy disk is set in the drive and press [Y] and WRITE keys. If you do not want to output the data to the floppy disk, press [N] and WRITE keys.

(3) SPECIFIED FILE ALREADY EXISTS. OVERWRITE? (Y/N)

This message is displayed if you specify the same file name as the one used for the file existing in the floppy disk.

If the existing file may be updated, input Y, or if the existing file should be remained in the floppy disk, input N. Then, press the WRITE key.

(4) FLOPPY DISK FORMAT IS INCOMPATIBLE.

This message is displayed if the floppy disk is neither MS-DOS format nor OSP format when reading a file from the floppy disk.

Use the floppy disk formatted in MS-DOS or OSP.

(5) ERROR DURING FILE OUTPUT.

This message is displayed if the system fails to output a file to the floppy disk. Probable cause is defective floppy disk; change the floppy disk to a new one.

On the CURRENT NC STATUS and OPERATION HISTORY (I/O SIGNAL) Screens:

(1) DATA HAS BEEN OUTPUT.

OUTPUT FILE REQUIRED FOR I/O SIGNAL ANALYSIS?(Y/N)

When you press function key [F6] (DATA OUTPUT), the data is output and then this message is displayed after the completion of data output to ask you if you want output of a file which is necessary for I/O analysis.

For the current NC status (only when 60001:FN-IODT is selected) and operation history (I/O signals), the ON/OFF status of I/O signals is described in hexadecimal.

This file is necessary if you want to analyze the I/O signals in the same manner as with the check data display in automatic operation mode.

(2) OUTPUT FILE REQUIRED FOR I/O SIGNAL ANALYSIS?(Y/N)

If there is more than one file which is necessary for I/O signal analysis, this message is displayed for the second and later files.

On the HISTORY Screens:

(1) SAMPLING STOPPED. RESTART SAMPLING? (Y/N)!

When you press function key [F5] (PRINTER OUTPUT) or [F6] (DATA OUTPUT) to output the data to the printer or floppy disk, this message is displayed after the completion of data output to ask you if you want to restart data collection.

To restart data collection, press [Y] and WRITE keys. If you do not want to restart data collection, press [N] and WRITE keys.

Note: On the VARIABLES HISTORY screen, data collection is suspended in the same manner while the data is output. However, data collection restarts automatically after the completion of data output.

On the PREFERENCE SETTINGS Screen:

(1) ERROR IN INPUT DATA.

This message is displayed if the input data is outside the specified range.

If this message is displayed, check if you followed the instruction to input the data and also the file name if it is correct.

(2) ERROR IN SIZE, FORM, DISPLAY ATTRIBUTE COMBINATION.

In the second and later pages of variables A to D, the system checks the combination of the size, attribute and display attribute which have been input when you press function key [F7] (QUIT) or a page key. This message is displayed if the combinations of the input data are incorrect. If this message is displayed, input the data correctly.

Note: If "0" is set for address, data combination check is no made because data collection is not made for such variables.

SECTION 19 OUTPUT FILES

(1) Daily Machining Report (Text File)

Date of today : If DAILY REPORT (TODAY) is output
Date of previous day : If DAILY REPORT (PRE DAY) is output

Machine name displayed at the upper left area on the MacMan mode screen

Date and time at which a function key was pressed

```
DAILY MACHINING REPORT [1994/07/30]
MACH NAME:MC.NAME
DATE/TIME:1994/07/30 10:30:54

#MS-100-DW
START DAY      TIME      NO. WORK  OPER %    RUN   OPERATE   CUT   CYCLE   MACHINE
P1.MIN         OP001
94/07/30      9:03:49      2        30       881   272      270   440    135
P2.MIN         OP002
94/07/30      8:51:40      2        60       729   444      399   364    222
P3MIN         OP003
94/07/30      8:33:08      1        69      1112   777      698  1112    777
P4.MIN         OP004
94/07/30      8:20:00      4        11       788   90       60   197    22
#ME-100-DW
```

Upper line: File name and program name of the selected main program
Lower line: Report data (time data is displayed in units of seconds)

(2) Daily Machining Report (Work Sheet)

Date of today : If DAILY REPORT (TODAY) is output
Date of previous day : If DAILY REPORT (PRE DAY) is output

Machine name displayed at the upper left area on the MacMan mode screen

Date and time at which a function key was pressed

DAILY MACHINING REPORT: 1994/07/30		MACH NAME: MC. NAME		DATE/TIME: 1994/07/30 10:30:54						
MAIN PROGRAM FILE	MAIN PROGRAM NAME	START DAY	START TIME	NO. OF WORK	OPERATING %	FEEDING	OPERATING	CUTTING	CYCLE TIME	MACHINING
P1.MIH	0P001	94/07/30	9:03:49	2	30	881	272	270	440	136
P2.MIH	0P002	94/07/30	8:51:40	2	60	729	444	399	364	222
P3.MIH	0P003	94/07/30	8:33:08	1	69	1112	777	698	1112	777
P4.MIH	0P004	94/07/30	8:20:00	4	11	788	90	60	197	22

Display and analysis is possible using Lotus 1-2-3 (R2)
In the file, line data is not included.

(3) Period Machining Report (Text File)

Machine name displayed at the upper left area on the MacMan mode screen

Date and time at which a function key was pressed

```
PERIOD MACHINING REPORT
MACH NAME:MC.NAME
DATE/TIME:1994/07/30 10:30:54

=MS-100-TW
START DAY      TIME      NO. WORK  OPER %    RUN   OPERATE   CUT    CYCLE    MACHINE
P1.MIN         OP001
94/07/30      9:03:49      2        30       881    272      270    440     136
P2.MIN         OP002
94/07/30      8:51:40      2        60       729    444      399    364     222
P3MIN         OP003
94/07/30      8:33:08      1        69       1112   777      698    1112    777
P4.MIN         OP004
94/07/30      8:20:00      4        11       78E    90       60     197     22
=ME-100-TW
```

Upper line: File name and program name of the selected main program
Lower line: Report data (time data is displayed in units of seconds)

(4) Period Machining Report (Work Sheet)

Machine name displayed at the upper left area on the MacMan mode screen

Date and time at which a function key was pressed

PERIOD MACHINING REPORT										
MACH NAME: MC-NAME										
DATE/TIME: 1994/07/30 10:30:54										
MAIN PROGRAM FILE	MAIN PROGRAM NAME	START DAY	START TIME	NO. OF WORK	OPERATING %	RUNNING	OPERATING	CUTTING	CYCLE TIME	MACHINING
P1.M1H	0P001	94/07/30	9:03:49	2	30	881	272	270	440	136
P2.M1H	0P002	94/07/30	8:51:40	2	60	729	444	399	364	222
P3.M1H	0P003	94/07/30	8:33:08	1	69	1112	777	698	1112	777
P4.M1H	0P004	94/07/30	6:20:00	4	11	788	90	60	197	22

Display and analysis is possible using Lotus 1-2-3 (R2)
In the file, line data is not included.

(5) Daily Operating Report (Text File)

Date of today : If DAILY REPORT (TODAY) is output
Date of previous day: If DAILY REPORT (PRE DAY) is output

Machine name displayed at the upper left area on the MacMan mode screen

Date and time at which a function key was pressed

```

DAILY OPERATING REPORT [1994/07/30]
MACH NAME:MC. NAME
DATE/TIME:1994/07/30 10:30:54
#MS-100-DM
      TIME NEEDED RUN BREAKDOWN
RUNNING          2118          100
OPERATING         375           17
CUTTING           200           53
NOT OPERATNG     1343           63
IN-PRO SETUP     210           15
NO OPERATOR      489           36
PART WAITING     454           33
MAINTENANCE      100            7
OTHER             90            6
SPINDLE RUN       70            3
EXTRNL INPUT      30            1
ALARM ON          34            1
#ME-100-DM
    
```

The ratio of NEEDED time of each item to total RUNNING time.

Time data is displayed in units of seconds.

(6) Daily Operating Report (Work Sheet File)

Date of today : If DAILY REPORT (TODAY) is output
Date of previous day : If DAILY REPORT (PRE DAY) is output

Machine name displayed at the upper left area
on the MacMan mode screen

Date and time at which a function key
was pressed

```
DAILY OPERATING REPORT [1994/07/30]
MACH NAME:MC.NAME
DATE/TIME:1994/07/30 10:30:54
      TIME NEEDED RUN BREAKDWN
RUNNING          2118          100
OPERATING         375           17
CUTTING           200           53
NOT OPERATING    1343           63
IN-PRO SETUP     210           15
NO OPERATOR      489           36
PART WAITING     454           33
MAINTENANCE      100            7
OTHER             90            6
SPINDLE RUN       70            3
EXTRNL INPUT     30             1
ALARM ON         34             1
```

Display and analysis is possible using Lotus 1-2-3 (R2)
In the file, line data is not included.

(7) Period Operating Report (Text File)

The date at which the PERIOD REPORT was cleared.
In this case, the report is made from 1993 April 01.

Machine name displayed at the upper left area
on the MacMan mode screen

Date and time at which a function
key was pressed

```
PERIOD OPERATING REPORT [1993/09/17]
MACH NAME:MC. NAME
DATE/TIME:1994/07/30 10:30:54
#MS-100-TM
      TIME NEEDED RUN BREAKDOWN
RUNNING          2118          100
OPERATING         375           17
CUTTING           200           53
NOT OPERATNG     1343           63
IN-PRO SETUP      210           15
NO OPERATOR       489           36
PART WAITING      454           33
MAINTENANCE       100            7
OTHER              90            6
SPINDLE RUN        70            3
EXTRNL INPUT       30            1
ALARM ON           34            1
#ME-100-TM
```

The ratio of NEEDED time of each item to
total RUNNING time.

Time data is displayed in units of seconds.

(8) Period Operating Report (Work Sheet File)

The date at which the PERIOD REPORT was cleared.
In this case, the report is made from 1993 April 01.

Machine name displayed at the upper left area
on the MacMan mode screen

Date and time at which a function
key was pressed

PERIOD OPERATING REPORT [1993/09/17]		
MACH NAME:MC. NAME		
DATE/TIME:1994/07/30 10:30:54		
	TIME NEEDED	RUN BREAKDWN
RUNNING	2118	100
OPERATING	375	17
CUTTING	200	53
NOT OPERATNG	1343	63
IN-PRO SETUP	210	15
NO OPERATOR	489	36
PART WAITING	454	33
MAINTENANCE	100	7
OTHER	90	6
SPINDLE RUN	70	3
EXTRNL INPUT	30	1
ALARM ON	34	1

Display and analysis is possible using Lotus 1-2-3 (R2)
In the file, line data is not included.

(9) Daily Operating History (Text File)

Date of today : If DAILY REPORT (TODAY) is output
Date of previous day : If DAILY REPORT (PRE DAY) is output

Machine name displayed at the upper left area
on the MacMan mode screen

Date and time at which a function key
was pressed

```
DAILY OPERATING HISTORY [1994/07/30]
MACH NAME:MC. NAME
DATE/TIME:1994/07/30 10:30:54
#MS-100-DH

<-00-><-01-><-02-><-03-><-04-><-05-><-06-><-07-><-08-><-09-><-10->
RUNNING -----*****
OPERAITNG -----*****
CUTTING -----** **
NOT OPERATING -----*** **
IN-PRO SETUP -----***
NO OPERATOR -----*
PART WAITING -----***
MAINTENANCE -----
OTHER -----***
SPINDLE RUN -----*****
EXTRNL INPUT -----
ALARM ON -----

NC was turned on at about 8:20 a.m.

NC was turned on at about 18:30.

<-11-><-12-><-13-><-14-><-15-><-16-><-17-><-18-><-19-><-20-><-21-><-22-><-23->
*****
*****
** *
***
***
*****
***
*****
*** **
*****
*** **
```

(10) Daily Operating History (Work Sheet File)

Date of today : If DAILY REPORT (TODAY) is output
Date of previous day : If DAILY REPORT (PRE DAY) is output

Machine name displayed at the upper left area on the MacMan mode screen

Date and time at which a function key was pressed

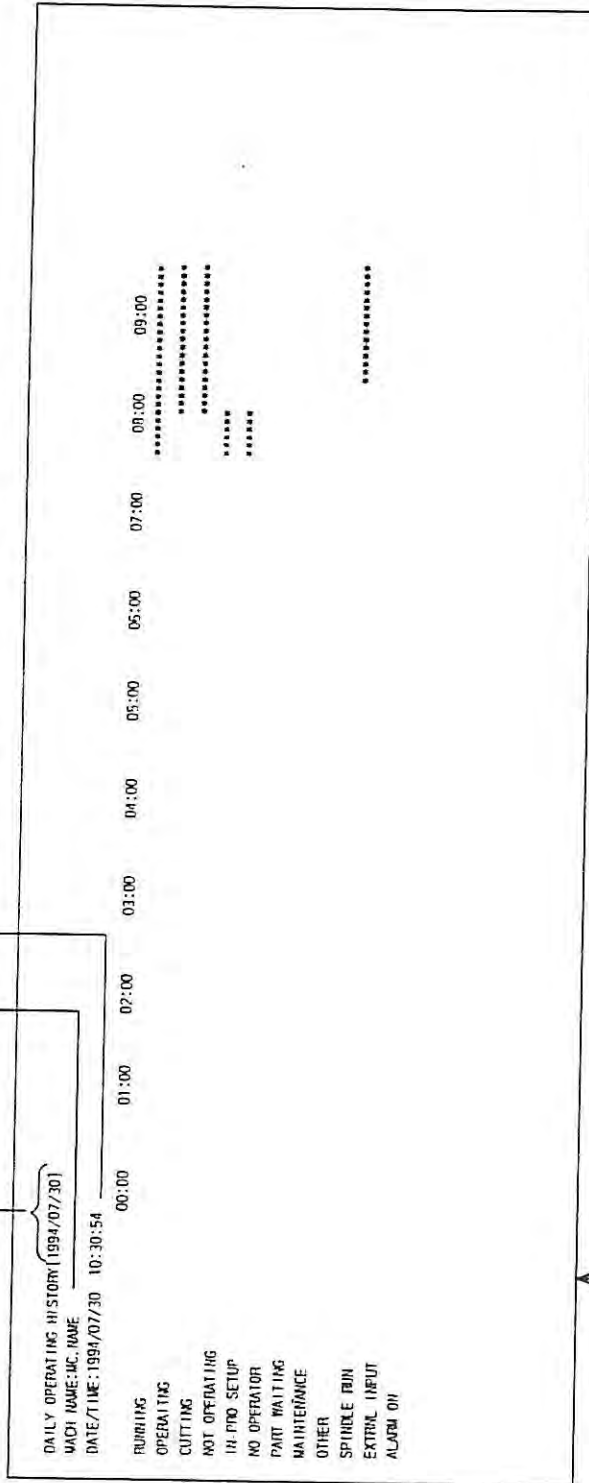

Display and analysis is possible using Lotus 1-2-3 (R2)
In the file, line data is not included.

(11) NC Status at Alarm (Text File)

Machine name displayed at the upper left area on the MacMan mode screen

Date and time at which a function key was pressed

Customer information (output example)

```
NC STATUS AT ALARM
MACH NAME :MC-NAME
DATE/TIME :1993/07/30 18:29:58
```

```
(000)MACH NAME
MC60VA
(001)MACH NO.
00354
(002)USER
ABC CORPORATION
(003)THE SEAT
(004)TELEPHONE
```

```
#MS-$$$-AN
DATE TIME ALARM NO. ALARM CODE ALARM CHAR STRINGS
93/07/30 13:32:50 1234-01 4
```

```
NC-ALARM
1 ORGOFST
X 0.000 Y 0.000 Z 0.000 4 0.000 5 0.000 6 0.000
2 LIMITPL
X 40000.000 Y 40000.000 Z 40000.000 4 0.000 5 0.000 6 0.000
3 LIMITMI
```

```
#ME-$$$-AN
```

Information related with the selected alarms; it includes day/time of occurrence, alarm number, code, and character-string.

NC status collected at the occurrence of the selected alarms (see the following page for details.)

The following gives the NC status data which are collected at an occurrence of an alarm.

Note: The data actually displayed depends on your machine and NC specifications.

[Lathe]

MANMDF	:	Manual mode status data
MPWFF	:	Main program write completed status data
ECINDATA	:	EC input data
ECOUTDATA	:	EC output data
RCON	:	Command value
HOMEP	:	Home position
RCONM	:	M-axis command value
RAPAM	:	M-axis actual value
ORGOF	:	Zero offset value
PRGPL	:	Program limit (plus)
PRGML	:	Program limit (minus)
NEGFSAA	:	Coordinate value in the minus area at the graphic front view
PLGFSAA	:	Coordinate value in the plus area at the graphic front view

[Machining center]

ORGOFST	:	System parameter/zero (machine) offset
LIMITPL	:	System parameter/plus travel limit
LIMITMI	:	System parameter/minus travel limit
PRLMTPL	:	User parameter/plus program travel limit
PRLMTMI	:	User parameter/minus program travel limit
WKCONO	:	Work coordinate system number used presently
WKORGOF	:	Work coordinate system offset used presently
LOCOSF	:	Local coordinate shift used presently
TLLNCRNO	:	Tool length offset number used presently
TLLNCR	:	Tool length offset data used presently
TLRDCRNO	:	Cutter radius compensation number used presently
TLRDCR	:	Cutter radius compensation data used presently
BLKCNT	:	Block counter data
ORDER	:	Coordinate value calculated by interpolation function (machine coordinate value)
TARGET	:	Target value in the command (machine coordinate value)
REST	:	Remaining distance to the target value (machine coordinate value)
UNIT	:	Unit movement distance calculated by interpolation function
TGTRC1 TO 3	:	History of target value (machine coordinate value) (collected in the order of TGTRC1 → TGTRC2 → TGTRC3 → TGTRC1)

[Machining center]

- RTTRC1 TO 3 : History of distance (machine coordinate value) to the target value
(collected in the order of RTTRC1 → RTTRC2 → RTTRC3 → RTTRC1)
- TRCWP : 0 = TGTRC1 and RTTRC1 indicate the latest data
4 = TGTRC2 and RTTRC2 indicate the latest data
8 = TGTRC3 and RTTRC3 indicate the latest data
- STMHLDF : Whether or not S, T, and M commands exist
(00 = command existing, 80 = command not existing)

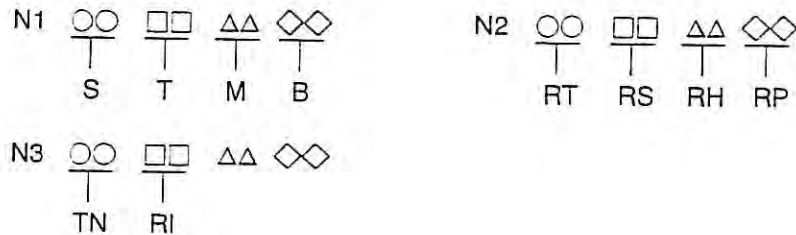

- EXS : Data specified by S code
- EXNT : Data specified by T code
- EXM : Data specified by M code
- GCODE1 : Presently valid G code data (hexadecimal)

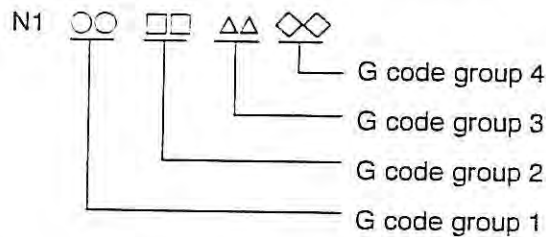

- GCODE2 : Presently valid G code data (hexadecimal)

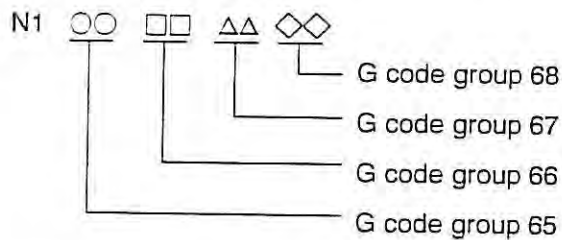

- MCODE : Presently valid M code data

[Machining center]

PRGMOD : 0 = Ordinary status
1 = During the execution of fixed cycle
2 = In the cutter radius compensation mode
3 = In the 3D tool length offset mode
4 = During the execution of area machining
5 = During movement to the home position
6 = During movement to the home position called by M code

NCTOEC : Communication data: From EC to NC

ECTONC : Communication data: From NC to EC

DIAGMSG1 TO 16 : Machine diagnosis message given at the time the alarm occurred

(12) Current NC Status (Text File)

Machine name displayed at the upper left area on
the MacMan mode screen

Date and time at which a function key
was pressed

Customer information (output example)

```
CURRENT NC STATUS
MACH NAME :MC-NAME
DATE/TIME :1993/07/30 18:29:58

(000)MACH NAME
MC60VA
(001)MACH NO.
00354
(002)USER
ABC CORPORATION
(003)THE SEAT
(004) TELEPHONE

#MS-$$$-CN
NC-ALARM
1 ORGOFST
X 0.000 Y 0.000 Z 0.000 4 0.000 5 0.000 6 0.000
2 LIMITPL
X 40000.000 Y 40000.000 Z 40000.000 5 0.000 6 0.000
3 LIMITMI
X -40000.000 Y -40000.000 Z -40000.000 4 0.000 5 0.000 6 0.000
4 PRLMTPL

#ME-$$$-CN
```

NC status collected at the time the function key
is pressed according to the selected data item

(13) Alarm History (Text File)

Machine name displayed at the upper left area
on the MacMan mode screen

Date and time at which a function key
was pressed.

```
ALARM HISTORY
MACH NAME:MC.NAME
DATE/TIME:1994/07/30 10:30:54
#MS-100-AL
  DATE      TIME      ALARM NO.  ALARM CODE  ALARM CHAR STRINGS
94/07/30  20:32:50  1234-01    23           BCID
94/07/30  18:21:56  2222       11
#ME-100-AL
```

(14) Console Line (Text File)

Machine name displayed at the upper left area
on the MacMan mode screen

Date and time at which a function key
was pressed.

```
OPERATION HISTORY: CONSOLE LINE
MACH NAME:MC.NAME
DATE/TIME:1994/07/30 10:30:54
#MS-100-CS
  DATE      TIME
94/07/30 10:24:12 =SET 2000
94/07/30 10:23:24 >CO FDO:A.MIN.MD1:
94/07/30 10:23:22 =PIP
#ME-100-CS
```

(15) Operation Panel (Text File)

Machine name displayed at the upper left area
on the MacMan mode screen

Date and time at which a function key
was pressed.

```
OPERATION HISTORY: OPERATION PANEL
MACH NAME:MC.NAME
DATE/TIME:1994/07/30 10:30:54
#MS-100-OP
  DATE      TIME
94/07/30 10:24:12 MODE [E8]
94/07/30 10:23:24 TURRET [E6]
94/07/30 10:23:22 CONTROL [OD]
#ME-100-OP
```

(16) I/O Signals (Text File)

Machine name displayed at the upper left area on the MacMan mode screen

SS-NO.,STRBE-NO.,BIT of I/O signals

Date and time at which a function key was pressed

```
OPERATION HISTORY : I/O SIGNALS
MACH NAME : MC-NAME
DATE/TIME : 1993/07/30 18:29:58

INPUT
000-0-00 001-1-01 002-2-0A 003-3-FF
032-1-BC 048-2-0F 128-2-D0 103-3-EF
001-4-FF 128-2-0A 102-1-EA 048-2-38
032-2-BC 048-3-FF 128-1-01 103-4-1A
OUTPUT
000-0-00 001-1-01 002-2-0A 003-3-FF
032-1-BC 048-2-0F 128-2-D0 103-3-EF
001-4-FF 128-2-0A 102-1-EA 048-2-38
032-2-BC 048-3-FF 128-1-01-103-4-1A

#MS-$$$-MP
  DATE      TIME
93/07/30 18:24:12 OUTPUT 800020E0 00000000 00010100 00000000
93/07/30 18:23:20 OUTPUT 800020E0 00000000 00000100 00000000
93/07/30 18:23:18 INPUT 81002000 01000200 00000000 00000000

          S

93/07/30 13:18:52 INPUT 81002000 03000200 00000000 00000000
93/07/30 13:18:50 OUTPUT 800020E0 00000000 00008000 00000000
#ME-$$$-MP
```

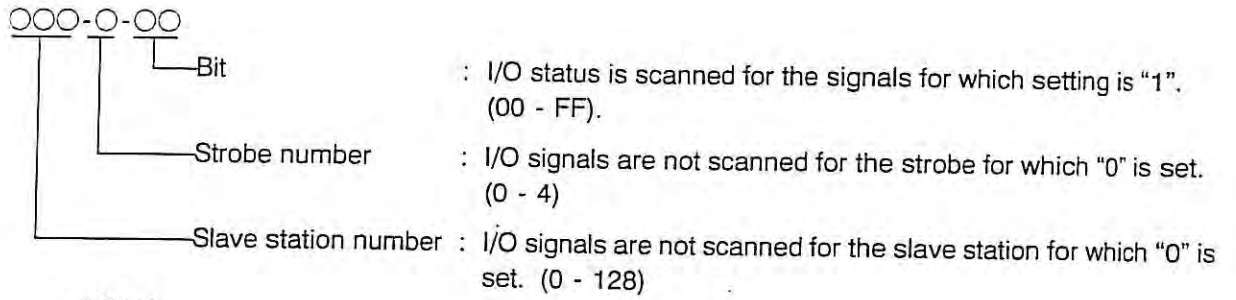

INPUT

000-1-00	000-2-00	000-3-00	000-4-00
000-5-00	000-6-00	000-7-00	000-8-00
000-9-00	000-10-00	000-11-00	000-12-00
000-13-00	000-14-00	000-15-00	000-16-00

OUTPUT

000-a-00	000-b-00	000-c-00	000-d-00
000-e-00	000-f-00	000-g-00	000-h-00
000-i-00	000-j-00	000-k-00	000-l-00
000-m-00	000-n-00	000-o-00	000-p-00

INPUT □□□□□□□□ □□□□□□□□ □□□□□□□□ □□□□□□□□

 1 2 3 4 5 6 7 8 9 10 11 12 13 14 15 16

OUTPUT □□□□□□□□ □□□□□□□□ □□□□□□□□ □□□□□□□□

 a b c d e f h i j k l m n o p q

(17) Variables History (Text File)

Machine name displayed at the upper left area
on the MacMan mode screen

Date and time at which a function key
was pressed.

```
VARIABLES HISTORY: A
MACH NAME:MC. NAME _____
DATE/TIME:1994/07/30 10:30:54 _____
#MS-100-VA
SAMPLE CYCLE (SEC) 86400.0000
ADDRESS 00081000 00081080 00001000 00001080
      DATE      TIME      VAR-A1      VAR-A2      VAR-A3      VAR-A4
94/07/30 10:24:12 00200340 999999.999 AAAAAAAAAA 00000000
94/07/30 10:23:24 00AE56AC ***** BBBB BBBB 01010101
94/07/30 10:23:22 00128000 23.000 XXXXXXXXXX 00001111
#ME-100-VA
```

LIST OF PUBLICATIONS

Publication No.	Date	Edition
4201-E	March 1998	1st

This manual may be at variance with the actual product due to specification or design changes.

Please also note that specifications are subject to change without notice. If you require clarification or further explanation of any point in this manual, please contact your OKUMA representative.

OKUMA OFFICES

DOMESTIC OFFICES

REGISTERED OFFICES

1-32 Tsujimachi, Kita-ku
Nagoya 462-0032, Japan

WORLD HEADQUARTERS-OGUCHI PLANT

Okuma Corporation
Oguchi-cho, Niwa-gun Aichi, 480-0193, Japan
Phone (0587) 95-7825 Fax (0587) 95-6074 Telex 4573310 OKUMA J

KANI PLANT

Okuma Corporation
3-6 Himegaoka, Kani-shi, Gifu-ken, 509-0249, Japan
Phone (0574) 63-5611 Fax (0574) 63-5678

OVERSEAS OFFICES

Okuma Corporation ,Melbourne Liaison Office
c/o Atlas CNC Machines Ltd. 3 Tampe Road Rowvill, Victoria 3178 Australia
Phone (03) 9753-2848 Fax (03) 9753-2020

Okuma Corporation Singapore Branch
422 Tagore Avenue Singapore 2678
Phone 4590819 Fax 4598276

OVERSEAS AFFILIATE

Okuma America Corporation
12200 Steele Creek Road, Charlotte, NC 28273, U.S.A.
Phone (704) 588-7000 Fax (704) 588-6503

OVERSEAS SUBSIDIARIES

Okuma Europe GmbH
Europark, Fichtenhain A20
47807 Krefeld , F.R. of Germany
Phone (49) 2151-374-0 Fax (49) 2151-374100

Okuma Service Center TPE
Tatung Co., 22 Chungshan N. Rd.,3rd Sec.Taipei, Taiwan, 10451 R.O.C
Phone (02) 673-6901 Fax (02) 673-6900

