

COMBIVERT F5

INSTRUCTION MANUAL



ELEVATOR DRIVE



00.F5.LUB-K140





Table of Contents

1. General	7	5.2 Loading The Configuration	52
1.2 Model number information	8	5.3 Setting The Control Type.....	53
1.3 Mounting instructions.....	9	5.4 Entering The Operating Data.....	53
1.3.1 Classification	9	5.5 Induction Motors	53
1.3.2 Physical Mounting	9	5.5.1 Motor Overload.....	53
1.3.3 Harsh Environments	9	5.5.2 Motor Data.....	54
1.4 Electrical connections	10	5.6 PM Synchronous Motors	55
1.4.4 Ambient Conditions	10	5.6.1 Motor Overload.....	55
1.4.1 Safety First.....	10	5.6.2 Motor Data.....	55
1.4.2 Voltage Supply	10	5.6.3 Auto-Tuning PM motors	56
1.4.3 Disconnect switch	11	5.7 Machine Data	58
1.4.4 Fusing.....	11	5.8 Encoder Feedback.....	58
1.4.5 Line Chokes	12	5.8.1 Encoder card verification	58
1.4.6 Motor Thermal Protection.....	13	5.8.2 Encoder serial com. verification	59
1.4.7 Motor Cable Length.....	13	5.8.3 Loading motor data from encoder	59
1.4.8 High Voltage Connections.....	14	5.8.4 Other encoder adjustments.....	60
1.4.9 Ground Connections.....	14	5.9 Controller Settings	60
1.4.10 High Frequency Shielding.....	15	5.10 Speed and Profile Settings	60
2. Technical Data	16	5.11 Running the Motor.....	61
2.1 Technical data 230V (size 13 to 21).....	16	5.11.1 Absolute Encoder Setup (no ropes)	61
2.2 Technical Data 460V (Size 13 to 19).....	18	5.11.2 Absolute Encoder Setup (with ropes)	63
2.2 Technical Data 460V (Size 20 to 26).....	20	5.11.3 Absolute Encoder Position Verification	65
2.3 Dimensions and weight	21	5.11.4 Encoder Synchronization	66
2.4 Summary of the power circuit terminals	22	6. Parameter Description	67
2.5 Connection of the power circuit.....	23	6.1 US-Parameters	67
2.6 Time dependent overload curve	25	Password	67
2.7 Low Speed Overload	26	LF Parameter Reset.....	67
3.0 Installation and Connection	27	Load Configuration	67
3.1 Control Circuit	27	Select Configuration	67
3.1.1 Terminal Strip Connections	27	Other US parameters	68
3.1.2 Connection of the control signals	28	6.2 LF-Elevator Parameters.....	69
3.1.3 Digital Inputs.....	28	Signal Operating Mode	69
3.1.4 Analog Inputs	28	Drive Configuration.....	73
3.1.5 Voltage Input / External Power Supply.....	29	Motor-Selection	73
3.1.6 Digital Outputs.....	29	Drive Fault Auto Reset.....	73
3.1.7 Relay Outputs	29	Electronic Motor Overload Protection.....	74
3.1.8 Analog Outputs	29	Electronic Overload Current	75
3.1.9 Voltage Output.....	29	Rated Motor Power.....	75
3.2 Encoder Connections	30	Rated Motor Speed.....	76
3.2.1 X3A RS422/TTL Incremental Encoder Input	30	Rated Motor Speed.....	78
3.2.2 X3A TTL Inc. Enc. In Screw Terminals	32	Rated Motor Current	78
3.2.3 X3A Hiperface Encoder	34	Rated Motor Frequency	78
3.2.4 X3A EnDat Encoder	38	Rated Motor Voltage	79
3.2.5 X3A SIN/COS-SSI Encoder	42	Power Factor	79
3.2.6 X3B Incremental Encoder Output	46	Field Weakening Speed	80
4. Operation of the unit	48	Rated Motor Torque	81
4.1 Digital Operator	48	Motor Stator Resistance	82
4.2 Parameter Identification.....	49	Motor Leakage Inductance	82
4.3 Parameter Selection	49	Contract Speed.....	83
4.4 Changing Parameter Values.....	50	Traction Sheave Diameter	83
4.5 Parameter Structure	50	Gear Reduction Ratio.....	83
4.6 Saving Parameter Values.....	51	Roping Ratio	84
4.7 Error Messages.....	51	Load Weight.....	84
5. Initial Start-up	52	Estimated gear ratio.....	84
5.1 Selecting The Configuration	52	Encoder Feedback	85
		Encoder Pulse Number.....	91
		Reverse Encoder	91
		Encoder Sample Time.....	91
		Control Method.....	92
		Kp Speed.....	93
		Ki Speed	93
		Ki Speed Offset.....	93
		Kp Current.....	94
		Ki Current.....	94
		Maximum Torque.....	94
		Open Loop Torque Boost.....	94
		Carrier Frequency	95

Tabel of Contents

Set Speed S_L , Leveling Speed	95	Peak current.....	115
Set Speed S_H , High Speed	95	Torque current.....	115
Set Speed S_I , Inspection Speed	95	DC bus voltage	115
Set Speed S_{HL} , High leveling Speed	96	Peak DC bus voltage.....	115
Set Speed S_{INT} , Intermediate Speed	96	Output Voltage.....	116
Starting Jerk	96	Input terminal state	116
Acceleration	97	Input terminal state	116
Deceleration Jerk	97	Output terminal state	116
Deceleration	97	Output flag state.....	117
Speed Following Error	98	Output status	117
Speed Difference	98	Active Parameter Set	117
Trigger Time Speed Difference	98	Analog pattern raw.....	117
Pre-torque Gain	99	Analog pattern processed	117
Pre-torque Offset.....	99	Analog pre-torque raw	118
Pre-torque Direction	99	Analog pre-torque processed	118
Speed Pick Delay.....	100	Analog option raw	118
Encoder Resolution Multiplier	101	Analog option processed	118
Absolute Encoder Position	102	Analog Out 1 preamp	118
Brake Drop Delay	103	Analog Out 1 post-amp.....	118
Current Hold Time	103	Analog Out 2 preamp	118
Software Version	104	Analog Out 2 post-amp.....	118
Software Date	104	Motor pot value.....	118
X2A Input State.....	105	Power module temperature	119
X2A Output State	106	Overload counter.....	119
Operation Mode	106	Power On counter	119
Inverter Load.....	107	Run counter	119
Motor Set Speed.....	107	Modulation grade	119
Actual Motor Speed.....	107	Timer 1.....	119
Actual Elevator Speed	107	Timer 1.....	119
Phase Current.....	108	Actual carrier frequency	119
Peak Phase Current	108	Motor temperature.....	119
Actual DC Voltage	108	Position counter	119
Peak DC Voltage.....	108	8.0 Advanced Adjustments	120
Actual Output Frequency	108	Parameter Access	120
Last Error	108	Comm error para address	120
6.3 Error Messages and their Cause.....	110	Comm error para data.....	120
Under voltage	110	E.OL2 Function.....	120
Overvoltage.....	110	Pre-torque timer ramp up	121
Over current.....	110	Pre-torque timer ramp down	121
Overload.....	110	Field Weakening Corner	122
Low speed overload.....	110	Speed for Max KI	123
Cool down phase completed.....	110	Speed for min KI.....	123
Inverter Overheat.....	111	Speed dependent KP gain	124
Motor Over Temperature	111	Min KP gain at high speed.....	124
Over Temperature Cooled Down	111	KD speed gain	124
Over Speed	111	Phase current check	125
DC Bus Charging Error.....	111	Encoder diagnostic	125
Encoder Failure	111	Power stage ID code	126
Encoder Signal Loss.....	111	Analog input noise clamp.....	126
Encoder Communication Error	112	HSP5 Watchdog time	126
Power Unit Code.....	112	Encoder R/W	126
Power Unit Code Changed	112	KP Synthesized Pre-torque	127
Error Current Check.....	112	KI Synthesized Pre-torque.....	127
Encoder Card Change.....	112	E.dOH Function	127
Encoder Card Invalid	112	Analog Pattern Gain.....	127
Inverter Status	113	9.0 Input/Output Configuration	128
Electronic Motor Overload	113	9.1 Digital Input Parameters	128
Bus Com. Fault	113	Input Type	128
Base Block Time.....	113	Noise Filter	128
7.0 Run Parameters	114	9.2 Digital Output Parameters	130
Inverter State	114	Output Inversion.....	130
Set Speed.....	114	Output X2A.18.....	130
Command Speed.....	114	Output X2A.19.....	130
Actual output frequency	114	Output X2A.24..26.....	130
Actual speed value	114	Output X2A.27..29.....	130
Encoder 1 speed.....	114	9.3 Timing Graph - Analog Control	132
Encoder 2 speed.....	114	9.4 Timing Graph - Digital Control	134
Commanded torque	115	10.0 Parameter List Reference	137
Actual torque	115	11.0 Customer Parameter Values.....	141
Actual load	115		
Peak load.....	115		
Phase current	115		



Danger to Life

AC motor controls and servo drives contain dangerous voltages which can cause death or serious injury. During operation they can have live "energized" un-insulated parts, moving parts, as well as hot surfaces. Care should be taken to ensure correct and safe operation in order to minimize risk to personnel and equipment.



Only Qualified Personnel

All work involving this product, installation, start up as well as maintenance may only be performed by qualified electrical technical personnel. According to this manual "qualified" means: those who are able to recognize and acknowledge the possible dangerous conditions based on their training and experience and those who are familiar with the relevant standards and installation codes as well as the field of power transmission.



Protect Against Accidental Contact

AC motor controls and servo drives must be protected against physical damage during transport, installation, and use. Components or covers must not be bent or deformed as this may decrease insulation distances inside the unit resulting in an unsafe condition. On receipt of the unit visual damage should be reported immediately to the supplier. **DO NOT ATTEMPT TO POWER UP A UNIT WITH VISIBLE PHYSICAL DAMAGE.** This unit contains electrostatically sensitive components which can be destroyed by in correct handling. For that reason, disassembly of the unit or contact with the components should be avoided.



Note Capacitor Discharge Time

Before any installation and connection work can be done the supply voltage must be turned off and locked out. After turning off the supply voltage, dangerous voltages may still be present within the unit as the bus capacitors discharge. Therefore it is necessary to wait 5 minutes before working on the unit after turning off the supply voltage.



Secure Isolation

The low voltage control terminal strip and communication ports are securely isolated in accordance with EN50178. When connecting to other systems, it is necessary to verify the insulation ratings of these systems in order to ensure the EN requirements are still met. When connecting the unit to a grounded delta power system, the control circuit can no longer be classified as a "securely isolated circuit".

Before putting the motor control into operation be sure the connection terminals are tight and all covers removed for installation have been replaced.



Damage to Property and Injury to Persons

The AC motor control or servo system can be adjusted to self initiate an automatic restart in the even of a fault or error condition. The design of the system must take this into account, such that personnel are safe guarded against potentially dangerous circumstances.



Redundant Safety Mechanisms

Software functions in the AC motor control or servo system can be used to control or regulate external systems. However, in the event of failure of the motor control or servo system there is no guarantee these software function(s) will continue to provide the desired level of control. As a result, when operator or machine safety is at stake, external elements must be used to supplement or override the software function within the AC motor control or servo system.



1. General

1.1 Product description

In selecting the COMBIVERT F5 series inverter, you have chosen a frequency inverter with the highest quality and dynamic performance.

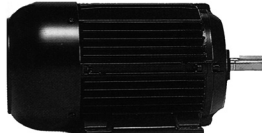

It is exclusively designed for smooth speed regulation of a three-phase motor.



The operation of other electrical loads is forbidden and can lead to destruction of the unit.

This manual describes the frequency inverter COMBIVERT F5.

- 10 hp...60 hp / 230V class
- 10 hp...175 hp / 460V class

CPU Software version 2.8 or 3.3
Application Software Version 1.4

The F5 inverter has the following features:

- small mounting footprint
- IGBT power circuit gives low switching losses
- low motor noise with high carrier frequency
- extensive protection for over- current, voltage and temperature
- voltage and current monitoring in static and dynamic operation
- short circuit proof and ground-fault proof
- noise immunity in accordance with IEC1000
- hardware current regulation
- integrated temperature controlled cooling fan
- uniform mounting pattern
- can be mounted side by side with zero clearance
- CE compliant and UL listed
- extensive functional capabilities

General

1.2 Model number information

Part Number

15.F5.M1G-RL00

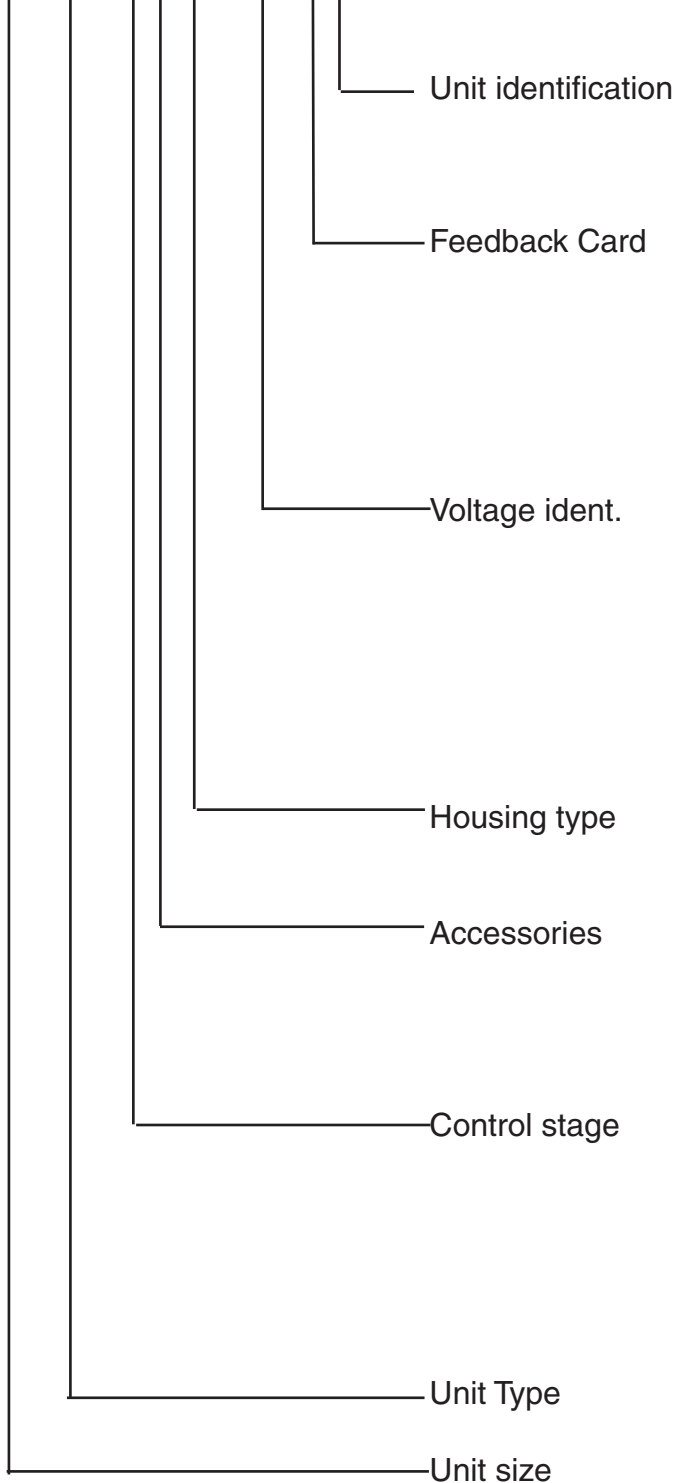

0 = software/function rev 0
 1 = software/function rev 1
 A = special hardware rev 0

0 = none installed at the factory
 D or B = TTL input, TTL output
 J = HTL input, TTL output
 M = SINCOS, TTL output
 F = HIPERFACE, TTL output
 P = ENDAT, TTL output
 V = Sin/Cos-SSI, TTL input
 Z = UVW, TTL input

R = 460V 3 Phase
 P = 230V 3 Phase
 L = KEB US Elevator Drive

E, G, H, R, U,

1 = Braking transistor
 3 = Braking transistor and EMI filter

M = Multi- supports all motors in closed loop speed and torque control
 A = Appl- supports all motors in closed loop speed, torque or position control. Additionally supports extended feedback types

F5

14 = 10 hp	19 = 40 hp	24 = 125 hp
15 = 15 hp	20 = 50 hp	
16 = 20 hp	21 = 60 hp	26 = 175 hp
17 = 25 hp	22 = 75 hp	
18 = 30 hp	23 = 100 hp	

1.3 Mounting instructions

1.3.1 Classification



- The elevator drive is classified as an "Open Type" inverter with an IP20 rating and is intended for "use in a pollution degree 2 environment." The unit must be mounted inside of a control cabinet offering proper environmental protection.

1.3.2 Physical Mounting

- Install the inverter in a stationary location offering a firm mounting point with low vibration.
- Installation of the inverter on moving system may require special earth ground connections to the inverter.
- For best high frequency grounding, install the inverter on a bare metal sub-panel, i.e. zinc plated steel or galvanized steel.
- Take into consideration the minimum clearance distances when positioning the inverter (see drawing below). The F5 series inverters are designed for vertical installation and can be aligned next to each other. Maintain a distance of at least 2 inches in front of the unit. Make sure cooling is sufficient.

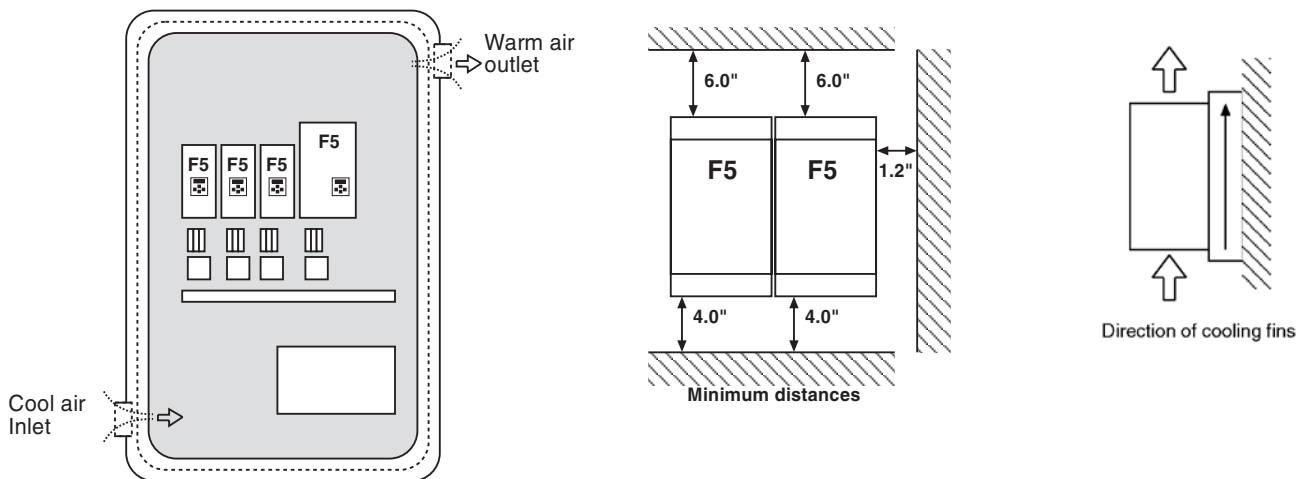

1.3.3 Harsh Environments

- For extended life, prevent dust from getting into the inverter.
- When installing the unit inside a sealed enclosure, make sure the enclosure is sized correctly for proper heat dissipation or that a cooling system has been installed in the panel.



- Protect the inverter against conductive and corrosive gases and liquids. Water or mist should not be allowed into the inverter.
- The F5 elevator drive inverter must be installed in an explosion-proof enclosure when operating in an explosion-proof environment.

1.3.4 Ambient Conditions



- Maximum Surrounding Air Temperature 45°C!** The operating temperature range of the unit is -10°C to + 45°C (14° to +113°F). Operation outside of this temperature range can lead to shut down of the inverter.
- The unit can be stored (power off) in the temperature range -25°C to 70°C (-13 to +158°F). After prolonged storage, one half year or more, apply voltage to the inverter for 2 hours before operating the motor. This will allow the electrolytic bus capacitors to stabilize before use and result in longer lifetime of the unit.
- The power rating of the inverter must be derated for operation above 3,300 ft (1000 m). Reduce the rated power 1% for each additional 330 ft (100 m). The maximum elevation for operation is 6,560 ft (2000 m)
- The relative humidity shall be limited to 95% without condensation.

1.4 Electrical connections

1.4.1 Safety First



- CAUTION - RISK OF ELECTRIC SHOCK!** Always disconnect supply voltage before servicing the F5 Elevator Drive.
- After disconnecting the supply voltage, always wait 5 minutes before attempting to change the wiring. The internal DC BUS capacitors must discharge.

1.4.2 Voltage Supply

- The F5 series inverters are suitable for use on a circuit capable of delivering not more than 10,000 rms symmetrical amperes, 480 volts maximum.

Pay attention to the supply voltage and be sure the supply voltage matches

- that of the inverter. A 230V unit can be supplied with voltage in the range 180 to 260VAC +/-0%, for a 460V unit the range is 305 to 500VAC +/- 0%, 48Hz to 62 Hz.



- Connection of the F5 series inverters to voltage systems configured as a corner grounded delta, center tap grounded delta, open delta, or ungrounded delta, may defeat the internal noise suppression of the inverter. Increased high frequency disturbance in the machine and on the line may be experienced. A balanced, center grounded wye connection is always recommended. The three phase voltage imbalance must be less than 2% phase to phase. Greater imbalance can lead to damage of the inverter's power circuit.

1.4.3 Disconnect switch

- A disconnect switch or contactor should be provided as a means of turning off the supply voltage when the unit is not in use or when it must be serviced.
- Repetitive cycling on and off of the input supply voltage more than once every two minutes can lead to damage of the inverter.

1.4.4 Fusing



- Integral solid state short circuit protection does not provide branch circuit protection. Branch circuit protection must be provided in accordance with the Manufacturer Instructions, National Electrical Code and any additional local codes.
- Branch circuit protection for the F5 must be provided using the fuses as listed in the tables 1.4.4.1 and 1.4.4.2 below. BUSSMANN type FRS-R for 480V or FRN-R for 230V are the recommended class RK5 fuse.
- The minimum voltage rating for protection devices used with 230V inverters shall be 250VAC. The minimum voltage rating for protection devices used with 460V inverters shall be 600VAC.
- Fuses shall not be installed between the inverter and the motor.

Table 1.4.4.1 - 230V Units

Unit Size / Housing	UL Class RK5 Fuse Rating [A]	UL Class L Fuse Rating [A]	Semiconductor Fuse* / Rating [A]
13 / E	40	--	50 140 06 80 / 80
14 / G	50	--	50 140 06 100 / 100
15 / G , H	70	--	50 140 06 80 / 80
16 / H	90	--	--
17 / H	110	--	--
18 / R	125	--	--
19 / R	150	--	--
20 / R	175	--	--
21 / R	200	--	--

* Semiconductor fuses are manufactured by Siba Fuse Inc. When using this type of fuse, this is the model number of the fuse is the fuse that must be used.

Table 1.4.4.2 - 460V Units

Unit Size / Housing	UL Class RK5 Fuse Rating [A]	UL Class L Fuse Rating [A]	Semiconductor Fuse* / Rating [A]
13 / E	25	--	50 140 06 40 / 40
14 / E	30	--	50 140 06 50 / 50
14 / G	30	--	50 140 06 80 / 80
15 / E	40	--	50 140 06 80 / 80
15 / G, H	40	--	50 140 06 40 / 40
16 / G, H	50	--	50 140 06 63 / 63
17 / G, H	60	--	50 140 06 80 / 80
18 / H	70	--	50 140 06 80 / 80
19 / H	90	--	50 140 06 100 / 100
19 / R	90	--	--
20 / H	100	--	--
20 / R	100	250	--
21 / R	150	300	--
22 / R	175	400	--
23 / U	200	--	--
24 / U	225	--	--
26 / U	300	--	--

* Semiconductor fuses are manufactured by Siba Fuse Inc. When using this type of fuse, this is the model number of the fuse is the fuse that must be used.

1.4.5 Line Chokes



- A line choke with minimum 3% impedance is required for all 230 V inverters 50hp (size 20) and greater. A line choke with minimum 3% impedance is required for all 460V inverters 100hp (size 23) and greater.
- Installation of a line choke is recommended and can be used prevent nuisance errors and protection caused by voltage spikes. Additionally, the use of a line choke will double the operational lifetime of the unit.

1.4.6 Motor Thermal Protection

- The F5 series inverters are UL approved as a solid state motor overload protection device. It is necessary to adjust the current trip level in parameter LF.9 or LF.12. The function assumes the use of a non-ventilated motor. The function meets the requirements set forth in VDE 0660 Part 104, UL508C section 42, NEC 430 part C. See the description for parameter LF.9 for the trip characteristics.
- A motor winding sensor can also be used for additional safety and the highest level of protection. Either a normally closed contact (rating: 15V / 6mA) or a PTC (positive temperature coefficient) resistor can be connected to the T1, T2 terminals on the inverter. The thermal device should be connected as indicated on page 24.

1.4.7 Motor Cable Length

- In some conventional installations and many MRL applications, the motor can be a considerable distance (greater than 40 feet) from the elevator drive. Under these circumstances the long cable length can cause high voltage peaks or high dv/dt (rate of voltage rise) on the motor windings. Depending on the design of the motor, these can lead to damage of the motor winding. Therefore, in these installations use of a special dv/dt filter is recommended.

The standard approved solution is special output choke designed for use with the drive's 16kHz switching frequency and low inductance so as not to drastically influence the motor's equivalent circuit model.

There is one standard filter solution for motors rated up to 70A. The part number is U0.90.290-7501. For motors above 70A, please consult the manufacturer.

1.4.8 High Voltage Connections

- Always note inverter voltage, select appropriate over current protection devices, select disconnect device, and select proper wire size before beginning the wiring process. Wire the inverter according to NEC Class 1 requirements.
- The correct wire gauge for each size inverter can be selected from the charts on pages 12-19. The wire gauge is based on the maximum fuse rating for the inverter. The terminal tightening torque can be found for each unit in the same charts.
- Always use UL listed and CSA approved wire. Use 60/75°C copper conductors only for equipment rated 100 Amperes or less and use 75°C Copper Conductors only for equipment rated greater than 100 Amperes! Use minimum 300V rated wire with 230V systems and minimum 600V rated wire with 460V systems.
- To prevent coupling high frequency noise, the following wires must be spatially separated from each other a minimum distance of 8 inches (20 cm) when they are laid parallel to each other :
 - AC supply power and motor lines not connected to inverters
 - motor lines connected to inverters
 - control and data lines (low-voltage level < 48 V)
- When using EMI filters, use only the wire provided with the filter to connect the filter to the inverter. Do not add additional wire between the filter and the inverter as this will have a negative effect on the operation of the filter.

1.4.9 Ground Connections

- When working with high frequencies (> 1kHz) and power semiconductors it is recommended to make all ground connections with large exposed metal surfaces in order to minimize the ground resistance.
- The metal sub-plate the inverter is mounted on is regarded as the central ground point for the machine or the equipment. For best results use an unpainted, galvanized or plated sub-panel.
- An additional high frequency ground wire should be connected between the inverter and the sub-panel. Use a stranded wire (4 gauge) or a thick ground strap. This is in addition to the ground wire required by NEC.
- All ground connections should be kept as short as possible and as close as possible to the ground system, sub-panels.
- If other components in the system exhibit problems due to high frequency disturbances, connect an additional high frequency ground wire between them and the sub-panel.
- The EMI filter should be mounted to the inverter or as close as possible to the inverter and on the same sub-panel as the inverter. Good metallic surface contact to the sub-panel is required to provide adequate high frequency grounding of the filter.

1.4.10 High Frequency Shielding

- Use of shielded cable is recommended when high frequency emissions or easily disturbed signals are present. Examples are as follows:
 - motor wires connected to inverters: connect shield to ground at both the inverter and motor, NOTE the shield should never be used as the protective ground conductor required by NEC. Always use a separate conductor for this.
 - digital control wires: connect shield to ground at both ends.
 - analog control wires: connect shield to ground only at the inverter.

- The connection of meshed shields to the ground connection should **not** be done through a single strand or drain wire of the shield, but with metallic clamps to provide 360° contact around the surface of the shield to the ground point. Connection with a single wire from the braided shield reduces the effectiveness of the shield 70%. Metal conduit clamps work well for this. Be sure the fit is tight.
- Ridged metal conduit can be used as the shield of the motor wires. Always observe the following points :
 - remove all paint from the control cabinet and motor housing where the conduit is fastened
 - securely fasten all conduit fittings
 - run only the motor wires through the conduit, all other wires, high voltage AC and low voltage signal, should be pulled through a separate conduit.
 - connect the control panel to the Sub-panel with a heavy ground strap.
- If EMI filters are used, they should be mounted to the inverter or as close as possible to the inverter and on the same sub-panel as the inverter. Good metallic surface contact to the sub-panel is required to provide adequate high frequency grounding of the filter. Always use the shielding plate provided with the filter when connecting the filter to the inverter.
- Shielding of control wires:

If digital signal wires are terminated on a terminal block in the control panel, the shields should be firmly connected to the sub-panel on both sides of the terminal block.

The shields of digital signal wires originating outside the control cabinet which are not terminated on a terminal block, must be connected to the sub-panel at the point where the cable enters the control panel and at the inverter.

If the shield is terminated to the sub-panel within 8 inches (20cm) of the inverter, then the shield no longer needs to be connected to the inverter.

When using un-shielded signal wires, they should always be installed as a twisted pair (signal and common).

Low voltage signal wires should cross high voltage wires at right angles.

2. Technical Data

2.1 Technical data 230V (size 13 to 21)

Inverter Size	13	14	15	16	17
Recommended Motor Power [hp]	7.5	10	15	20	25
Housing size	E	E	G	G	H
Input Ratings					
Supply voltage [V]	180...260 ±0 (230 V rated voltage)				
Supply voltage frequency [Hz]	50 / 60 +/- 2				
Input phases	3	3	3	3	3
Rated input current [A]	28	36	55	59	75
Recommended wire gauge ¹ [awg]	10	8	8	6	4
Output Ratings					
Rated output power [kVA]	9.5	13	17	23	29
Rated motor power [kW]	5.5	7.5	11	15	18.5
Rated output current [A]	22	28	42	57	84
Peak current (30 seconds) ¹ [A]	36	49.5	72	86	99
Over current fault (E.OC) trip level [A]	43	59	86	104	118
Output voltage [V]	3 x 0...V input (3 x 0...255V ²)				
Output frequency [Hz]	Generally 0 to 1600Hz (limited by control board and carrier frequency)				
Rated switching frequency [kHz]	8	4	16	4	16
Maximum switching frequency [kHz]	16	16	16	8	16
Power loss at rated operation ⁷ [W]	290	350	330	330	430
Stall current at 4kHz [A]	24	33	33	36	53
Stall current at 8kHz [A]	24	24	33	31	53
Stall current at 16kHz [A]	16.8	16.8	33	26	53
Braking Circuit					
Min. braking resistance ⁴ [Ohm]	16	16	8.0	8.0	5.6
Typ. braking resistance ⁴ [Ohm]	27	20	20	13	13
Max. braking current [A]	25	25	50	50	70
Installation Information					
Max. shielded motor cable length ⁵ [ft]	330	330		330	330
Tightening torque for terminal strip [in lb]	11	11	11	35	35
Environmental					
Max. heat sink temperature TOH [°C]	90°C / 194°F				
Storage temperature [°C]	-25...70 °C / -13...158°F				
Operating temperature [°C]	-10...45 °C / 14...113°F				
Housing design / protection	Chassis / IP20 / Pollution Degree 2				
Relative humidity	max. 95% without condensation				
Approvals					
Tested in accordance with...	EN 61800-3 /UL508C				
Standards for emitted interference	EN 55011 Class B / EN 55022 Class A				
Standards for noise immunity	IEC 1000-4-2 / -3 / -4 / -5/ -6				
Climatic category	3K3 in accordance with EN 50178				



The recommended motor rating is for 4/6 pole standard motors. When using motors with different numbers of poles, the inverter must be dimensioned based on the motor rated current. Contact the manufacturer for special frequency motors.

The power rating of the inverter must be de-rated for operation above 3,300 ft (1000 m). Reduce the rated power 1% for each additional 330 ft (100 m). The maximum elevation for operation is 6,560 ft (2000 m)

Inverter Size	18	19	20	21
Recommended Motor Power [hp]	30	40	50	60
Housing size	R	R	R	R
Input Ratings				
Supply voltage [V]	180...260 ±0 (230 V rated voltage)			
Supply voltage frequency [Hz]	50 / 60 +/- 2			
Input phases	3	3	3	3
Rated input current [A]	88	115	143	170
Recommended wire gauge ³⁾ [awg]	3	1	2/O	3/O
Output Ratings				
Rated output power [kVA]	35	42	52	62
Rated motor power [kW]	22	30	37	45
Rated output current [A]	80	104	130	154
Peak current (30 seconds) ¹⁾ [A]	150	172	217	270
Over current fault (E.OC) trip level [A]	162	207	270	315
Output voltage [V]	3 x 0...V input (3 x 0...255V ²⁾)			
Output frequency [Hz]	Generally 0 to 1600Hz (limited by carrier frequency)			
Rated switching frequency [kHz]	8	8	8	8
Maximum switching frequency [kHz]	16	16	16	16
Power loss at rated operation ⁷⁾ [W]	1020	1200	1400	1700
Stall current at 4kHz [A]	110	123	160	198
Stall current at 8kHz [A]	100	115	145	180
Stall current at 16kHz [A]	70	70	101	101
Braking Circuit				
Min. braking resistance ⁴⁾ [Ohm]	4.7	3.9	2.0	2.0
Typ. braking resistance ⁴⁾ [Ohm]	5.6	4.7	3.9	3.0
Max. braking current [A]	85	102	160	160
Installation Information				
Max. shielded motor cable length ⁵⁾ [ft]	165			
Tightening torque for terminal strip [in lb]	53			
Environmental				
Max. heat sink temperature TOH [°C]	90°C / 194°F			
Storage temperature [°C]	-25...70 °C / -13...158°F			
Operating temperature [°C]	-10...45 °C / 14...113°F			
Housing design / protection	Chassis / IP20 / Pollution Degree 2			
Relative humidity	max. 95% without condensation			
Approvals				
Tested in accordance with...	EN 61800-3 /UL508C			
Standards for emitted interference	EN 55011 Class B / EN 55022 Class A			
Standards for noise immunity	IEC 1000-4-2 / -3 / -4 / -5/ -6			
Climatic category	3K3 in accordance with EN 50178			

1) This is the maximum
card.

2) This data pertains only to

3) The wire gauge is based on the maximum fuse rating, copper wire with a 75°C insulation rating, THHW or equivalent. If circuit protection is selected based on the rated input current, the wire size could be reduced.

4) This is the power
load will decrease this value.

5) Max motor cable length when using shielded cable, KEB EMI filter, and the installation must conform to EN55011 / EN55022.

Technical Data

2.2 Technical Data 460V (Size 13 to 19)

Inverter Size	13		14		15		
Recommended Motor Power [hp]	7.5		10		15		
Housing size	E	G	E	G	E	G	H
Input Ratings							
Supply voltage [V]	305...500 ±0 (460 V Nominal voltage)						
Supply voltage frequency [Hz]	50 / 60 +/- 2						
Input phases	3		3		3		
Rated input current [A]	15.4		19.6		27.3		
Recommended wire gauge ¹⁾ [awg]	12		10		10		
Output Ratings							
Rated output power [kVA]	8.3		11		17		
Rated motor power [kW]	5.5		7.5		11		
Rated output current [A]	11		14		21		
Peak current (30 seconds) ²⁾ [A]	21.6	18	29.7	24.8	36		
Over current fault (E.O.C) trip level [A]	25.9	21.6	35.6	29.7	43.2		
Output voltage [V]	3 x 0...Vsupply						
Output frequency [Hz]	Generally 0 to 1600Hz (limited by carrier frequency)						
Rated switching frequency [kHz]	8	16	8	16	4	8	16
Maximum switching frequency [kHz]	16	16	16	16	16	16	16
Power loss at rated operation ³⁾ [W]	250	200	320	260	350	290	360
Stall current at 4kHz [A]	12	12	16.5	16.5	24	24	24
Stall current at 8kHz [A]	12	12	16.5	16.5	16	19	24
Stall current at 16kHz [A]	12	12	10	12	10	8.4	15
Braking Circuit							
Min. braking resistance ⁴⁾ [Ohm]	39	50	39	39	39	22	
Typ. braking resistance ⁴⁾ [Ohm]	100		85		56		
Max. braking current [A]	21	15	21	21	21	37	
Installation Information							
Max. shielded motor cable length ⁵⁾ [ft]	300				330		
Tightening torque for terminal strip [in lb]	4.5	11	4.5	11	11	35	
Environmental							
Max. heat sink temperature TOH [°C]	90°C / 194°F						
Storage temperature [°C]	-25...70 °C / -13...158°F						
Operating temperature [°C]	-10...45 °C / 14...113°F						
Housing design / protection	Chassis / IP20 / Pollution Degree 2						
Relative humidity	max. 95% without condensation						
Approvals							
Tested in accordance with...	EN 61800-3 /UL508C						
Standards for emitted interference	EN 55011 Class B / EN 55022 Class A						
Standards for noise immunity	IEC 1000-4-2 / -3 / -4 / -5/ -6						
Climatic category	3K3 in accordance with EN 50178						



The recommended motor rating is for 4/6 pole standard motors. When using motors with different numbers of poles, the inverter must be dimensioned based on the motor rated current. Contact the manufacturer for special frequency motors.

The power rating of the inverter must be de-rated for operation above 3,300 ft (1000 m). Reduce the rated power 1% for each additional 330 ft (100 m). The maximum elevation for operation is 6,560 ft (2000 m)

Inverter Size	16		17		18		19	
Recommended Motor Power [hp]	20		25		30		40	
Housing size	G	H	G	H	H	R	H	R
Input Ratings								
Supply voltage [V]	305...500 ±0 (460 V Nominal voltage)							
Supply voltage frequency [Hz]	50 / 60 +/- 2							
Input phases								
Rated input current [A]	35		44		52		57	
Recommended wire gauge ¹⁾ [awg]	8		6		6		4	
Output Ratings								
Rated output power [kVA]	23		29		35		42	
Rated motor power [kW]	15		18.5		22		30	
Rated output current [A]	27		34		40		52	
Peak current (30 seconds) ²⁾ [A]	49.5		63		75		90	
Over current fault (E.OC) trip level [A]	59.4		75.6		90		108	
Output voltage [V]	3 x 0...Vsupply							
Output frequency [Hz]	Generally 0 to 1600Hz (limited by carrier frequency)							
Rated switching frequency [kHz]	8	16	4	8	8	16	8	8
Maximum switching frequency [kHz]	16	16	16	16	16	16	16	16
Power loss at rated operation ³⁾ [W]	310	490	360	470	610	850	540	750
Stall current at 4kHz [A]	33	42	42	42	60	50	60	60
Stall current at 8kHz [A]	21.5	33	21.5	42	50	50	54	60
Stall current at 16kHz [A]	9.5	20	-	25	30	40	36	27
Braking Circuit								
Min. braking resistance ⁴⁾ [Ohm]	25	22	25	22	13	9	13	9
Typ. braking resistance ⁴⁾ [Ohm]	39		28		22		16	
Max. braking current [A]	30	37	30	37	63	88	63	88
Installation Information								
Max. shielded motor cable length ⁵⁾ [ft]	330							
Tightening torque for terminal strip [in lb]	11	35	11	35	53	35	53	
Environmental								
Max. heat sink temperature TOH [°C]	90°C / 194°F							
Storage temperature [°C]	-25...70 °C / -13...158°F							
Operating temperature [°C]	-10...45 °C / 14...113°F							
Housing design / protection	Chassis / IP20 / Pollution Degree 2							
Relative humidity	max. 95% without condensation							
Approvals								
Tested in accordance with...	EN 61800-3 / UL508C							
Standards for emitted interference	EN 55011 Class B / EN 55022 Class A							
Standards for noise immunity	IEC 1000-4-2 / -3 / -4 / -5 / -6							
Climatic category	3K3 in accordance with EN 50178							

1) This is the maximum card.

2) This data pertains only to

3) The wire gauge is based on the maximum fuse rating, copper wire with a 75°C insulation rating, THHW or equivalent. If circuit protection is selected based on the rated input current, the wire size could be reduced.

4) This is the power load will decrease this value.

5) Max motor cable length when using shielded cable, KEB EMI filter, and the installation must conform to EN55011 / EN55022.

Technical Data

2.2 Technical Data 460V (Size 20 to 26)

Inverter Size	20	21	22	23	24	26		
Recommended Motor Power [hp]	50	60	75	100	125	175		
Housing size	H	R	R	R	U	U		
Input Ratings								
Supply voltage [V]	305...500 ±0 (460 V Nominal voltage)							
Supply voltage frequency [Hz]	50 / 60 +/- 2							
Input phases	3	3	3	3	3	3		
Rated input current [A]	72	86	105	150	189	254		
Recommended wire gauge ¹⁾ [awg]	4	3	1	2/O	3/O	350		
Output Ratings								
Rated output power [kVA]	52	62	80	104	125	173		
Rated motor power [kW]	37	45	55	75	90	132		
Rated output current [A]	65	77	96	136	172	231		
Peak current (30 seconds) ²⁾ [A]	135	112	135	172	225	270	375	450
Over current fault (E.O.C) trip level [A]	162	135	162	207	270	324	450	540
Output voltage [V]	3 x 0...Vsupply							
Output frequency [Hz]	Generally 0 to 1600Hz (limited by control board and carrier frequency)							
Rated switching frequency [kHz]	4	8	8	8	8	8	4	4
Maximum switching frequency [kHz]	16	16	16	8	8	8	8	12
Power loss at rated operation ³⁾ [W]	900	1100	1500	1900	2400	2800	2800	
Stall current at 4kHz [A]	83	83	99	115	165	198	330	330
Stall current at 8kHz [A]	83	75	81	115	150	180	180	225
Stall current at 16kHz [A]	45	34	45	63	-	-	-	125 ⁶⁾
Braking Circuit								
Min. braking resistance ⁴⁾ [Ohm]	9	9	9	5	4	4	4.0	
Typ. braking resistance ⁴⁾ [Ohm]	13	11	9	6	6	6	4.3	
Max. braking current [A]	88	88	88	160	200	200	200	
Installation Information								
Max. shielded motor cable length ⁵⁾ [ft]	165						165	
Tightening torque for terminal strip [in lb]	35	53	133	220				
Environmental								
Max. heat sink temperature TOH [°C]	90°C / 194°F						60°C	
Storage temperature [°C]	-25...70 °C / -13...158°F							
Operating temperature [°C]	-10...45 °C / 14...113°F							
Housing design / protection	Chassis / IP20 / Pollution Degree 2							
Relative humidity	max. 95% without condensation							
Approvals								
Tested in accordance with...	EN 61800-3 /UL508C							
Standards for emitted interference	EN 55011 Class B / EN 55022 Class A							
Standards for noise immunity	IEC 1000-4-2 / -3 / -4 / -5/ -6							
Climatic category	3K3 in accordance with EN 50178							

1) This is the control card.

3) The wire gauge is based on the maximum fuse rating, copper wire with a 75°C insulation rating, THHW or equivalent. If circuit protection is selected based on the rated input current, the wire size could be reduced.

4) This is or reduced load will decrease this value.

5) Max motor cable length when using shielded cable, KEB EMI filter, and the installation must conform to EN55011 / EN55022.

6) Value at 12kHz

2.3 Dimensions and weight

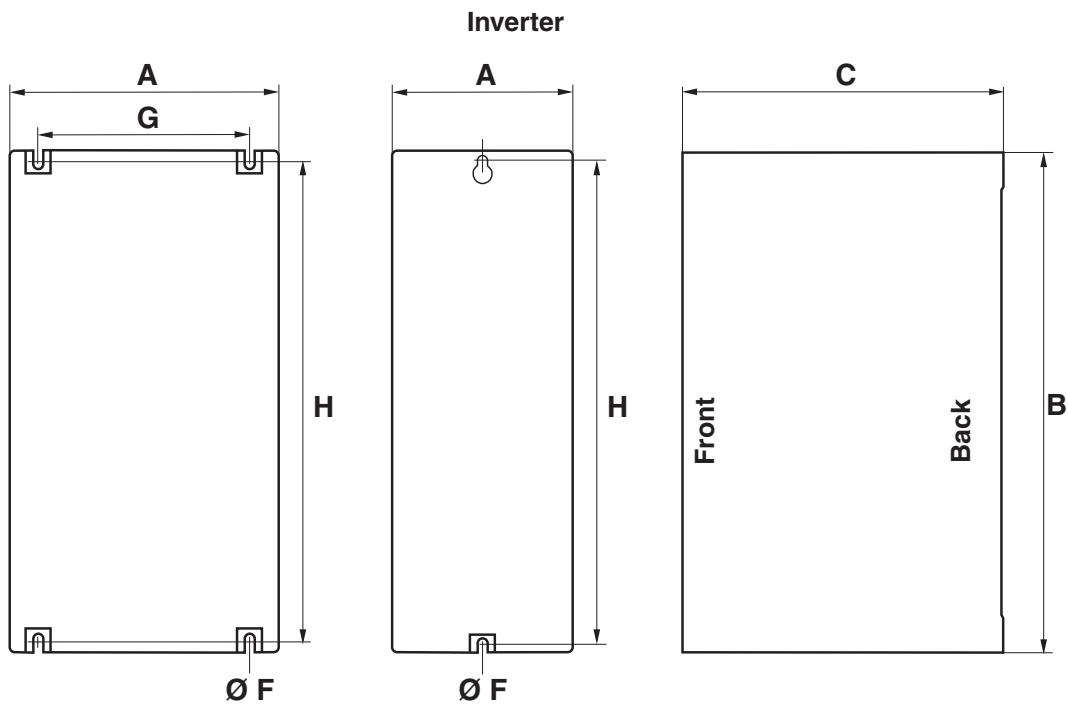

Dimensions in inches

Housing	A	B	B2	C	C2	F	G	H	Weight [lb]
E	5.12	11.4	-	8.75	-	0.28	-	10.8	11
G	6.7	13.4	-	10.0	-	0.28	5.9	13.0	22
H	11.7	13.4	-	10.0	-	0.28	9.8	13.0	31
R	13.5	20.5	-	14.0	-	0.394	11.8	19.5	55-64
U	13.5	31.5	-	14.0	-	0.394	11.8	30.5	165.5

Power Circuit Terminals

2.4 Summary of the power circuit terminals

Housing size E ⚠ Note always verify input voltage with name plate for proper connection

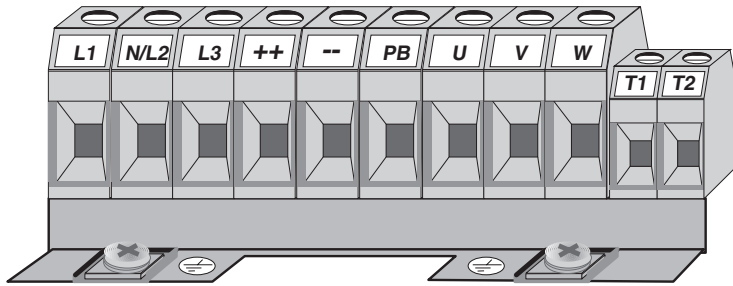

- L1, L2, L3** 3 phase supply voltage
- ++, --** Connection for DC supply
- ++, PB** Connection for braking resistor
- U, V, W** Motor connection
- T1, T2** Connection for temperature sensor
-  Connection for earth ground

Terminal Tightening Torque: 4.5 inlb

Housing size G ⚠ Note always verify input voltage with name plate for proper connection

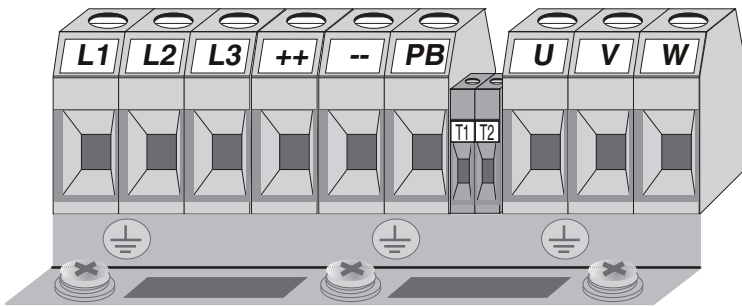

- L1, L2, L3** 3 phase supply voltage
- ++, --** Connection for DC supply
- ++, PB** Connection for braking resistor
- T1, T2** Connection for temperature sensor
- U, V, W** Motor connection
-  Connection for earth ground

Terminal Tightening Torque: 11 inlb

Housing size H ⚠ Note always verify input voltage with name plate for proper connection

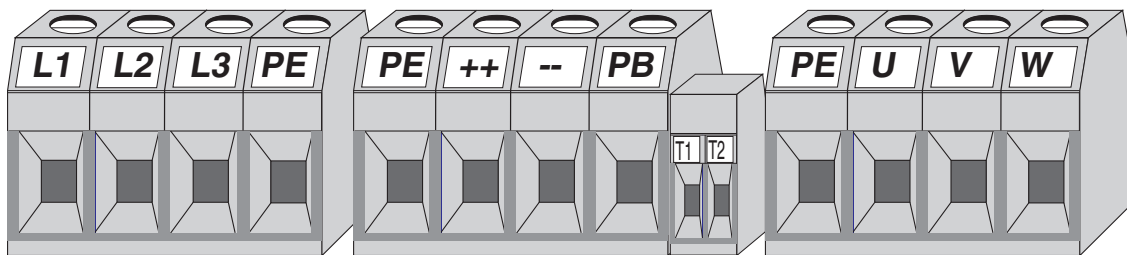

- | | | | |
|-------------------|---------------------------------|----------------|-----------------------------------|
| L1, L2, L3 | 3 phase supply voltage | T1, T2 | Connection for temperature sensor |
| ++, -- | DC supply connection | U, V, W | Motor connection |
| ++, PB | Connection for braking resistor | PE | Connection for earth ground |

Terminal Tightening Torque: 22 inlb

Housing size R and U **Verify input voltage with name plate for proper connection 230V or 460V**

Note always verify input voltage with name plate for proper connection

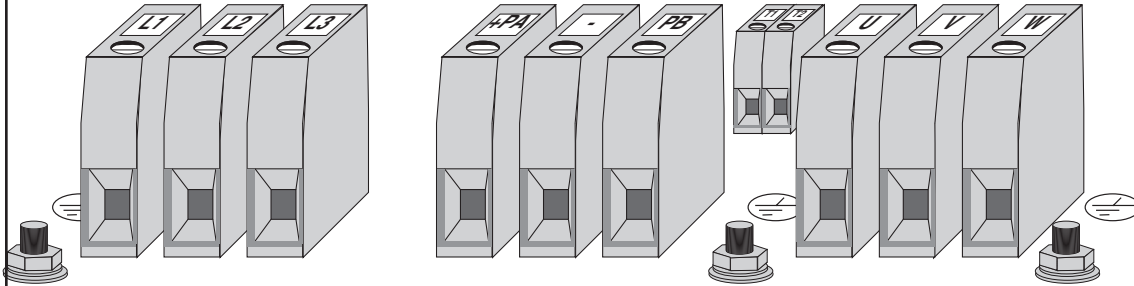

L1, L2, L3
+ +, - -
+ +, PB

3 phase supply voltage
DC supply connection
Connection for braking resistor

T1, T2
U, V, W

Connection for temperature sensor
Motor connection
Connection for earth ground

Terminal Tightening Torque: R housings 53 inlb
U housings size 23/24 130inlb
U housings sizes > 24 220 inlb

2.5 Connection of the power circuit

See technical data on pages 12-15 to match the wiring diagram to inverter size and housing type.

If the supply voltage is connected to the motor terminals, the unit will be destroyed!

Pay attention to the supply voltage 230/460V and the correct polarity of the motor!

Wiring diagram 1

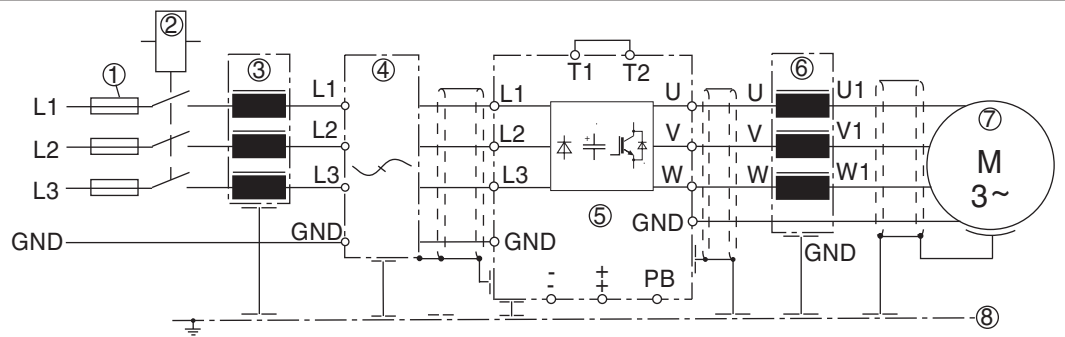

Wiring diagram

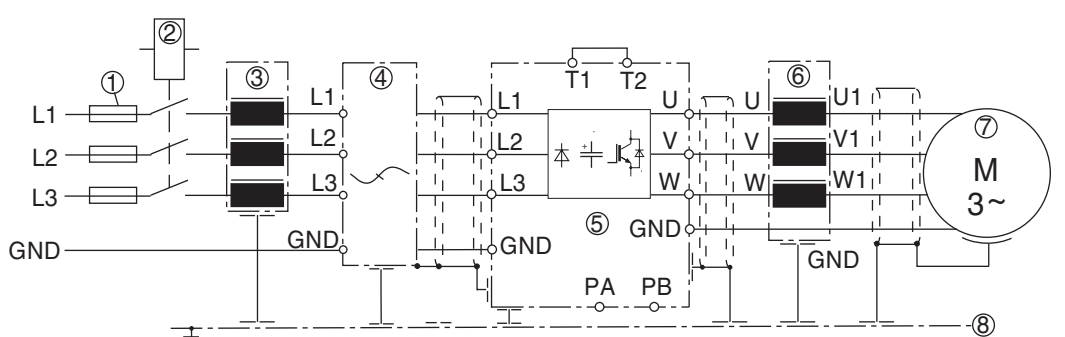

Connection of the Power Circuit

Wiring diagram 3

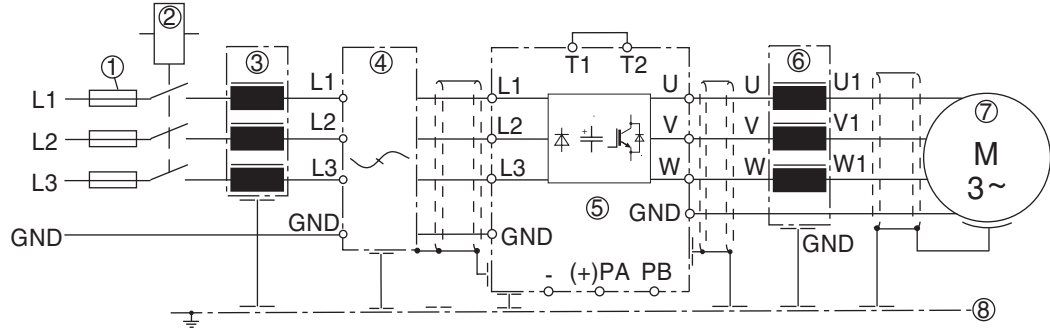

- | | |
|--|---------------------------------------|
| ① Supply fuse | ⑤ COMBIVERT F5 |
| ② Disconnect switch or contactor | ⑥ Motor choke or output filter |
| ③ Line choke | ⑦ Motor |
| ④ Interference suppression filter | ⑧ Sub panel in control cabinet |

External motor temperature sensor (for all units)

Don't install sensor wires with control wires!

Must use double shield when running these wires with motor wires!

It is necessary to activate this function via software parameter!

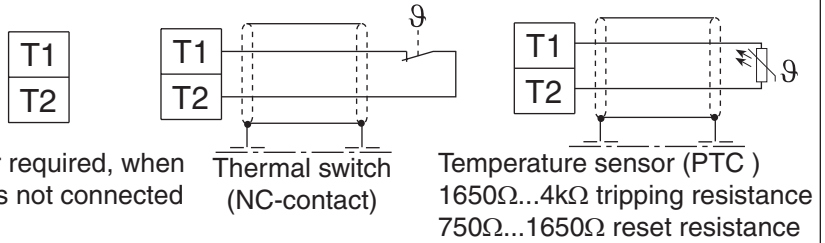

Connection of braking resistor (Braking circuit installed as standard in housing sizes E,G,H, R and U.)

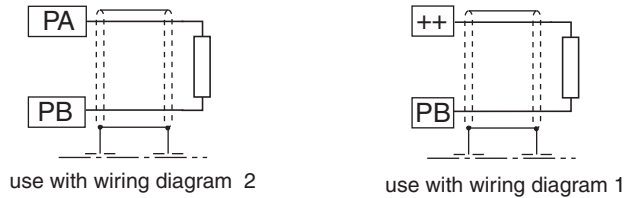

Braking resistor with line side over temperature cutoff



This is the only way to turn off voltage to the resistor in the event of failure of the internal braking transistor of the inverter.

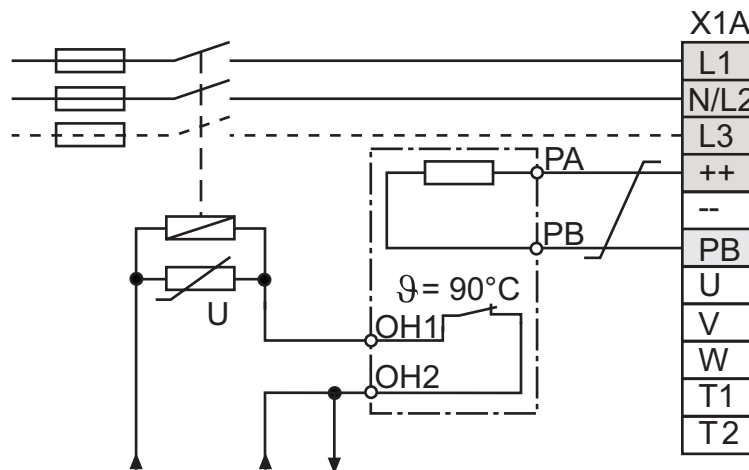

24VDC or 120VAC contactor control voltage

Note: a NC thermal switch not PTC device on the resistor is required.

2.6 Time dependent overload curve

If the load current exceeds the rated current but is below the over current level, an overload timer begins counting. The rate at which the timer increments is a function of load current. The higher the current the faster the increments. When the counter reaches the limit the fault E.OL is triggered and the output to the motor is shut off. At this point the inverter begins a cool down period where the inverter is allowed to cool before the fault can be reset.

① Less than size 24

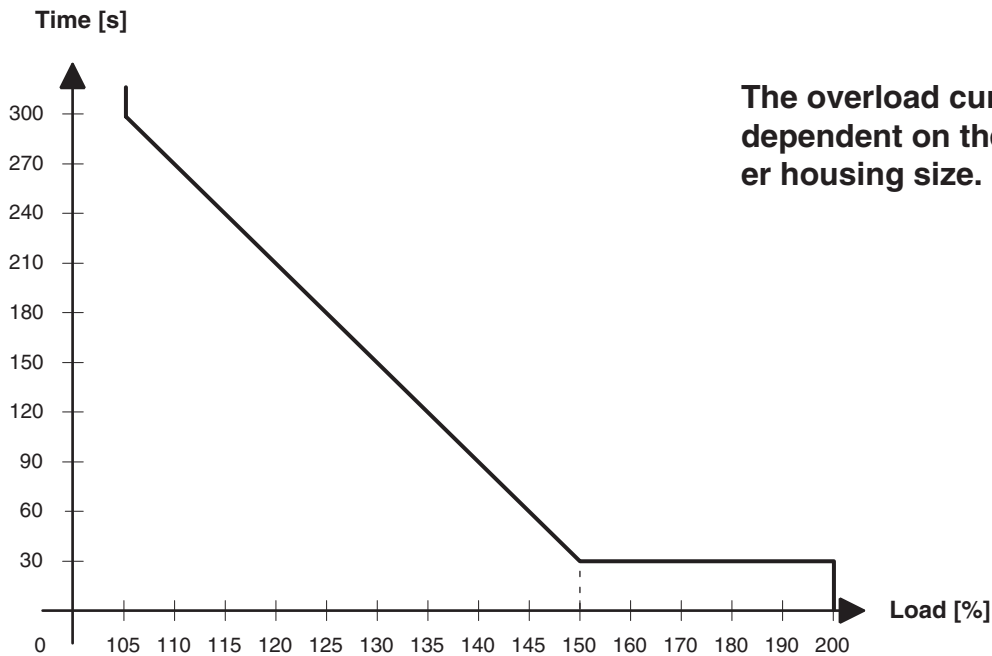

② Size 24 and greater

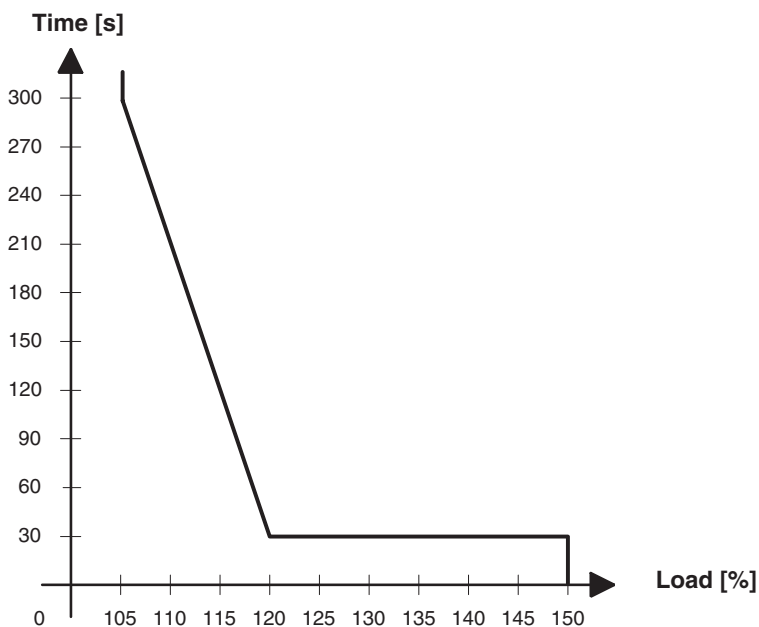

Overload Characteristic

2.7 Low Speed Overload (E.OL2)

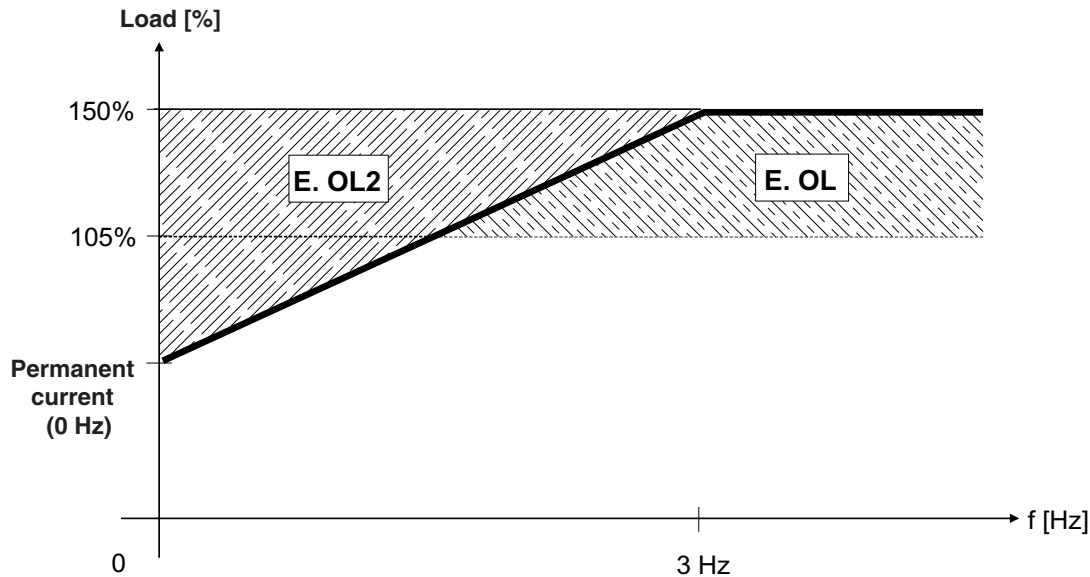

At low speeds (below 3 Hz) the rms current flowing through the power transistors is higher, reaching 1.4 times the rated 60Hz rms value. This is caused by the low frequency sine wave created by the PWM. As a result, the continuous output current must be limited at low speeds to prevent the power transistors from overheating. The COMBIVERT F5 will drop the carrier frequency to 4kHz if necessary to be able to continue to provide current to the motor. Once the output frequency rises above 3Hz or the current drops below the levels listed below, the carrier frequency will be returned to the higher value.

230V Maximum stall current (amps at 0Hz)										
Inverter Housing	Carrier Frequency	Inverter Size								
		13	14	15	16	17	18	19	20	21
E	8 kHz	24	24							
	16 kHz	16.8	16.8							
G	8 kHz		33	31						
	16 kHz		33	26						
H	8 kHz			53	72.5	109				
	16 kHz			53	73	92				
R	8 kHz					84	100	115	145	180
	16 kHz					50	70	70	102	102

460V Maximum stall current (amps at 0Hz)														
Inverter Housing	Carrier Frequency	Inverter Size												
		13	14	15	16	17	18	19	20	21	22	23	24	26
E	8 kHz	12	17	17										
	16 kHz	12	10	10										
G	8 kHz	12	17	19	22.0									
	16 kHz	12	12	8.4	9.5									
H	8 kHz		24	33	42	50	54	83						
	16 kHz		15	20	25	30	36	45						
R	8 kHz					50	60	75	81	115				
	16 kHz					40	27	34	45	63				
U	4 kHz										165	198	330	330
	8 kHz										150	180	180	225
	16 kHz										-	-	-	-

X2A

3.1 Control Circuit

3.1.1 Terminal Strip Connections



PIN	Function	Name	Description
1	Analog input 1 +	AN1+	Pattern speed input or torque command input
2	Analog input 1 -	AN1-	
3	Analog input 2 +	AN2+	Pre-torque input
4	Analog input 2 -	AN2-	
5	Analog output 1	ANOUT1	Analog output of the real speed 0...±10 VDC (0...± 100 %)
6	Analog output 2	ANOUT2	
7	+10V Output	CRF	Analog supply voltage for speed ref.
8	Analog Common	COM	Common for analog in- and outputs
9	Analog Common	COM	Common for analog in- and outputs
10	Leveling Speed	S _L	10 + 11 results in the selection of Intermediate Speed With analog control (LF.2=R 5Pd) these inputs are not used!
11	High Leveling Speed	S _{HL}	
12	High Speed	S _H	
13	Inspection Speed	S _{INS}	
14	Up	U	Preset rotation; "Up" has priority
15	Down	D	
16	Drive Enable	ST	Enable/Disable; response time < 1msec; enable instantly turns off motor current
17	Reset	RST	
18	Digital Out 1	O1	At speed signal (turns off if the actual speed deviates from the set speed)
19	Digital Out 2	O2	Fault signal (activates when there is a drive fault)
20	24V-Output	V _{out}	Approx. 24V output (max.100 mA load)
21	20...30V-Input	V _{in}	Voltage input when an external 24VDC supply is used
22	Digital Common	0V	Common for digital in-/outputs
23	Digital Common	0V	Common for digital in-/outputs
24	RDY Relay max. 30 V DC, 1 A	NO	Ready; relay drops when a drive fault occurs (E.XX).
25		NC	Picks after fault is cleared with RST input or power cycle
26		COM	See Parameter do.82
27	DRO Relay max. 30 V DC, 1 A	NO	Drive On; relay picks after all of the follow conditions are met:
28		NC	enable picked, direction picked, motor phase current check passes.
29		COM	Relay drops when one of the following occurs: enable dropped, direction dropped and actual speed is zero, drive fault (E.XX). See Parameter do.83

Installation and Connection

3.1.2 Connection of the control signals

In order to prevent a malfunction caused by interference voltages on the control inputs, the following steps should be observed:



- Establish a true earth ground for all ground connections!
- Do not connect drive signal commons to earth ground!
- Use shielded cable with twisted pair wires!
- Terminate shield wires to earth ground, only at inverter!
- Separate control and power wires by 8" or more!
- Control and power wires should cross at a right angle!

3.1.3 Digital Inputs

Use of **internal** voltage supply

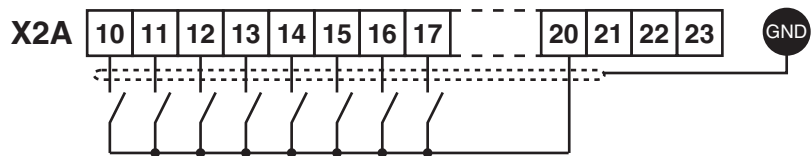

Use of **external** voltage supply

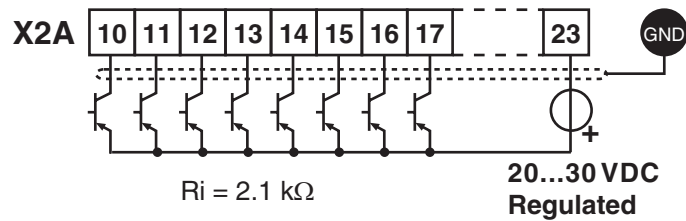

3.1.4 Analog Inputs

Speed Pattern, Torque Command

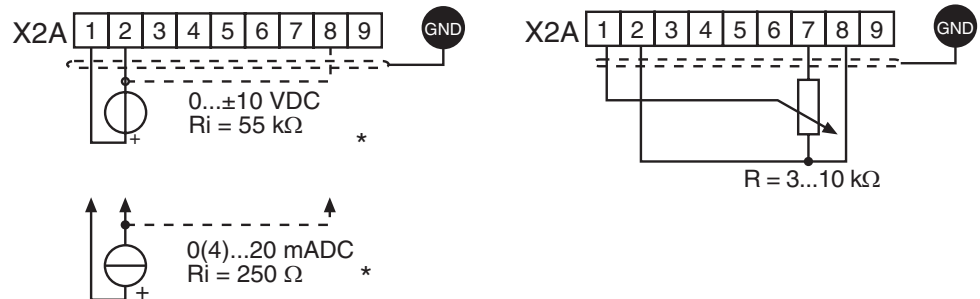

Connect unused analog inputs to common to eliminate noise signals!

3.1.5 Voltage Input / External Power Supply

The supply to the control circuit through an external voltage source keeps the control in operational condition even if the power stage is switched off. To prevent undefined conditions (false triggering), first switch on the power supply then the inverter.

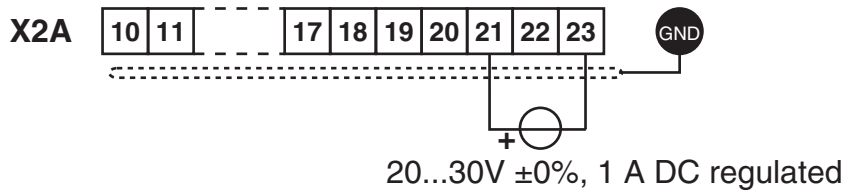

3.1.6 Digital Outputs

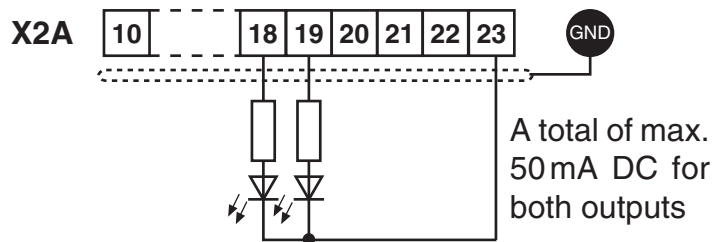

3.1.7 Relay Outputs

In case of inductive loads on the relay outputs, protective wiring must be provided (e.g. RC or diode arc suppression)!

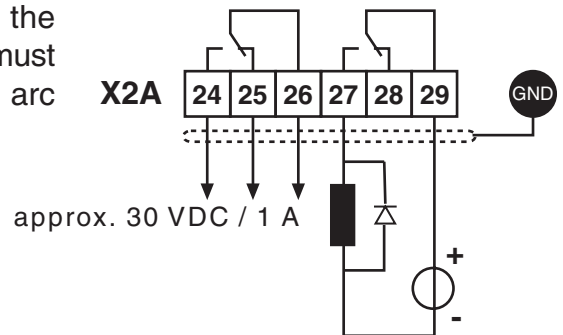

3.1.8 Analog Outputs

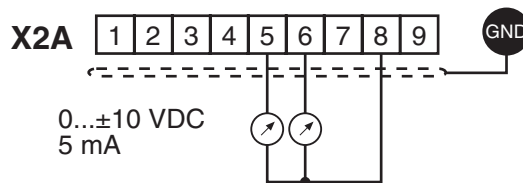

3.1.9 Voltage Output

The voltage output serves for triggering the digital inputs as well as for supplying external control devices. Do not exceed the maximum output current of 100 mA. This output is short circuit protected.

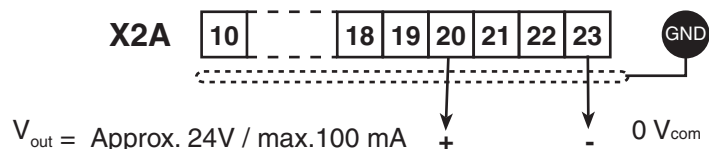

Installation and Connection

3.2 Encoder Connections

3.2.1 X3A RS422/TTL Incremental Encoder Input



ONLY when the inverter is switched off and the voltage supply is disconnected may the feedback connectors be removed or connected!

Connect the incremental encoder mounted on the motor to the 15-pin Sub-D connector at X3A on the COMBIVERT F5M. This connection provides speed feedback and is imperative to the proper operation of the F5M.

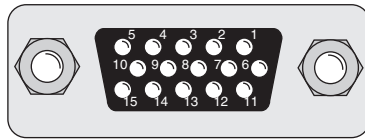

Pin No.	Signal
3	A-
4	B-
8	A+
9	B+
11	V_{var} 24...30 V
12	+5.2 V
13	0V (com)
14	N-
15	N+
Shield	Housing

The internal voltage of " V_{var} " 24...30 V ⁽¹⁾ is a unregulated supply and will allow up to 170 mA max. current draw, for X3A and X3B total. If higher voltages / currents are required, then an external power supply must be provided.

The +5.2 V is a regulated voltage supply generated from V_{var} and will allow up to 500 mA max. current draw, for X3A and X3B total. If additional current is required from the +5.2 V output, the current from V_{var} decreases in accordance with following formula:

$$I_{var} = 170 \text{ mA} - \frac{5.2 \text{ V} \times I_{+5V}}{V_{var}}$$

The following specifications apply to encoder interface X3A and X3B, channel 1 and 2 respectively:

- Max. operating frequency: 300 kHz.
- Internal terminating resistance: $R_t = 120 \Omega$
- RS422 or TTL level square wave voltage level: 2...5 Vdc

Input Wiring

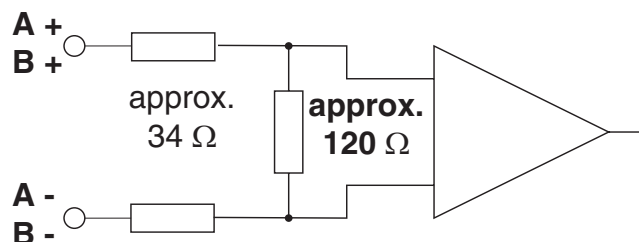

1. Maximum Encoder voltage: +5.2 V

2. Encoder line number: 1...16383 ppr
 2500 ppr is recommended and gives best speed resolution and regulation performance for applications with a maximum motor speed of up to 4500 rpm.

F5M Interface cutoff frequency: 300 kHz
 Observe cutoff frequency of the encoder:

$$f_{\text{limit}} > \frac{g \cdot n_{\text{max}}}{60}$$

g = Encoder increments (ppr)
 n = Encoder speed (rpm)
 f = Encoder operating frequency (Hz)

3. Signal specifications:

Four signals consisting of two square-wave pulses that are electrically 90° out of phase and their inverse signals (TTL-push-pull signals / RS422-conformity). Minimum "on" voltage level is 2.0V and maximum "off" voltage level is 0.5V. The encoder must be electrically isolated from the motor shaft. Otherwise noise from the motor may corrupt the encoder signals.

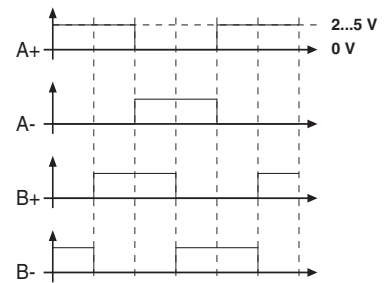

4. Cable specifications: The encoder cable shall not be so long such that the voltage drop in supply voltage on the encoder cable results in a voltage less than the minimum encoder supply voltage. Typically encoder lines should not be longer than 160 ft (50 m). The following must be valid for trouble free operation.

$$[(I_{\text{Encoder}} \cdot R_{\text{Line}}) + V_{\text{Encoder (min)}}] < +5.2 \text{ V}$$

R_{Line} is the sum of the resistance of the supply wires both +V and com.

For maximum noise immunity, the encoder cable shall consist of individually shielded twisted pairs with one overall shield. The individual shields should be connected to 0V (com) pin 13 on the Sub D connector and be kept separate from the outer shield. The outer shield should be connected to earth ground, the housing of the Sub D connector.



The cable shall be kept a minimum of 8 inches (20 cm) away from all wires having greater than 24VDC on them. For best results run the encoder cable in a separate conduit from the controller to the motor.

Installation and Connection

3.2.2 X3A TTL Inc. Enc. In Screw Terminals



ONLY when the inverter is switched off and the voltage supply is disconnected may the feedback connectors be removed or connected!

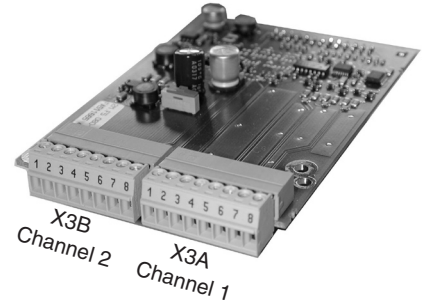
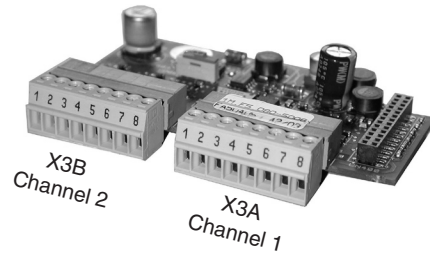

Connect the incremental encoder mounted on the motor to the 8 position terminal connector at X3A. This connection provides speed feedback and is imperative to the proper operation of the F5M.

Plug in screw terminal X3A		1 2 3 4 5 6 7 8
Pos	Signal	Description
1	A+	TTL incremental encoder track A
2	A-	Differential signal to A+
3	B+	TTL incremental encoder track B
4	B-	Differential signal to B+
5	N+	TTL Zero track
6	N-	Difference signal to N+
7	15/24V	Voltage output 15/20...30V, power supply for the encoder, switchable with dip switch S100
8	COM	0V reference for voltage supply
-	GND	connect the outer cable shield to an earth ground connection on the elevator drive .

The following specifications apply to encoder interface X3A, channel 1

- Max. operating frequency: 300 kHz.
- Maximum cable length: 50m (164 ft) (RS422)
- Internal terminating resistance: $R_t = 120 \Omega$
- RS422 or TTL level square wave voltage level: 2...5 Vdc

Input equivalent circuit

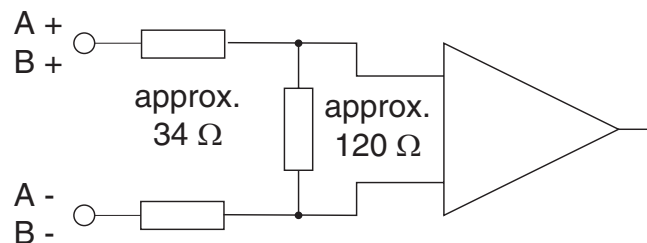

Selection of the supply voltage

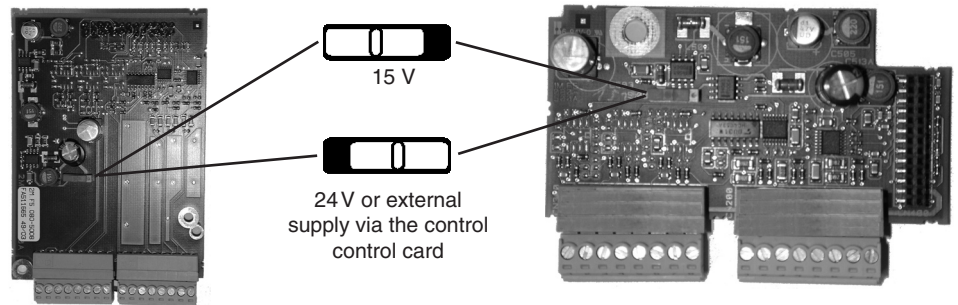

The maximum load capacity is dependant on the selected voltage supply.

Max. load capacity with 15V internal supply:300 mA

Max. load capacity with 24 V internal supply:170 mA

Max. load capacity with an external 24V supply 1 A (dependent on the external voltage source)

The specified currents are reduced by any current drawn on the second interface X3B.

Note: For 5V TTL encoders, a 5V supply is available on second interface, X3B terminal 7.

For maximum noise immunity, the encoder cable shall consist of individually shielded twisted pairs with one overall shield. The individual shields should be connected to 0V (com) pin 8 on the X3A terminal strip and be kept electrically isolated from the outer shield. The outer shield should be connected to earth ground on the elevator drive.



The cable shall be kept a minimum of 8 inches (20 cm) away from all wires having greater than 24VDC on them. For best results run the encoder cable in a separate conduit from the controller to the motor.

Installation and Connection

3.2.3 X3A Hiperface Encoder

The Hiperface encoder provides two differential analog channels for incremental position and one serial data channel for communication with the encoder. This serial data channel can provide the drive with the absolute position of the motor as well as other operating data.

The analog cosine and sine wave signals of tracks A and B have a voltage of 1 V_{pp} with an Offset of 2.5 V. This analog voltage is measured and a high resolution position value is determined as a result. This high resolution position value is very important for good speed control of a gearless motor.



Therefore it is absolutely necessary to ensure these signals are well shielded! Noise on the analog signals resulting from breaks in the shield or improper shield termination will result in vibration in the motor and poor ride quality.

The internal stored ppr value is compared to the adjusted value in LF.27. If the two are not the same the drive will trigger the error E.ENCC. Refer to parameter LF.26 for more information.

During start-up and then every 100 ms a request is transmitted to the encoder and the absolute position is read out via serial communication. This initial readout of the absolute position provides the drive with the commutation angle for permanent magnet motors. On the very first operation of a permanent magnet motor it is necessary to synchronize the encoder position to one of the pole pairs of the motor. See parameter LF.77 for more information and section 5.11.1.

During normal operation, the difference between the internal absolute position of the encoder and the measured position value in the drive is compared. If the two deviate by more than 2.8 degrees, the drive will trigger the error, E.ENCC. Refer to parameter LF.26 for more information.

Hiperface encoders also provide memory for the user to store a copy of the motor data. The drive supports the functionality to read and write the motor data to the encoder. See parameter LF.26 for more information.

**Drive connection
X3A Female SUBD
15 HD**

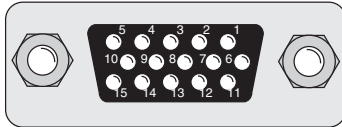

Pin No	Signal Description
1	- -
2	- -
3	REF_COS signal input A- (difference signal to COS+)
4	REF_SIN signal input B- (difference signal to SIN+)
5	- -
6	- -
7	- -
8	COS+ signal input A (absolute track for counter and direction detection)
9	SIN+ signal input B (absolute track for counter and direction detection)
10	+7.5V Supply voltage for encoder
11	- -
12	- -
13	COM reference potential for supply voltage
14	-DATA Data channel RS485
15	+DATA Data channel RS485

Max. Load Capacity depending on Voltage Supply

Max. load capacity at +7.5 V:300 mA. The specified current is reduced by the load current taken from the second encoder interface X3B interface (see section 3.2.5).

HIPERFACE Cable

Pre-manufactured Hiperface cables offer the best solution against noise and disturbance while at the same time saving installation time. The cables come in standard lengths of 5m,10m,15m,20m, 25m, and 30m.

Cable Part Number

00.S4.809-00xx xx = length in meters, 10 = 10 meters

Mating Connector

00.90.912-003U for encoder (solder type)

Running in Conduit

When this cable must be pulled through metallic conduit, it is necessary to over size the conduit! Use of a 1 1/2 inch trade size conduit will allow the connectors to pass without removal of the connectors. Cutting the cable, or removal of the connectors or their housings voids the warranty and will result in problems with electrical noise after the fact.

Circular connector on HIPERFACE encoder.

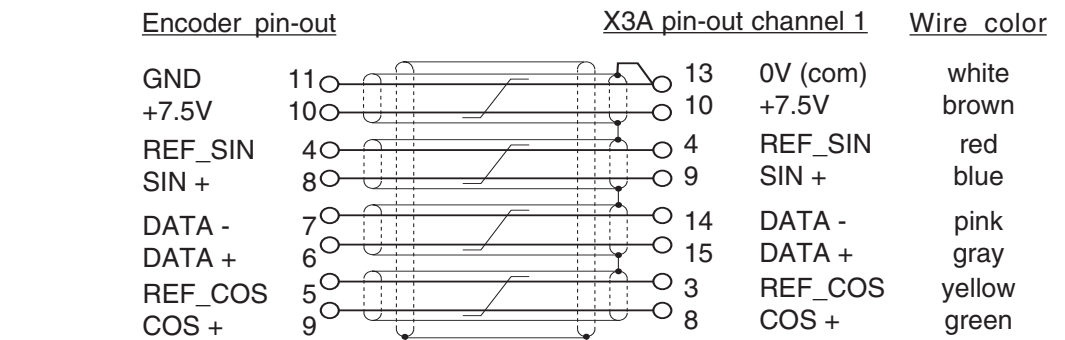
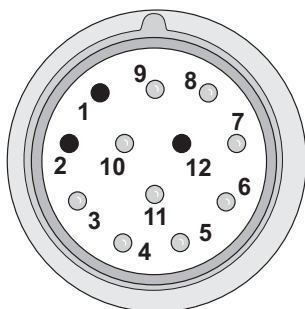

Shield wire tied to housing Shield wire tied to housing which is earth ground.

Note: Inner pair shields are tied to 0V (com) not earth ground!

Installation and Connection

Technical Data

Input resistance:	120 Ohm
Process data channel:	1Vpp
Parameter channel:	EIA RS485 half duplex
Maximum input frequency:	200 kHz
Encoder line number:	1024 inc
Maximum cable length:	<100 m <i>(based on signal levels, otherwise see below)</i>

Cable length based on cable resistance

The maximum cable length is calculated as follows:

$$\text{Length} = \frac{V - V_{\min}}{I_{\max} * R} = \frac{7.5V - 7.0}{0.2A * 0.07 \Omega/m} = 35.7 \text{ m}$$

where

I_{\max} = supply current of encoder [amps]

V = voltage supply of the drive = 7.5V

V_{\min} = minimum supply voltage of the encoder

R = cable resistance (0.07 Ω/m) for KEB cables)

The following Hiperface®-encodera have been tested for use:

- Stegmann SRS 50/60 Singleturn; SCS 60/70 Singleturn
- Stegmann SRM 50/60 Multiturn; SCM 60/70 Multiturn

However, this does not restrict the use of rotary encoder with same specifications of other manufacturers

Recognition of encoder loss or exchange

The recognition of encoder loss or exchange is a software function and dependent on the encoder type. If the drive senses that the serial communication to the encoder has stopped, it will trigger the error E.ENCC.



If the encoder is replaced or disconnected, the drive will trigger an error or warning that the encoder was changed. The drive will display the error message E.ENCC and lock out operation by changing LF.3 to configuration mode. No further operation is possible.

If the encoder was exchanged the drive will auto reset the E.ENCC fault but will remain in configuration mode because the user will need to learn the new encoder position before operation can continue. See section 5.11.1

If there is an encoder triggered fault or problems with the encoder cables, the E.ENCC error will not clear and the problems must be diagnosed through parameter LF.26. To clear the E.ENCC error, it is necessary to go to parameter 0.LF.26, press "Func" and then press "Enter".

Signals Format of the analog channels

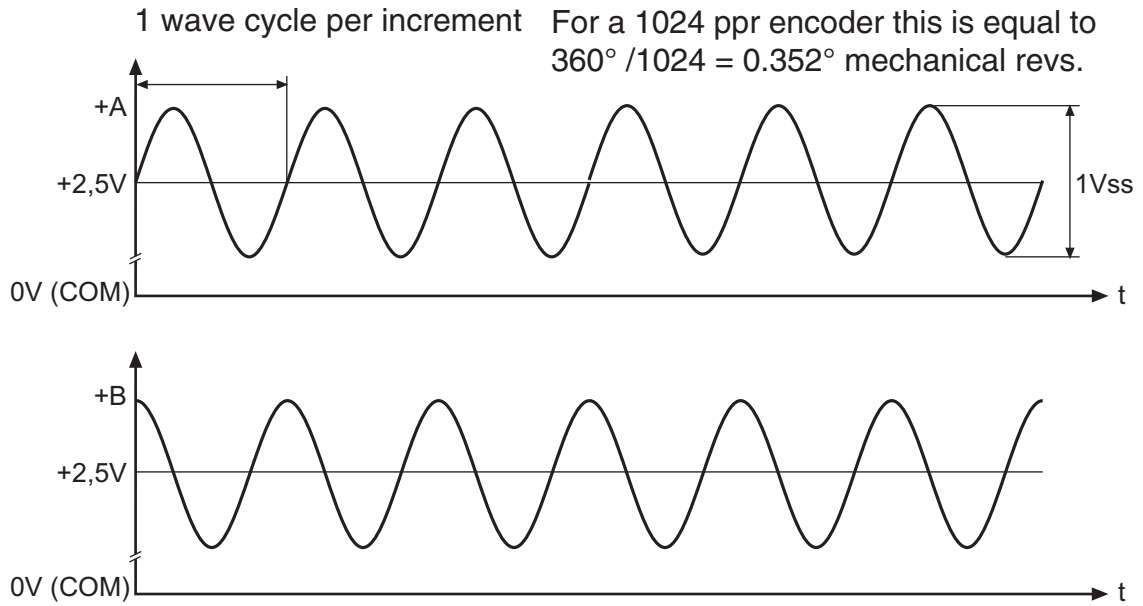

Installation and Connection

3.2.4 X3A EnDat Encoder

The EnDat encoder provides two differential analog channels for incremental position and one serial data channel with clock for communication with the encoder. This serial data channel can provide the drive with the absolute position of the motor as well as other operating data. The EnDat encoder must be version 2.1 or greater for compatibility reasons.

The analog cosine and sine wave signals of tracks A and B have a voltage of 1 V_{pp} with an Offset of 2.5 V. This analog voltage is measured and a high resolution position value is determined as a result. This high resolution position value is very important for good speed control of a gearless motor.



Therefore it is absolutely necessary to ensure these signals are well shielded! Noise on the analog signals resulting from breaks in the shield or improper shield termination will result in vibration in the motor and poor ride quality.

The internal stored ppr value is compared to the adjusted value in LF.27. If the two are not the same the drive will trigger the error E.ENCC. Refer to parameter LF.26 for more information.

During start-up and then every 30 ms a request is transmitted to the encoder and the absolute position is read out via serial communication. This initial readout of the absolute position provides the drive with the commutation angle for permanent magnet motors. On the very first operation of a permanent magnet motor it is necessary to synchronize the encoder position to one of the pole pairs of the motor. See parameter LF.77 for more information and section 5.11.1.

During normal operation, the difference between the internal absolute position of the encoder and the measured position value in the drive is compared. If the two deviate by more than 2.8 degrees, the drive will trigger the error, E.ENCC. Refer to parameter LF.26 for more information.

ENDAT encoders also provide memory for the user to store a copy of the motor data. The drive supports the functionality to read and write the motor data to the encoder. See parameter LF.26 for more information.

The clock signal serves as synchronisation for the serial data channel.

Drive connection
X3A Female SUBD
15 HD

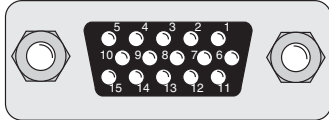

Pin No	Signal Description
1	- -
2	- -
3	REF_COS signal input A- (difference signal to COS+)
4	REF_SIN signal input B- (difference signal to SIN+)
5	- -
6	+ CLOCK synch. signal for serial data
7	- CLOCK synch. signal for serial data
8	COS+ signal input A (absolute track for counter and direction detection)
9	SIN+ signal input B (absolute track for counter and direction detection)
10	- -
11	- -
12	+ 5V Supply voltage for encoder
13	COM Reference potential for supply voltage
14	-DATA Data channel RS485
15	+DATA Data channel RS485

Max. Load Capacity depending on Voltage Supply

Max. load capacity at +5.0V; 300 mA. The specified current is reduced by the current taken from the second encoder interface X3B interface (see section 3.2.4).

EnDat Cable

Pre-manufactured EnDat cables offer the best solution against noise and disturbance while at the same time saving installation time. The cables come in standard lengths of 5m, 10m, 15m, 20m, 25m and 30m.

Cable Part Number

00.F5.0C1-40xx xx = length in meters, 10 = 10 meters

Mating Connector

00.90.912-004U for encoder (solder type)

Running in Conduit

When this cable must be pulled through metallic conduit, it is necessary to over size the conduit! Use of a 1 1/2 inch trade size conduit will allow the connectors to pass without removal of the connectors. Cutting the cable, or removal of the connectors or their housings voids the warranty and will result in problems with electrical noise after the fact.

Circular connector on EnDat encoder.

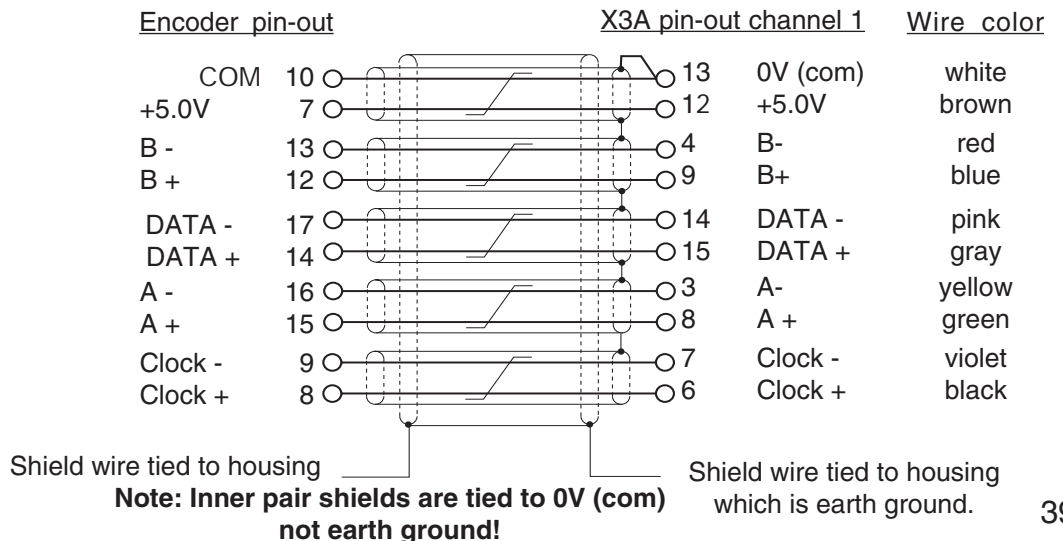
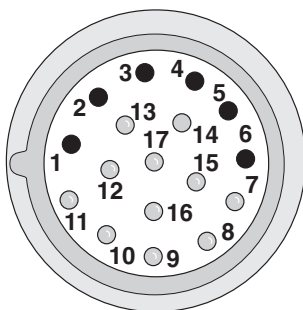

Installation and Connection

Technical Data

Input resistance:	120 Ohm
Process data channel:	1Vpp
Parameter channel:	EIA RS485 half duplex
Clock signal output:	EIA RS485
Maximum input frequency:	200 kHz
Encoder line number:	1...2048 inc
Maximum cable length:	100 m (<i>based on signal levels, otherwise see below</i>)
Cable length based on cable resistance	

The maximum cable length is calculated as follows:

$$\text{Length} = \frac{V - V_{\min}}{I_{\max} * R} = \frac{5.25V - 4.75V}{0.2A * 0.07 \Omega/m} = 35.7 \text{ m}$$

where

I_{\max} = supply current of encoder [amps]

V = voltage supply of the drive = 5.25V

V_{\min} = minimum supply voltage of the encoder

R = cable resistance (0.07 Ω/m) for KEB cables)

The following ENDAT encoders have been tested for use:

- Heidenhain ECN 1313 single turn; ECI 1317 Singleturn
- HeidenhainROQ 425 Multiturn; EQI 1329 Multiturn

However, this does not restrict the use of rotary encoder with same specifications of other manufacturers

The recognition of encoder loss or exchange is a software function and dependent on the encoder type. If the drive senses that the serial communication to the encoder has stopped, it will trigger the error E.ENCC.



If the encoder is replaced or disconnected, the drive will trigger an error or warning that the encoder was changed. The drive will display the error message E.ENCC and lock out operation by changing LF.3 to configuration mode. No further operation is possible.

If the encoder was exchanged the drive will auto reset the E.ENCC fault but will remain in configuration mode because the user will need to learn the new encoder position before operation can continue. See section 5.11.1

If there is an encoder triggered fault or problems with the encoder cable the E.ENCC error will not clear and the problems must be diagnosed through parameter LF.26. To clear the E.ENCC error, it is necessary to go to parameter 0.LF.26, press "Func" and then press "Enter".

Signals Format of the analog channels

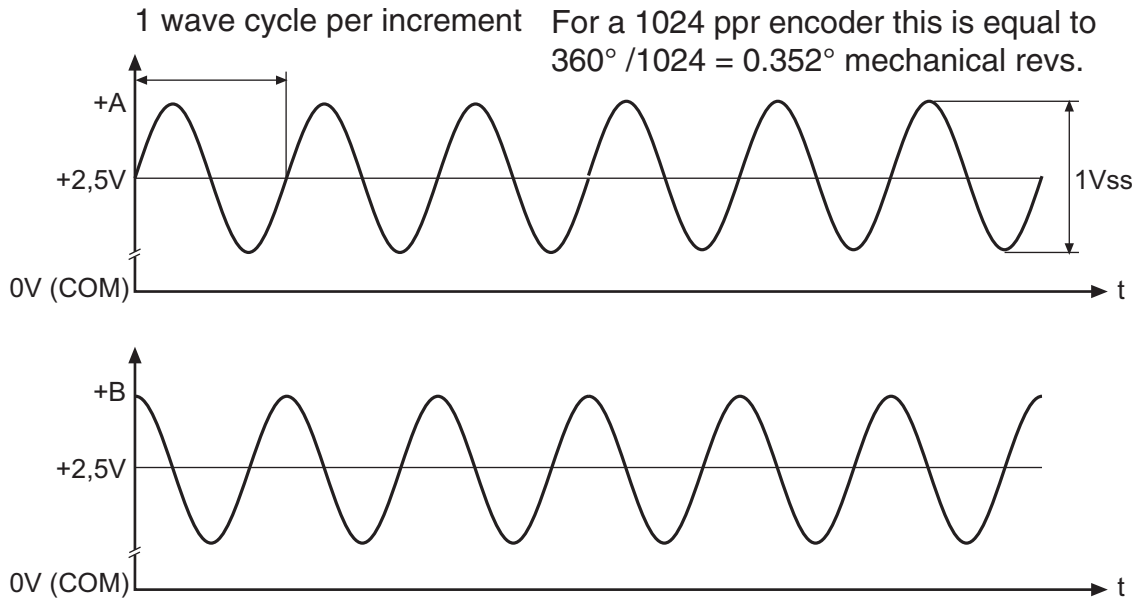

Installation and Connection

3.2.5 X3A SIN/COS-SSI Encoder

The SIN/COS-SSI encoder provides two differential analog channels for incremental position and one serial data channel with clock for communication with the encoder. This serial data channel can provide the drive with the absolute position of the motor.

The analog cosine and sine wave signals of tracks A and B have a voltage of 1 V_{pp} with an Offset of 2.5 V. This analog voltage is measured and a high resolution position value is determined as a result. This high resolution position value is very important for good speed control of a gearless motor.



Therefore it is absolutely necessary to ensure these signals are well shielded! Noise on the analog signals resulting from breaks in the shield or improper shield termination will result in vibration in the motor and poor ride quality.

During start-up and then every 30 ms a request is transmitted to the encoder and the absolute position is read out via serial communication. This initial readout of the absolute position provides the drive with the commutation angle for permanent magnet motors. On the very first operation of a permanent magnet motor it is necessary to synchronize the encoder position to one of the pole pairs of the motor. See parameter LF.77 for more information and section 5.11.1.

During normal operation, the difference between the internal absolute position of the encoder and the measured position value in the drive is compared. If the two deviate by more than 2.8 degrees, the drive will trigger the error, E.ENCC. Refer to parameter LF.26 for more information.

The clock signal serves as synchronisation for the serial data channel.

**Drive connection
X3A Female SUBD
15 HD**

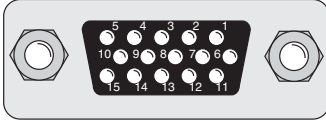

Pin No	Signal Description
1	- -
2	- -
3	REF_COS signal input A- (difference signal to COS+)
4	REF_SIN signal input B- (difference signal to SIN+)
5	- -
6	+ CLOCK synch. signal for serial data
7	- CLOCK synch. signal for serial data
8	COS+ signal input A (absolute track for counter and direction detection)
9	SIN+ signal input B (absolute track for counter and direction detection)
10	- -
11	- -
12	+ 5V Supply voltage for encoder
13	COM Reference potential for supply voltage
14	-DATA Data channel RS485
15	+DATA Data channel RS485

Max. Load Capacity depending on Voltage Supply

Max. load capacity at +5.0V; 300 mA. The specified current is reduced by the current taken from the second encoder interface X3B interface (see section 3.2.4).

SIN/COS-SSI Cable

Pre-manufactured SIN/COS-SSI cables offer the best solution against noise and disturbance while at the same time saving installation time. The cables come in standard lengths of 5m, 10m, 15m, 20m, 25m and 30m.

Cable Part Number

00.F5.0C1-40xx xx = length in meters, 10 = 10 meters

Mating Connector

00.90.912-004U for encoder (solder type)

Running in Conduit

When this cable must be pulled through metallic conduit, it is necessary to over size the conduit! Use of a 1 1/2 inch trade size conduit will allow the connectors to pass without removal of the connectors. Cutting the cable, or removal of the connectors or their housings voids the warranty and will result in problems with electrical noise after the fact.

Circular connector on EnDat encoder.

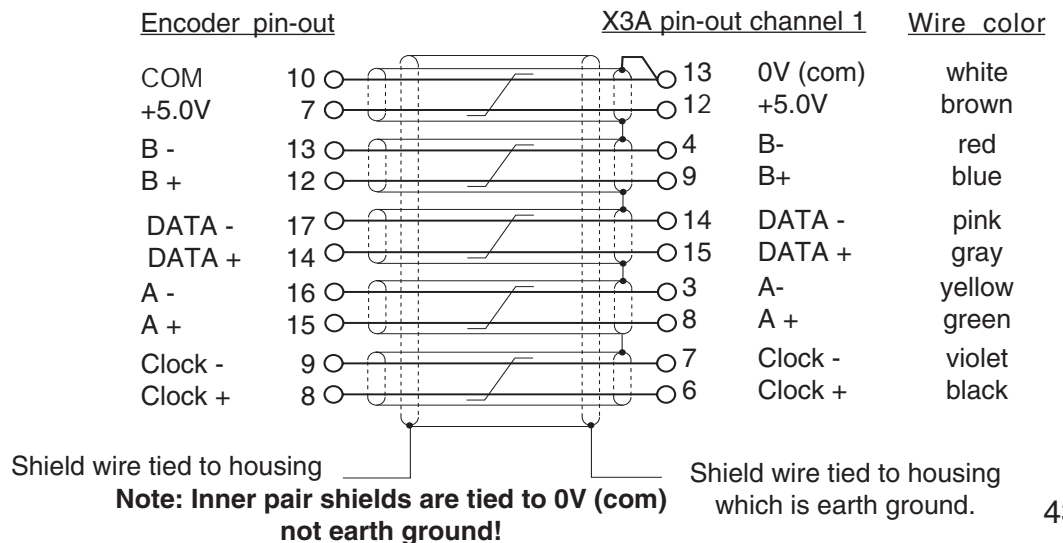
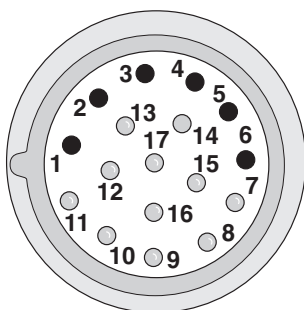

Installation and Connection

Technical Data

Input resistance:	120 Ohm
Process data channel:	1Vpp
Parameter channel:	EIA RS485 half duplex
Clock signal output:	EIA RS485
Maximum input frequency:	200 kHz
Encoder line number:	1...2048 inc
Maximum cable length:	100 m <i>(based on signal levels, otherwise see below)</i>
Cable length based on cable resistance	

The maximum cable length is calculated as follows:

$$\text{Length} = \frac{V - V_{\min}}{I_{\max} * R} = \frac{5.25V - 4.75V}{0.2A * 0.07 \Omega/m} = 35.7 \text{ m}$$

where

I_{\max} = supply current of encoder [amps]

V = voltage supply of the drive = 5.25V

V_{\min} = minimum supply voltage of the encoder

R = cable resistance (0.07 Ω/m) for KEB cables)

The following SIN/COS-SSI encoders have been tested for use:

- Danaher / Hengstler

However, this does not restrict the use of rotary encoder with same specifications of other manufacturers

The recognition of encoder loss or exchange is a software function and dependent on the encoder type. If the drive senses that the serial communication to the encoder has stopped, it will trigger the error E.ENCC.



If the encoder is replaced or disconnected, the drive will trigger an error or warning that the encoder was changed. The drive will display the error message E.ENCC and lock out operation by changing LF.3 to configuration mode. No further operation is possible.

If the encoder was exchanged the drive will auto reset the E.ENCC fault but will remain in configuration mode because the user will need to learn the new encoder position before operation can continue. See section 5.11.1

If there is an encoder triggered fault or problems with the encoder cable the E.ENCC error will not clear and the problems must be diagnosed through parameter LF.26. To clear the E.ENCC error, it is necessary to go to parameter 0.LF.26, press "Func" and then press "Enter".

Signals Format of the analog channels

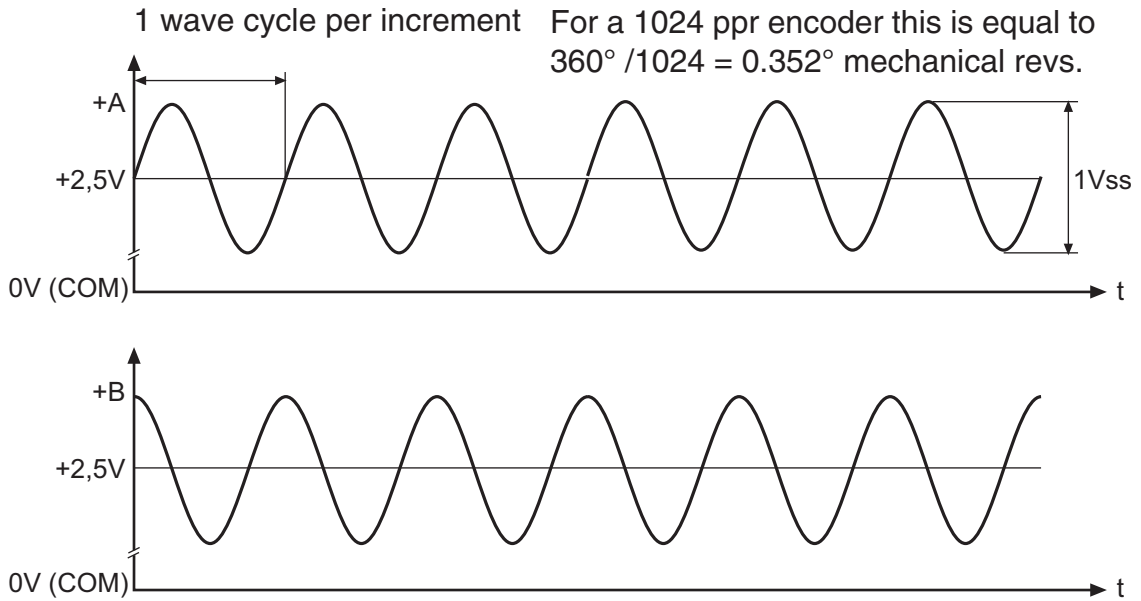

Installation and Connection

3.2.6 X3B Incremental Encoder Output



ONLY when the inverter is switched off and the voltage supply is disconnected may the feedback connectors be removed or connected!

The second incremental encoder connection serves as a buffered output of the motor encoder. This can be used by other control systems for speed or position control. The output signals are according to the RS422 line driver signal standard.

9 Pin Sub D - Female

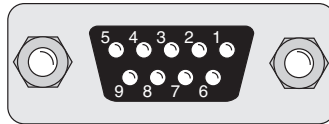

Plug in screw terminal



Pin No.	Signal	Pin No.
1	A+	1
2	B+	3
3	N+	5
4	+5.0 V	7
5	24...30 V	-
6	A-	2
7	B-	4
8	N-	6
9	0V com	8
Sub-D Housing	Earth GND	Inverter Housing

The internal 24VDC power supply has a maximum load capacity of 170mA . The 5V supply has a maximum load capacity of 500mA. Both of these values assume no loading on the supplies of connection X3A. If connections or loads are placed on both terminals, the total load between the two must not exceed these values.

The following specifications apply to encoder interface X3B, channel 2

- Max. operating frequency: 200 kHz.
- Maximum cable length: 50m (164 ft)
- External terminating resistance: $R_t = 120 \text{ W}$
- RS422 or TTL level square wave voltage level: 2...5 Vdc



For proper noise immunity, the RS422 standard requires a termination resistor be placed at the device which is receiving the simulated encoder signal. The resistors shall be connected from A+ to A-, B+ to B-, N+ to N- (only when used).

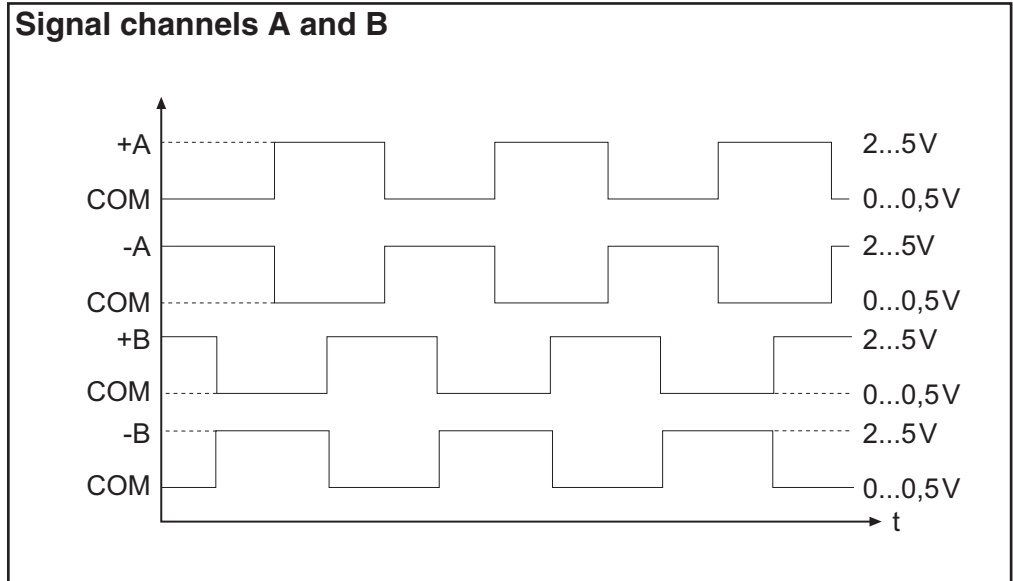

4. Operation of the unit

4.1 Digital Operator

The Elevator drive uses a special operator which provides a user interface and functionality specific to elevator applications. The operator must be plugged into the drive in order for the drive to function correctly.



Unplugging the operator while the drive is in operation will result in immediate shutdown of the drive and will cause the ready relay to drop and the fault output to activate. If it is necessary to remove the operator, do so while the elevator is standing still!

Elevator Operator: Part No. 00.F5.060-2010

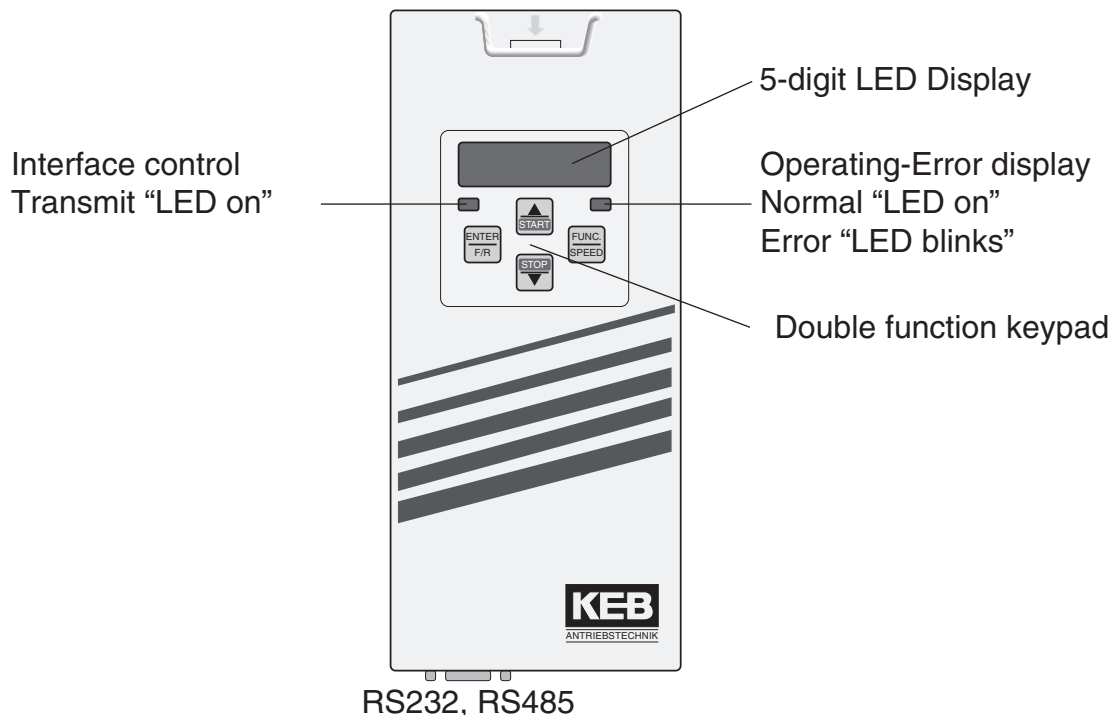

Only use the **operator interface** for the serial data transfer to RS232, 485. The direct connection from PC directly to the Elevator Drive, i.e. not to the operator, is only possible with a **special cable**, otherwise it will lead to the destruction of the PC-interface. Consult the factory for more information.

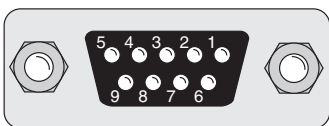

PIN	RS485	Signal	Meaning
1	–	–	reserved
2	–	TxD	Transmitter signal, RS232
3	–	RxD	Receiver signal, RS232
4	A'	RxD-A	Receiver signal A, RS485
5	B'	RxD-B	Receiver signal B, RS485
6	–	VP	Voltage supply-Plus +5V ($I_{\max} = 10 \text{ mA}$)
7	C, C'	DGND	Data reference potential
8	A	TxD-A	Transmitter signal A, RS485
9	B	TxD-B	Transmitter signal B, RS485

4.2 Parameter Identification

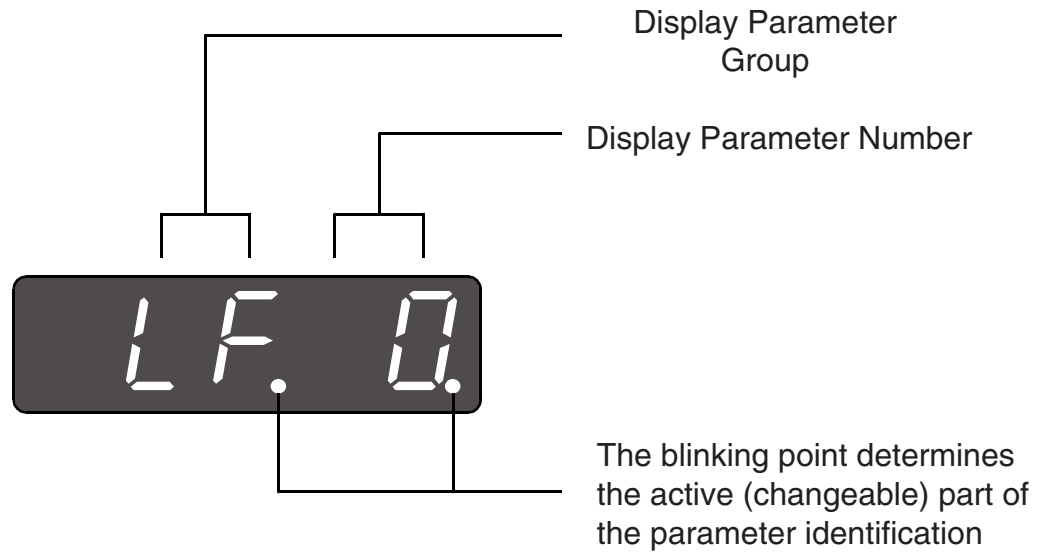

4.3 Parameter Selection

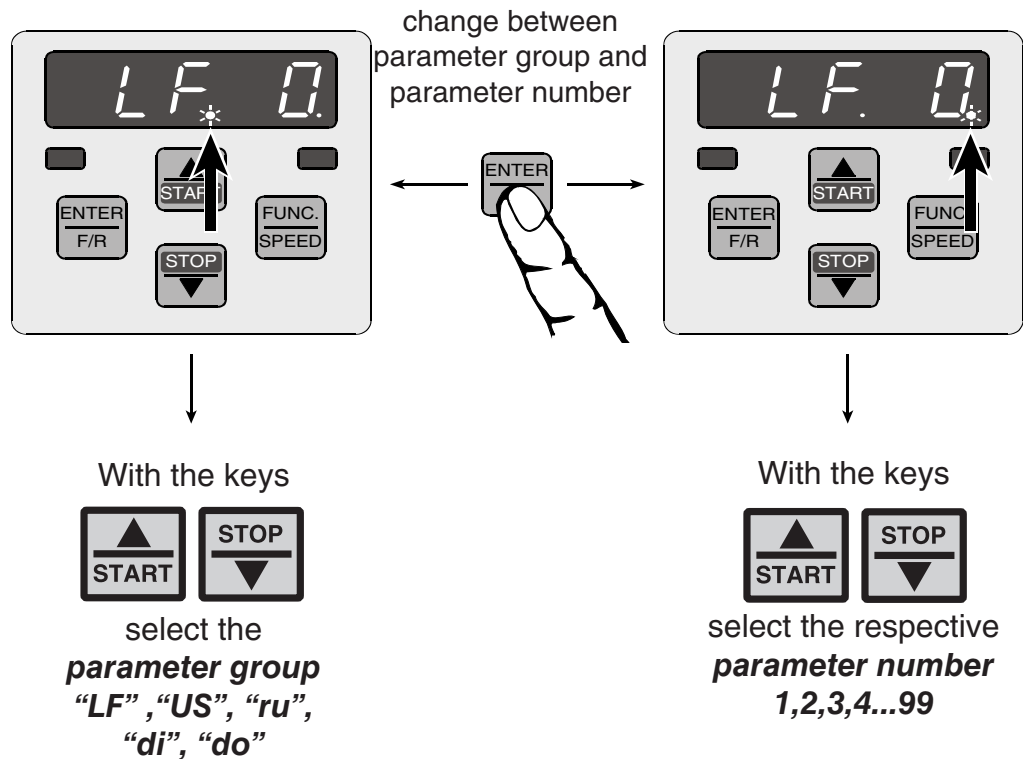

Keypad Display

4.4 Changing Parameter Values

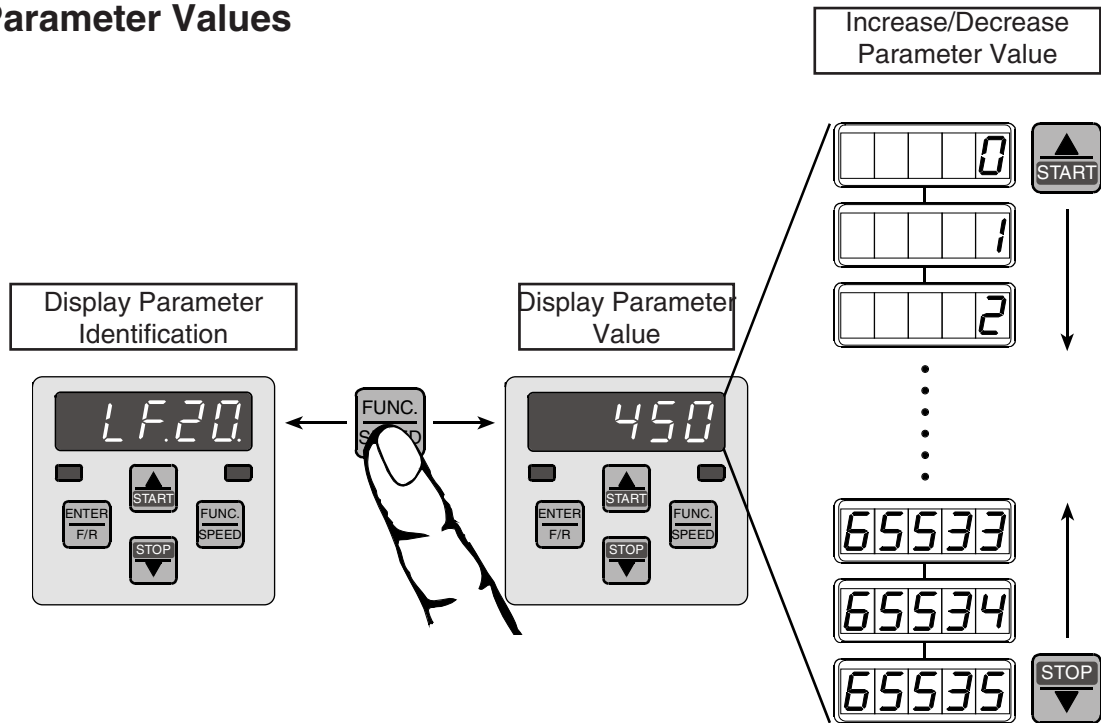

Changing Parameter Values

All parameter changes are accepted for operation and saved only after the ENTER key is pressed.

4.5 Parameter Structure

Some parameters, such as the motor data, can not be changed while the elevator is in operation.

Parameter Groups

LF-Parameter: LF. 2 ... LF.99

These parameters allow the user to program the drive for the given job specifications: motor data, mechanical data, speeds, profiles, etc.

US-Parameter: US. 1 ... US.10

The US parameters are comprised of configuration parameters: parameter value reset, selection of operation mode, password entry, etc.

ru-Parameter: ru.0 ... ru.83

The ru parameters are comprised of run parameters for monitoring operation, i.e. actual values for many internal parameters

do-Parameter: do.42 ... do.83

The do parameters are comprised of parameters for defining the output functions

di-Parameter: di.0 ... di.3

The di parameters are comprised of parameters for defining the input functions

4.6 Saving Parameter Values

If the parameter value is changed, a point appears behind the last position in the display. The adjusted parameter value is permanently saved when **ENTER** is pressed. The point after the value disappears to confirm.

Example:

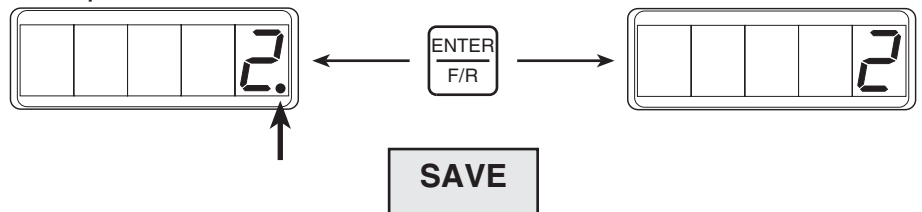

4.7 Error Messages

If a malfunction occurs during operation, the drive shuts down operation and the actual display is overwritten with the error message. By pressing the “ENTER” key, the error message and the fault status is cleared. Exception: E.ENCC errors, see parameter LF.26 for E.ENCC errors.

Example:



Some errors are automatically reset according to the adjustment of parameter LF.5. So it is possible that the error message and the error status of the drive will clear on its own. Refer to parameter LF.98 for the fault history.

***Inverter Status Message
(running/error message) see p. 110***

5. Initial Start-up

5.1 Selecting The Configuration

Before trying to operate the drive it is necessary to establish the correct mode of operation. The F5 drive is capable of driving different types of motors both open and closed loop. Therefore prior to operation, the type of motor and mode of operation (open or closed loop) must be established.



Note: In most cases the elevator control manufacturer will make the adjustment of the configuration and control mode, sections 6.1,6.2,6.3, and therefore it is not necessary to make these adjustments in the field. In this case simply verify parameter LF.4 matches the required configuration number listed below.

The available motors and modes or configurations are listed below. From this list it is possible to select the correct configuration setting of the Drive.

Motor Type	Open Loop	Closed Loop	Configuration Display Code
Induction Geared	-	x	ICL5d
Induction Gearless	-	x	I9L55
PM Synchronous Geared	-	x	PCL5d
PM Synchronous Gearless	-	x	P9L55

5.2 Loading The Configuration

With the configuration code noted, go to parameter US.10 on the keypad of the drive and press “Function.” Select the configuration code indicated and press “Enter.”

Once the configuration is selected, it is now necessary to load the configuration file. This adjusts the drive for the correct motor type and establishes the correct internal settings.

To load the configuration go to parameter US.04, set the display to LoAd and press enter. The display will show Pr09 and the configuration file will be loaded. The display will confirm whether the load was successful. If the display ultimately changes to parameter LF.99 and shows n0P, the load was successful. If the file is not completely loaded, the display will show b0PAS for bad operation and will remain at parameter US.4. In this case power cycle the drive and try to load the configuration again. Make sure that no inputs are active while trying to load the configuration. LF.82 should read 0. If still unsuccessful there may be an incompatibility between the operator and the drive. Contact the manufacturer for further assistance.

After loading, the configuration can be verified through parameter LF.4. The same configuration code as that selected in US.10 will be displayed in LF.4. Also after a successful load US.4 will display PASS.

5.3 Setting The Control Type

The COMBIVERT drive supports five different control modes, digital speed selection and control, analog speed control, analog torque control. The drive's I/O will need to be set up according to the desired scheme. From the table below select the desired control scheme and adjust the corresponding number in parameter LF.2.

Control Mode	Setting in LF.2
Absolute Analog Speed Control	RbSPd
Digital Speed Selection	d SPd
Analog Speed Control	A SPd
Analog Torque Control	A tor
Analog Speed Control	SErSP

5.4 Entering The Operating Data

The COMBIVERT drive utilizes robust algorithms for controlling the motor, therefore even with minimum information about the motor, good performance can still be achieved. However a few basic parameters are required. Their adjustment is outlined below. For purposes of identifying the type of motor in use the following convention will be utilized in this manual. AC induction motors will be referred to as "IM" and AC permanent magnet synchronous motor will be referred to as "PM"

Before you begin to enter the motor data verify that parameter LF.3 is set to conF configuration.

The COMBIVERT Drive is capable of driving either induction motors, referred to from here on as "IM" or permanent magnet motors referred to from here on as "PM"

Verify in LF. 4 that the correct motor configuration is loaded and then follow the steps listed below based on what type of motor you have.

5.5 Induction Motors

5.5.1 Motor Overload

The COMBIVERT drive is capable of providing solid state motor overload protection. If it is desired that the drive provide this protection, turn the function "on" in parameter LF.08. Then adjust the motor full load amps (FLA) in parameter LF.09. Enter the IM power (hp) in LF.10.

Initial Start Up

5.5.2 Motor Data

Enter the motor rated speed (rpm) in LF.11. For IM this value is not the synchronous speed but the full load rpm which is always less than synchronous speed. An example is a 6 pole motor; the synchronous speed is 1200 rpm but the rated speed is lower, about 1165 rpm. If the rated speed is not listed on the nameplate then the value can be approximated as the synchronous speed less 2.9%, so $1200 \text{ rpm} - 35 \text{ rpm} = 1165 \text{ rpm}$.

Enter the rated FLA of the motor in parameter LF.12.

Enter the rated nameplate frequency in parameter LF.13. In some cases manufacturers of induction motors de-rate the motor by changing the frequency to something less than 60hz, i.e. 40Hz. In this case enter the nameplate value of 40Hz. Most gearless motors will have a very low frequency in the range of 8 to 30 Hz. Enter the frequency as indicated on the motor nameplate.

In LF.14 enter the rated motor voltage. For IM this is the AC voltage at the rated frequency, i.e. 230V or 460V.

The IM power factor can be entered in LF.15. If this value is not known use the default value of 0.90. This parameter sets the magnetizing current level. Higher values result in lower magnetizing current. For older existing high slip or two speed motors use a value of 0.95.

The field weakening speed in LF.16 is calculated by the drive. It may be necessary to adjust it later once the elevator is in operation and running at high speed. For now leave it at the calculated value.

LF.17 is the motor rated torque. With IM this value is calculated and is only for reference.

Entry of the IM motor data is now complete!

5.6 PM Synchronous Motors

5.6.1 Motor Overload The COMBIVERT drive is capable of providing solid state motor overload protection. If it is desired that the drive provide this protection, turn the function “on” in parameter LF.08. The drive uses the motor current from LF.12. As the trigger level.

5.6.2 Motor Data Depending on the motor manufacturer and the installed encoder, it may be possible to read all motor data from the encoder and preset all data to the manufacturer’s values therefore eliminating the need to adjust the motor data. Refer to section 5.8.3 for a description of this process. Otherwise proceed with the adjustment steps below.

The PM motor power (hp) in LF.10 is calculated from the speed (LF.11) and torque (LF.17). This value is for reference only.

Enter the motor rated speed (rpm) in LF.11. Note in some cases this speed may be faster than the actual speed the motor will turn at. This parameter must agree with parameters LF.13 based on the following equation. Do not round the numbers enter exactly what is calculated.

$$\frac{\text{Rated Freq.} \times 120}{\text{no. of poles}} = \text{Rated Speed}$$

Enter the rated FLA of the motor in parameter LF.12.

Enter the rated nameplate frequency in parameter LF.13. Again refer to the calculation above. Do not round this value enter exactly what is calculated.

In LF.14 enter the rated, no load, motor back EMF rms phase to phase voltage. Follow the steps in section 5.6.3 to measure this value.

LF.17 is the motor rated torque. For PM motors enter the rated motor torque in lbft. If this value is not listed on the motor you can calculate it as follows.

$$\frac{\text{HP}}{\text{rpm}} \times 5258 = \text{lbft} \quad (\text{HP and rpm from motor nameplate})$$

LF.18 is the motor stator phase to phase resistance. Follow the steps in section 5.6.3 to measure this value.

LF.19 is the motor stator leakage inductance. Follow the steps in section 5.6.3 to measure this value.

Entry of the PM motor data is now complete!

Initial Start Up

5.6.3 Auto-Tuning PM motors For best performance the resistance and the inductance of the PM motor must be measured by the drive. Use the following steps to complete the measurement for PM synchronous motors.

Set up

- 1) Make sure the rated motor speed (LF.11), rated motor current (LF.12), rated motor frequency (LF.13), rated motor torque (LF.17) and contract speed (LF.20) are entered into the drive before you begin.
- 2) Remove one brake wire from the controller or reduce the brake pick voltage level, preventing it from picking.
- 3) If the controller is providing the speed command via analog or serial command, set the inspection speed value to zero in the controller to zero. If the drive is providing the command there is no need to change the inspection speed in the drive.
- 4) Go to parameter 2.LF.26 and verify the display shows conn meaning the encoder is communicating to the drive and everything is OK.

Learn Process

- 1) Set LF.3 = 5 Lrn. This will start the learn process.
- 2) The display will change to StArt.
- 3) Press and hold inspection up. The motor contactor should pull in and the brake should not pick. Motor current will begin to flow and the drive display will change to MeASr .
- 4) Continue holding the inspection button in until the display shows either rLrnd (resistance learned) or E rLn (error resistance learn).
- 5) When the drive displays one of these two messages, release the inspection switch. The drive will reset, displaying 88888 and then eventually display StArt again. In the mean time the ready relay on the drive will have dropped momentarily causing a fault on the controller.
- 6) With the controller reset and the drive display showing StArt, press and hold the inspection switch again. The drive display will briefly show MeASr and then a number, at the same time you will hear various frequencies coming from the motor. Each number is one measurement of the inductance.
- 7) Continue holding the inspection switch until the drive displays either LLrnd or E LLn.
- 8) Release the inspection switch, the drive will finish by calibrating the motor back EMF in parameter LF.14 and then will reset and reprogram all parameters updating the motor data with the measured values.

AUTO TUNE COMPLETE!

rLrnd means the resistance was successfully learned and the drive will continue to learn the inductance.

LLrnd means the inductance was successfully learned and the drive will continue to calibrate the back EMF.



Errors E rLn or E LLn can be caused by releasing the inspection switch before the learn is complete or by the drive measuring three values with more than 10% difference in between. If an error is encountered start at the beginning of the learn process and try again.

Remember to put the drive back into run mode in LF.3 and return the controller adjustments to the previous values! Reconnect the brake wire!



Initial Start Up

5.7 Machine Data

It is necessary to enter the machine data such that the drive can establish the relationship between linear travel, ft/min and rotary speed in rpm at the motor.

Enter the job contract speed in parameter LF.20.

Then enter the sheave diameter in LF.21. If this value is not known, it can be measured with a tape measure. Some sheave manufacturers will show the “Minimum Groove Diameter” on a plate attached to the sheave. This is the diameter to the bottom of the groove, which is normally about one inch smaller than the actual diameter at which the rope lies. Therefore, when this dimension is provided, add one inch to it and enter that value into LF.21.

LF.22 is the machine gear ratio. It is often listed on the machine as a ratio of gear teeth such as 55:2. In this case divide the ratio ($55/2 = 27.5$) and enter the value. If the ratio is not known, skip ahead to LF.23 and then see LF.25 for an estimated gear ratio which can be entered into LF.22. Remember for gearless jobs the gear ratio is 1.00.

LF.23 is the roping ratio. For most geared applications it is 1:1. For gearless application the rope ratio is typically 2 but can be higher.

LF.24 is the car rated capacity in lbs.

LF.25 is the estimated gear ratio. If the gear ratio is not known, take the value from LF.25 and enter it into LF.22.

Set up for the machine is complete!

5.8 Encoder Feedback

Parameters LF.26...LF.29 and optionally parameters LF.76 and LF.77 are used to establish the encoder feedback.

5.8.1 Encoder card verification

The most important point is to verify that the installed feedback card matches the encoder type on the motor. The drive supports many different types of encoders, some of which require different feedback cards as options. Parameter 0.LF.26 displays the type of encoder feedback card which is currently installed. From the list below verify the encoder interface on the drive matches the encoder on the motor.

0.LF.26	Type of encoder card installed in the drive
rESoL	Resolver
HIPEr	Hiperface
Inc24	15-24V HTL incremental
IncIE	5V TTL incremental
SinCo	Sine Cosine
I24PE	15-24V HTL incremental
EndAt	EnDat Encoder
PHASE	UVW Encoder

5.8.2 Encoder serial com. verification

ENDAT, HIPERFACE, and SIN/COS-SSI encoders support serial communication between the encoder card on the drive and the encoder. This serial communication transmits the digital position value and well as other data about the motor and the encoder. The encoder can trigger faults and advise the drive of the problem. Therefore with these types of encoders it is necessary to verify that serial communication is functioning normally. Parameter 2.LF.26, displays the status of the encoder / encoder interface. When everything is functioning normally the display will show `conn`. If there is an error, the drive will first stop operation with an E.ENCC error and then will display the encoder error code from 2.LF.26 and then a text message representing the code. All diagnostics of the encoder interface should be handled through parameter 2.LF26. For more information refer to parameter LF.26.

5.8.3 Loading motor data from encoder

When ENDAT or HIPERFACE encoders are used on PM motors, the motor manufacturer may pre-load the encoder with the motor data at the factory. In this case the motor data as well as commutation position, can then be read out from the encoder and loaded into the drive, and thus simplify the set up and commissioning process.

Parameter 3.LF.26 allows the motor data in the encoder to be loaded into the drive.

Reading motor data from the encoder

- 1) go to parameter 2.LF26 and verify serial communication is OK. Display should show `conn`.
- 2) go to parameter 3.LF.26 and press function. The display should show `ldLE`.
- 3) press the up arrow and the display will change to `rdEnc`
- 4) press enter and the display will change to `no`
- 5) press the up arrow and the display will change to `YES`
- 6) press enter and the display will change to `rERd`. The drive will then read the data from the encoder, update the motor parameters and reload all drive data.

This process will load motor parameters LF.10...LF.19, LF.27, LF.34...LF.35 and LF.77. Since the commutation position (LF.77) is also loaded this process eliminates the need to learn the position. Therefore refer only to section 5.11.4 regarding the start up of a PM motor.

Initial Start Up

5.8.4 Other encoder adjustments

Enter in LF.27 the pulses per revolution of the encoder, i.e. 1024, 2048, 4096 etc.

LF.28 can be used to swap the encoder channels such that the encoder is incrementally counting in the same direction as the motor. Initially leave this parameter set to 0 or no reversal. Whether or not reversal is necessary will be determined later in section 5.11

LF.29 sets the sample time for the speed measurement. Initially the default setting of 4 mSec will work fine.

Set up of the encoder is complete!

5.9 Controller Settings

The speed and torque controller are adjusted in parameters LF.30 through LF.36. For initial start up the default settings will work. Once the elevator is running at high speed, it might be necessary to come back to adjust LF.31... LF.33. LF.34 and 35 are adjusted automatically by the drive and should require no adjustment by the user.

LF.30 is the one parameter which will need to be adjusted for initial operation. If operating open loop set LF.30 = 0 and if operation is closed loop speed or torque control initially set LF.30 = 2. Once the proper direction of rotation is established LF.30 can be changed to a value of 4 if torque control is ultimately desired.

Set up of the controller is complete!

5.10 Speed and Profile Settings

The speeds are adjusted through parameters LF.41...LF.45. The profile is adjusted through parameters LF.50...LF.53.

When operating with digital speed selection and control, each speed must be adjusted respectively.

LF.41 = Leveling speed LF.42 = High speed
LF.43 = Inspection speed LF.44 = high leveling speed
LF.45 = intermediate speed

The default settings for the profile parameters LF.50...LF.53 are a good place to start. When operating with analog speed or torque control, only high speed must be adjusted to the contract speed value. In addition the profile parameters must be adjusted such that the internal ramp generator in the drive is disabled. This can be done with the following settings:

LF.50 Start Jerk = 32 ft/sec³ LF.51 Acceleration = 12 ft/sec²
LF.52 Decel Jerk = 32 ft/sec³ LF.53 Deceleration = 12 ft/sec²

Set up of the speeds and profiles are complete!

5.11 Running the Motor

5.11.1 Absolute Encoder Setup (no ropes)

HIPERFACE, ENDAT, SIN/COS Encoders

The following will outline the procedure for aligning an absolute encoder for use with a permanent magnet motor and the following encoders: Hiperface, Endat, SIN/COS. The motor must be mounted in place and be electrically connected to the elevator controller. The motor encoder must also be connected to the controller. The motor must be able to spin freely either by mechanically releasing the brake or through normal electrical release.



If at any point during the set up process, if the drive should give the error E.ENCC, the display will change automatically to 2.LF.26 and display the error code from the encoder. Refer to parameter LF.26 for further information.

Initial Steps

- 1) Verify the motor is correctly connected to the drive, i.e. phase U->U, V->V, W->W. With PM motors you can not have an arbitrary phasing. If direction reversal is required, the system direction can be reversed in LF.28.
- 2) Verify the correct mode of operation. LF.4 should be set to either PCL5d or P9L55. If this is not the case see parameter US.10 to change the configuration mode.
- 3) Set LF.3 to conf for configuration mode.
- 4) Enter the motor data and machine data in parameters LF.10 to LF.25. Learn the motor data if it is not known.
- 5) Verify the correct encoder feedback card is installed in the drive. See parameter 0.LF.26. Enter the encoder ppr in parameter LF.27. Make sure the sample time (LF.29) is set to 4mSec.

Rotation Direction Verification

- 1) Lower LF.76 to a value of 4.
- 2) Set the display to parameter ru.54.
- 3) Manually release the brake and then manually rotate the motor in the clockwise direction (*clockwise when facing the motor sheave opposite the side the encoder is mounted on*). Take note of the value in ru.54. The value should be counting up or counting down.
 - If it is counting up the encoder direction is correct and the verification is complete.
 - If it is counting down the direction is reversed. In this case change LF.28 from 0 to 1 and rotate the motor again to verify the value of ru.54 is now counting up.
 - If the value does not change even when the motor is turning constantly in one direction, one or more of the encoder channels is not connected properly. Verify all encoder connections.

Initial Start Up

Alignment Process

- 1) Adjust LF.3 = conF
- 2) Set LF.77 = 2206, the display will say PASS and then change to a number.
- 3) Press and hold the inspection up switch. Motor current will begin to flow in one phase and the current will ramp up to the motor's rated value. The motor sheave should turn slowly and then stop when the motor rotor has lined up with one of the motor poles. The display should change from the value 2206 to a value which represents the actual encoder position in relation to the motor pole. Once this value is stabilized, the alignment has been found. Continue holding the inspection switch as the drive will then try to move the motor clockwise and counter clockwise to verify the motor's rotation is consistent with the encoder's. During this process the drive will display cdd in parameter LF.99. The entire process will take about 15 seconds. If the motor keeps rotating for more than 20 seconds, the phasing between the encoder and the motor is not correct. Change LF.28 as described in step 4 below and repeat the process.
- 4) If the drive triggers the error E.ENC1, the motor's rotation is backwards from the encoder. Release the inspection switch. If LF.28 is 0 then change the value to 1. If LF.28 is 1 change the value to 0. Go back to step 1 and try the adjustment process again.
- 5) Once this process is complete make note of the final position number from LF.77 in the job information. This position number is valid only for this motor and encoder. If the encoder is physically removed from the motor, this process will need to be done again.

Return to Normal Operation

- 1) Put the drive into run mode by setting LF.3 to run.
- 2) Run the motor on inspection up and down. The speed displayed in LF.89 should be stable and should match the command speed value in LF.88. Additionally the motor current in LF.93 should be near zero.

5.11.2 Absolute Encoder Setup (with ropes)



The following will outline the procedure for aligning an absolute encoder for use with a permanent magnet motor and the following encoders: HIPERFACE, ENDAT, SIN/COS. The motor must be mounted in place and be electrically connected to the elevator controller. The motor encoder must also be connected to the drive. In this case the ropes are already on the motor.

At a certain point in the process, it will be necessary to put balanced load into the car to carry out this adjustment.

If at any point during the set up process, if the drive should give the error E.ENCC, the display will change automatically to 2.LF.26 and display the error code from the encoder. Refer to parameter LF.26 for further information.

Initial Steps

- 1) Verify the motor is correctly connected to the drive, i.e. phase U->U, V->V, W->W. With PM motors you can not have an arbitrary phasing. If direction reversal is required, the system direction can be reversed in LF.28.
- 2) Verify the correct mode of operation. LF.4 should be set to either PCL5d or P9L55. If this is not the case see parameter US.10 to change the configuration mode.
- 3) Enter the motor data and machine data in parameters LF.10 to LF.25. Learn the motor data if it is not known.
- 4) Verify the correct encoder feedback card is installed in the drive. See parameter 0.LF.26. Enter the encoder ppr in parameter LF.27. Make sure the sample time (LF.29) is set to 4mSec.

Balancing the car

The following steps are necessary if the car is not at floor level and the weights can not be loaded into the car. Therefore it is necessary to drive the car to a floor.

- 1) Adjust parameter LF.36 equal to LF.17.
- 2) Set the inspection speed to a relatively low value 10-15ft/min.
- 3) Adjust parameter LF.77 to 16,000.
- 4) Try to run the car on inspection up or down. (note the motor will make a loud noise and the control of the motor will be poor.
- 5) If the car fails to move go back to step 3 and change the value to 32,000, 48,000, or 64,000. Try to move the car again after each value.
- 6) Once you find a value which gives some movement you may need to add or subtract 8,000 to increase the torque output of the motor (i.e. you can move a little but the motor does not seem to have enough torque).
- 7) At this point if there is a long distance to cover in the hoist way, the inspection speed can be raised to a higher value.

Balance the car such that when the brake opens, the car does not move at all. It might be necessary to let the car drift until it reaches an equilibrium.

Initial Start Up

Alignment Process

- 1) Adjust LF.3 = conF
- 2) Set LF.77 = 2206, the display with say PASS and then change to a number.
- 3) Press and hold the inspection up switch. Motor current will begin to flow in one phase and the current will ramp up to the motor's rated value. The motor sheave should turn slowly and then stop when the motor rotor has lined up with one of the motor poles. The display should change from the value 2206 to a value which represents the actual encoder position in relation to the motor pole. Once this value is stabilized, the alignment has been found. Continue holding the inspection switch as the drive will then try to move the motor clockwise and counter clockwise to verify the motor's rotation is consistent with the encoder's. During this process the drive will display cdd in parameter LF.99. The entire process will take about 15 seconds. If the motor keeps rotating for more than 20 seconds, the phasing between the encoder and the motor is not correct. Change LF.28 as described in step 4 below and repeat the process.
- 4) If the drive triggers the error E.ENC1, the motor's rotation is backwards from the encoder. Release the inspection switch. If LF.28 is 0 then change the value to 1. If LF.28 is 1 change the value to 0. Go back to step 1 and try the adjustment process again.
- 5) If the error E.ENC1 is triggered regardless of the adjustment of LF.28, it may be there there is too much friction and the motor can not turn. Open the brake and move the car manually (a quarter turn of the motor sheave) and try the process again.
- 6) Once the this process is complete make note of the final position number from LF.77 in the job information. This position number is valid only for this motor and encoder. If the encoder is physically removed from the motor, this process will need to be done again.

Return to Normal Operation

- 1) Put the drive into run mode by setting LF.3 to run.
- 2) Run the motor on inspection up and down. The speed displayed in LF.89 should be stable and should match the command speed value in LF.88. Additionally the motor current in LF.93 should be near zero.

5.11.3 Absolute Encoder Position Verification

Verification of the encoder position.

Friction and the inertial load of the cab and counter weights can lead to a small error in the actual position value. The following procedure will verify whether the position is correct or not.

- 1) Set LF.36 = to two times LF.17.
- 2) Pick two floors in the middle of the shaft which are far enough apart such that the car reaches contract speed
- 3) Run the car between these floors and monitor LF.94 (peak phase current). Note the peak value for both the up and down run. The stored maximum value is cleared by pressing the down arrow. Make several runs to establish the average value in each direction.
- 4) Add 2000 to the value in LF.77 and run the car again between the same two floors. If the current value goes down then go to step 5. If the current value goes up go to step 6.
- 5) Add 2000 more to the value in LF.77 and run the car again. If the peak current in LF.94 goes down further, add 2000 more and try again. Keep doing this until the motor current begins to rise again. The value with the lowest current is the best value. Jump to step 7.
- 6) If the current went up initially, then lower LF.77 by 2000 and run the car again. If the peak current in LF.94 goes down further, subtract 2000 more and try again. Keep doing this until the motor current begins to rise again. The value with the lowest current is the best value.
- 7) Return the value of LF.77 to the value which gave the lowest current. Make note of this value in the job information for future reference.

Initial Start Up

5.11.4 Encoder Synchronization

TTL, HTL, SIN/COS Encoders with induction motors

It is necessary to determine whether or not the motor encoder is in phase with the rotation of the motor. As an example the motor is turning clockwise and the encoder is indicating clockwise rotation. The problem comes when the encoder indicates rotation opposite to the actual rotation of the motor. Depending on whether the system is operating in speed control mode or torque control mode it will be necessary to follow one of the following two procedures.

Speed Control, LF.30 = 2

To determine whether or not the encoder is aligned with the motor run the car on inspection in both the up and down direction. If the motor turns out of control, at the wrong speed, or the current going to the motor (see LF.93) is greater than the motor FLA, the encoder is reversed. This can be corrected by adjusting parameter LF.28 from 0 to 1.

Run the car again in both the up and down direction. The motor should now be running in a controlled manner but possibly in the wrong direction, meaning up inspection drives the car down or down inspection drives the car up. Parameter LF.28 can also be used to correct this. If LF.28 = 0 then change the value to 2. If LF.28 = 1 then change the value to 3. Now the motor should be controlled and run in the correct direction.

Torque Control, LF.30 = 4

To determine whether or not the encoder is aligned with the motor run the car on inspection in both the up and down direction. If the motor turns out of control, at the wrong speed, or the current going to the motor (see LF.93) is greater than the motor FLA, the encoder is reversed. This can be corrected by adjusting parameter LF.28. You will need to try all possible settings, LF.28 = 0,1,2,3. One of them should give you controlled operation of the motor and motor current below the FLA of the motor. However the direction of travel of the car in the hoist way may be reversed. If this is the case change LF.28 as described below and reverse the speed reference direction in the elevator controller.

Changes to LF.28 to reverse car direction

0 -> 2	1 -> 3
or	or
2 -> 0	3 -> 1

Changes to LF.28 to reverse encoder counting direction

0 -> 1	2 -> 3
or	or
1 -> 0	3 -> 2

6. Parameter Description

6.1 US-Parameters

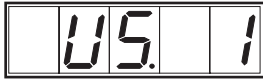

Password

With different passwords different parameter groups can be accessed for advanced programming.



LF Parameter Reset

By selecting LoAd and pressing ENTER, all the LF parameters are returned to the factory default values. Note the display will automatically change to show the value of LF.99 upon successful loading of the default values.

Adjustment value: LoAd = reset all LF parameters

Displayed responses: PASS = default successful
bdPAS = default not successful

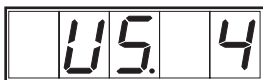

Load Configuration

By selecting LoAd and pressing ENTER, the selected configuration file in US.10 and all the existing LF parameter values will be loaded into the drive. *Note: if the configuration is changed in US.10, the LF parameter values are returned to the factory default values. In this case, this should be done before any programming of the drive is carried out as all parameters will be cleared.* The display will change automatically to LF.99 upon successful loading of the configuration. The process may take several seconds.

Adjustment value: LoAd = Load Configuration

Displayed responses: Pro9 = Loading configuration
PASS = Load successful
bdPAS = Load not successful

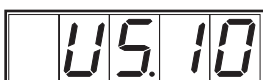

Select Configuration

This parameter allows the user to select which mode the drive will operate in. The possibilities are closed loop induction motor, closed loop permanent magnet motor, and low speed gearless modes. Select from the list below and then load the configuration file into the drive through parameter US.4.

Adjustment value: ICL5d = Closed loop induction
I9L5S = Closed loop induction gearless
PCL5d = Closed loop permanent magnet
P9L5S = Closed loop permanent magnet gearless

Parameter Description - Basic Set Up

Other US parameters

These US parameters are special parameters which are not needed in every application. They are turned off by default by the control manufacturer. The following serves only as a list of these parameters. For further adjustment refer to section 8.0.

US. 8	Parameter Access
US.14	Comm Error Para Address
US.15	Comm Error Data
US.16	E.OL2 function
US.17	Pretorque Timer-Ramp Up
US.18	Pretorque Timer-Ramp Dwn
US.19	Field Weakening Corner
US.20	Max speed for max Ki
US.21	Speed for min Ki
US.22	Speed dependent Kp Gain
US.23	Min KPgain at high speed
US.24	KD speed gain
US.25	Phase current check
US.26	Encoder diagnostic
US.27	Power Unit Code
US.28	HSP5 Watchdog Time
US.29	Analog input zero volt clamp
US.30	Encoder Memory R/W
US.31	KP Synth. Pre-Torq.
US.32	KI Synth. Pre-Torq.
US.33	E.dOH Function

6.2 LF-Elevator Parameters



Signal Operating Mode

This value determines the type of speed selection and rotation setting.

Value range:

AbSPd	= Absolute Analog Speed
d SPd	= Digital Speed Selection
A tor	= Analog Torque Control
A SPd	= Analog Speed Control
SErSP	= Serial Com. Speed Control

Factory setting: d SPd

Value	Control mode	Direction Selection
AbSPd	Abs. Analog Spd. Control 0...+10V terminals X2A.1, X2A2	terminals X2A.14 & X2A.15
d SPd	Digital Speed Control terminals X2A.10, X2A.11, X2A.12,X2A.13	terminals X2A.14, X2A.15
A tor	Analog Torque Control -10V...0... +10V terminals X2A.1, X2A2, X2A.3, X2A4	terminal X2A.14, does not determine direction used only for triggering the start sequence
A SPd	Analog Speed Control -10V...0...+10V terminals X2A.1, X2A2	terminals X2A.14 & X2A.15 do not determine direction. Used only for triggering the start sequence
SErSP	Digital Serial Speed Control Serial communication 16 bit signed speed value	Serial communication 16 bit control word

When LF.2 = A tor then: max. system speed is approximately 110% of (LF.20)

When LF.2 = AbSPd or A SPd then: 0 ... ±10V = 0 ... ± max. system speed (LF.20)

a) Analog set speed selection LF.02 = Ab5Pd

A unipolar analog signal is connected to the terminals X2A.1(+) and X2A.2 (-). Terminals X2A.3 and X2A.4 can be used for pre-torque input.



0 ... 10V = 0 ... max. system speed (LF.20)

Terminals X2A.14 and X2A.15 are used to select direction and activate the start and stop routine. The directions below must be followed in the exact sequence they are listed:

- Start:
- 1.) Enable on X2A.16=on
 - 2.) "Direction" input terminal (X2A.14 = on or X2A.15) = on
 - 3.) Drive commences current check and magnetizes the motor when ready it will activate the DRO output X2A.27...29.
 - 4.) Give analog speed signal
- Stop:
- 1.) Analog signal => 0V
 - 2.) Terminal X2A.14 / X2A.15 = off
 - 3.) Enable X2A.16=off after the sum of the times adjusted in LF.78 and LF.79.

b) Input coded set speed selection LF.02 = d 5Pd
(Default setting)

Digital speed setting uses preset digital values in the drive as command speeds. The drive creates the driving profile between selected speeds.

	X2A.10	X2A.11	X2A.12	X2A.13			
Speed =0	0	0	0	0			
S _{Leveling}	1	0	x	x			
S _{High Leveling}	0	1	x	x			
S _{Intermediate}	1	1	x	x			
S _{High}	0	0	1	x			
S _{Inspection}	0	0	0	1			

Symbol: 1 = Input is active
 0 = Input is not active
 X = Setting has no effect or don't care

c) Analog Torque control LF.02 = R tor

The differential analog signals are connected to the terminals X2A1(+) and X2A2(-) and X2A3(+) and X2A4(-). The actual torque command is the sum of the differential inputs.

Torque command = $(X2A1 - X2A2) + (X2A3 - X2A4)$



In a torque controlled system the maximum speed is controlled by the elevator control not the drive. However for safety reasons the drive will internally limit the speed to 110% of LF.20 or contract speed.

Terminal X2A.14.5 is used to activate the starting and stopping routine. The directions below must be followed in the exact sequence they are listed:

- Start:**
- 1.) Enable X2A.16=on
 - 2.) Select direction input X2A.14
 - 3.) Drive commences current check and magnetizes the motor when ready it will activate the DRO output X2A.27...29.
 - 4.) Controller gives analog torque signal

- Stop:**
- 1.) Analog signal => 0V
 - 2.) Direction X2A.14 = off
 - 3.) Enable X2A.16=off after the sum of the times adjusted in LF.78 and LF.79.

d) Analog set speed selection LF.02 = R SPd

A Differential analog signal is connected to the terminals X2A.1(+) and X2A.2 (-). Terminals X2A.3 and X2A.4 can be used for pre-torque input.



0 ... ±10V = 0 ... ±max. system speed (LF.20)

Terminals X2A.14 and X2A.15 are used to activate the start and stop routine. The directions below must be followed in the exact sequence they are listed:

- Start:**
- 1.) Enable on X2A.16=on
 - 2.) "Direction" input terminal (X2A.14 = on or X2A.15) = on
 - 3.) Drive commences current check and magnetizes the motor when ready it will activate the DRO output X2A.27...29.
 - 4.) Give analog speed signal

- Stop:**
- 1.) Analog signal => 0V
 - 2.) Terminal X2A.14 / X2A.15 = off
 - 3.) Enable X2A.16=off after the sum of the times adjusted in LF.78 and LF.79.

Parameter Description - Basic Set Up

e) Digital serial communication LF.02 = 5Er5P

Serial communication is used to control the drive and provide a speed and pre-torque command. The serial communication can also provide the drive status, actual speed and actual motor torque back to the controller. Consult the manufacture for more information on implementing this control scheme.

Digital commands to the drive

The command speed is a 16 bit signed value representing the motor speed.

The control word is a 16 bit value which is used to digitally activate the inputs (enable, direction, reset, etc).

The pre-torque is an 11 bit signed value which is used to provide roll back compensation.

Digital commands from the drive

The actual speed is a 16 bit signed value representing the actual motor speed as measured by the encoder.

The status word provides the status of the drive in addition to the output conditions.

The actual torque provides the torque value back to the controller.



In this mode parameter changes on the keypad are locked out while LF.3 = run. Parameters can be viewed at any time. With the car stopped, change LF.2 = conf to change the parameters manually via the keypad.

Additionally, once in run mode, the drive must see a serial communication request at the X4 serial port at minimum every 100mSec. If not the drive will trigger an E.BUS fault.



Drive Configuration

This parameter is used to put the drive into configuration mode. In this mode the encoder position can be learned as well as the PM motor data. When in configuration mode the drive does not respond to the direction input and therefore the motor will not run. However the drive will provide a DRO signal when enabled to satisfy the logic of the elevator control.

This parameter also can be used to activate the auto tune function (S Lrn) for PM motors. See section 5.6.3.

Value range: run ... conF ... EconF ... S Lrn
 Factory setting: conF



This parameter is time limited for safety. Once conF is activated you have 5 minutes to complete the alignment or measurement process. After the timer runs out, the mode will change to EconF (expired configuration mode). It will be necessary to change back to conF thus resetting the timer to continue. Once all set up is complete set this parameter to run.



Motor-Selection

This parameter displays the current mode of operation, open or closed loop, geared or gearless, induction motor, synchronous motor. The parameter is read only.

Possible displays:

- ICLSd = Closed loop induction
- I9L55 = Closed loop induction gearless
- PCLSd = Closed loop permanent magnet
- P9L55 = Closed loop permanent magnet gearless



Drive Fault Auto Reset

With LF. 5 all drive faults can be automatically reset.

The number adjusted in this parameter determines how many times per hour the elevator drive will automatically reset faults. Before resetting the fault, the drive will wait 4 seconds to allow everything to stop or stabilize. It is not fault specific, so with the default setting of 3, if the drive experiences 4 different faults in one hour the unit will latch the last fault and not reset. See parameter LF.98 for fault history information.

Unit: 1
 Value range: 0...10
 Factory setting: 3

Note: a setting of "0" means no fault resets.

Parameter Description - Basic Set Up



Electronic Motor Overload Protection

This parameter is used to activate and select the type of motor overload function. Depending on the setting of this parameter, the Elevator Drive will trigger a drive fault E.OH2 causing the motor to stop. The trigger level is established in parameters LF.9 or LF.12

Value range: off...on
Factory Setting: off
Adjustment value: as required



This function must be activated to ensure the motor protection function is operational!

The trip curve is in accordance with VDE 0660 Part 104, UL508C section 42, and NEC 430 part C. It is defined as follows:

- 100% of trip current => continuous running
- 120% of trip current => trip after 2 hours
- 150% of trip current => trip after 2 minutes
- 200% of trip current => trip after 1 minute
- 800% of trip current => trip after 5 seconds

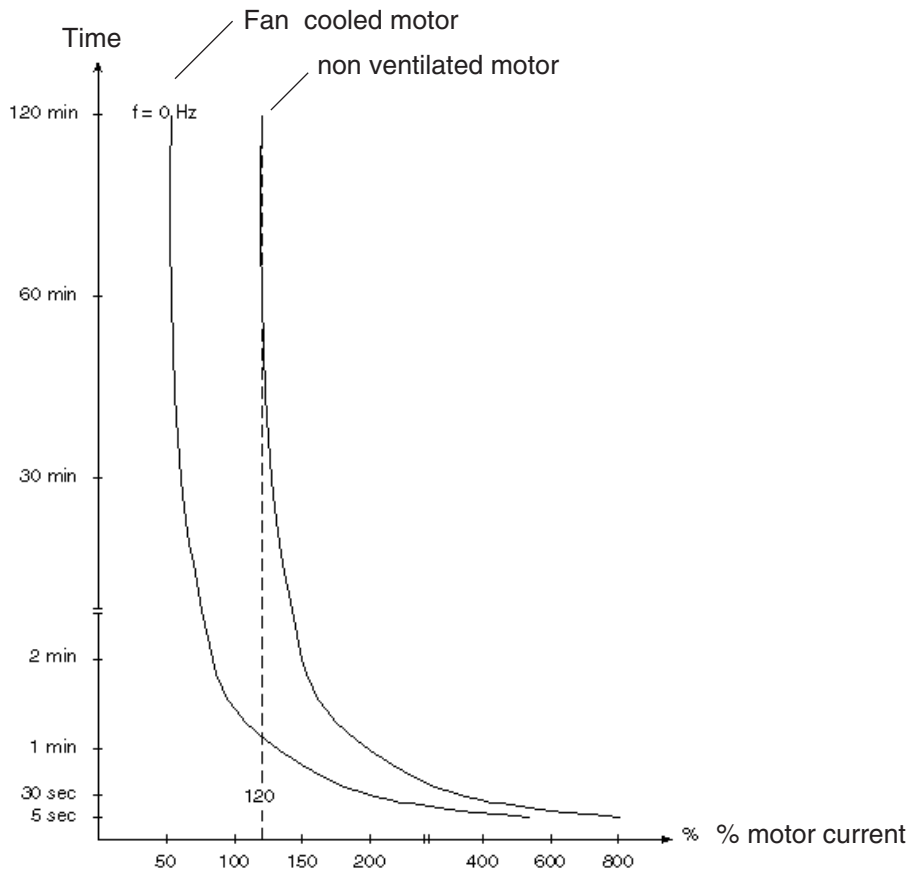



The following parameters configure the COMBIVERT Elevator Drive to the particular motor. Correct adjustment of these parameters is critical for proper operation of the system. Depending on the mode of operation the units and or range of acceptable values may change. Parameters LF10 through LF.19 have dual functions depending on the type of motor.

For induction motor configuration modes the parameter information will be indicated with the symbol



For synchronous permanent magnet motors, configuration mode the parameter info will be indicated with the symbol



**Electronic
Overload
Current**



This parameter sets the current threshold in amps above which the Elevator drive activates the motor overload function.

Unit: ampere
 Value range: 1.0...1.1 x drive rated current
 Factory Setting: 8.0A
 Adjustment value: in accordance with motor nameplate



For PM motors the current threshold is set equal to the rated motor current in LF.12. Therefore this parameter is not visible.



Rated Motor Power



Enter the rated power of the motor.

Unit: hp
 Value range: 0.0...125 hp
 Factory setting: 5.0 hp
 Adjustment value: in accordance with the motor name plate



The power value is calculated from the torque and speed. Therefore this parameter becomes read only.

Parameter Description - Motor Data



Rated Motor Speed



Unit: rpm
 Value range : 10.0...6000.0 or 500.0
 (based on config mode)
 Factory setting: 1165.0 or 150.0
 (based on config mode)

Adjustment value: in accordance with the motor name plate



You may not enter the motor-synchronous speed (e.g. 1800 rpm for a 4 pole motor, 1200 rpm for a 6 pole motor, and 900 rpm for a 8 pole motor). Ask the manufacturer for the motor rated speed if you cannot find it on the name plate or use the following example to estimate the rated speed.

Example: If the name plate reads 1200 rpm (synchronous speed) then the value that should be entered must be lower. For starting purposes, one can estimate the slip at about 2.9%. Then through running the elevator it is possible to determine whether further adjustments are necessary. 2.9% of 1200 is 35 rpm. So for starting, use the value $1200 - 35 = 1165$ rpm which is the default value.

LF.11 Valid Adjustment Range for 60Hz motors

From this parameter along with the rated frequency in LF.13, the COMBIVERT Elevator Drive calculates the number of motor poles. As a result there are limits as to how low the value can be adjusted for a motor with a certain number of poles. Refer to the table to the right for the valid adjustment range of 60Hz motors.

4 poles	1201...1799 rpm
6 poles	901...1199 rpm
8 poles	721...899 rpm
10 poles	601...719 rpm

Recommend values for LF.11 when using modern 6 pole 60Hz, elevator motors

With modern low slip elevator motors it is often advantageous to enter a rated motor speed which is slightly higher than the name plate speed. This results in a lower calculated slip and in many cases reduces the motor current and offers smoother ride performance.

Motor Name Plate	Adder Value	Value in LF.11
1180	5	1185
1175	6	1181
1170	8	1178
1165	9	1174
1160	10	1170
1155	11	1166
1150	13	1163

LF.11 Rated motor speed continued.

Once all the other parameter adjustments are made it may necessary to come back to parameter LF.11 in order to fine tune the operation of the elevator drive with the motor. The parameter LF.11 will determine how much torque the motor can produce and has influence over the following aspects of operation:

- motor current
- motor's lifting capability
- motor's ability to run at contract speed
- motor's ability to track the commanded speed
- sloppy behavior or random overshoot of floors
- motor vibration or jerkiness
- motor audible noise

The following steps can be used to fine tune the adjustment of LF.11

- 1) To start the adjustment, set LF.11 to the nameplate motor speed on the motor.
- 2) Run up and down about mid shaft between the same floors.
- 3) If the motor can not lift the load (empty car down) or if it is having trouble getting to contract speed then start decreasing LF.11 in steps of 10 rpm.
- 4) Once the motor is able to lift the car or reach rated speed empty car down, check the current in LF.93. If the current is higher than the nameplate FLA of the motor then raise LF.11 in steps of 5 rpm until the motor current drops to a lower level.



LF.11 Adjustment trends

LF.11	lower values	higher values
motor current	higher	lower
lifting capability	better	worse
run at contract speed	better	worse
speed tracking	better	worse
sloppy behavior	better	worse
motor vibration	higher	lower
motor audible noise	higher	lower

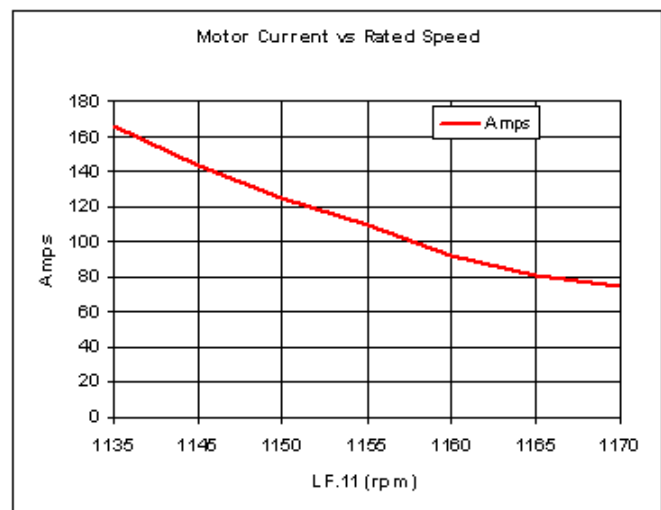

This graph shows an example between motor current while running empty car down and the adjustment of LF.11. In this case the motor nameplate speed was 1165 rpm and the FLA was 96A.

Parameter Description - Motor Data

LF.11

Rated Motor Speed



Unit: rpm
Value range : 10.0...6000.0 or 500.0
(based on configuration mode)
Factory setting: 1165.0 or 150.0
(based on configuration mode)

Adjustment value: in accordance with the motor name plate

For permanent magnet synchronous motors there is no slip. Therefore the value entered must be exactly the value on the name plate of the motor. With this there is no further adjustment necessary. Do not round this value off to the nearest whole number. This speed value must be exactly the value as calculated below.

$$\text{LF.11} = \frac{\text{LF.13} \times 120}{\text{motor poles}}$$

LF.12

Rated Motor Current



Enter the motor nameplate rated current (FLA).



Unit: ampere
Value range: 1.0...1.1 x Inverter rated current
Factory setting: 8.0 A
Adjustment value: in accordance with the motor name plate

LF.13

Rated Motor Frequency



Enter the exact rated frequency of the motor.



Unit: hertz
Value range: 4.0...100.0 Hz
Factory setting : 60.0 Hz
Adjustment value: in accordance with the motor name plate

LF.14

Rated Motor Voltage



Enter the name plate rated voltage.

Unit: volt
 Value range: 120...500 V
 Factory setting: 230 or 460 V based on drive voltage
 Adjustment value: in accordance with the motor name plate



Enter the no load phase to phase back EMF rms voltage at rated speed (LF.11).

Unit: Vrms / at rated speed
 Value range: 1...32000 V/krpm
 Factory setting : none
 Adjustment value: in accordance with the motor name plate



Note: On older software versions this parameter displayed volts peak at 1000 rpm. So the value was significantly higher (i.e. greater than 1000V). When upgrading to the newer software this value must be recalculated using the new method (Vrms at rated speed)

To convert the old value from V1.3 to the new value for V1.4 use the following equation:

$$V1.4 \text{ value for LF.14} = \frac{V1.3 \text{ value} \times LF.11}{1000 \times 1.414}$$

LF.15

Power Factor



This parameter is not the efficiency of the motor but the ratio of the magnetizing current to the total phase current of the motor. Lower power factor values will increase the magnetizing current to the motor and thus increase the field strength resulting in tighter control of the motor. Higher values decrease the magnetizing current and the field strength.

Unit: 1
 Value range: 0.50...1.00
 Factory setting: 0.90
 Adjustment value: in accordance with the motor name plate

Note: If not known, a value of 0.9 is recommended for old high slip motors and a value of 0.65 is recommended for gearless induction motors.



For PM motors this parameter is not required and therefore is not visible.

Parameter Description - Motor Data



Field Weakening Speed



The field weakening speed determines at which speed the peak torque limit starts being reduced. It is necessary to reduce the peak torque limit of the motor since the drive's ability to force current into the motor is limited by the applied voltage as rated speed is reached.

If the drive tries to demand more torque than the motor can produce given the available voltage and actual motor speed, it is possible that the breakdown torque of the motor will be exceeded and as a result the motor will appear to stall and run at less than desired speed.

Generally this phenomenon can be identified in one of two ways. First, after having decreased the rated speed (LF.11) it was not possible get the motor to run at contract speed or it was not possible to run at contract speed without excessive current. Secondly, the motor reaches contract speed but only for a brief second and then drops to a lower speed. In both cases the motor is being driven beyond what it is capable of producing. As a result the peak torque command must be further limited in order to maintain control of the motor.

The solution is simply to reduce the value of LF.16 to about 60% of synchronous speed (720 rpm for a 1200 rpm motor). A setting of 45% of synchronous speed should be used as the practical lower limit of this parameter.

Unit: rpm
 Value range: 0.0...6000 rpm
 Factory setting: 960.0 rpm
 Initial adjustment value: approx. 80% of synchronous speed

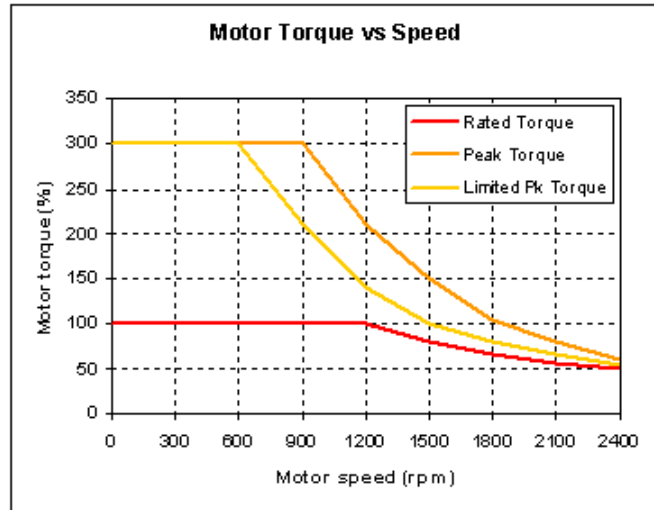

For PM motors this parameter is not necessary and therefore is not visible.

LF.17

Rated Motor Torque



For IM the torque value is calculated from the rated speed (LF.11) and rated power (LF.10). Therefore this value is read only.

Unit: lb ft
 Value range: 1...10000 lb ft
 Factory setting: Calculated



For PM motors the torque value must be entered and is used to establish the torque constant. Enter the rated name plate torque.

Unit: lb ft
 Value range: 1...10000 lb ft
 Factory setting: 18 lb ft
 Adjustment value: enter the motor name plate value

Some motors have the torque stated in Nm. To convert Nm to lb ft: multiply Nm by 0.738.

Parameter Description - Motor Data

LF.18

Motor Stator Resistance



This parameter not required for closed loop induction motor operation and will not be visible in these modes.



For PM motors enter the phase to phase resistance value. Some motor manufacturers list the per phase value therefore you must multiply by two. This value can also be measured by the drive's auto-tune function, see parameter LF.3. Incorrect settings of this parameter could lead to oscillation in the current control and audible noise in the motor, since the regulator values for the current control are calculated from this value.

Unit: ohms
Value range: 0.000...49.999
Factory setting: 49.999
Adjustment value: enter the motor resistance value

LF.19

Motor Leakage Inductance



This information is not used for induction motors and therefore the parameter is not visible in induction motor mode.



This is the total phase to phase reflected leakage inductance of the motor winding. The inductance listed on the manufacturer's data sheet will most likely be for one phase. So it will be necessary to multiply the value by two and then enter it into the drive. This value can also be measured by the drive's auto-tune function, see parameter LF.3. Incorrect settings of this parameter could lead to oscillation in the current control since the regulator values for the current control are calculated from this value.

Unit: mH
Value range: 0.01...500.00
Factory setting: 1.00
Adjustment value: enter the value from the manufacturer's data sheet.



The following parameters relate to the machine data of the elevator. It is important to enter the correct values, such that both the motor and the car run at the correct

LF.20

Contract Speed

This is the elevator contract speed.

The speeds adjusted in parameters LF.42, LF.43, LF.44 and LF.45 are limited by LF.20. Other internal values are calculated from LF.20.

With an analog speed signal the following is valid:

$$0 \dots \pm 10V = 0 \dots \pm \text{contract speed (LF.20)}$$

Unit: feet per minute
 Value range: 0...1600ft/min
 Factory setting: 0 ft/min
 Adjustment value: maximum speed of the system



If the motor does not run at the correct speed do not adjust this parameter! See parameter LF.22.

LF.21

Traction Sheave Diameter

Unit: Inches
 Value range: 7.00...80.00 in
 Factory setting: 24.00 in
 Adjustment value: measure the sheave diameter

LF.22

Gear Reduction Ratio

Enter the actual gear ratio. If the ratio is not known, see parameter LF.25 and enter the value from LF. 25 into LF.22

Unit: 1
 Value range: 1.00 ... 99.99
 Factory setting: 30.00
 Adjustment value: in accordance with the gear name plate,



The ratio can be determined by counting the revolutions of the motor during one rev of the traction sheave.

Once the car is running on high speed, if the measured speed is slightly above or below the contract speed, the gear ratio can be changed slightly to compensate. Higher values in LF.22 will increase the car speed, lower values will decrease the car speed. Make very small changes at first!

Parameter Description - Machine Data

LF.23

Roping Ratio

Unit: 1
Value range: 1...8 (1:1...8:1)
Factory setting: 1
Adjustment value: in accordance with the system data

LF.24

Load Weight

Unit: pounds
Value range: 0...30000lbs
Factory setting: 0 lb
Adjustment value: in accordance with the system

LF.25

Estimated gear ratio

This parameter is read only and will change when adjustments are made to LF.11, LF.20, LF.21 or LF.23.

This parameter can be used to estimate the gear ratio if it is not known. After correctly entering values into LF.11, LF.20, LF.21, and LF.23, read this value and then enter this value into LF.22. Then to verify, run the car at inspection speed, measure the actual speed with a hand tach. If the car speed is slower than the adjusted inspection speed (LF.43), then increase LF.22. If it is higher than the adjusted inspection speed, decrease LF.22.

Note: If LF.20 = 0.00 ft/min the value of LF.25 will be the same as the last calculated value.

Unit: .01
Value range: 1.00...99.99



Encoder Feedback

This parameter is used to manage the encoder interface and its surrounding functionality. Depending on the type of encoder and encoder interface only some of these functions are supported. The parameter has been expanded using an offset number to denote the function.

The function of each offset is denoted below



Displays the type of encoder interface on the drive. Is also used to manually reset E.ENCC errors.



Displays the type of encoder connected to the drive, if the info is available from the encoder.



Displays the status of the encoder interface (encoder faults, etc.)



Provides read/write access to the encoder, allows motor data to be read from or saved to the encoder.

The key strokes below can be used to navigate to the desired offset number.

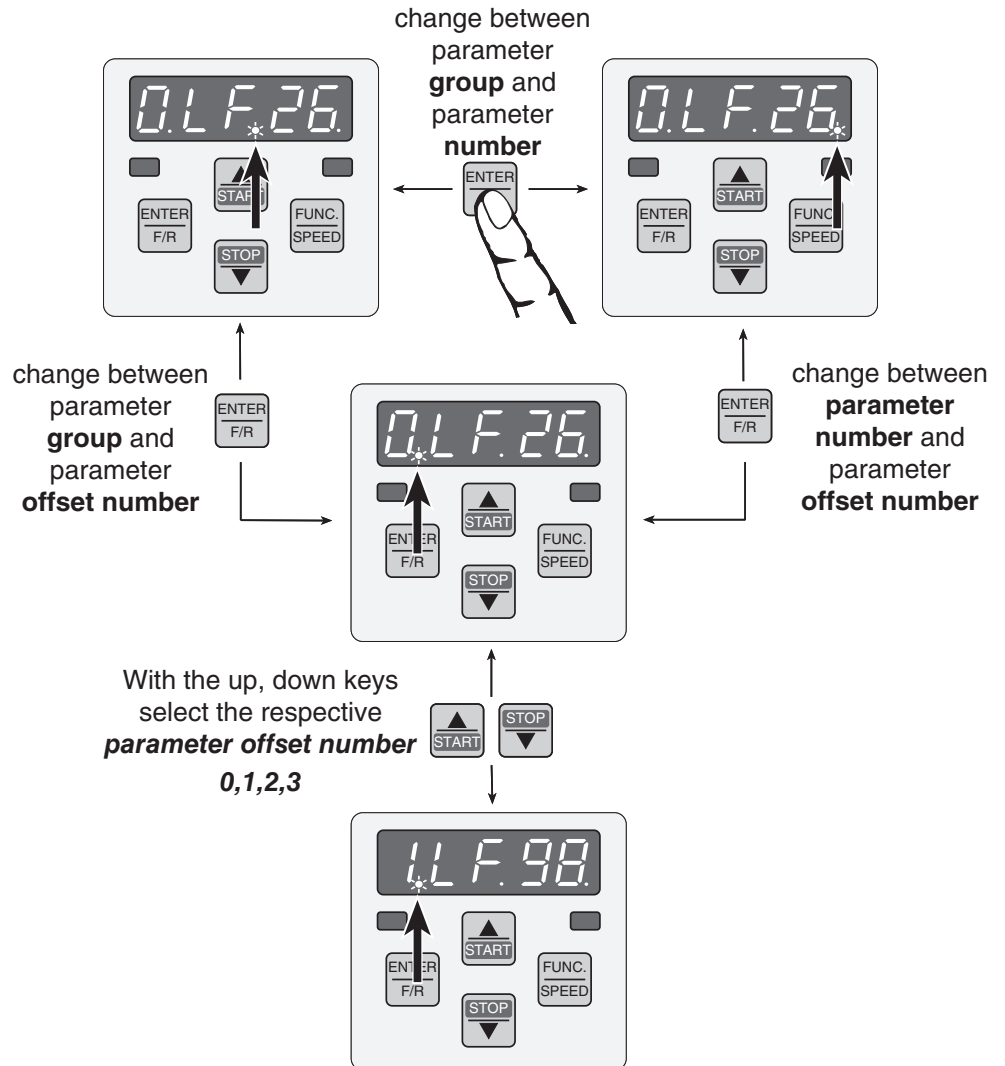

Parameter Description - Encoder Set Up



This parameter displays the type of encoder feedback installed in the drive. It is also used to reset E.ENCC error. Under normal operation this parameter displays the type of encoder feedback card installed in the drive. See the list below.

Additionally, if an E.ENCC error has occurred, and the problem has been corrected, the error can be reset by displaying the value of 0.LF.26 and pressing ENTER. This is the only way to manually reset the E.ENCC error. See 2.LF.26 below for more information on E.ENCC errors.

Display	Channel 1 (X3A)	Channel 2 (X3B)
noInt	No feedback card installed	
SSl	5V TTL incremental	Synchronous Serial Interface, absolute multi turn position encoder
rESoL	Resolver	5V TTL incremental output
HIPeR	Hiperface	5V TTL incremental output
Inc24	15-24V HTL incremental	5V TTL incremental output
IncIE	5V TTL incremental	5V TTL incremental output
SinCo	Sine Cosine / -SSI	5V TTL incremental output
I24PE	15-24V HTL incremental	5V TTL incremental output
EnDat	EnDat	5V TTL incremental output
PhASE	UVW	5V TTL incremental output



This parameter displays the type of encoder connected to the drive. It is only supported by HIPERFACE, EnDat or SIN/COS-SSI encoders.

Operator	Encoder
Display	Type
noEnc	No Encoder Detected
SC567	SCS 60/70
SCn67	SCM 60/70
SinCo	SIN/COS no abs.
SinCo	SIN/COS abs.
SSl	SSI abs.
Sr556	SRS 50/60
Srn56	SRM 50/60
EnDat	EnDat
EnDat	EnDat Single Turn
EnDat	EnDat Multi. Turn
EncUn	Encoder Undefined



This parameter displays the status of the connected encoder along with error messages and in case of a malfunction. It is only supported by HIPERFACE, EnDat or SIN/COS-SSI encoders.

Refer to the table on the following page for possible displays and their meanings.



When the status of the encoder interface changes to a value other than “communication established” conn, and the drive is enabled, the drive will trigger an E.ENCC fault. Press enter and the drive will change the display to this parameter and show the fault code. Once the problem has been corrected, the E.ENCC fault can be cleared by displaying the value of parameter 0.LF.26 and pressing enter.

Parameter Description - Encoder Set Up

2LF26 Fault Codes

Display	Description	Fault cause and solution
conn	Serial Com. Established	Position values are being transferred to the encoder, encoder and serial interface are working.
EncId	Unknown encoder ID	Encoder is an unknown type and does not support the required serial communication protocol. Encoder is the wrong type, i.e. EnDat connected to a HIPERFACE feedback card. Solution: verify encoder type.
bdCbi	Cable break. inc. channels	The interface looks at each incremental channel for the idle voltage value of 2.5V with reference to common (pin 13). If this voltage is not present an error will be triggered with this fault code. Solution: check all signal connections, replace cable with new.
bdCba	Cable break. abs. channels	The interface looks at each data or clock channel for the idle voltage value of 2.5V with reference to common (pin 13). If this voltage is not present an error will be triggered with this fault code. Solution: check all signal connections, replace cable with new.
PoSde	Position deviation too high	The position deviation between the incremental channels and the absolute values is greater than 2.8 degrees. On SIN/COS the comparison is made between occurrences of the zero pulse. Too many or too few counts between the zero pulse will trigger this error. Normally, this is caused by a bad encoder cable and/or poor shielding and grounding of the cable. Solution: replace the cable.
BdPPr	Enc. ppr does not match	Compares the internal value of ppr stored inside the encoder with the setting of LF.27. If they do not match this error code will be activated. Solution: verify correct encoder ppr and enter it in LF.27.
BdInt	Interface Card not recognized	The serial interface card is not recognized by the main CPU of the drive. Replace the feedback card.
bdSuP	Bad internal enc. supply	The internal power supply of the encoder has failed
OHEnc	Encoder over heat	Encoder temp is measure by the encoder and the error is passed on to the drive via serial com.
OSEnc	Encoder over speed	Actual speed has exceeded the max speed of the encoder.
ErEnc	Internal encoder failure	Internal encoder signals are incorrect or out of tolerance. Replace the encoder
ErEnc	Internal encoder failure	Replace encoder
FrtEn	Formatting the encoder	The encoder will be formatted according to the prescribed structure. This will allow further read/write cycles to occur.
nEEnc	New encoder found	The feedback card has recognized that a new or different encoder is now connected to the drive. Therefore it is necessary to confirm. Reenter the values in LF.26,LF.27,LF.77
noFrt	Encoder memory not formatted	Encoder memory structure is not valid and therefore can not be read
EncBS	Encoder is busy	The encoder is busy during data transfer and cannot accept the transmission.
OFF	No com to Enc. Card	There is no communication between the encoder and the drive.

3LF.26

This parameter reads or writes data from or to the encoder. It is only supported by HIPERFACE or EnDat encoders.

When the encoder is supplied pre installed from the motor manufacturer, the motor manufacturer can store the motor data information in the encoder. This allows the end user to simply read out the motor data from the encoder and thus avoid having to enter the motor data, auto tune the motor, or learn the encoder position.



Follow the procedure carefully as it is possible to overwrite the stored data with no chance to recover the stored values.

Reading data from the encoder

Start

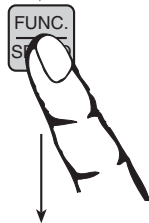

rdEnc

ENTER
F/R

n0

START

YES

ENTER
F/R

rEAd

nOP

Enter YES to confirm. Drive will read encoder data, update the parameter values and then reprogram itself using the new values.

Finished

Parameter Description - Encoder Set Up

Storing data to the encoder

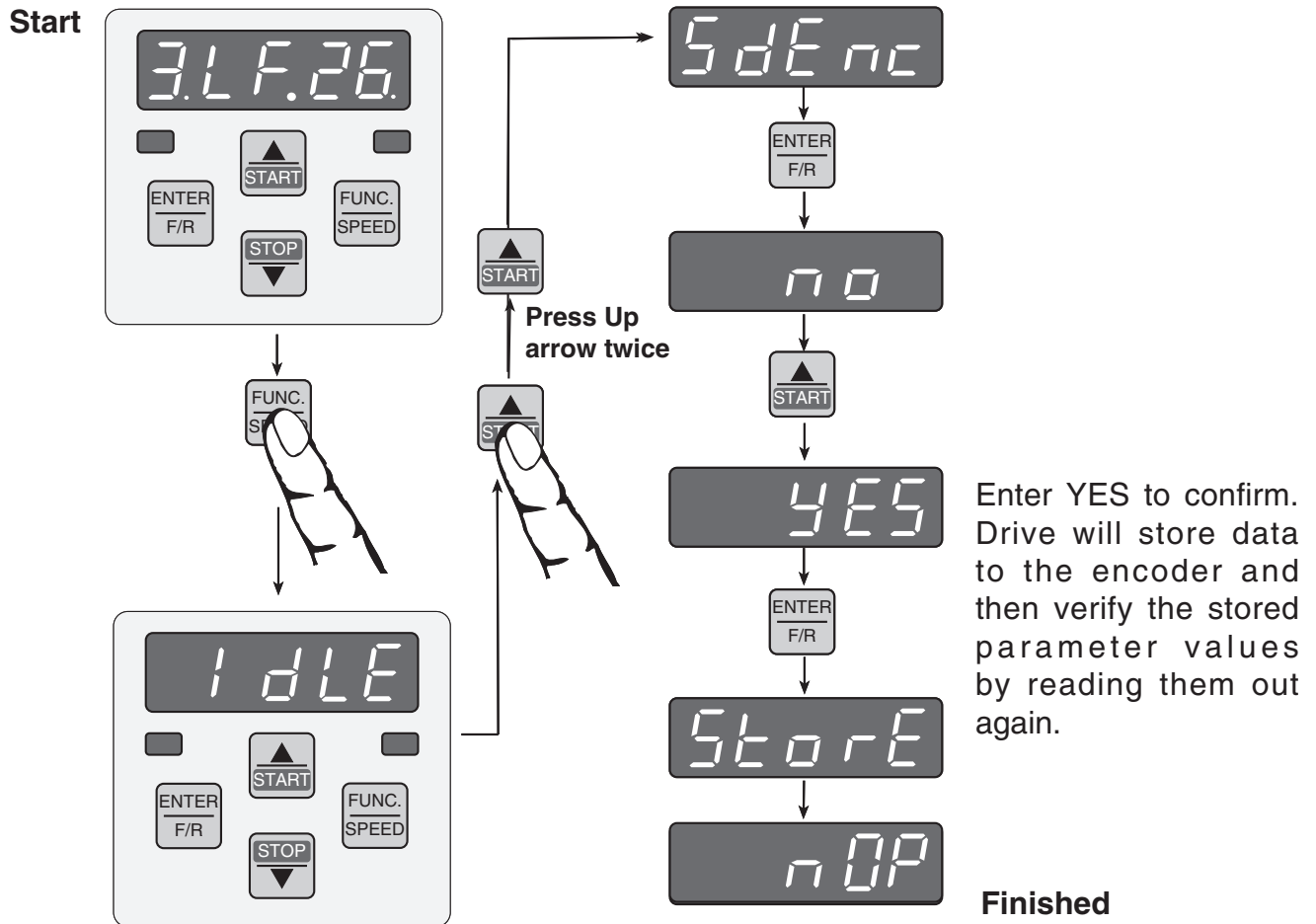

The parameters which are saved in the encoder are the following:
LF.10...LF.19, LF.34...LF.36, LF.77

If in the process of reading or storing the data there is a problem. The display will give an error message. The most common cause of these problems is a bad encoder cable.

LF.27

Encoder Pulse Number

Unit: pulse per revolution
 Value range: 256...16384 pulse per revolution
 Factory setting: 1024 pulse per revolution
 Adjustment value: in accordance with the manufacturer specifications



If the incremental encoder pulse number is not correctly adjusted, the elevator drive can run very slowly, or over-speed is possible or other unforeseen conditions may occur. Therefore, it is absolutely necessary to adjust this parameter correctly.

LF.28

Reverse Encoder

This parameter can be used to swap the two encoder channels, reverse the direction of the entire system, or both swap encoder channel and reverse the system direction. **See also section 5.11.2**

Unit: 1
 Value range: 0...3
 Factory setting: 0
 Adjustment value: 0 nothing reversed
 1 encoder change A <--> B swapped
 2 motor rotation reversed
 3 motor rotation reverse and A<-->B swapped

LF.29

Encoder Sample Time

This parameter is used to adjust the sample time of the encoder feedback for calculation of the actual motor speed value. With certain motors or encoders it may be beneficial to use a time other than the factory setting. Lower values lead to higher bandwidth and faster response times of the motor. However lower values also increase the systems susceptibility to electrical noise on the encoder signal. Therefore on some systems having higher noise levels, lower values may not be suitable. If this electrical noise is a problem, the motor will produce an audible noise while running.

Unit: -
 Value range: 0_5, 1, 2, 4, 8, 16, 32 mSec
 Factory setting: 4 mSec
 Adjusted value: based on application requirements

Example: with a 4 mSec sample time the resulting speed measurement resolution using a 1024 encoder is +/-3.5 rpm. A setting of 8 mSec gives +/-1.8 rpm.

With Sin/Cos, Hiperface, EnDat encoders see also parameter LF.76 for extended resolution adjustments.

Parameter Description - Control Settings



Control Method

Used in conjunction with LF.2 to adjust the control method.

Unit: 1
Value range: 0...5
Factory setting: 0

Adjustment values

- 0 or 1 Open loop induction motor operation for construction, inspection and test purposes only.
- 2 Closed loop speed control. Valid when LF.2 = AbSPd, d SPd, A SPd, SErSP
- 3 Closed loop speed control with pre-torque input active. Valid when LF.2 = AbSPd, d SPd, A SPd and using a load weight system to provide a pre-torque signal to the drive. Analog inputs X2A.3 and X2A.4 serve as the pre-torque input.
- 4 Closed loop torque control. Valid when LF.2 = A tor. Both analog inputs serve as torque inputs and are internally summed together.
- 5 Closed loop speed control with synthesized pre-torque. Valid when LF.2 = AbSPd, d SPd, A SPd, SErSP . Provide a synthesized pre-torque without a load weigher. See parameters US.31 and US.32 for further adjustment.



When using induction motors, the COMBIVERT F5 can be run open loop in inspection to verify whether the encoder functions normally. By setting the parameter LF.30 = 0, the inverter runs the motor open loop. The encoder feedback (motor speed) is displayed in parameter LF.89 but has no effect on the operation of the motor. Therefore, this mode can be used to verify whether the encoder is functioning properly. Generally, when running empty car up the actual motor speed in LF.89 should be equal to the set speed in LF.88. If these values are off by more than 20 rpm when running empty car up, there is most likely an encoder or encoder cable problem.

When using permanent magnet synchronous motors only closed loop operation (2,3,4,5) is permitted.



Running the COMBIVERT open loop, in automatic mode, at high speed or leveling speed can result in high motor currents and or poor performance. Always verify that this parameter is set correctly before running in automatic mode!



Kp Speed

Proportional gain of the speed controller. The default values are a good starting point and will work for most applications. However if the motor does not track the speed command tight enough, then the value should be increased. If the motor makes audible noise or vibration in the car, then the gain value should be reduced. Adjustment steps of +/- 250 are reasonable.

Unit: 1

Value range: 1...32767

Factory setting : 3000

Adjustment value: dependent on ratio of inverter / motor



Ki Speed

Integral gain of the speed controller. The default value is a good starting point and will work for most applications. If the motor makes audible noise or vibration then the gain value should be reduced.

Unit: 1

Value range: 1...32767

Factory setting: 500

Adjustment value: dependent on ratio of inverter / motor

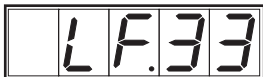

Ki Speed Offset

This gain value is effective only at low speeds. This value is added to the I term gain in LF.32 to provide greater control and more stability.

This offset gain will assist the motor in catching the load during starting. It is especially important for high efficiency geared or gearless applications. Values of 2,000 to 8,000 are useful.

Unit: 1

Value range: 0...8000

Factory setting: 2000

Adjustment value: dependent on ratio of inverter / Motor and gear type

The offset gain value is tapered off beginning at about 8 ft/min and the offset reaches zero at 24ft/min.

Parameter Description - Control Settings

LF.34

Kp Current

Proportional gain of the current controller.
The correct value is calculated from the motor data.

Unit: 1
Value range: 1...32767
Factory setting: Calculated!
Adjustment value: Do not change.

LF.35

Ki Current

Integral gain of the current controller.
The correct value is calculated from the motor data.

Unit: 1
Value range: 1...32767
Factory setting: Calculated!
Adjustment value: Do not change.

LF.36

Maximum Torque

This peak torque limit prevents the motor from exceeding its breakdown torque limit. If the torque limit is reached, the acceleration process will take longer with a full load. The value can be raised.

Unit: pound feet (lb ft)
Value range: 0.0...torque at the drive's current limit
Factory setting: 3 x Rated motor torque for IM
approx. 3 x LF.17
1.5 x Rated motor torque for PM motors
approx. 1.5 x LF.17

Note: to run with >100% load, it may be necessary to raise this value.

LF.37

Open Loop Torque Boost

Adjusts the torque boost only during open loop operation (LF.30=0). If the torque boost is too low the motor may not be able to lift the load. Too much boost can lead to high current while running open loop.

Unit: % of input voltage
Value range: 0.0...25.5 %
Factory setting: 10.0 %
Adjustment value: dependent on load



Carrier Frequency

Using parameter LF.38 the switching frequency of the inverter can be set. The switching frequency can be constantly 8 kHz or 16kHz with an automatic reduction based on the heat-sink temperature.



If the display often shows the error message E.OL2, then this parameter should be set to zero. Some power stages only support 8Khz. On these units it is not possible to change to this value.

Unit: 1
 Value range: 0 = switching frequency constantly 8 kHz
 1 = 16kHz with automatic reduction
 Factory setting: 0
 Adjusted value: as needed



Set Speed S_L , Leveling Speed

Leveling speed, selected by X2A.10, has priority over High speed, and Inspection speed.

Unit: feet per minute
 Value range: 0...16% of LF.20
 Factory setting: 0 ft/min
 Adjustment value: approx. 20 ft/min



Set Speed S_H High Speed

Selected by X2A.12.

Unit: feet per minute
 Value range: 0...LF.20
 Factory setting: 0 ft/min
 Adjusted value: LF.20 or smaller



Set Speed S_I , Inspection Speed

Selected by X2A.13.

Unit: feet per minute
 Value range: 0... 66% of LF.20
 Factory setting: 0 ft/min
 Adjusted value: approx. 100 ft/min

Parameter Description - Driving Profile

LF.44

Set Speed S_{HL} , High leveling Speed

Selected by X2A.11, has priority over High speed and Inspection speed.

Unit: feet per minute
 Value range: 0...25% of LF.20
 Factory setting: 0 ft/min
 Adjusted value: dependent on the distance between the floors

LF.45

Set Speed S_{INT} , Intermediate Speed

Selected by X2A.10 + X2A.11, has priority over High speed and Inspection speed.

Unit: feet per minute
 Value range: 0...91% of LF.20
 Factory setting: 0 ft/min
 Adjusted value: dependent on the distance between the floors

LF.50

Starting Jerk

Unit: feet per second³
 Value range: off, 0.30...32.00 ft/s³
 Factory setting: 2.00 ft/s³
 Adjusted value: dependent on the mechanical system (values which are too high can lead to oscillations in the cabin)

Note: 32.0 = no start ramp and should be used for analog speed or torque control.

General: The jerk or shock, which **always** occurs during the acceleration process, is crucial for the comfort of passengers in a passenger elevator. This causes objects to topple over or sway and puts too much stress on the mechanical components. Each person experiences this 'shock' differently, depending on their age, physical and mental state and whether they expect this force or not.

Empirical values: 2.00...3.00 ft/s³ for retirement homes, hospitals, apartment buildings
 3.00...4.00 ft/s³ for office buildings, banks etc.

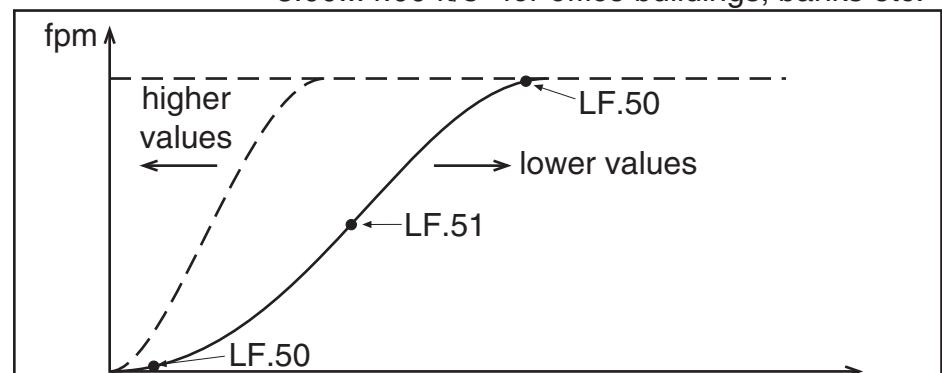

LF.51

Acceleration

Empirical values: 2.00...3.00 ft/s² for retirement homes, hospitals, apartment buildings
3.00...4.00 ft/s² for office buildings, banks etc

Unit: feet per second²

Value range: 0.30...12.0 ft/s²

Factory setting: 3.00 ft/s²

Adjustment value: according to comfort,

Note: 12.0 = no accel ramp and should be used for analog speed or torque control.

LF.52

Deceleration Jerk

Unit: feet per second³

Value range: off, 0.31...32.00 ft/s³

Factory setting: 3.28 ft/s³

Adjusted value: according to comfort

Note: 32.0 = no decel ramp and should be used for analog speed or torque control.



When the deceleration jerk is set too low, parameter LF.53 is no longer valid.

LF.53

Deceleration

Hard deceleration rates around 4 ft/sec² can result in a rough or bumpy stop especially as the transition to leveling speed is made. If spotting is occurring reduce LF.53 and LF.52. The best ride comfort is achieved with lower deceleration rates.

Unit: feet per second²

Value range: 0.30...8.0 ft/s²

Factory setting: 3.00 ft/s²

Adjusted value: according to comfort

Note: 12.0 = no decel ramp and should be used for analog speed or torque control.

Parameter Description - Driving Profile

LF.57

Speed Following Error

Triggers a drive fault if the actual motor speed deviates from the commanded speed by more than the window defined in parameter LF.58 and for the length of time defined in LF.59. This function only works in close loop speed control mode, ie. LF30=2 or 3.

Settings: 0 = Off (Use when LF.30 = 4)

1 = On, drive indicate speed following error when motor speed varies from the set speed by the amount in LF.58 and for the time in LF.59, output (X2A.18) turns off.

LF.58

Speed Difference

Sets the +/- window for the speed following error in percent of the set speed.

Factory setting: 0, Off
Unit: %
Value range: 0...30%
Factory setting: 10%
Adjustment value: as necessary

LF.59

Trigger Time Speed Difference

Defines the length of time the following error can exist before the fault is triggered.

Unit: Seconds
Value range: 0.0...1.0 sec.
Factory setting: 1.0 sec.
Adjustment value: as necessary



When trying to trouble shoot the cause of this fault, it helps to increase LF.58 and LF.59 to the maximum values to prevent the fault from triggering.

LF.67

Pre-torque Gain

A car weighing system can be used to provide an analog signal to the elevator drive which is proportional to the load in the cabin. When LF.30 is set to 3, this analog signal is used to generate an exact counter torque to hold the car stationary when the brake is released. This is important for gearless speed control applications.

- 10 V	→ the cabin is empty	→ negative rated torque
0 V	→ cabin weight + half load = counterweight	→ 0
10 V	→ the cabin is full	→ positive rated torque

If the rated torque is too small or too large , it can be increased or decreased with LF.67.

Unit:	-
Value range:	0.25 ... 2.00
Factory setting:	1
Adjusted value:	depends on the required torque

LF.68

Pre-torque Offset

If the counter weight is not 50 % (cabin weight + 50% of max. load), the pre-torque can be adjusted with LF.68.

Unit:	%
Value range:	- 100.0 % ... 100.0 %
Factory setting:	0 %
Adjusted value:	depends on the counter weight

LF.69

Pre-torque Direction

This parameter can be used to invert the direction of the pretorque being applied to the motor.

Unit:	1
Value range:	0 => +10V = positive torque
	1 => -10v = positive torque
Factory setting:	0
Adjusted value:	depends on the required torque direction

Parameter Description



Speed Pick Delay

This time delay allows the brake to release before the motor starts turning. The drive will hold the speed command at zero, including analog commands, for the adjusted time.

Unit: seconds

Value range: 0.0...3.0 s

Factory setting: 0.3 s

Adjusted value: 0.3 s



Note: When the pre-torque function is active (LF.30 = 3 or 5), the speed pick delay is the sum of the pre-torque ramp timers US.17 and US.18. Proper adjustment of these timers will automatically provide the required speed pick delay.



Encoder Resolution Multiplier

This parameter can be used to increase the resolution of encoders with analog sine/cosine tracks. The encoder types are SIN/COS, Hiperface, EnDat.

Unit: 1

Value range: 0...13

Factory setting: 2 for incremental encoders
8 for Sin/Cos, EnDat, or Hiperface encoders

The value corresponds to the multiplier using the following relation.
Actual Encoder Resolution = Encoder base ppr x $2^{(LF76)}$

Example: Sin/Cos encoder with base resolution of 2048 ppr

With $LF.76 = 8$ the actual measured resolution is:

$$2048 \times 2^8 = 524288 \text{ counts / rev}$$

Higher values give better resolution especially for gearless applications. However higher values make the system more susceptible to disturbances due to noise. Therefore the actual value which can be used will ultimately be limited by the noise being picked up on the encoder cable.

Parameter Description



Absolute Encoder Position

This parameter is only visible in closed loop PM motor mode (LF.4 = PCLSD or P9LSS). LF.77 displays the position of the encoder in relation to one of the motor poles.

Unit: 1

Value range: 0 ... 65535h

Factory setting: 0

Adjusted value: according to encoder position

If the position value is already known, simply enter the value in this parameter. If it is not known then follow the procedure in section 5.11.1 to measure the position. If the encoder was pre-programmed by the motor vendor, this value can be read out from the encoder in parameter 3.LF.26.



If the position is not known, then the drive will determine the correct position value. This process is best done when the motor is free to turn, i.e. without the ropes on the main sheave.

If it is not possible to remove the ropes from the sheave then it can be possible to make this measurement with a balanced car.

See section 5.11.1 and 5.11.2 for learn procedures.



Brake Drop Delay

This parameter determines how long the drive will maintain full current and control of the motor after the direction inputs, X2A.14 and X2A.15 have been turned off. After the adjusted time, motor current will continue to flow, however the analog input will be clamped and the speed control gains will be reduced. This time should be adjusted longer than the actual required time for the brake to mechanically drop.

Unit: seconds

Value range: 0.00 ... 3.00 Seconds

Factory setting: 0.50 Seconds



Current Hold Time

Once the time in LF.78 has expired, current will continue flowing to the motor, but the drive will ramp the motor torque down to zero over the time adjusted in LF.79. This provides a smooth transition of the load to the brake and a quiet de-energization of the motor. This time should be adjusted such that the drive shuts off the current before the controller drops the drive enable (X2A.16) and opens the motor contactor. If the drive enable is dropped before the current is shut off, it is possible the drive will respond with base block protection "BBL" which can prevent further operation for 1 to 3 seconds depending on the drive size. Therefore the times should be adjusted to prevent this. Additionally during this time the speed control is turned off to prevent the motor from driving against the brake.



The total time between the drop of the direction signals (X2A.14 & X2A.15) and the turn off of motor current is LF.78 + LF.79. The time delay for dropping the enable (X2A.16) and the opening of the motor contact should be greater than the sum of LF.78 and LF.79.

Unit: seconds

Value range: 0.00 ... 3.00 Seconds

Factory setting: 0.30 Seconds

Diagnostic Parameters



Software Version

Display of the software version of the Elevator Operator.



Software Date

Display of the software date.

Format DDMM.Y

Note: The lead character of the date may be blanked if it is a zero.

Example: data code 0208.1 display reads as 208.1



X2A Input State

Terminal X2A

This parameter displays the status of the digital inputs on terminal X2A. Each input has a specific value. See the table below for decoding.

Displayed Value	Terminal number(s)	Description
0	All X2	No signals are active on terminal X2A.10 to X2A.17
1	X2A.16	Only the enable signal is active on X2A.16. Drive will not run until one of the direction signals on X2A.14 or X2A.15 are active
2	X2A.17	Only the fault reset signal is active on X2A.17
4	X2A.14	Only the up signal is active on X2A.14. Drive will not run until enable signal on X2A.16 is active.
5	X2A.16,X2A.14	Both the enable and up signals are active. This is normal during operation.
8	X2A.15	Only the down signal is active on X2.4. Drive will not run until enable signal on X2.1 is active.
9	X2A.16,X2A.15	The enable and down signals are active. This is normal during operation.
16	X2A.10	Only the Leveling speed signal at X2A.10 is active. Drive will not run unit enable signal on X2A.16 and direction signal on X2A.14 or X2A.15 are active.
17	X2A.10,X2A.16	Both the enable and Leveling speed signals are active. A direction signal is required to allow operation.
32	X2A.11	Only the HighLeveling speed signal at X2A.11 is active. Drive will not run unit enable signal on X2A.16 and direction signal on X2A.14 or X2A.15 are active.
33	X2A.11,X2A.16	Both the enable and HighLeveling speed signals are active. A direction signal is required to allow operation.
64	X2A.12	Only the High speed signal at X2A.12 is active. Drive will not run unit enable signal on X2A.16 and direction signal on X2A.14 or X2A.15 are active.
65	X2A.12,X2A.16	Both the enable and High speed signals are active. A direction signal is required to allow operation.
128	X2A.13	Only the Inspection speed signal at X2A.13 is active. Drive will not run unit enable signal on X2A.16 and direction signal on X2A.14 or X2A.15 are active.
129	X2A.13,X2A.16	Both the enable and Inspection speed signals are active. A direction signal is required to allow operation.

Diagnostic Parameters



X2A Output State

Terminal X2A

This parameter displays the status of the digital outputs on terminal X2A. Each output has a specific value. If more than one output is active, the sum of the value is displayed.

Value table:

Value	Output Terminal	Function
1	X2A.18	+24VDC Solidstate out - AS, At speed
2	X2A.19	+24VDC Solidstate out - FLT, Drive fault
4	X2A.24...26	Form C Relay - RDY, Drive Ready
8	X2A.27...29	Form C Relay - DRO, Drive On



Operation Mode

Display

- 0 =
- 1 =
- 2 =
- 3 =
- 4 =
- 5 =
- 6 =
- 7 =

Speed

- Zero Speed or analog control
- High speed selected
- Inspection speed selected
- PreTorque On
- PreTorque On
- No Direction Selected
- no meaning
- no meaning



Inverter Load

Display of the actual inverter load in %. 100% equals rated load of the inverter.



Motor Set Speed

Displays the motor set speed in rpm, calculated from the system data.



Actual Motor Speed

Displays the actual motor speed in rpm measured from the motor encoder .

Actual motor speed should always be the same sign (polarity) as LF.88 and within 20 rpm. Otherwise there is a problem with the encoder, the encoder cable, or the setting of parameters LF.28.



To verify the encoder operation with induction motors, run the elevator drive in open loop (LF.30=0), set the inspection speed (LF43) to 50% of contract speed and run the car empty up. The actual motor rpm value displayed in LF.89 should be nearly equal to the value displayed in LF.88. If the value in LF.89 varies by more than +/- 10 rpm or the value is greater or less than LF.88 by more than 20 rpm, there is a problem with either the encoder or the encoder cable.



Actual Elevator Speed

Display of the car speed in ft/min; only when the encoder is connected.

This is a calculated value. The car speed should always be verified with an independent measuring device.

Diagnostic Parameters



Phase Current

Display of the actual phase current.
Resolution 0.1A



Peak Phase Current

Maximum motor phase current that occurs during operation. Display in [A]. The value can be deleted by pressing the UP or DOWN key. The memory is also deleted when the inverter is switched off.



Actual DC Voltage

Display of the actual dc-bus voltage
Resolution: 1V



Peak DC Voltage

Display of the maximum dc-bus voltage measured. In addition the highest value which occurs in ru.11 is stored in ru.12. (Erasing the peak storage : see parameter ru. 8)

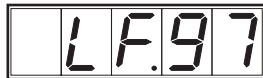

**Actual Output
Frequency**

Display of the actual output frequency.
Resolution: 0.1 Hz







Last Error





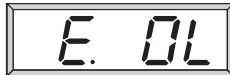

Displays the last 8 drive faults which occurred. The fault list can be viewed by changing the number to the left of the LF on the display. This number is the parameter offset number. Zero is the newest fault and 7 is the oldest. See the adjustment steps below to view the fault messages. A list of common faults, their causes, and trouble shooting tips is located on the following pages.

Error messages are always represented by an “E” in the left most position of the display. The drive fault displays are listed and described on the following pages. All faults are automatically reset up to an adjustable number of times. See parameter LF.5.





Error Messages



6.3 Error Messages and their Cause

Display	Description	Cause and Solution
 Under voltage	The DC bus voltage drops below the permissible value, the input is single phasing, or there is a phase imbalance of greater than 2%.	<ul style="list-style-type: none"> • Input voltage is too low or unstable • Input wiring is wrong • Isolation transformer is too small • Isolation transformer is not connected correctly • One phase of the input line is missing • Phase imbalance greater than 2%
 Overvoltage	The DC bus voltage rises above the permissible value either during motor regenerative operation or as a result of line side voltage spikes.	<ul style="list-style-type: none"> • Input voltage is too high – install a step down transformer • Voltages spikes on the line – install 5% line choke • Braking resistor is not connected or has a broken connection or the resistance is too high – verify braking resistor resistance • Inverter is poorly grounded
 Over current	Occurs when the specified peak output current is exceeded or if there is a ground fault.	<ul style="list-style-type: none"> • Short circuit on the motor leads • Ground fault on the motor leads – verify motor wiring • Contacts on motor contactor are damaged or burned causing arcing - check and replace • Inverter poorly grounded • Incorrect motor data – verify data LF10-LF19 • Shorted output transistor
 Overload	Time dependent overload. See overload curves on page 21. Error can not be rest until display shows E.nOL!	<ul style="list-style-type: none"> • Motor wired for incorrectly • Motor data is wrong, specifically motor current • The inverter is sized too small • High mechanical load (friction) on gear, guides, or rails... etc
 Low speed overload	Time dependent overload at low speed. See overload curve on page 22. Error can not be rest until display shows E.nOL!	<ul style="list-style-type: none"> • Stand still current of the motor is too high – reduce the switching frequency of the inverter to 8kHz (LF.38 = 0) see also US.16. • Motor data is not adjusted properly • Inverter sized too small • High mechanical load (friction) on gear, guides, rails...etc • Motor wired incorrectly
 Cool down phase completed	The drive has cooled down after an E.OL or E.OL2 error.	<ul style="list-style-type: none"> • The errors E.OL and E.OL2 can only be reset after E.nOL is displayed

Display	Description	Cause and Solution
 Inverter Overheat	The heat sink temperature rises above the permissible limit (see technical data)	<ul style="list-style-type: none"> • Insufficient cooling – increase the airflow around the inverter • Ambient temperature is too high - add a cabinet cooler • Fan is clogged – clean fan
 Motor Over Temperature	The external motor temperature sensor tripped	<ul style="list-style-type: none"> • Resistance at the terminals T1/T2 > 1650 Ohm • Motor temperature sensor indicating an overheated motor • Factory jumper between T1/T2 missing
 Over Temperature Cooled Down	Over temperature reset possible	<ul style="list-style-type: none"> • Internal or external temperature has dropped to a safe level. Error “E.OH” can be reset.
 Over Speed	Error over speed	<ul style="list-style-type: none"> • Speed was greater than 110% of the contract speed entered in LF.20. Speed is measured by the motor encoder. • Verify motor data LF.10 – LF.19 and LF.27 • Noise on the encoder cable can also cause this error.
 DC Bus Charging Error	This occurs for a short time during the power up of the drive, but will clear automatically if everything is OK	<ul style="list-style-type: none"> • Input voltage is wrong or too low • High resistance in the supply line • Braking resistor connected to the wrong terminals • Braking transistor is not functioning • Hardware failure –replace inverter
 Encoder Failure	Error encoder failure	<ul style="list-style-type: none"> • Encoder not connected electrically - Verify all encoder connections and signals. • Encoder channels reversed – see LF28
 Encoder Signal Loss	Error signal loss or during absolute position search: wrong rotation direction or too much drag	<ul style="list-style-type: none"> • One or more of the signals A+, A-, B+, B-, Z+, Z- are missing. • One or more of the differential signals is latched, i.e. both A+ and A- at are +5V at the same time. Check the encoder connections as well as the signal levels. All + and - signal should be opposite (0V and >2.0V) while the motor is standing still. • If learning encoder position on a PM motor first try moving car to a different part of the hoist way and this fault occurs, if no success then change LF.28.

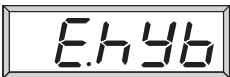
Error Messages

Display	Description	Cause and Solution
 Encoder Communication Error	<p>This indicates that there is a problem either with the serial communication between the drive and the encoder or the encoder signals. The full meaning of this error must be decoded through parameter 2.LF.26.</p>	<ul style="list-style-type: none"> • See parameter 2.LF.26 for fault diagnostics • This error does not reset with the RST input or the auto reset function. To clear this error go to parameter 0.LF.26, press function to show the value and then press enter.
 Power Unit Code	<p>Error Power Unit Code. During the initialization phase the power stage was not identified</p>	<ul style="list-style-type: none"> • Hardware failure replace the elevator drive
 Power Unit Code Changed	<p>Error Power Unit Code Changed. Indicates the power unit code has changed. This is typically experienced when exchanging control cards.</p>	<ul style="list-style-type: none"> • The unit will automatically configure itself for the new power stage and clear the error. • The drive will keep a history of all changes for future reference. • To manually clear this error, go to parameter US.27, press "function" and then "enter" and the error should clear.
 Error Current Check	<p>Error current check. Prior to every run the drive sends current to each phase of the motor to verify the connection. Afterward, the drive applies magnetizing current and monitors whether the motor is magnetized or not.</p>	<ul style="list-style-type: none"> • One or more motor leads is not connected. • Motor contactor is not closing or not closing in time - verify switching time of contactor • Motor contactor contacts are burnt or damaged - Inspect contactor • Motor windings are damaged. Measure motor resistance. • Drive is not able to generate acceptable current levels - after checking everything above it the problem could be drive related. • The phase current check can be bypassed by setting US.25 = 1
 Encoder Card Change	<p>This error indicates the feedback card has been changed</p>	<ul style="list-style-type: none"> • The unit will automatically clear the error and acknowledge the new feedback card. The unit keeps an internal log of all changes to the feedback board for future reference.
 Encoder Card Invalid	<p>This error indicates the feedback card has an invalid identification code.</p>	<ul style="list-style-type: none"> • The card was most likely damaged. Replace the feedback card.

Display	Description	Cause and Solution
 Electronic Motor Overload	Electronic Motor Overload protection was activated.	<ul style="list-style-type: none"> Excessive motor current above the value adjusted in LF.9 for IM or LF.12 for PM. Look for mechanical loading problems or motor data adjustment in parameters LF.10...LF.19.
 Bus Com. Fault	This indicates that serial communication between the keypad operator and the drive or the drive and the elevator control has been lost. See parameter US.29 to bypass this fault.	<ul style="list-style-type: none"> If communication is restored this fault will clear after 4 seconds. If not remove the operator cycle power to the drive and then install operator again. When using serial communication with the controller, make sure the serial cable to the controller is plugged into X4.
 Base Block Time	This message precedes most faults	<ul style="list-style-type: none"> Indicates the output transistors have been safely shut off and are being blocked from further operation.

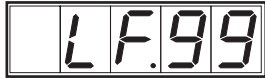

Inverter Status

Normal Operating Messages

Display	Significance
noP	No Operation, terminal X2.1 (Drive Enable) is not set
LS	Low speed, inverter is enabled but no direction of rotation is set, motor current still off
Facc	Forward acceleration
Fcon	Forward constant running
FdEc	Forward deceleration
rAcc	Reverse acceleration
rCon	Reverse constant running
rdEc	Reverse deceleration
boff	Indicates brake should be in the process of releasing at beginning of run
bon	Indicates brake should be setting at end of run
bbL	Base-block-time, power modules are blocked after an error is triggered and when enable X2A.16 is turned off while motor current is flowing.

Diagnostic parameters

7.0 Run Parameters

The run parameters display operational values within the elevator drive. They can be used for trouble shooting or calibration purposes. Each parameter is listed below along with a description of what it displays. Some parameters may display information only used by factory service personnel during diagnostic or repair. It is not necessary to understand the function of each of these parameters.

ru. 0 Inverter State

This parameter displays the operational status of the inverter. The status codes are defined with parameter LF.99.

ru. 1 Set Speed

This parameter displays the set speed or commanded value. This value is before the ramp generator.

Units: rpm

ru. 2 Command Speed

This parameter displays the actual commanded speed of the motor. This is the speed the motor should turn at.

Units: rpm

ru. 3 Actual output frequency

This is the actual output frequency to the motor.

Units: Hz

ru. 7 Actual speed value

This is the processed actual speed value as measured by the motor encoder.

Units: rpm

ru. 9 Encoder 1 speed

This is the raw measured speed value as measured by the encoder connected to input X3A.

Units: rpm

ru.10 Encoder 2 speed

This is the raw measured speed value as measured by the encoder connected to input X3B.

Units: rpm

rU.11 Commanded torque	This is the internal torque command value which is fed into the current controller. Units: Nm
rU.12 Actual torque	This is the actual torque value which is calculated from the motor current. Units: Nm
rU.13 Actual load	This is the load level of the inverter. 100% equals rated load. Units: %
rU.14 Peak load	This is the peak load level of the inverter. 100% equals rated load. The highest value is stored. The stored value can be reset by pressing the up or down key. It will also reset when the power is turned off. Units: %
rU.15 Phase current	This is the actual phase current flowing to the motor. The currents in the three phases are averaged. Units: Amps
rU.16 Peak current	This is the peak phase current. The highest value is stored. The stored value can be reset by pressing the up or down key. It will also reset when the power is turned off. Units: Amps
rU.17 Torque current	This is the per phase value for the reflected rotor current. This current is the torque producing component of the phase current and will be proportional to the torque. Units: Amps
rU.18 DC bus voltage	This is the actual value of the DC bus voltage. Normally it will be 1.4 times higher than the input line voltage. Units: Volts
rU.19 Peak DC bus voltage	Peak DC bus voltage. The highest value is stored. The stored value can be reset by pressing the up or down key. It will also reset when the power is turned off. Units: Volts

Diagnostic parameters

ru.20

Output Voltage

This is the actual phase to phase output voltage to the motor.

Units: Volts

ru.21

Input terminal state

The raw status of the input terminals. Each input is binary weighted according to the table below. If an input is activated the value corresponding to the input is displayed. If multiple inputs are activated the sum of the values is displayed. This parameter includes software linked inputs.

<u>Input Terminal</u>	<u>Function</u>	<u>Value</u>	Example: Input X2A.16 and X2A.14 are active.
X2A.16	Enable	1	
X2A.17	Reset	2	
X2A.14	Up	4	1 + 4 = 5
X2A.15	Down	8	
X2A.10	Leveling speed	16	
X2A.11	High Level speed	32	
X2A.12	High Speed	64	
X2A.13	Inspection Speed	128	
none	Internal function	256	
none	Internal function	512	
none	Internal function	1024	
none	Internal function	2048	

ru.22

Input terminal state

This is the processed status, after filters, software switches etc. of the inputs. The same weighting scheme applied as in parameter ru.21.

ru.23

Output terminal state

This is the state of the internal output conditions. Multiple active conditions results in the sum of the values.

<u>Condition</u>	<u>Value</u>
0	1
1	2
2	4
3	8
4	16
5	32
6	64
7	128



ru.24 Output flag state

This is the state of the internal output flags. Multiple active flags result in the sum of the values.

Flag	Value
0	1
1	2
2	4
3	8
4	16
5	32
6	64
7	128

ru.25 Output status

This is the state of the actual outputs. Multiple active outputs result in the sum of the values.

Output	Function	Value
X2A.18	At Speed	1
X2A.19	FLT	2
X2A.24...26	RDY	4
X2A.27...29	DRO	8
A	Software Link	16
B	Software Link	32
C	Software Link	64
D	Software Link	128

ru.26 Active Parameter Set

This parameter display the active internal parameter set.

ru.27 Analog pattern raw

This parameter displays the value of the actual pattern signal applied between terminal X2A.1 and X2A.2. The value is in percent +/- 100.0% = +/- 10.00V. This value is unfiltered and unprocessed.

Units: %

ru.28 Analog pattern processed

This parameter displays the processed analog pattern value. Filters, offsets and gains are applied to this value. Again 100.0% = 10.00V on the input.

Units: %

Diagnostic parameters

ru.29

Analog pre-torque raw

This parameter displays the value of the actual pre-torque signal applied between terminal X2A.3 and X2A.4. The value is in percent $\pm 100.0\% = \pm 10.00V$. This value is unfiltered and unprocessed.

Units: %

ru.30

Analog pre-torque processed

This parameter displays the processed analog pre-torque value. Filters, offsets and gains are applied to this value. Again $100.0\% = 10.00V$ on the input.

Units: %

ru.31

Analog option raw

This parameter displays the value of the analog signal applied to an option interface board. The value is in percent $\pm 100.0\% = \pm 10.00V$. This value is unfiltered and unprocessed.

Units: %

ru.32

Analog option processed

This parameter displays the processed analog option value. Filters, offsets and gains are applied to this value. Again $100.0\% = 10.00V$ on the input.

Units: %

ru.33

Analog Out 1 preamp

Analog output 1 preamp display. The value is in percent $\pm 100.0\% = \pm 10.00V$.

Units: %

ru.34

Analog Out 1 post-amp

Analog output 1 post amp display. The value is in percent $\pm 100.0\% = \pm 10.00V$.

Units: %

ru.35

Analog Out 2 preamp

Analog output 2 preamp display. The value is in percent $\pm 100.0\% = \pm 10.00V$.

Units: %

ru.36

Analog Out 2 post-amp

Analog output 2 post amp display. The value is in percent $\pm 100.0\% = \pm 10.00V$.

Units: %

ru.37

Motor pot value

Value of the internal function.

Units: %

- ru.38**
Power module temperature
This is the temperature of the output transistors.
Units: °C
- ru.39**
Overload counter
Overload counter display. Once the load of the drive goes above 100% this counter begins to increment. IF the load drops below it decrements. If the Counter reaches 100 the drive will shut down with an E.OL error.
- ru.40**
Power On counter
Power On counter counts the time while powered up.
Units: hours
- ru.41**
Run counter
Run counter counts the time actual providing power to the motor and running the elevator.
Units: hours
- ru.42**
Modulation grade
This is the percent utilization of the DC bus voltage. 100% means the DC bus is 100% utilized and the output voltage is equal to the input voltage. If this value reaches 100% or goes above 100% as a result of over modulation, loss of control of the motor will occur.
Units: %
- ru.43**
Timer 1
Displays the value of an internal timer.
- ru.44**
Timer 1
Displays the value of an internal timer.
- ru.45**
Actual carrier frequency
This is the actual carrier frequency the drive is operating at. Under certain conditions the drive may lower the carrier frequency in order to provide more current at low frequencies.
- ru.46**
Motor temperature
Displays the motor temperature. This value is only valid when the motor has a KTY thermal sensor install and that sensor is connected to the T1/T2 terminals.
Units: °C
- ru.54**
Position counter
Display the value of the internal position counter.
Units: counts



All remaining ru parameters are not important for the function of the elevator drive and therefore are not documented here.

Advanced Parameters

8.0 Advanced Adjustments

There are additional US parameters which can provide further functional adjustments of the drive. These US parameters are all those greater than US.10. They are turned ON or OFF through parameter US.8. Once turned ON, the higher US parameters are unlocked and can be adjusted as needed.

The following will provide a basic description of the function of each parameter.

US. 8 Parameter Access

By setting this parameter to ON, the US parameters greater than US.10 are accessible and can be changed as needed. Setting it to OFF will disable access to the higher level parameters. However, their functionality based on the actual adjustment, will remain active.

US. 14 Comm error para address

In the event of a communication error between the operator and the drive. The operator stores for diagnostic purposes, the address of the parameter it was trying to communicate with.

US. 15 Comm error para data

In the event of a communication error between the operator and the drive. The operator stores for diagnostic purposes, the data it was trying to send to the parameter in the drive.

US. 16 E.OL2 Function

The E.OL2 function is designed to protect the inverter from dangerous currents when operating at very low output frequencies. With some geared motors and mainly with gearless motors the drive is forced to provide high currents at output frequencies below 3 Hz. This causes considerable thermal loading on the power transistors. In an attempt to protect itself the drive will monitor the load current when operating below 3 Hz. If the safe value is exceeded, the drive will trigger the error E.OL2. See section 2.7 for a table with the actual current values. A value of 0 in US.16 provides this function.

A value of 16 takes into consideration the actual temperature of the power modules. If the temperature is lower, the threshold level for the output current is raised allowing more current to flow before triggering the error.

A value of 64 will cause the drive to automatically lower the carrier frequency when the output current reaches the E.OL2 limit. By doing so the actual threshold value is raised preventing E.OL2 and the drive keeps running. It is possible that under certain cases the carrier frequency might become low enough to be audible.

0 = Standard function E.OL2 at listed current values

16 = Heatsink temperature dependent E.OL2

64 = Auto carrier frequency reduction

80 = both temp dependent and auto carrier freq. reduction

US. 17

**Pre-torque
timer ramp up**

The function of this parameter is dependent on which mode of pre-torque is selected in LF.30.

LF.30 = 3 analog pre-torque from load weigher

This timer controls the build time for the Pre-torque function. Once the direction input is activated this timer begins counting. In the mean time the current check takes place and then finally the motor is magnetized. At this point the analog pre-torque value is evaluated and the torque begins to build on the motor. If this value is set too short the torque build will stop before the current check is done or before it has reached its nominal value. As a result it will appear that the Pre-torque function does not work. If the value is too long the actual pre-torque made by the motor will appear to over compensate.

LF.30 = 5 Synthesized pre-torque

This timer inserts dead time prior to brake release during which the current check function occurs and the motor becomes magnetized. In this case it should always be adjusted less than the actual mechanical brake pick time.

Unit: 0.1 seconds

Value range: 0.0...10.0

Factory setting : 0.3

Adjustment values: (when LF.30 = 3) 0.3 to 0.5 sec

(when LF.30 = 5) 1/2 of the total speed pick delay
time but less than the mechanical brake pick time

US. 18

**Pre-torque
timer ramp
down**

The function of this parameter is dependent on which mode of pre-torque is selected in LF.30.

LF.30 = 3 analog pre-torque from load weigher

This timer controls the ramp down time for the analog pre-torque function. Once the pre-torque is established it is necessary to ramp the command torque down to provide a smooth transition when the brake releases. Without any ramp, the turn off of pre-torque will be abrupt and with too much ramp time the actual start of movement will be influenced.

LF.30 = 5 Synthesized pre-torque

This timer controls the window during which the synthesized pre-torque function is actually active. The mechanical release of the brake must take place during this time period.

Unit: 0.1 seconds

Value range: 0.0...10.0

Factory setting : 0.1

Adjustment values: (when LF.30 = 3) 0.1 to 0.2

(when LF.30 = 5) 0.2 to 0.4

Advanced Parameters

US. 19 Field Weakening Corner

This parameter provides a better adjustment of the field weakening torque curve. Under certain situations, if the input voltage is sagging too low or the motor has very high slip, it is possible that the voltage limit might be reached. This can be confirmed by monitoring ru.42. If ru.42 reaches 100% or more the drive is operating at the voltage limit and potentially can cause poor control of the motor.

To prevent this from happening the drive has an adjustable torque curve which prevents the voltage limit from being reached. The value of this parameter is normally calculated when the motor data is loaded in the LF parameters. After entering the data, this value can be fine tuned.

Unit: 1 rpm

Value range: 0..4000

Factory setting : calculated from motor data

Adjustment values: increment /decrement by steps of 10%

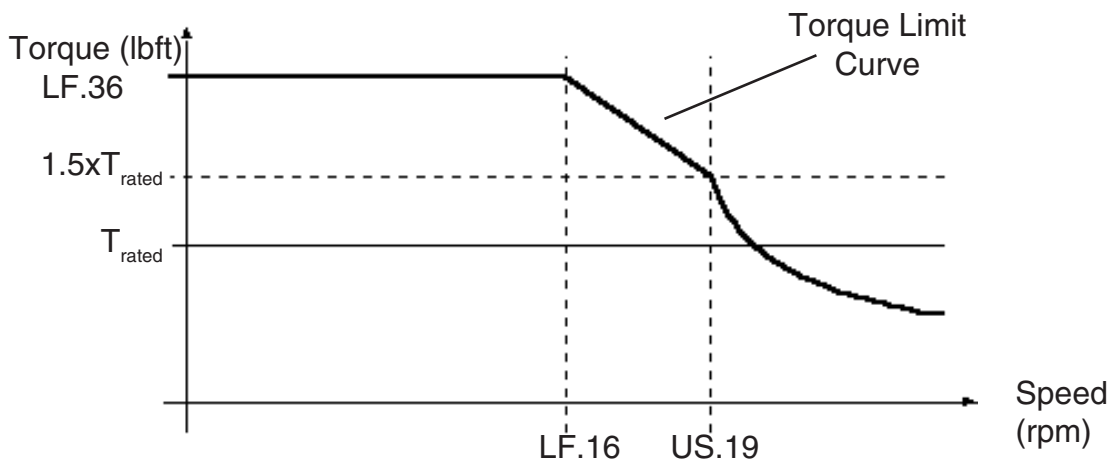

US. 20 Speed for Max KI

These parameters can be used to tailor the KI Offset gain to a specific speed range at low speed. Worm gear applications require a smaller KI Offset value but over a broader speed range. Whereas a gearless motor will require a much higher KI Offset value but at only the very lowest speed. With these two parameters the Offset can be tailored to the application. The default values are applicable to worm gear applications.

US. 21 Speed for min KI

US.20

Unit: 1 ft/min

Value range: 0..1600

Factory setting : 8 ft/min

US.21

Unit: 1 ft/min

Value range: 0..1600

Factory setting : 24 ft/min

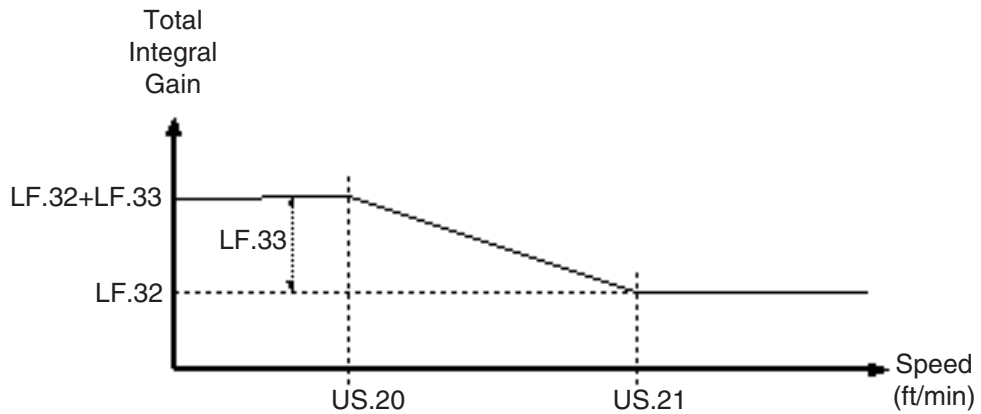

Advanced Parameters

US. 22 Speed dependent KP gain

These parameters allow the KP gain to be scaled dependent on the command speed of the elevator. In some cases it is beneficial to reduce the gain at high speed to minimize system response to hoistway vibrations or disturbances. Parameter US.22 turns the variable gain function on or off and parameter US.23 adjusts the value to which the gain is reduced.

US. 23 Min KP gain at high speed

US.22
Unit: -
Value range: off, on
Factory setting : off

US.23
Unit: 1
Value range: 0..32000
Factory setting : 1000

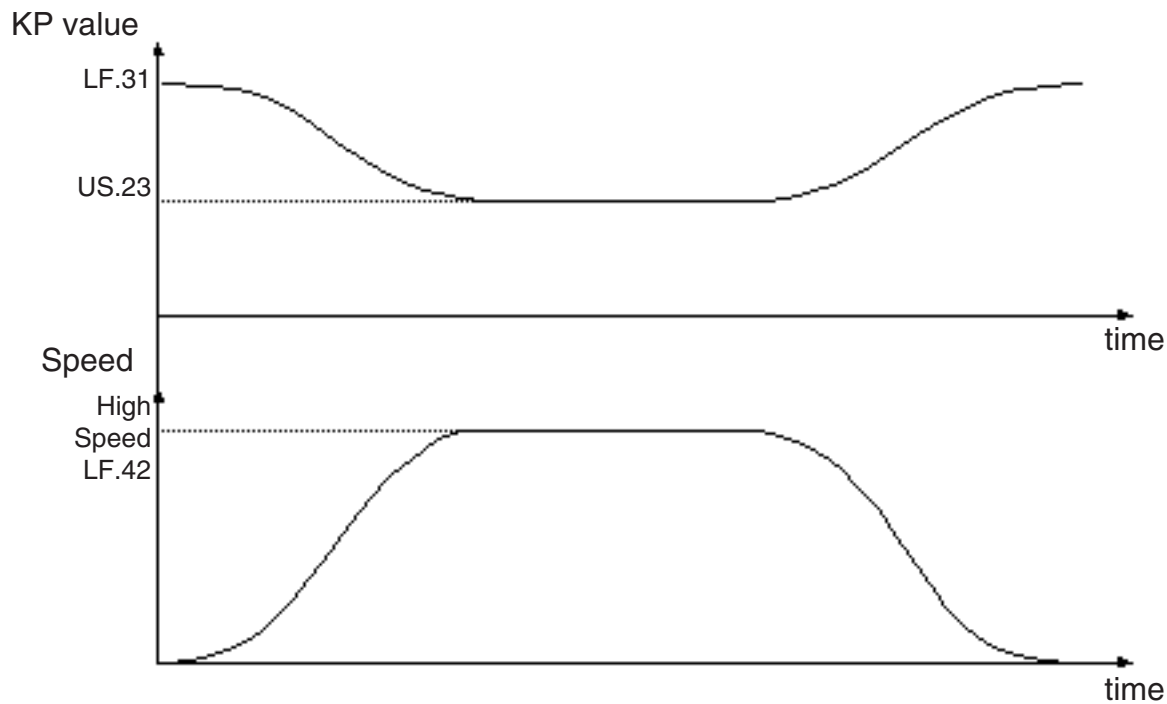

US. 24 KD speed gain

This acts as a derivative gain for the speed control. Generally the use of the derivative term is not necessary. However, there are some applications, where it could be useful. An example of which would be if for some reason it was necessary to keep the KP and KI gain values very low to prevent oscillation. In this case the KD gain could be used to maintain stability.

Unit: -
Value range: 0...32000
Factory setting : 0
Recommended adjustment: 500 - 1500

US. 25 Phase current check

This parameter can be used to select what type of current check is performed. Additionally it determines whether or not the brake on/off message is displayed. In the event there is a problem getting a consistently positive phase check, it is possible to switch to only a magnetizing current check. The possibilities are defined below.

Value	Function
0	Off (for temporary adjustment only)
1	Magnetization current check with brake on/off display
2	Magnetization current check without brake on/off display
3 _(default)	Phase current check with brake on/off display
4	Phase current check without brake on/off display

US. 26 Encoder diagnostic

This parameter provides diagnostics for SIN/COS, HIPERFACE and ENDAT encoders supporting a serial interface or absolute position channel. When a E.ENCC error is triggered, this parameter can be used to decode the cause of the fault. See also parameter LF.26.

Value	Status Description
16	Position values are being transferred to the encoder, encoder and serial interface are working.
64	Encoder is an unknown type and does not support the required serial communication protocol. Solution: verify encoder type.
68	Encoder is not connected, cable breakage has been detected. The interface looks at each channel for the idle voltage value of 2.5V with reference to common (pin 13). If this voltage is not present an error will be triggered with this fault code. Solution: check all signal connections.
69	The position deviation between the incremental channels and the absolute values is greater than 2.8 degrees. On SIN/COS the comparison is made between occurrences of the zero pulse. Too many or too few counts between the zero pulse will trigger this error. Solution: check all signal connections. Look for shielding or grounding problems. For best results an encoder cable with a double shield is recommended.
70	Compares the internal value of ppr stored inside the encoder with the setting of LF.27. If they do not match this error code will be activated. Solution: verify correct encoder ppr and enter it in LF.27.
71	The serial interface card is not recognized by the main CPU of the drive. Replace the feedback card.
74	Encoder temp is measure by the encoder and the error is passed on to the drive via serial com.
75	Actual speed has exceeded the max speed of the encoder.
76	Internal encoder signals are incorrect or out of tolerance. Replace the encoder
77,78	The encoder has an internal defect. Replace encoder
92	The encoder will be formatted according to the prescribed structure. This will allow further read/write cycles to occur.
96	New or different encoder connected to the drive
97	Encoder memory structure is not valid and therefore can not be read
98	The encoder is busy during data transfer and cannot accept the transmission.
0,255	There is no communication between the encoder and the drive.

Advanced Parameters

US. 27

Power stage ID code

Each voltage and size power stage has its own unique ID code. This parameter displays the ID number of the power stage. In the event the control card is replaced, when the new control card is installed the drive will display the message E.PUCH indicating that the ID of the power stage has changed since the last power on sequence. Before you are able to proceed further it is necessary to confirm the new ID number through this parameter. Simply display the ID number and press enter. This will clear the error message E.PUCH and allow the unit to go into operation.

US. 28

Analog input noise clamp

This parameter can be used to suppress noise on the analog speed pattern. When adjusted to a value greater than zero it will act as a hysteresis level above which the analog signal must rise before the drive begins to act on it. With a negative value the drive applies the same hysteresis to constant speed, i.e. at high speed.

Unit: 0.1 % = 10mV

Value range: 0.1...10.0 %

Factory setting : - 0.2 %

Recommended adjustment: -0.1% to -0.4 %

US. 29

HSP5 Watchdog time

This parameter adjusts the serial watchdog on the HSP5 com. link between the operator and the drive. If the operator is removed from the drive, the serial communication stops. If it does not restart before this timer expires the drive will trigger a fault and stop the operation of the motor.



A setting of 0 or OFF turns off the watchdog allowing operation of the drive with the operator removed. Note this mode of operation is recommended only for trouble shooting purposes.

Unit: 0.01 sec

Value range: 0.01...10.00 sec

Factory setting : 1.00 sec

Recommended adjustment: 1.00 sec

US. 30

Encoder R/W

This parameter has been de-activated. Refer to 3.LF.26 for this functionality.

US. 31 KP Synthesized Pre-torque

This parameter sets the proportional gain of the synthesized pre-torque. The default value should work in most cases. However when using normal 1024 TTL encoders, it may be necessary to lower this value to 1000.

Value range: 1...32767
 Factory setting : 2000
 Recommended adjustment: 2000

US. 32 KI Synthesized Pre-torque

This parameter sets the integral gain of the synthesized pre-torque. The default value should work in most cases. However when using normal 1024 TTL encoders, it may be necessary to lower this value to a lower number.

Value range: 1...32767
 Factory setting : 10,000
 Recommended adjustment: 10,000

US. 33 E.dOH Function

This parameter can be used to activate the temperature sensor input (T1 T2) on the drive. With this input activated, if the resistance between T1 and T2 becomes greater than 1650 ohms, the drive will trigger an E.dOH error indicating that the temperature sensor is too hot. Note: there is a 60 second time delay between when the sensor triggers and when the drive triggers the fault.

Value range: off...on
 Factory setting : off

US. 34 Analog Pattern Gain

The analog pattern can be scaled directly through this parameter. As an example if the analog signal is +/- 0...5 V, the pattern gain can be changed to 2.00 to provide full scale control of the motor speed.

Value range: 0.01...20.00
 Factory setting : 1.00

9.0 Input/Output Configuration

9.1 Digital Input Parameters

The digital input parameters can be used to configure the digital inputs for operation. Normally these parameters only need to be adjusted by the Elevator control builder.

di. 0 **Input Type**

Determines whether the inputs are PNP (sourcing) or NPN (sinking). This setting is applied globally to all inputs.

Unit: -

Value Range: PnP, nPn

Factory Setting: PnP

di. 3 **Noise Filter**

This parameter controls a digital noise filter which can be used to mask relay bounce or other unwanted momentary signals. This filter applies to all digital inputs except the enable input at X2A.16. The enable input is processed immediately

Unit: mSec

Value Range: 0 ... 127 mSec

Factory Setting: 10 mSec

Input/Output Configuration

9.2 Digital Output Parameters

The digital output parameters can be used to configure the digital outputs for operation. Normally these parameters only need to be adjusted by the Elevator control builder.

do. 42 Output Inversion

Can be used to invert the function of the output. As an example, normally on becomes normally off. Each output is assigned a value. To invert the output set this parameter to that value. To invert more than one output set this parameter to the sum of the values. Example X2A.18 = 1 and X2A.19 = 2, to inverter both set this parameter equal to 3.

Value	Output Terminal
1	X2A.18 +24VDC solid state output
2	X2A.19 +24VDC solid state output
4	X2A.24..26 form C relay output
8	X2A.27..29 form C relay output

Unit: -
Value Range: 0...15
Factory Setting: 0

do. 80 Output X2A.18

This parameter determines the function of the +24VDC solid state drive output X2A.18. The function can be selected from the table on the following page.

Factory Setting: R5d

do. 81 Output X2A.19

This parameter determines the function of the +24VDC solid state drive output X2A.19. The function can be selected from the table on the following page.

Factory Setting: FLt

do. 82 Output X2A.24..26

This parameter determines the function of the relay output X2A.24..26. The function can be selected from the table on the following page.

Factory Setting: rdy

do. 83 Output X2A.27..29

This parameter determines the function of the relay output X2A.27..29. The function can be selected from the table on the following page.

Factory Setting: dro

Switching conditions for the digital outputs. Only one condition can be assigned to each output.

Designator	Function
FLt	Fault - indicates there is a drive fault. Output activates when there is a drive fault, E.xxx
Rdy	Ready - indicates the drive is ready for operation. Output activates when the drive and ready for operation and there are no active faults E.xxx
dro	Drive On - indicates the drive is on and in control of the motor. Output activates after the following conditions are met: enable input active, direction input active, motor phase current check passed, motor magnetizing current OK. The output turns off when one of the following occurs: enable input is turned off, direction input is turned off and the motor speed has decelerated to zero speed and timer LF.78 has expired, drive fault E.xx, current to the motor is interrupted for any other reason.
ASd	At Speed - indicates the actual speed is tracking the command speed. Output is active as long as the actual speed matches the commanded speed. If during operation the actual speed is greater than or less than the commanded value, the output will turn off. See also parameters LF.57, LF.58, LF.59 for adjustment.
HSd	High Speed Run - indicates when the actual motor speed is above twice the value adjusted in LF. 41 (leveling speed). The output turns on when the actual speed is greater than 2 x LF.41. When the actual speed drops below 1.5 times LF.41 the output turns off. The speed is measured by the motor encoder.
brC	Brake Control - for controlling the brake. Output activates after the following conditions are met: enable input active, direction input active, motor phase current check passed, motor magnetizing current OK. The output turns off when one of the following occurs: enable input is turned off, direction input is turned off and the motor speed has decelerated to zero speed, drive fault E.xx, current to the motor is interrupted for any other reason.
Mcc	Main Contactor Control - for controlling the main motor contactor. Output activates after the following condition is met: enable input active. The output turns off when one of the following occurs: enable input is turned off, drive fault E.xx. Note: when using this input, it is necessary to qualify the direction signal(s) through an auxiliary contact on the main contact for proper timing.

Input/Output Configuration

9.3 Timing Graph - Analog Control

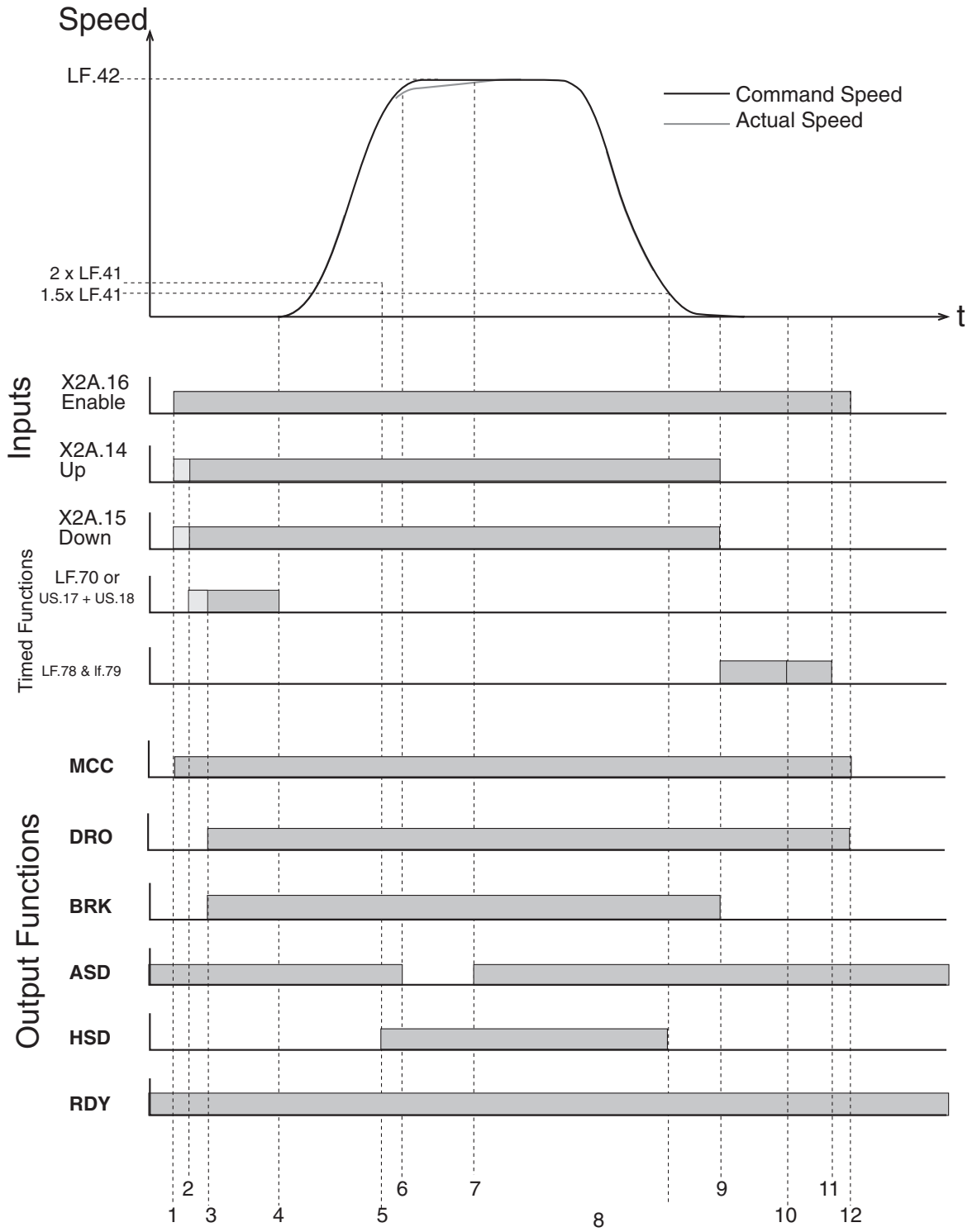

Event Sequence

- 1) Drive is enabled, outputs assigned to Mcc activate.
- 2) Direction signal is given. Note if Mcc output function is used, direction signals must be qualified by the closing of the main contactor.
- 3) The drive performs a current check to be sure the motor is connected and that rated magnetizing current is produced. This current check requires about 300mSec to complete.
- 4) If pretorque is not used the analog input is clamped for the period adjusted in LF.70. If pre-torque is used, the drive is applying pre-torque to the motor during this time. In either case motion can not occur so the controller must delay the pattern by at least the amount adjusted in LF.70 or the sum of the timer values in US.17 and US.18. After this time the controller can begin to ramp the analog command. This time should be adjustable to accommodate different brake release times.
- 5) Once the actual speed is above two times the leveling speed adjusted in LF.41, the HSD output function turns on.
- 6) If there is speed deviation during the run that exceeds the adjustment of LF.58 and LF.59, the ASD output turns off.
- 7) Once the speed deviation corrects itself, the ASD output turns on again.
- 8) When the elevator decelerates below, 1.5 times the leveling speed adjusted in LF.41, the HSD output turns off.
- 9) When the analog speed pattern is reaches zero, the controller should drop the direction signal. Exception, in the event of re-leveling leave the direction signal active and simply provide the re-leveling command with the analog pattern signal. When the direction turns off the timer in LF.78 begins. Additionally, the Brk output function turns off when the direction signal is turned off. If the controller is controlling the brake, the brake should be set at this time.
- 10) The drive maintains full control and current to the motor for the time period adjusted in LF.78. After which, the drive will reduce speed control gains and begin to ramp the motor current down to zero over the time adjusted in LF.79.
- 11) After the sum of the times in LF.78 and LF.79 the motor current is zero and it is safe to disable the drive and open the main contactor. Since LF.78 and LF.79 are adjustable to account for variable brake drop times, the corresponding time delay should also be adjustable in the controller.
- 12) Drive is disabled and the Mcc output turns off.

Input/Output Configuration

9.4 Timing Graph - Digital Control

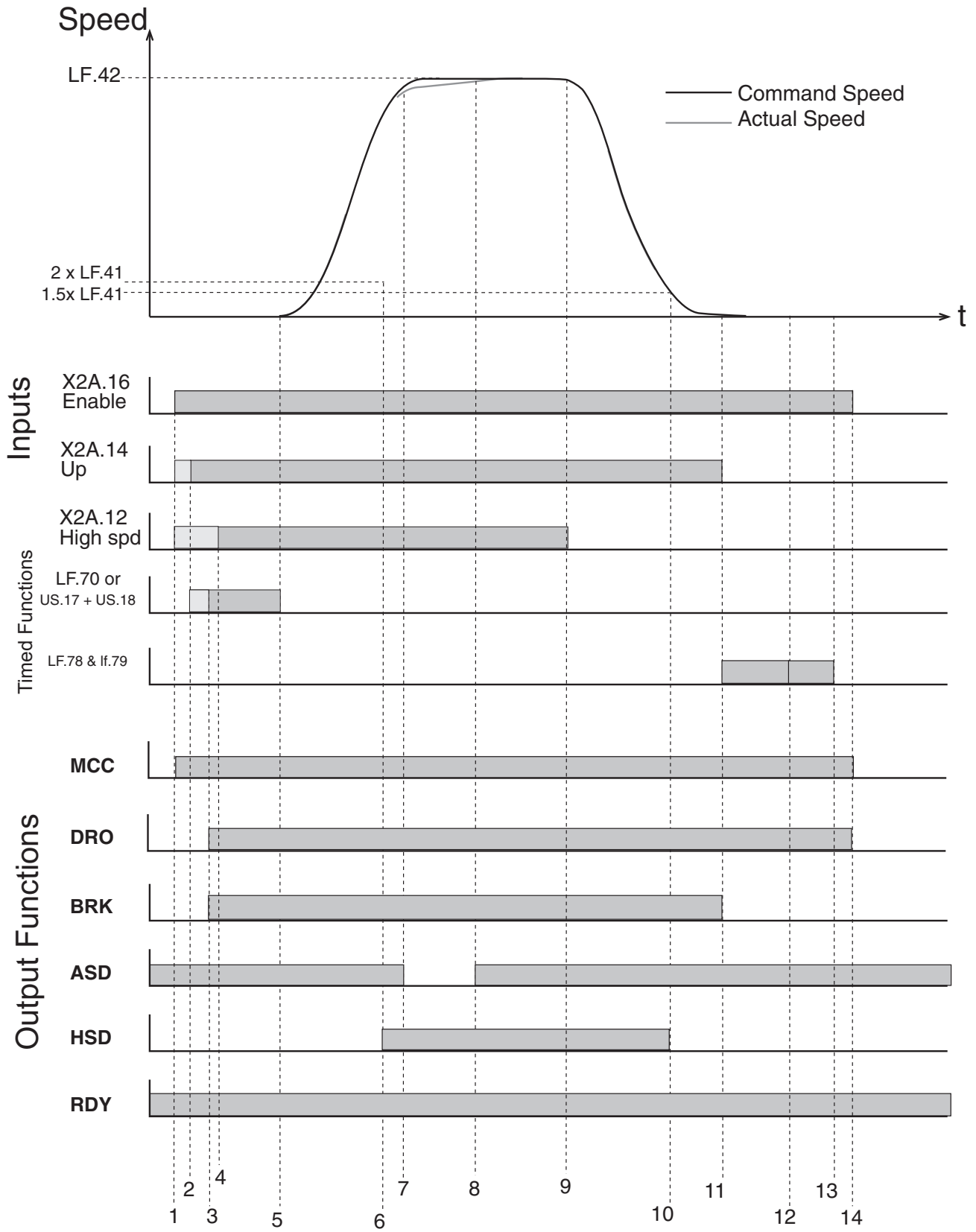

Event Sequence

- 1) Drive is enabled, outputs assigned to Mcc activate.
- 2) Direction signal is given. Note if Mcc output function is used, direction signals must be qualified by the closing of the main contactor.
- 3) The drive performs a current check to be sure the motor is connected and that rated magnetizing current is produced. This current check requires about 300mSec to complete.
- 4) The high speed signal is given. Note this signal can be given together with the direction signals or afterward.
- 5) If pretorque is not used the speed is held at zero the period adjusted in LF.70. If pre-torque is used, the drive is applying pre-torque to the motor during the total time in US.17 and US.18. These times are adjustable to accommodate different brake release times. The drive begins to accelerate the motor based on the adjusted pattern.
- 6) Once the actual speed is above two times the leveling speed adjusted in LF.41, the HSD output function turns on.
- 7) If there is speed deviation during the run that exceeds the adjustment of LF.58 and LF.59, the ASD output turns off.
- 8) Once the speed deviation corrects itself, the ASD output turns on again.
- 9) The high speed signal is removed and the drive begins to decelerate the elevator to the floor. Note variations in the turn off of the high speed signal will result in inconsistent approach to the floor. Therefore this signal must have minimal delay in processing from the controller.
- 10) When the elevator decelerates below, 1.5 times the leveling speed adjusted in LF.41, the HSD output turns off.
- 11) When the elevator reaches the floor, the controller should drop the direction signal. Exception, in the event of re-leveling leave the direction signal active and simply provide the re-leveling command by selecting leveling speed. When the direction turns off the timer in LF.78 begins. Additionally, the Brk output function turns off when the direction signal is turned off. If the controller is controlling the brake, the brake should be set at this time.
- 12) The drive maintains full control and current to the motor for the time period adjusted in LF.78. After which, the drive will reduce speed control gains and begin to ramp the motor current down to zero over the time adjusted in LF.79.
- 13) After the sum of the times in LF.78 and LF.79 the motor current is zero and it is safe to disable the drive and open the main contactor. Since LF.78 and LF.79 are adjustable to account for variable brake drop times, the corresponding time delay should also be adjustable in the controller.
- 14) Drive is disabled and the Mcc output turns off.

10.0 Parameter List Reference



Para.	Name	E	R	Res.	Lower Limit	Upper Limit	Default	Unit
LF.02	Steering/Operating Mode	E		1	1	4	2	text
LF.03	Drive configuration	E		1	0	3	1	text
LF.04	Drive Mode	E	R	1	0	4	-	text
LF.05	Auto Reset	E		1	0	10	3	-
LF.08	Electronic Mtr Protection	E		1	0	1	0	text
LF.09	Electronic Mtr Protection Current	E		0.1	1	110%Rtd	8	A
LF.10	Rated Motor Power	E		0.1	0.5	125	5	hp
			R	0.1	0.5	125	5	hp
LF.11	Rated Motor Speed	E		0.1	10	6000 (500.0)	1165 (150.0)	rpm
LF.12	Rated Motor Current	E		0.1	1	110%Rtd	8	A
LF.13	Rated Motor Frequency	E		0.1	4	200 (50.0)	60 (50.0)	Hz
LF.14	Rated Motor Voltage	E		1	120	500	230/460	V
	Voltage Constant ke	E		1	1	32000	1	V @ rated rpm
LF.15	Power Factor	E		0.01	0.5	1	0.9	-
LF.16	Field Weakening Speed	E		0.5	1	6000.0 (500.0)	960.0 (100.0)	rpm
LF.17	Rated Motor Torque	E	R					lb ft
				1	1	10000	18	
LF.18	Motor Resistance	E		0.001	0	50.000:	49.999	ohms
						49.999		
LF.19	Motor Inductance	E		0.01	0.01	500	1	mH
LF.20	Contract Speed	E		1	0	1600	0	ft/min
LF.21	Traction Sheave Diameter	E		0.01	7	80	24	inches
LF.22	Gear Reduction Ratio	E		0.01	1	99.99	30	-
LF.23	Roping Ratio	E		1	1	8	1	-
LF.24	Load	E		1	0	30000	0	lb
LF.25	Estimated Gear Reduction		R	0.01	0	655.35	-	-
LF.26	Type of encoder	E		1	0	15	1	-
LF.27	Encoder Pulse Number	E		1	256	16384	1024	ppr
LF.28	Swap Encoder Channels	E		1	0	3	0	-
LF.29	Sample rate for encoder	E		1	0.5	32	4	mS
LF.30	Control Mode	E		1	0	4	0(GM), 2(S)	-
LF.31	KP Speed	E		1	1	50396	3000	-
LF.32	KI Speed	E		1	1	26214	500	-
LF.33	KI Speed Offset	E		1	0	8000	2000	-
LF.34	KP Current	E		1	1	32767	1500	-
LF.35	KI Current	E		1	1	32767	500	-
LF.36	Maximum Torque	E		1	0	23590	3 x LF17	lbft
LF.37	Low Speed Torque Boost	E		0.1	0	25.5	5	%
LF.38	Switching Frequency	E		1	0	1	0	-
LF.41	Leveling Speed	E		0.1	0	16%ofLF20	0	ft/min
LF.42	High Speed	E		0.1	0	LF.20	0	ft/min
LF.43	Inspection Speed	E		0.1	0	66%ofLF20	0	ft/min
LF.44	High Leveling Speed	E		0.1	0	25%ofLF20	0	ft/min
LF.45	Intermediate Speed	E		0.1	0	100%ofLF20	0	ft/min

Parentheses designate value in gearless modes

Parameter List Reference

Para.	Name	E	R	Res.	Lower Limit	Upper Limit	Default	Unit
LF.50	Acceleration Jerk	E		0.01	0.3	32.00: off	3	ft/s ³
LF.51	Acceleration	E		0.01	0.3	12.00: off	3	ft/s ²
LF.52	Deceleration Jerk	E		0.01	0.3	32.00: off	3	ft/s ³
LF.53	Deceleration	E		0.01	0.3	12.00: off	3	ft/s ²
LF.57	Speed Following Error	E		1	0	1	1	text
LF.58	Speed Difference	E		1	0	30	10	%
LF.59	Following Error Timer	E		0.1	0	1	1	sec
LF.60	Level for Brake Set	E		0.1	0	3	1	ft/min
LF.67	Pretorque Gain	E		0.01	0.25	2	1	-
LF.68	Pretorque Offset	E		0.1	-100	100	0	%
LF.69	Pretorque Direction	E		1	-1	1	1	-
LF.70	Brake Release Time	E		0.1	0	3	0.3	s
LF.76	Encoder multiplier	E		1	0	13	2	-
LF.77	Absolute Encoder Position	E		1	0	65535	0	-
LF.78	Brake Engage Time	E		0.01	0	3	0.5	s
LF.79	Current Hold Time	E		0.1	0.1	3	0.3	s
LF.80	Software Version		R					-
LF.81	Software Date		R					-
LF.82	X2-Input State		R	Table				-
LF.83	X2-Output State		R	Table				-
LF.86	Selected Speed		R	1	0	7		-
LF.87	Actual Inverter Load		R	1				%
LF.88	Actual Set Speed		R	0.1				rpm
LF.89	Actual Motor Speed		R	0.1				rpm
LF.90	Actual Elevator Speed		R	1				ft/min
LF.93	Phase Current		R	0.1				A
LF.94	Peak Phase Current		R	0.1				A
LF.95	DC Bus Voltage		R	1				V
LF.96	Peak DC Bus Voltage		R	1				V
LF.97	Actual output frequency		R	0.1				Hz
LF.98	Last Fault		R	Table				
LF.99	Inverter State		R	Table				

Parameter List Reference



Para.	Name	E	R/ W	Res.	Lower Limit	Upper Limit	Default	Unit
US.00	Operator application		R	1	-	-	-	-
US.01	Password	E	R/W	1	0	9999	660	-
US.02	Config para		R	1	0	9999		-
US.03	Default all LF parameters	E	R/W	1	1	1	0:bdPAS	-
US.04	Load configuration	E	R/W	1	1	1	0:bdPAS	-
US.05	Read inverter state SLOW	E	R/W	0.001	0.010	60.000	0.100	sec
US.06	Read inverter state FAST	E	R/W	0.001	0.005	60.000	0.010	sec
US.07	last power up mode		R	1	0	4	none	-
US.08	Utility Parameter Access	E	R/W	1	OFF	ON	OFF	-
US.10	Select Configuration	E	R/W	1	0	4	1	text
US.11	P-On download delay timer	E	R/W	0.001	0: off	65.535		sec
US.13	P-On If write delay timer	E	R/W	0.001	0: off	65.535		sec
US.14	Comm Error para Address		R					
US.15	Comm Error Data		R					
US.16	E.OL2 function	E	R/W	1	0	255	0	-
US.17	Pre - Torque Timer ramp up	E	R/W	0.01	0.00	32.00	0.30	sec
US.18	Pre - Torque Timer ramp dwn	E	R/W	0.01	0.00	32.00	0.10	sec
US.19	Field Weakening Corner Speed	E	R/W	0.1	0:off	6000.0	none	rpm
US.20	max speed for max KI	E	R/W	1	0	1600	8	fpm
US.21	speed for min KI	E	R/W	1	0	1600	24	fpm
US.22	Speed Dependent KP Gain	E	R/W	1	0	1	0	-
US.23	Min KP Gain at High Speed	E	R/W	1	0	50396	1000	-
US.24	KD speed gain	E	R/W	1	0	5000	0	-
US.25	Phase Current Check	E	R/W	1	0	4	3	-
US.26	Encoder Diagnostic	E	R	1	0	255	-	-
US.27	Power Unit Code	E	R/W	1	0	255	-	-
US.28	Analog Input Noise Clamp	E	R/W	0.1	-2.5	2.5	-0.1	%
US.29	HSP5 Watchdog Time	E	R/W	0.01	0.0 = oFF	10.00	1.00	Sec
US.30	Encoder Read Write	E	R	1	0	1	0	-
US.31	KP Synthesized Pre-Torque	E	R/W	1	1	32767	2000	-
US.32	KI Synthesized Pre-Torque	E	R/W	1	1	32767	10000	-
US.33	EdOH function	E	R/W	1	0 = off	1 = on	0	-
US.34	Analog Pattern Gain	E	R/W	0.01	0.01	20.00	1.00	-

Parameter List Reference

Para.	Name	E	R	Res.	Lower Limit	Upper Limit	Default	Unit
di.0	Input type	E	R/W	1	0 = PNP	1 = NPN	0	-
di.3	Noise Filter	E	R/W	1	0	127	10	mSec

Para.	Name	E	R	Res.	Lower Limit	Upper Limit	Default	Unit
do.42	Digital Output Inversion	E	R/W	1	0	15	0	-
do.80	Output X2A.18	E	R/W	1	0	6	3	-
do.81	Output X2A.19	E	R/W	1	0	6	0	-
d0.82	Output X2A.24...26	E	R/W	1	0	6	2	-
d0.83	Output X2A.27...29	E	R/W	1	0	6	3	-

11.0 Customer Parameter Values



Para.	Name	Customer Value	Unit
LF.02	Steering/Operating Mode		
LF.03	Drive configuration		
LF.04	Drive Mode		
LF.05	Auto Reset		
LF.08	Electronic Mtr Protection		
LF.09	Electronic Mtr Protection Current		A
LF.10	Rated Motor Power		hp
LF.11	Rated Motor Speed		rpm
LF.12	Rated Motor Current		A
LF.13	Rated Motor Frequency		Hz
LF.14	Rated Motor Voltage Voltage Constant ke		V
LF.15	Power Factor		-
LF.16	Field Weakening Speed		rpm
LF.17	Rated Motor Torque		lb ft
LF.18	Motor Resistance		ohms
LF.19	Motor Inductance		mH
LF.20	Contract Speed		ft/min
LF.21	Traction Sheave Diameter		inches
LF.22	Gear Reduction Ratio		-
LF.23	Roping Ratio		-
LF.24	Load		lb
LF.27	Encoder Pulse Number		ppr
LF.28	Swap Encoder Channels		-
LF.29	Sample rate for encoder		mS
LF.30	Control Mode		-
LF.31	KP Speed		-
LF.32	KI Speed		-
LF.33	KI Speed Offset		-
LF.34	KP Current		-
LF.35	KI Current		-
LF.36	Maximum Torque		lbft
LF.37	Low Speed Torque Boost		%
LF.38	Switching Frequency		-

Para.	Name	Customer Value	Unit
LF.41	Leveling Speed		ft/min
LF.42	High Speed		ft/min
LF.43	Inspection Speed		ft/min
LF.44	High Leveling Speed		ft/min
LF.45	Intermediate Speed		ft/min
LF.50	Acceleration Jerk		ft/s ³
LF.51	Acceleration		ft/s ²
LF.52	Deceleration Jerk		ft/s ³
LF.53	Deceleration		ft/s ²
LF.57	Speed Following Error		
LF.58	Speed Difference		%
LF.59	Following Error Timer		sec
LF.60	Level for Brake Set		ft/min
LF.67	Pretorque Gain		-
LF.68	Pretorque Offset		%
LF.69	Pretorque Direction		-
LF.70	Brake Release Time		s
LF.76	Encoder multiplier		-
LF.77	Absolute Encoder Position		-
LF.78	Brake Engage Time		s
LF.79	Current Hold Time		s
LF.80	Software Version		-
LF.81	Software Date		-

Customer Parameter Values

Advanced Parameters

Para.	Name	Customer Value	Unit
US.16	E.OL2 function		-
US.17	Pre - Torque Timer ramp up		sec
US.18	Pre - Torque Timer ramp dwn		sec
US.19	Field Weakening Corner Speed		rpm
US.20	max speed for max KI		fpm
US.21	speed for min KI		fpm
US.22	Speed Dependent KP Gain		-
US.23	Min KP Gain at High Speed		-
US.24	KD speed gain		-
US.25	Phase Current Check		-
US.26	Encoder Diagnostic		-
US.27	Power Unit Code		-
US.28	Analog Input Noise Clamp		%
US.29	HSP5 Watchdog Time		mS
US.30	Encoder Read Write		-
US.31	KP Synthesized Pre-Torque		-
US.32	KI Synthesized Pre-Torque		-
US.33	EdOH function		-
US.34	Analog Pattern Gain		-

Digital I/O Handling

Para.	Name	Customer Value	Unit
di.0	Input Type		-
di.3	Noise Filter		mSec
do.42	Digital Output Inversion		-
do.80	Output X2A.18		-
do.81	Output X2A.19		-
do.82	Output X2A.24...26		-
do.83	Output X2A.27...29		-

KEB AMERICA INC.
5100 Valley Industrial Blvd.
Shakopee, MN 55379
PHONE: 952-224-1400
www.kebamerica.com