

IGBT MODULE (S series) 1200V / 15A / PIM



■ Features

- Low $V_{CE(sat)}$
- Compact package
- P.C. board mount
- Converter diode bridge, Dynamic brake circuit

■ Applications

- Inverter for motor drive
- AC and DC servo drive amplifier
- Uninterruptible power supply

■ Maximum ratings and characteristics

● Absolute maximum ratings ($T_c=25^\circ\text{C}$ unless without specified)

| Item | Symbol | Condition | Rating | Unit | | |
|---------------------------------|-------------------------------------|-----------|--------------------------------|------------------------|----------------------|---|
| Inverter | Collector-Emitter voltage | V_{CES} | 1200 | V | | |
| | Gate-Emitter voltage | V_{GES} | ± 20 | V | | |
| | Collector current | I_C | Continuous | $T_c=25^\circ\text{C}$ | 25 | A |
| | | | | $T_c=80^\circ\text{C}$ | 15 | |
| | | I_{CP} | 1ms | $T_c=25^\circ\text{C}$ | 50 | A |
| | | | | $T_c=80^\circ\text{C}$ | 30 | |
| $-I_C$ | | | 15 | A | | |
| Collector power dissipation | P_C | 1 device | 110 | W | | |
| Brake | Collector-Emitter voltage | V_{CES} | 1200 | V | | |
| | Gate-Emitter voltage | V_{GES} | ± 20 | V | | |
| | Collector current | I_C | Continuous | $T_c=25^\circ\text{C}$ | 25 | A |
| | | | | $T_c=80^\circ\text{C}$ | 15 | |
| | | I_{CP} | 1ms | $T_c=25^\circ\text{C}$ | 50 | A |
| | | | | $T_c=80^\circ\text{C}$ | 30 | |
| Collector power dissipation | P_C | 1 device | 110 | W | | |
| Repetitive peak reverse voltage | V_{RRM} | | 1200 | V | | |
| Converter | Repetitive peak reverse voltage | V_{RRM} | 1600 | V | | |
| | Average output current | I_O | 50Hz/60Hz sine wave | 15 | A | |
| | Surge current (Non-Repetitive) | I_{FSM} | $T_j=150^\circ\text{C}$, 10ms | 155 | A | |
| | I^2t (Non-Repetitive) | I^2t | half sine wave | 120 | A^2s | |
| Operating junction temperature | T_j | | +150 | $^\circ\text{C}$ | | |
| Storage temperature | T_{stg} | | -40 to +125 | $^\circ\text{C}$ | | |
| Isolation voltage | between terminal and copper base *2 | V_{iso} | AC : 1 minute | AC 2500 | V | |
| | between thermistor and others *3 | | | AC 2500 | | |
| Mounting screw torque | | | 3.5 *1 | N·m | | |

*1 Recommendable value : 2.5 to 3.5 N·m (M5)

*2 All terminals should be connected together when isolation test will be done.

*3 Terminal 8 and 9 should be connected together. Terminal 1 to 7 and 10 to 24 should be connected together and shorted to copper base.

● Electrical characteristics (T_j=25°C unless otherwise specified)

| Item | Symbol | Condition | Characteristics | | | Unit | | |
|------------------------------|--------------------------------------|-----------------------|---|----------|------|------|------|-----|
| | | | Min. | Typ. | Max. | | | |
| Inverter | Zero gate voltage collector current | ICES | V _{CE} =1200V, V _{GE} =0V | | 1.0 | mA | | |
| | Gate-Emitter leakage current | IGES | V _{CE} =0V, V _{GE} =±20V | | 0.2 | μA | | |
| | Gate-Emitter threshold voltage | V _{GE(th)} | V _{CE} =20V, I _c =15mA | | 5.5 | 7.2 | 8.5 | V |
| | Collector-Emitter saturation voltage | V _{CE(sat)} | V _{GE} =15V, I _c =15A | chip | 2.1 | | V | |
| | | | | terminal | 2.15 | 2.6 | | |
| | Input capacitance | C _{ies} | V _{GE} =0V, V _{CE} =10V, f=1MHz | | 1800 | | pF | |
| | Turn-on time | ton | V _{CC} =600V | | 0.35 | 1.2 | μs | |
| | | tr | I _c =15A | | 0.25 | 0.6 | | |
| | | tr(i) | V _{GE} =±15V | | 0.1 | | | |
| | Turn-off | toff | R _G =82Ω | | 0.45 | 1.0 | | |
| tf | | | | 0.08 | 0.3 | | | |
| Forward on voltage | V _F | I _F =15A | chip | 2.3 | | V | | |
| | | | terminal | 2.35 | 3.2 | | | |
| Reverse recovery time of FRD | t _{rr} | I _F =15A | | | 0.35 | μs | | |
| Brake | Zero gate voltage collector current | ICES | V _{CEs} =1200V, V _{GE} =0V | | 1.0 | mA | | |
| | Gate-Emitter leakage current | IGES | V _{CE} =0V, V _{GE} =±20V | | 0.2 | μA | | |
| | Collector-Emitter saturation voltage | V _{CE(sat)} | I _c =15A, V _{GE} =15V | chip | 2.1 | | V | |
| | | | | terminal | 2.2 | 2.6 | | |
| | Turn-on time | ton | V _{CC} =600V | | 0.35 | 1.2 | μs | |
| | | tr | I _c =15A | | 0.25 | 0.6 | | |
| | Turn-off time | toff | V _{GE} =±15V | | 0.45 | 1.0 | | |
| | | tf | R _G =82Ω | | 0.08 | 0.3 | | |
| | Reverse current | I _{RRM} | V _R =1200V | | | 1.0 | mA | |
| | Forward on voltage | V _{FM} | I _F =15A | chip | 1.1 | | V | |
| terminal | | | | 1.2 | 1.5 | | | |
| Reverse current | I _{RRM} | V _R =1600V | | | 1.0 | mA | | |
| Thermistor | Resistance | R | T=25°C | | 5000 | Ω | | |
| | | | T=100°C | | 465 | | 495 | 520 |
| | B value | B | T=25/50°C | | 3305 | 3375 | 3450 | K |

● Thermal resistance Characteristics

| Item | Symbol | Condition | Characteristics | | | Unit |
|---------------------------------|----------------------|-----------------------|-----------------|------|------|------|
| | | | Min. | Typ. | Max. | |
| Thermal resistance (1 device) | R _{th(j-c)} | Inverter IGBT | | | 1.14 | °C/W |
| | | Inverter FWD | | | 1.85 | |
| | | Brake IGBT | | | 1.14 | |
| | | Converter Diode | | | 1.30 | |
| Contact thermal resistance * | R _{th(c-f)} | With thermal compound | | 0.05 | | |

* This is the value which is defined mounting on the additional cooling fin with thermal compound

■ Equivalent Circuit Schematic

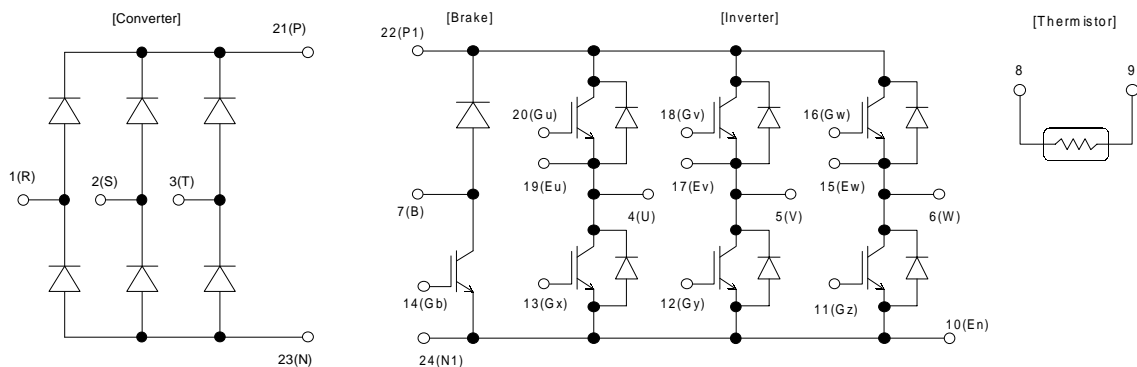

■ Characteristics (Representative)

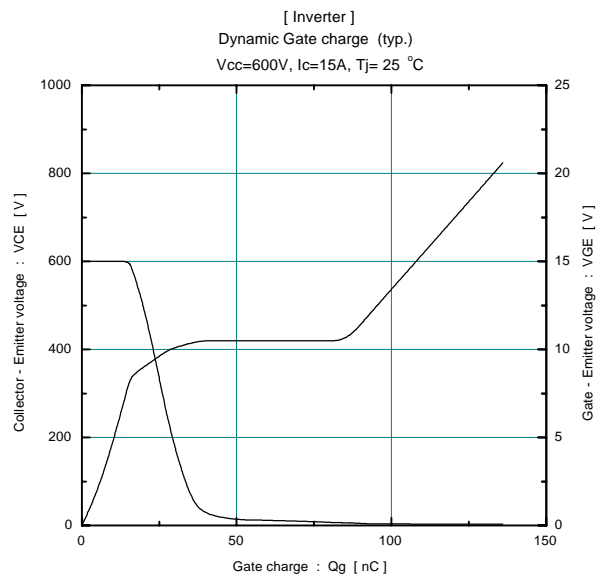
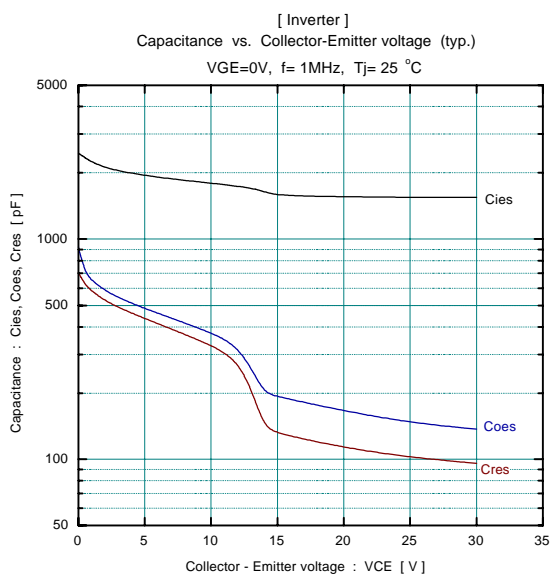
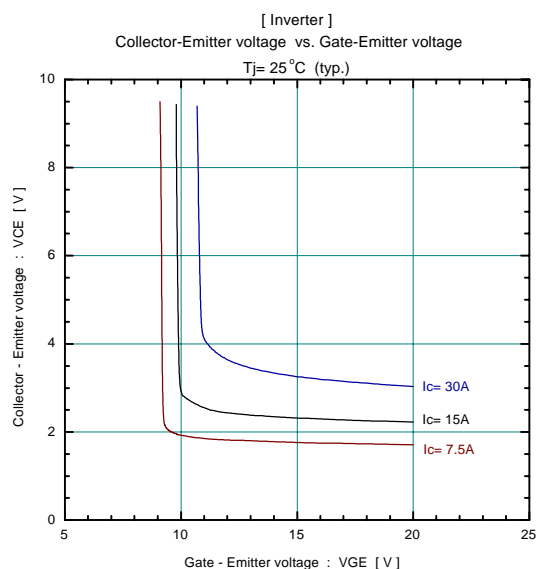
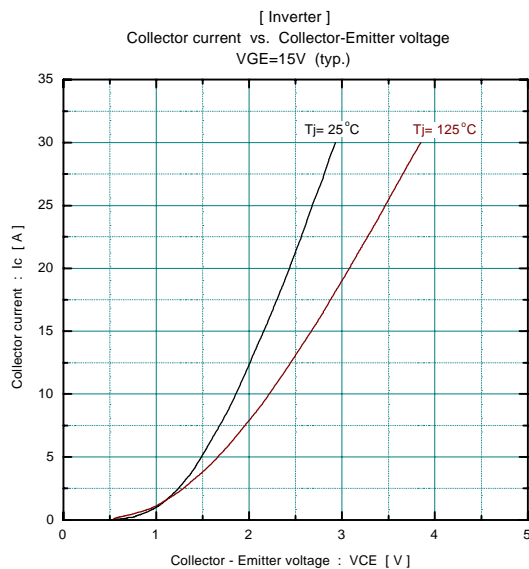
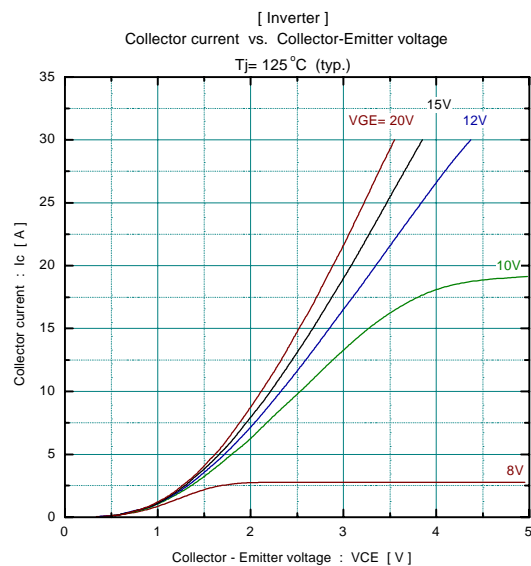
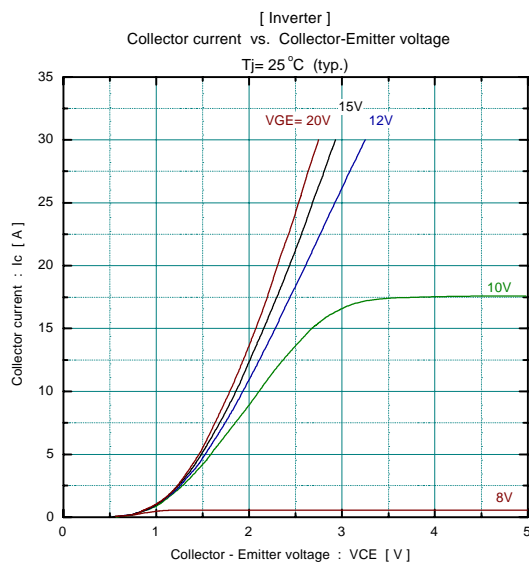

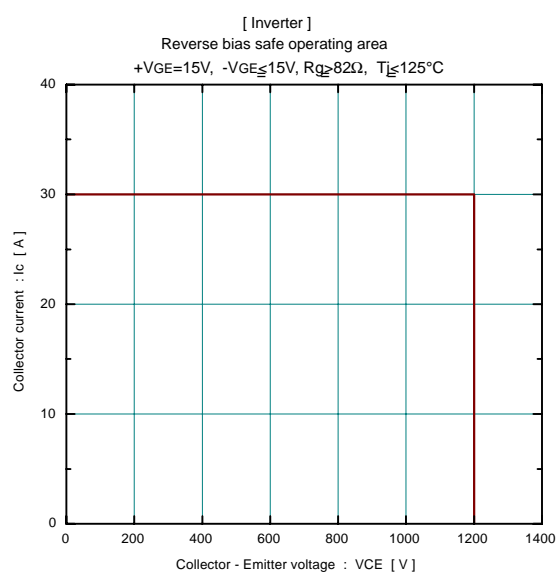
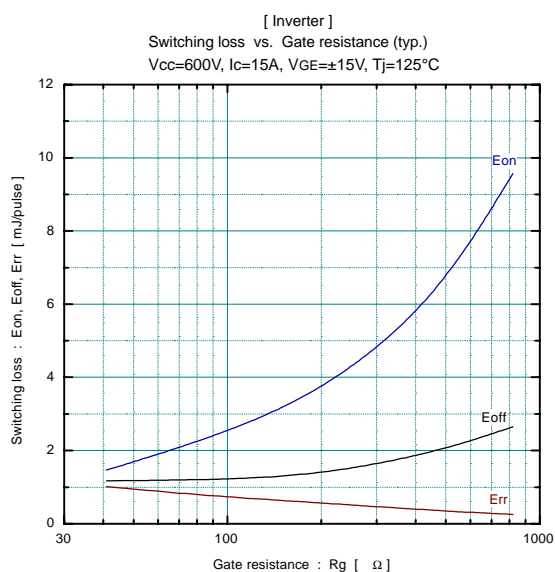
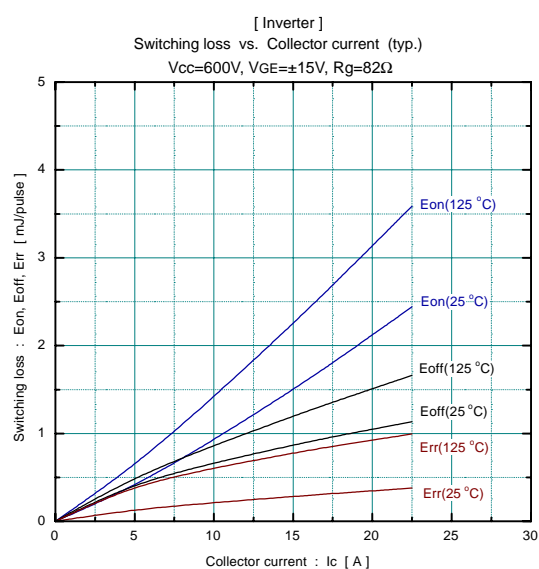
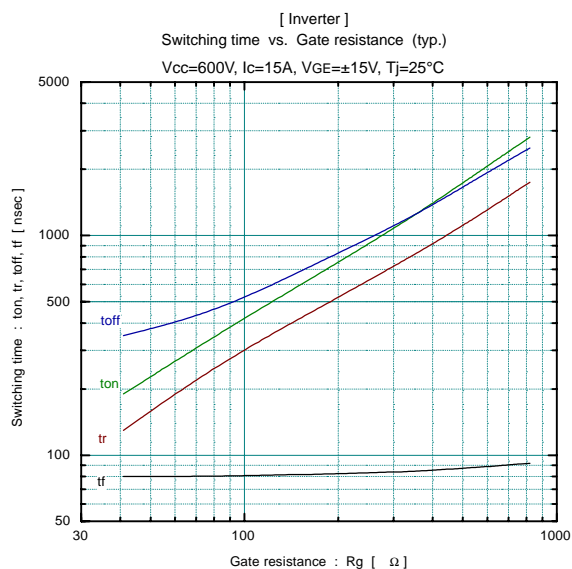
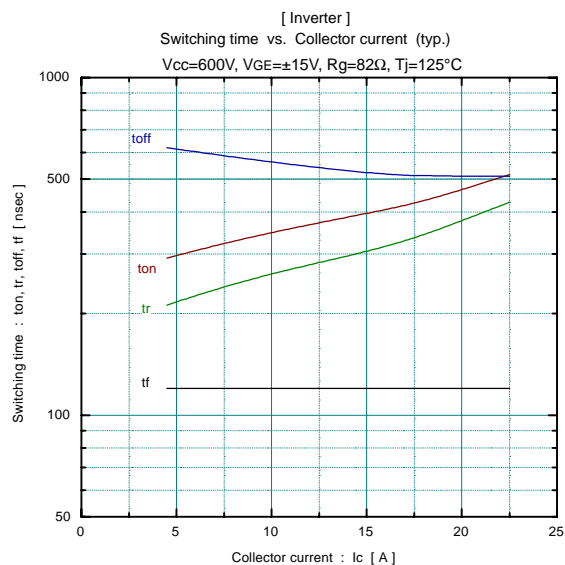
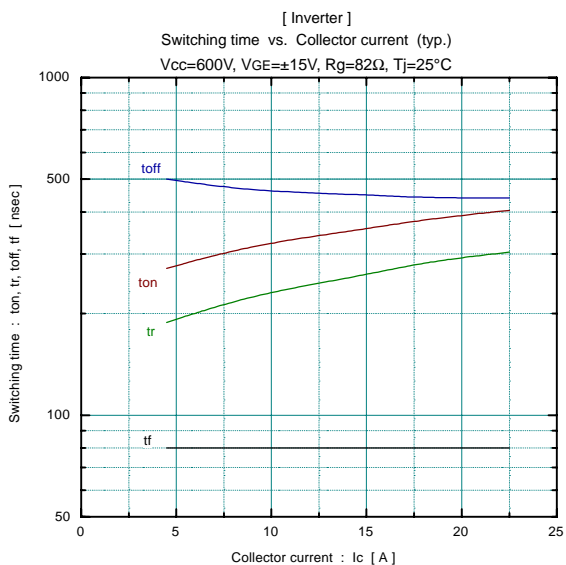

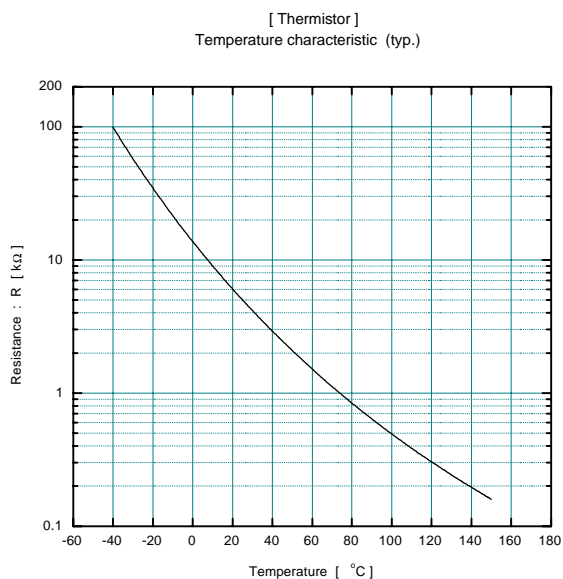
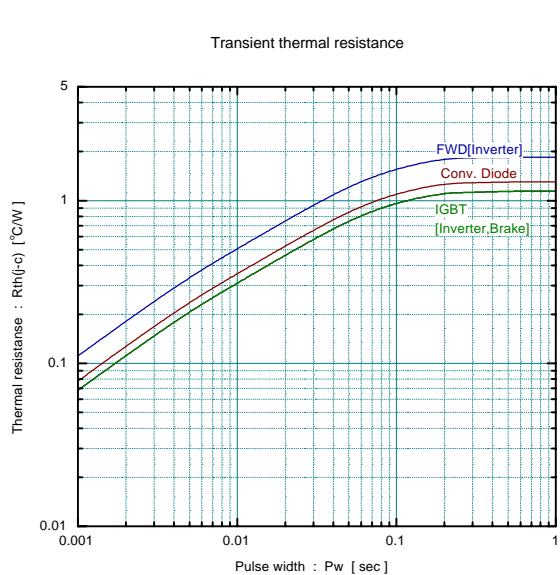
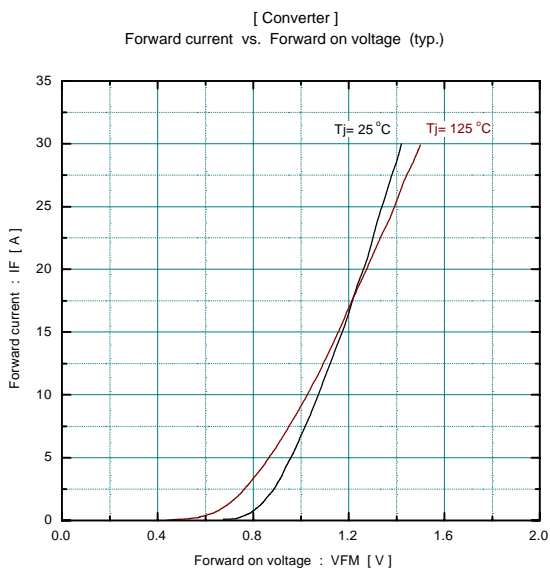
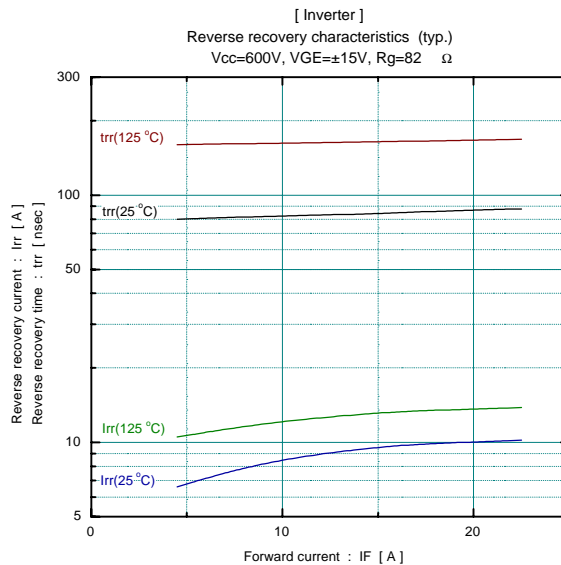
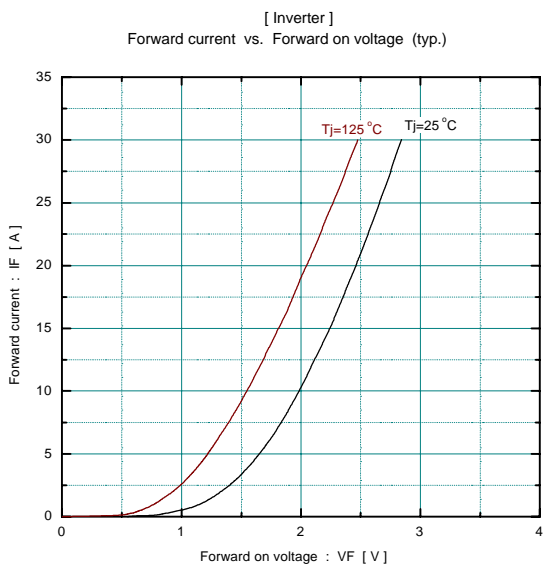

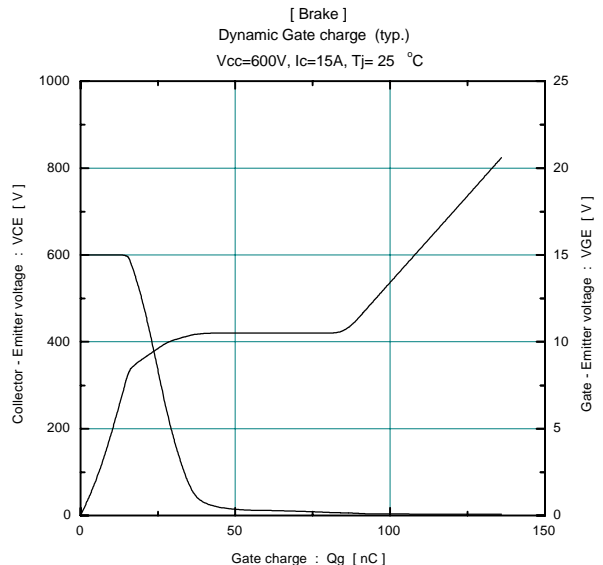
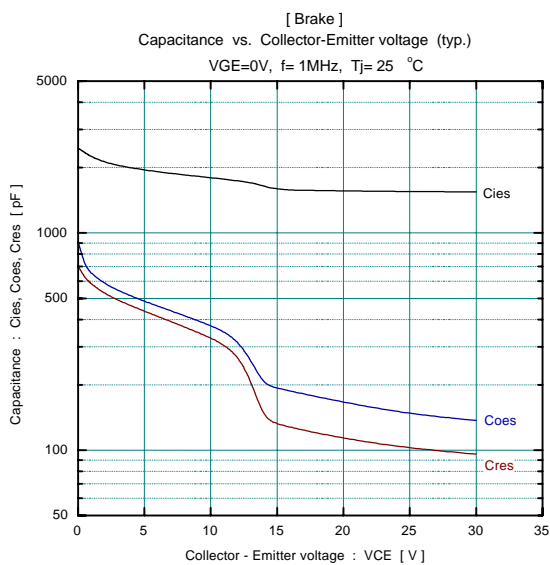
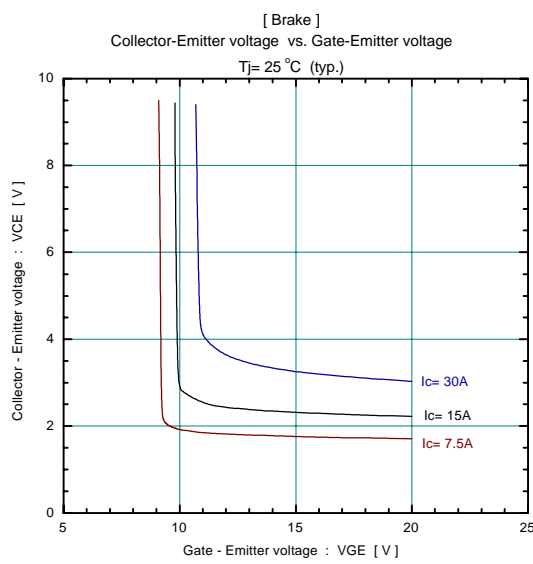
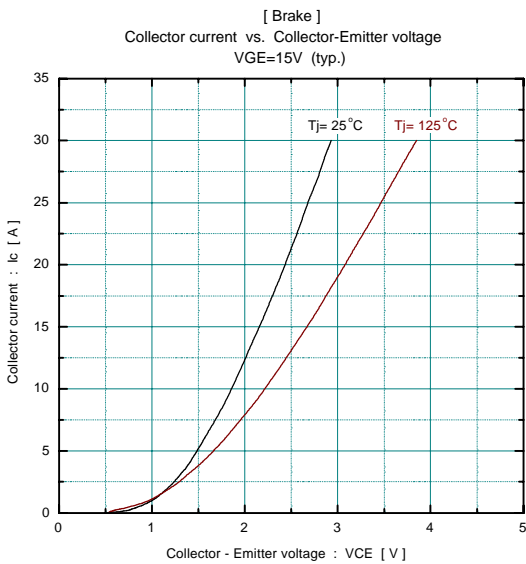
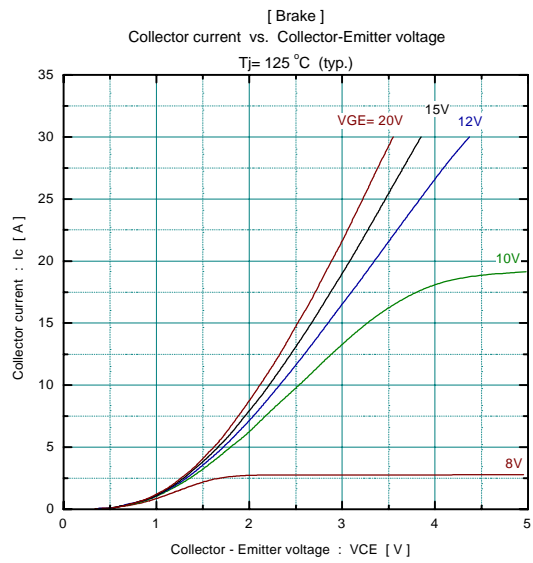
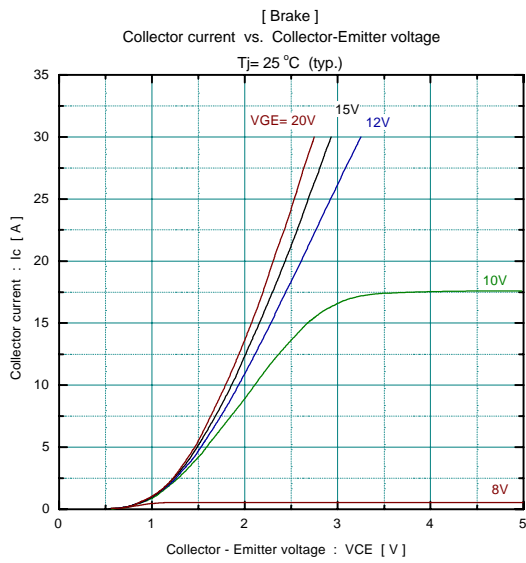

■ Outline Drawings, mm

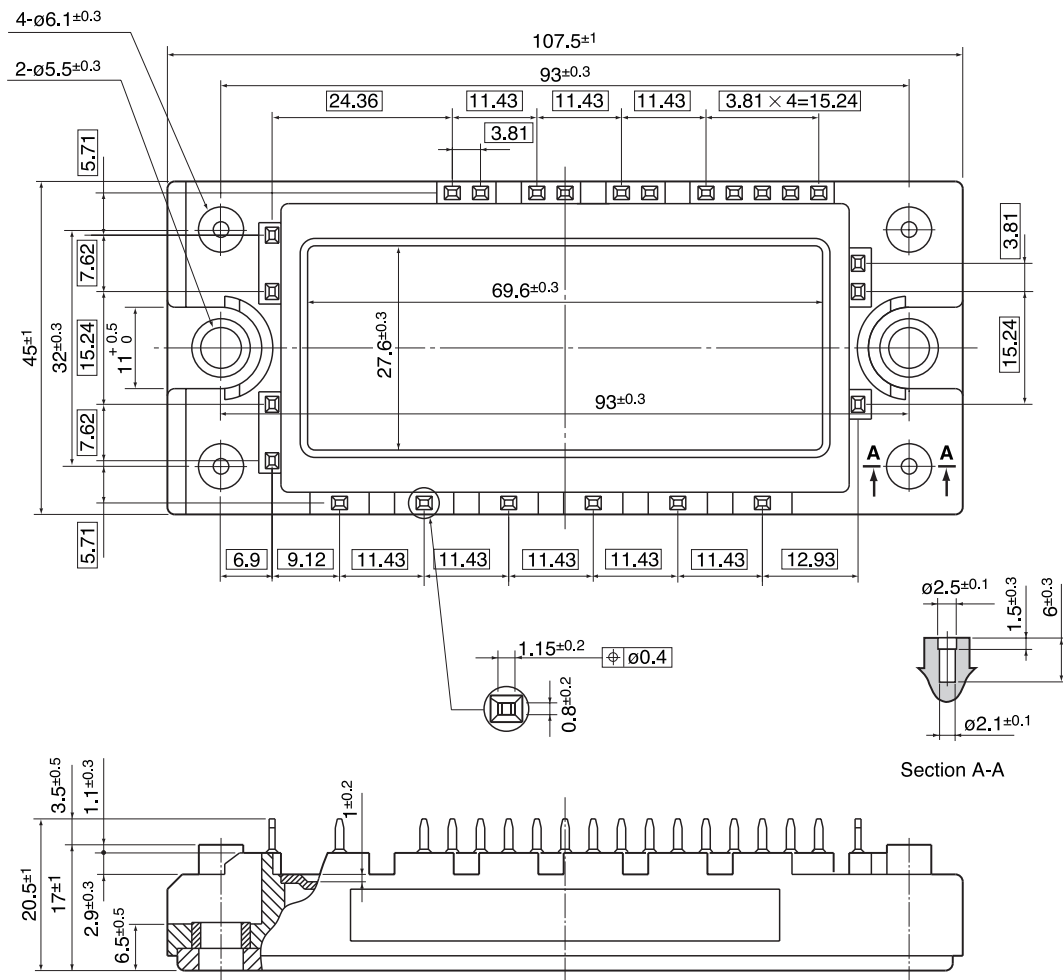

□ Shows theory dimensions