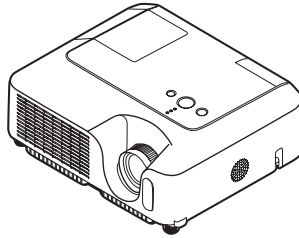


Projector

CP-X256/CP-X265

User's Manual – Operating Guide



Thank you for purchasing this projector.

⚠WARNING ▶ Before using this product, please read the "User's Manual - Safety Guide" and related manuals to ensure the proper use of this product. After reading them, store them in a safe place for future reference.

About this manual

Various symbols are used in this manual. The meanings of these symbols are described below.

- ⚠WARNING** This symbol indicates information that, if ignored, could possibly result in personal injury or even death due to incorrect handling.
- ⚠CAUTION** This symbol indicates information that, if ignored, could possibly result in personal injury or physical damage due to incorrect handling.



📖 Please refer to the pages written following this symbol.

NOTE • The information in this manual is subject to change without notice.
• The manufacturer assumes no responsibility for any errors that may appear in this manual.
• The reproduction, transfer or copy of all or any part of this document is not permitted without express written consent.

Trademark acknowledgment

- VGA and XGA are registered trademarks of International Business Machines Corporation.
 - Apple and Mac are registered trademarks of Apple Computer, Inc.
 - VESA and SVGA are trademarks of Video Electronics Standard Association.
 - Windows is a registered trademark of Microsoft Corporation.
- All other trademarks are the properties of their respective owners.

Content

			
About this manual	1	EASY Menu	25
Content	2	Aspect, Auto keystone Execute,	
Projector features	3	Keystone, Picture mode, Brightness,	
Preparations	3	Contrast, Color, Tint, Sharpness,	
About contents of package	3	Whisper, Mirror, Reset, Filter time,	
Fastening the lens cover	3	Language, Go to advanced menu	
Part names	4	PICTURE Menu	27
Projector	4	Brightness, Contrast, Gamma,Color temp,	
Control buttons	6	Color, Tint, Sharpness, My memory	
Remote control	6	IMAGE Menu	30
Setting up	7	Aspect, Over scan, V. position, H. position,	
Arrangement	8	H. phase, H. size, Auto adjust execute	
Adjusting the projector's elevator	9	INPUT Menu	32
Using the Security Bar	10	Progressive, Video NR, Color space,	
Connecting your devices	11	Component, Video format, Frame lock,	
Connecting power supply	14	RGB in, Resolution	
Remote control	15	SETUP Menu	35
Putting batteries	15	Auto keystone Execute, Keystone,	
Using the remote control	16	Whisper, Mirror, Volume, Audio	
Power on/off	17	SCREEN Menu	37
Turning on the power	17	Language, Menu position, Blank,	
Turning off the power	17	Start up, MyScreen, MyScreen lock,	
Operating	18	Message, Source name	
Adjusting the volume	18	OPTION Menu	40
Temporarily muting the sound	18	Auto search, Auto keystone, Auto on,	
Selecting an input signal	18	Auto off, Lamp time,Filter time,	
Searching an input signal	19	My button, Service, Security	
Selecting an aspect ratio	19	NETWORK Menu	50
Adjusting the zoom and focus	19	DHCP, IP address, Subnet mask,	
Using the automatic adjustment feature	20	Default gateway, Time difference,	
Adjusting the position	20	Date and time, e-SHOT, Information, Service	
Correcting the keystone distortions	21	Maintenance	53
Using the magnify feature	21	Lamp	53
Freezing the screen	22	Air filter	55
Temporarily blanking the screen	22	Replacing Internal Clock battery	57
Operating the computer screen	23	Other care	58
Multifunctional settings	24	Troubleshooting	59
Using the menu function	24	Related messages	59
		Regarding the indicator lamps	60
		Phenomena that may be easy to be mistaken for machine defects	62
		Warranty and after-service	65
		Specifications	65

Projector features

This projector is used to project various computer signals as well as NTSC/PAL/SECAM, Component (SD, HD) video signals onto a screen. It requires just a little space for installation and gets a large image from short distance.

○ High Brightness

Newly developed 200W UHB (Ultra High Brightness) lamp gives you a higher brightness image on a screen. The image can be still kept as bright and clean enough for use in bright rooms.

○ Low Noise

WHISPER mode is available for reducing acoustic noise to realize quieter operation. It is perfect for use in low luminance rooms where low noise is more important than brightness.

○ Rich Connectivity

This projector has a variety of I/O ports. It can be easily connected to many signal sources like PC, DVD and so on. The rich connectivity provides you more options to make your presentation impressive.

○ Compact Body

Even with its many features, this projector is extremely compact and slim, which gives you more flexibility and usability to use it where you want.

Preparations

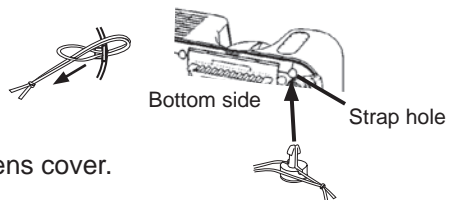
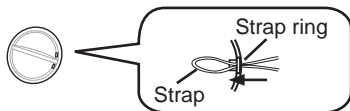
About contents of package

Please see the "Contents of package" of the "User's Manual - Quick Guide". Your projector should come with the items shown there. Contact immediately your dealer if anything is missing.

NOTE • Keep the original packing materials for future reshipment. For moving the projector, be sure to use the original packing materials. Use special caution for the lens part.

Fastening the lens cover

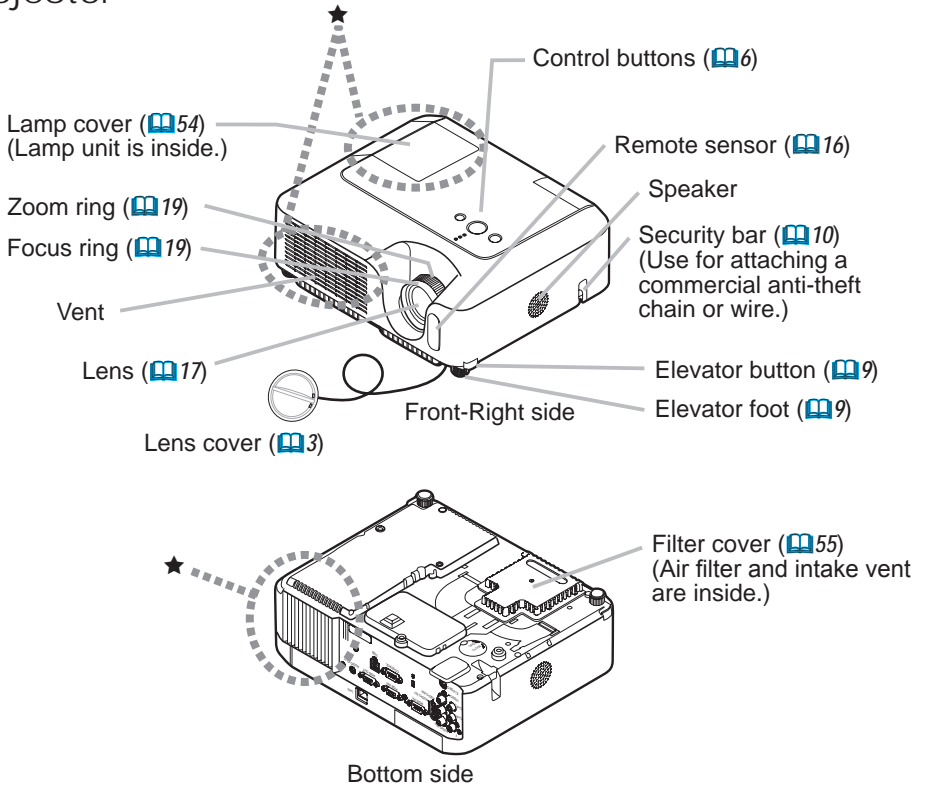
To avoid losing the lens cover, please fasten it the lens cap to the projector using the strap.



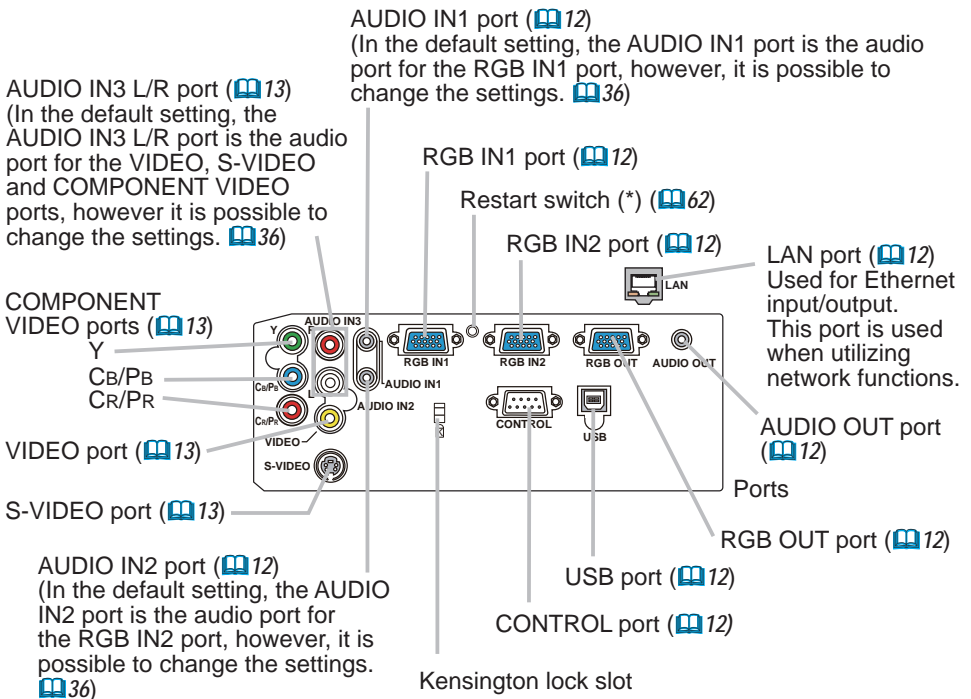
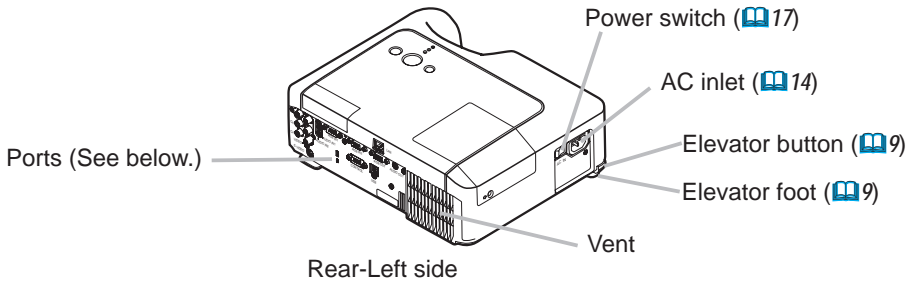
1. Fix the strap to the strap ring of the lens cover.
2. Put the strap into the groove on the rivet.
3. Push the rivet into the strap hole.

Part names

Projector

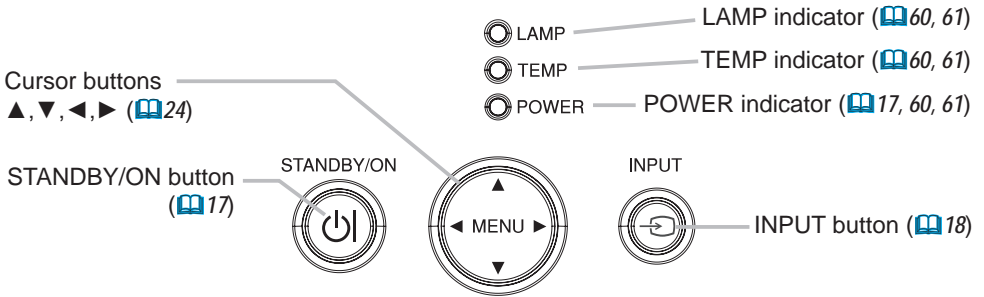


⚠WARNING ▶ During use or immediately after use, do not touch around the lamp and vents of the projector. (★) It could cause a burn.

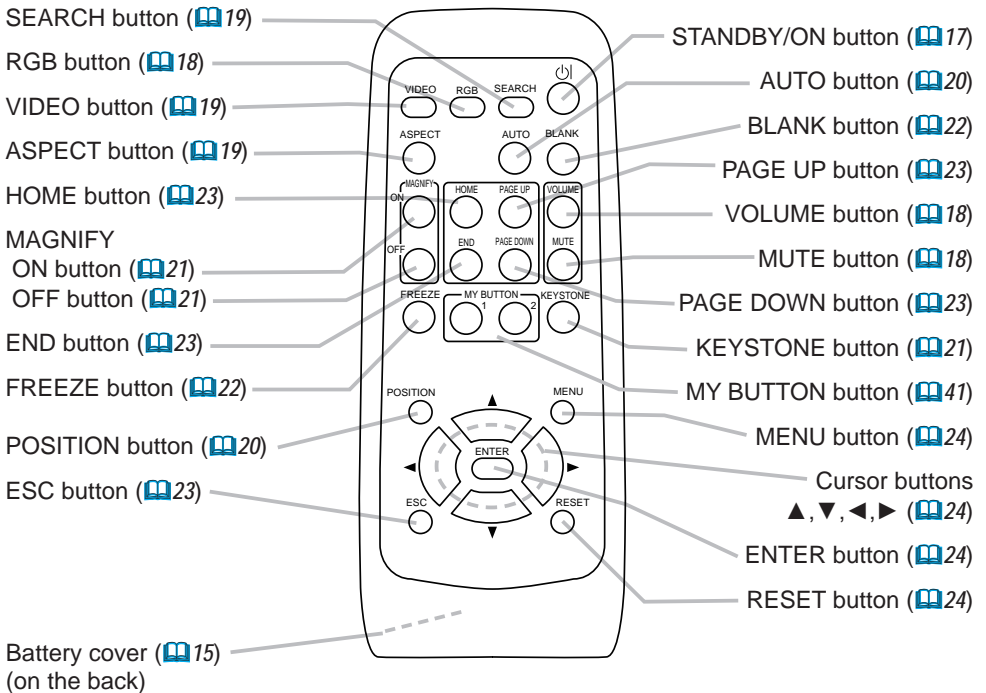


NOTE (*) About Restart switch: This projector is controlled by an internal microprocessor. Under certain exceptional circumstances, the projector may not operate correctly and the microprocessor will need to be reset. In such a case, please push the Restart switch by using a cocktail stick or similar, and before turning on again, make the projector cool down at least 10 minutes without operating. Only push the Restart switch in these exceptional instances.

Control buttons



Remote control



Setting up

⚠WARNING ► Place the projector in a stable position horizontally. A fall or a turnover could cause an injury and/or damage to the projector. Then using damaged projector could result in a fire and/or an electric shock.

- Do not place the projector on an unstable, slant or vibrant surface such as a wobbly or inclined stand.
- Do not place the projector in the side/front/rear-up position, except cleaning the air filter.

► Place the projector in a cool place, and pay attention enough to ventilation. The high temperature of the projector could cause a fire, a burn and/or malfunction to the projector.

- Do not stop up, block and cover the projector's vents.
- Keep a space of 30 cm or more between the sides and other objects such as walls.
- Do not place the projector on a metallic thing or anything weak in heat.
- Do not place the projector on a carpet, cushion or bedding.
- Do not place the projector in direct sunlight or near a hot object such as a heater.
- Put nothing about lens and vents of the projector. Put nothing on the projector.
- Put nothing that is sucked or sticks to the bottom of projector. This projector has some intake vents also on the bottom.

► Do not place the projector on the place that gets wet. Damping the projector or inserting liquid in the projector could cause a fire, an electric shock and/or malfunction to the projector.

- Do not place the projector in a bathroom or the outdoors.
- Put nothing containing the liquid near the projector.

⚠CAUTION ► Avoid a smoky, humid or dusty place. Placing the projector in such place could cause a fire, an electric shock and/or malfunction to the projector.

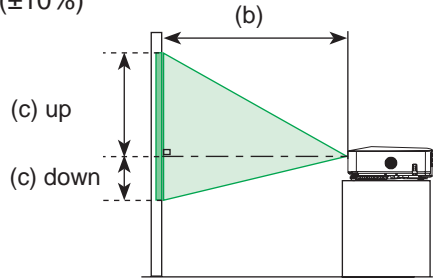
- Do not place the projector near a humidifier, a smoking space or a kitchen.
- Adjust the position of the projector to prevent any strong light, like direct sunlight or inverter fluorescent lamp light, from hitting the projector's remote sensor.

Arrangement

Refer to the illustrations and tables below to determine the screen size and projection distance.

The values shown in the table are calculated for a full size screen: 1024×768

- (a) The screen size (diagonal)
- (b) Distance from the projector to the screen ($\pm 10\%$)
- (c) The height of the screen ($\pm 10\%$)



(a) Screen size [inch (m)]	4 : 3 screen				16 : 9 screen			
	(b) Projection distance [m (inch)]		(c) Screen height [cm (inch)]		(b) Projection distance [m (inch)]		(c) Screen height [cm (inch)]	
	min.	max.	down	up	min.	max.	down	up
30 (0.8)	0.9 (34)	1.1 (41)	5 (2)	41 (16)	1.0 (38)	1.1 (45)	-1 (0)	39 (15)
40 (1.0)	1.2 (46)	1.4 (56)	6 (2)	55 (22)	1.3 (50)	1.5 (61)	-2 (-1)	51 (20)
50 (1.3)	1.5 (58)	1.8 (70)	8 (3)	69 (27)	1.6 (63)	1.9 (76)	-2 (-1)	64 (25)
60 (1.5)	1.8 (70)	2.1 (84)	9 (4)	82 (32)	1.9 (76)	2.3 (91)	-2 (-1)	77 (30)
70 (1.8)	2.1 (81)	2.5 (98)	11 (4)	96 (38)	2.3 (89)	2.7 (107)	-3 (-1)	90 (35)
80 (2.0)	2.4 (93)	2.8 (112)	12 (5)	110 (43)	2.6 (102)	3.1 (122)	-3 (-1)	103 (41)
90 (2.3)	2.7 (105)	3.2 (126)	14 (5)	123 (49)	2.9 (115)	3.5 (138)	-4 (-1)	116 (46)
100 (2.5)	3.0 (117)	3.6 (140)	15 (6)	137 (54)	3.2 (127)	3.9 (153)	-4 (-2)	129 (51)
120 (3.0)	3.6 (140)	4.3 (169)	18 (7)	165 (65)	3.9 (153)	4.7 (184)	-5 (-2)	154 (61)
150 (3.8)	4.5 (176)	5.4 (211)	23 (9)	206 (81)	4.9 (192)	5.8 (230)	-6 (-2)	193 (76)
200 (5.1)	6.0 (235)	7.2 (282)	30 (12)	274 (108)	6.5 (256)	7.8 (307)	-8 (-3)	257 (101)
250 (6.4)	7.5 (294)	9.0 (353)	38 (15)	343 (135)	8.1 (320)	9.8 (384)	-10 (-4)	322 (127)
300 (7.6)	9.0 (352)	10.8 (423)	46 (18)	411 (162)	9.8 (384)	11.7 (461)	-12 (-5)	386 (152)

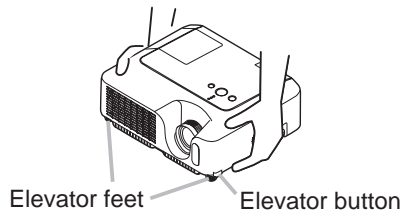
Adjusting the projector's elevator

⚠CAUTION ▶ If you press the elevator button without holding the projector, the projector might crash down, overturn, smash your fingers and possibly result in malfunction. To prevent damaging the projector and injuring yourself, always hold the projector whenever using the elevator buttons to adjust the elevator feet.

▶ Do not incline the projector rightward or leftward. Also do not incline it backward or forward exceeding 30 degrees. Exceeding these range could cause malfunction, and could shorten the lifetime of the consumables.

▶ Except for inclining by the elevator feet adjustment, place the projector horizontally.

You can use the elevator feet to make adjustments if the surface on which you need to set the projector is uneven or if you otherwise need to adjust the angle of projection. The adjustment range of the elevator feet is 0 to 9 degrees.



1. After making sure that the projector is cool adequately, press and hold in the elevator buttons while holding the projector.
The elevator buttons and the elevator feet are on the both sides.
2. Raise or lower the projector to the desired height and release the elevator buttons.
When you release the elevator buttons, the elevator feet will lock into position.
3. If necessary, you can also finely adjust the height of the projector by twisting the elevator feet by hand.

Using the Security Bar

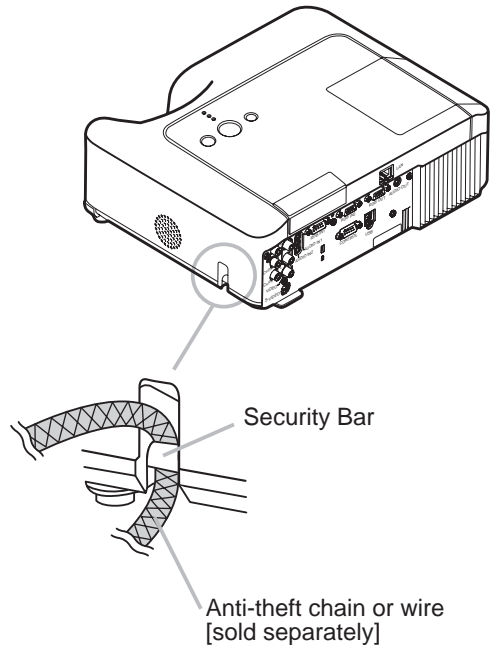
⚠WARNING ► Do not use the security bar to prevent the projector from falling. Dropping or knocking over the projector may cause damage or injury.

⚠CAUTION ► The security bar is not a comprehensive theft prevention measure. It is intended to be used as an extra theft prevention measure.

A commercial anti-theft chain or wire can be attached to the security bar on the projector.

1. How to attach

An anti-theft chain or wire can be attached as shown in the illustration. (Anti-theft chains or wires of up to 10mm in diameter can be used)



Connecting your devices

⚠CAUTION ▶ Turn off all devices prior to connecting them to the projector. Attempting to connect a live device to the projector may generate extremely loud noises or other abnormalities that may result in malfunction and/or damage to the device and/or projector.

▶ Use the accessory cable or a designated-type cable for the connection. Some cables have to be used with core set. A too long cable may cause a certain picture degradation. Please consult with your dealer for details. For cables that have a core only at one end, connect the core to the projector.

▶ Make sure that you connect devices to the correct port. Incorrect connection may result in malfunction and/or damage to the device and/or projector.

NOTE • Whenever attempting to connect a laptop computer to the projector, be sure to activate the laptop's RGB external image output (set the laptop to CRT display or to simultaneous LCD and CRT display). For details on how this is done, please refer to the instruction manual of the corresponding laptop computer.

- Secure the screws on the connectors and tighten.
- Some computers may have multiple display screen modes. Use of some of these modes will not be possible with this projector.
- For some RGB signal modes, the optional Mac adapter is necessary.
- When the image resolution is changed on a computer, depending on an input, automatic adjustment function may take some time and may not be completed. In this case, you may not be able to see a check box to select "Yes/No" for the new resolution on Windows. Then the resolution will go back to the original. It might be recommended to use other CRT or LCD monitors to change the resolution.

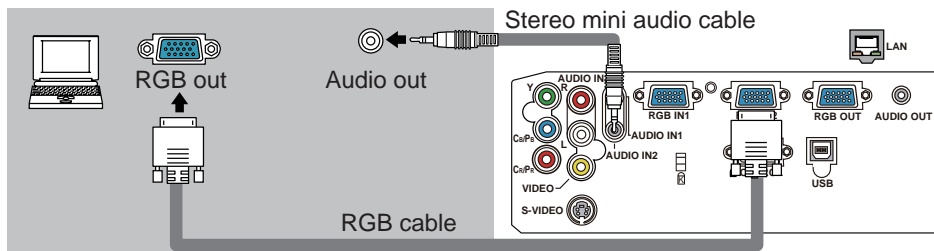
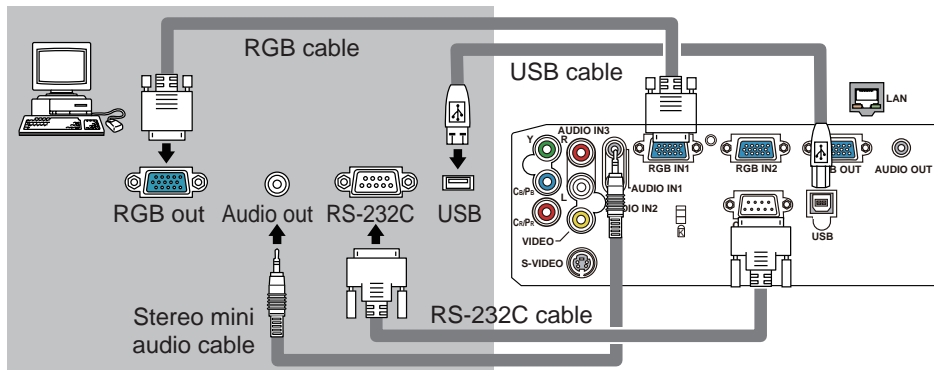
About Plug-and-Play capability

Plug-and-Play is a system composed of the computer, its operating system and peripheral equipment (i.e. display devices). This projector is compatible with VESA DDC 2B. Plug-and-Play can be achieved by connecting this projector to a computer is VESA DDC (display data channel) compatible.

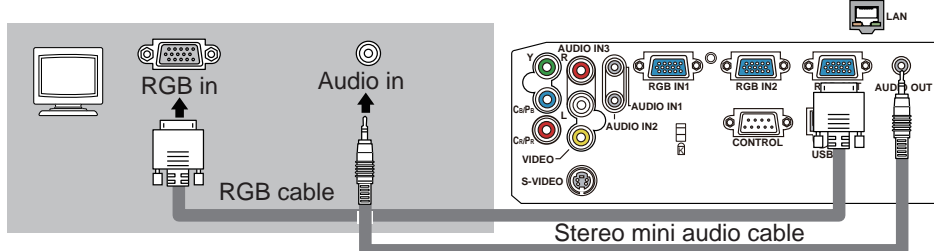
- Please take advantage of this function by connecting the accessory RGB cable to the RGB IN1 port (DDC 2B compatible). Plug-and-Play may not work properly if any other type of connection is attempted.
- Please use the standard drivers in your computer as this projector is a Plug-and-Play monitor.

Examples of connection with a computer

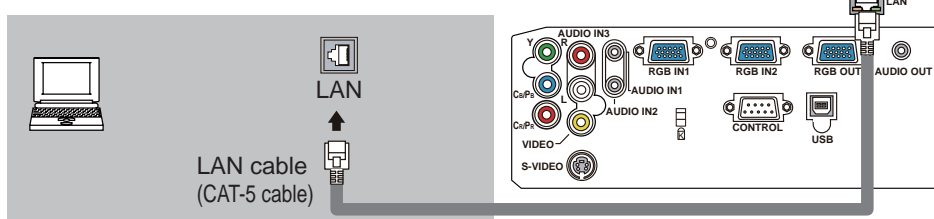
* In the default setting, the AUDIO IN1 port is the audio port for the RGB IN1, and the AUDIO IN2 port is the audio port for the RGB IN2 ports. To change the settings, refer to the AUDIO item in the SETUP menu. (p.36)



Connecting to a monitor (output) and a speaker with amplifier (output)



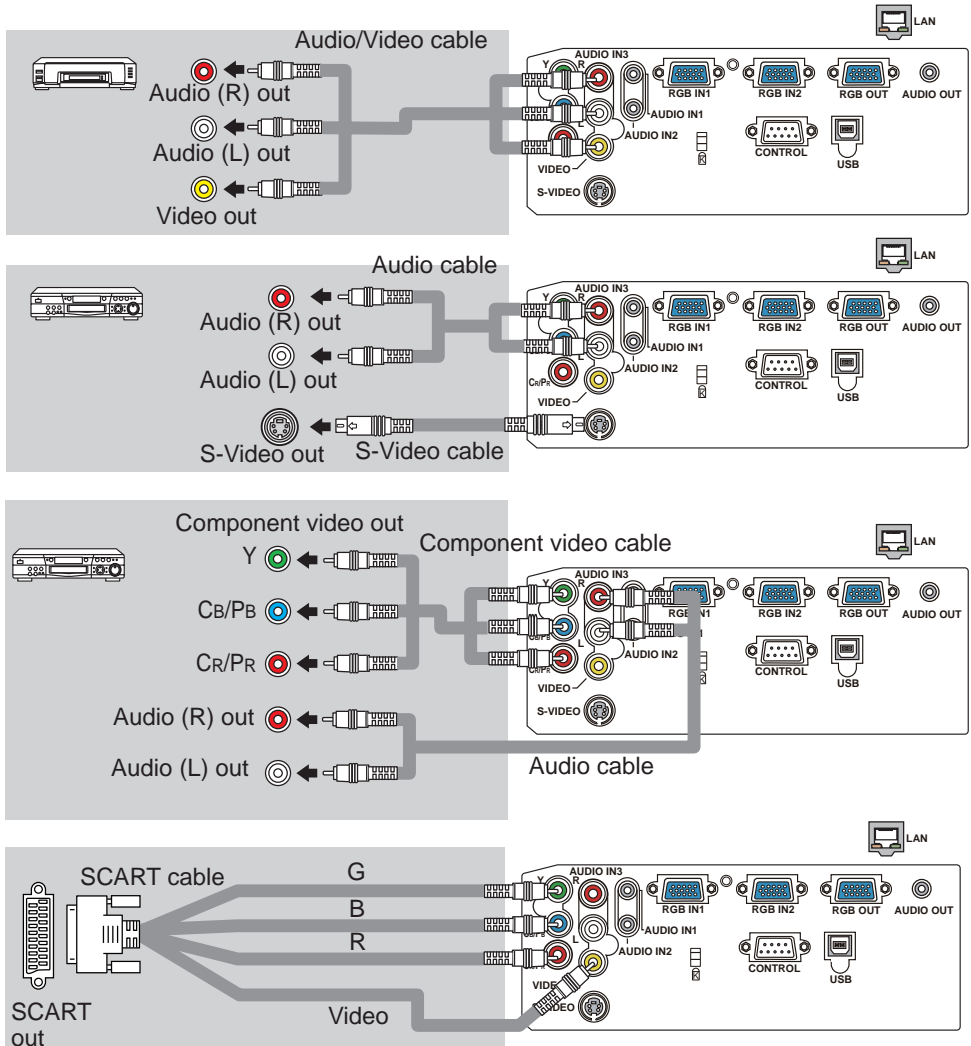
Connecting to a Network



⚠ CAUTION ► For safety, do not connect LAN port to any network that might have the excessive voltage.

Examples of connection with a VCR/DVD player

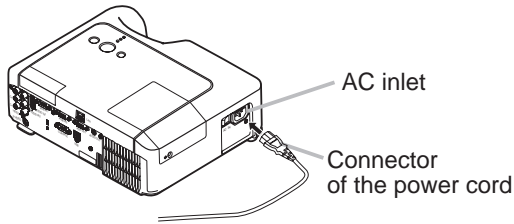
* In the default setting, the AUDIO IN3 L/R port is the audio port for the VIDEO, S-VIDEO and COMPONENT VIDEO ports. To change the settings, refer to the AUDIO item in the SETUP menu. (p.36)



Connecting power supply

⚠WARNING ► Please use extra caution when connecting the power cord, as incorrect or faulty connections may result in fire and/or electrical shock.

- Only use the power cord that came with the projector. If it is damaged, contact your dealer to newly get correct one.
- Only plug the power cord into an outlet rated for use with the power cord's specified voltage range.
- Never modify the power cord. Never attempt to defeat the ground connection of the three-pronged plug.



1. Connect the connector of the power cord to the AC inlet of the projector.
2. Firmly plug the power cord's plug into the outlet.

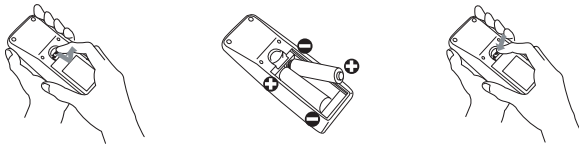
Remote control

Putting batteries

⚠WARNING ▶ Always handle the batteries with care and use them only as directed. Battery may explode if mistreated. Do not recharge, disassemble or dispose of in fire.

And also improper use may result in cracking or leakage, which could result in fire, injury and/or pollution of the surrounding environment.

- Be sure to use only the batteries specified. Do not use batteries of different types at the same time. Do not mix a new battery with used one.
- Make sure the plus and minus terminals are correctly aligned when loading a battery.
- Keep a battery away from children and pets. If swallowed consult a physician immediately for emergency treatment.
- Do not short circuit or solder a battery.
- Do not allow a battery in a fire or water. Keep batteries in a dark, cool and dry place.
- If you observe a leakage of a battery, wipe out the flower and then replace a battery. If the liquid adheres to your body or clothes, rinse well with water immediately.
- Obey the local laws on disposing the battery.



1. Remove the battery cover.
Slide back and remove the battery cover in the direction of the arrow.
2. Insert the batteries.
Align and insert the two AA batteries according to their plus and minus terminals as indicated in the remote control.
3. Close the battery cover.
Replace the battery cover in the direction of the arrow and snap it back into place.

Using the remote control

⚠CAUTION ▶ Be careful in handling the remote control.

- Do not drop or expose the remote control to physical impact.
- Do not get the remote control wet or place it on wet objects. It may result in malfunction.
- Remove the batteries from the remote control and store them in a safe place if you won't be using the remote control for an extended period.
- Replace the batteries whenever the remote control starts malfunctioning.
- When strong lights (such as direct sunlight) or light from an extremely close range (such as from an inverter fluorescent lamp), hit the projector's remote sensor, the remote control may cause to function. Adjust the direction of the projector to keep the light from directly hitting the projector's remote sensor.

The signal settings for the remote control transmitter and the projector's remote sensor can be changed. If the remote control does not function properly try changing the signal setting.

Changing the signal setting for the remote control transmitter

(1) Setting 1 (FREQ. : NORMAL)

Simultaneously press and hold the MUTE and RESET buttons for about 3 seconds.

(2) Setting 2 (FREQ. : HIGH)

Simultaneously press and hold the MAGNIFY OFF and ESC buttons for about 3 seconds.

- Setting 1 is the factory default setting.
- When the batteries are removed from the remote control, user-specified settings are saved for about half a day. If the batteries are removed from the remote control for longer than half a day, the remote will reset to Setting 1.

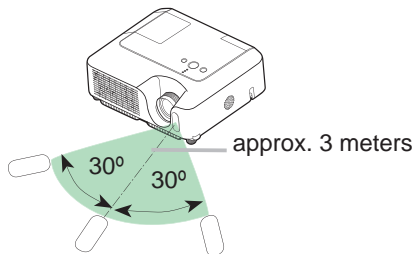
Changing the signal setting for the projector's remote sensor

Switch between Setting 1 and 2 using the SERVICE/REMOTE FREQ. item found in OPTION MENU. (p.43)

If the remote control does not seem to function properly, try changing the settings for the remote control and the projector's remote sensor.

The remote control will not function properly if the remote control transmitter settings and the projector's remote sensor settings are not the same.

The remote control works with the projector's remote sensor.



- The range of the remote sensor is 3 meters with a 60 degree range (30 degrees to the left and right of the remote sensor).
- Also a remote signal reflected in the screen etc. may be available. If it is difficult to send a remote signal to the sensor directly, please try to use the reflected signal.
- Since the remote control uses infrared light to send signals to the projector (Class1 LED), be sure to use the remote control in an area free from obstacles that could block the remote control's output signal to the projector.

Power on/off

⚠ WARNING ▶ When the power is on, a strong light is emitted. Do not look into the lens of projector. Also do not peep at the inside of projector through a hole.

NOTE • Turn the power on/off in right order. Please power on the projector prior to the connected devices. Power off the projector later than the connected devices.

Turning on the power

1. Make sure that the power cord is firmly and correctly connected to the projector and the outlet.
2. Remove the lens cover, and set the power switch to the ON position.

The power indicator will light up in steady orange. Then wait several seconds because the buttons may not function for these several seconds.

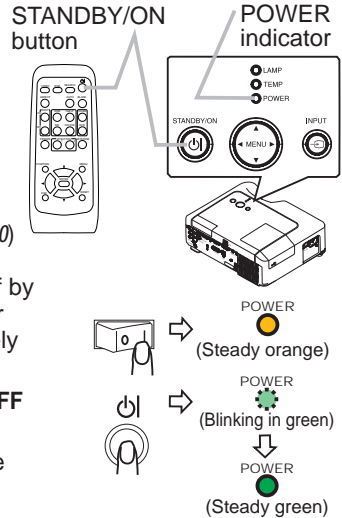
(1) When AUTO ON in the OPTION menu is set to TURN ON: (M40)

The lamp will only be automatically turned on when the Power switch is turned on after the power was turned off by Power switch last time. Afterwards the POWER indicator will begin blinking in green. When the power is completely on, the indicator will stop blinking and light in green.

(2) When AUTO ON in the OPTION menu is set to TURN OFF please see step 3.

3. Press the STANDBY/ON button on the projector or the remote control.

To display the picture, select an input signal according to the section "Selecting an input signal" (M18).

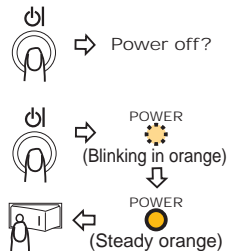


Turning off the power

Please pay special attention to below two points when you do:

- (1) Please do not turn the projector on again for at least 10 minute in this case. Neglect could shorten the lifetime of the lamp.
- (2) During use or immediately after use, do not touch around the lamp and vents of the projector (M4 ★) It could cause a burn.

1. Press the STANDBY/ON button on the projector or the remote control.
The message "Power off?" will appear on the screen for about 5 seconds.
2. Press the STANDBY/ON button on the projector or the remote control again while the message appears.
The projector lamp will go off, and the POWER indicator will begin blinking in orange.
Then the POWER indicator will stop blinking and light in steady orange when the lamp cooling is complete.

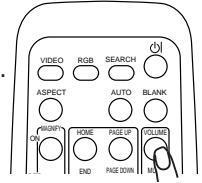


3. Make sure that the power indicator lights in steady orange, and set the power switch to the OFF position. The POWER indicator will go off. Attach the lens cover.

Operating

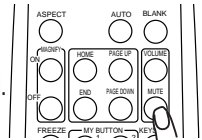
Adjusting the volume

1. Press the VOLUME button on the remote control.
 - A dialog will appear on the screen to aid you in adjusting the volume.
2. Use the cursor buttons ▲/▼ to adjust the volume.
 - To close the dialog and complete the operation, press the VOLUME button again. Even if you don't do anything, the dialog will automatically disappear after a few seconds.



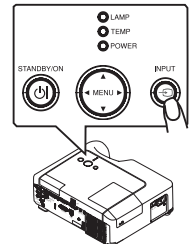
Temporarily muting the sound

1. Press the MUTE button on the remote control.
 - A dialog will appear on the screen indicating that you have muted the sound.
 - To restore the sound, press the MUTE or VOLUME button.
 - Even if you don't do anything, the dialog will automatically disappear after a few seconds.



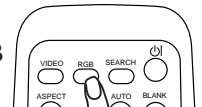
Selecting an input signal

1. Press the INPUT button on the projector.
 - Each time you press the button, the projector switches its input port as below.



1. Press the RGB button on the remote control to select an input port for the RGB signal.
 - Each time you press the button, the projector switches its RGB input port as below.

RGB IN1 ↔ RGB IN2



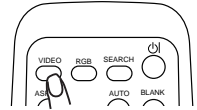
- If the RGB button is pushed (when switching from VIDEO to RGB signals) when TURN ON is selected for the AUTO SEARCH item in the OPTION menu the projector will check the RGB IN1 port first. If no input is detected at the port, the projector will check the RGB IN2 port.

Selecting an input signal (continued)

1. Press the VIDEO button on the remote control to select an input for video signal.

Each time you press the button, the projector switches its video input port as below.

COMPONENT VIDEO → S-VIDEO → VIDEO



- If the VIDEO button is pushed (when switching from RGB to VIDEO signals) when TURN ON is selected for the AUTO SEARCH item in the OPTION menu the projector will check the COMPONENT VIDEO port first. If no input is detected at the port, projector will begin to check other ports in above order.

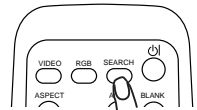
Searching an input signal

1. Press the SEARCH button on the remote control.

The projector will start to check its input ports in order to find any input signals.

When an input is found, the projector will stop searching and display the image. If no signal is found, the projector will return to the state selected before the operation.

RGB IN 1 → RGB IN 2 → COMPONENT VIDEO → S-VIDEO → VIDEO



Selecting an aspect ratio

1. Press the ASPECT button on the remote control.

Each time you press the button, the projector switches the mode for aspect ratio in turn.

- For an RGB signal

NORMAL → 4:3 → 16:9 → SMALL



- For a video signal, s-video signal or component video signal

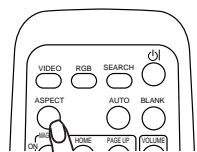
4:3 → 16:9 → 14:9 → SMALL



- For a no signal

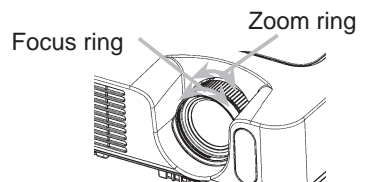
4:3 (fixed)

- The NORMAL mode keeps the original aspect ratio of the signal.
- Performing the automatic adjustment initializes the aspect ratio setting.



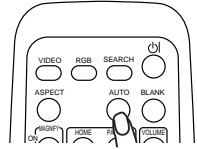
Adjusting the zoom and focus

1. Use the zoom ring to adjust the screen size.
2. Use the focus ring to focus the picture.



Using the automatic adjustment feature

1. Press the AUTO button on the remote control.



○ For an RGB signal

The vertical position, the horizontal position, the horizontal phase and the horizontal size will be automatically adjusted.

And the aspect ratio will be automatically set to default. Make sure that the application window is set to its maximum size prior to attempting to use this feature. A dark picture may still be incorrectly adjusted. Use a bright picture when adjusting.

○ For a video signal or s-video signal

The video format best suited for the respective input signal will be selected automatically.

This function is available only when the AUTO mode is selected to the VIDEO FORMAT item in the INPUT menu (133). For a component video signal, the signal type is identified automatically independently of this function.

○ For a video signal, s-video signal or component video signal

The vertical position, horizontal position and aspect ratio will be automatically set to default.

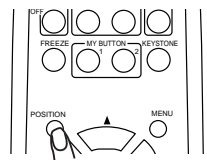
○ For a component video signal

The horizontal phase will be automatically set to default.

- The automatic adjustment operation requires about 10 seconds. Also please note that it may not function correctly with some input.

Adjusting the position

1. Press the POSITION button on the remote control.
The "POSITION" indication will appear on the screen.
2. Use the cursor buttons ▲/▼/◀/▶ to adjust the picture position.



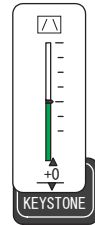
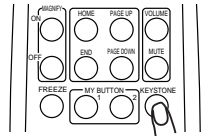
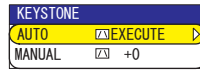
When you want to reset the operation, press the RESET button on the remote control during the operation.

To complete this operation, press the POSITION button again. Even if you don't do anything, the dialog will automatically disappear after a few seconds.

- When this function is performed at a video signal, a certain extra such as a line may appear outside a picture.

Correcting the keystone distortions

1. Press the KEYSTONE button on the remote control. A dialog will appear on the screen to aid you in correcting the distortion.
2. Use the cursor buttons ▲/▼ to select AUTO or MANUAL operation, and press the button ► to perform the following.
 - 1) AUTO executes automatic vertical keystone correction.
 - 2) MANUAL displays a dialog for vertical keystone correction. Use the buttons ▲/▼ for adjustment.

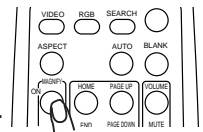


To close the dialog and complete this operation, press the KEYSTONE button again. Even if you don't do anything, the dialog will automatically disappear after a few seconds.

- The adjustable range for correction will vary among inputs. For some input, this function may not work well.
- When V:INVERT or H&V:INVERT is selected to the MIRROR item in the SETUP menu, if the projector screen is inclined or angled downward, the Auto Keystone function may not work correctly.
- When the zoom adjustment is set to the TELE (telephoto focus), this correction may be excessive. This function should be used when the zoom adjustment is set to the WIDE (wide-angle focus) whenever possible.
- When vertical degree is almost 0 degree, the automatic keystone distortion correction may not work.
- When vertical degree is almost ± 30 degree, the automatic keystone distortion correction may not work well.
- This function will be unavailable when Transition Detector is on (48).

Using the magnify feature

1. Press the ON button of MAGNIFY on the remote control.
 - The "MAGNIFY" indication will appear on the screen (although the indication will disappear in several seconds with no operation), and the projector will enter the MAGNIFY mode.
2. Use the cursor buttons ▲/▼ to adjust the zoom level.
 - To move the zoom area, press the POSITION button in the MAGNIFY mode, then use the cursor buttons ▲/▼/◀/▶ to move the area. And to finalize the zoom area, press the POSITION button again.

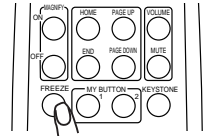


To exit the MAGNIFY mode and restore the screen to normal, press the OFF button of MAGNIFY on the remote control.

- The projector automatically exits the MAGNIFY mode when the input signal is changed, or when the display condition is changed.
- Although in the MAGNIFY mode, the keystone distortion condition may vary, it will be restored when the projector exits the MAGNIFY mode.

Freezing the screen

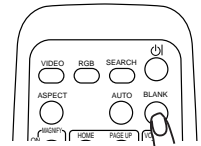
1. Press the FREEZE button on the remote control.
 - The “FREEZE” indication will appear on the screen, and the projector will enter the FREEZE mode.
 - To exit the FREEZE mode and restore the screen to normal, press the FREEZE button again.



- The projector automatically exits the FREEZE mode when the input signal changes, or when one of the projector’s buttons or the remote control buttons of STANDBY/ON, SEARCH, RGB, VIDEO, BLANK, AUTO, ASPECT, VOLUME, MUTE, KEYSTONE, POSITION, MENU, MAGNIFY and MY BUTTON is pressed.
- If the projector continues projecting a still image for a long time, the LCD panel might possibly be printed. Do not leave the projector in the FREEZE mode for too long.

Temporarily blanking the screen

1. Press the BLANK button on the remote control.
 - The blank screen will be displayed instead of the screen of input signal. Please refer to the BLANK item in the SCREEN menu (37).



To exit the blank screen and return to the input signal screen, press the BLANK button again.

- The projector automatically returns to the input signal screen when one of the projector’s buttons or the remote control buttons is pressed or one of the commands (except get commands) is transmitted from the control port.

Operating the computer screen

⚠ CAUTION ▶ Mistaken use of the mouse/keyboard control could damage your equipment.

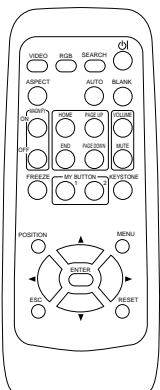
- While using this function, please connect only with a computer.
- Before connecting, read the manuals of the computer you will connect.

NOTE • It may not be possible to control notebook PC, and other computers with built-in pointing device (e.g. track ball), using this remote control. In this case, before connecting go into BIOS (system setup) and select external mouse, and disable the pointing device. In addition, the mouse may not function if the computer does not have the needed utility program. See your computer's hardware manual for details.

- The USB control can be used with Windows 95 OSR 2.1 or higher. It may not be possible to use the remote control, depending on the computer's configurations and mouse drivers.
- The USB control can be used only for the functions listed below. You cannot do things like press two buttons at once (for instance, pressing two buttons at the same time to move the mouse pointer diagonally).
- This function is not available while the lamp is warming up (the POWER indicator flashes green), and while adjusting the volume and display, correcting for trapezoidal distortion, zooming in on the screen, using the BLANK function, or displaying the menu screen.

USB mouse and keyboard control

1. Connect the projector's USB port to the computer via the mouse cable.

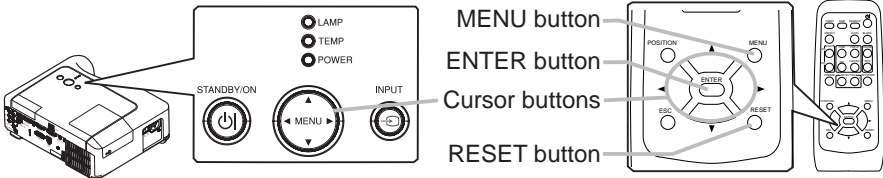


Available function	Remote control operation
Move pointer	Use ▲, ▼, ◀, ▶ buttons
Left click with mouse	Press ENTER button
Right click with mouse	Press RESET button
Press keyboard's HOME key	Press HOME button
Press keyboard's END key	Press END button
Press keyboard's PAGE UP key	Press PAGE UP button
Press keyboard's PAGE DOWN key	Press PAGE DOWN button
Press keyboard's ESC key	Press ESC button

Multifunctional settings

Using the menu function

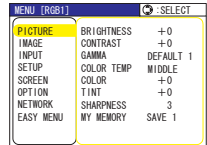
This projector has the following menus: PICTURE, IMAGE, INPUT, SETUP, SCREEN, OPTION, NETWORK, and EASY MENU. EASY MENU consists of functions often used, and the other menus are classified into each purpose. Each of these menus is operated using the same methods. The basic operations of these menus are as follows.



1. Press the MENU button on the remote control or one of the cursor buttons on the projector.
The Advanced MENU or EASY MENU will appear.

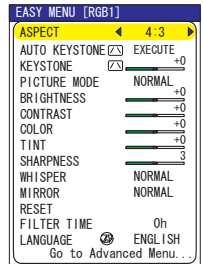
In the EASY MENU

2. If you want to change it to the Advanced MENU, select the "Go to Advanced Menu"
3. Use the cursor buttons ▲/▼ to select an item to operate.
4. Use the cursor buttons ◀/▶ to operate the item.



In the Advanced MENU

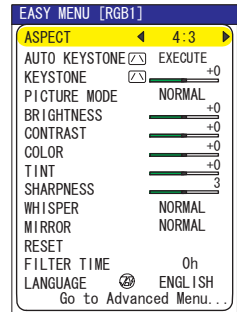
2. Use the cursor buttons ▲/▼ to select a menu.
If you want to change it to the EASY MENU, select the EASY MENU.
Then press the cursor button ▶ on the projector or remote control, or the ENTER button on the remote control to select an item. The display of the selected menu will be active.
3. Use the cursor buttons ▲/▼ to select an item to operate.
Then press the cursor button ▶ on the projector or remote control, or the ENTER button on the remote control to progress. The operation menu of the selected item will appear.
4. Use the cursor buttons ▲/▼ to operate the item.
 - When you want to reset the operation, press the RESET button on the remote control during the operation. Note that items whose functions are performed simultaneously with operation (ex. LANGUAGE, H PHASE, VOLUME etc.) cannot be reset.
 - In the advanced menu, when you want to return to the previous display, press the cursor button ◀ on the projector or remote control, or the ESC button on the remote control.
5. Press the MENU button on the remote control again to close the menu and complete this operation. Even if you don't do anything, the dialog will automatically disappear after about 10 seconds.
 - Some functions cannot be performed when a certain input port is selected, or when a certain input signal is displayed.



EASY Menu

With the EASY MENU, items shown in the table below can be performed.

Select an item using the cursor buttons ▲/▼ on the projector or remote control. Then perform it referring to the following table.



Item	Description
ASPECT	Using the buttons ◀/▶ switches the mode for aspect ratio. See the ASPECT item in the IMAGE menu (📖 30).
AUTO KEYSTONE EXECUTE	Using the button ▶ executes the auto keystone function. See the AUTO KEYSTONE EXECUTE item in the SETUP menu (📖 35). This function will be unavailable when Transition Detector is on (📖 48).
KEYSTONE	Using the buttons ◀/▶ corrects the keystone distortion. See the item KEYSTONE of section SETUP menu. (📖 35) This function will be unavailable when Transition Detector is on (📖 48).
PICTURE MODE	Using the buttons ◀/▶ switches the mode of picture type. The modes of picture type are combinations of a mode of GAMMA and a mode of COLOR TEMP. Choose a suitable mode according to the projected source. <div style="text-align: center;"> </div> <p>NORMAL: (COLOR TEMP = MID DEFAULT) + (GAMMA = #1 DEFAULT) CINEMA: (COLOR TEMP = LOW DEFAULT) + (GAMMA = #2 DEFAULT) DYNAMIC: (COLOR TEMP = HIGH DEFAULT) + (GAMMA = #3 DEFAULT) BOARD(BLACK): (COLOR TEMP = Hi-BRIGHT-1 DEFAULT) + (GAMMA = #4 DEFAULT) BOARD(GREEN): (COLOR TEMP = Hi-BRIGHT-2 DEFAULT) + (GAMMA = #4 DEFAULT) WHITEBOARD: (COLOR TEMP = MID DEFAULT) + (GAMMA = #5 DEFAULT)</p> <ul style="list-style-type: none"> • When the combination of GAMMA and COLOR TEMP differs from pre-assigned modes above, the display on the menu for the PICTURE MODE is "CUSTOM". Please refer to the GAMMA (📖 27) and COLOR TEMP (📖 28) items in the PICTURE menu. • When this function is performed, a certain extra such as a line may appear.
BRIGHTNESS	Using the buttons ◀/▶ adjusts the brightness. See the item BRIGHTNESS in the PICTURE menu (📖 27).

EASY Menu (continued)

Item	Description
CONTRAST	Using the buttons ◀/▶ adjusts the contrast. See the CONTRAST item in the PICTURE menu (p.27).
COLOR	Using the buttons ◀/▶ adjusts the strength of whole color. See the COLOR item in the PICTURE menu (p.28).
TINT	Using the buttons ◀/▶ adjusts the tint. See the TINT item in the PICTURE menu (p.28).
SHARPNESS	Using the buttons ◀/▶ adjusts the sharpness. See the SHARPNESS item in the PICTURE menu (p.28). • There may be some noise when an adjustment is made. This is not a malfunction.
WHISPER	Using the buttons ◀/▶ turns off/on the whisper mode. See the WHISPER item in the SETUP menu (p.35).
MIRROR	Using the buttons ◀/▶ switches the mode for mirror status. See the MIRROR item in the SETUP menu (p.36). If Transition Detector is TURN ON and MIRROR status is changed, Transition Detector Alarm (p.48) will be displayed when projector is restarted after the power switch is turned off.
RESET	Performing this item resets all of the items of EASY MENU except FILTER TIME and LANGUAGE. A dialog is displayed for confirmation. Selecting RESET using the button ▲ performs resetting.
FILTER TIME	Performing this item resets the filter timer which counts usage time of the air filter. A dialog is displayed for confirmation. Selecting RESET using the button ▲ performs resetting. See the FILTER TIME item in the OPTION menu (p.41).
LANGUAGE	Using the buttons ◀/▶ selects the LANGUAGE item to toggle the menu language. Refer to description of LANGUAGE in the SCREEN menu (p.37).
Go to Advanced Menu	Select "Go to Advanced Menu" and press the button ▶ or the ENTER button to use the menu of PICTURE, IMAGE, INPUT, SETUP, SCREEN, OPTION or NETWORK.

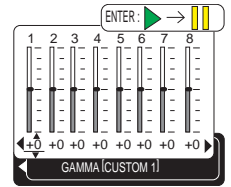
PICTURE Menu

With the PICTURE menu, the items shown in the table below can be performed.

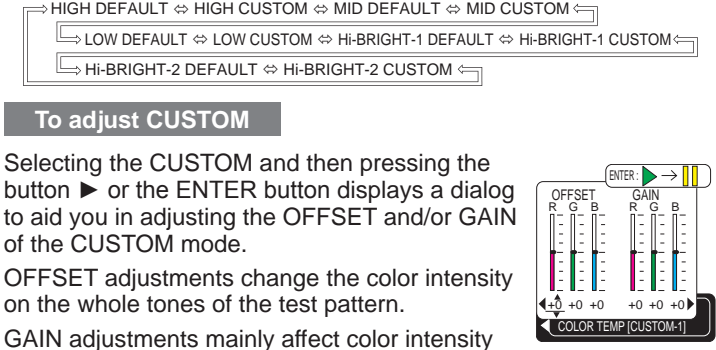
Select an item using the cursor buttons ▲/▼ on the projector or remote control, and press the cursor button ► on the projector or remote control, or the ENTER button on the remote control to execute the item. Then perform it referring to the following table.

MENU [RGB1]		↻:SELECT
PICTURE	BRIGHTNESS	+0
IMAGE	CONTRAST	+0
INPUT	GAMMA	DEFAULT 1
SETUP	COLOR TEMP	MIDDLE
SCREEN	COLOR	+0
OPTION	TINT	+0
NETWORK	SHARPNESS	3
EASY MENU	MY MEMORY	SAVE 1

Item	Description
BRIGHTNESS	Using the buttons ▲/▼ adjusts the brightness. : Light ⇔ Dark
CONTRAST	Using the buttons ▲/▼ adjusts the contrast. : Strong ⇔ Weak
GAMMA	<p>Using the buttons ▲/▼ switches the GAMMA mode.</p> <p>#1 DEFAULT ⇔ #1 CUSTOM ⇔ #2 DEFAULT ⇔ #2 CUSTOM ⇔ #3 DEFAULT</p> <p style="text-align: center;">⇕</p> <p>#5 CUSTOM ⇔ #5 DEFAULT ⇔ #4 CUSTOM ⇔ #4 DEFAULT ⇔ #3 CUSTOM</p> <p style="text-align: center;">⇕</p> <p>To adjust CUSTOM</p> <p>Selecting a mode of CUSTOM and then pressing the button ► or the ENTER button displays a dialog to aid you in adjusting the mode.</p> <p>This function is useful when you want to change the brightness of particular tones.</p> <p>Choose an item using the buttons ◀/▶, and adjust the level using the buttons ▲/▼.</p> <p>You can display a test pattern for checking the effect of your adjustment by pressing the ENTER button. Each time you press the ENTER button, the pattern changes as below.</p> <p>No pattern ⇔ Gray scale of 9 steps ⇨</p> <p>⇨ Ramp ⇔ Gray scale of 15 steps</p> <p>The eight equalizing bars correspond to eight tone levels of the test pattern except the darkest in the left end. If you want to adjust the 2nd tone from left end on the test pattern (Gray scale of 9 steps), use the equalizing adjustment bar "1". The darkest tone at the left end of the test pattern cannot be controlled with any of equalizing adjustment bar.</p> <ul style="list-style-type: none"> When this function is performed, a certain extra such as a line may appear.



PICTURE Menu (continued)

Item	Description
<p>COLOR TEMP</p>	<p>Using the buttons ▲/▼ switches the mode of color temperature.</p> <p>→ HIGH DEFAULT ⇔ HIGH CUSTOM ⇔ MID DEFAULT ⇔ MID CUSTOM ← ↳ LOW DEFAULT ⇔ LOW CUSTOM ⇔ Hi-BRIGHT-1 DEFAULT ⇔ Hi-BRIGHT-1 CUSTOM ← ↳ Hi-BRIGHT-2 DEFAULT ⇔ Hi-BRIGHT-2 CUSTOM ←</p> <p>To adjust CUSTOM</p> <p>Selecting the CUSTOM and then pressing the button ► or the ENTER button displays a dialog to aid you in adjusting the OFFSET and/or GAIN of the CUSTOM mode.</p> <p>OFFSET adjustments change the color intensity on the whole tones of the test pattern.</p> <p>GAIN adjustments mainly affect color intensity on the brighter tones of the test pattern.</p> <p>Choose an item using the buttons ◀/▶, and adjust the level using the buttons ▲/▼.</p> <p>You can display a test pattern for checking the effect of your adjustment by pressing the ENTER button. Each time you press the ENTER button, the pattern changes as below.</p> <p>No pattern ⇔ Gray scale of 9 steps ⇐ ↳ Ramp ⇔ Gray scale of 15 steps</p> <ul style="list-style-type: none"> • When this function is performed, a certain extra such as a line may appear. 
<p>COLOR</p>	<p>Using the buttons ▲/▼ adjusts the strength of whole color.</p> <p>Strong ⇔ Weak</p> <ul style="list-style-type: none"> • This item can be selected only for a video signal, s-video or component video signal.
<p>TINT</p>	<p>Using the buttons ▲/▼ adjusts the tint.</p> <p>Greenish ⇔ Redish</p> <ul style="list-style-type: none"> • This item can be selected only for a video signal, s-video or component video signal.
<p>SHARPNESS</p>	<p>Using the buttons ▲/▼ adjusts the sharpness.</p> <p>Strong ⇔ Weak</p> <ul style="list-style-type: none"> • There may be some noise and/or the screen may flicker for a moment when an adjustment is made. This is not a malfunction.

PICTURE Menu (continued)

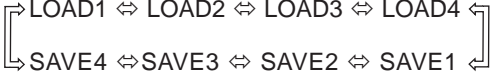
Item	Description
<p>MY MEMORY</p>	<p>Selecting a mode of MY MEMORY using the buttons ▲/▼ and then pressing the button ► or the ENTER button performs each function.</p> <p style="text-align: center;">  </p> <p>This projector has 4 numbered memories for adjustment data. Performing the LOAD1, LOAD2, LOAD3 or LOAD4 loads the data on the memory whose number corresponds to the command's number, and adjusts the picture automatically depending on the data. Performing the SAVE1, SAVE2, SAVE3 or SAVE4 saves the current adjustment data on the memory whose number corresponds to the command's number.</p> <ul style="list-style-type: none"> • The current adjustment data of the items in the PICTURE menu is stored. • There may be some noise and/or the screen may flicker for a moment when data is loaded to memory. This is not a malfunction. <p>When the current settings are not saved to memory the following dialog is displayed.</p> <div style="border: 1px solid black; background-color: #000080; color: white; padding: 5px; width: fit-content; margin: 10px auto;"> <p style="text-align: center;">Temporary condition</p> <p style="text-align: center;">MEMORY : Recall saved parameters</p> <p style="text-align: center;">◀ : Quit</p> </div> <p>To load saved adjustment settings press the MY BUTTON button. When there are no saved adjustment settings the following dialog is displayed.</p> <div style="border: 1px solid black; background-color: #000080; color: white; padding: 5px; width: fit-content; margin: 10px auto;"> <p style="text-align: center;">No saved data</p> </div> <p>~Note~ You have to assign the MY MEMORY function to the MY BUTTON (🔧41).</p>

IMAGE Menu

With the IMAGE menu, items shown in the table below can be performed.

Select an item using the cursor buttons ▲/▼ on the projector or remote control, and press the cursor button ► on the projector or remote control, or the ENTER button on the remote control to execute the item. Then perform it referring to the following table.

MENU [RGB1]		◀ SELECT
PICTURE	ASPECT	4:3
IMAGE	OVER SCAN	5
INPUT	V POSITION	25
SETUP	H POSITION	142
SCREEN	H PHASE	16
OPTION	H SIZE	1344
NETWORK	AUTO ADJUST	EXECUTE
EASY MENU		



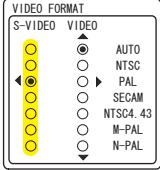
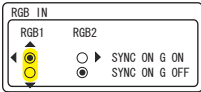
Item	Description
ASPECT	<p>Using the buttons ▲/▼ switches the mode for aspect ratio.</p> <p>For an RGB signal NORMAL ⇔ 4:3 ⇔ 16:9 ⇔ SMALL </p> <p>For a video signal, s-video signal or component video signal 4:3 ⇔ 16:9 ⇔ 14:9 ⇔ SMALL </p> <p>For a no signal 4:3 (fixed)</p> <ul style="list-style-type: none"> The NORMAL mode keeps the original aspect ratio of the signal.
OVER SCAN	<p>Using the buttons ▲/▼ adjusts the over-scan ratio.</p> <p>Large (It reduces picture) ⇔ Small (It magnifies picture)</p> <ul style="list-style-type: none"> This item can be selected only for a video, s-video and component signal. When this adjustment is too large, certain degradation may appear at the frame area of the picture. In such a case, please adjust small.
V POSITION	<p>Using the buttons ▲/▼ adjusts the vertical position.</p> <p>Up ⇔ Down</p> <ul style="list-style-type: none"> Over-adjusting the vertical position may cause noise to appear on the screen. If this occurs please reset the vertical position to the default setting. Pressing the RESET button when V POSITION is selected will reset the V POSITION to the default setting. <p>For a video signal, s-video signal or component video signal The adjustable range of V.POSITION depends on the OVERSCAN setting. It is not possible to adjust when the OVERSCAN is set to 10.</p>
H POSITION	<p>Using the buttons ▲/▼ adjusts the horizontal position.</p> <p>Left ⇔ Right</p> <ul style="list-style-type: none"> Over-adjusting the horizontal position may cause noise to appear on the screen. If this occurs please reset the horizontal position to the default setting. Pressing the RESET button when H POSITION is selected will reset the H POSITION to the default setting. <p>For a video signal, s-video signal or component video signal The adjustable range of H.POSITION depends on the OVERSCAN setting. It is not possible to adjust when the OVERSCAN is set to 10.</p>
H PHASE	<p>Using the buttons ▲/▼ adjusts the horizontal phase to eliminate flicker.</p> <p>Right ⇔ Left</p> <ul style="list-style-type: none"> This item can be selected only for an RGB signal or a component video signal.

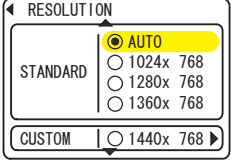

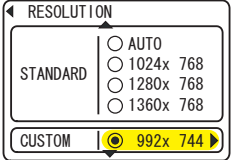
IMAGE Menu (continued)

Item	Description
H SIZE	<p>Using the buttons ▲/▼ adjusts the horizontal size. Large ↔ Small</p> <ul style="list-style-type: none"> • This item can be selected only for an RGB signal. • When this adjustment is excessive, the picture may not be displayed correctly. In such a case, please reset the adjustment by pressing the RESET button on the remote control during this operation.
AUTO ADJUST EXECUTE	<p>Selecting this item performs the automatic adjustment feature.</p> <p>For an RGB signal The vertical position, the horizontal position, the horizontal phase and the horizontal size will be automatically set to default. And the aspect ratio will be automatically selected. Make sure that the application window is set to its maximum size prior to attempting to use this feature. A dark picture may still be incorrectly adjusted. Use a bright picture when adjusting.</p> <p>For a video signal or s-video signal The video format best suited for the respective input signal will be selected automatically. This function is available only when the AUTO mode is selected to the VIDEO FORMAT item in the INPUT menu. For a component video signal, the signal type is identified automatically independently of this function.</p> <p>For a video signal, s-video signal or component video signal The vertical position, horizontal position and aspect ratio will be automatically set to default.</p> <p>For a component video signal The horizontal phase will be automatically set to default.</p> <ul style="list-style-type: none"> • The automatic adjustment operation requires about 10 seconds. Also please note that it may not function correctly with some input.

INPUT Menu (continued)

Item	Description
COMPONENT	<p>Using the buttons ▲/▼ switches the function of COMPONENT VIDEO port.</p> <p>COMPONENT ⇔ SCART RGB</p> <p>When the SCART RGB is selected, the COMPONENT VIDEO port function as a port for a SCART RGB signal input and VIDEO port function as a port for SCART RGB sync input. A SCART adapter and SCART cable realize a SCART RGB input to the projector. For details, contact your dealer.</p>
VIDEO FORMAT	<p>Set the video format for the s-video port and video port.</p> <p>(1) Use the ◀/▶ buttons to select the input port.</p> <p>(2) Using the buttons ▲/▼ switches the mode for video format.</p> <p>AUTO ⇔ NTSC ⇔ PAL ⇔ SECAM ⇕ N-PAL ⇔ M-PAL ⇔ NTSC4.43 ⇕</p> <ul style="list-style-type: none"> • This item is performed only for a video signal from the VIDEO port or the S-VIDEO port. • The AUTO mode automatically selects the optimum mode. • The AUTO operation may not work well for some signals. If the picture becomes unstable (ex. an irregular picture, a color lack), please select the mode depending on the input signal.  <p>The VIDEO FORMAT control panel shows two columns of buttons. The left column is labeled 'S-VIDEO' and has six buttons, with the top one highlighted in yellow. The right column is labeled 'VIDEO' and has seven buttons. The buttons in the VIDEO column are: AUTO (top, highlighted with a dot), NTSC, PAL, SECAM, NTSC4.43, M-PAL, and N-PAL (bottom, highlighted with a dot).</p>
FRAME LOCK	<p>Using the buttons ▲/▼ turns the frame lock function on/off.</p> <p>TURN ON ⇔ TURN OFF</p> <ul style="list-style-type: none"> • This item performs only at a RGB signal with vertical frequency of 50 to 60 Hz. • When the TURN ON is selected, a moving picture is displayed more smoothly. • This function may cause a certain degradation of the picture. In such a case, please select the TURN OFF.
RGB IN	<p>Set the RGB input signal type for the RGB port.</p> <p>(1) Use the ◀/▶ buttons to select the RGB port to be set.</p> <p>RGB1 ⇔ RGB2</p> <p>(2) Use the ▲/▼ buttons to select the RGB input signal type.</p> <p>SYNC ON G ON ⇔ SYNC ON G OFF</p> <ul style="list-style-type: none"> • Selecting TURN ON turns on the SYNC ON G mode. The SYNC ON G mode allows reception of SYNC ON G. • In the SYNC ON G mode, the picture may be distorted with certain input signals. In such a case, remove the signal connector so that no signal is received and turn SYNC ON G off, and then reconnect the signal.  <p>The RGB IN control panel shows two columns of buttons. The left column is labeled 'RGB1' and has two buttons, with the top one highlighted in yellow. The right column is labeled 'RGB2' and has two buttons. The buttons in the RGB2 column are: SYNC ON G ON (top, highlighted with a dot) and SYNC ON G OFF (bottom, highlighted with a dot).</p>

INPUT Menu (continued)

Item	Description
<p>RESOLUTION *2</p>	<p>The resolution for the RGB1 and RGB2 input signals can be set on this projector.</p> <p>(1) In the INPUT menu select RESOLUTION using the ▲/▼ buttons and press the ► button. The RESOLUTION menu will be displayed.</p>  <p>RESOLUTION MENU</p> <p>◀ INFORMATION RGB1 1280x 768 @ 60</p>  <p>CUSTOM RESOLUTION BOX</p> <p>◀ INFORMATION RGB1 992x 744 @ 60</p>  <p>(2) In the RESOLUTION menu select the resolution you wish to display using the ▲/▼ buttons. Selecting AUTO will set a resolution appropriate to the input signal.</p> <p>(3) Pressing the ► or Enter button when selecting a STANDARD resolution will automatically adjust the horizontal and vertical positions, clock phase and horizontal size and automatically select an aspect ratio. The INFORMATION dialog (43) will be displayed.</p> <p>(4) To set a custom resolution use the ▲/▼ buttons to select CUSTOM and the CUSTOM RESOLUTION BOX will be displayed. Set the horizontal (HORZ) and vertical (VERT) resolutions using the ▲/▼/◀/▶ buttons. *1</p> <p>(5) To save the setting place the cursor on the right-most digit and press the ► button. The horizontal and vertical positions, clock phase and horizontal size will be automatically adjusted and an aspect ratio will be automatically selected. After the INFORMATION(43) dialog has displayed for about 10 seconds the screen will return to the RESOLUTION menu displaying the changed resolution.</p> <p>(6) To revert back to the previous resolution without saving changes place the cursor on the left-most digit and press the ◀ button. The screen will then return to the RESOLUTION menu displaying the previous resolution.</p>

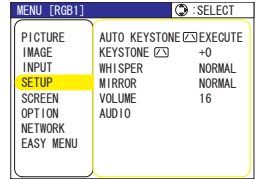
*1 Not all resolutions are guaranteed.

*2 For some pictures, this function may not work well.

SETUP Menu





With the SETUP menu, the items shown in the table below can be performed.

Select an item using the cursor buttons ▲/▼ on the projector or remote control, and press the cursor button ► on the projector or remote control, or the ENTER button on the remote control to execute the item. Then perform it referring to the following table.



Item	Description
AUTO KEYSTONE EXECUTE	<p>Selecting this item performs the Automatic keystone distortion correction. Projector automatically corrects vertical keystone distortion due to the (forward/backward) setup angle by itself.</p> <ul style="list-style-type: none"> • This function will be executed only once when selected in the Menu. When the slant of the projector is changed, executes this function again. • When V:INVERT or H&V:INVERT is selected to the MIRROR item in the SETUP menu, if the projector screen is inclined or angled downward, this function may not work correctly. • When the zoom adjustment is set to the TELE (telephoto focus), this correction may be excessive. This function should be used when the zoom adjustment is set to the WIDE (wide-angle focus) whenever possible. • When vertical degree is almost 0 degree, the automatic keystone distortion correction may not work. • When vertical degree is over ± 30 degree, the automatic keystone distortion correction may not work well. • This function will be unavailable when Transition Detector is on (📖48).
KEYSTONE	<p>Using the buttons ▲/▼ corrects the keystone distortion. Upper in the data ⇄ Lower in the data</p> <ul style="list-style-type: none"> • The adjustable range of this function will vary with the type of input signal. At some signals, this function may not work well. • This function will be unavailable when Transition Detector is on (📖48).
WHISPER	<p>Using the buttons ▲/▼ turns off/on the whisper mode. NORMAL ⇄ WHISPER</p> <ul style="list-style-type: none"> • When the WHISPER is selected, acoustic noise and screen brightness are reduced.

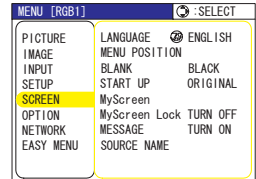
SETUP Menu (continued)

Item	Description																									
<p>MIRROR</p>	<p>Using the buttons ▲/▼ switches the mode for mirror status.</p> <div style="display: flex; justify-content: space-around; align-items: center;">     </div> <p>NORMAL ⇔ H:INVERT ⇔ V:INVERT ⇔ H&V:INVERT</p> <p style="text-align: center;">↑ ↑</p> <p>If Transition Detector is TURN ON and MIRROR status is changed, Transition Detector Alarm (🔔 48) will be displayed when projector is restarted after the power switch is turned off.</p>																									
<p>VOLUME</p>	<p>Using the buttons ▲/▼ adjusts the volume. High ⇔ Low</p>																									
<p>AUDIO</p>	<p>Allocates the audio ports. Choose a picture input port using the buttons ▲/▼ (1), then select the audio port to be interlocked with the input port using the buttons ◀/▶ (2). When off is selected, all audio ports do not work for the input port.</p> <p>(1) RGB1 ⇔ RGB2 ⇔ COMPONENT ⇔ S-VIDEO ⇔ VIDEO</p> <p>(2) 1 ⇔ 2 ⇔ 3 ⇔ ✕</p> <div style="border: 1px solid black; padding: 5px; margin-top: 10px;"> <p style="text-align: center; font-weight: bold;">AUDIO</p> <p style="text-align: center;">◀ QUIT</p> <table style="width: 100%; border-collapse: collapse;"> <tr> <td style="padding: 2px;">RGB1</td> <td style="padding: 2px;">◀ ●</td> <td style="padding: 2px;">○</td> <td style="padding: 2px;">○</td> <td style="padding: 2px;">▶ ●</td> </tr> <tr> <td style="padding: 2px;">RGB2</td> <td style="padding: 2px;">○</td> <td style="padding: 2px;">●</td> <td style="padding: 2px;">○</td> <td style="padding: 2px;">○</td> </tr> <tr> <td style="padding: 2px;">COMPONENT</td> <td style="padding: 2px;">○</td> <td style="padding: 2px;">○</td> <td style="padding: 2px;">●</td> <td style="padding: 2px;">○</td> </tr> <tr> <td style="padding: 2px;">S-VIDEO</td> <td style="padding: 2px;">○</td> <td style="padding: 2px;">○</td> <td style="padding: 2px;">○</td> <td style="padding: 2px;">●</td> </tr> <tr> <td style="padding: 2px;">VIDEO</td> <td style="padding: 2px;">○</td> <td style="padding: 2px;">○</td> <td style="padding: 2px;">○</td> <td style="padding: 2px;">○</td> </tr> </table> </div>	RGB1	◀ ●	○	○	▶ ●	RGB2	○	●	○	○	COMPONENT	○	○	●	○	S-VIDEO	○	○	○	●	VIDEO	○	○	○	○
RGB1	◀ ●	○	○	▶ ●																						
RGB2	○	●	○	○																						
COMPONENT	○	○	●	○																						
S-VIDEO	○	○	○	●																						
VIDEO	○	○	○	○																						

SCREEN Menu


With the SCREEN menu, the items shown in the table below can be performed.

Select an item using the cursor buttons ▲/▼ on the projector or remote control, and press the cursor button ► on the projector or remote control, or the ENTER button on the remote control to execute the item. Then perform it referring to the following table.









Item	Description
LANGUAGE	<p>Using the buttons ▲/▼ switches the OSD (On Screen Display) language.</p> <p>ENGLISH ⇄ FRANÇAIS ⇄ DEUTSCH ⇄ ESPAÑOL ⇄ ITALIANO</p> <p>↓</p> <p>NORSK ⇄ NEDERLANDS ⇄ PORTUGUÊS ⇄ 日本語</p> <p>↓</p> <p>简体中文 ⇄ 繁體中文 ⇄ 한글 ⇄ SVENSKA ⇄ РУССКИЙ</p> <p>↓</p> <p>SUOMI ⇄ POLSKI ⇄ TÜRKÇE</p> <p>↑</p>
MENU POSITION	<p>Using the buttons ◀/▶/▲/▼ adjusts the menu position.</p> <p>To quit the operation, press the MENU button on the remote control or keep no operation for about 10 seconds.</p>
BLANK	<p>Using the buttons ▲/▼ switches the mode for the blank screen. The blank screen is a screen for the temporarily blanking feature (22). It is displayed by pressing the BLANK button on the remote control.</p> <p>MyScreen ⇄ ORIGINAL ⇄ BLUE ⇄ WHITE ⇄ BLACK</p> <p>↑</p> <p>MyScreen is a screen you can register as a desired screen. The ORIGINAL screen is the existing standard screen. BLUE, WHITE and BLACK are non-patterned (plain) screens in each color.</p> <ul style="list-style-type: none"> • To avoid remaining as an afterimage, the MyScreen and the ORIGINAL screens will change to the BLACK screen after several minutes. • For the MyScreen, please refer to the MyScreen item (38).

SCREEN Menu (continued)

Item	Description
START UP	<p>Using the buttons ▲/▼ switches the mode for the start-up screen. The start-up screen is a screen displayed when no signal or an unsuitable signal is detected.</p> <p>MyScreen ⇔ ORIGINAL ⇔ TURN OFF</p>  <p>MyScreen is a screen you can register as a desired screen. The ORIGINAL screen is the existing standard screen. When TURN OFF is selected, the BLACK screen is used.</p> <ul style="list-style-type: none"> • To avoid remaining as an afterimage, the MyScreen and the ORIGINAL screens will change to the BLANK screen after several minutes. If also the BLANK screen is the MyScreen or ORIGINAL, it will change to the BLACK screen. • For the MyScreen, please refer to the item MyScreen below. For the BLANK screen, please refer to the BLANK item (p. 37). • This function will be unavailable and fixed to Myscreen when MyScreen Password in the Security Menu is on.
MyScreen	<p>This item functions for capturing the MyScreen of the blank screen and the start-up screen. Please execute displaying the input including the picture you want to capture.</p> <ol style="list-style-type: none"> 1. Selecting this item displays a dialog titled “MyScreen”. It will ask you if you start capturing the picture from the current screen. Please wait for the target picture to be displayed, and press the ENTER button on the remote control when the picture is displayed. The picture will freeze and the frame for capturing appears. To stop performing, press the RESET or ESC button on the remote control. 2. Using the buttons ◀/▶/▲/▼ adjusts the frame position. Please move the frame to the position of the picture which you want to use. The frame may not be able to be moved for some input signals. To start registration, press the ENTER button on the remote control. To restore the screen and return to the previous dialog, press the RESET or ESC button on the remote control. <p>Registration takes several minutes. When the registration is completed, the registered screen and the message “MyScreen registration is finished.” are displayed for several seconds. If the registration failed, the message “A capturing error has occurred. Please try again.” is displayed.</p> <ul style="list-style-type: none"> • This function will be unavailable when MyScreen Password in the Security Menu is on. <p>NOTE : The KEYSTONE cannot be adjusted while using the MyScreen function.</p>
MyScreen Lock	<p>Using the buttons ▲/▼ turns on/off the MyScreen lock function.</p> <p>TURN ON ⇔ TURN OFF</p> <p>When the TURN ON is selected, the item MyScreen is locked. Use this function for protecting the current MyScreen.</p> <ul style="list-style-type: none"> • This function will be unavailable when MyScreen Password in the Security Menu is on.

SCREEN Menu (continued)

Item	Description
MESSAGE	<p>Using the buttons ▲/▼ turns on/off the message function. TURN ON ⇔ TURN OFF</p> <p>When the TURN ON is selected, the following message function works. "AUTO IN PROGRESS" while automatically adjusting "NO INPUT IS DETECTED" "SYNC IS OUT OF RANGE" "Searching...." while searching for the input "Detecting...." while an input signal is detected The indication of the input signal displayed by changing The indication of the aspect ration displayed by changing The indication of the My Memory displayed by changing The indication of the Picture Mode displayed by changing The indication of "FREEZE" and "II" while freezing the screen by pressing the FREEZE button.</p> <ul style="list-style-type: none"> • When the TURN OFF is selected, please remember if the picture is freezing. Do not mistake freezing for a malfunction ( 22).
SOURCE NAME	<p>Each input port for this projector can have a name applied to it.</p> <p>(1) Use the ▲/▼ buttons on the SCREEN menu to select SOURCE NAME and press the ► button. The SOURCE NAME menu will be displayed.</p> <p>(2) Use the ▲/▼ buttons on the SOURCE NAME menu to select the port to be named and press the ► button. The SOURCE NAME dialog will be displayed.</p> <p>(3) The current name will be displayed on the first line. Use the ◀/▶/▲/▼ and ENTER or INPUT buttons to select and enter characters. The RESET button can be used to erase 1 character at a time. The name can be a maximum of 16 characters.</p> <p>(4) To change an already inserted character, press the ▲ button while the cursor is on the [A-N] row to move the cursor to the name displayed on the first line and use the ◀/▶ buttons to select character to be changed. Once a character in the name is selected use the ▼ button to move the cursor back down to the character entry area to select and enter characters as described above.</p> <p>(5) Select  and press the ENTER or INPUT buttons when finished entering text. To revert to the previous name without saving changes press the ESC or ◀ button and the INPUT button simultaneously.</p> <div data-bbox="800 715 1036 858" style="border: 1px solid black; padding: 5px;"> <p>◀SOURCE NAME</p> <p>RGB1 : </p> <p>RGB2 : DESKTOP PC</p> <p>COMPONENT : DVD</p> <p>S-VIDEO : CAMERA</p> <p>VIDEO : VTR</p> </div> <p style="text-align: center;">SOURCE NAME MENU *Right side of the menu is blank until a name is specified</p> <div data-bbox="792 943 1036 1114" style="border: 1px solid black; padding: 5px;"> <p>NAME: RGB1  SELECT</p> <p>R G B 1</p> <p>A B C D E F G H I J K L M N</p> <p>O P Q R S T U V W X Y Z</p> <p>a b c d e f g h i j k l m n</p> <p>o p q r s t u v w x y z</p> <p>0 1 2 3 4 5 6 7 8 9</p> <p>- . # ! ? &</p> <p>ESC. ◀ ◻ : QUIT ENTER ◻ : NEXT</p> </div> <div data-bbox="792 1134 1036 1305" style="border: 1px solid black; padding: 5px;"> <p>NAME: RGB1  SELECT</p> <p>R G B 1</p> <p>A B C D E F G H I J K L M N</p> <p>O P Q R S T U V W X Y Z</p> <p>a b c d e f g h i j k l m n</p> <p>o p q r s t u v w x y z</p> <p>0 1 2 3 4 5 6 7 8 9</p> <p>- . # ! ? &</p> <p>ESC. ◀ ◻ : QUIT</p> </div> <div data-bbox="792 1326 1036 1497" style="border: 1px solid black; padding: 5px;"> <p>NAME: RGB1  SELECT</p> <p>R G B 1</p> <p>A B C D E F G H I J K L M N</p> <p>O P Q R S T U V W X Y Z</p> <p>a b c d e f g h i j k l m n</p> <p>o p q r s t u v w x y z</p> <p>0 1 2 3 4 5 6 7 8 9</p> <p>- . # ! ? &</p> <p>ESC. ◀ ◻ : QUIT ENTER ◻ : NEXT</p> </div>

OPTION Menu



With the OPTION menu, the items shown in the table below can be performed.

Select an item using the cursor buttons ▲/▼ on the projector or remote control, and press the cursor button ► on the projector or remote control, or the ENTER button on the remote control to execute the item, except for the items LAMP TIME and FILTER TIME. Then perform it referring to the following table.



MENU [RGB1]		SELECT
PICTURE	AUTO SEARCH	TURN OFF
IMAGE	AUTO KEYSTONE	TURN OFF
INPUT	AUTO ON	TURN OFF
SETUP	AUTO OFF	0min
SCREEN	LAMP TIME	0h
OPTION	FILTER TIME	0h
NETWORK	MY BUTTON	
EASY MENU	SERVICE	
	SECURITY	

Item	Description
AUTO SEARCH	<p>Using the buttons ▲/▼ turns on/off the automatic signal search function. TURN ON ⇔ TURN OFF</p> <p>When the TURN ON is selected, detecting no signal automatically cycles through input ports in the following order. The search is started from the current port. Then when an input is found, the projector will stop searching and display the image.</p> <p>RGB IN1 ⇨ RGB IN2 ⇨ COMPONENT VIDEO ⇨ S-VIDEO ⇨ VIDEO</p> <p style="text-align: center;">↑ └──┘</p>
AUTO KEYSTONE	<p>Using the buttons ▲/▼ turns on/off the automatic keystone function. TURN ON ⇔ TURN OFF</p> <p>TURN ON : Automatic keystone distortion correction will be executed whenever changing the slant of the projector.</p> <p>TURN OFF : This function is disabled. Please execute the AUTO KEYSTONE EXECUTE in the SETUP Menu for automatic keystone distortion correction.</p> <p>When the projector is suspended from the ceiling this feature will not function properly so select TURN OFF. This function will be unavailable when Transition Detector is on (48).</p>
AUTO ON	<p>Using the buttons ▲/▼ turns on/off the AUTO ON function. TURN ON ⇔ TURN OFF</p> <p>When set to TURN ON, the lamp will only be automatically turned on when the Power switch is turned on after the power was turned off by Power switch last time.</p> <p>The lamp will not be automatically turned on when the Power switch is turned on if the lamp was turned off with the following procedures.</p> <ul style="list-style-type: none"> • The lamp was turned off with a remote control, projector button, or power turn off command. • The lamp was turned off with an AUTO OFF function (47). • The lamp was turned on by an AUTO ON function and was turned off about 30 minutes after no signal had been detected. <p>When no input is detected after the power on and AUTO OFF time is set to 0, the projector will be turned off after about 30 minutes passed.</p> <p>When no input is detected after the power on and AUTO OFF time is set to 1 to 99, the projector will be turned off after the passed time reaches at the set time.</p> <p>If one of the projector's buttons or the remote control buttons is pressed or one of the commands (except get commands) is transmitted from the control port during the corresponding time, projector will not be turned off.</p>

OPTION Menu (continued)

Item	Description
<p>AUTO OFF</p>	<p>Using the buttons ▲/▼ adjusts the time to count down to automatically turn the projector off. Long (max. 99 minutes) ⇔ Short (min. 0 minute = DISABLE)</p> <div style="display: flex; justify-content: center; gap: 20px;">   </div> <p>When the time is set to 0, the projector is not turned off automatically. When the time is set to 1 to 99, and when the passed time with no-signal or an unsuitable signal reaches at the set time, the projector lamp will be turned off.</p> <p>If one of the projector's buttons or the remote control buttons is pressed or one of the commands (except get commands) is transmitted from the control port during the corresponding time, projector will not be turned off.</p> <p>Please refer to the section "Turning off the power" (17).</p>
<p>LAMP TIME</p>	<p>The lamp time is the time counted after the last resetting. It is shown in the OPTION menu as the usage time of the lamp. Pressing the RESET button on the remote control or the button ► of the projector displays a dialog. To reset the lamp time, select the RESET using the button ▲.</p> <p>RESET ⇔ CANCEL</p> <ul style="list-style-type: none"> • Please reset the lamp time only when you have replaced the lamp, for a suitable indication about the lamp. • For the lamp replacement, see the section "Lamp" (53, 54).
<p>FILTER TIME</p>	<p>The filter time is the time counted after the last resetting. It is shown in the OPTION menu as the usage time of the air filter. Pressing the RESET button on the remote control or the button ► of the projector displays a dialog. To reset the filter time, select the RESET using the button ▲.</p> <p>RESET ⇔ CANCEL</p> <ul style="list-style-type: none"> • Please reset the filter time only when you have cleaned or replaced the air filter, for a suitable indication about the air filter. • For the air filter cleaning, see the section "Air filter" (55, 56).
<p>MY BUTTON</p>	<p>Sets the assigned function for the MY BUTTON1 and 2 buttons on the included remote control.</p> <ul style="list-style-type: none"> • RGB1: Sets port to RGB1. • RGB2: Sets port to RGB2. • COMPONENT: Sets port to COMPONENT. • S-VIDEO: Sets port to S-VIDEO. • VIDEO: Sets port to VIDEO. • e-SHOT: Displays the e-SHOT menu (51). • INFORMATION: Displays INPUT INFORMATION (43). • AUTO KEYSTONE EXECUTE: Performs automatic KEYSTONE correction (35). • MY MEMORY: Loads MY MEMORY settings (29). • PICTURE MODE: Changes the PICTURE mode (25). • FILTER RESET: Displays the filter time reset confirmation dialogue (41). • VOLUME+: Sets the volume up. • VOLUME-: Sets the volume down.

OPTION Menu (continued)

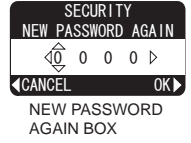
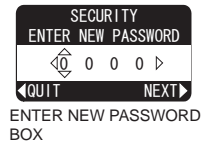
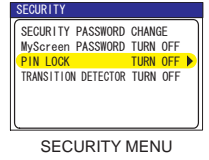
Item	Description
<p>SERVICE</p>	<p>Selecting this item displays the SERVICE menu. Select an item using the buttons ▲/▼, and press the button ► or the ENTER button on the remote control to execute the item.</p> <p>FAN SPEED ⇄ AUTO ADJUST ⇄ GHOST ⇄ FILTER MESSAGE ⇄ KEY LOCK</p> <p style="text-align: center;">   </p> <p>FACTORY RESET ⇄ INFORMATION ⇄ REMOTE FREQ.</p> <p>FAN SPEED Using the buttons ▲/▼ switches the rotation speed of the cooling fans. The HIGH is the mode for use at highlands etc. Note that the projector is noisier when the HIGH is selected. HIGH ⇄ NORMAL</p> <p>AUTO ADJUST Using the buttons ▲/▼ enables/disables the automatic adjustment. When DISABLE is selected, the automatic adjustment feature is disabled, although rough adjustment is automatically performed depending on the basic setting. ENABLE ⇄ DISABLE</p> <ul style="list-style-type: none"> Depending on conditions, such as input image, signal cable to the projector, environment around the projector, etc., the automatic adjustment may not work correctly. In such a case, please choose DISABLE to disable the automatic adjustment, and make adjustment manually. <p>GHOST 1. Select a color element of ghost using the buttons ◀/▶. 2. Adjust the selected element using the buttons ▲/▼ to disappear ghost.</p> <p>FILTER MESSAGE Use the ▲/▼ button to set the timer for the interval to show the message for cleaning up the air filter. 50h ⇄ 100h ⇄ 200h ⇄ 300h ⇄ TURN OFF After selecting “50h”, “100h”, “200h”, or “300h”, the message “REMINDER *** HRS PASSED AFTER THE LAST FILTER CHECK” will appear after the timer reaches the interval time set by the menu. (p.59) When the “TURN OFF” is chosen, the air filter cleaning message will not appear.</p> <ul style="list-style-type: none"> Please check and clean the air filter periodically, even if there is no message. If the air filter becomes to be blocked by dust or others, the internal temperature will rise, which could cause malfunction, or reduce the lifetime of the projector. It is recommended to choose “100h” in general. Please be careful with the operating environment of the projector and the condition of the air filter, especially when the “200h”, “300h” or “TURN OFF” is chosen. <p>KEY LOCK Using the buttons ▲/▼ turns on/off the key lock feature. When TURN ON is selected, the buttons on the projector except the STANDBY/ON button are locked. TURN ON ⇄ TURN OFF</p> <ul style="list-style-type: none"> Please use to avoid a mischief and touching accidentally. This function does not have any effect on the remote control.

OPTION Menu (continued)

Item	Description
SERVICE	<p>REMOTE FREQ. Use the ▲/▼ button to change the Projector's remote sensor setting (📖 16). 1:NORMAL ⇔ 2:HIGH</p> <p>Items with a checkmark are on. The factory default setting is for both 1:NORMAL and 2:HIGH to be on. If the remote control does not function correctly set the this to either only 1 or only 2 as described in Remote Control Settings (📖 16). Neither can be turned off at the same time.</p> <p>INFORMATION Selecting this item displays a dialog titled "INPUT INFORMATION". It shows the information about the current input.</p> <div style="display: flex; justify-content: space-around; align-items: flex-start;"> <div style="border: 1px solid black; padding: 5px; text-align: center; width: 30%;"> ◀ INPUT-INFORMATION RGB 1024x768 @60Hz FRAME LOCK </div> <div style="border: 1px solid black; padding: 5px; text-align: center; width: 30%;"> ◀ INPUT-INFORMATION S-VIDEO SECAM AUTO </div> <div style="border: 1px solid black; padding: 5px; text-align: center; width: 30%;"> ◀ INPUT-INFORMATION COMPONENT 576i @50 SCART RGB </div> </div> <ul style="list-style-type: none"> • The "FRAME LOCK" message on the dialog means the frame lock function is working. • The "SCART RGB" message means the COMPONENT VIDEO port is working as a SCART RGB input port. Please refer to the COMPONENT item in INPUT menu. (📖 33) • This item can't be selected for no signal and sync out. <p>FACTORY RESET Selecting RESET using the button ▲ performs this function. By this function, all the items in all of menus will collectively return to the initial setting. Note that the items LAMP TIME, FILTER TIME, LANGUAGE and OPTION_SECURITY are not reset. RESET ⇔ CANCEL</p>

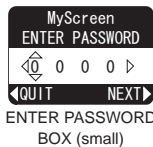
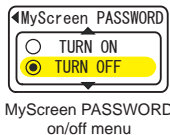
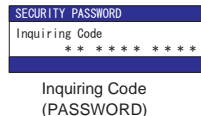
OPTION Menu (continued)

Item	Description
<p>SECURITY</p>	<p>This projector is equipped with security functions. User registration is required before using the security functions. Please contact your local dealer.</p> <p>1. Using Security Features</p> <p>1.1 Inputting the PASSWORD</p> <p>1.1-1 Use the ▲/▼ buttons on the OPTION menu to select SECURITY and press the ► button. The ENTER PASSWORD box will be displayed. The factory default PASSWORD is 3046. This PASSWORD can be changed (1.2 Changing the PASSWORD).</p> <div style="border: 1px solid black; padding: 5px; margin: 10px 0;"> <p>NOTE : It is strongly recommended the factory default PASSWORD to be changed as soon as possible.</p> </div> <p>1.1-2 Use the ▲/▼/◀/▶ buttons to enter the registered PASSWORD. Move the cursor to the right side of the ENTER PASSWORD BOX and press the ► button to display the SECURITY menu. If an incorrect PASSWORD is input the ENTER PASSWORD BOX will be displayed again. If incorrect PASSWORD is input 3 times the projector will turn off. Afterwards the projector will turn off every time an incorrect PASSWORD is input.</p> <p>1.2 Changing the PASSWORD</p> <p>1.2-1 Use the ▲/▼ buttons on the SECURITY menu to select SECURITY PASSWORD CHANGE and press the ► button to display the ENTER NEW PASSWORD BOX.</p> <p>1.2-2 Use the ▲/▼/◀/▶ buttons to enter the new PASSWORD.</p> <p>1.2-3 Move the cursor to the right side of the ENTER NEW PASSWORD BOX and press the ► button to display the NEW PASSWORD AGAIN BOX, enter the same PASSWORD again.</p> <p>1.2-4 Move the cursor to the right side of the NEW PASSWORD AGAIN BOX and press the ► button and the NOTE NEW PASSWORD BOX will be displayed for about 20 seconds, please make note of the PASSWORD during this time. Pressing the ENTER button on the remote controll or INPUT button on the projector will close the NOTE NEW PASSWORD BOX.</p> <div style="border: 1px solid black; padding: 5px; margin: 10px 0;"> <p>NOTE : Please do not forget your PASSWORD.</p> </div>



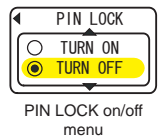
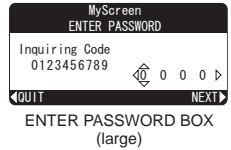
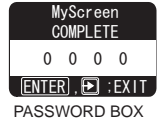
OPTION Menu (continued)

Item	Description
<p style="text-align: center;">SECURITY</p>	<p>1.3 If you have forgotten your PASSWORD</p> <p>1.3-1 Follow the procedure in 1.1-1 to display the ENTER PASSWORD BOX.</p> <p>1.3-2 While the ENTER PASSWORD BOX is displayed, press and hold the RESET button on the remote control for about 3 seconds or press and hold the INPUT and ► buttons on the projector for about 3 seconds. The 10 digit Inquiring Code will be displayed. NOTE: If there is no key input for about 55 seconds while the Inquiring Code is displayed the menu will close. If necessary repeat the process from 1.3-1.</p> <p>1.3-3 Contact your dealer with the 10 digit Inquiring Code. Your PASSWORD will be sent after your user registration information is confirmed.</p>
	<p>2. Using the MyScreen PASSWORD Function</p> <p>The MyScreen PASSWORD function can be used to prohibit access to the MyScreen function and prevent the currently registered MyScreen image from being overwritten.</p> <p>2.1 Turning on the MyScreen PASSWORD Function</p> <p>2.1-1 Use the ▲/▼ buttons on the SECURITY menu to select MyScreen PASSWORD and press the ► button to display the MyScreen PASSWORD on/off menu.</p>
	<p>2.2 Setting the PASSWORD</p> <p>2.2-1 Display the MyScreen on/off menu using the procedure in 2.1-1.</p> <p>2.2-2 Use the ▲/▼ buttons on the MyScreen PASSWORD on/off menu to select TURN ON. The ENTER PASSWORD BOX (small) will be displayed.</p> <p>2.2-3 Use the ▲/▼/◀/▶ buttons to enter the PASSWORD. Move the cursor to the right side of the ENTER PASSWORD BOX (small) and press the ► button to display the CHECK PASSWORD BOX, enter the same PASSWORD again.</p>

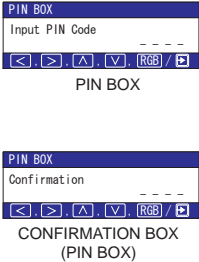


OPTION Menu (continued)

Item	Description
<p style="text-align: center;">SECURITY</p>	<p>2.2-4 Move the cursor to the right side of the CHECK PASSWORD BOX and press the ► button to display the PASSWORD for about 20 seconds, please make note of the PASSWORD during this time. After the PASSWORD has displayed for about 20 seconds the screen will return to the MyScreen PASSWORD on/off menu.</p> <p>Pressing the ENTER button on the remote control or INPUT button on the projector will close the PASSWORD box.</p> <p>When a PASSWORD is set for MyScreen:</p> <ul style="list-style-type: none"> • The MyScreen registration function (and menu) will be unavailable. • The START UP setting will be locked on MyScreen (and the menu will be unavailable). <p>Turning the MyScreen PASSWORD off will allow normal operation of both functions.</p> <div style="border: 1px solid black; padding: 2px; display: inline-block;"> <p>NOTE : Please do not forget your MyScreen PASSWORD.</p> </div>
	<p>2.3 Turning the PASSWORD off</p> <p>2.3-1 Follow the procedure in 2.1-1 to display the MyScreen PASSWORD on/off menu.</p> <p>2.3-2 Select TURN OFF to display the ENTER PASSWORD BOX (large). Enter the registered PASSWORD and the screen will return to the MyScreen on/off menu.</p> <p>If an incorrect PASSWORD is input the menu will close. If necessary repeat the process from 2.3-1.</p>
	<p>2.4 If you have forgotten your PASSWORD</p> <p>2.4-1 Follow the procedure in 2.1-1 to display the MyScreen PASSWORD on/off menu.</p> <p>2.4-2 Select TURN OFF to display the ENTER PASSWORD BOX (large). The 10 digit Inquiring Code will be displayed inside the BOX.</p> <p>2.4-3 Contact your dealer with the 10 digit Inquiring Code. Your PASSWORD will be sent after your user registration information is confirmed.</p>
	<p>3. Using the PIN LOCK Function</p> <p>PIN LOCK is a function which prevents the projector from being used unless a registered Code is input.</p> <p>3.1 Registering the PIN Code</p> <p>3.1-1 Use the ▲/▼ buttons on the SECURITY menu to select PIN LOCK and press the ► button or the ENTER button to display the PIN LOCK on/off menu.</p> <p>3.1-2 Use the ▲/▼ buttons on the PIN LOCK on/off menu to select TURN ON and the PIN BOX will be displayed.</p>




OPTION Menu (continued)

Item	Description
<p>SECURITY</p>	<p>3.1-3 Input a 4 part PIN Code using the ▲/▼/◀/▶ /RGB and INPUT buttons. A CONFIRMATION BOX will appear. Reenter the same PIN Code. This will complete the PIN Code registration.</p> <p>NOTE: If there is no key input for about 55 seconds while the PIN BOX or the CONFIRMATION BOX are displayed the menu will close. If necessary repeat the process from 3.1-1.</p> <p>Afterwards, anytime the projector is restarted after the power switch is turned off the PIN BOX will be displayed. Enter the registered PIN Code. The projector can be used after entering the registered PIN Code. If an incorrect PIN Code is input the PIN BOX will be displayed again. If an incorrect PIN Code is input 3 times the projector will turn off. Afterwards the projector will turn off every time an incorrect PIN Code is input. The projector will also turn off if there is no key input for about 5 minutes while the PIN BOX is displayed. This function will activate only when the projector is started after the power switch was turned off.</p> <div style="border: 1px solid black; padding: 2px; display: inline-block;"> <p>NOTE : Please do not forget your PIN Code.</p> </div> <p>3.2 Turning Off the PIN LOCK Function</p> <p>3.2-1 Follow the procedure in 3.1-1 to display the PIN LOCK on/off menu. Use the ▲/▼ buttons to select TURN OFF and the PIN BOX will be displayed. Enter the registered PIN Code to turn the PIN LOCK function off. If an incorrect PASSWORD is entered the menu will close.</p> <p>3.3 If you have forgotten your PIN Code</p> <p>3.3-1 While the PIN BOX is displayed, press and hold the RESET button for three seconds or press and hold the INPUT and ► buttons for three seconds. The 10 digit Inquiring Code will be displayed.</p> <p>NOTE: If there is no key input for about 5 minutes while the Inquiring Code is displayed the projector will turn off.</p> <p>3.3-2 Contact your dealer with the 10 digit Inquiring Code. Your PASSWORD will be sent after your user registration information is confirmed.</p>
	<div style="display: flex; justify-content: space-between;"> <div data-bbox="311 212 800 715"> <p>3.1-3 Input a 4 part PIN Code using the ▲/▼/◀/▶ /RGB and INPUT buttons. A CONFIRMATION BOX will appear. Reenter the same PIN Code. This will complete the PIN Code registration.</p> <p>NOTE: If there is no key input for about 55 seconds while the PIN BOX or the CONFIRMATION BOX are displayed the menu will close. If necessary repeat the process from 3.1-1.</p> <p>Afterwards, anytime the projector is restarted after the power switch is turned off the PIN BOX will be displayed. Enter the registered PIN Code. The projector can be used after entering the registered PIN Code. If an incorrect PIN Code is input the PIN BOX will be displayed again. If an incorrect PIN Code is input 3 times the projector will turn off. Afterwards the projector will turn off every time an incorrect PIN Code is input. The projector will also turn off if there is no key input for about 5 minutes while the PIN BOX is displayed. This function will activate only when the projector is started after the power switch was turned off.</p> </div> <div data-bbox="829 240 1028 502">  <p>The image shows two screenshots of the projector's menu. The first is labeled 'PIN BOX' and shows 'Input PIN Code' with four dashes and navigation buttons. The second is labeled 'CONFIRMATION BOX (PIN BOX)' and shows 'Confirmation' with four dashes and navigation buttons.</p> </div> </div>

OPTION Menu (continued)

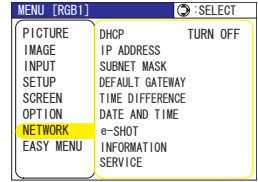
Item	Description
<p>SECURITY</p>	<p>4. Using the Transition Detector Function</p> <p>While the Transition Detector function is ON, when power switch is started to supply to the projector, it might react as below.</p> <ul style="list-style-type: none"> • Transition Detector alarm shown below might appear on screen, if the projector has been moved or re-installed. • Transition Detector alarm might appear on screen, if the MIRROR setting has been changed. • Keystone adjustment feature has been prohibited as long as the Transition Detector function is ON. <p>4.1 Turning On the Transition Detector Function</p> <p>4.1-1 Use the ▲/▼ buttons on the SECURITY menu to select Transition Detector and press the ► or the ENTER button to display the Transition Detector on/off menu. Select TURN ON and the current angle and mirror setting will be recorded.</p> <div data-bbox="848 491 1001 580" style="border: 1px solid black; padding: 5px; margin: 10px 0;"> <p>Transition Detector</p> <p>○ TURN ON</p> <p>● TURN OFF</p> </div> <p style="text-align: center; margin: 5px 0;">Transition Detector on/off menu</p> <p>NOTE: This feature may not function properly if the projector is not in a stable position when TURN ON is selected.</p> <p>4.1-2 If this function is set to TURN ON when the vertical angle of the projector or mirror setting at which the projector is turned on is different than the previously recorded the Transition Detector Alarm will be displayed and the projector will not display the input signal.</p> <div data-bbox="837 644 1031 756" style="border: 1px solid black; padding: 5px; margin: 10px 0;"> <p style="text-align: center;"><<TRANSITION DETECTOR ON>></p> <p style="font-size: small;">The projector has been transferred from previously installed position.</p> <p style="font-size: x-small;">If you wish to have a square image on screen again, disable Transition Detector on Menu.</p> </div> <p style="text-align: center; margin: 5px 0;">Transition Detector Alarm</p> <p>Set the Transition Detector off in the SECURITY menu or set the projector at the recorded angle to display the input signal.</p> <p>If the Transition Detector ALARM is displayed for about 5 minutes the lamp will turn off. This function will activate only when the projector is started after the power switch was turned off.</p> <p>4.2 Setting the Transition Detector PASSWORD</p> <p>4.2-1 Use the ▲/▼ buttons on the SECURITY menu to select Transition Detector and press the ► or the ENTER button to display the Transition Detector on/off menu.</p> <p>4.2-2 Use the ▲/▼ buttons on the Transition Detector on/off menu to select TURN ON. The ENTER PASSWORD BOX (small) will be displayed.</p> <div data-bbox="860 1018 1012 1155" style="border: 1px solid black; padding: 5px; margin: 10px 0;"> <p style="text-align: center;">Transition Detector</p> <p style="text-align: center;">ENTER PASSWORD</p> <p style="text-align: center;">◀ 0 0 0 ▶</p> <p style="text-align: center;">◀QUIT NEXT▶</p> <p style="text-align: center;">ENTER PASSWORD BOX (small)</p> </div> <p>4.2-3 Use the ▲/▼/◀/▶ buttons to enter a PASSWORD. Move the cursor to the right side of the ENTER PASSWORD BOX (small) and press the ► button to display the CHECK PASSWORD BOX, enter the same PASSWORD again.</p> <div data-bbox="860 1161 1012 1299" style="border: 1px solid black; padding: 5px; margin: 10px 0;"> <p style="text-align: center;">Transition Detector</p> <p style="text-align: center;">CHECK PASSWORD</p> <p style="text-align: center;">◀ 0 0 0 ▶</p> <p style="text-align: center;">◀QUIT NEXT▶</p> <p style="text-align: center;">CHECK PASSWORD BOX</p> </div> <p>4.2-4 Move the cursor to the right side of the CHECK PASSWORD BOX and press the ► button to display the PASSWORD for about 20 seconds, please make note of the PASSWORD during this time. After the PASSWORD has displayed for about 20 seconds the screen will return to the Transition Detector on/off menu.</p> <div data-bbox="860 1305 1012 1417" style="border: 1px solid black; padding: 5px; margin: 10px 0;"> <p style="text-align: center;">Transition Detector</p> <p style="text-align: center;">COMPLETE</p> <p style="text-align: center;">0 0 0 0</p> <p style="text-align: center;">[ENTER] [EXIT] :EXIT</p> <p style="text-align: center;">PASSWORD BOX</p> </div> <p>Pressing the ENTER button on the remote control or the INPUT button on the projector will close the PASSWORD BOX.</p> <div data-bbox="311 1458 965 1490" style="border: 1px solid black; padding: 5px; margin-top: 10px;"> <p>NOTE : Please do not forget your Transition Detector PASSWORD.</p> </div>

OPTION Menu (continued)

Item	Description
SECURITY	4.3 Setting the Transition Detector off
	4.3-1 Follow the procedure in 4.1-1 to display the Transition Detector on/off menu.
	4.3-2 Select TURN OFF to display the ENTER PASSWORD BOX (large). Enter the registered PASSWORD and the screen will return to the Transition Detector on/off menu. If an incorrect PASSWORD is input the menu will close. If necessary repeat the process from 4.3-1.
	4.4 If you have forgotten your PASSWORD
4.4-1 Follow the procedure in 4.1-1 to display the Transition Detector on/off menu.	
4.4-2 Select TURN OFF to display the ENTER PASSWORD BOX (large). The 10 digit Inquiring Code will be displayed inside the BOX.	
4.4-3 Contact your dealer with the 10 digit Inquiring Code. Your PASSWORD will be sent after your user registration information is confirmed.	

NETWORK Menu


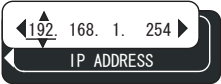
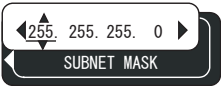
Select **[Network]** from the main menu to access the following functions.



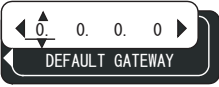
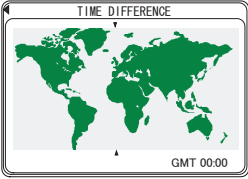
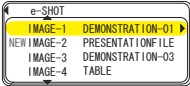
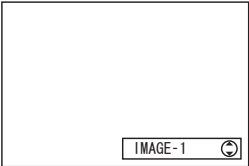

NOTE

- The factory default setting for DHCP is “TURN ON”. You do not have to set up [DHCP], [IP ADDRESS], [SUBNET MASK] or [DEFAULT GATEWAY] if your network has DHCP enabled. (**📖 User’s Manual - Network Functions**)
- If you are not utilizing Sntp (**📖 User’s Manual - Network Functions**), then you must set the DATE AND TIME during the initial installation. Please refer to the item DATE AND TIME on the following list.

NOTE Ask with your network administrator before connecting to an existing access point on your network. Incorrect network settings on this projector may cause unnecessary troubles on the network.

Item	Operation
<p>DHCP (Dynamic Host Configuration Protocol)</p>	<p>DHCP TURN ON/TURN OFF: Use the ▲/▼ buttons to turn DHCP on/off TURN ON ⇔ TURN OFF</p>  <p>Select TURN OFF when the network does not have DHCP enabled.</p>
<p>IP ADDRESS</p>	<p>Input the IP ADDRESS : Use the ▲/▼/◀/▶ buttons to enter the IP ADDRESS. This function can only be used when DHCP is set to “TURN OFF”.</p>  <p>-Note- IP ADDRESS is a number which identifies this projector on the network. You cannot have two devices with the same IP ADDRESS on the same network.</p>
<p>SUBNET MASK</p>	<p>Input the SUBNET MASK : Use the buttons ▲/▼/◀/▶ to enter the same SUBNET MASK of your PC. This function is available as long as DHCP is set to “TURN OFF”.</p> 

NETWORK Menu (continued)

Item	Operation
<p>DEFAULT GATEWAY</p>	<p>Input the DEFAULT GATEWAY : Use the ▲/▼/◀/▶ buttons to enter the DEFAULT GATEWAY (a node on a computer network that serves as an access point to another network) address. This function is available as long as DHCP is set to "TURN OFF".</p> 
<p>TIME DIFFERENCE</p>	<p>Input the TIME DIFFERENCE : Use the ▲/▼ buttons to enter the TIME DIFFERENCE. Set the same TIME DIFFERENCE as that on your PC. If unsure, ask your network administrator. Use the ◀ button to return to the menu after setting the TIME DIFFERENCE.</p> 
<p>DATE AND TIME</p>	<p>Input DATE AND TIME : Use the ▲/▼/◀/▶ buttons to enter the Year (last two digits), Month, Date, Hour and Minute. ~Note~ The projector will override this setting and retrieve DATE AND TIME information from the Timeserver when SNTP is enabled. See [Date/Time Settings] in [User's Manual - Network Functions: Configuring and Controlling the Projector via a Web Browser] for SNTP settings.</p>
<p>e-SHOT</p>	<p>e-SHOT display : Use the ▲/▼ buttons to select an item and the ▶ or ENTER buttons to display the image.</p> <p>Image1 Image2 Image3 Image4</p>  <p>File names of registered images are displayed by 16 characters or less. Example: DEMONSTRATION-01 "NEW" stamp is added to the head of line when the image is registered newly. After the image is displayed, "NEW" stamp will be erased.</p> <p>Once an image is displayed, you can use the ▲/▼ buttons to page through the images. Use the ◀ or ESC buttons to return to the menu.</p> <p>Pressing the RESET button on the remote control while an image is being displayed will display the RESET menu. The displayed image can be deleted from the RESET menu using the ENTER button on the remote control or the INPUT button on the projector.</p> <p>If you do not wish to delete the image use the ESC button on the remote control or push the ◀ and INPUT buttons on the projector at the same time.</p> <p>~Note~</p> <ul style="list-style-type: none"> • Items with no image stored cannot be selected. • Images can be changed using the ▲/▼ buttons while the image data downloads.  

NETWORK Menu (continued)

Item	Operation														
<p>INFORMATION</p>	<p>INFORMATION display : Use the ► or ENTER buttons to view network information and confirm settings.</p> <div data-bbox="773 245 1021 392" style="border: 1px solid black; padding: 5px; margin: 10px 0;"> <p>◀ NETWORK-INFORMATION</p> <table border="0"> <tr><td>NAME</td><td></td></tr> <tr><td>IP ADDRESS</td><td>192.168.1.254</td></tr> <tr><td>SUBNETMASK</td><td>255.255.255.0</td></tr> <tr><td>DEFAULT GATEWAY</td><td>0.0.0.0</td></tr> <tr><td>MAC ADDRESS</td><td>00:00:87:56:AC:7C</td></tr> <tr><td>TIME DIFFERENCE</td><td>GMT 00:00</td></tr> <tr><td>DATE AND TIME</td><td>2000/1/1 8:15</td></tr> </table> </div> <p>~Note~</p> <ul style="list-style-type: none"> • Only the first 16 characters of the projector name are displayed. • When the voltage level of battery for built in clock decreases, set time may become incorrect even though accurate date and time are input. <p>Replace a battery through the following the instructions. (P.57)</p>	NAME		IP ADDRESS	192.168.1.254	SUBNETMASK	255.255.255.0	DEFAULT GATEWAY	0.0.0.0	MAC ADDRESS	00:00:87:56:AC:7C	TIME DIFFERENCE	GMT 00:00	DATE AND TIME	2000/1/1 8:15
NAME															
IP ADDRESS	192.168.1.254														
SUBNETMASK	255.255.255.0														
DEFAULT GATEWAY	0.0.0.0														
MAC ADDRESS	00:00:87:56:AC:7C														
TIME DIFFERENCE	GMT 00:00														
DATE AND TIME	2000/1/1 8:15														
<p>SERVICE</p>	<p>Excuting this item restarts and initializes the Network Function. Choose the RESTART using the button ►.</p> <div data-bbox="555 651 729 730" style="border: 1px solid black; padding: 5px; margin: 10px 0;"> <p>◀ SERVICE RESTART ►</p> </div> <p>Then use the button ▲ to execute.</p> <div data-bbox="549 783 734 895" style="border: 1px solid black; padding: 5px; margin: 10px 0;"> <p>◀ RESTART EXECUTE CANCEL ►</p> </div> <p>Network will be once cut off when choose restart. If DHCP is selected on, IP address may be changed. After selecting RESTART, Network menu may not be controlled approx. 30 seconds.</p>														

Network Functions

Refer to the separate volume on Network Functions.

Maintenance

Lamp

**WARNING**

HIGH VOLTAGE



HIGH TEMPERATURE



HIGH PRESSURE

► The projector uses a high-pressure mercury glass lamp. The lamp can break with a loud bang, or burn out, if jolted or scratched, handled while hot, or worn over time. Note that each lamp has a different lifetime, and some may burst or burn out soon after you start using them. In addition, when the bulb bursts, it is possible for shards of glass to fly into the lamp housing, and for gas containing mercury to escape from the projector's vent holes.

► **About disposal of a lamp** • This product contains a mercury lamp; do not put it in a trash. Dispose of it in accordance with environmental laws. For lamp recycling, go to www.lamprecycle.org. (in the US) For product disposal, contact your local government agency or www.eiae.org (in the US) or www.epsc.ca (in Canada). For more information, call your dealer.



Disconnect the plug from the power outlet

- If the lamp should break (it will make a loud bang when it does), unplug the power cord from the outlet, and make sure to request a replacement lamp from your local dealer. Note that shards of glass could damage the inside of the projector, or cause injury during handling, so please do not try to clean the projector or replace the lamp yourself.

- If the lamp should break (it will make a loud bang when it does), ventilate the room well, and make sure not to breathe the gas that comes out of the projector vents, or get it in your eyes or mouth.

- Before replacing the lamp, turn the projector off and unplug the power cord, then wait at least 45 minutes for the lamp to cool sufficiently. Handling the lamp while hot can cause burns, as well as damaging the lamp.



- Never unscrew except the appointed (marked by an arrow) screws.
- Do not open the lamp cover while the projector is suspended from the ceiling. This is dangerous, since if the lamp's bulb has broken, the shards will fall out when the cover is opened. In addition, working in high places is dangerous, so ask your local dealer to have the lamp replaced even if the bulb is not broken.

- Do not use the projector with the lamp cover removed. To replace the lamp, make sure that the screws are tightened firmly. Loose screws could result in damage or injury.



- Use only the lamp of the specified type.
- If the lamp breaks soon after the first time it is used, it is possible that there are electrical problems elsewhere besides the lamp. If this happens, contact your local dealer or a service representative.

- Handle with care: jolting or scratching could cause the lamp bulb to burst during use.
- Using the lamp for long periods of time, could cause it dark, not to light up or to burst. When the pictures appear dark, or when the color tone is poor, please replace the lamp as soon as possible. Do not use old (used) lamps; this is a cause of breakage.

Lamp (continued)

A lamp has a finite product life. Using the lamp for long periods of time could cause the pictures darker or the color tone poor. Note that each lamp has a different lifetime, and some may burst or burn out soon after you start using them. Preparation of a new lamp and early replacement are recommended.

To prepare a new lamp, contact your dealer and tell the lamp type number.

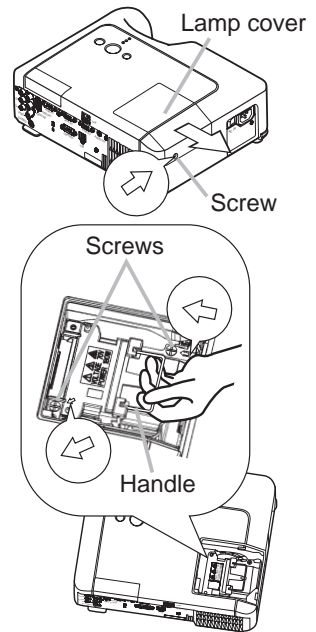
Type number = < CP-X256 > DT00757, < CP-X265 > DT00751

1. Turn the projector off, and unplug the power cord. Allow the lamp to cool for at least 45 minutes.
2. Prepare a new lamp.
 - If the projector is mounted on the ceiling, or if the lamp has broken, also ask the dealer to replace the lamp.

In the case of replacement by yourself,

3. Loosen the lamp cover screw (marked by arrow) and then slide the lamp cover to the side to remove it.
4. Loosen the 2 screws (marked by arrow) of the lamp, and slowly pick up the lamp by the handles.
5. Insert the new lamp, and retighten firmly the two screws that are loosened in the previous process to lock it in place.
6. Slide the lamp cover back in place and firmly fasten the lamp cover a screw.
7. Turn the projector on and reset the lamp time using the LAMP TIME function in the OPTION menu (41).

- (1) Press the MENU button to display a menu. Only when the EASY MENU has appeared, please perform the next step (2).
- (2) Point at the "Go to Advanced Menu ..." in the menu using ▼/▲ button, then press the ► button.
- (3) Point at the "OPTION" in the left column of the menu using ▼/▲ button, then press the ► button.
- (4) Point at the "LAMP TIME" using ▼/▲ button, then press the ► button. A dialog will appear.
- (5) Press the ▲ button to select "RESET" on the dialog. It performs resetting the lamp time.



NOTE • Please reset the lamp time only when you have replaced the lamp, for a suitable indication about the lamp.

Air filter

⚠ WARNING ▶ Before caring, make sure the power switch is off and the power cable is not plugged in, then allow the projector to cool sufficiently. The care in a high temperature state of the projector could cause an electric shock, a burn and/or malfunction to the projector.

▶ Use only the air filter of the specified type. Do not use the projector with the air filter and the filter cover removed. It could result in a fire and/or malfunction to the projector.

▶ The air filter should be cleaned periodically. If the air filter becomes clogged by dust or the like, internal temperatures rise and could cause a fire, a burn and/or malfunction to the projector.

NOTE • Please replace the air filter when it is damaged or too soiled, and also when you replace the lamp.

• Please reset the filter time only when you have cleaned or replaced the air filter, for a suitable indication about the air filter. (41)

• The projector may display the message such as “CHECK THE AIR FLOW” or turn off the projector, to prevent the internal heat level rising.

If the air filter becomes clogged by dust or the like, internal temperatures rise and could cause a fire, a burn and/or malfunction to the projector. When the indicators or a message prompts you to clean the air filter, clean the air filter as soon as possible.

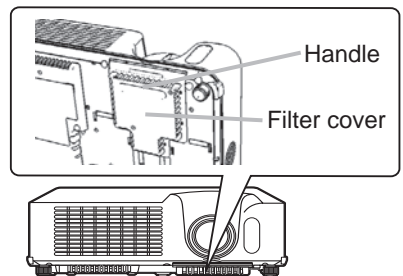
Please check and clean the air filter periodically, even if there is no message. Please replace the air filter when it is damaged or too soiled. Preparation of a new air filter is recommended.

To prepare a new air filter, contact your dealer and tell the air filter type number.

Type number = NJ22222

And also when you replace the lamp, please replace the air filter. An air filter of specified type will come together with a replacement lamp for this projector.

1. Turn the projector off, and unplug the power cord. Allow the lamp to cool for at least 45 minutes.
2. When the projector is suspended from the ceiling, apply the vacuum cleaner to and around the filter cover first, to prevent penetration of dust or the like.
3. While supporting the projector with one hand, use your other hand to pull the filter cover forward in the direction of the arrow. Remove the air filter.



Air filter (continued)

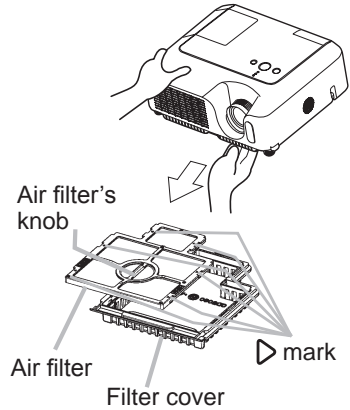
4. Apply a vacuum cleaner to the air filter and the filter cover. Please replace the air filter when it is damaged or too soiled.

5. Replace the air filter in its original position. Secure the air filter in place by pressing each of the six ▶ locations. Make sure there is no dust or dirt remaining after the cover is in place. If any dust or dirt remains use a vacuum cleaner to remove it as when placing the filter cover on the air filter.

Reattach the filter cover to the projector by aligning the filter cover with the grooves on the projector. While holding the handle, push down on the filter cover until it locks firmly in place.

6. Turn the projector on and reset the filter time using the FILTER TIME function in the OPTION menu (41).

- (1) Press the MENU button to display a menu. When the EASY MENU has appeared, please skip the next step (2).
- (2) Point at the "OPTION" in the left column of the menu using ▼/▲ button, then press the ▶ button.
- (3) Point at the "FILTER TIME" using ▼/▲ button, then press the ▶ button. A dialog will appear.
- (4) Press the ▲ button to select "RESET" on the dialog. It performs resetting the filter time.



Replacing Internal Clock battery

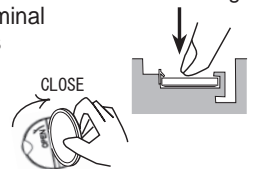
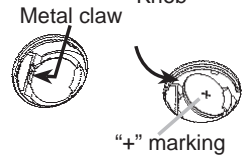
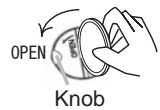
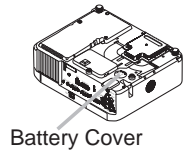
Consumption of the battery makes the clock not to work correctly. When the clock is wrong or it has stopped, please replace the battery according to the following procedures.

⚠WARNING ▶ Always handle the batteries with care and use them only as directed. Battery may explode if mistreated. Do not recharge, disassemble or dispose of in fire.

And also improper use may result in cracking or leakage, which could result in fire, injury and/or pollution of the surrounding environment.

- Be sure to use only the batteries specified. Do not use batteries of different types at the same time. Do not mix a new battery with used one.
- Make sure the plus and minus terminals are correctly aligned when loading a battery. If the battery is placed in the battery holder upside-down, it may be hard to remove.
- Keep a battery away from children and pets. If swallowed consult a physician immediately for emergency treatment.
- Do not short circuit or solder a battery.
- Do not allow a battery in a fire or water. Keep batteries in a dark, cool and dry place.
- If you observe a leakage of a battery, wipe out the flower and then replace a battery. If the liquid adheres to your body or clothes, rinse well with water immediately.
- Obey the local laws on disposing the battery.

1. Turn the projector off, and unplug the power cord. Allow the projector to cool sufficiently.
2. After making sure that the projector has cooled adequately, slowly turn over the projector, so that the bottom is facing.
3. Remove the battery cover. Turn the battery cover in the direction indicated "OPEN" using such as coins. Then the battery cover will come up. While removing the battery cover, pick its knob.
4. Take the old battery out. Press the metal claw of the battery holder. Then the battery will come up. Remove the battery.
5. Put a new battery in. **Replace battery with HITACHI MAXELL, Part No.CR2032 only. Use of another battery may present a risk of fire or explosion.** Insert a new battery in the battery holder according to its minus terminal \ominus as indicated in the battery holder, so that the side marked by + is facing. And push the battery into the battery holder fully to fix.
6. Close the battery cover. Replace the battery cover in place, then turn it in the direction indicated "CLOSE" using such as coins, to fix.



If the battery is placed in the battery holder upside-down, follow the procedure below to remove and reload it properly.

1. Remove the battery cover as described in steps 1 through 3 above.
2. Turn the projector over again, so that the top of the projector is facing up.
3. While lifting the side of the projector closest to the lens, press the metal claw of the battery holder. The battery will fall out of the holder, so be careful not to lose it.
4. Turn the projector over once more, so that the bottom faces up, and reload the battery correctly.

NOTE • The internal clock's time will be reset when the battery is removed. Please reconfigure the time via the menu or a web browser after replacing the battery. (Please refer to [57](#) and User's Manual-Network Functions: Date/Time Settings for more information.)

Other care

⚠WARNING ▶ Before caring, make sure the power switch is off and the power cable is not plugged in, and then allow the projector to cool sufficiently. The care in a high temperature state of the projector could cause a burn and/or malfunction to the projector.

▶ Never try to care for the inside of the projector personally. Doing is so dangerous.

▶ Avoid wetting the projector or inserting liquids in the projector. It could result in a fire, an electric shock, and/or malfunction to the projector.

- Do not put a container containing water, cleaner or chemicals near the projector.
- Do not use aerosols or sprays.

⚠CAUTION ▶ Please take right care of the projector according to the following. Incorrect care could cause not only an injury but adverse influence such as discoloration, peeling paint, etc.

▶ Do not use cleaner or chemicals other than those listed below.

▶ Do not polish or wipe with hard objects.

Inside of the projector

In order to ensure the safe use of your projector, please have it cleaned and inspected by your dealer about once every year.

Caring for the lens

If the lens is flawed, soiled or fogged, it could cause deterioration of display quality. Please take care of the lens, being cautious of handling.

1. Turn the projector off, and unplug the power cord. Allow the projector to cool sufficiently.
2. After making sure that the projector is cool adequately, lightly wipe the lens with a commercially available lens-cleaning wipe. Do not touch the lens directly with your hand.

Caring for the cabinet and remote control

Incorrect care could have adverse influence such as discoloration, peeling paint, etc.

1. Turn the projector off, and unplug the power cord. Allow the projector to cool sufficiently.
2. After making sure that the projector is cool adequately, lightly wipe with gauze or a soft cloth.

If soiling is severe, dip soft cloth in water or a neutral cleaner diluted in water, and wipe lightly after wringing well. Then, wipe lightly with a soft, dry cloth.

Troubleshooting

Related messages

When the unit's power is on, messages such as those shown below may be displayed. When any such message is displayed on the screen, please follow the instructions described below. If the same message is displayed after the remedy, or if a message other than the following appears, please contact your dealer or service company.

Although these messages will be automatically disappeared around several minutes, it will be reappeared every time the power is turned on.

Message	Description
<p>NO INPUT IS DETECTED ***</p>	<p>There is no input signal. Please confirm the signal input connection, and the status of the signal source.</p>
<p>SYNC IS OUT OF RANGE *** [fH] **kHz [fV] **Hz</p>	<p>The horizontal or vertical frequency of the input signal is not within the specified range. Please confirm the specs for your projector or the signal source specs.</p>
<p>CHECK THE AIR FLOW</p>	<p>The internal temperature is rising. Please turn the power off, and allow the projector to cool down at least 20 minutes. After having confirmed the following items, please turn the power ON again.</p> <ul style="list-style-type: none"> • Is there blockage of the air passage aperture? • Is the air filter dirty? • Does the peripheral temperature exceed 35°C? <p>If the same indication is displayed after the remedy, please set FAN SPEED of the SERVICE item in the OPTION menu to HIGH.</p>
<p>REMINDER *** HRS PASSED AFTER THE LAST FILTER CHECK. FILTER MAINTENANCE IS ESSENTIAL. TO REMOVE WARNING MESSAGE, RESET FILTER TIMER. SEE MANUAL FURTHER INFO.</p>	<p>A note of precaution when cleaning the air filter. Please immediately turn the power off, and clean or change the air filter referring to the "Air Filter" section of this manual (45). After you have cleaned or changed the air filter, please be sure to reset the filter timer (47).</p>

Regarding the indicator lamps

Lighting and flashing of the POWER indicator, the LAMP indicator, and the TEMP indicator have the meanings as described in the table below. Please follow the instructions within the table. If the same indication is displayed after the remedy, or if an indication other than the following is displayed, please contact your dealer or service company.

POWER indicator	LAMP indicator	TEMP indicator	Description
Lighting In Orange	Turned off	Turned off	The projector is in a standby state. Please refer to the section "Power On/Off".
<i>Blinking</i> In Green	Turned off	Turned off	The projector is warming up. Please wait.
Lighting In Green	Turned off	Turned off	The projector is in an on state. Ordinary operations may be performed.
<i>Blinking</i> In Orange	Turned off	Turned off	The projector is cooling down. Please wait.
<i>Blinking</i> In Red	(discretionary)	(discretionary)	The projector is cooling down. A certain error has been detected. Please wait until the POWER indicator finishes blinking, and then perform the proper measure using the item descriptions below.
<i>Blinking</i> In Red or Lighting In Red	Lighting In Red	Turned off	The lamp does not light, and there is a possibility that interior portion has become heated. Please turn the power off, and allow the projector to cool down at least 20 minutes. After the projector has sufficiently cooled down, please make confirmation of the following items, and then turn the power on again. <ul style="list-style-type: none"> • Is there blockage of the air passage aperture? • Is the air filter dirty? • Does the peripheral temperature exceed 35°C? If the same indication is displayed after the remedy, please change the lamp referring to the section "Lamp".
<i>Blinking</i> In Red or Lighting In Red	<i>Blinking</i> In Red	Turned off	The lamp cover has not been properly fixed. Please turn the power off, and allow the projector to cool down at least 45 minutes. After the projector has sufficiently cooled down, please make confirmation of the attachment state of the lamp cover. After performing any needed maintenance, turn the power on again. If the same indication is displayed after the remedy, please contact your dealer or service company.

Regarding the indicator lamps (continued)

POWER indicator	LAMP indicator	TEMP indicator	Description
<i>Blinking In Red or Lighting In Red</i>	Turned off	<i>Blinking In Red</i>	<p>The cooling fan is not operating. Please turn the power off, and allow the projector to cool down at least 20 minutes. After the projector has sufficiently cooled down, please make confirmation that no foreign matter has become caught in the fan, etc., and then turn the power on again. If the same indication is displayed after the remedy, please contact your dealer or service company.</p>
<i>Blinking In Red or Lighting In Red</i>	Turned off	Lighting In Red	<p>There is a possibility that the interior portion has become heated. Please turn the power off, and allow the projector to cool down at least 20 minutes. After the projector has sufficiently cooled down, please make confirmation of the following items, and then turn the power on again.</p> <ul style="list-style-type: none"> • Is there blockage of the air passage aperture? • Is the air filter dirty? • Does the peripheral temperature exceed 35°C? <p>If the same indication is displayed after the remedy, please set FAN SPEED of the SERVICE item in the OPTION menu to HIGH.</p>
Lighting In Green	Simultaneous <i>blinking in Red</i>		<p>It is time to clean the air filter. Please immediately turn the power off, and clean or change the air filter referring to the section “Air Filter”. After cleaning or changing the air filter, please be sure to reset the filter timer. After the remedy, reset the power to ON.</p>
Lighting In Green	Alternative <i>blinking in Red</i>		<p>There is a possibility that the interior portion has become overcooled. Please use the unit within the usage temperature parameters (5°C to 35°C). After the treatment, reset the power to ON.</p>
<i>Blinking in Green for approx. 3 seconds</i>	Turned off	Turned off	<p>At least 1 “Power ON” schedule is saved to the projector. (Please refer to the User’s Manual-Network Functions: Schedule Settings for more information.)</p>

NOTE • When the interior portion has become overheated, for safety purposes, the power source is automatically turned off, and the indicator lamps may also be turned off. In such a case, press the “O” (OFF) side of the power switch, and wait at least 45 minutes. After the projector has sufficiently cooled down, please make confirmation of the attachment state of the lamp and lamp cover, and then turn the power on again.

Phenomena that may be easy to be mistaken for machine defects

⚠WARNING ▶ Never use the projector if abnormal operations such as smoke, strange odor, excessive sound, damaged casing or elements or cables, penetration of liquids or foreign matter, etc. should occur. In such cases, immediately turn off the power switch and then disconnect the power plug from the power outlet. After making sure that the smoke or odor has stopped, contact your dealer or service company.

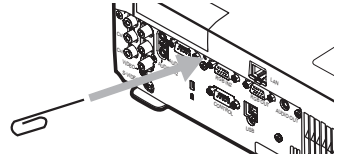
1. Before requesting repair, please check in accordance with the following chart. This operation sometimes resolves your problem.

If the situation cannot be corrected,

2. The projector's microprocessor may need to be reset. Please push the Restart switch by using a cocktail stick or similar and the projector will restart.

3. Some setting may be wrong. Please use the **FACTORY RESET** function of the **SERVICE** item in the **OPTION** menu (p.43) to reset all settings to factory default.

Then, if the problem is not removed after the remedy, please contact your dealer or service company.



Phenomenon	Cases not involving a machine defect	Reference page
Power does not come on.	The electrical power cord is not plugged in. Correctly connect the power cord.	14
	The power switch is not set to the on position. Set the power switch to [] (On).	17
	The main power source has been interrupted during operation such as by a power outage (blackout), etc. Please turn the power off, and allow the projector to cool down at least 2 minutes, then turn the power on again.	17
	Either there is no lamp and/or lamp cover, or either of these has not been properly fixed. Please turn the power off, and allow the projector to cool down at least 45 minutes. After the projector has sufficiently cooled down, please make confirmation of the attachment state of the lamp and lamp cover, and then turn the power on again.	53, 54
Neither sounds nor pictures are outputted.	The signal cables are not correctly connected. Correctly connect the connection cables.	12, 13
	Signal source does not correctly work. Correctly set up the signal source device by referring to the manual of the source device.	–
	The input changeover settings are mismatched. Select the input signal, and correct the settings.	18, 19

Phenomena that may be easy to be mistaken for machine defects (continued)

Phenomenon	Cases not involving a machine defect	Reference page
Sound does not come out.	<p>The signal cables are not correctly connected. Correctly connect the audio cables.</p>	12,13
	<p>The MUTE function is working. Restore the sound pressing the MUTE or VOLUME button on the remote control.</p>	18
	<p>The volume is adjusted to an extremely low level. Adjust the volume to a higher level using the menu function or the remote control.</p>	18
	<p>The AUDIO setting is not correct. Correctly set the AUDIO item in the SETUP menu.</p>	36
No pictures are displayed.	<p>The lens cap is attached. Remove the lens cover.</p>	17
	<p>The signal cables are not correctly connected. Correctly connect the connection cables.</p>	12, 13
	<p>The brightness is adjusted to an extremely low level. Adjust BRIGHTNESS to a higher level using the menu function or the remote control.</p>	25
	<p>The computer cannot detect the projector as a plug and play monitor. Make sure that the computer can detect a plug and play monitor using another plug and play monitor.</p>	11
	<p>The BLANK screen is displayed. Press the BLANK button on the remote control.</p>	22
Video screen display freezes.	<p>The FREEZE function is working. Press the FREEZE button to restore the screen to normal.</p>	22
Colors have a faded- out appearance, or Color tone is poor.	<p>Color settings are not correctly adjusted. Perform picture adjustments by changing the COLOR TEMP, COLOR, TINT and/or COLOR SPACE settings, using the menu functions.</p>	26, 28, 32
	<p>COLOR SPACE setting is not suitable. Change the COLOR SPACE setting to AUTO, RGB, SMPTE240, REC709 or REC601.</p>	32

Phenomena that may be easy to be mistaken for machine defects (continued)

Phenomenon	Cases not involving a machine defect	Reference page
Pictures appear dark.	<p>The brightness and/or contrast are adjusted to an extremely low level. Adjust BRIGHTNESS and/or CONTRAST settings to a higher level using the menu function.</p>	25, 26
	<p>The WHISPER function is working. Select NORMAL for the WHISPER item in the SETUP menu.</p>	26, 35
	<p>The lamp is approaching the end of its product lifetime. Replace the lamp.</p>	53, 54
Pictures appear blurry.	<p>Either the focus and/or horizontal phase settings are not properly adjusted. Adjust the focus using the focus ring, and/or H PHASE using the menu function.</p>	19, 30
	<p>The lens is dirty or misty. Clean the lens referring to the section "Caring for the lens".</p>	58

NOTE • Although bright spots or dark spots may appear on the screen, this is a unique characteristic of liquid crystal displays, and it does not constitute or imply a machine defect.

Warranty and after-service

If a problem occurs with the equipment, first refer to the “Troubleshooting” and run through the suggested checks. If this does not resolve the problem, please contact your dealer or service company. They will tell you what warranty condition is applied.

Specifications

Specifications

NOTE • These specifications are subject to change without notice.

Item		Specification
Product name		Liquid crystal projector
Liquid Crystal panel	Panel size	1.6 cm (0.63 type)
	Drive system	TFT active matrix
	Pixels	786,432 pixels (1024 horizontal x 768 vertical)
Lens		Zoom lens F=1.7 ~ 1.9 f=18.9 ~ 22.6 mm
Lamp		200W UHB
Speaker		1W x 1
Power Supply		AC100-120V/3.5A, AC220-240V/1.5A
Power Consumption		330W
Temperature range		5 ~ 35°C (Operating)
Size		306 (W) x 106 (H) x 249 (D) mm (Not including protruding parts) • Please refer to the following figure.
Weight (mass)		3.3 kg
Ports		RGB input: RGB IN1 ..D-sub 15pin mini x1 RGB IN2 ..D-sub 15pin mini x1 RGB output: RGB OUT ..D-sub 15pin mini x1 Audio input: AUDIO 1Stereo mini x1 AUDIO 2Stereo mini x1 AUDIO 3 RCA x2 Audio output: AUDIO OUTStereo mini x1 Video input: COMPONENT VIDEO (Y, CB/PB, CR/PR)..... RCA x3 S-Video Mini DIN x1 Video RCA x1 Communication port: CONTROL..... D-sub 9pin x1 USBUSB(B) x1 LAN RJ-45 x1
Optional parts	Lamp	CP-X256 : DT00757 CP-X265 : DT00751
	Air filter	NJ22222
	Others	• Please consult your dealer.

