

DRAWN BY:  
G. ROBINSON

CHECKED BY:  
D. WEAVER

# KITSAP LIVE STEAMERS

## STEEL OFFSET CUPOLA CABOOSE SIDE ELEVATION

SIZE

FSCM NO.

DWG NO.

KLS01

REV

SCALE NONE

SHEET 1 OF 8

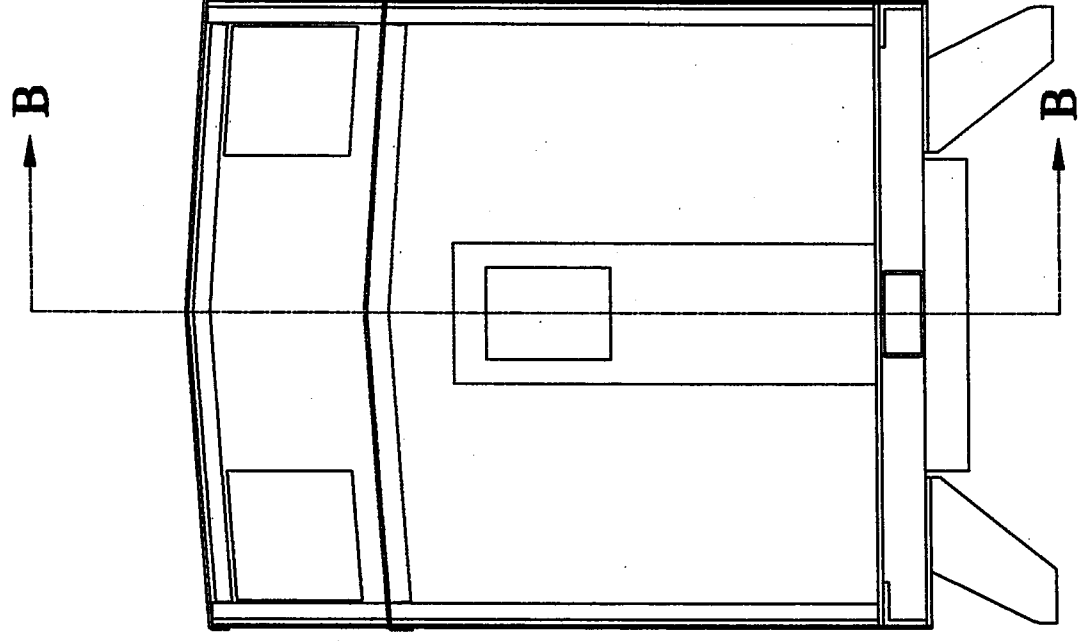
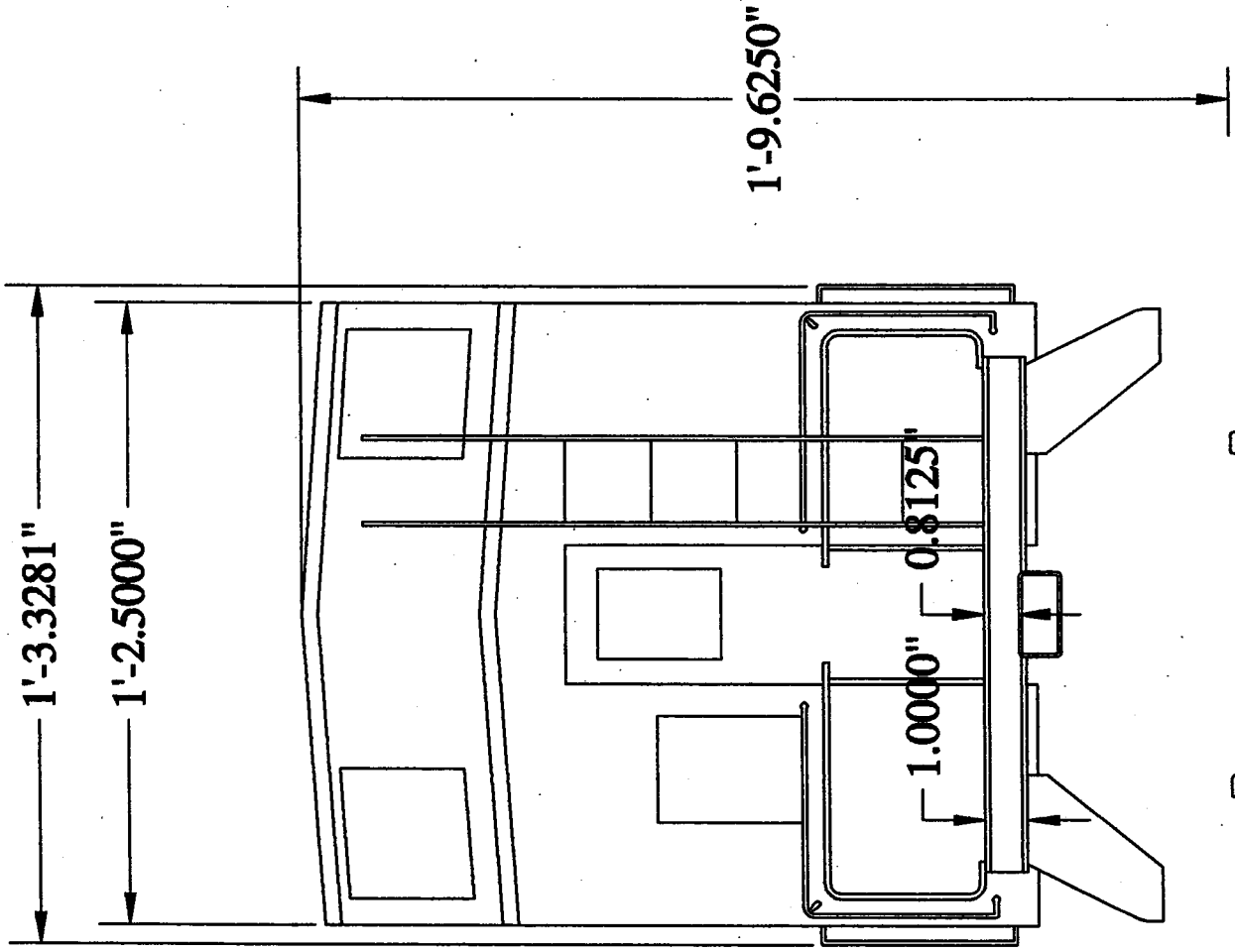

SECTION A-A

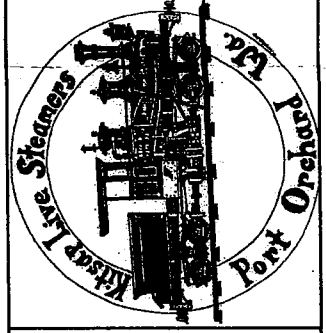

DRAWN BY:  
G. ROBINSON

CHECKED BY:  
D. WEAVER

# KITSAP LIVE STEAMERS

STEEL OFFSET CUPOLA CABOOSE  
END VIEW AND SECTION A-A

SIZE	FSCM NO.	DWG NO.	REV
		<b>KLS02</b>	
SCALE NONE		SHEET	2 OF 8

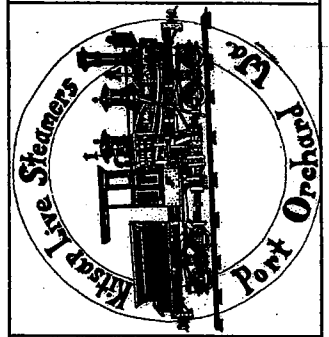
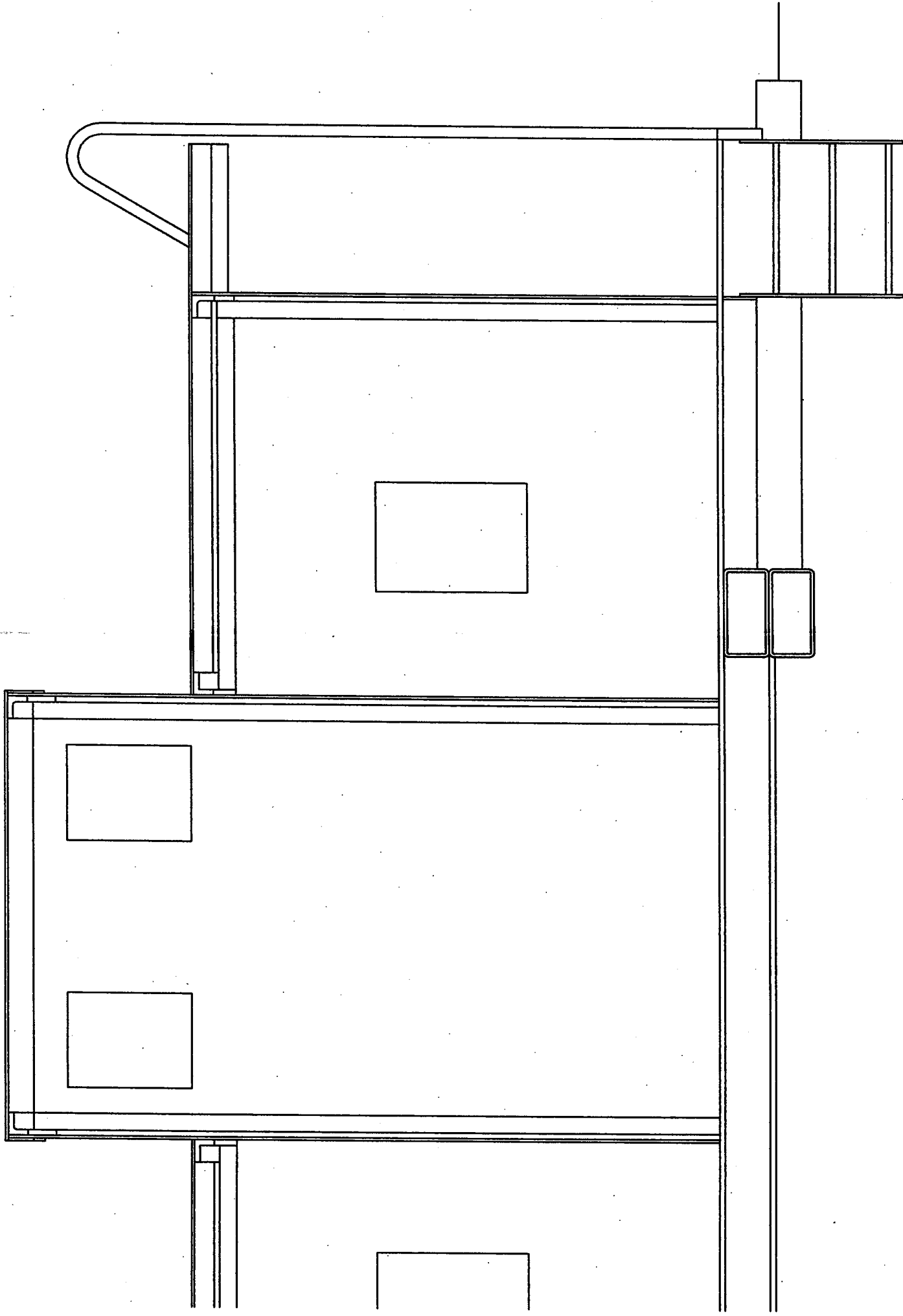

# KITSAP LIVE STEAMERS

## STEEL OFFSET CUPOLA CABOOSE SECTION B-B

**DRAWN BY:**  
G. ROBINSON

**CHECKED BY:**  
D. WEAVER

SIZE FSCM NO.

DWG NO. **KLS03**

REV

SCALE **NONE**

SHEET **3 OF 8**

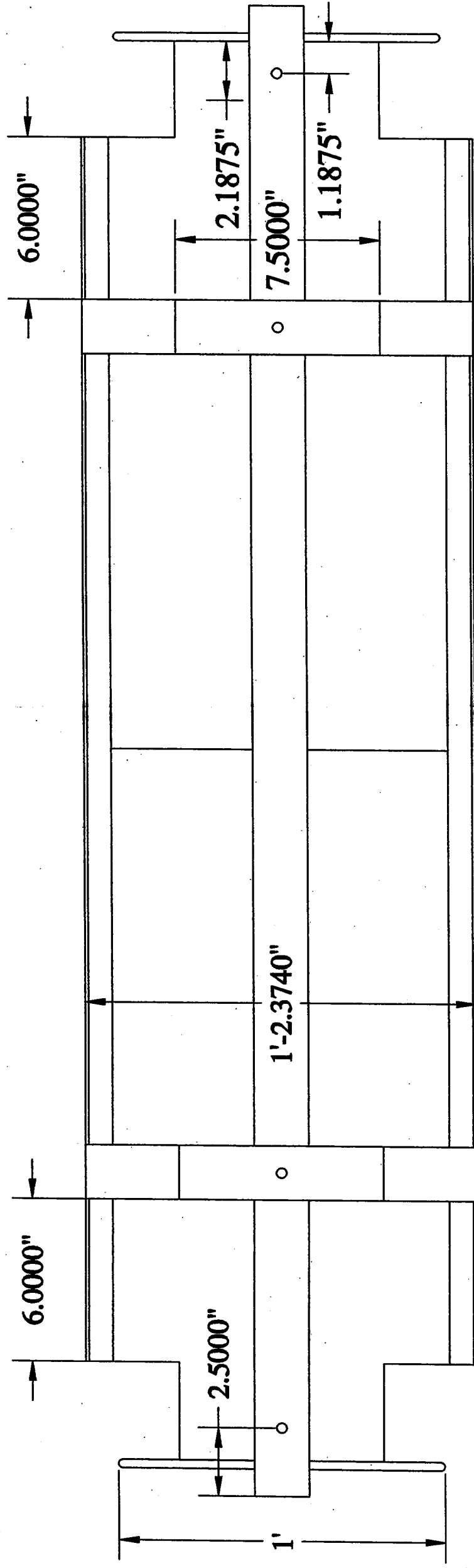

BOTTOM VIEW

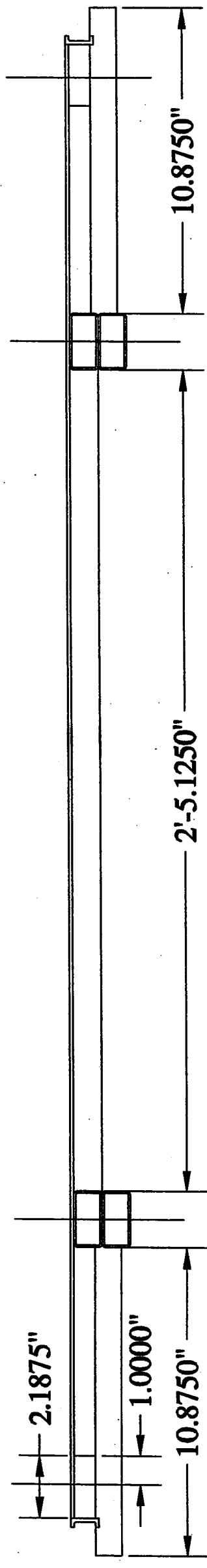

SIDE VIEW

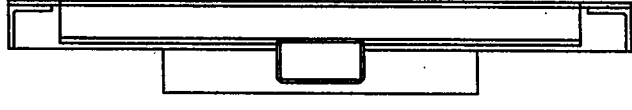

END VIEW

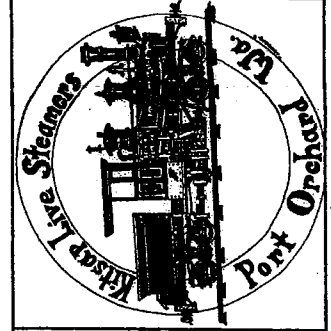

# KITSAP LIVE STEAMERS

## STEEL OFFSET CUPOLA CABOOSE FRAME DETAILS

DRAWN BY:  
**G. ROBINSON**

CHECKED BY:  
**D. WEAVER**

SIZE

FSCM NO.

DWG NO. **KLS04**

REV

SCALE **NONE**

SHEET **4 OF 8**

**DRAFT GEAR TUBE**

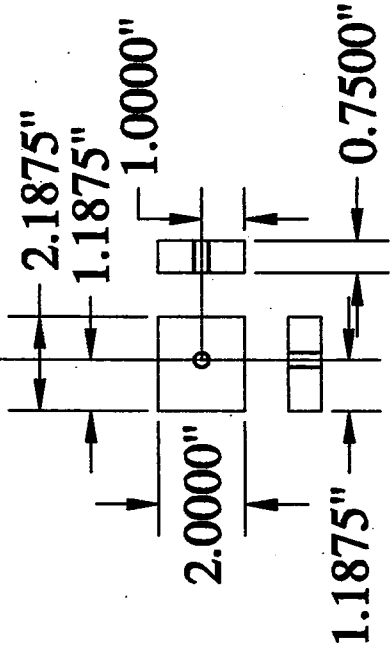
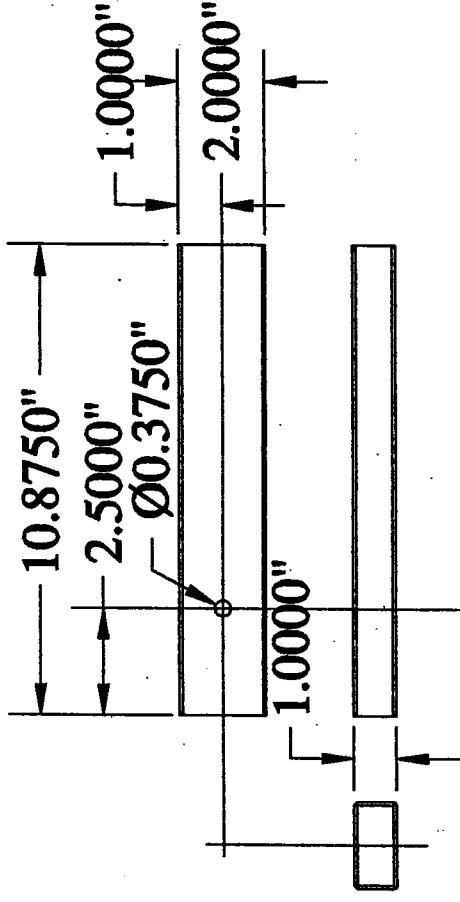

**DRILL 5/16"  
TAP 3/8"-16**

**DRAFT GEAR SPACER**

**BOLSTER**

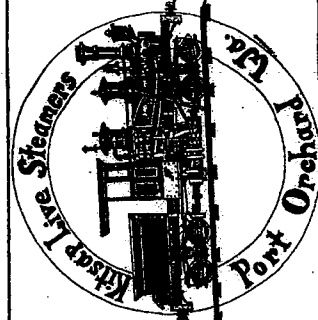
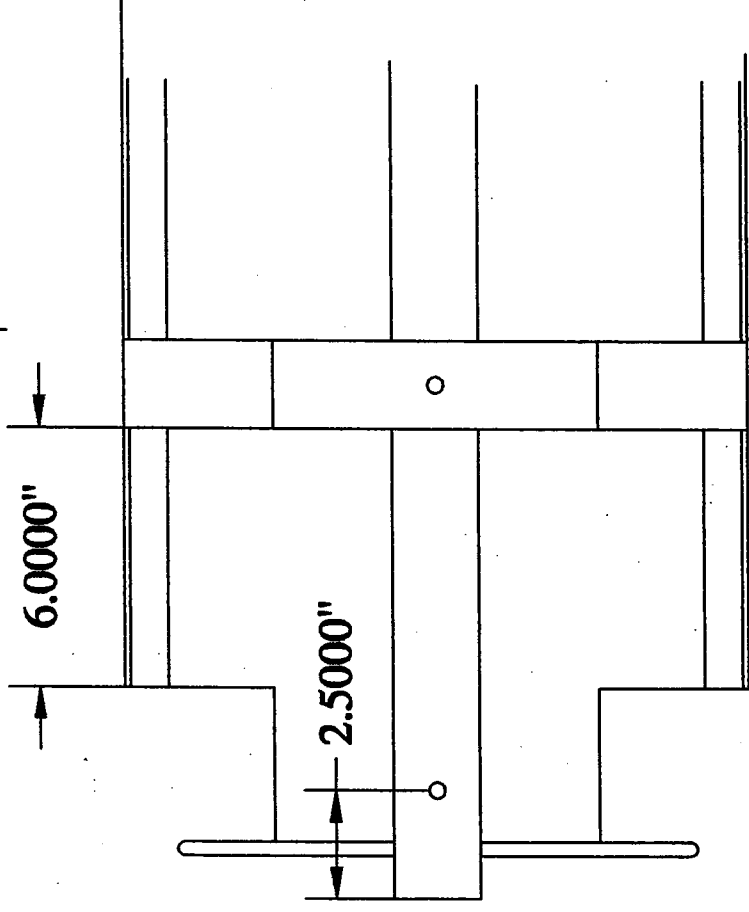
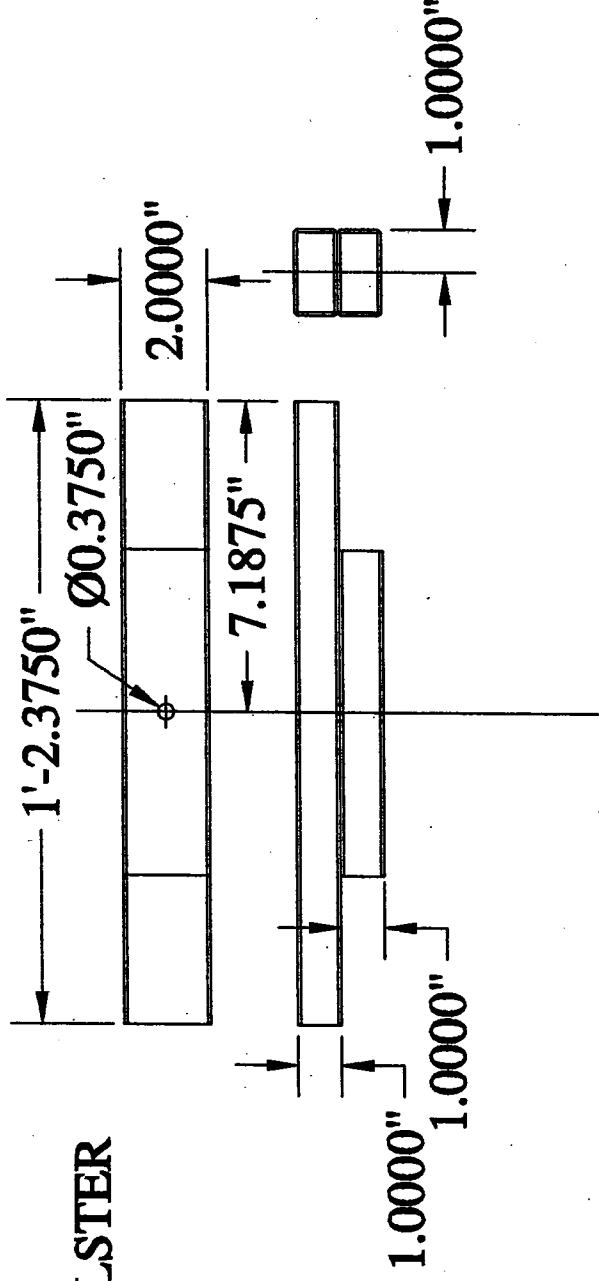

**DRAWN BY:  
G. ROBINSON**  
**CHECKED BY:  
D. WEAVER**

**KITSAP LIVE STEAMERS**

**STEEL OFFSET CUPOLA CABOOSE  
BOLSTER & DRAFT GEAR DETAILS**

SIZE	FSCM NO.	DWG NO.	REV
SCALE NONE		KLS05	
SHEET		5 OF 8	

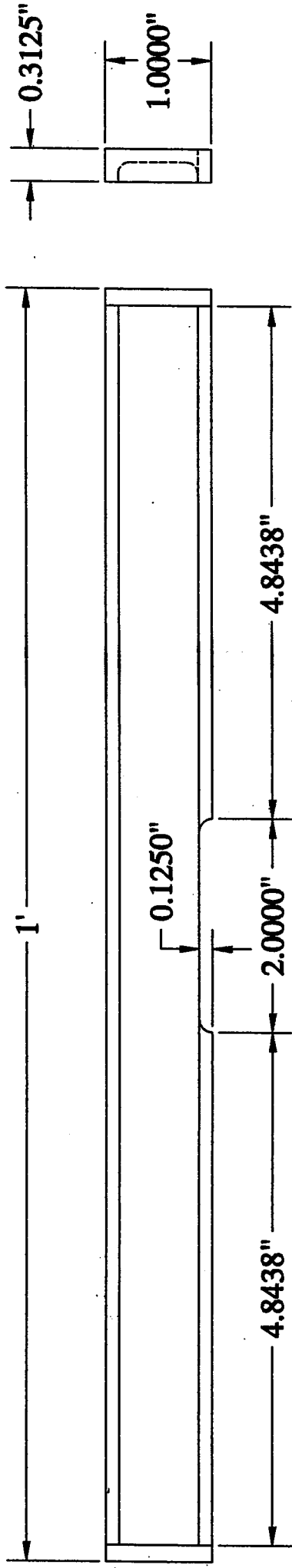
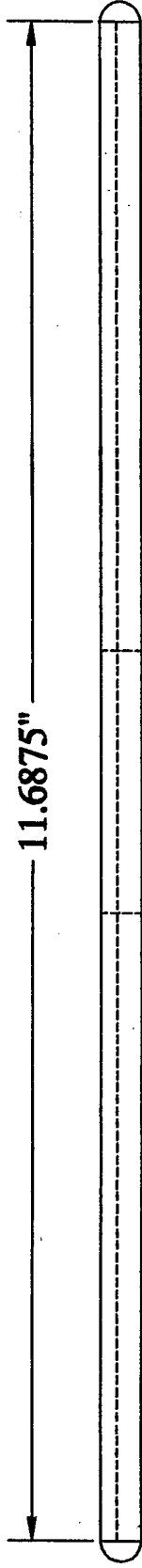

**NOTE:**  
 ENDS OF BEAM ARE MADE  
 FROM 5/16" DIAM. STEEL ROD  
 MILLED TO HALF ROUND SHAPE  
 AND SILVERBRAZED TO EACH END.

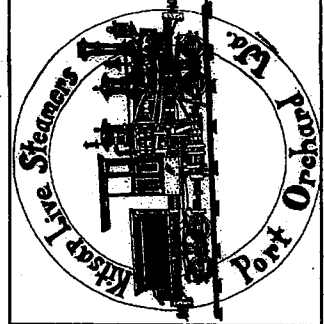

**DRAWN BY:**  
**G. ROBINSON**

**CHECKED BY:**  
**D. WEAVER**

# KITSAP LIVE STEAMERS

**STEEL OFFSET CUPOLA CABOOSE  
 END BEAM DETAILS**

SIZE

FSCM NO.

DWG NO.

**KLS06**

REV

SCALE NONE

SHEET

**6 OF 8**

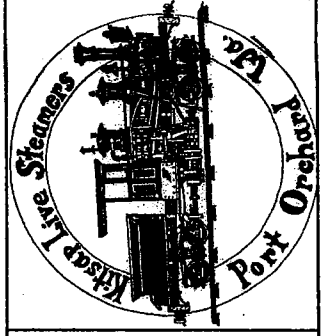
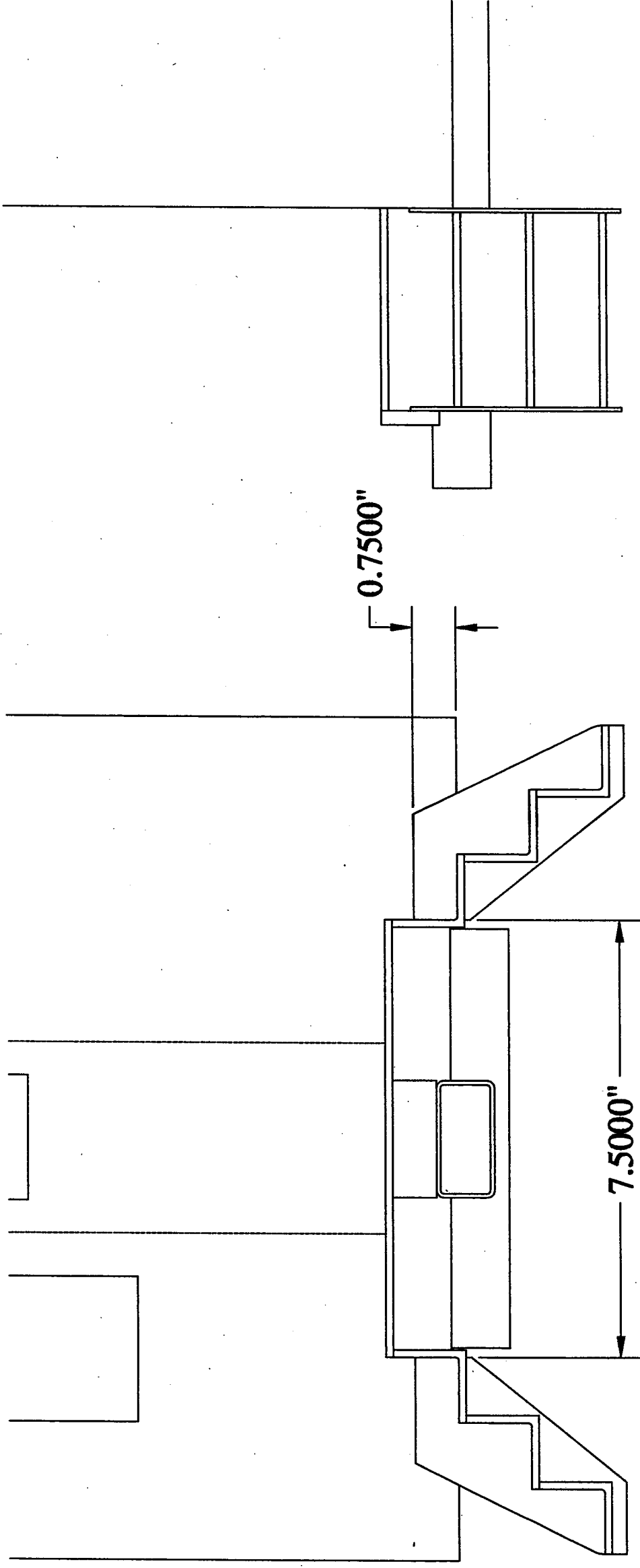

DRAWN BY:  
G. ROBINSON

CHECKED BY:  
D. WEAVER

# KITSAP LIVE STEAMERS

## STEEL OFFSET CUPOLA CABOOSE STEP DETAILS

SIZE	FSCM NO.	DWG NO.	REV
		<b>KLS07</b>	
SCALE NONE		SHEET	7 OF 8

LADDER

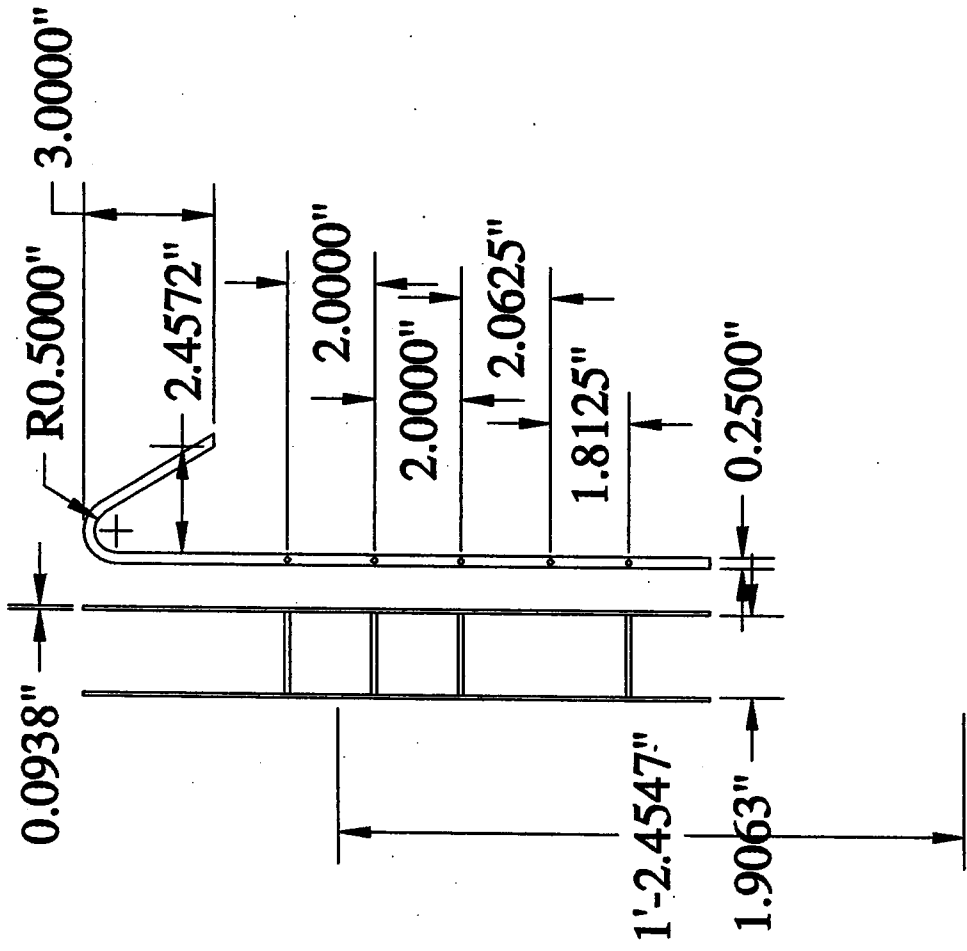

BODY CORNER RADIUS DETAIL

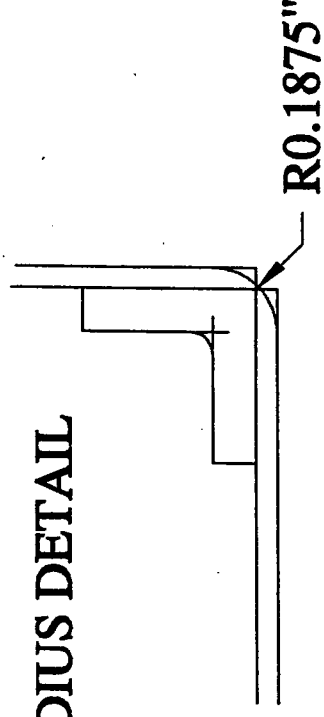

CUPOLA CORNER DETAIL

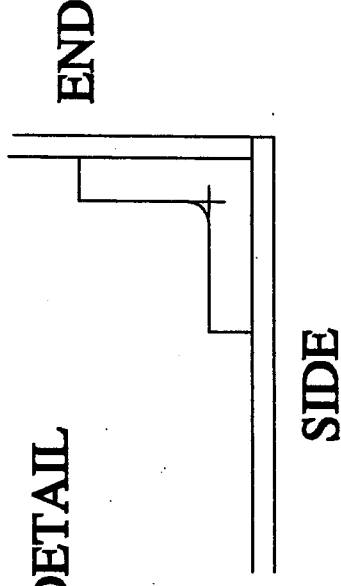

END HANDRAILS

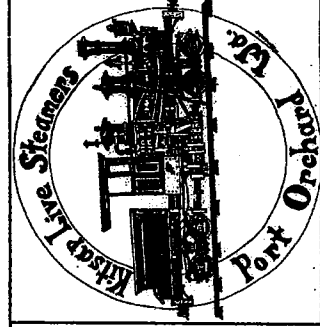
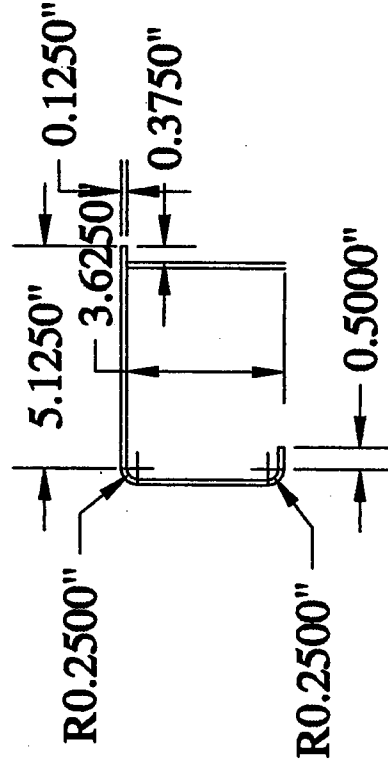

KITSAP LIVE STEAMERS

STEEL OFFSET CUPOLA CABOOSE  
LADDER, END RAILS & CORNER DETAILS

DRAWN BY: <b>G. ROBINSON</b>	SIZE	FSCM NO.	DWG NO.	REV
	SCALE NONE			KLS08
CHECKED BY: <b>D. WEAVER</b>		SHEET		8 OF 8