



# **Boiler Certification Documents**

**4-6-2 Pacific**

Kenneth Olsen

6518 44<sup>th</sup> Ave SW  
Seattle, WA 98136

206-718-9401

**Form 1**  
**Hobby Boiler**

Boiler owner complete lines 1, 2, & 3 prior to initial inspection:

---

1. Boiler Identification (owner): \_\_\_\_\_ Kenneth Olsen \_\_\_\_\_  
2. Washington State Special Number: \_\_\_\_\_ 1728-10 \_\_\_\_\_  
3. Owner's Address: \_\_\_\_\_ 6518-44<sup>th</sup> Ave SW Unit A \_\_\_\_\_  
City, State & Zip: \_\_\_\_\_ Seattle, WA 98136 \_\_\_\_\_

**Inspection**

Verify Materials Form 2\* \_\_\_\_\_

Verify Design Disclosure Form 3\* \_\_\_\_\_

Verify Boiler Drawings\* \_\_\_\_\_

Enter Certificate Pressure \_\_\_\_\_ PSIG

Hydrostatic Pressure Test\*\* \_\_\_\_\_ PSIG

Verify Satisfactory Pressure Test: \_\_\_\_\_

Verify Satisfactory Visual Inspection

Internal: \_\_\_\_\_

External: \_\_\_\_\_

Verify Satisfactory Steam Gauge Operation \_\_\_\_\_

Verify Satisfactory Safety Valve Operation \_\_\_\_\_

ASME  Non-ASME

Witness Satisfactory Boiler Operation \_\_\_\_\_

Certify Boiler Yes \_\_\_\_\_ No \_\_\_\_\_ (\*\*\*)

Inspector \_\_\_\_\_ Number \_\_\_\_\_ Date: \_\_\_\_\_

\*Not required for Annual Testing.

\*\*Enter pressure corresponding to test requirements.

\*\*\*Attach written reason for not accepting, including reference to requirements.

## Form 2 (Material List) & Form 3 (Design Disclosure)

Hobby Boilers Inspection Check List

Revision 0

Maximum Allowable Working Pressure (MAWP) is defined as the maximum pressure determined by the lowest calculated pressure of each separate component.

Component	Form 2: Material List and MAS:	Form 3: (MWAP)
1. Boiler shell (Boiler Barrel)	SA 53 gr. B Smls - Pipe - 15,000 MAS	942.34 PSI
2. Front Tube Sheet (Plate)	SA 36 - Plate - 14,500 MAS	644.44 PSI
3. Rear Tube Sheet (Firebox Tubesheet)	SA 36 - Plate - 14,500 MAS	601.54 PSI
4. Flues (fire tubes)	1/2" Tubes B-88 copper	1378.33 PSI
5. Super heater tubes	1" Tubes B-88 copper	969.50 PSI
6. Firebox Side (Leg) Stays	SA 36 - Plate - 14,500 MAS	400.37 PSI
7. Firebox sides	SA 36 - Plate - 14,500 MAS	743.41PSI
8. Crown Sheet Round stays	SA 36 - Plate - 14,500 MAS	N/A PSI PSI
9. Crown Sheet Girder Stays:	SA 36 - Plate - 14,500 MAS	477.53 PSI
10 Crown Sheet	SA 36 - Plate - 14,500 MAS	809.46 PSI
11 Mud Ring	SA 36 - Bar Stock - 13,300 MAS	1416.10 PSI
12 Siphon Tubes	1/2" Tubes B-88 copper	501.88 PSI
13 Throat Sheet	SA 36 - Plate - 14,500 MAS	559.74 PSI
14. Steam Dome	Unidentified Steel - All Forms - 10,300 MAS	2087.84 PSI
15. Firebox Backplate	SA 36 - Plate - 14,500 MAS	840.01 PSI
16 Backhead	SA 36 - Plate - 14,500 MAS	1080.71PSI

Note: Under Form 3 above, if "N/A" appears, that component is not installed in this boiler.

The lowest MAWP from the above chart is 400.37 PSI (6. Firebox Side (Leg) Stays). However, this exceeds the MAWP allowed by the Washington State Miniature Hobby Boiler Guidelines. Therefore:

### The MWAP for this boiler shall be 150 PSIG

- The materials utilized in boiler fabrication shall be noted in the application sections of the Boiler Material Form (Form 2). When completed, the form shall be signed by the owner or fabricator thereby certifying that the noted materials used are as indicated.
- Maximum allowable material stress will be indicated in the following table. This table lists materials and the stress that may be used in fabrication of boilers fabricated in accordance to the requirements set forth in this procedure. However, the boiler is not limited to these materials only.
- Seamless and welded shells made from pipe for miniature boilers shall be not less than 3/16 in. (5.0 mm) in thickness. Shells or heads made from plate shall be not less than 1/4 in. (6 mm) in thickness. Heads used as tube-sheets, with tubes expanded, shall be at least 5/16 in. (8 mm) in thickness.
- The maximum allowable stress (MAS) to be used for maximum allowable working pressure (MAWP) calculations shall be 0.75 times the maximum stress allowed at 400 deg. F, by Section II Part D, ASME code for specific known materials. All other shall be prescribed in the table below.

Form 2: Weld/Solder Material

Area:     All     Filler:     7100     Root:     6011    

Tested by: \_\_\_\_\_ Date: \_\_\_\_/\_\_\_\_/\_\_\_\_

## Preamble to Calculations and their results

### 4-6-2 Pacific model steam engine

#### Boiler Design Calculations

Kenneth Olsen

Ken Olsen resides at 6518 44<sup>th</sup> Ave SW, Seattle, WA 98136, Cell 206-718-9401. Ken is replacing the existing boiler for his scale model steam engine. The state of Washington requires that all pressure vessels and boilers be certified. Therefore, it is the purpose of this document to show all the necessary calculations and data for the proper certification of the new boiler by the State of Washington. Special thanks to Don Deffley, Russ Noe, Conrad Watne, Courtney Jones and many other members of Kitsap Live Steamers, Inc. for their help.

The Revised Code of Washington (RCW 70.79.070) places the responsibility on the owner for certification of Miniature Hobby Boilers with the Department of Labor and Industries, Boiler and Pressure Vessel Section. Under this authority, the Boiler and Pressure Vessel Section have developed the following dimensional limitations and criteria (taken from the 1998 ASME code, Section I, PMB-2, pg 157).

For a boiler to be certified as a Miniature Hobby Boiler, it must fall within the following guidelines:

- 1) The *maximum* of sixteen inches inside boiler shell diameter;
- 2) A *maximum* of twenty square feet of total heating surface;
- 3) A *maximum* gross volume of five cubic feet, and a *minimum* of seventy five cubic inches;
- 4) A *maximum* allowable working pressure of 150 psig

### BOILER DESIGN CALCULATIONS AND THEIR RESULTS

#### I Inside boiler shell diameter shall be sixteen inches or less:

Barrel OD:	10.75	Inches
Boiler Wall thickness:	0.365	Inches
Barrel ID:	10.020	Inches

**Inside diameter (ID) of boiler shell = 10.020**

## Boiler design calculations and their results continued:

### **II. Heating area of the boiler components shall be twenty square feet or less.**

A. **Tubes:** The tubes shall consist of the sum of the areas being heated, or the circumferential surface times the length of the tubes times the number of tubes.

Superheater: Note: Superheater tubes are installed in this boiler

ID of Tube: 0.995 inches  
Length of Tube: 34.1875 inches  
Number of Tubes: 5

Formula:  $\pi * \text{Tube ID radius} * \text{Tube Length} * \text{Number of tubes} = 534.33 \text{ Sq In.}$

Boiler tubes also known as boiler tubes or flues:

ID of Tubes 0.527 inches  
Length of Tube 34.1875 inches  
Number of Tubes: 31

Formula:  $\pi * \text{Tube ID radius} * \text{Tube Length} * \text{Number of tubes} = 1,912.240 \text{ Sq In.}$

### **Total of tube heating area = 2,288.977 Sq In**

B: **Front tube sheet:** The front tube sheets shall consist of the area of the tube sheet less the sum of the areas of the tubes. Note: if Superheater tubes are not present, the values will show "N/A"

Front tube sheet OD 10.020 Sq In  
OD of Superheater tubes if present: 1.125 Inches  
Number of Tubes 5  
OD of firebox flues 0.625 Inches  
Number of Tubes 31

Formula:  $\pi * \text{Front tube sheet radius squared} * \text{less the heating area of the tubes} = 63.760 \text{ Sq In}$

### **Total Tube sheet heating area: 64.374 Sq In**

C: **Crown Sheet:** The surface area of the crown sheet is calculated using the length times the width measurements. In this case the area was calculated using the "Area" function within the Cad program used to generate the area. See the attached drawing.:

Formula:  $\text{Length} * \text{Width} = \text{Total Sq In.}$

The area of the Crown Sheet using the above formula is 73.402 Sq In

### **Total crown sheet heating area: 73.402 sq In**

**D: Firebox sides (legs):** The surface area of the firebox sides is calculated using the length times the width measurements. In this case the area was calculated using the "Area" function within the Cad program used to generate the area. See attached drawing.:

Formula: Height \* Average length \* 2 as there is two sides.

The area of the firebox sides (legs) using the above formula is:151.434.

**Total crown sheet heating area: 151.434 sq In**

**E: Firebox backplate:** The surface area of the firebox backplate is calculated using the height times the width measurements. In this case the area was calculated using the "Area" function within the Cad program used to generate the area. See the attached drawing:

Formula: height \* width

The area of the firebox backplate using the above formula is: 16.556 sq in.

**Total Firebox Backplate heating area: 16.556 Sq In**

**F: Firebox Front Tube Sheet:** The surface area of the Firebox front tube sheet is calculated using the height times the width measurements. In this case the area was calculated using the "Area" function within the Cad program used to generate the area. See the attached drawing:

Formula: (Height \* average width) – area of tube ends

The area of the Firebox Front Tube Sheet using the above formula is: 54.784 sq In

**Total Firebox Front Tube Sheet heating area: 54.784 Sq In**

**G: Firebox Siphon Tubes:** Note: if firebox box siphon tubes are not present, the values will show "N/A".

OD Tube            0.625 inches  
Length of tube    11.125  
Number of tubes   3

Formula: Total of tube heating area = OD \* p \* Length \* # of tubes = 65.53 sq In

**Total Firebox Siphon Tubes heating area is: 65.53 Sq In**

A. Total of tube heating area:	2,288.98 Sq In
B. Total front tube sheet heating area:	64.37 Sq In
C. Total of crown sheet heating area:	73.40 Sq In
D. Total of firebox sides heating area:	151.43 Sq In
E. Total of firebox rear heating area:	16.56 Sq In
F. Total of front tube sheet heating area:	54.17 Sq In
G. Firebox siphon tube heating area:	<u>65.53 Sq In</u>
Total:	2,715.06 Sq In

**144 Sq In = 1 Sq Ft, so 2,715.06/144 = 18.85**

**Total heating area: 18.85 Square Feet**

Gross volume maximum of five cubic feet, and a minimum of seventy five cubic inches.

**III. Total gross volume of the this boiler shall include the following calculations:**

**A. Boiler Barrel:**

Barrel OD: 10.75 inches  
Boiler wall thickness: 0.365 Inches  
Barrel ID: 10.02 Inches  
Radius: 5.01 Inches  
Length\* 34.1875 Inches

\*Note: inches between inside of front tube sheet to the forward side of the back tube sheet.

Formula: Volume =  $\pi$  \* barrel ID radius \* barrel length = 2,695.83 Cubic Inches

**Total Boiler Barrel Volume - 2,695.83 Cubic Inches**

**B. Firebox Legs (Sides):**

The firebox legs (Sides) are of an irregular shape and are equal to the previous calculations for the heating surface. The square inch calculations are used for that portion of the volume calculations.

Area of Firebox legs from cad drawings: 75.013 Sq In  
Distance between the water side of the  
Firebox legs and the inside of the firebox sides 0.625 Inches

Formula: Area of firebox legs \* Distance between = 93.766 Cu In

**Total Firebox Legs Volume = 93.766 Cubic Inches**

**C. Firebox Rear End:**

The firebox rear end is calculated based upon the height of the firebox backplate x its average width x the space between the firebox backplate and the firebox backhead.

Area of the Firebox back plate from Cad drawing: 60.310 Sq In  
Distance between firebox backplate and backhead: 0.693 Inches

Formula: Area of firebox back plate \* Distance between = 41.795 Cu In

**Total Firebox Rear End Volume = 41.795 Cubic Inches**

**D. Firebox front end:**

Area of firebox rear end from Cad drawing: 66.39 Sq In  
Distance between firebox rear end and backhead: 0.625 Inches

Formula: Area of firebox rear end \* Distance between = 41.494 Cu In.

**Total Firebox Front End Rear End Volume = 41.494 Cubic Inches.**

**E. Firebox crown sheet area:**

Radius of barrel:	5.010 Inches
Height between top of crown sheet and underside of barrel:	4.103 Inches
Distance from front edge of crown sheet to inside back edge of backhead:	11.100 Inches

Formula: segment of a circle times the distance from the front end of the crown sheet to the middle of the backhead above the crown sheet = 337.317 Cu In.

The formula for a segment of a circle required to calculate this can be found at:

<http://www.mathopenref.com/segmentareaht.html>.

**Total Firebox Crown Sheet Volume - 485.186 Cubic Inches.**

**Summary of the gross volume for this boiler:**

- |  |                        |
|--|------------------------|
| A. Total boiler Barrel volume =        | 2,695.83 Cu. In.       |
| B. Total Firebox leg volume =          | 93.766 Cu. In.         |
| C. Total Firebox rear volume =         | 41.795 Cu. In.         |
| D. Total Firebox front volume =        | 41.494 Cu. In.         |
| E. Total fire box crown sheet volume:= | <u>337.317 Cu. In.</u> |
| Total:                                 | 3,210.202 Cu. In.      |

The conversion of Cu. In. to Cu. Ft.. 3,210.202 is divided by 1728 = 1.858 Cu Feet

**Total Boiler Volume = 1.858 Cubic Feet.**

**IV Boiler Calculations to determine the *maximum* boiler pressure allowed for this boiler:**

Maximum Allowable Working Pressure (MAWP) is defined as the maximum pressure determined by the lowest calculated pressure of each separate component.

**If the MAWP of any component is less than 150 psi, that will be the MAWP for the boiler, otherwise the MAWP shall not be more than 150 psi.**

Maximum Allowable Stress (MAS) is the maximum stress on each separate component. Washington State allows the following stress ratings on material used within this boiler at 400 degrees Fahrenheit :

Material, Form and Stress Value (MAS)

See page 2 of 13 for a complete list of all materials, form and stress values (MAS)

Copper Tube The values to be determined by information available on a case by case basis.



### 1. Boiler Shell (Barrel)

For Boiler Shells, cylinders, and parts of Cylinders, the following equation is limited to longitudinal sections.

$$P = \frac{2 * S * E * t}{D - (2 * Y * t)}$$

Where:

P = MWAP

S = MAS: 15,000

D = OD of Cylinder (Barrel): 10.75 inches

E = Constant for Seamless or welded pipe: 0.90

Y = Constant for conditions less than 900 Deg F: 0.40

T = Cylinder (Barrel) wall thickness: 0.365 Inches

**Using the formula above the MWAP for this component is: 942.34 PSI**

### 2. Front Tube Sheet

$$P = \frac{S * C * t^2}{X * Y}$$

Where:

P = MAWP

S = MAS: 14,500

t = Thickness of front tube sheet: 0.500 Inches

X = Distance between C/L of hollow stays: 2.63 Inches

Y = Distance between C/L of hollow stays & C/L if 1<sup>st</sup> row of tubes: 4.50 Inches

C = Constant\*\*: 2.1

\*A=X\*Y, where x & y are pitches at right angles passing through the center of a stay.

\*\*Constant is 2.1 for stayed surfaces (From 1998 ASME Code, Section I, PFTG-23.1.3 pg 140)

**Using the formula above the MWAP for this component is: 644.44 PSI**

### 3. Rear Tube Sheet (Firebox Tubesheet)

$$P = \frac{S * C * t^2}{X * Y}$$

Where:

P = MAWP

S = MAS: 14,500

t = Thickness of front tube sheet: 0.500 Inches

X = Distance between C/L of tube sheet stays: 2.531 Inches

Y = Distance between C/L of bottom row of flues to C/L of tube sheet stays: 5.000 Inches

C – Constant\*\*: 2.1

\*A=X\*Y, where x & y are pitches at right angles passing through the center of a stay.

\*\*Constant is 2.1 for stayed surfaces (From 1998 ASME Code, Section I, PFTG-23.1.3 pg 140)

**Using the formula above the MWAP for this component is: 601.54 PSI**

#### 4. Flues (fire tubes)

$$P = S * \left[ \frac{2t - 0.01D - 2e}{D - t - (0.005 * D) - e} \right]$$

Where:

P = MAWP

S = MAS for 1/2" Tubes B-88 copper:\*

8,700

D = Outside diameter of tubing in inches

0.625 Inches

t = Thickness of the tubing wall in inches

0.049 Inches

e = A constant: for welded tube ends, e = 0.0

0.00

Note: For other end conditions, refer to ASME Power Boiler Section I, Part PG-27

**Using the formula above the MAWP for this component is: 1,378.33 PSI**

#### 5. Superheater tubes

$$P = S * \left[ \frac{2t - 0.01D - 2e}{D - t - (0.005 * D) - e} \right]$$

Where:

P = MAWP

S = MAS for 1" Tubes B-88 copper:

8,700

D = Outside diameter of tubing in inches:

1.125 Inches

t = Thickness of the tubing wall in inches:

0.065 Inches

e = A constant: For welded tube ends, e = 0.0

0.00

Note: For other end conditions, refer to ASME Power Boiler Section I, Part PG-27

**Using the formula above the MAWP for this component is: 969.50 PSI**

#### 6. Firebox Sides (Legs) Stays:

$$P = \frac{Sa}{A}$$

Where:

P = MAWP

S = MAS:

14,500

A = Area of the plate in inches (Use x and y below)

X = Distance that separates the stays center to center:

2 Inches

Use vertical distance for x

Y = Distance that separates the stays center to center:

2 Inches

Use horizontal distance for y

a = Cross sectional area of stays:

0.11 Sq In

**Using the formula above the MAWP for this component is: 400.37 PSI**

## 7. Firebox sides:

$$P = \frac{S * C * t^2}{X * Y}$$

Where

P = MWAP

S = MAS:

14,500

t = Thickness of plate:

0.3125 Inches

X = Vertical distance between C/L to C/L of stays:

2.000 Inches

Y = Horizontal distance between C/L to C/L of stays:

2.000 Inches

C = is defined as the constant for flat stayed surfaces\*:

2.1

(1998 ASME Code, Sect 1, Pg 46.1 pg 36 eq #2)

**Using the formula above the MWAP for this component is: 743.41 PSI**

## 8. Crown Sheet Round Stays

$$P = \frac{S a}{X * Y}$$

Where

P = MWAP

S = MAS:

Not installed in this Boiler

a = Cross sectional area of the stays in inches:

Not installed in this Boilerr

X = Vertical distance that separates the stays C/L to C/L:

Not installed in this Boiler

Y = Horizontal distance that separates the stays C/L to C/L:

Not installed in this Boiler

**Using the formula above the MWAP for this component is: N/A PSI**

## 9. Crown Sheet Girder Stays:

PFT-30.1 gives this formula:

$$P = \frac{C * d^2 * t}{(W - p) D_1 * W}$$

Where

P = MWAP

C = a constant with a value that depends on the number of staybolts on each girder\*: 10,000

D<sub>1</sub> = Distance between girders from center to center: 2.300 In.

d = Height of the girder: 2.625 In

p = Pitch of supporting bolts (1/2 of the length of the girder if so built w/o the bolts: 2.300 In

t = Thickness of the girder(s) combined 1.250 In

W = the distance of the crown sheet front to back exposed to the fire: 10.08 In

\*Note: C = 7,000 if the girder is fitted with one supporting bolt, 10,000 if two or three, and 11,000 if four or five. Most of the girders used in model boilers have notches for water circulation which take the place of the bolts (Refer to the attached drawings). The leg between the centers of the notches represent the single bolt.

**Using the formula above the MWAP for this component is: 477.53 PSI**

### 10 Crown Sheet:

$$P = \frac{S * C * t^2}{X * Y}$$

Where

P = MWAP

S = MAS

t = thickness of the crown sheet

C = Is defined as the constant for stayed surfaces

X = Distance that separates the stays or girders center to center:

Y = Distance that separates the stays center to center front to back of boiler\*:

\*Use ½ the length of the girder if used.

14,500

0.375 Inches

2.1

2.3 Inches

2.3 Inches

**Using the formula above the MWAP for this component is: 809.46 PSI**

### 11 Mud Ring:

$$P = \frac{S * C * t^2}{X * Y}$$

Where

P = MWAP

S = MAS

t = Thickness (height) of the Mud Ring:

C = Defined as the constant for stayed surfaces:

X = Width of the mud ring:

Y = Length of the longest mud ring:

13,300

0.625 Inches

2.1

0.625 Inches

12.327Inches

**Using the formula above the MWAP for this component is: 1,416.10 PSI**

### 12 Siphon Tubes:

$$P = \frac{2 * S * E * t}{D - (2 * Y * t)}$$

Where

P = MWAP

S = MAS for K copper tube\*

D = OD of tubing in inches

E = Constant for seamless or welded pipe:

Y = Constant for conditions less than 900 deg F

t = Thickness of tubing wall in inches

\*Note: Internal MAS for copper tubes with internal pressure (ASME B41)

3,000

0.625 Inches

1.00

0.40

0.049 Inches

**Using the formula above the MWAP for this component is: 501.88 PSI**

### 13 Throat Sheet:

$$P = \frac{S * C * t^2}{X * Y}$$

Where

P = MWAP

S = MAS

T = Thickness of throat sheet

C = Constant for flat stayed surfaces:

X = Distance C/L to C/L of throat sheet Stays:

Y = Distance C/L of throat sheet stays to inside bottom of barrel:

14,500

0.313 Inches

2.1

5.000 Inches

1.063 Inches

**Using the formula above the MWAP for this component is:559.74 PSI**

**14 Steam Dome:**

$$P = \frac{2 * S * E * t}{D - (2 * Y * t)}$$

Where

P = MWAP

S = MAS

10,300.00

D = Outside diameter of the Steam Dome cylinder in inches:

4.000 Inches

E = 1.00 for seamless pipe, 0.90 for welded seam or 0.60 for other seams:

1.00

Y = 0.40 for conditions less than 900 degrees F:

0.40

T = cylinder wall thickness:

0.375 Inches

**Using the formula above the MWAP for this component is: 2087.84 psi.**

**15. Firebox Backplate:**

$$P = \frac{S * C * t^2}{X * Y}$$

Where

P = MWAP

S = MAS:

14,500

t = Thickness of backhead sheet:

0.3125 Inches

C = Constant for flat stayed surfaces:

2.1

X = Distance C/L to C/L of backplate stays:

3.000 Inches

Y = distance C/L of backplate stays to bottom of firebox door:

1.180 Inches

**Using the formula above the MWAP for this component is: 840.01 PSI**

**16 Backhead:**

$$P = \frac{S * C * t^2}{X * Y}$$

Where

P = MWAP

S = MAS

14,500

t = Thickness of backhead

0.500 Inches

C = Constant for flat stayed surfaces:

2.1

X = Distance C/L to C/L of backplate stays:

3.00 Inches

Y = Distance C/L of hollow stays down to top of crown sheet:

2.35 Inches

**Using the formula above the MWAP for this component is: 1080.71 PSI**

**The maximum allowable working pressure (MAWP) for this boiler as shown in the calculations for the weakest component #6. Firebox Side (Leg) Stays is: 400.37\_PSI. Therefore, the maximum allowable working pressure will be 150 PSI.**

---

Component

1

Boiler Shell (Boiler Barrel)

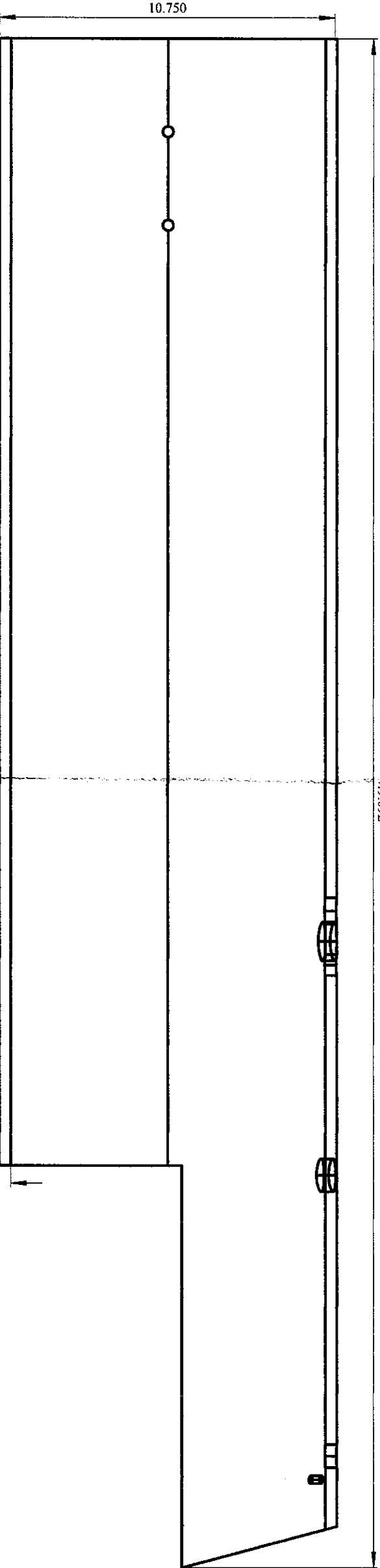

**Boiler Shell (Barrel)**  
**Schedule 40 Pipe**  
**Scale: 3" = 12"**

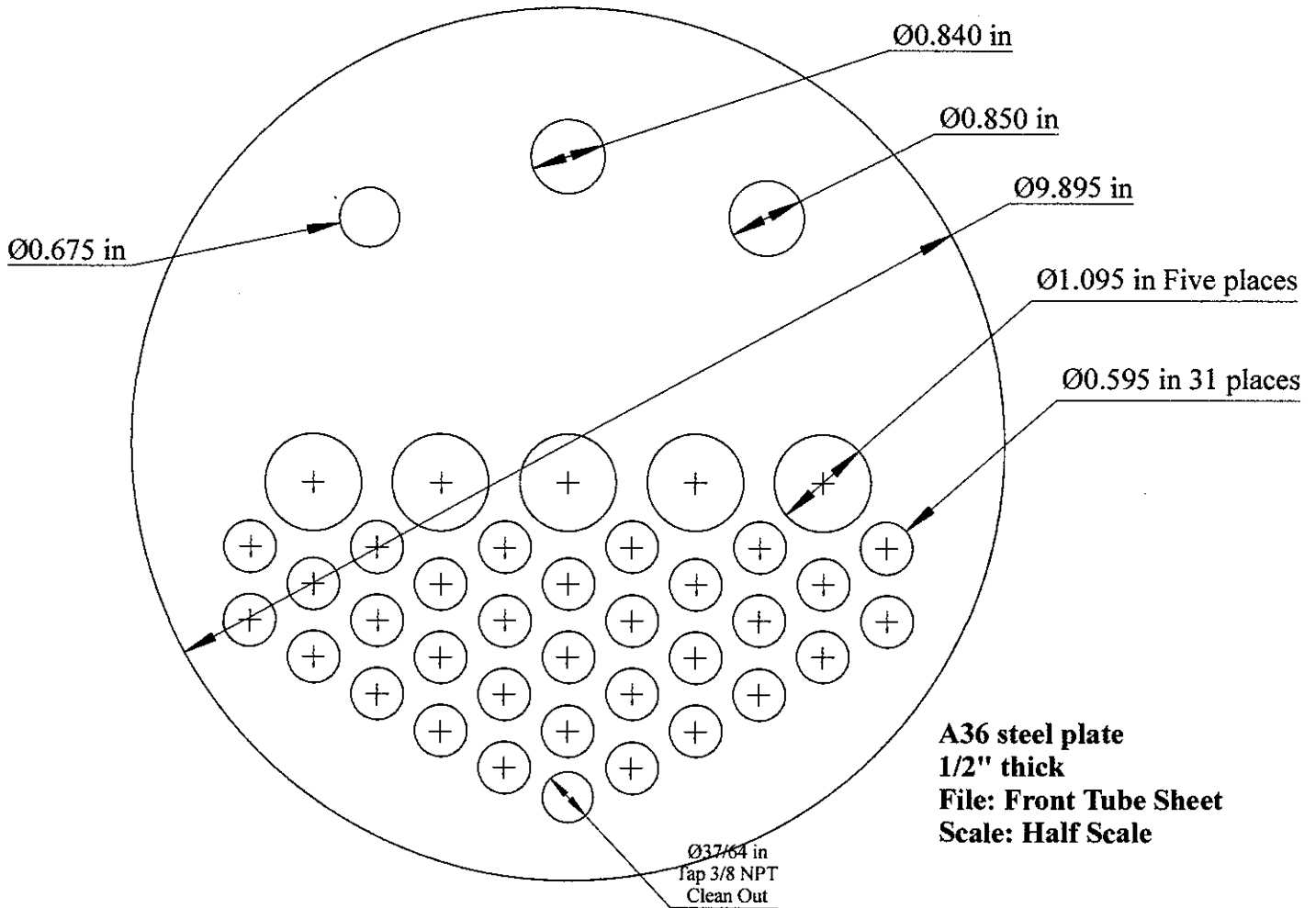

Component  
 2  
 Front Tube Sheet



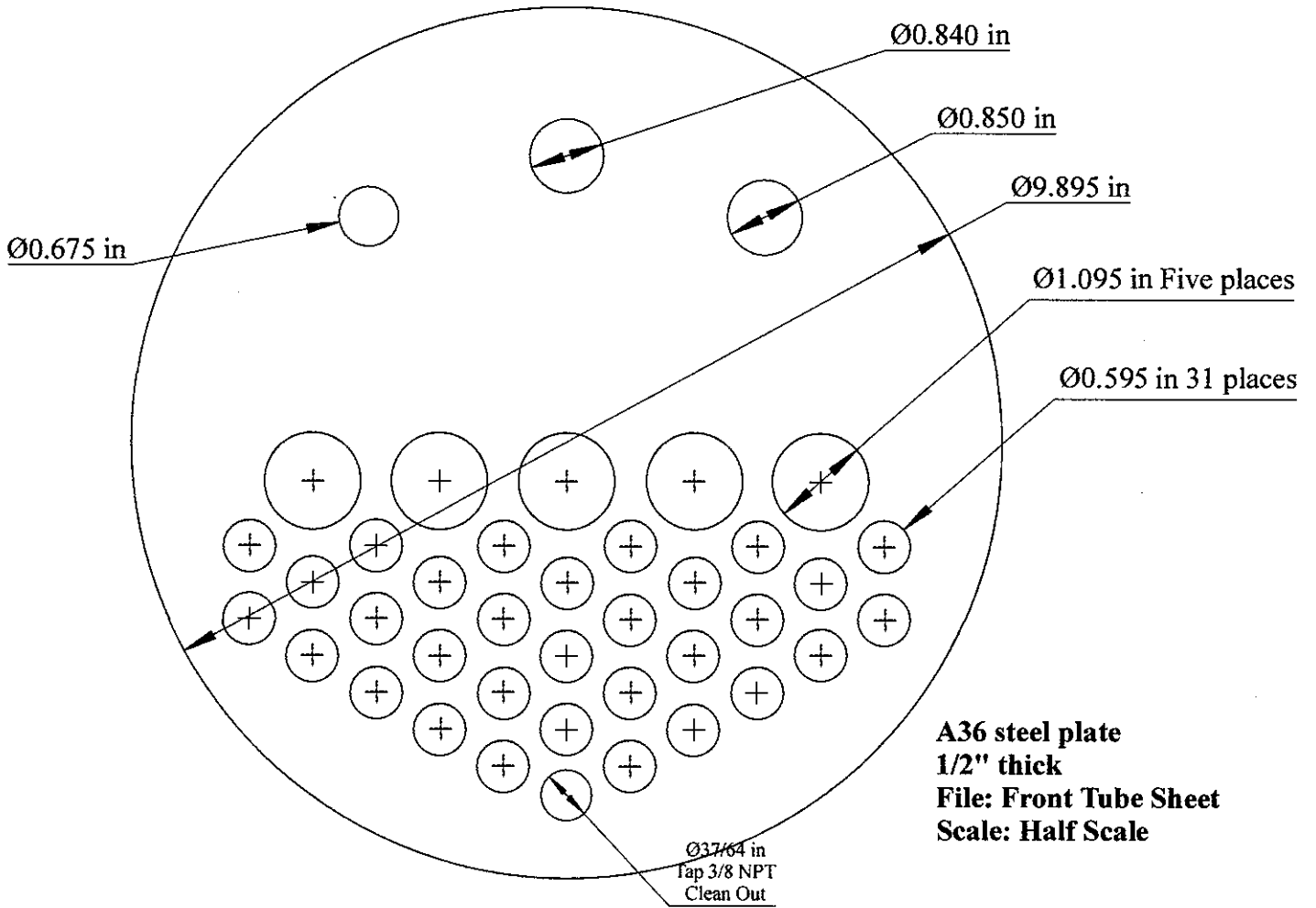

---

Component  
5  
Super Heater Tubes

---

Component  
4  
Flues (Fire Tubes)

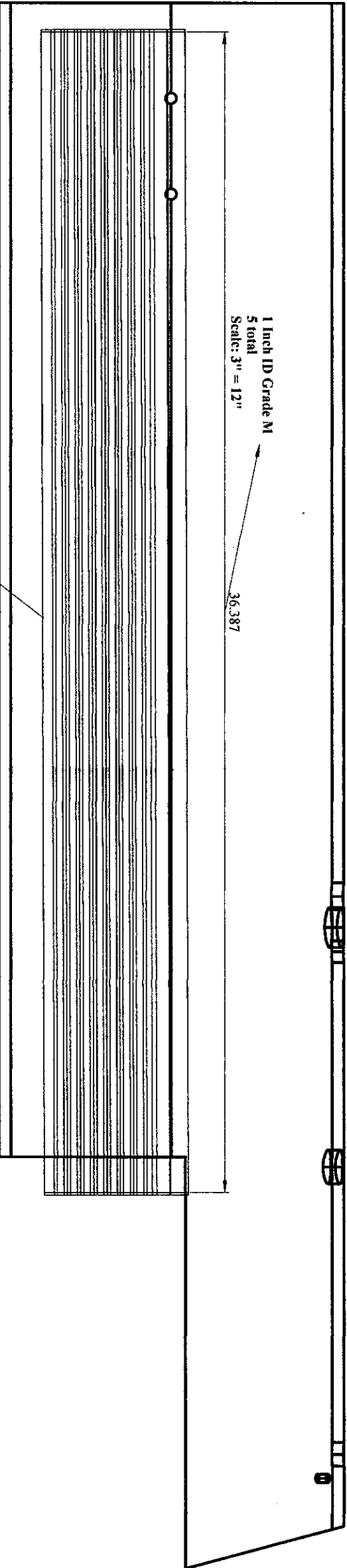

1 Inch ID Grade M  
5 total  
Scale: 3" = 12"

36.387

Plates (Fire tubes) Grade M  
31 total  
Scale: 3" = 12"

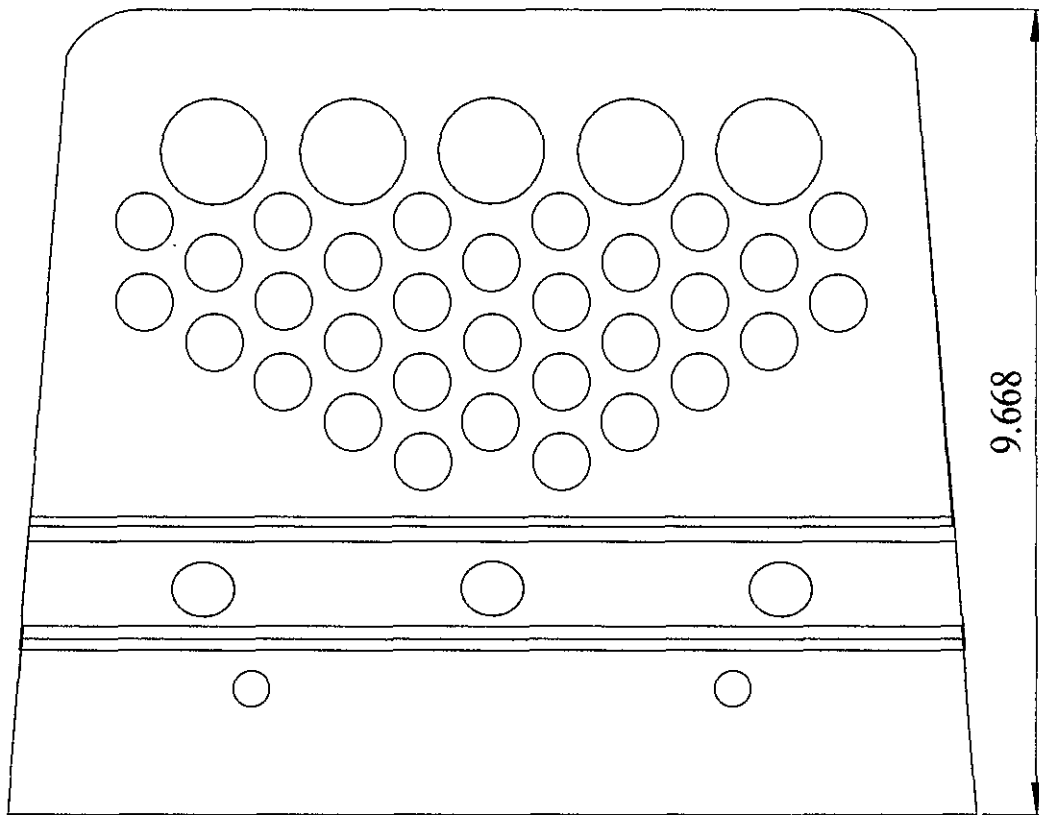

10.074

9.668

**Firebox Tube Sheet**  
**A36 1/2" Thick**  
**Scale: Half size**

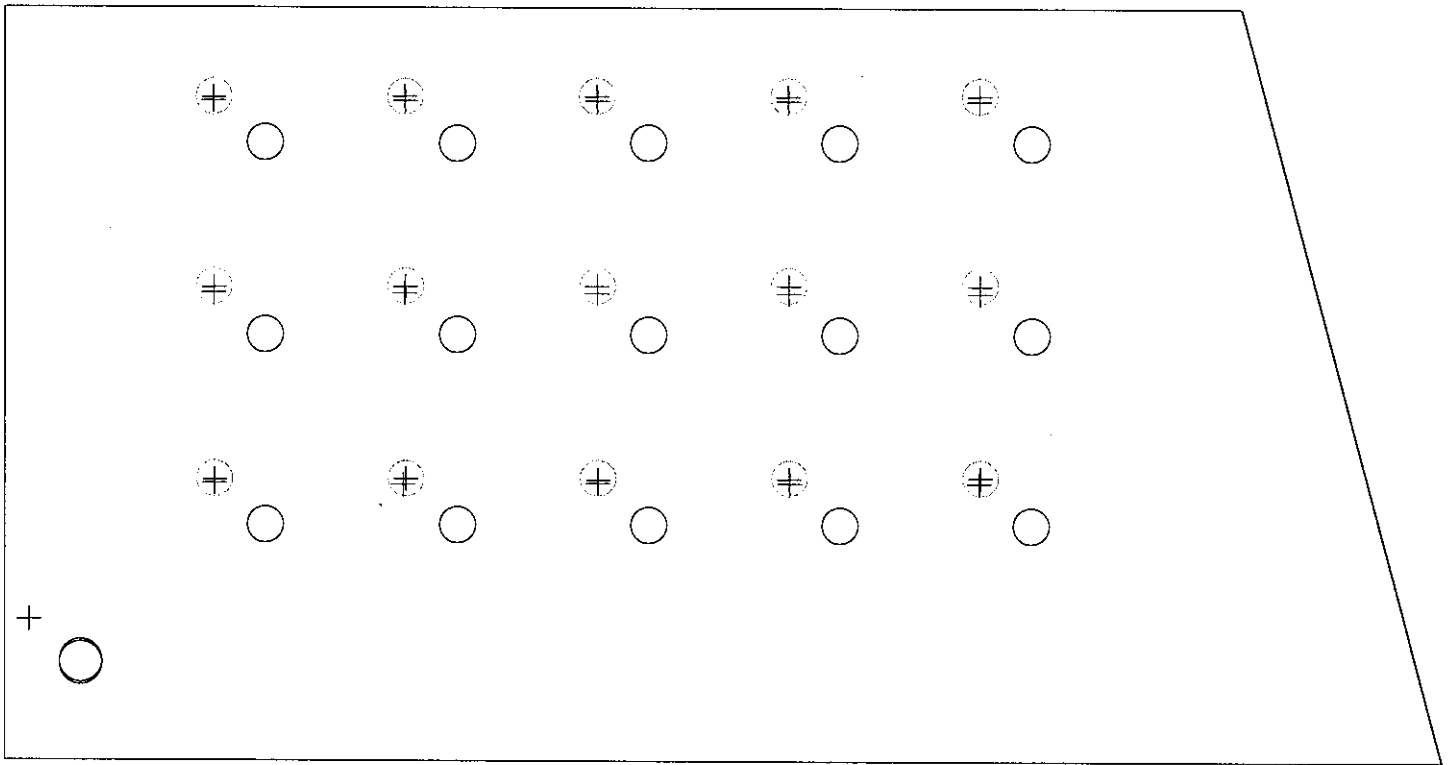

Make from A36 plate 5/16" thick  
File: Firebox Legs  
Scale: half size

7.808 in

15.000 in

75.00°

Component  
6  
Firebox Sides (legs)

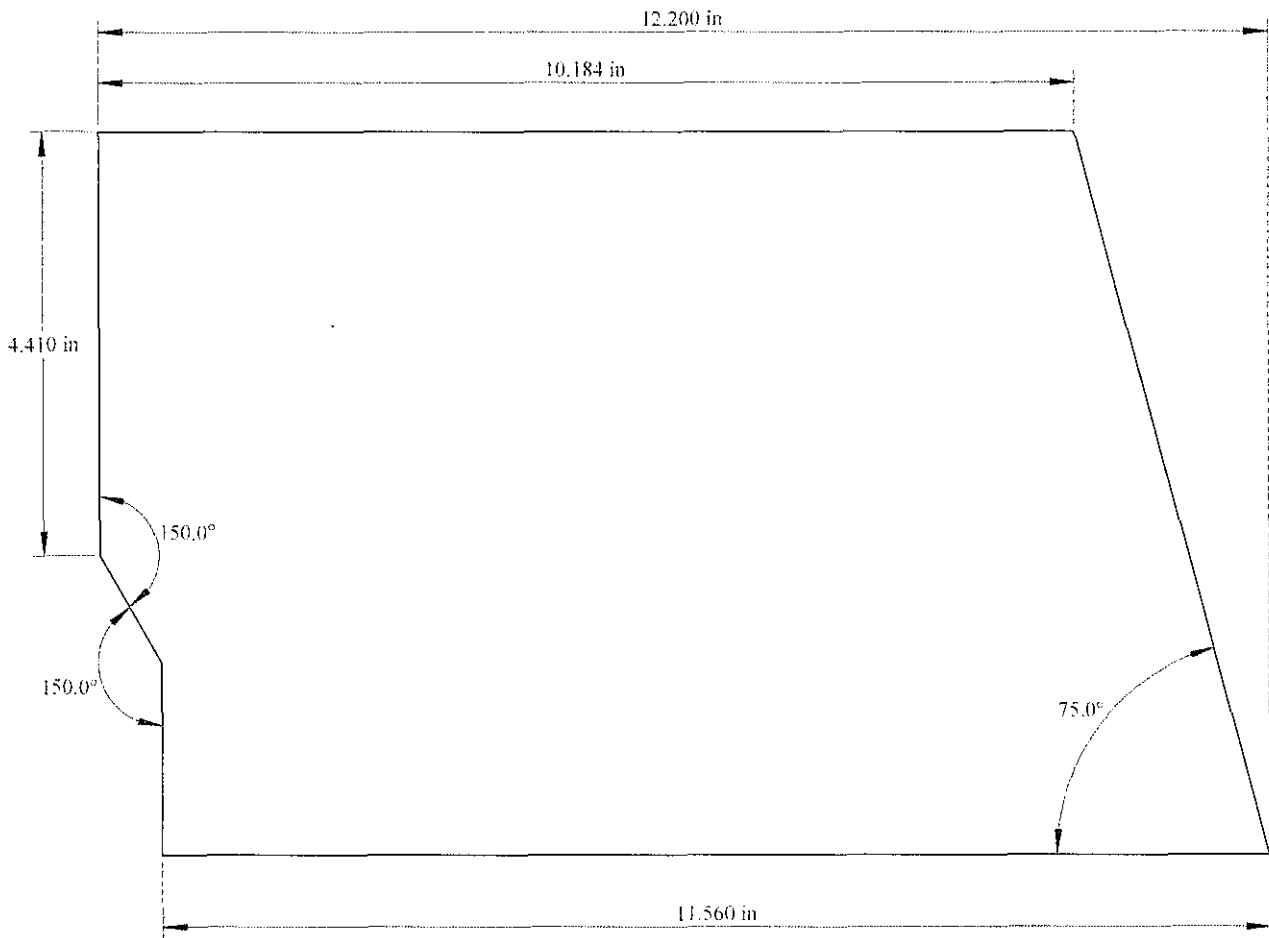

A36 Steel Plate  
5/16" thick  
File: Firebox Sides  
Scale: Half Scale

Component  
7  
Firebox Sides

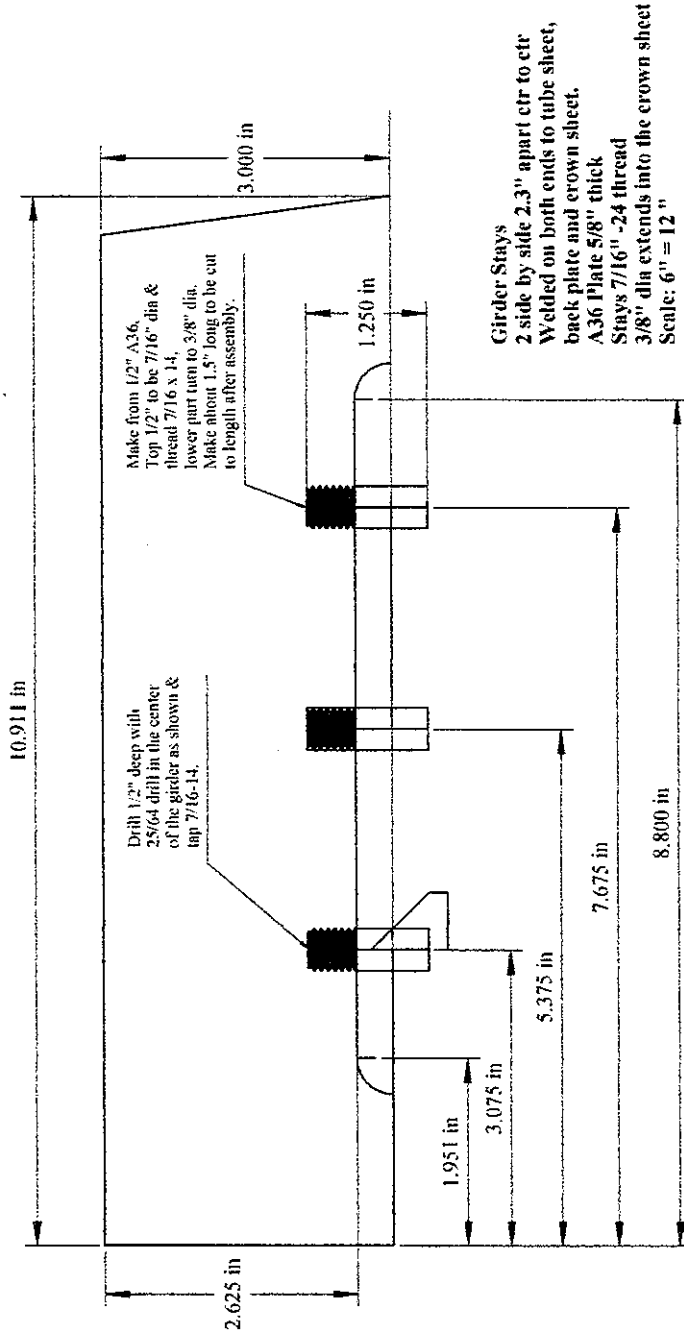

Component

9

Crown Sheet Girder Stays

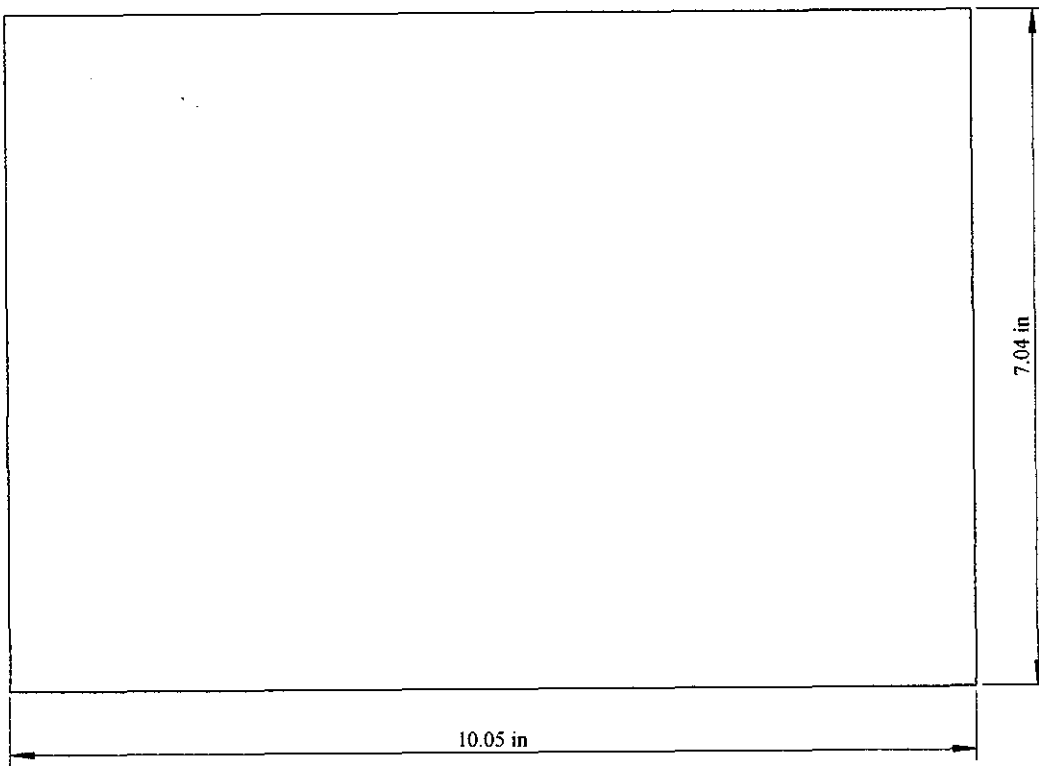

**A36 plate  
3/8" Thick  
Crown Sheet  
Half Scale**

Component  
10  
Crown Sheet



**Mud Ring  
A36 bar  
Side view  
Not to Scale**

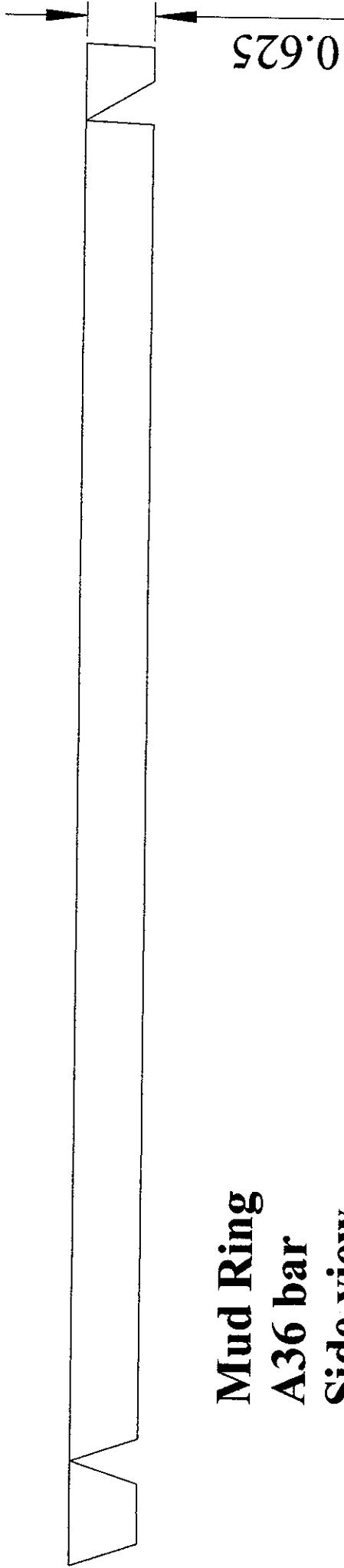

Component  
11  
Mud Ring

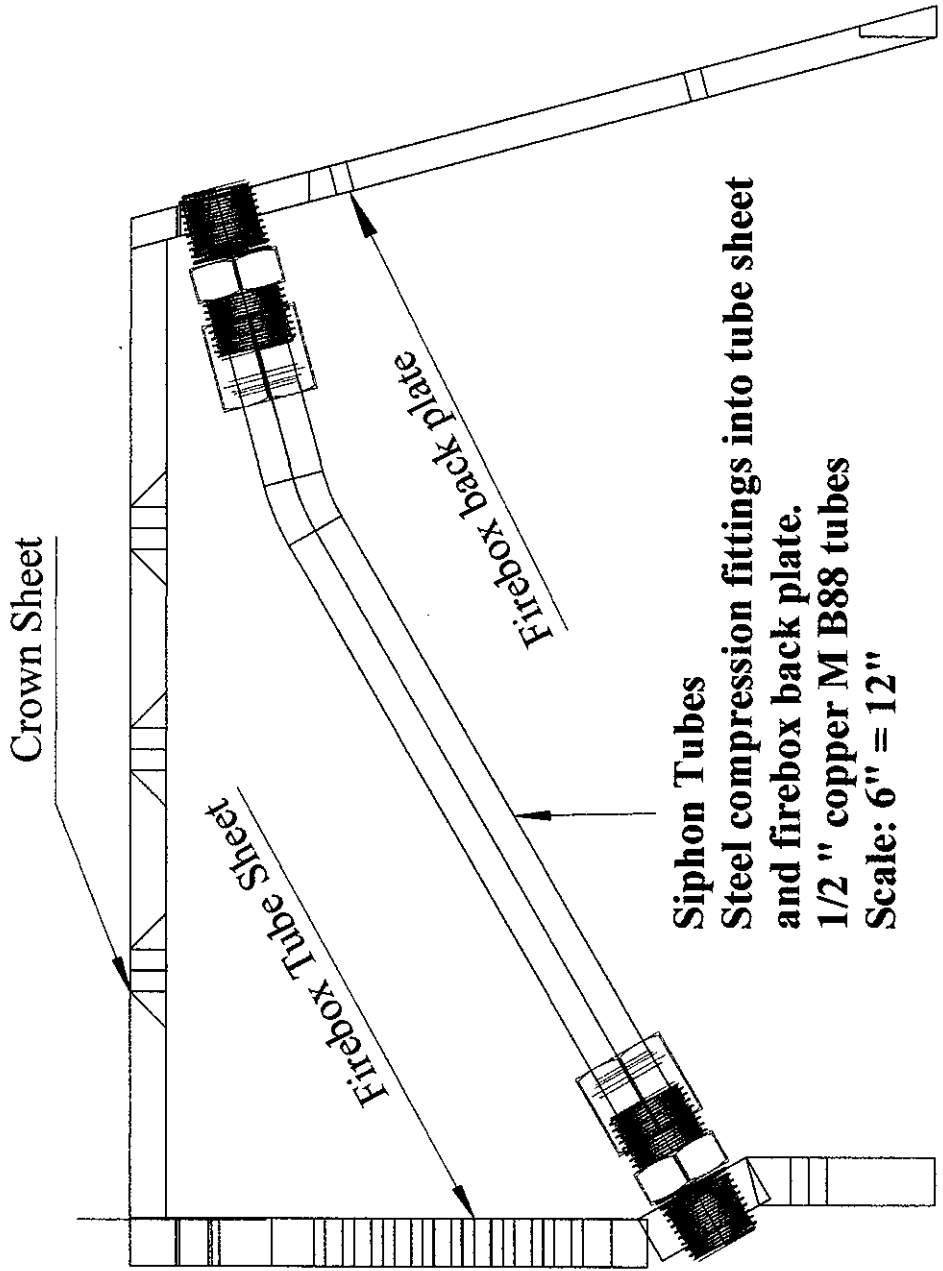

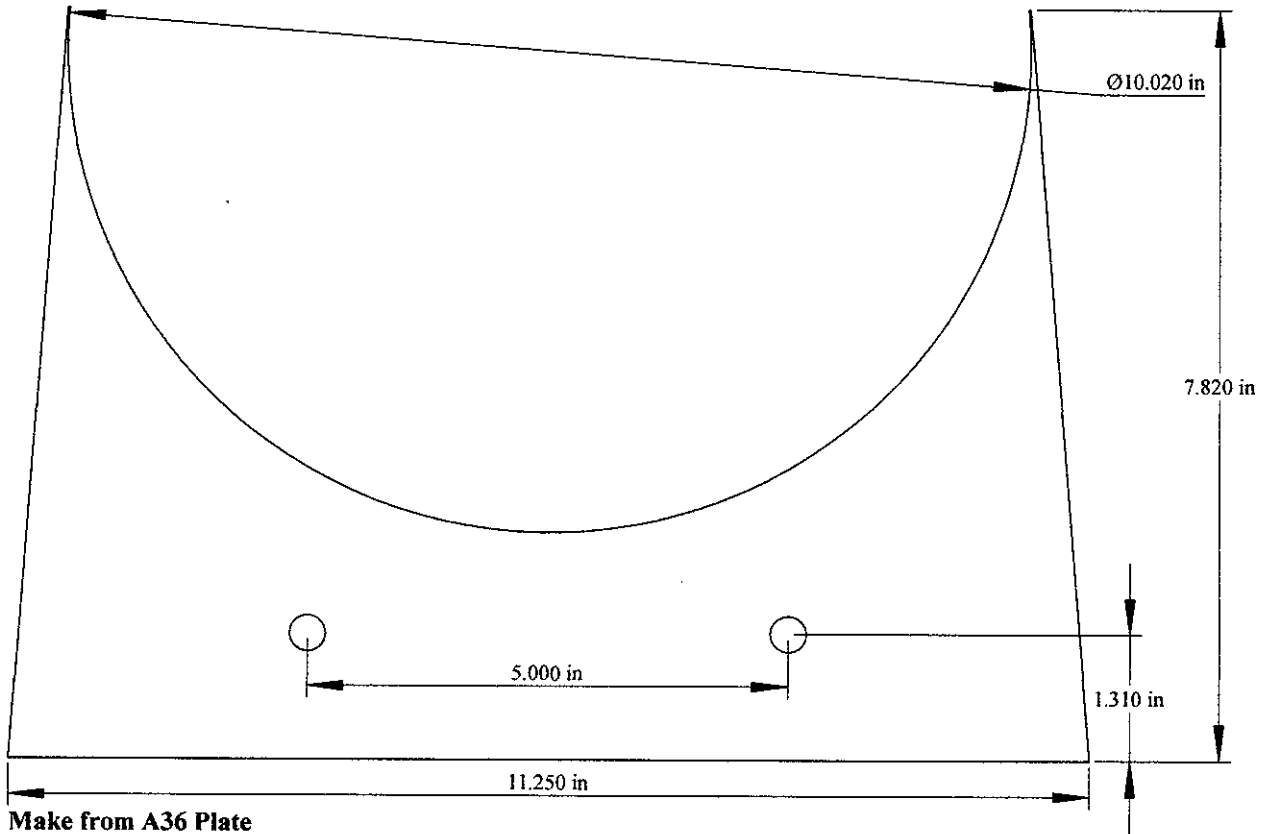

**Make from A36 Plate**  
**5/16" Thick**  
**File: Throat**  
**Scale: Half**

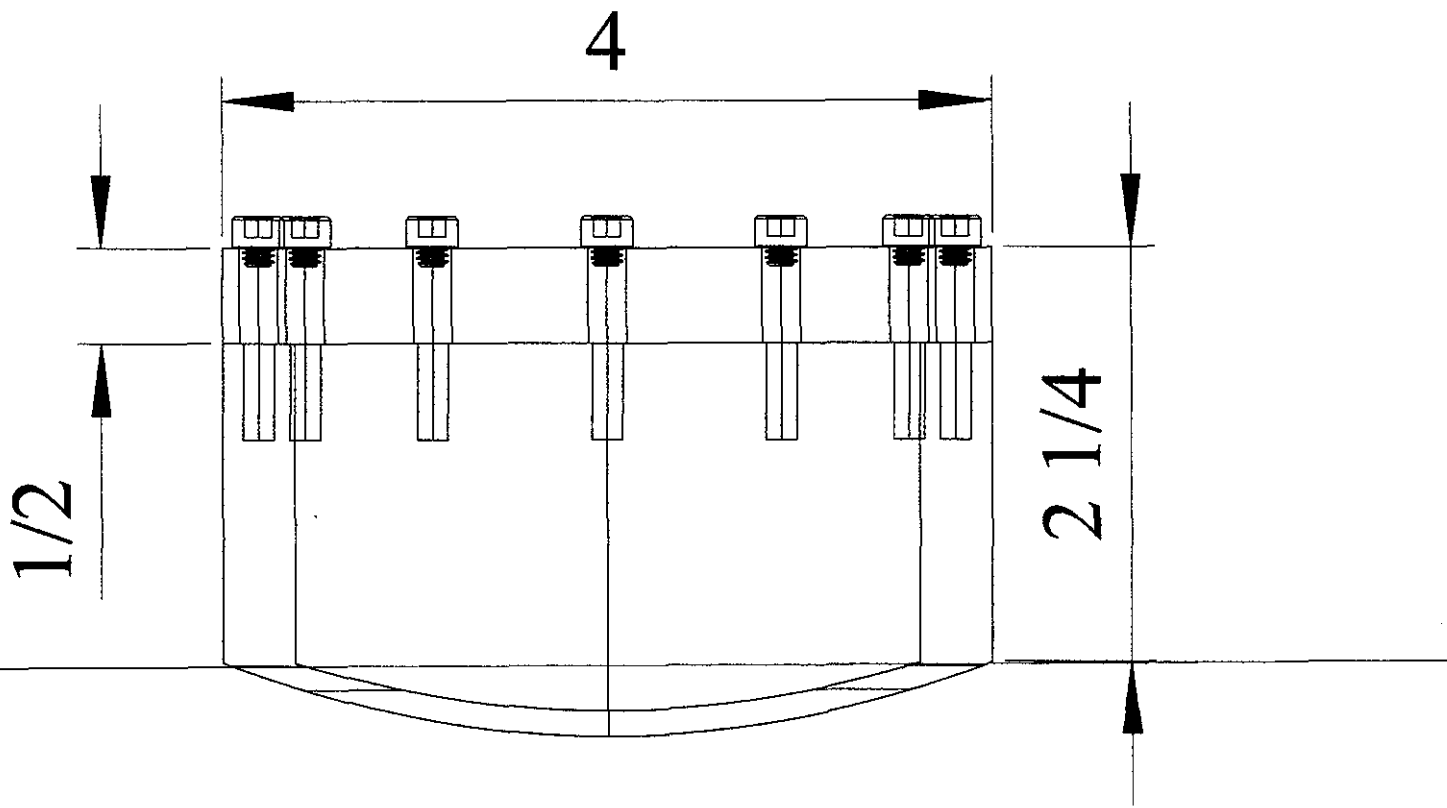

**Steam Dome**  
**4" OD, 3 1/4" ID**  
**Lid: 1/2" A36 steel**  
**Secured with 12 steel bolts**  
**Scale: Full Size**

Make from A36 Plate  
5/16" thick  
File: Firebox back sheet  
Scale: Half Scale

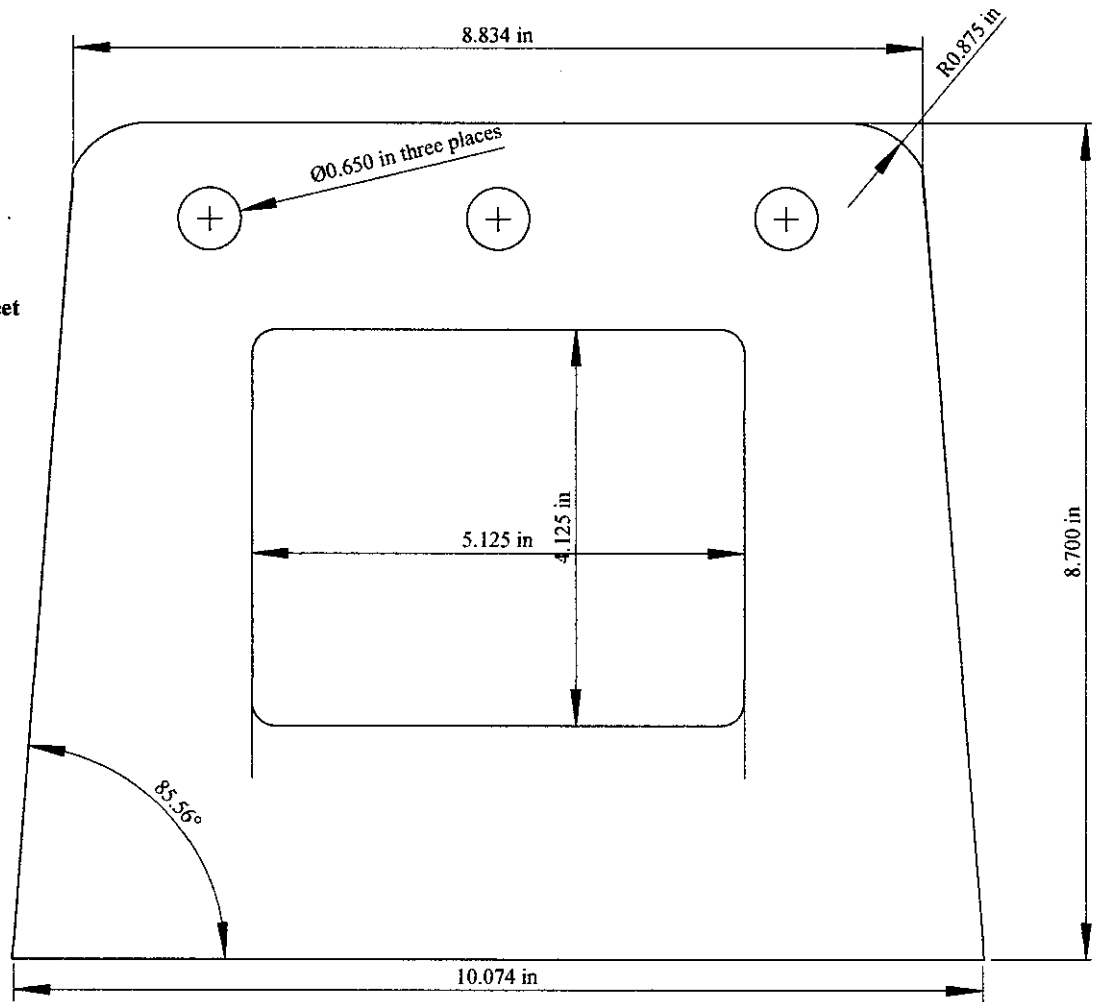

Component  
15  
Firebox Backplate

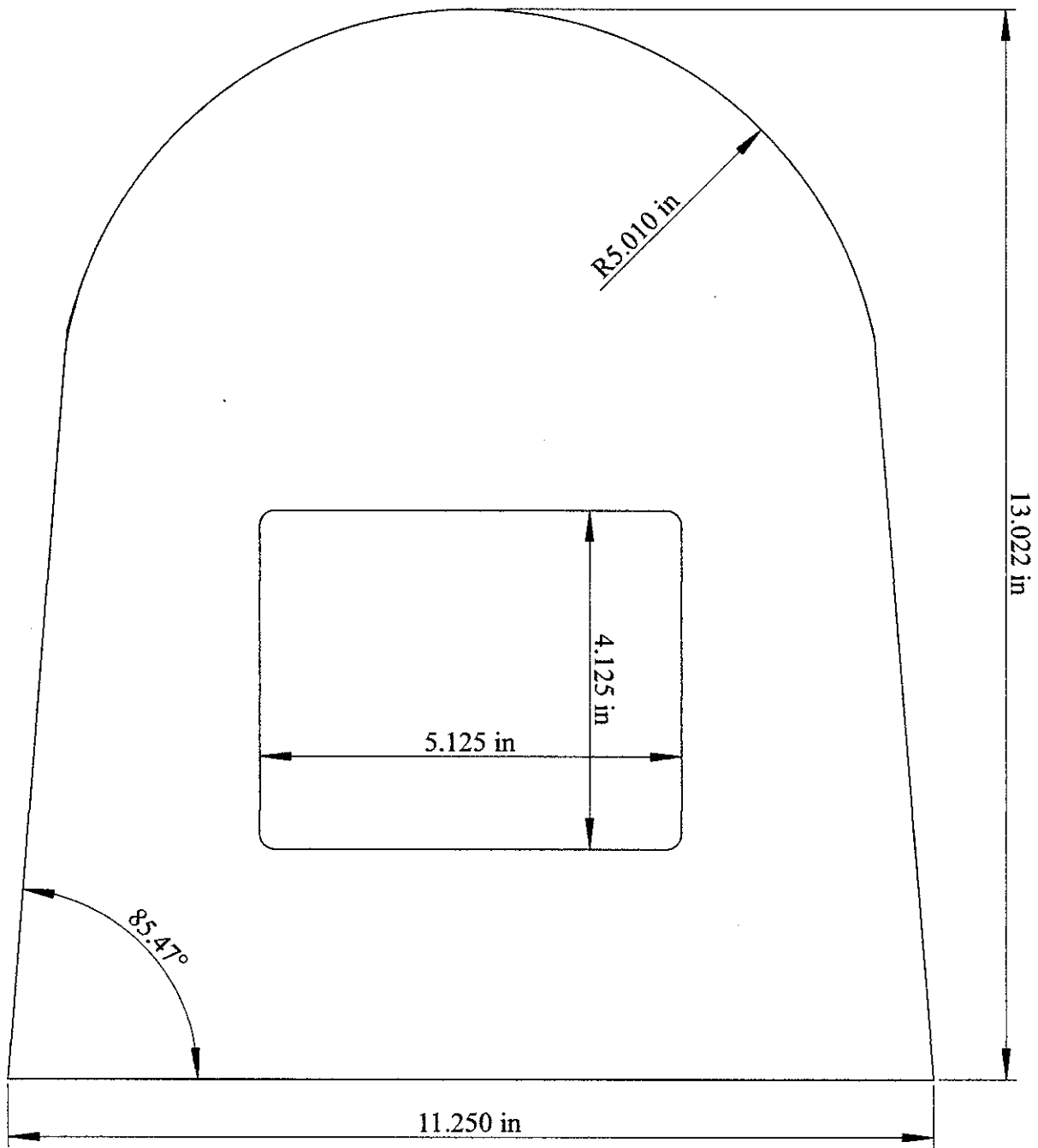

Make from A36 plate 1/2" thick  
File: Backhead  
Scale: Half Scale  
Make one copy  
Ken Olsen 206-718-9401

Component  
16  
Backhead

**OnlineMetals**

1138 West Ewing  
 Seattle, WA 98119  
 Phone: (206) 285-8603 Fax: (206) 285-7836  
 Website: <http://www.onlinemetals.com>

November 12, 2015 8:21:13AM  
 Page 1 of 1

**Order Number: 533646**

**Bill To** Ivy Court  
 6518 44th Ave SW A  
 Seattle, WA 98136

**Ship To** Ivy Court  
 6518 44th Ave SW  
 Unit A  
 Seattle, WA 98136

Customer P.O. #: Paid by visa  
 Contract  
 Sales 1: Web Site  
 Terms: Visa

Sales Order No: 533646  
 F.O.B.: Origin  
 Sales 2:

**Due Date:** 11/12/15  
 Ship Via: OLM Will Call

Ship Pcs	Order Pcs	Description	Length	Weight	Price UM	Extension Tax
1	1	1.5625" EXTRUDED BRASS ROUND C360 H02	11"	6.47	\$41.40 E	\$41.40 T
1	1	0.75" EXTRUDED BRASS HEX C360 H02	36"	5.39	\$40.75 E	\$40.75 T
1	1	0.5" X 0.065" HOT ROLLED MILD STEEL SQUARE TUBE A513	96"	3.08	\$5.66 E	\$5.66 T
1	1	0.5" X 4.5" HOT ROLLED MILD STEEL RECTANGLE A36	11"	7.00	\$10.22 E	\$10.22 T

**Total Weight 21.9404**

*↑  
Steam Dome Cop*

**Subtotal Non taxable**  
**Subtotal taxable \$98.03**  
**Vertex Tax Service : 0.00% \$9.41**  
**Total \$107.44**

**Shipping Instructions:**

**Messages:**

OnlineMetals.com order 1296459.

Inspection prior to processing is recommended and any discrepancies should be reported within 15 days, and prior to on site machining. For information regarding the OnlineMetals return policy, visit <http://www.onlinemetals.com/returns.cfm>.

**OnlineMetals**

1138 West Ewing  
 Seattle, WA 98119  
 Phone: (206) 285-8603 Fax: (206) 285-7836  
 Website: <http://www.onlinemetals.com>

November 24, 2015 8:52:04AM  
 Page 1 of 1

**Order Number: 540636**

Bill To Ivy Court  
 6518 44th Ave SW A  
 Seattle, WA 98136

Ship To Ivy Court  
 6518 44th Ave SW  
 Unit A  
 Seattle, WA 98136

Customer P.O. #: Paid by visa  
 Contract:  
 Sales 1: Web Site  
 Terms: Visa

Sales Order No: 540636  
 F.O.B.: Origin  
 Sales 2:

**Due Date: 11/25/15**  
 Ship Via: OLM Will Call

Ship Pcs	Order Pcs	Description	Length	Weight	Price UM	Extension Tax
1	1	1.75" HOT ROLLED MILD STEEL ROUND A36	12"	8.19	\$17.27 E	\$17.27 T

**Total Weight 8.1930**

**Subtotal Non taxable**  
**Subtotal taxable \$17.27**  
**Vertex Tax Service: 0.00% \$1.66**  
**Total \$18.93**

**Shipping Instructions:**

*Mud Rings*

**Messages:**

OnlineMetals.com order 1305983.

Inspection prior to processing is recommended and any discrepancies should be reported within 15 days, and prior to on site machining. For information regarding the OnlineMetals return policy, visit <http://www.onlinemetals.com/returns.cfm>.



# Specialty METALS

## Quotation

www.specialtymetalscorp.com  
 8300 S. 665<sup>th</sup> Street  
 Kent, WA 98032-1214  
 Phone: 253-872-0000  
 Fax: 253-872-0437

Quote #: Q343876  
 Dsn: 12/28/15  
 Time: 3:29pm  
 Page: 1

Order to: Attn: Ken Olsen  
 KEN / KENNY  
 --Cash Sale--  
 Kent, WA 98032-1214

Order #: KEN / KENNY  
 --Cash Sale--  
 Kent, WA 98032-1214

605196

Quoted to	Telephone	Fax	Salesperson		
Ken Olsen			8 Shelli Brevik		
Terms	FOB Point	Ship Terms			
* COD ** COD *	WC	WILL CALL			
Ln#	Quantity	US Description	Unit Price	Ext Price	Unit Price
Please allow approx 8-9 business days after order placement					
Let me know if you have any questions					
Thank you!					
Shelli					
.....					
..					
1	1.00	EA CARBON FLAT BAR HRFB .50 X 1 SAW 36" BAND SAW CUT TOLERANCE:+/-.125"	20.8200	EA	20.82
2	1.00	EA CARBON FLAT BAR HRFB .50 X .75 SAW 72" BAND SAW CUT TOLERANCE:+/-.125" ** Offering 1/2" x .75" wide ..... ..	26.1100	EA	26.11
3	1.00	EA CARBON ROUND BAR HR A36 3/8" DIA SAW 120" BAND SAW CUT TOLERANCE:+/-.125" ** Continued on Next Page **	20.5000	EA	20.50
				bobtoSal GwigCt CUL CO'LL:	

We appreciate the opportunity to be of service  
 Serving our customers since 1981

# Specialty METALS

## Quotation

www.specialtymetalscorp.com  
 5505 S. 896<sup>th</sup> Street  
 Kent, WA 98032-6666  
 Phone: 253-222-0000  
 Fax: 253-872-0437

Quote D: Q343876  
 Date: 12/28/15  
 Time: 3:29pm  
 Page: 2

**Address:** Attn: Ken Olsen  
 KEN / KENNY  
 --Cash Sale--  
 Kent, WA 98032-1214

**Ship to:** KEN / KENNY  
 --Cash Sale--  
 Kent, WA 98032-1214

605196

Product	Transfer	Fee	Release		
Ken Olsen			Shelli Brevik		
SSS	SSS SSS	Ship Terms			
* COD ** COD *	WC	WILL CALL			
Qty	Unit	Description	Price	UM	Ext Price
4	1.00	EA CARBON PLATE HR 1-1/2" WJQ PER DWG 4" X 5" WATERJET QUALITY CUT TOLERANCE:+/-.020" Per drwg "Firebox opening" ..... ..	141.7500	EA	141.75
5	2.00	EA CARBON PLATE HR 5/8" WJQ PER DWG 3" X 10.911" WATERJET QUALITY CUT TOLERANCE:+/-.020" Per drwg "Gerder Stays" ..... ..	79.4900	EA	158.98
6	1.00	EA CARBON PLATE HR LQ 1/2" WJQ PER DWG 1.962" X 10.07 WATERJET QUALITY CUT TOLERANCE:+/-.020" Per drwg "Firebox tube sheet Middle Plate" ..... ..	38.4900	EA	38.49
** Continued on Next Page **					
				<b>Subtotal:</b> <b>Amount:</b> <b>Tax:</b> <b>TOTAL:</b>	

# Specialty METALS

## Quotation

www.specialtymetalscorp.com  
 8300 S. 206<sup>th</sup> Street  
 Kent, WA 98032-1214  
 Phone : 050-000-000F  
 Fax : 253-872-0437

Quote #: Q343876  
 Date: 12/28/15  
 Time: 3:29pm  
 Page: 3

Order Attn: Ken Olsen  
 KEN / KENNY  
 --Cash Sale--  
 Kent, WA 98032-1214

Ship to: KEN / KENNY  
 --Cash Sale--  
 Kent, WA 98032-1214

605196

Quote to	Telephone	Fax	Salesperson			
Ken Olsen			Shelli Brevik			
Terms	FOB Point	Ship Terms				
* COD ** COD *	WC	WILL CALL				
Ln#	Quantity	UM	Description	Unit Price	UM	Extended Price
7	✓ 1.00	EA	CARBON PLATE HR LQ 1/2" WJQ PER DWG 9.895" X 9.895 WATERJET QUALITY CUT TOLERANCE:+/-.020" Per drwg "Front Tube Sheet" ..... ..	105.3600	EA	105.36
8	✓ 1.00	EA	CARBON PLATE HR LQ 1/2" WJQ PER DWG 11.25" X 13.02 WATERJET QUALITY CUT TOLERANCE:+/-.020" Per drwg "Backhead" ..... ..	85.0900	EA	85.09
9	✓ 1.00	EA	CARBON PLATE HR LQ 1/2" WJQ PER DWG 5.285" X 9.587 WATERJET QUALITY CUT TOLERANCE:+/-.020" Per drwg "Firebox Tube sheet" ..... ..	148.3600	EA	148.36
** Continued on Next Page **						
				FoFfof-I: Faigh: āa: ũũũũ:		

# Specialty METALS

## Quotation

www.specialtymetalscorp.com  
 8300 S. 206<sup>th</sup> Street  
 Kent, WA 98032-1214  
 Phone : 253-872-8000  
 Fax : 253-872-0437

Quote #: Q343876  
 Date: 12/28/15  
 Time: 3:29pm  
 Page: 4

Quoted to: Attn: Ken Olsen  
 KEN / KENNY  
 --Cash Sale--  
 Kent, WA 98032-1214

Ship to: KEN / KENNY  
 --Cash Sale--  
 Kent, WA 98032-1214

605196

Quoted to	Telephone	Fax	Salesperson			
Ken Olsen			8 Shelli Brevik			
Terms	FOB Point	Ship Terms				
* COD ** COD *	WC	WILL CALL				
Ln#	Quantity	UM	Description	Unit Price	UM	Extended Price
10	✓ 1.00	EA	CARBON PLATE HR LQ 3/8 WJQ PER DWG 7.04" X 10.05" WATERJET QUALITY CUT TOLERANCE:+/-.020" Per drwg "Crown sheet" ..... ..	92.8800	EA	92.88
11	✓ 2.00	EA	CARBON PLATE HR LQ 5/16" WJQ PER DWG 7.5" X 12.2" WATERJET QUALITY CUT TOLERANCE:+/-.020" Per drwg "Firebox sides" ..... ..	49.7500	EA	99.50
12	✓ 2.00	EA	CARBON PLATE HR LQ 5/16" WJQ PER DWG 7.808" X 15" WATERJET QUALITY CUT TOLERANCE: +/- .020" Per drwg "Firebox legs" ..... ..	48.2500	EA	96.50
** Continued on Next Page **						
						<b>Subtotal:</b> <b>Freight:</b> <b>Tax:</b> <b>TOTAL:</b>

We appreciate the opportunity to be of service  
 Serving our customers since 1981.

# Specialty METALS

## Quotation

www.specialtymetalscorp.com  
 8300 S. 206<sup>th</sup> Street  
 Kent, WA 98032-1214  
 Phone : 253-872-8000  
 Fax : 253-872-0437

Quote #: Q343876  
 Date: 12/28/15  
 Time: 3:29pm  
 Page: 5

**Sold to:** Attn: Ken Olsen  
 KEN / KENNY  
 --Cash Sale--  
 Kent, WA 98032-1214

**Printed by:** KEN / KENNY  
 --Cash Sale--  
 Kent, WA 98032-1214

605196

Quoted to	Telephone	Fax	Salesperson			
Ken Olsen			Shelli Brevik			
Terms	FOB Point	Ship Terms				
* COD ** COD *	WC	WILL CALL				
Ln#	Quantity	UM	Description	Unit Price	UM	Extended Price
13	1.00	EA	CARBON PLATE HR LQ 5/16" WJQ PER DWG 7.82" X 11.25" WATERJET QUALITY CUT TOLERANCE:+/-.020" Per drwg "Throat" ..... ..	71.8500	EA	71.85
14	1.00	EA	CARBON PLATE HR LQ 5/16" WJQ PER DWG 8.7" X 10.074" WATERJET QUALITY CUT TOLERANCE:+/-.020" Per drwg "Firebox back sheet" ..... ..	66.8500	EA	66.85
All prices are Price in Effect at time of order placement and subject to stock availability.				<b>Subtotal:</b>		1173.04
				<b>Freight:</b>		0.00
				<b>9.500% Tax:</b>		111.44
				<b>TOTAL:</b>		1284.48

We appreciate the opportunity to be of service  
 Serving our customers since 1981

BALLARD INDUSTRIAL  
 PO Box 70585  
 Seattle WA 98127-0585

4749 Ballard Ave NW  
 Seattle WA 98107  
 206-783-6626 FAX 206-782-4181  
 www.ballardindustrial.com



# Cash Sales Invoice

**Invoice No** 431875  
**Invoice Date** 12/07/2015  
**Customer** CASH99  
**Customer PO** KENNETH OLSEN  
**Created By** Drew Dolhanyk  
**Cust. Contact**  
**Shipping Terms** Prepaid

**Invoice Address:**

CASH SALE  
 CASH SALE  
 BALLARD INDUSTRIAL

**Delivery Address:**

Kenneth Olsen  
 BALLARD INDUSTRIAL

From Order# 4033650 Order Date: 12/07/2015 Page 1 of 1

Header Notes									
Line	Item - Description	Qty Ord	Qty B/Ord	Qty Ship /UOM	Price	UOM	Sub-Total	Svc / Frt	Total
1	PIP-CKH-00G-00K - TUBE COPPER TYPE K HARD 1/2" X 5/8 OD  please cut 32 pcs @ 36-1/2 in	97.33	0	97.33 /FT	4.58	FT	\$445.77		445.77 T
2	PIP-CKH-010-014 - TUBE COPPER TYPE K HARD 1" X 1-1/8 OD  please cut 5 pcs @ 36-1/2 in	15.21	0	15.21 /FT	10.73	FT	\$163.20		163.20 T

PAID

**Payments**

Date/Time: 12/07/2015 12:53  
 Shift4 Invoice Number: 125415  
 Card Type: Visa  
 Card Number: \*\*\*\*\*1561  
 Amount: 667.43  
 Authorization Code: 075643

Goods received in good condition  
 Signature \_\_\_\_\_

RETURN POLICY		Total Amount	\$608.97
NO RETURNS ON CUT / SPECIAL ORDERS. PURCHASES MUST BE RETURNED WITHIN 60 DAYS. RECEIPT MUST ACCOMPANY ALL RETURNS. ALL RETURNS SUBJECT TO RETURN CHARGE. Refunds: Cash Sales under \$50.00 refunded by cash immediately. Cash Sales over \$50.00 refunded by Check. Sales paid by Check refunded by Check after 14 days. Bankcard sales refunded on Bankcard only.		Sales Tax	\$58.46
		Invoice Total	\$667.43
		Balance Due	\$0.00

