

# WIMS WORLD

University of Michigan

Michigan State University

Michigan Technological University

## Director's Message



A few weeks ago, my wife enlisted my aid in creating some puzzles for our youngest grandchildren. The idea was to take family pictures from our vacation this summer, glue them onto boards, and then cut them out to form simple puzzles. My job was to cut the puzzle pieces out on the jig saw. Leaving nothing to chance, there was even a template for where to cut. But when I tried to transfer the template to the picture, it was hard to see the lines and harder still to cut along them. And when I did, I discovered that the pieces were not interlocking so that the puzzle kept falling apart. It turned out to be a lot easier, and better, to cut the pieces out freeform, making interlocking patterns up as I went.

That experience with the puzzle came to mind the other day as I thought about the Center and the challenges of system integration. As we enter the seventh year of our Center, the time remaining in which to accomplish our goals is now starting to look all too short. And that, of course, prompts the question of just what we do want to accomplish. What lasting legacies do we want to leave? Certainly, there will be important efforts in K-12 education and a whole new series of new courses at the college level. Certainly, there will be many doctoral students trained and papers produced. And certainly there will also be seminal contributions to setting directions for WIMS as it continues to expand as a worldwide imperative. But most of all, I think the really key research contributions are certain to come from our testbeds. Both the neural and the environmental testbeds were unique, or nearly unique, to Michigan when we started. Today, both are worldwide efforts. We chose them well. But if we are to claim real success as a Center, we must complete the realization of these microsystems and put them on the road to becoming products that will fulfill our vision for improved health care and environmental quality. And doing that will not be easy.

Testbeds are at the heart of what ERCs are all about—interdisciplinary teamwork and system integration. But these run counter to the nature of academia, which is still tightly geared to individual accomplishment. Too often that leads to the creation of fiefdoms, which are probably the antithesis of teamwork and system integration. System integration is all about being able to see the big picture. It is what our industrial members most often cite as the thing they like the best about our students. But instilling that system view, so necessary in industry,—that willingness to set aside one's own work in order to help on the bigger goal—is counterculture in academia. Too often it is viewed as an unwelcome diversion away from

achieving the depth required to produce the “contribution to knowledge” expected in a doctoral thesis. Successful system integration is also hard because it requires staff to maintain continuity in the face of student graduations and departures. But by realizing complete systems, we not only train our students in skills that will be invaluable, we also make impact that can be made no other way. And we set the stage for commercialization. So as we move toward “graduation,” it is critically important that we find more secure ways of supporting our staff so we can continue to work at the system level and that we inspire our faculty, staff, and students with a vision of what is possible so that they want to do it.

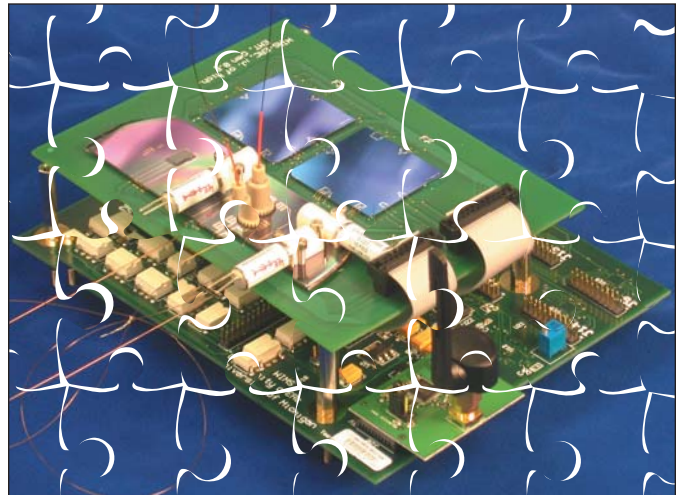

It's a little like the puzzle. The whole thing can't succeed unless we have all of the pieces (faculty, staff, students, and research results) and that they all fit into place. And it won't succeed unless the pieces interlock (are mutually dependent). But we can't over legislate the template, either. There must still be room to innovate and the flexibility to rapidly incorporate new advances. It can't just become a development effort. Somewhere there is a successful balance where doctoral research and prototype development blend into a really wonderful training ground for people. And we're going to find it! ■

*Ken D. Wise*

Director, Engineering Research Center for  
Wireless Integrated MicroSystems

## Research Highlights

### An Interface Chip for Power and Bidirectional Data Telemetry in an Implantable Cochlear Microsystem

Amir M. Sodagar, Kensall D. Wise, and Khalil Najafi

A wireless interface chip has been designed and fabricated for a cochlear implant that receives power, data, and clock through an inductive link and in turn transmits neural-response and position information prepared by the system to the external setup. The forward telemetry front-end of the chip is composed of a multi-output power regulator, wideband frequency shift keying (FSK) data demodulator, and clock recovery circuit. The reverse telemetry back-end consists of a Manchester encoder, an on-off keying modulator, and an antenna driver. A data packet checker is also employed to check the format and contents (parity) of the received data. A power-on reset block is also considered on the chip, which generates a short reset pulse upon the establishment of the power supplies. Carrier frequency for the forward telemetry link is 8MHz, and the data can be transferred at a rate of up to 2Mbps. The reverse telemetry link has a programmable carrier frequency adjustable within the range of 80MHz–190MHz. Bit rate for the outgoing data is 2Mbps also. The chip has been fabricated in 1.5 $\mu$ m CMOS technology and measures 4.6mm x 4.6mm. ■

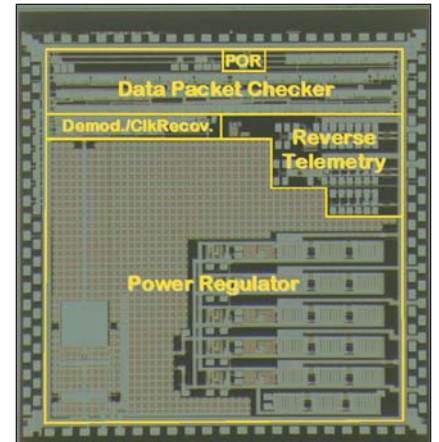

Six components of the chip.

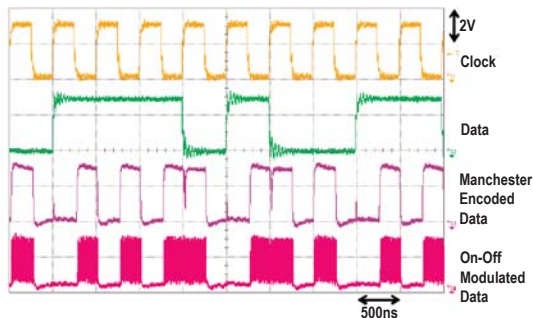

Samples of experimental results.



### A Hybrid Thermo-Pneumatic and Electrostatic Microvalve With Closed-Loop Position Sensing

Joseph Potkay and Kensall D. Wise

The WIMS ERC has successfully fabricated a low-power, hybrid thermo-pneumatic and electrostatic microvalve that enables pressure programming of the WIMS micro gas chromatograph ( $\mu$ GC) columns; it is believed to be the first device of its kind. To close the device, an elevated heater grid energizes a working fluid, raising the pressure in the cavity and deflecting a corrugated diaphragm and valve seat. The heater is suspended in order to increase its heating efficiency, and the corrugations serve to decrease the spring constant of the diaphragm, permitting valve travel greater than 35 $\mu$ m. The capacitive pressure sensor reads out the cavity pressure and valve seat position and provides feedback to determine when to enable the electrostatic actuator. Once latched, the power to the heater can be reduced or eliminated. The 7.5mm x 10.3mm valve has an open flow rate of 8sccm at 4.6Torr, a leak rate of  $1.3 \times 10^{-3}$ sccm at 860Torr, an actuation time of 430ms, and a required hold power of 60mW while closed. In addition, to open the valve requires no power, whereas an energy of 108mJ is needed to close it. With minor improvements, the valve requires 35mJ to close in 140ms, a hold power of 6mW without the electrostatic latch, and no hold power with an electrostatic voltage of 180V. Lastly, it has a built-in position sensor with a sensitivity of 1.3fF/Torr. ■

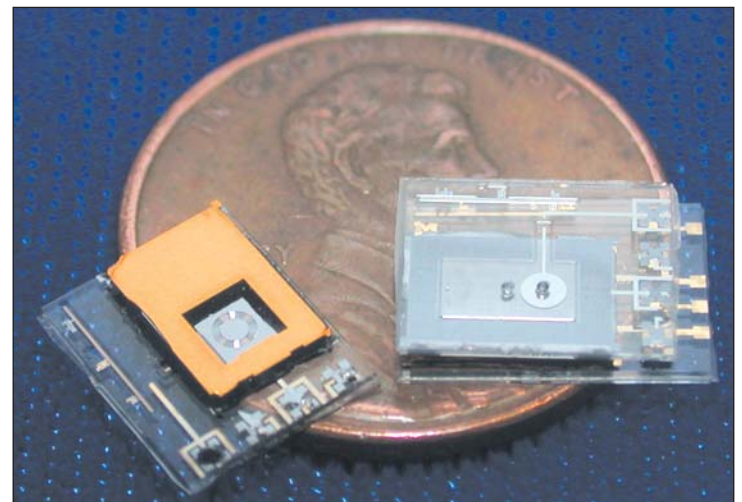

The bottom (left) and top (right) of the hybrid microvalve.

## Narada: A Low-Cost Wireless Sensor for Monitoring and Control

R. Andrew Swartz, Michael P. Flynn, and Jerome P. Lynch

A new wireless sensor platform, termed Narada, has been both designed and deployed by WIMS ERC researchers for a variety of monitoring and control applications. Designed from commercial off-the-shelf components, Narada offers multi-channel sensor and actuator interfaces (Figure 1). The internal 16-bit, analog-to-digital converter can simultaneously collect sensor data from four channels at rates as high as 100kHz. A two-channel, 12-bit, digital-to-analog converter provides the wireless sensor with the capability to output voltage signals from 0V to 4V to actuators. The low-power, 8-bit Atmel ATmega128 micro-controller has been selected as the wireless sensor's computational core. To facilitate interoperability with commercial wireless sensor nodes (e.g., Crossbow Motes) using the IEEE 802.15.4 wireless sensor protocol stack, the Chipcon CC2420 wireless transceiver is integrated into the Narada platform. Lastly, a multi-thread operating system has been embedded in the wireless sensor core, featuring a complete implementation of the IEEE 802.15.4 physical and medium access control protocol layers.

To validate the functionality of Narada, Center researchers installed a multi-node wireless sensor network in collaboration with researchers from the National Center for Research on Earthquake Engineering (NCREE), Taipei, Taiwan, in July 2006, in a 3-story test structure (Figure 2). Adjustable MR dampers were installed as actuators capable of controlling the dynamic response of the structure during simulated earthquake loading. The wireless sensors were responsible for measurement of story velocities (using velocity meters), transmission of response data, calculation of control forces (using embedded Kalman filters and optimal control algorithms), and distribution of command signals to the dampers in real-time (using a 50Hz sample rate). This is the first-ever, full-scale implementation of a wireless structural control system applied to civil engineering structures for seismic protection. ■

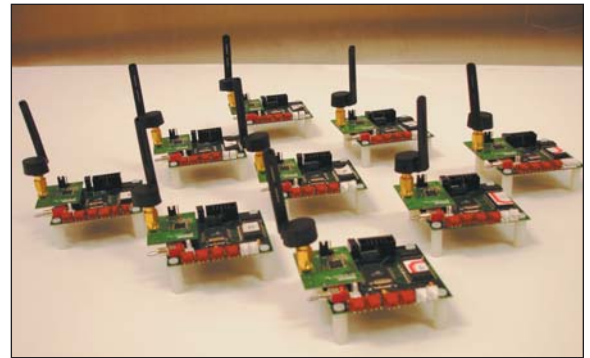

Figure 1 – Fully functional Narada wireless sensor network.

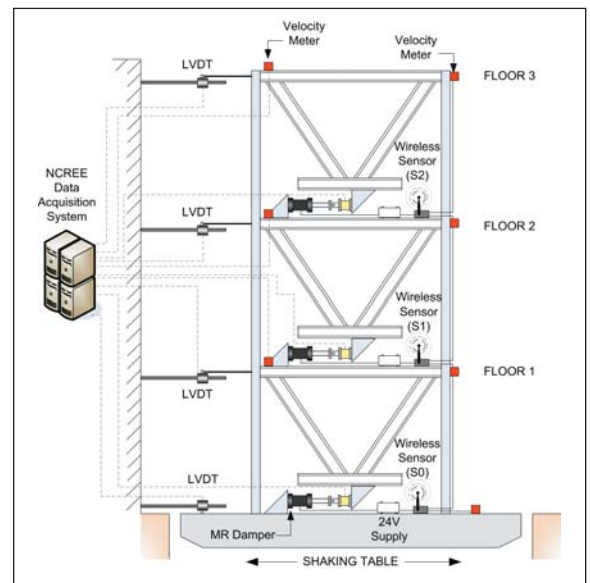
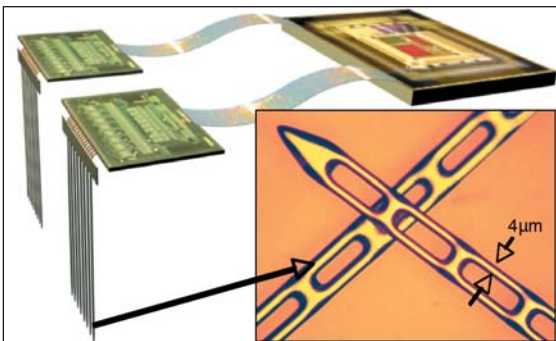

Figure 2 – Application of Narada wireless sensors to a structural control system.

## Special Feature

### NIH/NIBIB Funds New Center

The National Institute of Biomedical Imaging and Bioengineering recently announced funding for the Center for Neural Communication Technologies (CNCT) at the University of Michigan. The new Center, directed by Professor Daryl Kipke (U of M-BME), will begin in September 2006, continuing until at least September 2011. It will address areas critical to achieving the goals of the WIMS ERC in biomedical sensors and subsystems. An earlier CNCT (1994–2004), based on Michigan's development of multi-channel neural probes, facilitated the transfer of 7500 devices to the neuroscience community, beginning a revolution in understanding neural structures. The new Center will focus on solving the problems associated with long-term probe-tissue interfaces and on developing fluidic devices for chemical sensing and drug delivery. When probes are implanted in tissue, they are slowly encapsulated, degrading their recording performance. Micromotion may also lead to cell loss. Shrinking probe widths to cellular dimensions and keeping the structures open to allow tissue regrowth through them is one strategy being used to address these problems. ■



New WIMS ERC probe designs being driven by the need for long-term tissue-compatible interfaces.

## Education Highlights

### LSAMP REU Program for Summer 2006

Five undergraduate students were hosted at the WIMS ERC for summer 2006 to participate in the Louis Stokes Alliance for Minority Participation (LSAMP) Research Experiences for Undergraduates (REU) program. The program started with student arrivals and an opening reception on May 31 and ended with a closing symposium and student departures on August 12.

The LSAMP REU is structured with the primary goal that each student will have a research project closely linked to the Center's research thrusts, working directly with an advanced graduate student (in meaningful daily contacts) under the direction of a WIMS ERC faculty member. In addition, the program comprises several secondary components. The first secondary component is a technical communication course with classroom instruction, writing assignments, and oral presentations to support the research experience of the student. Highlights of the communication component are project descriptions at the start of the summer, progress reports, and final reports with a closing symposium that allows each student to make an oral presentation of his/her summer research project and achieved results. An additional secondary component encompasses both professional ethics and LSAMP information. The ethics sessions involve presentations on principles for ethical analysis, codes of conduct, and practical dilemmas, followed by discussions among the students and presenter. The LSAMP information includes the historical development and growth of LSAMPs since their start in 1991, notable contributions by racial and ethnic celebrities, the

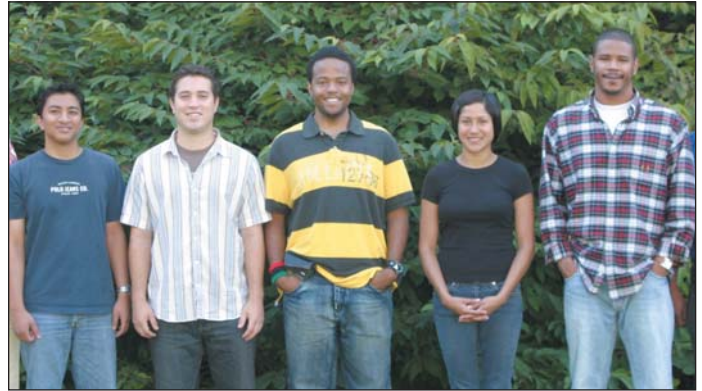

**2006 LSAMP REU Students.**

current status of LSAMP alliances, and opportunities for LSAMP students. Graduate study is yet another secondary component, with the students learning about the graduate study process, such as graduate schools in the student's area of interest; admission application procedures and required exams; financial aid available at the department, university, and national level; and associated financial aid applications. The summer program's ancillary activities include tours of labs and facilities at Michigan State University and the University of Michigan, as well as a visit to the Henry Ford Museum. The Summer 2006 program ended with a celebratory social activity of dinner, putt-putt golf, and ice cream. ■

### Girls Find Fun in Science and Math at the Sally Ride Festival

Since 2002, the University of Michigan has participated in the Sally Ride Festival honoring the first American female astronaut in space. This event encourages girls from 5th through 8th grades to become interested in science and math, beginning with a street fair with hands-on activities, booths, food, and music. Next comes an inspiring talk by a woman astronaut, followed by workshops for girls, parents, and educators. The WIMS ERC set up two hands-on displays at the street fair that highlighted many WIMS educational activities that are available to girls of pre-college age. In one display, MSU students highlighted a drag-race timer, electronic thermometer, and search-and-rescue robot, each designed to help middle and high school students put theory into practice. Also explained were the WIMS Summer Programs available for pre-college students at the MSU campus. The other display was used to explain the advances made for the profoundly deaf by demonstrating a "Name That Tune" game that allowed the girls to identify a song under extreme limited hearing conditions. Each display was well attended, and the girls left with a greater desire to be part of the exciting fields of science and math. ■



**An MSU student demonstrates that "science can be fun" when taught using WIMS technology to build a drag-race timer, an electronic thermometer, and a search-and-rescue robot.**



**Young girls and parents encounter the differences between normal hearing and impaired hearing of those who are profoundly deaf. The WIMS ERC is minimizing that difference with state-of-the-art technology.**

## Dean Aslam Shows Off His Innovations in Education and Research at Harvard, Princeton, and MIT



Dean Aslam recently presented his LEGO-, robot- and micro-controller-based learning modules at Harvard, Princeton, and MIT. His research on micro- and nanotechnologies in the past ten years has resulted in unique modules that focus on three layers of learning for microsystems: fundamental science, enabling technologies, and complete systems. For example, LEGOs are used to explain the fabrication process and operation of (a) nano-structures and -transistors, (b) sensors and actuators, (c) wireless devices, and (d) cochlear implant probes.

### COMPLETE SYSTEMS

### FUNDAMENTAL SCIENCE



The researchers at Harvard, Princeton, and MIT were very impressed with the modules that Professor Aslam now uses in the K-12 classroom, as well as in undergraduate and graduate teaching at MSU. Referring to nanotechnology modules, Dr. Philip Sadler, Head of Science Education at Harvard, offers this praise: "It was intriguing to see how you approached conveying the concepts and processes of this burgeoning field using simple activities and models. I found your use of LEGOs to be especially riveting. Taking such a familiar, everyday item and putting it to a new use is particularly impressive. I learned a tremendous amount from your visit and see great potential in your methods and ideas." Similarly, Dr. Dan Steinberg, Director of Education and Outreach at Princeton University, responds positively: "I am very impressed with the LEGO modules on nanofabrication. I haven't seen anything like that anywhere else."

Nanobrick LLC, a new company, was launched on September 21, 2006, to commercialize Dean Aslam's inventions. Nanobrick plans to offer short courses and to market low-cost learning toys and learning modules in the first phase of its business plan. ■

## Personnel Focus



**Nayda Santiago** believes in bridging the gap between research and education. This will prepare undergraduate students with invaluable skills for the future. Since she started teaching at the University of Puerto Rico, Mayagüez Campus, she has been engaged in working with undergraduate research to provide students with problem-solving, communication, and critical-thinking skills. According to Richard M. Felder, a well-known researcher and educator from North Carolina University, these are some of the fundamental education and career skills students in engineering need.

This past semester, Nayda had 21 undergraduate students working in three different research projects: Cochlear Implant, Micro Gas Chromatograph, and Visual Terrain Explorer (VTE).

The first two projects are both WIMS related, while the last one is part of the Wide Area Large Scale Automated Information Processing Project (WALSAIP). In the cochlear implant project, ten undergraduate students are developing the code for the board developed jointly by the University of Michigan and University of Utah to demonstrate the units developed for the WIMS cochlear implant. In the MicroGC project, six students are undertaking a similar task on the WIMS micro gas chromatograph. Students have low-power and memory constraints in the design of the code in both projects.

The last undergraduate research project is the development of a new module for VTE, for the WALSAIP grant. VTE is a java-based application for the integrated visualization of geographic information, sensor data, and elevation from multiple sources, designed with three main goals: portable, modular, and extensible.

Nayda is part of the Computing Alliance for Hispanic Serving Institutions (CahSI) where she provides seminars to students to develop undergraduate research skills. Nayda has been working with WIMS Center since Spring 2004. To contact Nayda, please send email to: [Nayda.Santiago@ece.uprm.edu](mailto:Nayda.Santiago@ece.uprm.edu). ■

## Faculty/Student Awards



Professor **Scott A. Mahlke** received an unusual award at the ACM SIGARCH (Special Interest Group on Computer Architecture)/IEEE-CS TCCA (Technical Committee on Computer Architecture) Influential ISCA (International Symposium on Computer Architecture) Paper Award at ISCA 2006.

In short, this award recognizes a single, seminal paper from the ISCA Proceedings fifteen years earlier that has had the most impact on computer architecture. The award was for the paper, "IMPACT: An Architectural Framework for Multiple-Instruction-Issue Processors," by Pohua P. Chang, Scott A. Mahlke, William Y. Chen, Nancy J. Warter, and Wen-mei W. Hwum, from Proceedings of the 18th Annual International Symposium on Computer Architecture, pp. 266–275, May 1991. It was Mahlke's first paper as a graduate student.

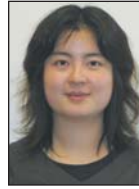

**Jianbai (Jenn) Wang** was awarded the 2005 Roger A. Haken Best Student Paper award, which will be presented to her on December 11, 2006, at the Plenary Session of the 2006 International Electron Devices Meeting (IEDM). Her paper is entitled "An Integrated Position-Sensing System for a MEMS-Based Cochlear Implant."



Shown above is the team of Mr. James Griffin, **Professor Gary L. Harris**, Dr. O'Neil Biscentte, and **O'tega Ejofodomi** (graduate student) whose work was performed at Howard Nanoscale Science and Engineering Facility (HNF). Dr. O'Neil Biscentte holds the award he received at the National Medical Association Convention, Georges C. Benjamin, MD Resident Research Forum, for Best Resident Presentation entitled "GaAs/GaAlAs Prosthetic Retina."

## Industrial Liaison's Report



As we go into a new school year, I am thinking of the students we have just graduated and those who are scheduled to soon graduate. These students are starting out on high-tech careers, but are they going to be able to keep us in the forefront of innovation? Not by themselves, for sure. We need to encourage more students to enter into engineering and science careers if we want to maintain a society that produces innovation. A number of programs, certainly not enough, are addressing the issue of insufficient technical students. However, even fewer resources are being allocated toward ensuring that our engineers add value to industry and society. Technical literacy and proficiency are spreading across the globe. Many universities are offering the same courses to teach their students, with the results that an ever increasing number of engineers are available. How are we to maintain a premium for our engineers and thereby ensure that our best and brightest will look at engineering as a rewarding career? I believe that we need to train engineers to be more than technical bureaucrats. We need to broaden their knowledge beyond the prescribed technical courses and teach them to address system issues, apply their knowledge to a team goal, and work as part of a team.

The Center is helping to train our students by having them drive their research to support the testbed systems. This makes students learn what other students are doing and why. As a result, students learn to work on a team and this means sometimes they lead and

sometimes they follow. Furthermore, students are being given the opportunity to take courses in the Zell Lurie Institute for Entrepreneurial Studies to learn how to assess if, and when, a technology is positioned to be commercialized. In the Integrated Microsystems Enterprise at Michigan Technological University, undergraduates are learning how to organize a business around a product. In short, students are learning to go beyond the "routine" engineering so that the phrase, "it can be done by the lowest bidder with a computer," will not apply to their efforts. I believe that the engineer of the future will need to be a Renaissance person and not just a technocrat. If you have suggestions on how we can further improve our students' preparations for the future, please let us know.

If you, or one of your colleagues, is interested in sharing your activities with our students, please contact me at either (734) 615-3096 or giachino@eeecs.umich.edu to schedule a seminar.

As always, please visit when in the Ann Arbor area so we can share our latest technical developments and progress with the laboratory expansion. ■

**Joseph M. Giachino**  
Associate Director, Industry

## Presentations and Publications

### Conference Presentations

*IEEE Antennas and Propagation Society/URSI International Symposium, Albuquerque, New Mexico, July 2006*

W. Hong, N. Behdad, and K. Sarabandi, "Reconfigurable Antenna for Active RFID"

W. Hong, N. Behdad, and K. Sarabandi, "Design of Efficient Slot Antennas for On-Chip Wireless Systems"

*International Workshop on Neural Interface Technologies and Applications, Kunming, China, July 2006*

M. J. Lehmkuhle, C. R. Butson, C. C. McIntyre, and D. R. Kipke, "Volume of Cortical Activation as a Function of Electrical Stimulation Configuration, Duration, and Amplitude in Auditory Cortex"

*The 49th IEEE International Midwest Symposium on Circuits and Systems (MWSCAS'06), San Juan, Puerto Rico, August 2006*

A. M. Sodagar and K. Najafi, "Wireless Interfaces for Implantable Biomedical Microsystems"

*Neural Interface Workshop, Bethesda, Maryland, August 2006*

M. D. Johnson, M. D. Gibson, L. G. Salas, R. K. Franklin, R. B. Brown, and D. R. Kipke, "Spatiotemporal Neurochemical, and Electrophysiological Recordings in Rodents"

M. J. Lehmkuhle and D. R. Kipke, "Neuromodulation of the Ventromedial Hypothalamus of the Rat Through Deep Brain Stimulation Effects Animal Weight"

*IEEE Conference of the IEEE Engineering in Medicine and Biology Society (EMBS), New York, New York, August 2006*

M. D. Johnson, N. B. Langhals, and D. R. Kipke, "Neural Interface Dynamics Following Insertion of Hydrous Iridium"

G. E. Perlin, A. M. Sodagar, and K. D. Wise, "Neural Recording Front-End Designs for Fully-Implantable Neuro-Science Applications and Neural Prosthetic Microsystems"

A. M. Sodagar, K. D. Wise, and K. Najafi, "A Neural Signal Processor for an Implantable Multi-Channel Cortical Recording Microsystem"

A. M. Sodagar, K. D. Wise, and K. Najafi, "Generic Controller Dedicated to Telemetry-Controlled Microsystems"

J. Subbaroyan and D. R. Kipke, "The Role of Flexible Polymer Interconnects in Chronic Tissue Response Induced by Intracortical Microelectrodes—a Modeling and an *In-Vivo* Study"

*Custom Integrated Circuits Conference (CICC), San Jose, California, September 2006*

A. M. Sodagar, K. Najafi, K. D. Wise, and M. Ghovanloo, "Fully-Integrated CMOS Power Regulator for Telemetry-Powered Implantable Biomedical Microsystems"

*Antenna Applications Symposium, Monticello, Illinois, September 2006*

W. Hong, M. Behdad, and K. Sarabandi, "Tri-Bond Reconfigurable Antenna for Active RFID"

### Publications

A. Gaitas and Y. B. Gianchandani, "An Experimental Study of Contact Mode Scan Speed Constraints for Polyimide Cantilever Probes," *Ultramicroscopy (Elsevier)*, 106, pp. 874–880, July 2006.

D. Papageorgiou, S. Shore, S. Bledsoe, and K. D. Wise, "A Shuttered Probe with In-Line Flowmeters for Chronic *In-Vivo* Drug Delivery," *IEEE J. Micro-electro-mech. Systems*, 15, pp. 1025–1033, August 2006.

Y. Yao, M. N. Gulari, and K. D. Wise, "Microassembly Techniques for a Three-Dimensional Neural Stimulating Microelectrode Array," *Digest IEEE Int. Conf. on Engr. in Med. and Biol. (EMBS'06)*, New York City, pp. 4643–4646, September 2006.

J. Wang, M. N. Gulari, and K. D. Wise, "A Parylene-Silicon Cochlear Electrode Array With Integrated Position Sensors," *Digest IEEE Int. Conf. on Engr. in Med. and Biol.*, New York City, pp. 3170–3173, September 2006.

## Doctoral Dissertations

*University of Michigan, 2006*

**Pamela T. Bhatti**, "A High-Density Thin-Film Electrode Array for Cochlear Prosthesis"  
Postgraduate Position: Assistant Professor of Electrical and Computer Engineering, Georgia Institute of Technology  
Advisor: Professor Kensall D. Wise

**Matthew Guthaus**, "Clock Tree Analysis and Synthesis Considering Process Parameters and Variability"  
Postgraduate Position: Assistant Professor at University of California, Santa Cruz  
Advisor: Professors Dennis M. Sylvester and Richard B. Brown

**Gordon R. Lambertus**, "Development, Evaluation, and Application of Silicon/Glass Microfabricated Gas Chromatography Columns"  
Postgraduate Position: Schlumberger, Boston, Massachusetts  
Advisors: Professors Richard D. Sacks and Edward T. Zellers

**Seungbae Lee**, "Micromechanical Resonator Reference Oscillators for Wireless Communications"  
Postgraduate Position: Senior Design Engineer, RFMD Company, Greensboro, North Carolina  
Advisor: Professor Clark T.-C. Nguyen

**Sunghyun Park**, "Design Techniques for High-Performance CMOS Flash Analog-to-Digital Converters"  
Postgraduate Position: Senior Staff Engineer, Qualcomm, San Diego, California  
Advisor: Professor Michael P. Flynn

**Joseph A. Potkay**, "A Low-Power Pressure- and Temperature-Programmed Separation System for a Micro Gas Chromatograph"  
Postgraduate Position: Associate Investigator for the Advanced Platform Technology (APT) Center at the Louis Stokes Cleveland VA Medical Center  
Advisor: Professor Kensall D. Wise

**Michael P. Rowe**, "Synthesis and Characterization of Monolayer-Protected Gold Nanoparticles and Their Organoplatinum Composites as Vapor-Sensitive Microsensor Interface Materials"  
Postgraduate Position: Postgraduate Research Fellow for Dr. Edward Zellers in Environmental Health Sciences at U of M  
Advisor: Professor Edward T. Zellers

## Doctoral Dissertations (cont)

University of Michigan, 2006

**William H. Steinecker**, "Gold-Thiolate Monolayer-Protected Nanoparticles as Sorptive Interfaces for Microsensor Arrays"  
Postgraduate Position: Post-Doctoral Researcher, Schlumberger, Boston, Massachusetts  
Advisor: Professor Edward T. Zellers

**Jing Wang**, "Stem Self-Aligned Micromechanical Radial-Contour Mode Disk Resonators for Wireless Communications"  
Postgraduate Position: University of Florida, Tampa  
Advisor: Professor Clark T.-C. Nguyen

## Seminar Series

**September 12, 2006**

**Gordon R. Lambertus**  
University of Michigan  
"Preparation, Evaluation, and Application of Silicon Micro-Fabricated Gas Chromatography Columns"

**\* September 19, 2006**

**Michael P. Rowe**  
University of Michigan  
"Synthesis and Characterization of Monolayer-Protected Gold Nanoparticles and Their Organoplatinum Composites as Vapor-Sensitive Microsensor Interface Materials"

**\* September 26, 2006**

**P. C. Ku**  
University of Michigan  
"En Route to Optoelectronic Integration"

*\*Available for viewing on website*

*Visit our website at <http://wimserc.org> to find out more information about these seminars and to view them on streaming video. You can also see a schedule of upcoming seminars, as well as a listing of publications.*

## Member Companies

Agilent Technologies  
Corning, Inc.  
Dexter Research Center, Inc.  
Discera, Inc.  
Evigia Systems, Inc.  
Freescale Semiconductor, Inc.  
Honeywell International  
Integrated Sensing Systems, Inc.  
MEDC  
Medtronic Corporation  
Mobius Microsystems, Inc.  
Motorola, Inc.  
NeuroNexus Technologies  
Sandia National Laboratories  
Schlumberger Technology Corporation  
Seagate  
Stryker  
SUSS MicroTec  
Textron Systems Corporation

Julia Donovan Darlow  
Laurence B. Detich  
Olivia P. Maynard  
Rebecca McGowan  
Andrea Fischer Newman  
Andrew C. Richner  
S. Martin Taylor  
Katherine E. White  
Mary Sue Coleman (ex officio)

The Regents of the  
University of Michigan

Michigan Engineering

WIMS ERC  
201 Engineering Programs Bldg.  
2609 Draper  
Ann Arbor, MI 48109-2101  
Telephone: (734) 764-3346  
Fax: (734) 647-2342  
www.wimserc.org  
Editor: Rose Anderson  
Email: [roseand@eecs.umich.edu](mailto:roseand@eecs.umich.edu)

WIMS WORLD



WIMS WORLD is published quarterly by the Engineering Research Center for Wireless Integrated Microsystems.

Non-Profit Org.  
US Postage  
**PAID**  
Permit No. 144  
Ann Arbor, MI