

BSP

Hydraulics Ltd

FOR ALL YOUR HYDRAULIC REQUIREMENTS

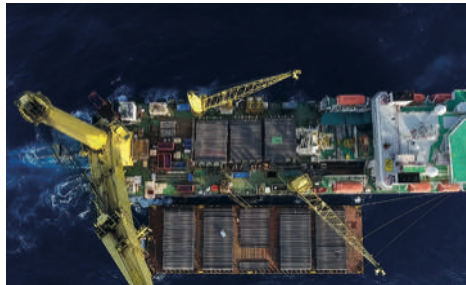

INDUSTRIAL



INTRODUCTION

Since 1992, BSP Hydraulics have built up and maintained an outstanding reputation for being one of the most accomplished hydraulic distribution companies in the United Kingdom.

Specialising in supplying and servicing equipment into the truck, mobile and industrial sectors, we have developed a wealth of technical expertise and we pride ourselves on offering a fast, efficient and reliable service. Our core value is customer satisfaction; therefore, we aim for symbiosis with both customers and suppliers in order to provide a totally customer focused service.

Our premises hold a comprehensive stock of products and spare parts, keeping us at the forefront of the hydraulic market and permitting a swift and proficient turnaround. We are equipped to provide high quality products which are both competitively priced and quickly delivered.

We have in-house and on-site hydraulic repair and service capabilities for our full range of hydraulic components. Our expert team hold a combined experience of over 100 years in repairing hydraulic products and are always on hand to fulfil your needs.

BSP Hydraulics Ltd are in premier partnership with Parker Hannifin and Hydro Leduc, two of the world's leading manufacturers in motion and control equipment. Both offering a wide product portfolio, and we support this with our substantial product and application knowledge.

This brochure showcases a selection of our products that we supply. We also hold large stocks of additional products of other manufacturers across an extensive range. For our full range please visit our website.

For further details or to discuss your hydraulic requirements, please contact our sales team or visit our user-friendly website.



Certificate Number: 10781
ISO 9001

Tel: 01924 332491 | Email: sales@bsphydraulics.co.uk

WHY CHOOSE BSP?

- Excellent Technical Support
- Large Stock Holdings
- Market Leading Products

Matching service

At BSP Hydraulics, we recognise the challenges you face when a crucial hydraulic component is outdated, discontinued, or unidentifiable so our Matching Service is dedicated to finding you replacements that either perfectly match your original parts or provide suitable alternatives that meet or exceed the original specifications, ensuring your machinery's peak performance.

How does it work? Let's walk through our straightforward process:

The identification process relies on the use of photographs and measurements or in-person analysis of a part that is sent to us.

Assessment: We start by examining the hydraulic part you need to replace, gathering all necessary specifications and operational requirements. Using both visual and technical analysis, our team ensures every detail is considered to find the best match.

Search and Match: Leveraging our vast network of suppliers and comprehensive inventory, we find either an identical replacement or the closest match that ensures compatibility and enhanced functionality. This process involves comparing your part against thousands of stored configurations to find the one that aligns perfectly with your needs.

In cases where the part is no longer manufactured, we will attempt to find an alternative unit that will meet or exceed the original specifications.

PUMPS

We specialise in supplying high-performance pump solutions tailored for the industrial sector. With decades of experience and a commitment to excellence, we provide our customers with dependable, efficient, and cost-effective pumping systems built to withstand the toughest environments.

Parker Variable Pumps

- VP1 45 TO 130 pumps



TXV Series:

- 11 Models available



Goldcups



PV Pumps



PD Pumps



PARKER GEAR PUMPS

PGP Series

We offer the full range of Parker PGP series pumps, both in cast iron and aluminium.

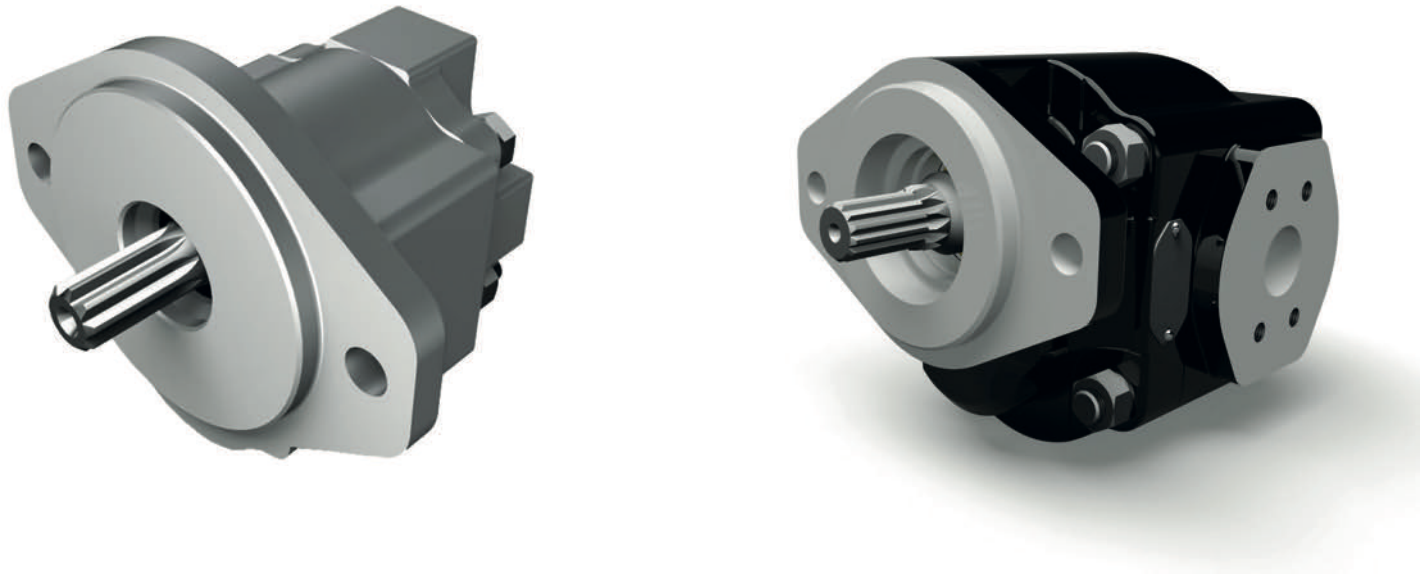

PAVC Pump

Parker PAVC Medium Pressure/Super Charged Hydraulic Piston Pumps provide reliable high-speed operation. With a pressure rating of 3,000 psi, they are ideal for a variety of medium pressure mobile and industrial applications.



PARKER DENISON

As one of the UK's leading suppliers for Parker Hannifin and the UK's first certified Parker Denison Build Centre back in 2016, we're proud to offer the full range of products as Parker Denison suppliers. Our expert team have years of experience in building and refurbishing Denison Hydraulics.

We offer the full Parker Denison range, including T6, T7, Goldcups, Calzoni, Denison motors, valves and a variety of spare parts.

Unloading Valve



Vane Pump - T6/T7

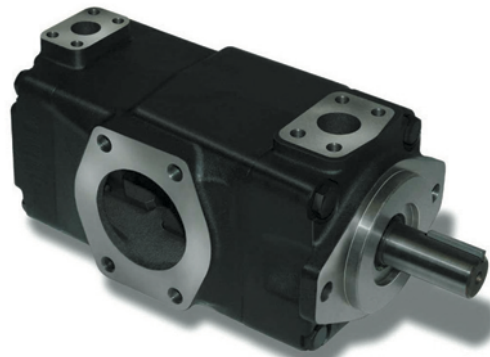

Calzoni



CETOP Valve



Gold Cup



Spares



PARKER MOTORS



Axial Piston Motors/Pumps

- Parker F11/F12
- High overall efficiency
- Pressure ranges up to 480 bar
- Easy to service

Torque Motors

Our range of Parker Torque Motors are suitable for a variety of applications, whether these are light, medium or heavy duty. For more information on the Torque motor series that we offer please take a look at our website.



V14



HYDRO LEDUC MOTORS

Variable Displacement Motor:

- 9 Piston design



W Pump:

- Displacements from 12 to 125cc

M Motor:

- Displacements from 5 to 180cc

Drainless Motor

POWER TAKE OFF



Parker Chelsea PTO Units

We are the main stockists and service agents of Parker Chelsea PTOs (Power Take Off). We can supply new units from stock, together with spare parts such as shafts, gears, seal kits and actuators.



Reservoir Accessories

BSP offer a range of reservoir accessories including; Triceptor Desiccant breathers, spin on breathers and suction strainers and diffusers.



Tel: 01924 332491 | Email: sales@bsphydraulics.co.uk

VALVES

Hy-Pro Valves

BSP supplies the full range Hy-Pro hydraulic valves. The Hy-Pro range produces three ranges of modular valves, that are robust sectional valves, with manual, cable, electric and pneumatic options.

They also have a selection of line-mounted valves, including check valves, diverter valves, flow control valves, relief valves and shut off valves.



Parker Directional Control Valves

- Section built valve
- A series of spool controls
- Flow ranges up to 150 l/min

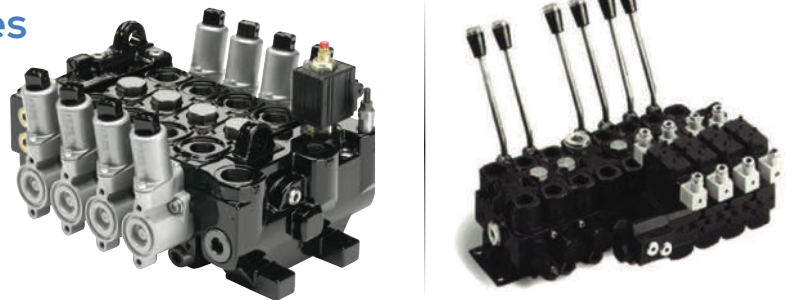

Auxiliary Valves

We offer a range of auxiliary valves, including relief valves, check valves, diverter valves, overcentre valves, flow control valves, dump valves and shut of valves.

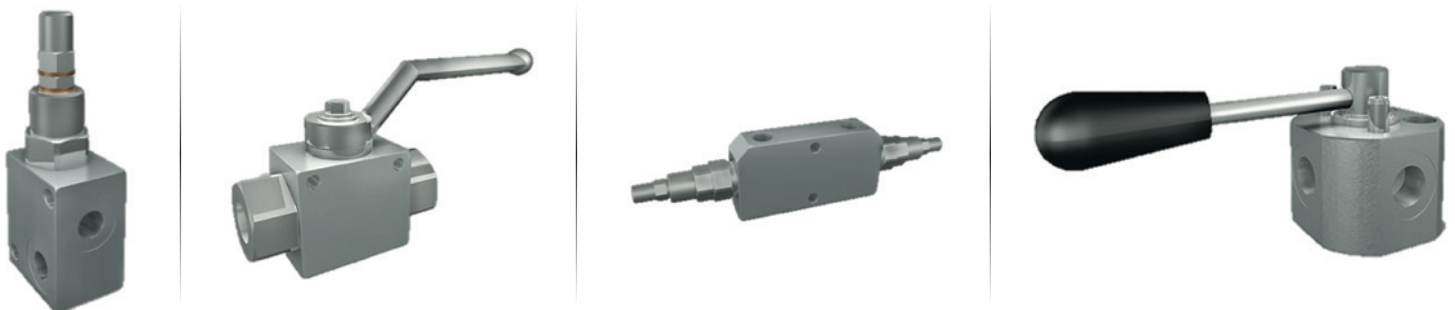

FILTERS

Filters

- Various mounting configurations • Various port options • High capacity/high efficiency
- Visual and electrical indicators with several connector styles



Measuring & Test Equipment

- BSP stock and supply the full range of HSP gauges, test points, test leads and hydraulic test kits

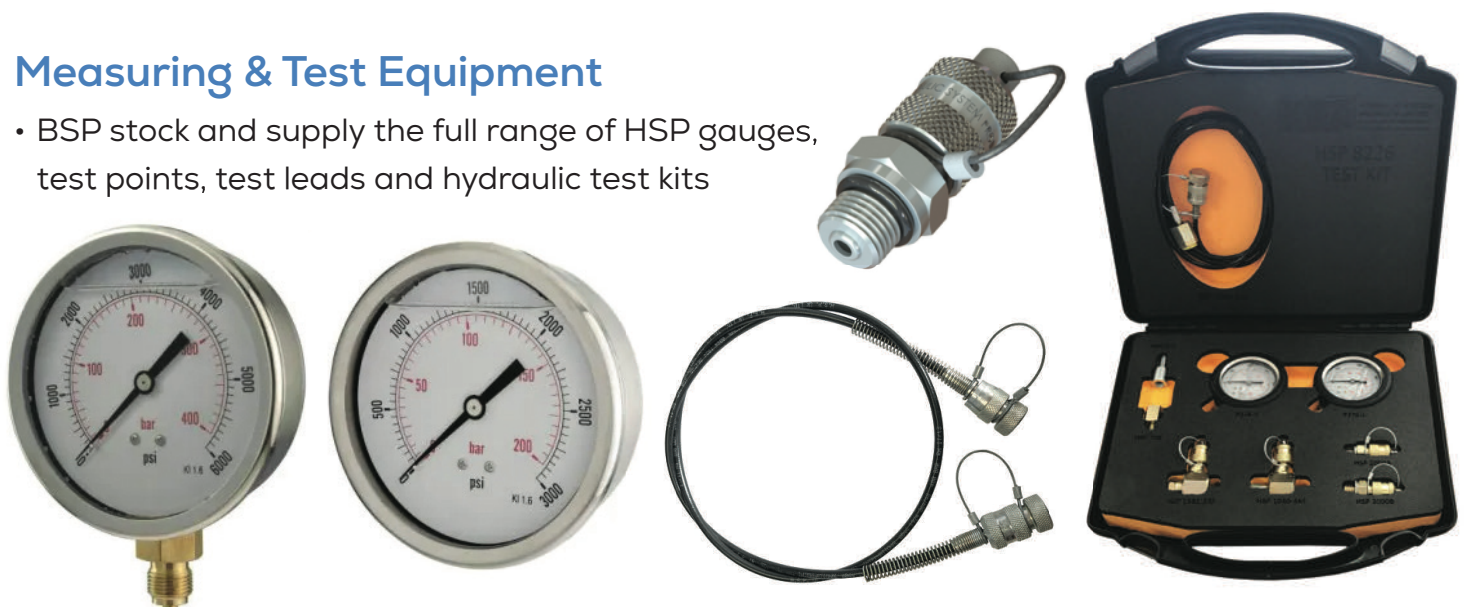

ACCUMULATORS

Accumulator Range

We offer the full range of Hydro Leduc Accumulators; these include Bladder, Diaphragm, Piston, Spherical and Cylindrical accumulators. All of which offer:

- Capacity from 0.02 to 50 litres
- Working pressure up to 500 bar
- Accessories for use with hydraulic motors

Please contact us for full details.



Piston Accumulators:

APL 250 bar

- Maximum pressure: 250 bar
- Extreme operating temperature:
- Standard version: -20°C to $+80^{\circ}\text{C}$



Bladder Accumulator:

ABVE 330 bar

- Maximum pressure: 330 bar
- ABVE 4 maximum pressure: 350 bar
- Extreme operating temperature:
- Standard version: -20°C to $+80^{\circ}\text{C}$



Spherical Accumulator:

AS 400 bar

- Maximum pressure: 400 bar
- Extreme operating temperature:
- Standard version: -20°C to $+100^{\circ}\text{C}$
- Low temperature version: -40°C to $+100^{\circ}\text{C}$



Safety Unloading Blocks



COOLERS

We offer the full range of Parker Coolers. Including the LDC series which offers reliable and efficient cooling solution. Also, the LOC series which has a three-phase AC motor which is optimised for use in the industrial sector.



HYDRAULIC CYLINDERS

Bespoke Cylinders

Designed Around Your Application

Our experienced engineers take the time to understand your system requirements and operating environment. With just a few key questions, we'll design and deliver a bespoke hydraulic cylinder that fits your application perfectly.

What We Offer:

- Custom-engineered hydraulic cylinders
- Short lead times
- Standard cylinders available from stock
- Competitive pricing
- Expert support from concept to completion

Whether you're replacing an existing unit or starting from scratch, BSP is your trusted partner for high-performance hydraulic solutions.

Parker Hydraulic Cylinders

As well as our bespoke cylinder offering, we also offer the full range of Parker Cylinders, including medium and heavy duty. With proven reliability, efficiency, and quality.



Certificate Number: 10781
ISO 9001

Tel: 01924 332491 | Email: sales@bsphydraulics.co.uk

HYDRO LEDUC MICRO HYDRAULICS

We supply the full range of Hydro Leduc Microhydraulics, this including; micro-pumps, micro-motors and complete micro-power packs. The key advantages of all these products are they have proven reliability of working in extreme operating conditions, such as temperature, pressure, medium and environment. Microhydraulics makes it possible to achieve several tons of force from a minimal power source within a very restricted space. They allow simple and easy solutions to problems that are often beyond the limits of traditional hydraulic options.



PARKER ELECTRIFICATION

Electrical Control Systems

Parker Hannifin's Electrical Control Systems provide products and solutions for electronic systems in industrial and mobile vehicles. The range includes; mobile master controllers, displays, IOAN master display modules, mobile software and much more. This range helps to increase productivity, reduce production time and decrease downtime.



SensoControl

The SensoControl® hand meters have been specially developed for the following applications:

- Measurement and display of all hydraulic values, such as pressure, differential pressure, pressure peaks, temperature and flow, as well as speed.
- They are perfectly suitable for the mobile recording of measured values and feature high precision combined with easy operation.
- All measuring devices as well as their accessories are manufactured and tested in our own plants. Our ever-increasing insistence on quality and flexibility make Parker a reliable partner.

SensoControl hand meters and complete measuring systems are perfectly suitable measuring tools for every application.

Whether they are used in the industrial area, in mobile hydraulics, for service or repair: measuring and processing of hydraulic values is the basis of safe trouble shooting.

The systematic search for errors with modern aids is something the service engineer simply cannot do without. High-speed processes, such as switching valves, cylinder strokes, pressure peaks, differential pressures and flow changes must be measured and evaluated simultaneously.



DELTA ZERO



One of our new product ranges added in 2023 was our Oil & Diesel Filtration system. Our range offers a unique filtration cartridge which is capable of filtration down to 0.1 micron; removing varnish, particles, and water from operating oils and fuels. By using these systems, it is possible to reduce fluid contamination by well over 90%, which will help to extend fluid life, reduce downtime and maintenance and of course reduces the risk of premature equipment failure.

The smallest unit of the range has a compact and cost-effective design and is ideal for fluid below 1000 litres @ 0.5lpm @ 32cSt.



On the other hand, the largest unit of the range has capabilities to hold up to 72,000 litres @ 12.7lpm @ 32cSt, and up to 61,000 litres @ 9lpm @ 46cSt.

Filters

The patented Delta-Xero cartridge is the reason that Delta-Xero filtration systems are so effective.



GEARBOXES & WINCHES

Our range includes a variety of gearboxes & winches, including Planetary gearboxes, Slewing Drives & Winches. All our products are held to the highest industry standards and are adaptable for various applications including mobile, drilling, marine, mining and industrial and offer tailored solutions for reliable work.

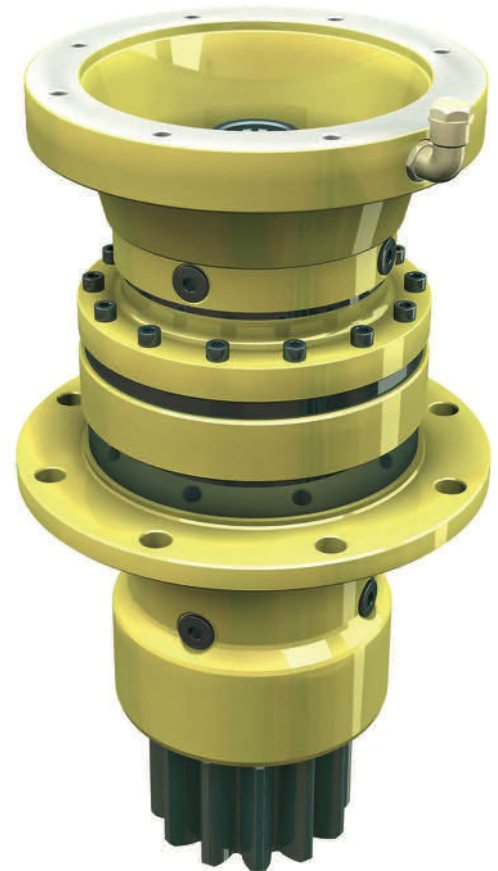

HOSE & FITTINGS

We stock a range of hydraulic hose and fittings including 1 wire, 2 wire and multispiral hose with fittings to suit. Including a wide range of adapters. Our extensive line includes low pressure, medium pressure and high pressure hydraulic hose assembly that can be made to customer specifications at our purpose-built hose facility and Parker Store trade counter in West Yorkshire. Hoses are tagged using (Parker Tracking System) PTS for full traceability and to increase uptime for faster more accurate hose replacement in the future. We can also supply loose hose and fittings.



Hose Kits

BSP can also make hose kits to suit your specification. Including hoses, adapters, seals, quick release couplings and much more.



KarryKrimp

BSP offer the full range of Parker KarryKrimps, they are easy to use, accurate and effective for making safe and reliable hose assemblies.

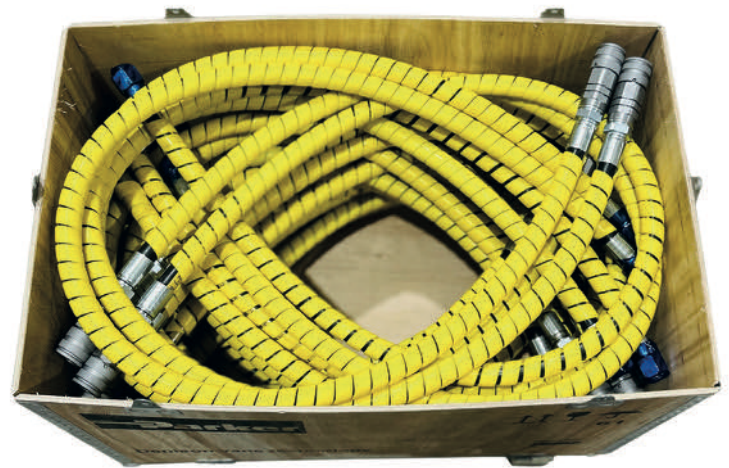

Consumables

We stock and supply a comprehensive range of high-quality consumables. Our range includes:

- Hydraulic Oil
- Spill Pads / Kits
- Gloves
- Funnels
- And more

Whether you're restocking essentials or preparing for a specific job, we've got the products you need, ready when you need them.

PARKER A LOK

At BSP, we are a supplier of Parker A-LOK® instrumentation tube fittings—renowned for their superior performance, reliability, and engineering excellence. Whether you're operating in oil & gas, chemical processing, power generation, or any critical application, Parker A-LOK® provides the secure connections you need.



STEEL TUBE

We supply a variety of steel tube suitable for a range of applications. Whether you need steel tube by the metre or in bulk, BSP is ready to deliver quality, reliability, and service.



HYDRAULIC POWER UNITS & ENGINE DRIVEN POWERPACKS

We supply Hydraulic Power Units (HPUs) and Engine-Driven Powerpacks engineered for performance, durability, and reliability in demanding environments. Talk to BSP today about your next power unit project—off-the-shelf or fully custom-built.

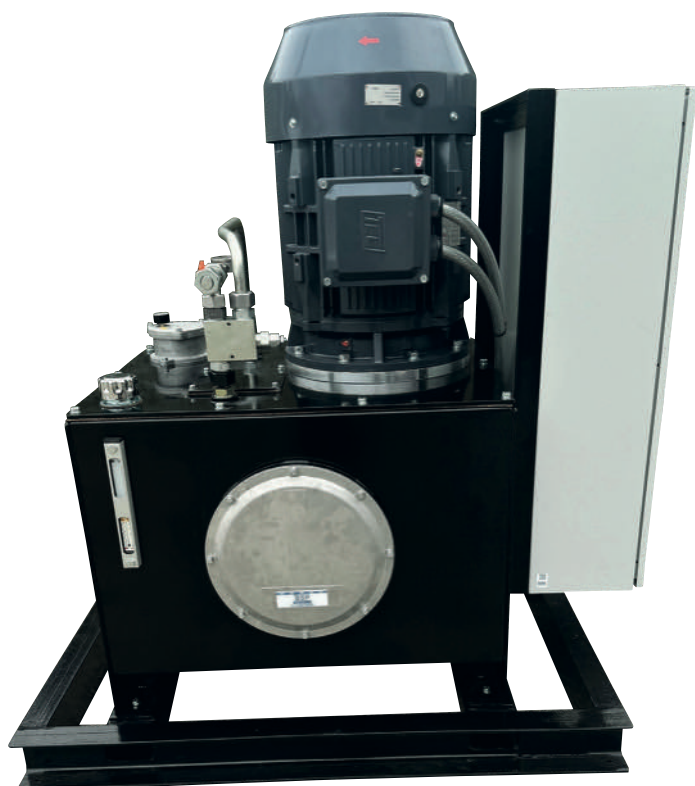

MOBILE HYDRAULIC HOSE REPLACEMENT SERVICE

BSP

— Hose & Fittings —

In 2022 BSP launched a new division 'BSP Hose & Fittings', where we now offer mobile hydraulic hose replacement across the Yorkshire region. We're also part of the Parker Hose Doctor programme to which we also undertake jobs.

To enquire about our mobile hose replacement please email us on hose@bsphydraulics.co.uk or call us on 01924 332491 (option 2)



Certificate Number: 10381
ISO 9001

Tel: 01924 332491 | Email: sales@bsphydraulics.co.uk

HOSE ASSEMBLY & HOSE TESTING

Our Normanton based facilities allow us to offer a wide range of hydraulic and industrial hose, fittings and adapters, suitable for a variety of applications. Our extensive line includes low, medium and high-pressure hydraulic hoses that can be made to customer specification at our purpose-built hose facility. We can make hoses while you wait in our Parker Store or we can supply customised to your exact requirements on a fast delivery service.



BSP have the facilities to offer hose pressure testing and flushing, with test certificates.



AFTER SALES/SERVICE

We are pleased to offer a comprehensive in-house and on-site repair service for the full range of Parker Hannifin hydraulic components. We also hold an extensive stock of new units and spare parts. We offer a fast turnaround of repairs and only use genuine parts.

All service and repair work is carried out by ex-employees of both Parker Hannifin and Voac Hydraulics, totalling over 100 years of experience.

Other services provided include installation, fault finding, commissioning and hose / fittings.



Parker Denison Build Centre

We are a UK distributor and stockist of the full Parker Denison range. In 2016, we became the UK's first certified Parker Denison build centre. Allowing us to supply and build the Parker Denison range suitable for applications within the truck, mobile and industrial markets. Our knowledgeable team are fully qualified and have excellent experience in building and refurbishing Parker Denison components. We carry extensive stock of genuine spare parts and full units, so we can deal with emergency situations and supply configured units in as little as 24 hours.



Certificate Number: 10781
ISO 9001

Tel: 01924 332491 | Email: sales@bsphydraulics.co.uk



Our other product ranges include:



CONTACT DETAILS

Unit 1 Tuscany Court | Express Way | Normanton | West Yorkshire | WF6 2AE

Tel: 01924 332491 | Fax: 01924 332493 | Email: sales@bsphdraulics.co.uk

www.bsphdraulics.co.uk

