



HP Folio 13

Maintenance and Service Guide

© Copyright 2012 Hewlett-Packard  
Development Company, L.P.

Intel is a trademark of Intel Corporation in the U.S. and other countries. Microsoft and Windows are U.S. registered trademarks of Microsoft Corporation. SD Logo is a trademark of its proprietor.

The information contained herein is subject to change without notice. The only warranties for HP products and services are set forth in the express warranty statements accompanying such products and services. Nothing herein should be construed as constituting an additional warranty. HP shall not be liable for technical or editorial errors or omissions contained herein.

First Edition: December 2011

Second Edition: December 2011

Third Edition: January 2012

Document Part Number: 671934-003

## Safety warning notice

---

**⚠ WARNING!** To reduce the possibility of heat-related injuries or of overheating the device, do not place the device directly on your lap or obstruct the device air vents. Use the device only on a hard, flat surface. Do not allow another hard surface, such as an adjoining optional printer, or a soft surface, such as pillows or rugs or clothing, to block airflow. Also, do not allow the AC adapter to contact the skin or a soft surface, such as pillows or rugs or clothing, during operation. The device and the AC adapter comply with the user-accessible surface temperature limits defined by the International Standard for Safety of Information Technology Equipment (IEC 60950).

---



---

# Table of contents

<b>1 Product description .....</b>	<b>1</b>
<b>2 External component identification .....</b>	<b>3</b>
Display .....	4
Buttons and other top components .....	5
Keys .....	6
Lights .....	7
TouchPad .....	8
Rear .....	8
Left side .....	9
Right side .....	10
Bottom .....	11
<b>3 Illustrated parts catalog .....</b>	<b>12</b>
Service tag .....	12
Computer major components .....	13
Mass storage devices .....	16
Miscellaneous parts .....	16
Sequential part number listing .....	17
<b>4 Removal and replacement procedures .....</b>	<b>19</b>
Preliminary replacement requirements .....	19
Tools required .....	19
Service considerations .....	19
Plastic parts .....	19
Cables and connectors .....	19
Drive handling .....	20
Grounding guidelines .....	20
Electrostatic discharge damage .....	20
Packaging and transporting guidelines .....	22
Component replacement procedures .....	23
Service tag .....	23
Computer feet .....	24
Base enclosure .....	25
Keyboard .....	26
Top cover .....	28

Power button board .....	29
TouchPad button board .....	31
Battery .....	32
Display panel .....	34
WLAN module .....	36
USB/Audio board .....	37
RTC battery .....	39
Hard drive .....	40
Memory module .....	41
Speakers .....	42
System board .....	43
Power connector cable .....	44
Fan/Heat sink .....	46

## **5 Setup Utility (BIOS) and System Diagnostics ..... 48**

Using Setup Utility .....	48
Starting Setup Utility .....	48
Changing the language of Setup Utility .....	48
Navigating and selecting in Setup Utility .....	49
Displaying system information .....	49
Restoring factory settings in Setup Utility .....	50
Exiting Setup Utility .....	50
Updating the BIOS .....	50
Determining the BIOS version .....	51
Downloading a BIOS update .....	51
Using System Diagnostics .....	52

## **6 Specifications ..... 53**

Computer specifications .....	53
13.3-inch display specifications .....	53

## **7 Backup and recovery ..... 55**

Restoring the system .....	55
Creating restore media .....	55
Performing a system recovery .....	56
Using the dedicated recovery partition .....	56
Restoring using the restore media .....	58
Changing the computer boot order .....	58
Backing up and recovering your information .....	58
Using Windows Backup and Restore .....	59

Using Windows system restore points .....	60
When to create restore points .....	60
Create a system restore point .....	60
Restore to a previous date and time .....	60
<b>8 Power cord set requirements .....</b>	<b>61</b>
Requirements for all countries .....	61
Requirements for specific countries and regions .....	61
<b>9 Recycling .....</b>	<b>63</b>
<b>Index .....</b>	<b>64</b>



# 1 Product description

Category	Description
<b>Product Name</b>	HP Folio 13 PC
<b>Processors</b>	Intel® Core™ i5-2467M 1.6GHz processor SC turbo up to 2.3GHz (3MB L3 cache, dual core 17 W) Intel® Core™ i3-2367M 1.4 GHz processor (3MB L3 cache, dual 17W)
<b>Chipset</b>	Intel® HM65 Express platform controller hub (PCH)
<b>Graphics</b>	Intel® HD Graphics 3000 discrete-class graphics. Supports BD and or HD-DVD playback with HD decode, and DX11 support and HDMI support
<b>Panel</b>	13.3" high-definition (HD) light-emitting diode (LED), BrightView (1366x768) display; (2.85mm) Shuriken, 200 nits All display assemblies include 2 wireless local area network (WLAN) antenna cables. Supports 16:9 wide aspect ratio Support for non-flush glass panel cover (non-PMMA)
<b>Memory</b>	One memory module slot DDR3-1333MHz single channel support (DDR3-1600 downgrade to 1333) Supports up to 4096 GB of system RAM Supports the following configuration: 4096-MB total system memory (4096×1).
<b>Hard drives</b>	mSATA SSD 128 GB: 128-GB SSD
<b>Optical drive</b>	External USB optical drive (computer USB ports support 2A current) SATA 12–7 mm tray load Supports the following external optical drives: <ul style="list-style-type: none"><li>• Blu-ray ROM DVD±R/RW Super Multi Double-Layer Drive</li><li>• DVD±RW and CD-RW Super Multi Double-Layer Combo Drive</li></ul>
<b>Audio and video</b>	Single digital microphone Two integrated stereo speakers HP TrueVision high-definition webcam (fixed, no tilt, 1280×800 by 30 frames per second)
<b>Ethernet</b>	Integrated 10/100/1000 GB network interface card (NIC)
<b>Wireless</b>	Integrated WLAN options by way of wireless module Two WLAN antennas built into display assembly

Category	Description
	<p>Supports the following WLAN formats:</p> <ul style="list-style-type: none"> <li>• Intel® Centrino® Wireless-N 1030 + Bluetooth combo w/ *2 antennas (802.11 b/g/n, Bluetooth 3.0)</li> <li>• Atheros 9485GN 802.11b/g/n 1×1 WiFi and 3012 Bluetooth 4.0 Combo Adapter</li> <li>• Broadcom 4313GN 802.11b/g/n 1×1 WiFi and 20702 Bluetooth 4.0 Combo Adapter</li> </ul>
<b>External media card</b>	<p>Push-pull insertion/removal</p> <p>HP Multi-Format Digital Media Reader supports the following digital card formats:</p> <ul style="list-style-type: none"> <li>• MultiMediaCard</li> <li>• Secure Digital (SD) Card</li> <li>• Secure Digital High-Capacity (SDHC) Card</li> <li>• Secure Digital Extended Capacity (SDxC) Card</li> </ul>
<b>Ports</b>	<ul style="list-style-type: none"> <li>• 3-pin AC power</li> <li>• Audio-in (mono microphone), supports jack detection</li> <li>• Audio-out (stereo headphone), supports jack detection</li> <li>• HDMI version 1.3b supporting 1080p, 1920 ×1080 @ 60Hz</li> <li>• RJ-45 (Ethernet, includes link and activity lights)</li> <li>• USB 3.0 (1 port)</li> <li>• USB 2.0 (1 port)</li> </ul>
<b>Keyboard/pointing devices</b>	<p>97% Duracoat, island-style keyboard, no spill-resistance (in black finish)</p> <p>TouchPad with multi-touch gestures</p> <p>Taps enabled as default</p>
<b>Power requirements</b>	<p><b>Supports the following HP AC adapters:</b></p> <ul style="list-style-type: none"> <li>• 65-W (non-smart) PFC RC V EM 3-wire HP AC adapter</li> </ul> <p><b>Supports the following batteries:</b></p> <ul style="list-style-type: none"> <li>• 6-cell, 59 WHr 5.4 AH Li-ion battery</li> </ul>
<b>Operating system</b>	<p><b>Preinstalled:</b></p> <ul style="list-style-type: none"> <li>• Windows 7 Home Basic (64- and 32-bit)</li> <li>• Windows 7 Home Premium (64- and 32-bit)</li> <li>• Windows 7 Professional (64- and 32-bit)</li> </ul>
<b>Serviceability</b>	<p><b>End-user replaceable parts:</b></p> <ul style="list-style-type: none"> <li>• AC adapter</li> </ul>

---

## 2 External component identification

# Display



Item	Component	Description
(1)	WLAN antennas (2)*	Send and receive wireless signals to communicate with wireless local area networks (WLANs).
(2)	Webcam	Records video and captures still photographs. To use the webcam, select <b>Start &gt; All Programs &gt; Communication and Chat &gt; CyberLink YouCam</b> .
(3)	Internal display switch	Turns off the display or initiates Sleep if the display is closed while the power is on. <b>NOTE:</b> The display switch is not visible from the outside of the computer.

\*The antennas are not visible from the outside of the computer. For optimal transmission, keep the areas immediately around the antennas free from obstructions. To see wireless regulatory notices, refer to the section of the *Regulatory, Safety and Environmental Notices* that applies to your country or region. These notices are located in Help and Support.

## Buttons and other top components



Item	Component	Description
(1)	Internal microphone	Records sound.
(2)	Power button	<ul style="list-style-type: none"> <li>When the computer is off, press the button to turn on the computer.</li> <li>When the computer is on, press the button briefly to initiate Sleep.</li> <li>When the computer is in the Sleep state, press the button briefly to exit Sleep.</li> <li>When the computer is in Hibernation</li> </ul> <p><b>NOTE:</b> For select models, the Intel® Rapid Start Technology feature is enabled at the factory. Rapid Start Technology allows your computer to resume quickly from inactivity. For more information, refer to Using Sleep or Hibernation, refer to the <i>HP Notebook User Guide</i>.</p> <p>If the computer has stopped responding and Windows® shutdown procedures are ineffective, press and hold the power button for at least 5 seconds to turn off the computer.</p> <p>To learn more about your power settings, select <b>Start &gt; Control Panel &gt; System and Security &gt; Power Options</b>.</p>
(3)	Speakers (2)	Produce sound.

# Keys

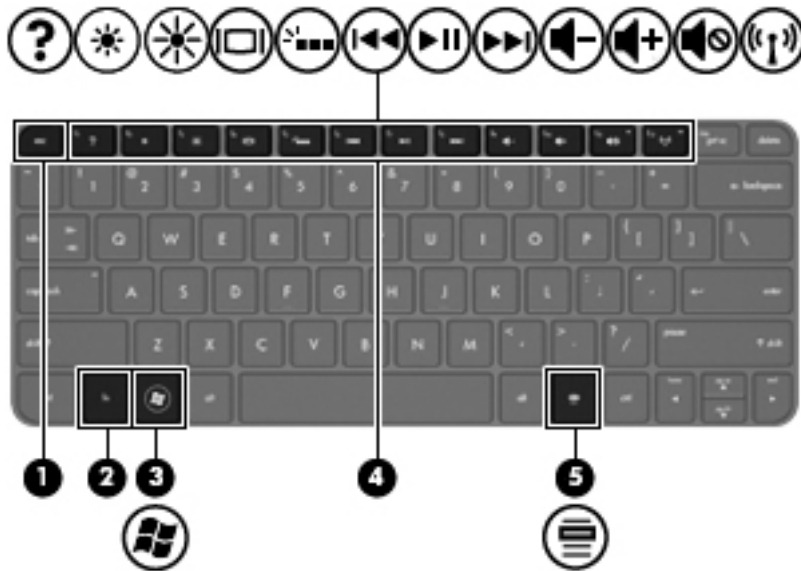

Item	Component	Description
(1)	esc key	Displays system information when pressed in combination with the <b>fn</b> key.
(2)	fn key	Displays system information when pressed in combination with the <b>esc</b> key.
(3)	Windows logo key	Displays the Windows Start menu.
(4)	Action keys	Execute frequently used system functions.
(5)	Windows applications key	Displays a shortcut menu for items beneath the pointer.

# Lights

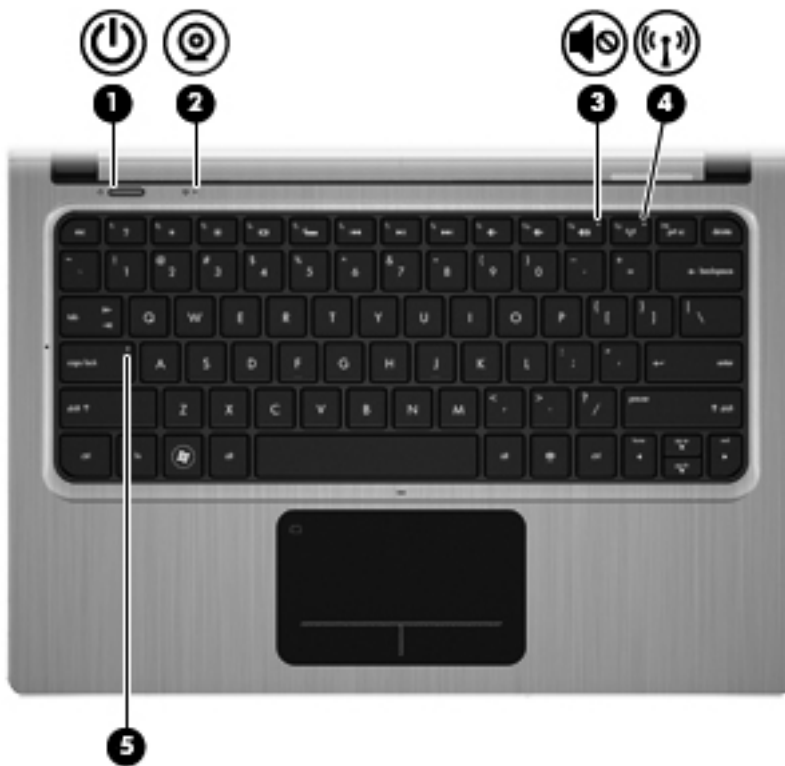

Item	Component	Description
(1)	Power light	<ul style="list-style-type: none"> <li>White: The computer is on.</li> <li>Blinking white: The computer is in the Sleep state.</li> <li>Off: The computer is off or in Hibernation.</li> </ul>
(2)	Webcam light	On: The webcam is in use.
(3)	Mute light	<ul style="list-style-type: none"> <li>Amber: Computer sound is off.</li> <li>Off: Computer sound is on.</li> </ul>
(4)	Wireless light	<ul style="list-style-type: none"> <li>White: An integrated wireless device, such as a wireless local area network (WLAN) device and/or a Bluetooth® device, is on.</li> <li>Amber: All wireless devices are off.</li> </ul>
(5)	Caps lock light	On: Caps lock is on.

## TouchPad

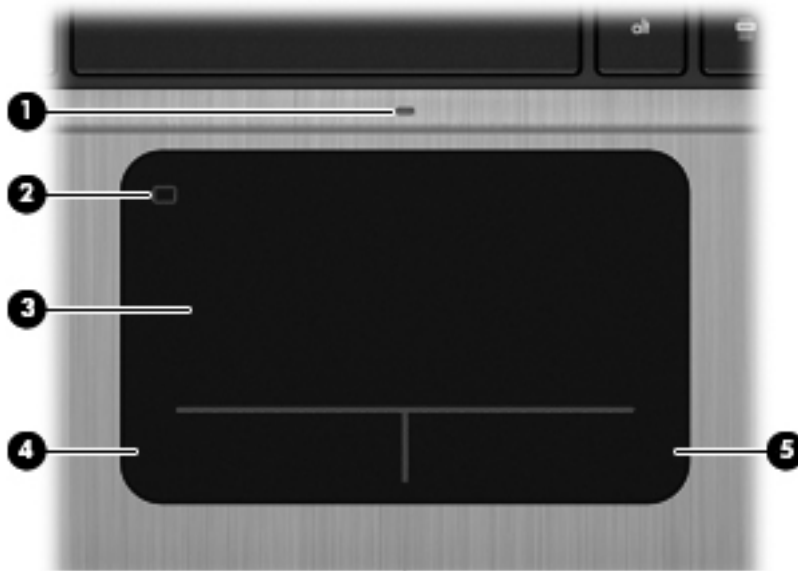

Item	Component	Description
(1)	TouchPad light	<ul style="list-style-type: none"><li>• On: The TouchPad is off.</li><li>• Off: The TouchPad is on.</li></ul>
(2)	TouchPad on/off button	Turns the TouchPad on and off.
(3)	TouchPad zone	Moves the pointer and selects or activates items on the screen.
(4)	Left TouchPad button	Functions like the left button on an external mouse.
(5)	Right TouchPad button	Functions like the right button on an external mouse.

## Rear



Component	Description
Vent	Enables airflow to cool internal components. <b>NOTE:</b> The computer fan starts up automatically to cool internal components and prevent overheating. It is normal for the internal fan to cycle on and off during routine operation.

## Left side



Item	Component	Description
(1)	Power connector	Connects an AC adapter.
(2)	AC adapter/Battery light	<ul style="list-style-type: none"> <li>White: The computer is connected to external power and the battery is fully charged.</li> <li>Amber: A battery is charging.</li> <li>Blinking white: The battery charge level is 12% or less (recharge the battery as soon as possible).</li> <li>Off: The computer is not connected to external power.</li> </ul>
(3)	RJ-45 (network) jack	Connects a network cable.
(4)	HDMI port	Connects an optional video or audio device, such as a high-definition television, or any compatible digital or audio component.
(5)	USB 3.0 port	<p>Connects optional USB 3.0 devices and provide enhanced USB power performance.</p> <p><b>NOTE:</b> The USB 3.0 port is also compatible with USB 1.0 and USB 2.0 devices.</p>
(6)	Digital Media Slot	<p>Supports the following digital card formats:</p> <ul style="list-style-type: none"> <li>Secure Digital (SD) Memory Card</li> <li>Secure Digital Extended Capacity (SDxC) Memory Card</li> <li>Secure Digital High Capacity (SDHC) Memory Card</li> <li>Ultra High Speed MultiMediaCard (UHS/MMC)</li> </ul>
(7)	Hard drive light	<ul style="list-style-type: none"> <li>Blinking white: The hard drive is being accessed.</li> </ul> <p><b>NOTE:</b> All references to the hard disk drive in this guide refer to the solid-state (SSD) drive.</p>
(8)	Power light	<ul style="list-style-type: none"> <li>White: The computer is on.</li> <li>Blinking white: The computer is in the Sleep state.</li> <li>Off: The computer is off or in Hibernation.</li> </ul>

## Right side



Item	Component	Description
(1)	USB 2.0 port	Connects optional USB devices.
(2)	Audio-out (headphone) jack/audio-in (microphone) jack	<p>Connects optional powered stereo speakers, headphones, earbuds, a headset, or television audio. Also connects an optional headset microphone.</p> <p><b>WARNING!</b> To reduce the risk of personal injury, adjust the volume before putting on headphones, earbuds, or a headset. For additional safety information, refer to the <i>Regulatory, Safety and Environmental Notices</i>.</p> <p><b>NOTE:</b> When a device is connected to the jack, the computer speakers are disabled.</p> <p><b>NOTE:</b> The microphone function is operational only when used with a headphone/microphone unit that has a 4-conductor audio connector.</p>

## Bottom

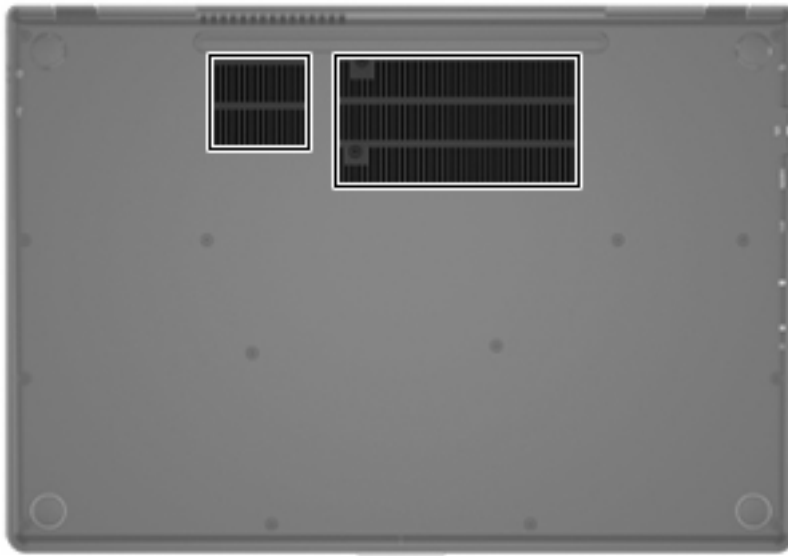

Item	Component	Description
(1)	Vent	Enables airflow to cool internal components. <b>NOTE:</b> The computer fan starts up automatically to cool internal components and prevent overheating. It is normal for the internal fan to cycle on and off during routine operation.

# 3 Illustrated parts catalog

## Service tag

When ordering parts or requesting information, provide the computer serial number and model description provided on the service tag, which is located on the bottom of the computer.

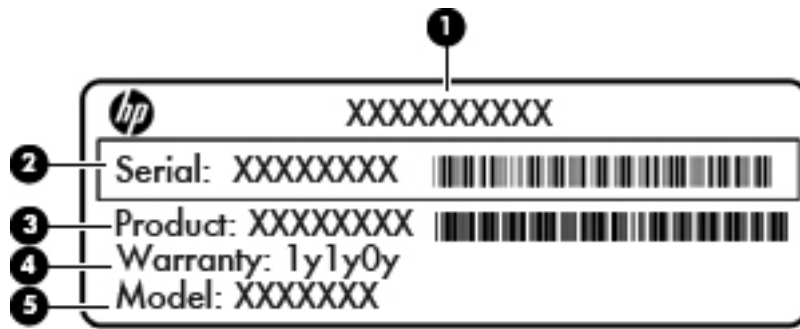

Item	Description	Function
(1)	Product name	This is the product name affixed to the front of the computer.
(2)	Serial number (s/n)	This is an alphanumeric identifier that is unique to each product.
(3)	Part number/Product number (p/n)	This number provides specific information about the product's hardware components. The part number helps a service technician to determine what components and parts are needed.
(4)	Warranty period	This number describes the duration of the warranty period for the computer.
(5)	Model description	This is the alphanumeric identifier used to locate documents, drivers, and support for the computer.

# Computer major components

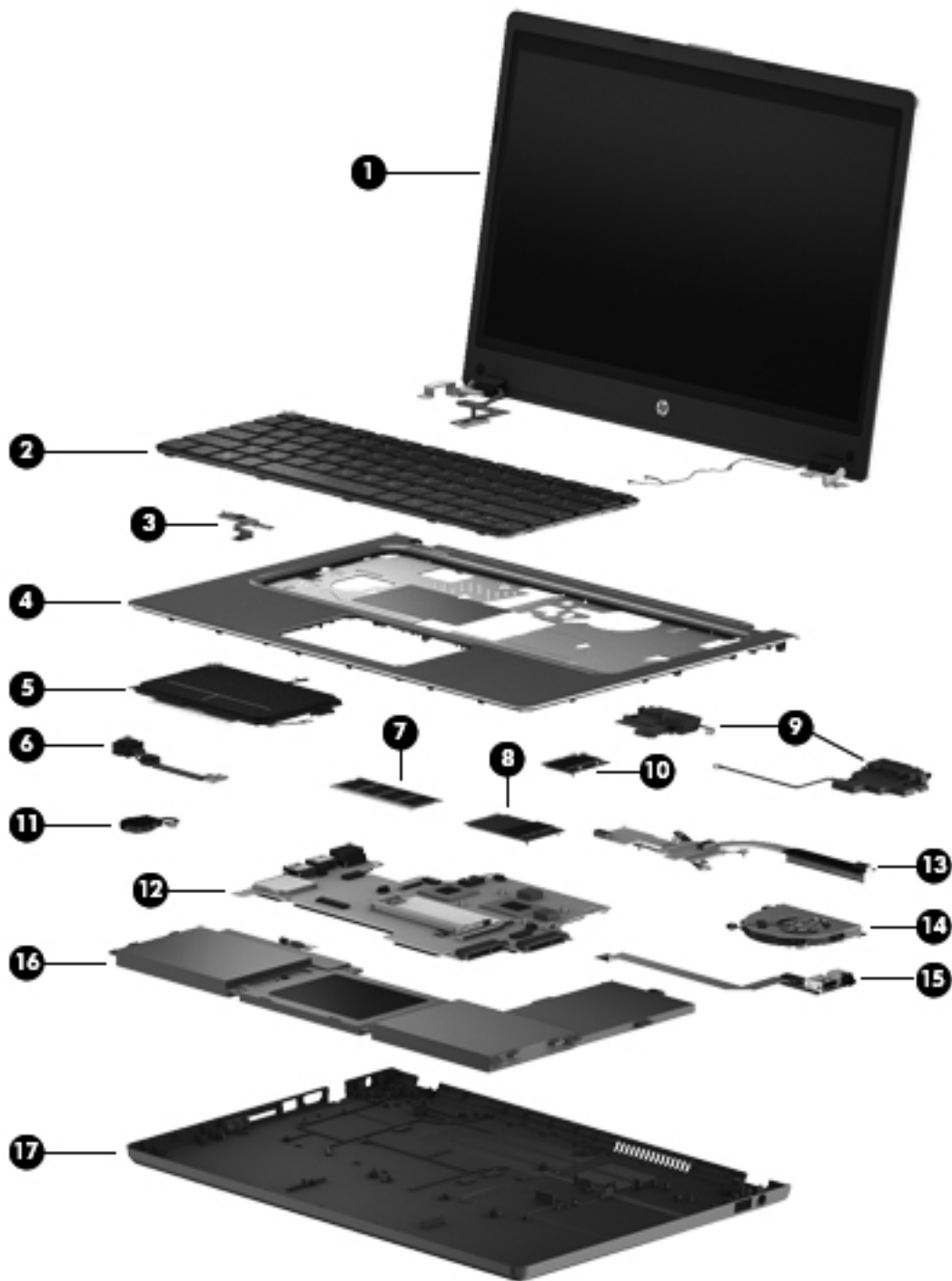

Item	Component	Spare part number
(1)	Display assembly	
(2)	Keyboard (includes keyboard cable):	
	In black finish:	

<b>Item</b>	<b>Component</b>	<b>Spare part number</b>
	For use in Thailand	673656-281
	For use in Canada	673656-121
	For use in Japan	673656-291
	For use in Latin America	673656-161
	For use in South Korea	673656-AD1
	For use in Taiwan	673656-AB1
	For use in the United States	673656-001
	For use in the United Kingdom and Singapore	673656-031
	For use in France	673656-051
	For use in Italy	673656-061
	For use in Saudi Arabia	673656-171
	For use in Russia	673656-251
	For use in the Netherlands	673656-B31
	For use in Spain	673656-071
	For use in Switzerland	673656-BG1
	For use in Denmark, Finland, Norway	673656-DH1
<b>(3)</b>	<b>Power button board</b>	672357-001
	<b>NOTE:</b> The top cover spare part kit includes the power button board and cable and the TouchPad and cable.	
<b>(4)</b>	<b>Top cover</b> (includes power button board and cable and TouchPad and TouchPad cable):	672357-001
<b>(5)</b>	<b>TouchPad button board</b> (includes cable)	672357-001
	<b>NOTE:</b> The top cover spare part kit includes the power button board and cable and the TouchPad and cable.	
<b>(6)</b>	<b>Power connector cable</b> (includes bracket)	672361-001
<b>(7)</b>	<b>Memory modules</b> (2, PC3, 10600, 1333-MHz):	
	4 GB	641369-005
<b>(8)</b>	<b>Hard drive</b> (does not include the hard drive bracket, connector cable, isolators, or screws.)	
	128-GB solid-state drive	672616-001
<b>(9)</b>	<b>Speakers</b> (includes cables)	672353-001
<b>(10)</b>	<b>WLAN module:</b>	
	Intel® Centrino® Wireless-N 1030 + Bluetooth combo w/ *2 antennas (802.11 b/g/n, Bluetooth 3.0)	631956-005
	Atheros 9485GN 802.11b/g/n 1×1 WiFi and 3012 Bluetooth 4.0 Combo Adapter	655795-005
	Broadcom 4313GN 802.11b/g/n 1×1 WiFi and 20702 Bluetooth 4.0 Combo AdapterSPS-WLAN 802.11bgn+BT4 BC HMC 1x1 VAL	657325-005
<b>(11)</b>	<b>RTC battery:</b>	672349-001

<b>Item</b>	<b>Component</b>	<b>Spare part number</b>
<b>(12)</b>	<b>System board</b>	672351-001
		672352-001
<b>(13)</b>	<b>Fan-Heat sink</b> (includes replacement thermal material)	672355-001
<b>(14)</b>	<b>Fan-Heat sink</b>	672354-001
<b>(15)</b>	<b>USB/Audio board</b>	672358-001
<b>(16)</b>	<b>Battery:</b> 6-cell, 59 WHr 5.4AH Li-ion battery	671602-001
<b>(17)</b>	<b>Base enclosure</b>	672356-001

## Mass storage devices



Item	Component	Spare part number
(1)	<b>Optical drive:</b>	
	Blu-ray ROM DVD±R/RW Super Multi Double-Layer Drive	659941-001
	DVD±RW and CD-RW Super Multi Double-Layer Combo Drive	659940-001
(2)	<b>Hard drive</b>	
	128-GB solid-state drive	672616-001
	Screws (not illustrated)	

## Miscellaneous parts

Component	Spare part number
<b>AC adapter (non-smart):</b>	
65-W PFC RC V EM 3-wire AC adapter (non-smart) for use only in India	613149-001
65-W PFC RC V 3-wire AC adapter (non-smart) for use in all countries and regions except India	613149-001
<b>Power cord (3-pin, black, 1.83-m):</b>	
For use in Australia	490371-011
For use in Italy	490371-061
For use in Japan	490371-291
For use in North America	490371-001
For use in the People's Republic of China	490371-AA1
For use in South Korea	490371-AD1
For use in Argentina	490371-D01
For use in Taiwan	490371-AB1

Component	Spare part number
For use in Thailand	490371-201
For use in Europe	490371-021
For use in Switzerland	490371-111
For use in the United Kingdom and Singapore	490371-031
<b>Screw Kit</b>	672359-001

## Sequential part number listing

Spare part number	Description
490371-001	Power cord for use in North America (3-pin, black, 1.83-m)
490371-011	Power cord for use in Australia (3-pin, black, 1.83-m)
490371-021	Power cord for use in Europe (3-pin, black, 1.83-m)
490371-031	Power cord for use in the United Kingdom and Singapore (3-pin, black, 1.83-m)
490371-061	Power cord for use in Italy (3-pin, black, 1.83-m)
490371-111	Power cord for use in Switzerland (3-pin, black, 1.83-m)
490371-201	Power cord for use in Thailand (3-pin, black, 1.83-m)
490371-291	Power cord for use in Japan (3-pin, black, 1.83-m)
490371-AA1	Power cord for use in the People's Republic of China (3-pin, black, 1.83-m)
490371-AB1	Power cord for use in Taiwan (3-pin, black, 1.83-m)
490371-AD1	Power cord for use in South Korea (3-pin, black, 1.83-m)
490371-D01	Power cord for use in Argentina (3-pin, black, 1.83-m)
613149-001	AC Adapter (non-smart) RC V 3-wire for use in all countries and regions except India
631956-005	Intel® Centrino® Wireless-N 1030 + Bluetooth combo w/ *2 antennas (802.11 b/g/n, Bluetooth 3.0)
641369-005	4-GB memory module (PC3, 10600, 1333-MHz)
655795-005	Atheros 9485GN 802.11b/g/n 1×1 WiFi and 3012 Bluetooth 4.0 Combo Adapter
657325-005	Broadcom 4313GN 802.11b/g/n 1×1 WiFi and 20702 Bluetooth 4.0 Combo Adapter
659940-001	DVD±RW and CD-RW Super Multi Double-Layer Combo Drive
659941-001	Blu-ray ROM DVD±R/RW Super Multi Double-Layer Drive
671602-001	6-cell, 59 WHr 5.4AH Li-ion battery
672349-001	RTC battery for use only with computer models without WWAN capability
672350-001	Display assembly for use with computer models equipped with WLAN only capability in black finish (includes WLAN antenna cable and transceivers)
672351-001	System board for use only with computer models equipped with an Intel 1.4 GHz processor (includes processor and replacement thermal material)

<b>Spare part number</b>	<b>Description</b>
672352-001	System board for use only with computer models equipped with an Intel 1.6 GHz processor (includes processor and replacement thermal material)
672353-001	Speaker Kit (includes left and right speakers and cable)
672354-001	Fan-Heat sink
672355-001	Fan-Heat sink (includes replacement thermal material)
672356-001	Base enclosure
672357-001	Top cover in black finish (includes power button board and cable and TouchPad and TouchPad cable)
672358-001	USB/Audio board
672359-001	Screw Kit
672361-001	Power connector cable (includes bracket)
672362-001	Thermal pad
672363-001	Rubber Kit (includes two rear corner covers and four rubber feet)
672616-001	128-GB solid-state drive only (does not include bracket, connector cable, isolators, or screws)
673656-001	Keyboard in black finish for use in the United States (includes keyboard cable)
673656-031	Keyboard in black finish for use in the United Kingdom and Singapore (includes keyboard cable)
673656-051	Keyboard in black finish for use in France (includes keyboard cable)
673656-061	Keyboard in black finish for use in Italy (includes keyboard cable)
673656-071	Keyboard in black finish for use in Spain (includes keyboard cable)
673656-121	Keyboard in black finish for use in Canada (includes keyboard cable)
673656-161	Keyboard in black finish for use in Latin America (includes keyboard cable)
673656-171	Keyboard in black finish for use in Saudi Arabia (includes keyboard cable)
673656-251	Keyboard in black finish for use in Russia (includes keyboard cable)
673656-281	Keyboard in black finish for use in Thailand (includes keyboard cable)
673656-291	Keyboard in black finish for use in Japan (includes keyboard cable)
673656-AB1	Keyboard in black finish for use in Taiwan (includes keyboard cable)
673656-AD1	Keyboard in black finish for use in South Korea (includes keyboard cable)
673656-B31	Keyboard in black finish for use in The Netherlands (includes keyboard cable)
673656-BG1	Keyboard in black finish for use in Switzerland (includes keyboard cable)
673656-DH1	Keyboard in black finish for use in Denmark, Finland, Norway (includes keyboard cable)

---

# 4 Removal and replacement procedures

## Preliminary replacement requirements

### Tools required

You will need the following tools to complete the removal and replacement procedures:

- Flat-bladed screwdriver
- Magnetic screwdriver
- Phillips P0 and P1 screwdrivers

### Service considerations

The following sections include some of the considerations that you must keep in mind during disassembly and assembly procedures.

---

 **NOTE:** As you remove each subassembly from the computer, place the subassembly (and all accompanying screws) away from the work area to prevent damage.

---

### Plastic parts

---

 **CAUTION:** Using excessive force during disassembly and reassembly can damage plastic parts. Use care when handling the plastic parts. Apply pressure only at the points designated in the maintenance instructions.

---

### Cables and connectors

---

 **CAUTION:** When servicing the computer, be sure that cables are placed in their proper locations during the reassembly process. Improper cable placement can damage the computer.

---

Cables must be handled with extreme care to avoid damage. Apply only the tension required to unseat or seat the cables during removal and insertion. Handle cables by the connector whenever possible. In all cases, avoid bending, twisting, or tearing cables. Be sure that cables are routed in such a way that they cannot be caught or snagged by parts being removed or replaced. Handle flex cables with extreme care; these cables tear easily.

## Drive handling

---

**⚠ CAUTION:** Drives are fragile components that must be handled with care. To prevent damage to the computer, damage to a drive, or loss of information, observe these precautions:

Before removing or inserting a hard drive, shut down the computer. If you are unsure whether the computer is off or in Hibernation, turn the computer on, and then shut it down through the operating system.

Before handling a drive, be sure that you are discharged of static electricity. While handling a drive, avoid touching the connector.

Before removing a diskette drive or optical drive, be sure that a diskette or disc is not in the drive and be sure that the optical drive tray is closed.

Handle drives on surfaces covered with at least one inch of shock-proof foam.

Avoid dropping drives from any height onto any surface.

After removing a hard drive, an optical drive, or a diskette drive, place it in a static-proof bag.

Avoid exposing an internal hard drive to products that have magnetic fields, such as monitors or speakers.

Avoid exposing a drive to temperature extremes or liquids.

If a drive must be mailed, place the drive in a bubble pack mailer or other suitable form of protective packaging and label the package "FRAGILE."

---

## Grounding guidelines

### Electrostatic discharge damage

Electronic components are sensitive to electrostatic discharge (ESD). Circuitry design and structure determine the degree of sensitivity. Networks built into many integrated circuits provide some protection, but in many cases, ESD contains enough power to alter device parameters or melt silicon junctions.

A discharge of static electricity from a finger or other conductor can destroy static-sensitive devices or microcircuitry. Even if the spark is neither felt nor heard, damage may have occurred.

An electronic device exposed to ESD may not be affected at all and can work perfectly throughout a normal cycle. Or the device may function normally for a while, then degrade in the internal layers, reducing its life expectancy.

---

**⚠ CAUTION:** To prevent damage to the computer when you are removing or installing internal components, observe these precautions:

Keep components in their electrostatic-safe containers until you are ready to install them.

Before touching an electronic component, discharge static electricity by using the guidelines described in this section.

Avoid touching pins, leads, and circuitry. Handle electronic components as little as possible.

If you remove a component, place it in an electrostatic-safe container.

---

The following table shows how humidity affects the electrostatic voltage levels generated by different activities.

---

**⚠ CAUTION:** A product can be degraded by as little as 700 V.

---

**Typical electrostatic voltage levels**

<b>Event</b>	<b>Relative humidity</b>		
	<b>10%</b>	<b>40%</b>	<b>55%</b>
Walking across carpet	35,000 V	15,000 V	7,500 V
Walking across vinyl floor	12,000 V	5,000 V	3,000 V
Motions of bench worker	6,000 V	800 V	400 V
Removing DIPS from plastic tube	2,000 V	700 V	400 V
Removing DIPS from vinyl tray	11,500 V	4,000 V	2,000 V
Removing DIPS from Styrofoam	14,500 V	5,000 V	3,500 V
Removing bubble pack from PCB	26,500 V	20,000 V	7,000 V
Packing PCBs in foam-lined box	21,000 V	11,000 V	5,000 V

## Packaging and transporting guidelines

Follow these grounding guidelines when packaging and transporting equipment:

- To avoid hand contact, transport products in static-safe tubes, bags, or boxes.
- Protect ESD-sensitive parts and assemblies with conductive or approved containers or packaging.
- Keep ESD-sensitive parts in their containers until the parts arrive at static-free workstations.
- Place items on a grounded surface before removing items from their containers.
- Always be properly grounded when touching a component or assembly.
- Store reusable ESD-sensitive parts from assemblies in protective packaging or nonconductive foam.
- Use transporters and conveyors made of antistatic belts and roller bushings. Be sure that mechanized equipment used for moving materials is wired to ground and that proper materials are selected to avoid static charging. When grounding is not possible, use an ionizer to dissipate electric charges.

## Workstation guidelines

Follow these grounding workstation guidelines:

- Cover the workstation with approved static-shielding material.
- Use a wrist strap connected to a properly grounded work surface and use properly grounded tools and equipment.
- Use conductive field service tools, such as cutters, screwdrivers, and vacuums.
- When fixtures must directly contact dissipative surfaces, use fixtures made only of static-safe materials.
- Keep the work area free of nonconductive materials, such as ordinary plastic assembly aids and Styrofoam.
- Handle ESD-sensitive components, parts, and assemblies by the case or PCM laminate. Handle these items only at static-free workstations.
- Avoid contact with pins, leads, or circuitry.
- Turn off power and input signals before inserting or removing connectors or test equipment.

## Equipment guidelines

Grounding equipment must include either a wrist strap or a foot strap at a grounded workstation.

- When seated, wear a wrist strap connected to a grounded system. Wrist straps are flexible straps with a minimum of one megohm  $\pm 10\%$  resistance in the ground cords. To provide proper ground, wear a strap snugly against the skin at all times. On grounded mats with banana-plug connectors, use alligator clips to connect a wrist strap.
- When standing, use foot straps and a grounded floor mat. Foot straps (heel, toe, or boot straps) can be used at standing workstations and are compatible with most types of shoes or boots. On conductive floors or dissipative floor mats, use foot straps on both feet with a minimum of one megohm resistance between the operator and ground. To be effective, the conductive must be worn in contact with the skin.

The following grounding equipment is recommended to prevent electrostatic damage:

- Antistatic tape
- Antistatic smocks, aprons, and sleeve protectors
- Conductive bins and other assembly or soldering aids
- Nonconductive foam
- Conductive tabletop workstations with ground cords of one megohm resistance
- Static-dissipative tables or floor mats with hard ties to the ground
- Field service kits
- Static awareness labels
- Material-handling packages
- Nonconductive plastic bags, tubes, or boxes
- Metal tote boxes
- Electrostatic voltage levels and protective materials

The following table lists the shielding protection provided by antistatic bags and floor mats.

Material	Use	Voltage protection level
Antistatic plastics	Bags	1,500 V
Carbon-loaded plastic	Floor mats	7,500 V
Metallized laminate	Floor mats	5,000 V

## Component replacement procedures

This chapter provides removal and replacement procedures.

There are as many as 77 screws that must be removed, replaced, or loosened when servicing the computer. Make special note of each screw size and location during removal and replacement.

## Service tag

When ordering parts or requesting information, provide the computer serial number and model number provided on the service tag, which is found on the bottom of the computer.

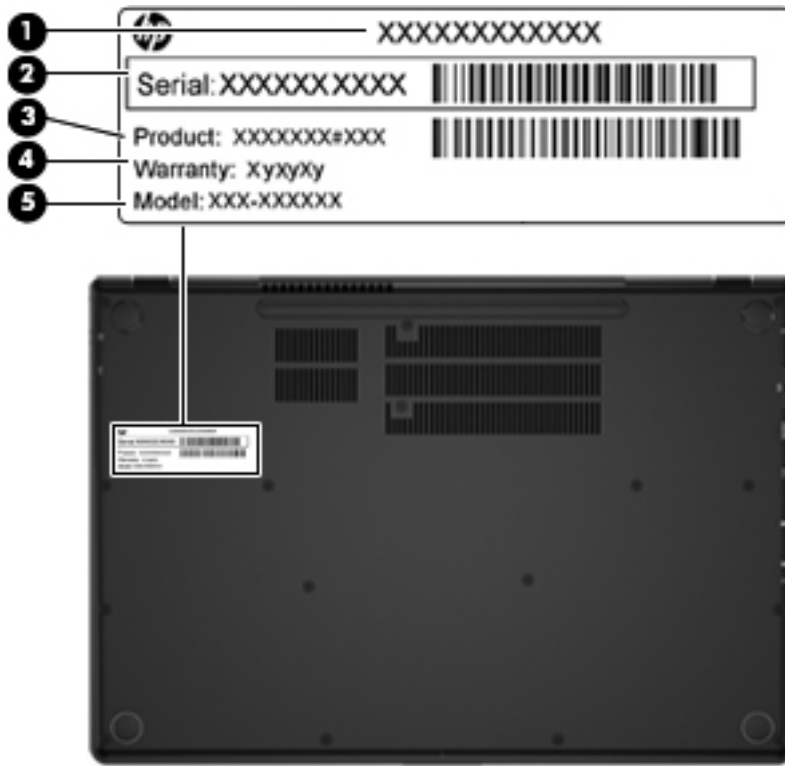

Item	Component	Description
(1)	Product name	This is the product name affixed to the front of the computer.
(2)	Serial number (s/n)	This is an alphanumeric identifier that is unique to each product.
(3)	Part number/Product number (p/n)	This number provides specific information about the product's hardware components. The part number helps a service technician determine what components and parts are needed.
(4)	Warranty period	This number describes the duration of the warranty period for the computer.
(5)	Model description	This is the alphanumeric identifier used to locate documents, drivers, and support for the computer.

## Computer feet

The computer feet are adhesive-backed rubber pads. There are 4 rubber feet that attach to the base enclosure in the locations illustrated below. All 4 feet are available in the Rubber Kit, spare part number 672363-001.

- ▲ Remove the four rubber feet from the base enclosure.

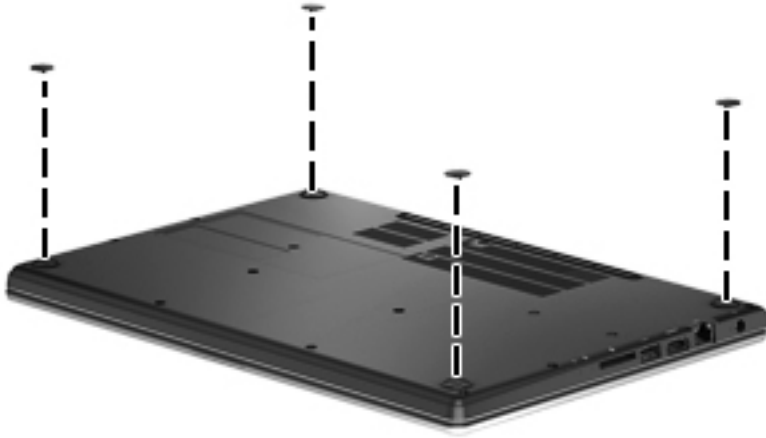

## Base enclosure

Description	Spare part number
Base enclosure	672356-001

Before disassembling the computer, follow these steps:

1. Shut down the computer. If you are unsure whether the computer is off or in Hibernation, turn the computer on, and then shut it down through the operating system.
2. Disconnect all external devices connected to the computer.
3. Disconnect the power from the computer by first unplugging the power cord from the AC outlet and then unplugging the AC adapter from the computer.

Remove the base enclosure screws:

- ▲ Turn the computer face down, remove the 16 Phillips PM 2.0×6 screws, and remove the base enclosure screws.

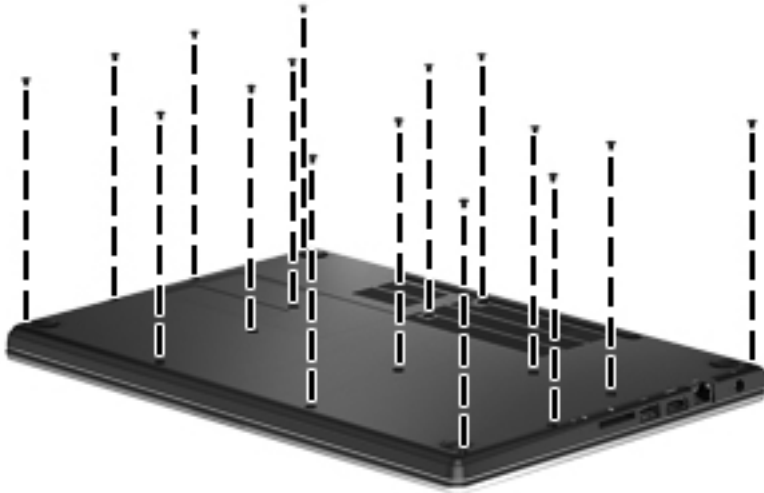

**CAUTION:** Before removing the base enclosure screws, do not use a pressure of more than 3.0 kgf-cm screw torque for the 3 Phillips PM 2.0x6.0 screws in the following locations:

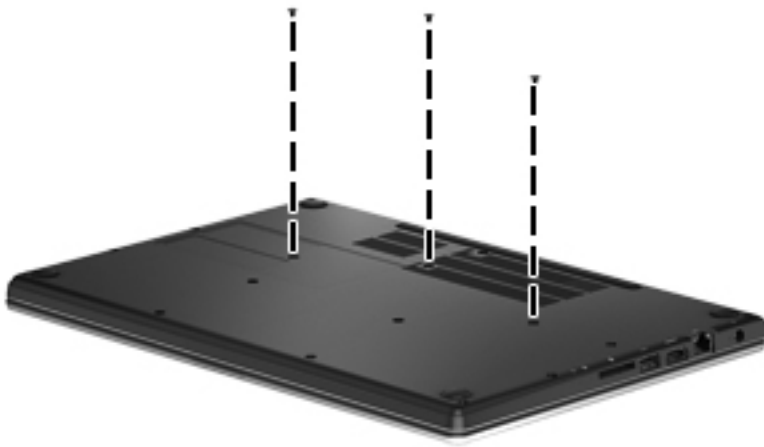

## Keyboard

**NOTE:** The keyboard spare part kit includes a keyboard cable.

For use in country or region:	Spare part number:	For use in country or region:	Spare part number:
Keyboard in black finish:			
For use in the United States	673656-001	For use in Latin America	673656-161
For use in Canada	673656-121	For use in Thailand	673656-281
For use in Japan	673656-291	For use in Taiwan	673656-AB1
For use in South Korea	673656-AD1	For use in the United Kingdom and Singapore	673656-031
For use in France	673656-051	For use in Italy	673656-061

For use in country or region:	Spare part number:	For use in country or region:	Spare part number:
For use in Saudi Arabia	673656-171	For use in Russia	673656-251
For use in The Netherlands	673656-B31	For use in Switzerland	673656-BG1
For use in Denmark, Finland, Norway	673656-DH1	For use in Spain	673656-071

Before removing the keyboard, follow these steps:

1. Shut down the computer. If you are unsure whether the computer is off or in Hibernation, turn the computer on, and then shut it down through the operating system.
2. Disconnect all external devices connected to the computer.
3. Disconnect the power from the computer by first unplugging the power cord from the AC outlet and then unplugging the AC adapter from the computer.
4. Remove the base enclosure screws (see [Base enclosure on page 25](#)).

Remove the keyboard:

1. Turn the computer right-side up with the front facing you.
2. Partially open the computer.
3. At the right side of the computer, insert a screwdriver or similar thin tool into the top cover release area, pressing upwards until the top cover starts to disengage from the computer.
4. Lift the right side of the top cover, and then press upwards behind the **Backspace** key to release the keyboard from the top cover.



5. Lift the rear edge of the keyboard, gently swing the keyboard forward slightly, and disconnect the keyboard's zero insertion force (ZIF) cable **(1)**.
6. Disconnect the keyboard light cable **(2)**.

7. Remove the keyboard (3).

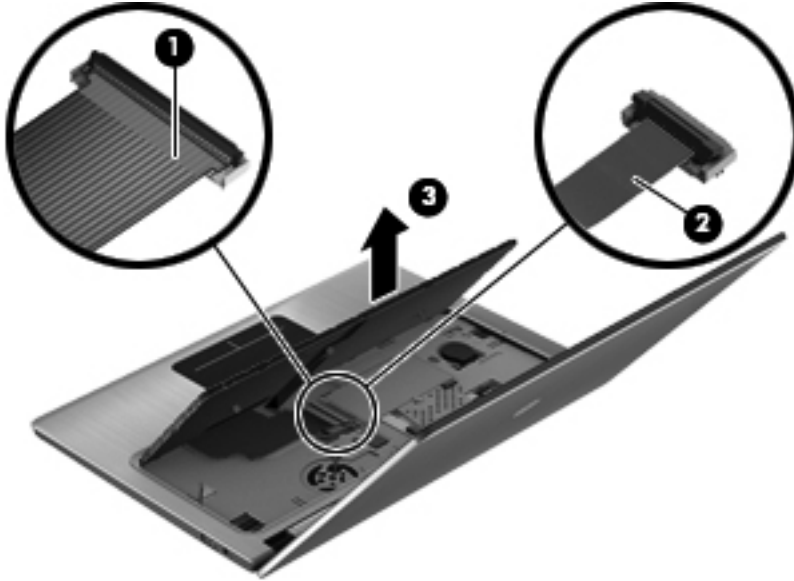

Reverse this procedure to install the keyboard.

## Top cover



**NOTE:** The top cover spare part kit includes the power button board and cable and the TouchPad and cable.

Description	Spare part number
Top cover	672357-001

Before removing the top cover, follow these steps:

1. Shut down the computer. If you are unsure whether the computer is off or in Hibernation, turn the computer on, and then shut it down through the operating system.
2. Disconnect all external devices connected to the computer.
3. Disconnect the power from the computer by first unplugging the power cord from the AC outlet and then unplugging the AC adapter from the computer.
4. Remove the base enclosure screws (see [Base enclosure on page 25](#)).
5. Remove the keyboard (see [Keyboard on page 26](#)).

When replacing the top cover, be sure that the TouchPad button board and cable (see [TouchPad button board on page 31](#)) are removed from the defective top cover and installed on the replacement top cover.

Remove the top cover:

1. Turn the computer right-side up, with the front toward you.
2. Open the computer.

3. Disconnect the following cables:
  - (1) Power button board cable
  - (2) TouchPad button board cable

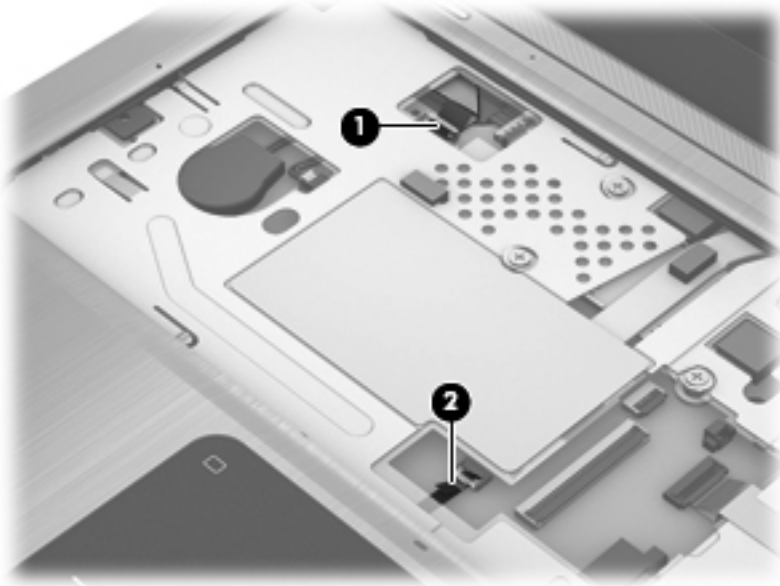

4. Lift the rear edge of the top cover until the left and right sides disengage from the base enclosure, and remove the top cover.

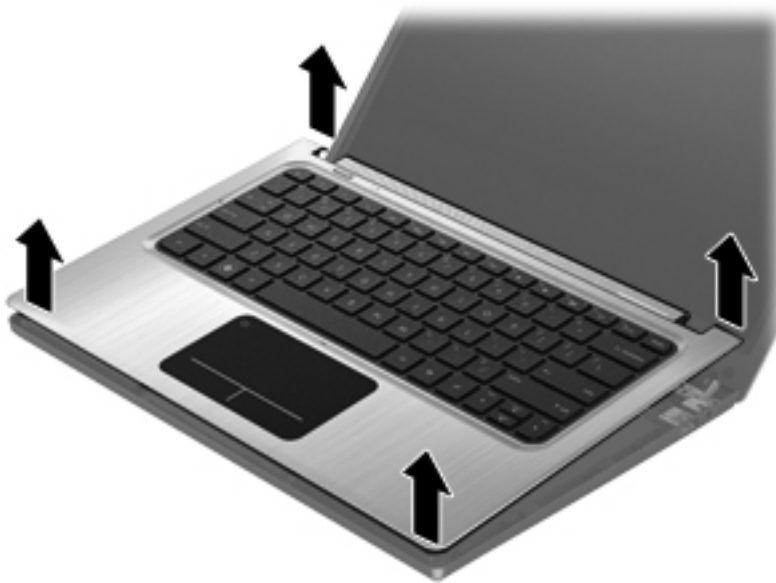

Reverse this procedure to install the top cover.

## Power button board

Description	Spare part number
Power button board	672357-001

Before removing the Power button board, follow these steps:

1. Shut down the computer. If you are unsure whether the computer is off or in Hibernation, turn the computer on, and then shut it down through the operating system.
2. Disconnect all external devices connected to the computer.
3. Disconnect the power from the computer by first unplugging the power cord from the AC outlet and then unplugging the AC adapter from the computer.
4. Remove the base enclosure screws (see [Base enclosure on page 25](#)).
5. Remove the keyboard (see [Keyboard on page 26](#)).
6. Remove the top cover (see [Top cover on page 28](#)).
7. Disconnect the battery cable (see [Battery on page 32](#)).

Remove the Power button board and cable:

1. Turn the top cover upside down, with the back edge toward you.
2. Remove the 2 Phillips PM 2.0x3x0 screws securing the Power button board to the top cover **(1)**.
3. Remove the Power button board **(2)**.

---

 **NOTE:** The Power button board's cable is attached to the board.

---

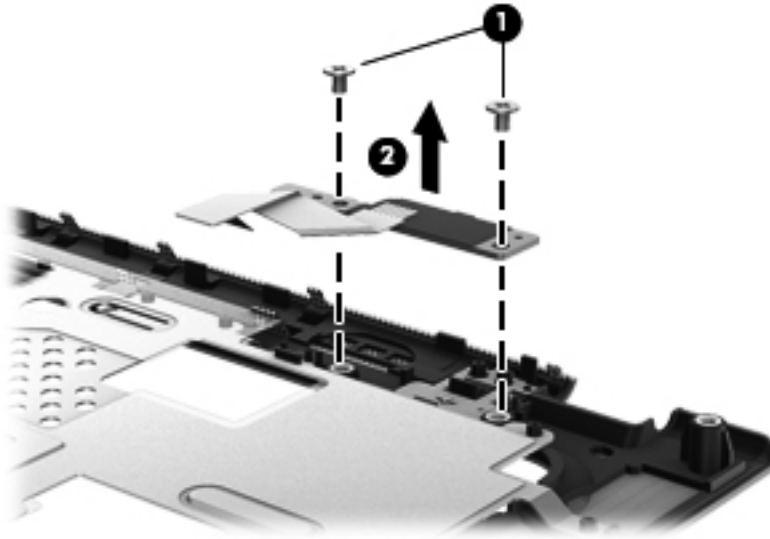

## TouchPad button board

Description	Spare part number
TouchPad button board (includes cable)	672357-001

Before removing the TouchPad button board, follow these steps:

1. Shut down the computer. If you are unsure whether the computer is off or in Hibernation, turn the computer on, and then shut it down through the operating system.
2. Disconnect all external devices connected to the computer.
3. Disconnect the power from the computer by first unplugging the power cord from the AC outlet and then unplugging the AC adapter from the computer.
4. Remove the base enclosure screws (see [Base enclosure on page 25](#)).
5. Remove the keyboard (see [Keyboard on page 26](#)).
6. Remove the top cover (see [Top cover on page 28](#)).

Remove the TouchPad button board and cable:

1. Turn the top cover upside down, with the back edge toward you.
2. Remove the 5 Phillips PM 2.0×3.8 screws (1) that secure the TouchPad button board to the top cover.
3. Remove the TouchPad bracket (2).
4. Remove the TouchPad button board and cable (3).

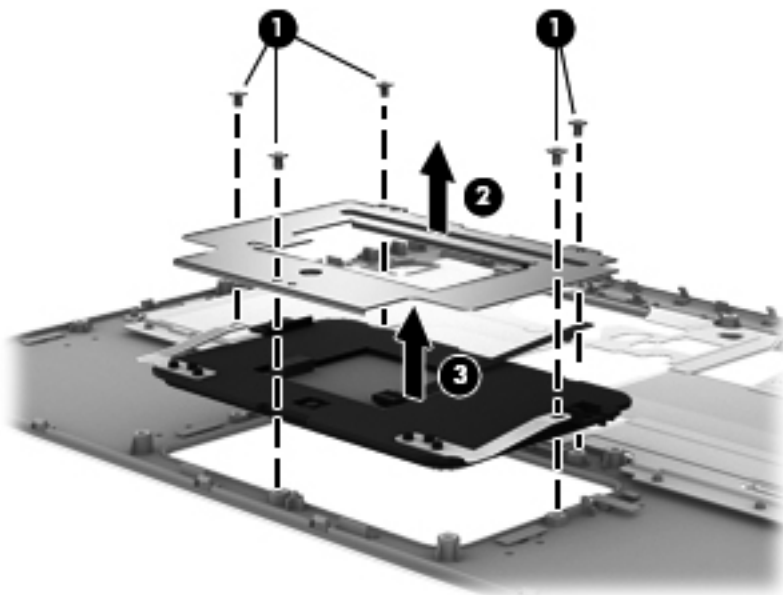

Reverse this procedure to install the TouchPad button board and cable.

## Battery

Description	Spare part number
6-cell, 59 WHr 5.4AH Li-ion battery	671602-001

Before removing the battery, follow these steps:

1. Shut down the computer. If you are unsure whether the computer is off or in Hibernation, turn the computer on, and then shut it down through the operating system.
2. Disconnect all external devices connected to the computer.
3. Disconnect the power from the computer by first unplugging the power cord from the AC outlet and then unplugging the AC adapter from the computer.
4. Remove the base enclosure screws (see [Base enclosure on page 25](#)).
5. Remove the keyboard (see [Keyboard on page 26](#)).
6. Remove the top cover (see [Top cover on page 28](#)).

Remove the battery:

1. Turn the computer right-side up, with the front toward you.
2. Disconnect the battery cable.

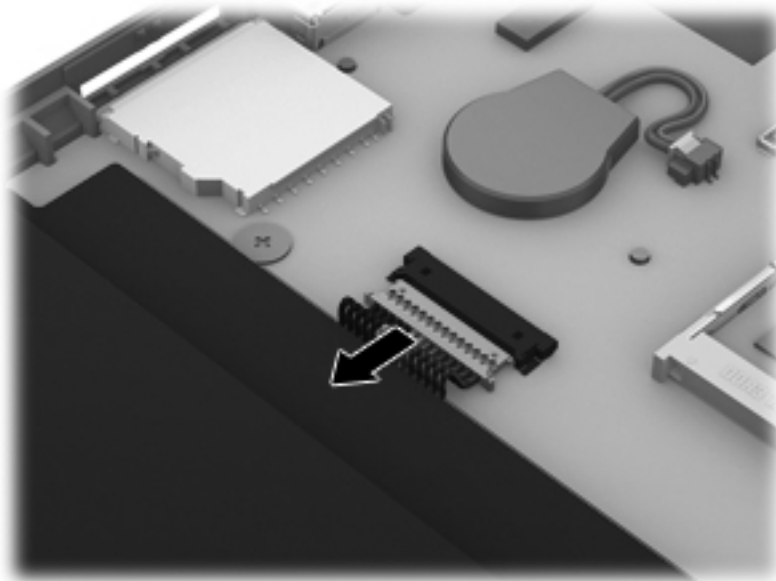

3. Remove the 2 Phillips PM 2.0×3.0 screws that secure the battery to the computer (1).

4. Support the display panel while lifting the battery slightly, and then slide it forward (2). Remove the battery from the computer (3).

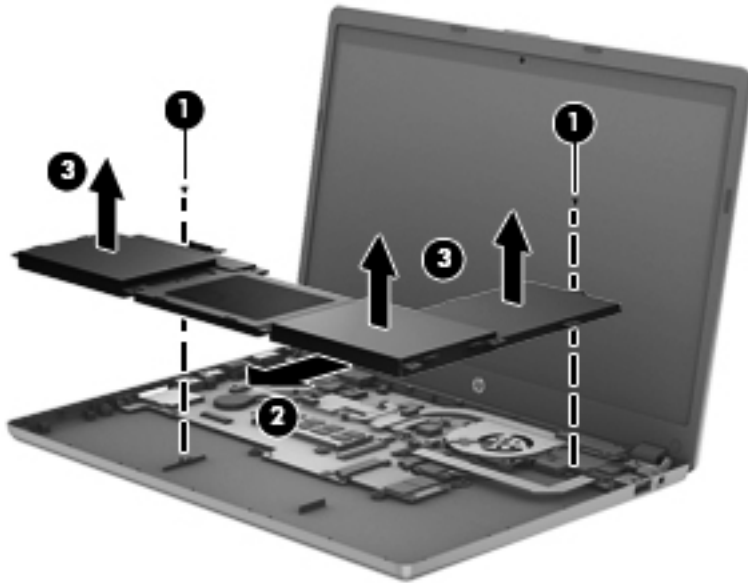

---

**⚠ CAUTION:** Make sure that you balance the battery carefully so that it is not damaged.

---

Reverse this procedure to install the battery.

## Display panel

Description	Spare part number
13.3-in, LED, BrightView SVA display panel	672350-001

Before removing the display panel, follow these steps:

1. Shut down the computer. If you are unsure whether the computer is off or in Hibernation, turn the computer on, and then shut it down through the operating system.
2. Disconnect all external devices connected to the computer.
3. Disconnect the power from the computer by first unplugging the power cord from the AC outlet and then unplugging the AC adapter from the computer.
4. Remove the base enclosure screws (see [Base enclosure on page 25](#)).
5. Remove the keyboard (see [Keyboard on page 26](#)).
6. Remove the top cover (see [Top cover on page 28](#)).
7. Disconnect the battery cable (see [Battery on page 32](#)).

Remove the display panel:

1. Turn the computer right-side up, with the front toward you.
2. Open the computer.
3. Disconnect the display panel cable from the system board **(1)**.
4. Disconnect the USB/Audio board cable from the system board **(2)**.
5. Disconnect the #1 and #2 WLAN antenna cables from the WLAN module **(3)**.



**NOTE:** The #1 WLAN antenna cable is connected to the WLAN module #1 terminal. The #2 WLAN antenna cable is connected to the WLAN module #2 terminal. For more information, see [WLAN module on page 36](#).

6. Ensure that the cables are released from the routing clips, the interior computer channels, and the right speaker clips (4).

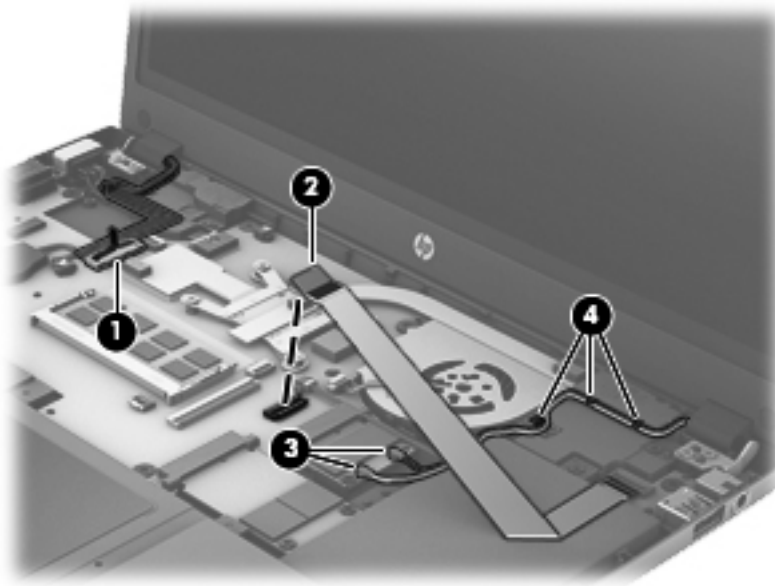

7. Remove the 5 screws (1) securing the display panel to the computer. There are 3 screws on the left hinge and 2 screws on the right hinge.



**NOTE:** Support the display panel as you are removing the screws.

8. Lift and remove the display panel (2).

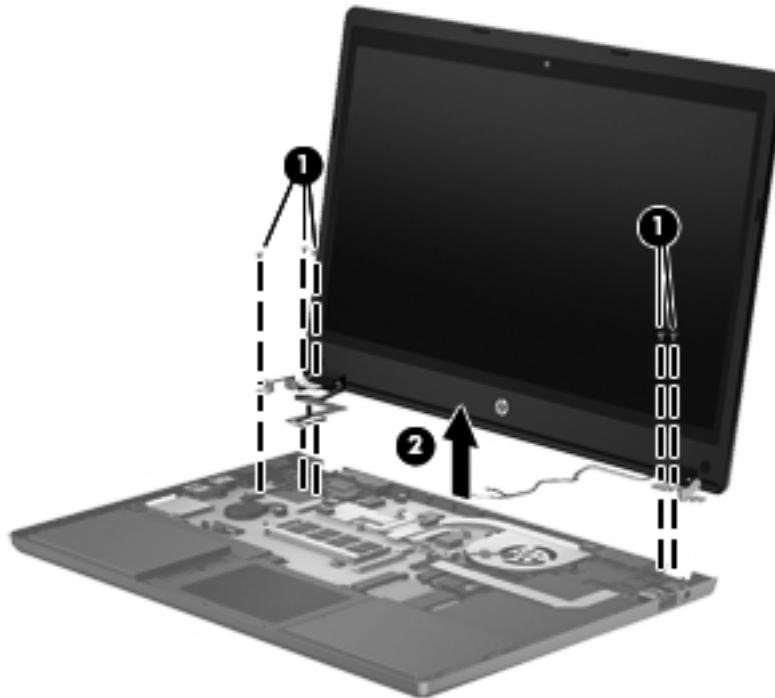

Reverse this procedure to install the display panel.

## WLAN module

Description	Spare part number
Intel® Centrino® Wireless-N 1030 + Bluetooth combo w/ *2 antennas (802.11 b/g/n, Bluetooth 3.0)	631956-001
Atheros 9485GN 802.11b/g/n 1×1 WiFi and 3012 Bluetooth 4.0 Combo Adapter	655795-001
Broadcom 4313GN 802.11b/g/n 1×1 WiFi and 20702 Bluetooth 4.0 Combo Adapter	657325-001

 **CAUTION:** To prevent an unresponsive system, replace the wireless module only with a wireless module authorized for use in the computer by the governmental agency that regulates wireless devices in your country or region. If you replace the module and then receive a warning message, remove the module to restore device functionality, and then contact technical support.

Before removing the WLAN module, follow these steps:

1. Shut down the computer. If you are unsure whether the computer is off or in Hibernation, turn the computer on, and then shut it down through the operating system.
2. Disconnect all external devices connected to the computer.
3. Disconnect the power from the computer by first unplugging the power cord from the AC outlet and then unplugging the AC adapter from the computer.
4. Remove the base enclosure screws (see [Base enclosure on page 25](#)).
5. Remove the keyboard (see [Keyboard on page 26](#)).
6. Remove the top cover (see [Top cover on page 28](#)).
7. Disconnect the battery cable (see [Battery on page 32](#)).

Remove the WLAN module:

1. Disconnect the USB/Audio board cable from the system board **(1)**.
2. Disconnect the #1 and #2 WLAN antenna cables from the WLAN module.





**NOTE:** The #1 WLAN antenna cable is connected to the WLAN module #1 terminal. The #2 WLAN antenna cable is connected to the WLAN module #2 terminal.

3. Remove the Phillips PM 2.0×2.5 screw **(3)** that secures the WLAN module to the system board. (The WLAN module tilts up.)

4. Remove the WLAN module by pulling the module away from the slot at an angle **(4)**.

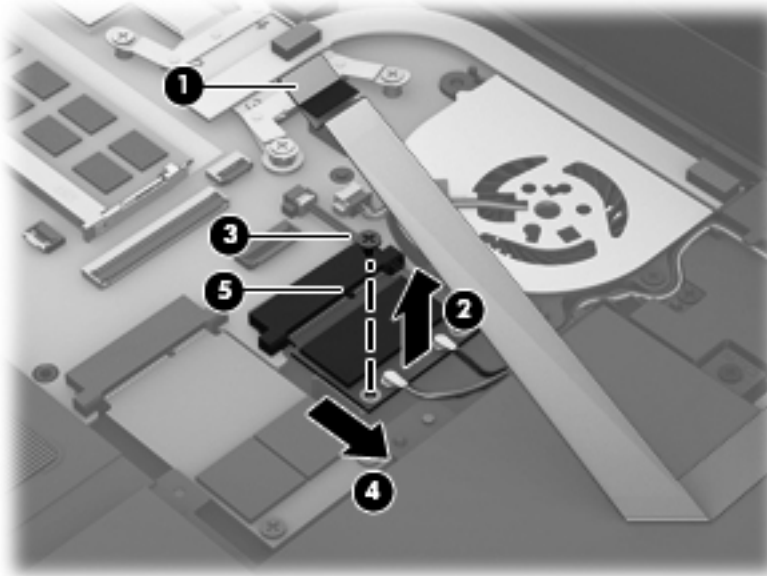
 **NOTE:** WLAN modules are designed with a notch **(5)** to prevent incorrect insertion into the memory module slot.



 **NOTE:** If the WLAN antennas are not connected to the terminals on the WLAN module, the protective sleeves must be installed on the antenna connectors.

## USB/Audio board

Description	Spare part number
USB/Audio board	672358-001

Before removing the USB/Audio board, follow these steps:

1. Shut down the computer. If you are unsure whether the computer is off or in Hibernation, turn the computer on, and then shut it down through the operating system.
2. Disconnect all external devices connected to the computer.
3. Disconnect the power from the computer by first unplugging the power cord from the AC outlet and then unplugging the AC adapter from the computer.
4. Remove the base enclosure screws (see [Base enclosure on page 25](#)).
5. Remove the keyboard (see [Keyboard on page 26](#)).
6. Remove the top cover (see [Top cover on page 28](#)).
7. Disconnect the battery cable (see [Battery on page 32](#)).

Remove the USB/Audio board:

1. Disconnect the USB/Audio board cable from the system board **(1)**
2. Disconnect the Phillips PM 2.0x2.0 screw securing the USB/Audio board **(2)**.

3. Remove the USB/Audio board (3).

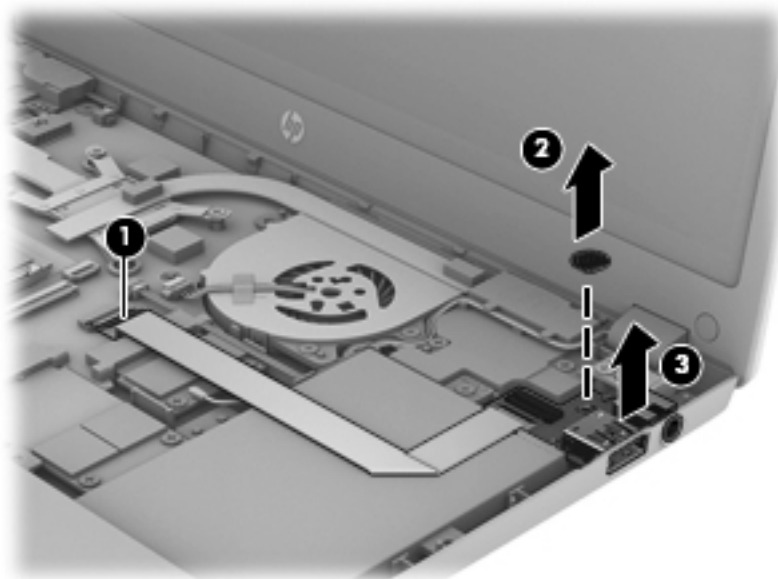

## RTC battery

Description	Spare part number
RTC battery	672349-001

Before removing the RTC battery, follow these steps:

1. Shut down the computer. If you are unsure whether the computer is off or in Hibernation, turn the computer on, and then shut it down through the operating system.
2. Disconnect all external devices connected to the computer.
3. Disconnect the power from the computer by first unplugging the power cord from the AC outlet and then unplugging the AC adapter from the computer.
4. Remove the base enclosure screws (see [Base enclosure on page 25](#)).
5. Remove the keyboard (see [Keyboard on page 26](#)).
6. Remove the top cover (see [Top cover on page 28](#)).
7. Disconnect the battery cable (see [Battery on page 32](#)).

Remove the RTC battery:

1. Disconnect the RTC battery cable from the system board (1).
2. Remove the RTC battery (2). Use a thin, non-conductive tool to remove the RTC battery from the socket on the system board. (The RTC battery is also attached to the system board with double-sided tape.)

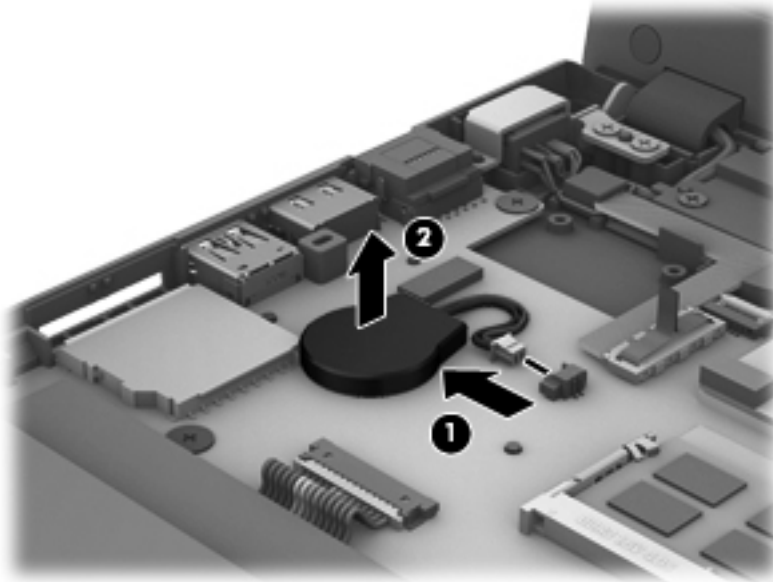

Reverse this procedure to install the RTC battery on computer models. When installing the RTC battery, make sure the “+” sign faces up.

## Hard drive

Description	Spare part number
128-GB mSATA solid-state drive (SSD)	672616-001

Before removing the hard drive, follow these steps:

1. Shut down the computer. If you are unsure whether the computer is off or in Hibernation, turn the computer on, and then shut it down through the operating system.
2. Disconnect all external devices connected to the computer.
3. Disconnect the power from the computer by first unplugging the power cord from the AC outlet and then unplugging the AC adapter from the computer.
4. Remove the base enclosure screws (see [Base enclosure on page 25](#)).
5. Remove the keyboard (see [Keyboard on page 26](#)).
6. Remove the top cover (see [Top cover on page 28](#)).
7. Disconnect the battery cable (see [Battery on page 32](#)).

Remove the hard drive:

1. Remove the 2 Phillips PM 2.0×2.5 screws **(1)** that secure the hard drive to the computer. (The hard drive tilts up.)
2. Pull the hard drive to the right**(2)**.
3. Remove the hard drive **(3)**.

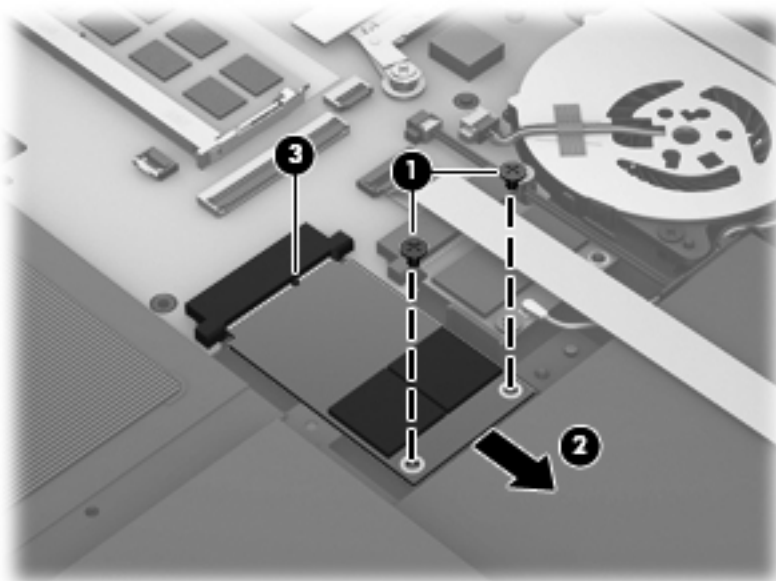

Reverse this procedure to reassemble and install the hard drive.

## Memory module

Description	Spare part number
4-GB memory module (PC3, 10600, 1333-MHz)	641369-001

Before removing a memory module, follow these steps:

1. Shut down the computer. If you are unsure whether the computer is off or in Hibernation, turn the computer on, and then shut it down through the operating system.
2. Disconnect all external devices connected to the computer.
3. Disconnect the power from the computer by first unplugging the power cord from the AC outlet and then unplugging the AC adapter from the computer.
4. Remove the base enclosure screws (see [Base enclosure on page 25](#)).
5. Remove the keyboard (see [Keyboard on page 26](#)).
6. Remove the top cover (see [Top cover on page 28](#)).
7. Disconnect the battery cable (see [Battery on page 32](#)).

Remove the memory module:

1. Spread the retaining tabs **(1)** on each side of the memory module slot to release the memory module. (The memory module tilts up.)

**⚠ CAUTION:** To prevent damage to the memory module, hold it by the edges only. Do not touch the components on the memory module.

2. Slide the memory module forward **(2)**.
3. Remove the memory module **(3)**.

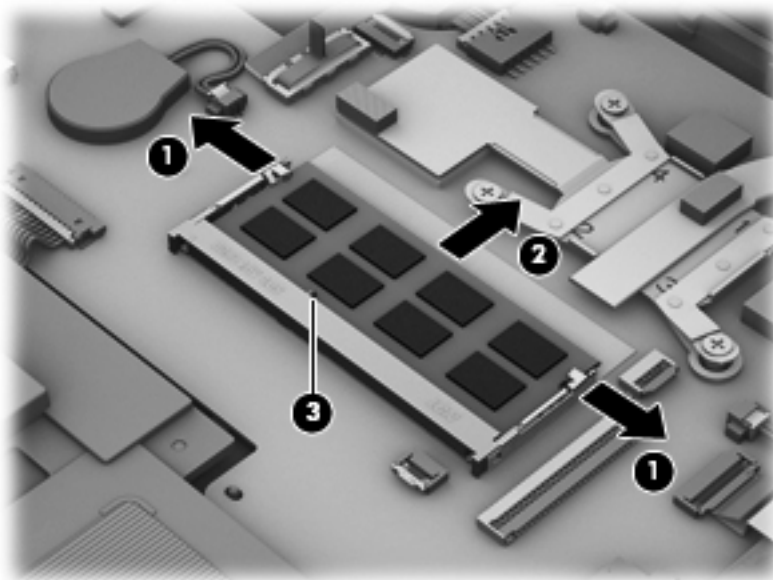

Reverse this procedure to install a memory module.

## Speakers

Description	Spare part number
Speaker Kit (includes left and right speakers and cable)	672353-001

Before removing the speakers, follow these steps:

1. Shut down the computer. If you are unsure whether the computer is off or in Hibernation, turn the computer on, and then shut it down through the operating system.
2. Disconnect all external devices connected to the computer.
3. Disconnect the power from the computer by first unplugging the power cord from the AC outlet and then unplugging the AC adapter from the computer.
4. Remove the base enclosure screws (see [Base enclosure on page 25](#)).
5. Remove the keyboard (see [Keyboard on page 26](#)).
6. Remove the top cover (see [Top cover on page 28](#)).
7. Disconnect the battery cable (see [Battery on page 32](#)).

Remove the speakers:

1. Turn the computer, with the front edge toward you.
2. Release the speaker cables from the clips (1).
3. Release the 2 Phillips PM 2.0×3.0 screws securing each speaker. (2)
4. Remove the speakers and cables (3).

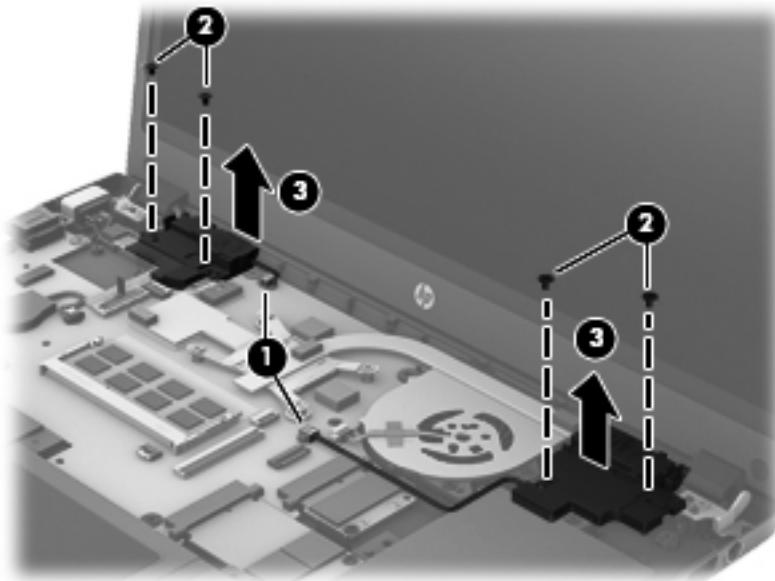

Reverse this procedure to install the speakers.

## System board



**NOTE:** The system board spare part kit includes replacement thermal material.

Description	Spare part number
For use only with computer models equipped with an Intel 1.4 GHz processor, but not WWAN capability (includes replacement thermal material)	672351-001
For use only with computer models equipped with an Intel 1.6 GHz processor but not WWAN capability (includes replacement thermal material)	672352-001

Before removing the system board, follow these steps:

1. Shut down the computer. If you are unsure whether the computer is off or in Hibernation, turn the computer on, and then shut it down through the operating system.
2. Disconnect all external devices connected to the computer.
3. Disconnect the power from the computer by first unplugging the power cord from the AC outlet and then unplugging the AC adapter from the computer.
4. Remove the base enclosure screws (see [Base enclosure on page 25](#)).
5. Remove the keyboard (see [Keyboard on page 26](#)),
6. Remove the top cover (see [Top cover on page 28](#)).
7. Remove the battery (see [Battery on page 32](#)).
8. Remove the WLAN module (see [WLAN module on page 36](#)).
9. Remove the hard drive (see [Hard drive on page 40](#)).
10. Disconnect the display panel cable from the system board (see [Display panel on page 34](#)).
11. Remove the speaker (see [Speakers on page 42](#)).
12. Remove the power connector and cable (see [Power connector cable on page 44](#)).
13. Remove the USB/Audio and cable (see [USB/Audio](#)).

When replacing the system board, be sure that the following components are removed from the defective system board and installed on the replacement system board:

- RTC battery (see [RTC battery on page 39](#))
- Memory module (see [Memory module on page 41](#))
- Power connector cable (see [Power connector cable on page 44](#))
- Fan (see [Fan/Heat sink on page 46](#))
- Heat sink (see [Fan/Heat sink on page 46](#))
- WLAN module see ([WLAN module on page 36](#)).
- Hard drive (see [Hard drive on page 40](#)).
- USB/Audio (see [USB/Audio](#))
- Display panel cable (see [Display panel on page 34](#)).

Remove the system board:

1. Remove the 4 Phillips PM 2.0×2.0 system board screws.

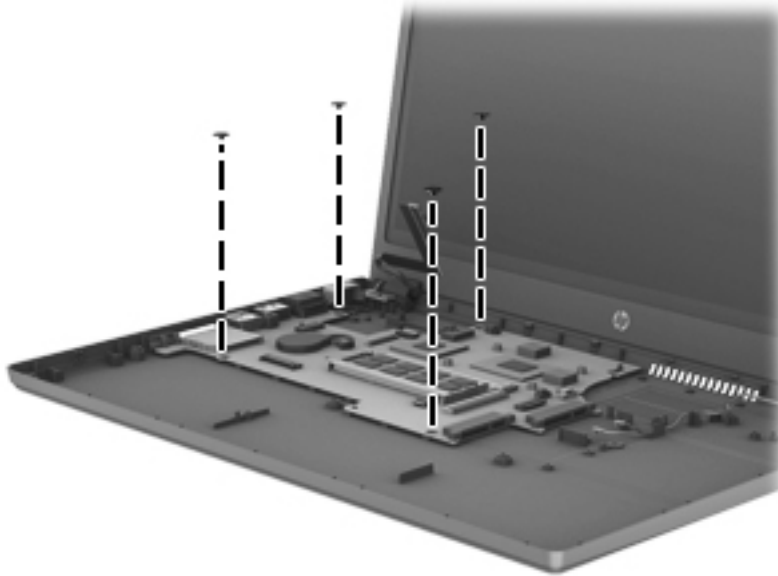

2. Lift the right side of the system board (1) until it rests at an angle.
3. Remove the system board (2) by sliding it up and to the right at an angle.

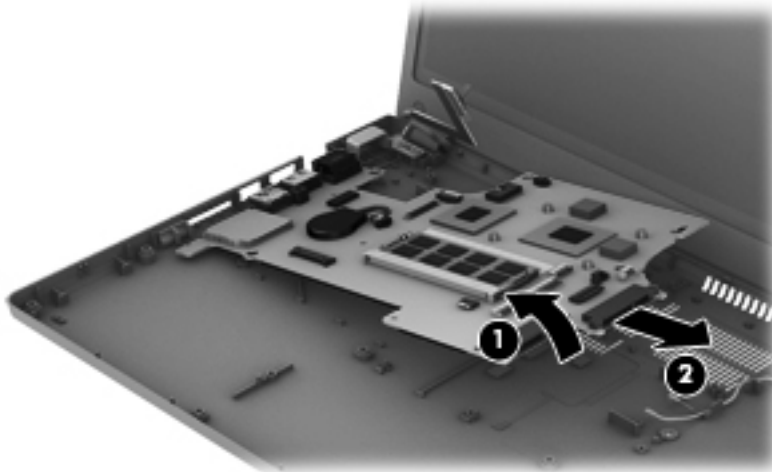

Reverse this procedure to install the system board.

## Power connector cable

Description	Spare part number
Power connector cable (includes bracket)	672361-001

Before removing the power connector cable, follow these steps:

1. Shut down the computer. If you are unsure whether the computer is off or in Hibernation, turn the computer on, and then shut it down through the operating system.
2. Disconnect all external devices connected to the computer.
3. Disconnect the power from the computer by first unplugging the power cord from the AC outlet and then unplugging the AC adapter from the computer.
4. Remove the base enclosure screws (see [Base enclosure on page 25](#)).
5. Remove the keyboard (see [Keyboard on page 26](#)).
6. Remove the top cover (see [Top cover on page 28](#)).
7. Remove the display panel (see [Display panel on page 34](#)).
8. Disconnect the battery cable (see [Battery on page 32](#)).
9. Remove the speakers (see [Speakers on page 42](#)).

Remove the power connector cable:

1. Turn the computer, with the right side toward you.
2. Disconnect the power connector cable **(1)** from the system board.
3. Remove the double-sided tape **(2)** from the power connector.
4. Remove the power connector cable **(3)**.

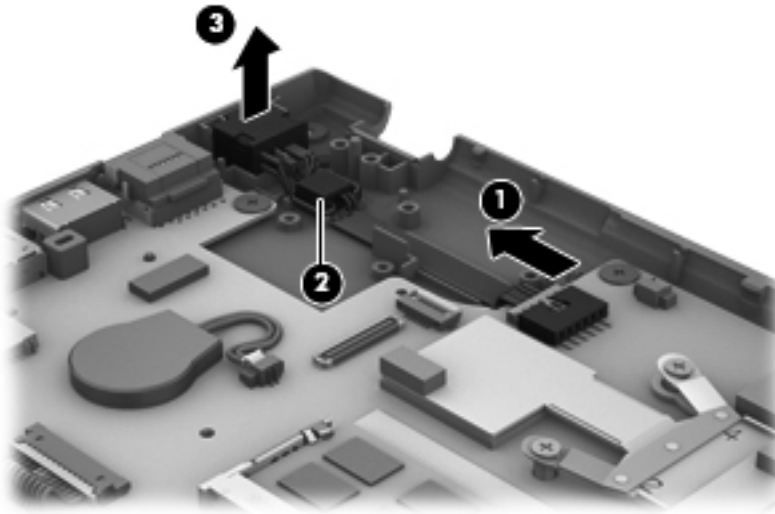

Reverse this procedure to install the power connector cable and bracket.

## Fan/Heat sink

Description	Spare part number
Fan	672354-001
Heat sink	672355-001

 **NOTE:** To properly ventilate the computer, allow at least 7.6 cm (3 in) of clearance on the left side of the computer. The computer uses an electric fan for ventilation. The fan is controlled by a temperature sensor and is designed to turn on automatically when high temperature conditions exist. These conditions are affected by high external temperatures, system power consumption, power management/battery conservation configurations, battery fast charging, and software requirements. Exhaust air is displaced through the ventilation grill located on the left side of the computer.

Before removing the fan, follow these steps:

1. Shut down the computer. If you are unsure whether the computer is off or in Hibernation, turn the computer on, and then shut it down through the operating system.
2. Disconnect all external devices connected to the computer.
3. Disconnect the power from the computer by first unplugging the power cord from the AC outlet and then unplugging the AC adapter from the computer.
4. Remove the base enclosure screws (see [Base enclosure on page 25](#)).
5. Remove the keyboard (see [Keyboard on page 26](#)).
6. Remove the top cover (see [Top cover on page 28](#)).
7. Disconnect the battery cable (see [Battery on page 32](#)),

Remove the fan:

1. Turn the computer, with the front toward you.
2. Disconnect the fan cable **(1)** from the system board.
3. Remove the 4 Phillips PM 2.0×3.0 screws securing the heat sink **(2)**, and the 2 Phillips PM 2.0×3.0 screws securing the fan **(3)**.

4. Remove the fan and heat sink (4).

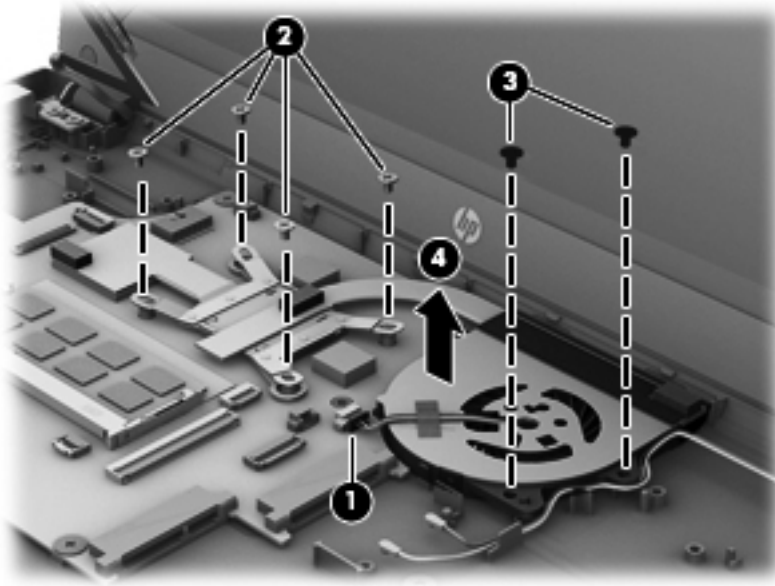

5. Remove the double-sided tape securing the fan to the heat sink (1) and remove the fan (2).

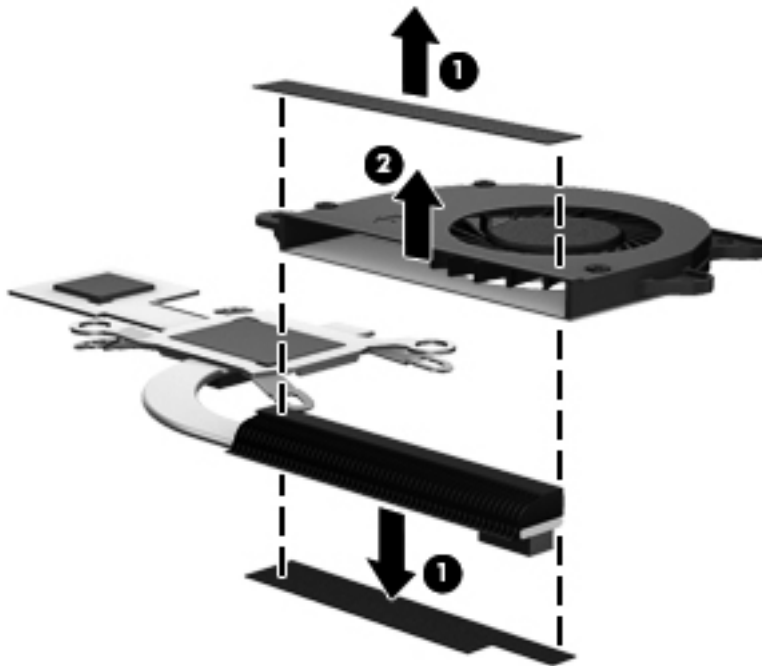

Reverse this procedure to install the fan and the heat sink..

---

# 5 Setup Utility (BIOS) and System Diagnostics

## Using Setup Utility

Setup Utility, or Basic Input/Output System (BIOS), controls communication between all the input and output devices on the system (such as disk drives, display, keyboard, mouse, and printer). Setup Utility includes settings for the types of peripherals installed, the startup sequence of the computer, and the amount of system and extended memory.

 **NOTE:** Use extreme care when making changes in Setup Utility. Errors can prevent the computer from operating properly.

---

## Starting Setup Utility

 **NOTE:** An external keyboard or mouse connected to a USB port can be used with Setup Utility only if USB legacy support is enabled.

---

To start Setup Utility, follow these steps:

1. Turn on or restart the computer, and then press **esc** while the “Press the ESC key for Startup Menu” message is displayed at the bottom of the screen.
2. Press **f10** to enter Setup Utility.

## Changing the language of Setup Utility

1. Start Setup Utility.
2. Use the arrow keys to select **System Configuration > Language**, and then press **enter**.
3. Use the arrow keys to select a language, and then press **enter**.
4. When a confirmation prompt with your language selected is displayed, press **enter**.
5. To save your change and exit Setup Utility, use the arrow keys to select **Exit > Exit Saving Changes**, and then press **enter**.

Your change takes effect immediately.

## Navigating and selecting in Setup Utility

To navigate and select in Setup Utility, follow these steps:

1. Turn on or restart the computer, and then press **esc** while the “Press the ESC key for Startup Menu” message is displayed at the bottom of the screen.
  - To select a menu or a menu item, use the tab key and the keyboard arrow keys and then press **enter**, or use a pointing device to click the item.
  - To scroll up and down, click the up arrow or the down arrow in the upper-right corner of the screen, or use the up arrow key or the down arrow key.
  - To close open dialog boxes and return to the main Setup Utility screen, press **esc**, and then follow the on-screen instructions.
2. Press **f10** to enter Setup Utility.

To exit Setup Utility menus, choose one of the following methods:

- To exit Setup Utility menus without saving your changes, press the **esc** key, and then follow the on-screen instructions.

– or –

Use the arrow keys to select **Exit > Exit Discarding Changes**, and then press **enter**.

- To save your changes and exit Setup Utility menus, press **f10**, and then follow the on-screen instructions.

– or –

Use the tab key and the arrow keys to select **Exit > Exit Saving Changes**, and then press **enter**.

Your changes go into effect when the computer restarts.

## Displaying system information

1. Start Setup Utility.
2. Select the **Main menu**. System information such as the system time and date, and identification information about the computer is displayed.
3. To exit Setup Utility without changing any settings, use the arrow keys to select **Exit > Exit Discarding Changes**, and then press **enter**.

## Restoring factory settings in Setup Utility

---

 **NOTE:** Restoring defaults will not change the hard drive mode.

---

To return all settings in Setup Utility to the values that were set at the factory, follow these steps:

1. Turn on or restart the computer, and then press **esc** while the “Press the ESC key for Startup Menu” message is displayed at the bottom of the screen.
2. Press **f10** to enter Setup Utility.
3. Use the arrow keys to select **Exit > Load Setup Defaults**.
4. Follow the on-screen instructions.
5. To save your changes and exit, press **f10**, and then follow the on-screen instructions.

– or –

Use the arrow keys to select **Exit > Exit Saving Changes**, and then press **enter**.

Your changes go into effect when the computer restarts.

---

 **NOTE:** Your password settings and security settings are not changed when you restore the factory settings.

---

## Exiting Setup Utility

- To exit Setup Utility and save your changes from the current session:

If the Setup Utility menus are not visible, press **esc** to return to the menu display. Then use the arrow keys to select **Exit > Exit Saving Changes**, and then press **enter**.

- To exit Setup Utility without saving your changes from the current session:

If the Setup Utility menus are not visible, press **esc** to return to the menu display. Then use the arrow keys to select **Exit > Exit Discarding Changes**, and then press **enter**.

## Updating the BIOS

Updated versions of the BIOS may be available on the HP Web site.

Most BIOS updates on the HP Web site are packaged in compressed files called *SoftPaqs*.

Some download packages contain a file named *Readme.txt*, which contains information regarding installing and troubleshooting the file.

## Determining the BIOS version

To determine whether available BIOS updates contain later BIOS versions than those currently installed on the computer, you need to know the version of the system BIOS currently installed.

BIOS version information (also known as *ROM date* and *System BIOS*) can be displayed by pressing **fn+esc** (if you are already in Windows) or by using Setup Utility.

1. Start Setup Utility (BIOS).
2. Use the arrow keys to select **Main**.
3. To exit Setup Utility (BIOS) without saving your changes, use the tab key and the arrow keys to select **Exit > Exit Discarding Changes**, and then press **enter**.

## Downloading a BIOS update

 **CAUTION:** To reduce the risk of damage to the computer or an unsuccessful installation, download and install a BIOS update only when the computer is connected to reliable external power using the AC adapter. Do not download or install a BIOS update while the computer is running on battery power, docked in an optional docking device, or connected to an optional power source. During the download and installation, follow these instructions:

Do not disconnect power from the computer by unplugging the power cord from the AC outlet.

Do not shut down the computer or initiate Sleep or Hibernation.

Do not insert, remove, connect, or disconnect any device, cable, or cord.

1. **Windows 7**—Select **Start > Help and Support > Maintain**.  
**Windows XP**—Select **Start > Help and Support**, and then select the software and drivers update.
2. Follow the on-screen instructions to identify your computer and access the BIOS update you want to download.
3. At the download area, follow these steps:
  - a. Identify the BIOS update that is later than the BIOS version currently installed on your computer. Make a note of the date, name, or other identifier. You may need this information to locate the update later, after it has been downloaded to your hard drive.
  - b. Follow the on-screen instructions to download your selection to the hard drive. Make a note of the path to the location on your hard drive where the BIOS update is downloaded. You will need to access this path when you are ready to install the update.



**NOTE:** If you connect your computer to a network, consult the network administrator before installing any software updates, especially system BIOS updates.

BIOS installation procedures vary. Follow any instructions that are displayed on the screen after the download is complete. If no instructions are displayed, follow these steps:

1. **Windows 7**—Open Windows Explorer by selecting **Start > Computer**.  
**Windows XP**—Open Windows Explorer by selecting **Start > My Computer**.
2. Double-click your hard drive designation. The hard drive designation is typically Local Disk (C:).
3. Using the hard drive path you recorded earlier, open the folder on your hard drive that contains the update.

4. Double-click the file that has an .exe extension (for example, *filename.exe*). The BIOS installation begins.
5. Complete the installation by following the on-screen instructions.



---

**NOTE:** After a message on the screen reports a successful installation, you can delete the downloaded file from your hard drive.

---

## Using System Diagnostics

System Diagnostics allows you to run diagnostic tests to determine if the computer hardware is functioning properly. The following diagnostic tests are available in System Diagnostics:

- **Start-up test**—This test analyzes the main computer components that are required to start the computer.
- **Run-in test**—This test repeats the start-up test and checks for intermittent problems that the start-up test does not detect.
- **Hard disk test**—This test analyzes the physical condition of the hard drive, and then checks all data in every sector of the hard drive. If the test detects a damaged sector, it attempts to move the data to a good sector.
- **Memory test**—This test analyzes the physical condition of the memory modules. If it reports an error, replace the memory modules immediately.
- **Battery test**—This test analyzes the condition of the battery. If the battery fails the test, contact HP support to report the issue and purchase a replacement battery.

You can also view system information and error logs in the System Diagnostics window.

To start System Diagnostics:

1. Turn on or restart the computer. While the “Press the ESC key for Startup Menu” message is displayed in the lower-left corner of the screen, press **esc**. When the Startup Menu is displayed, press **f2**.
2. Click the diagnostic test you want to run, and then follow the on-screen instructions.



---

**NOTE:** If you need to stop a diagnostics test while it is running, press **esc**.

---

# 6 Specifications

## Computer specifications

	Metric	U.S.
<b>Dimensions</b>		
Width	29.16 cm	11.48 in
Depth	2.15 cm	8.46 in
Height (front to back)	2.11 to 3.19 cm	0.83 to 1.26 in
<b>Weight</b>		
With 6-cell battery	1.60 kg	3.53 lb
With 3-cell battery	1.46 kg	3.22 lb
<b>Input power</b>		
Operating voltage and current	18.5 V dc @ 3.5 A - 65 W	
<b>Temperature</b>		
Operating	5°C to 35°C	41°F to 95°F
Nonoperating	-20°C to 60°C	-4°F to 140°F
<b>Relative humidity (noncondensing)</b>		
Operating	10% to 90%	
Nonoperating	5% to 95%	
<b>Maximum altitude (unpressurized)</b>		
Operating	-15 m to 3,048 m	-50 ft to 10,000 ft
Nonoperating	-15 m to 12,192 m	-50 ft to 40,000 ft
<b>NOTE:</b> Applicable product safety standards specify thermal limits for plastic surfaces. The device operates well within this range of temperatures.		

## 13.3-inch display specifications

	Metric	U.S.
<b>Dimensions</b>		
Height	16.50 cm	6.50 in
Width	25.34 cm	11.60 in
Diagonal	33.66 cm	13.30 in
<b>Number of colors</b>	262,144	

	<b>Metric</b>	<b>U.S.</b>
<b>Contrast ratio</b>	200:1 (typical)	
<b>Brightness</b>	200 nits (typical)	
<b>Pixel resolution</b>		
Pitch	<b>0.197 mm × 0.197 mm</b>	
Format	1366 × 768	
Configuration	RGB vertical stripe	
<b>Backlight</b>	LED	
<b>Character display</b>	80 × 25	
<b>Total power consumption</b>	2.0 W	
<b>Viewing angle</b>	±65° horizontal, ±50° vertical (typical)	

---

# 7 Backup and recovery

Your computer includes tools provided by the operating system and HP to help you safeguard your information and restore it if ever needed.

This chapter provides information on the following topics:

- Creating a set of recovery discs or a recovery flash drive (HP Recovery Manager software feature)
- Performing a system restore (from the partition, recovery discs, or a recovery flash drive)
- Backing up your information
- Recovering a program or driver

## Restoring the system

If the computer hard drive fails, you must use a set of recovery discs or a recovery flash drive to restore your system to its factory image. Ideally, you have already used HP Recovery Manager to create these tools immediately after software setup.

---

 **NOTE:** All references to the hard disk drive in this guide refer to the solid-state (SSD) drive

---

For issues other than hard drive failure, you can restore your system by using the HP Recovery partition, rather than by using recovery discs or a recovery flash drive. To check for the presence of a recovery partition, click **Start**, right-click **Computer**, click **Manage**, and then click **Disk Management**. If the recovery partition is present, a Recovery drive is listed in the window.

---

 **CAUTION:** HP Recovery Manager (partition or discs/flash drive) restores only software that was preinstalled at the factory. Software not provided with this computer must be reinstalled manually.

---

## Creating restore media

HP recommends that you create either a set of recovery discs or a recovery flash drive so that you can restore your computer to its original factory state if the hard drive fails, or if for any reason you cannot restore using the recovery partition tools. Create these discs or the flash drive after setting up the computer for the first time.

---

 **NOTE:** HP Recovery Manager allows the creation of only one set of recovery discs or one recovery flash drive. Handle these recovery tools carefully, and keep them in a safe place.

---

 **NOTE:** You can use an optional external optical drive (purchased separately) to create recovery discs, or you can purchase recovery discs for your computer from the HP Web site. If you use an external optical drive, it must be connected directly to a USB port on the computer, not to a USB port on an external device, such as a USB hub.

---

Guidelines:

- Purchase high-quality DVD-R, DVD+R, DVD-R DL, or DVD+R DL discs.

---

 **NOTE:** Read-write discs, such as CD-RW, DVD±RW, double-layer DVD±RW, and BD-RE (rewritable Blu-ray) discs, are not compatible with the HP Recovery Manager software.

---

- The computer must be connected to AC power during this process.

- Only one set of recovery discs or one recovery flash drive can be created per computer.

---

 **NOTE:** If you are creating recovery discs, number each disc before inserting it into an optional external optical drive (purchased separately).

---

- If necessary, you can exit the program before you have finished creating the recovery discs or recovery flash drive. The next time you open HP Recovery Manager, you will be prompted to continue the backup creation process.

To create a set of recovery discs or a recovery flash drive:

1. Select **Start > All Programs > Security and Protection > HP Recovery Manager > HP Recovery Media Creation**.
2. Follow the on-screen instructions.

## Performing a system recovery

HP Recovery Manager software allows you to repair or restore the computer to its original factory state. HP Recovery Manager works from recovery discs, a recovery flash drive, or from a dedicated recovery partition on the hard drive.

---

 **NOTE:** A system restore must be performed if the computer hard drive fails or if all attempts to correct any functional computer issues fail. A system restore should be used as a final attempt to correct computer issues.

---

Note the following when performing a system restore:

- You can restore only the system that you have previously backed up. HP recommends that you use HP Recovery Manager to create either a set of recovery discs or a recovery flash drive as soon as you set up the computer.
- Windows has its own built-in repair features, such as System Restore. If you have not already tried these features, try them before using HP Recovery Manager to restore your system.
- HP Recovery Manager restores only software that was installed at the factory. For software not provided with this computer, you must either download the software from the manufacturer's Web site or reinstall the software from the disc provided by the manufacturer using an optional external optical drive (purchased separately).

## Using the dedicated recovery partition

When using the dedicated recovery partition, there is an option to back up pictures, music and other audio, videos and movies, recorded TV shows, documents, spreadsheets and presentations, e-mails, Internet favorites and settings during this process.

To restore the computer from the recovery partition, follow these steps:

1. Access HP Recovery Manager in either of the following ways:
  - Select **Start > All Programs > Security and Protection > HP Recovery Manager > HP Recovery Manager**.
  - or –
  - Turn on or restart the computer, and then press **esc** while the “Press the ESC key for Startup Menu” message is displayed at the bottom of the screen. Then, press **f11** while the “F11 (System Recovery)” message is displayed on the screen.
2. Click **System Recovery** in the **HP Recovery Manager** window.
3. Follow the on-screen instructions.

## Restoring using the restore media

1. If possible, back up all personal files.
2. Insert the first recovery disc into an optional external optical drive (purchased separately), and then restart the computer.

– or –

Insert the recovery flash drive into a USB port on your computer, and then restart the computer.

---

 **NOTE:** If the computer does not automatically restart in the HP Recovery Manager, the computer boot order needs to be changed.

---

3. Press **F9** at system bootup.
4. Select the external optical drive or the flash drive.
5. Follow the on-screen instructions.

## Changing the computer boot order

To change the boot order for recovery discs:

1. Restart the computer.
2. Press **ESC** while the computer is restarting, and then press **F9** for boot options.
3. Select **Internal CD/DVD ROM Drive** from the boot options window.

To change the boot order for recovery flash drive:

1. Insert the flash drive into a USB port.
2. Restart the computer.
3. Press **ESC** while the computer is restarting, and then press **F9** for boot options.
4. Select the flash drive from the boot options window.

## Backing up and recovering your information

It is very important to back up your files and keep any new software in a safe place. As you add new software and data files, continue to create backups on a regular basis.

How completely you are able to recover your system depends on how recent your backup is.

---

 **NOTE:** A recovery from your most recent backup needs to be performed if the computer has a virus attack or if any major system components fail. In order to correct computer issues, a recovery should first be attempted before a system restore is attempted.

---

You can back up your information to an optional external hard drive, a network drive, or discs. Back up your system at the following times:

- At regularly scheduled times

---

 **TIP:** Set reminders to back up your information periodically.

---

- Before the computer is repaired or restored
- Before you add or modify hardware or software

Guidelines:

- Create system restore points using the Windows® System Restore feature, and periodically copy them to an optical disc using an optional external optical drive (purchased separately) or an external hard drive. For more information on using system restore points, refer to [Using Windows system restore points on page 60](#).
- Store personal files in the Documents library and back up this folder periodically.
- Save customized settings in a window, toolbar, or menu bar by taking a screen shot of your settings. The screen shot can be a time-saver if you have to re-enter your preferences.

To create a screen shot:

1. Display the screen you want to save.
2. Copy the screen image:  
To copy only the active window, press **alt+prt sc**.  
To copy the entire screen, press **prt sc**.
3. Open a word-processing document, and then select **Edit > Paste**. The screen image is added to the document.
4. Save and print the document.

## Using Windows Backup and Restore

Guidelines:

- Be sure that the computer is connected to AC power before you start the backup process.
- Allow enough time to complete the backup process. Depending on file sizes, it may take over an hour.

To create a backup:

1. Select **Start > Control Panel > System and Security > Backup and Restore**.
2. Follow the on-screen instructions to schedule and create a backup.



---

**NOTE:** Windows® includes the User Account Control feature to improve the security of the computer. You may be prompted for your permission or password for tasks such as installing software, running utilities, or changing Windows settings. Refer to Help and Support for more information.

---

## Using Windows system restore points

A system restore point allows you to save and name a snapshot of your hard drive at a specific point in time. You can then recover back to that point if you want to reverse subsequent changes.



---

**NOTE:** Recovering to an earlier restore point does not affect data files saved or e-mails created since the last restore point.

---

You also can create additional restore points to provide increased protection for your files and settings.

### When to create restore points

- Before you add or modify software or hardware
- Periodically, whenever the computer is functioning optimally



---

**NOTE:** If you revert to a restore point and then change your mind, you can reverse the restoration.

---

### Create a system restore point

1. Select **Start > Control Panel > System and Security > System**.
2. In the left pane, click **System Protection**.
3. Click the **System Protection** tab.
4. Click **Create**, and then follow the on-screen instructions.

### Restore to a previous date and time

To revert to a restore point (created at a previous date and time), when the computer was functioning optimally, follow these steps:

1. Select **Start > Control Panel > System and Security > System**.
2. In the left pane, click **System Protection**.
3. Click the **System Protection** tab.
4. Click **System Restore**.
5. Follow the on-screen instructions.

## 8 Power cord set requirements

The wide-range input feature of the computer permits it to operate from any line voltage from 100 to 120 volts AC, or from 220 to 240 volts AC.

The 3-conductor power cord set included with the computer meets the requirements for use in the country or region where the equipment is purchased.

Power cord sets for use in other countries and regions must meet the requirements of the country or region where the computer is used.

### Requirements for all countries

The following requirements are applicable to all countries and regions:

- The length of the power cord set must be at least **1.5 m** (5.0 ft) and no more than **2.0 m** (6.5 ft).
- All power cord sets must be approved by an acceptable accredited agency responsible for evaluation in the country or region where the power cord set will be used.
- The power cord sets must have a minimum current capacity of 10 A and a nominal voltage rating of 125 or 250 V ac, as required by the power system of each country or region.
- The appliance coupler must meet the mechanical configuration of an EN 60 320/IEC 320 Standard Sheet C13 connector for mating with the appliance inlet on the back of the computer.

### Requirements for specific countries and regions

Country/region	Accredited agency	Applicable note number
Argentina	IRAM	1
Australia	SAA	1
Austria	OVE	1
Belgium	CEBEC	1
Brazil	ABNT	1
Canada	CSA	2
Chile	IMQ	1
Denmark	DEMKO	1
Finland	FIMKO	1
France	UTE	1
Germany	VDE	1
India	ISI	1
Israel	SII	1
Italy	IMQ	1

Country/region	Accredited agency	Applicable note number
Japan	JIS	3
The Netherlands	KEMA	1
New Zealand	SANZ	1
Norway	NEMKO	1
The People's Republic of China	CCC	4
Saudi Arabia	SASO	7
Singapore	PSB	1
South Africa	SABS	1
South Korea	KTL	5
Sweden	SEMKO	1
Switzerland	SEV	1
Taiwan	BSMI	6
Thailand	TISI	1
The United Kingdom	ASTA	1
The United States	UL	2

1. The flexible cord must be Type H05VV-F, 3-conductor, 0.75-mm<sup>2</sup> conductor size. Power cord set fittings (appliance coupler and wall plug) must bear the certification mark of the agency responsible for evaluation in the country or region where it will be used.
2. The flexible cord must be Type SVT/SJT or equivalent, No. 18 AWG, 3-conductor. The wall plug must be a two-pole grounding type with a NEMA 5-15P (15 A, 125 V) or NEMA 6-15P (15 A, 250 V ac) configuration. CSA or C-UL mark. UL file number must be on each element.
3. The appliance coupler, flexible cord, and wall plug must bear a "T" mark and registration number in accordance with the Japanese Dentori Law. The flexible cord must be Type VCTF, 3-conductor, 0.75-mm<sup>2</sup> or 1.25-mm<sup>2</sup> conductor size. The wall plug must be a two-pole grounding type with a Japanese Industrial Standard C8303 (7 A, 125 V ac) configuration.
4. The flexible cord must be Type RVV, 3-conductor, 0.75-mm<sup>2</sup> conductor size. Power cord set fittings (appliance coupler and wall plug) must bear the CCC certification mark.
5. The flexible cord must be Type H05VV-F 3X0.75-mm<sup>2</sup> conductor size. KTL logo and individual approval number must be on each element. Corset approval number and logo must be printed on a flag label.
6. The flexible cord must be Type HVCTF 3x1.25-mm<sup>2</sup> conductor size. Power cord set fittings (appliance coupler, cable, and wall plug) must bear the BSMI certification mark.
7. For 127 V ac, the flexible cord must be Type SVT or SJT 3 x 18 AWG, with plug NEMA 5-15P (15 A, 125 V ac), with UL and CSA or C-UL marks. For 240 V ac, the flexible cord must be Type H05VV-F 3x0.75-/1.00-mm<sup>2</sup> conductor size, with plug BS 1363/A with BSI or ASTA marks.

---

## 9 Recycling

When a non-rechargeable or rechargeable battery has reached the end of its useful life, do not dispose of the battery in general household waste. Follow the local laws and regulations in your area for battery disposal.

HP encourages customers to recycle used electronic hardware, HP original print cartridges, and rechargeable batteries. For more information about recycling programs, see the HP Web site at <http://www.hp.com/recycle>.

---

# Index

- A**
  - AC adapter, spare part numbers
    - 16, 17
  - AC adapter/battery light 9
  - Action keys 6
  - antenna
    - locations 4
  - audio, product description 1
  - audio-in (microphone) jack, identifying 10
  - audio-out (headphone) jack, identifying 10
- B**
  - backing up
    - customized window, toolbar, and menu bar settings 59
    - personal files 59
  - base enclosure
    - removal 25
    - spare part numbers 25
  - base enclosure, spare part number 15, 18
  - battery
    - removal 32
    - spare part numbers 15, 17, 32
  - Blu-ray ROM DVD±R/RW Super Multi Double-Layer Drive
    - precautions 20
    - spare part number 16, 17
  - bottom components 11
  - button components 5
  - buttons
    - power 5
    - TouchPad 8
    - TouchPad on/off 8
- C**
  - cables, service considerations 19
  - caps lock light 7
  - chipset, product description 1
  - components
    - bottom 11
    - buttons 5
    - display 4
    - keys 6
    - left-side 9
    - lights 7
    - rear 8
    - right-side 10
    - TouchPad 8
  - computer feet
    - locations 24
    - removal 24
    - spare part number 24
  - computer major components 13
  - computer part number 24
  - computer specifications 53
  - connectors, service considerations 19
- D**
  - Digital Media Slot, identifying 9
  - display
    - components 4
    - specifications 53
  - display assembly
    - spare part numbers 34
  - display assembly, spare part numbers 17
  - display panel
    - removal 34
  - display panel, product description 1
  - display switch 4
  - drive light 9
  - drives, preventing damage 20
  - DVD±RW and CD-RW Super Multi Double-Layer Combo Drive
    - precautions 20
    - spare part number 16, 17
- E**
  - electrostatic discharge 20
  - equipment guidelines 23
  - esc key 6
  - Ethernet, product description 1
  - external media cards, product description 2
- F**
  - f11 57
  - fan
    - removal 46
    - spare part number 15, 18, 46
  - feet
    - locations 24
    - removal 24
    - spare part number 24
  - fn key 6
- G**
  - graphics, product description 1
  - grounding guidelines 20
  - guidelines
    - equipment 23
    - grounding 20
    - packaging 22
    - transporting 22
    - workstation 22
- H**
  - hard drive
    - precautions 20
    - product description 1
    - removal 40
    - spare part numbers 14, 16, 40
  - HDMI port 9
  - headphone (audio-out) jack 10
  - heat sink
    - spare part number 15, 18
  - HP Recovery Manager 56
- I**
  - Intel Rapid Start Technology 5
- J**
  - jacks
    - audio-in (microphone) 10
    - audio-out (headphone) 10
    - network 9
    - RJ-45 (network) 9
- K**
  - key components 6

- keyboard
  - product description 2
  - removal 26
  - spare part numbers 13, 18, 26
- keys
  - Action 6
  - esc 6
  - fn 6
  - Windows applications 6
  - Windows logo 6
- L**
- left-side components 9
- light components 7
- lights
  - battery 9
  - caps lock 7
  - hard drive 9
  - mute 7
  - power 7
  - TouchPad 8
  - wireless 7
- M**
- mass storage device
  - precautions 20
  - removal 40
  - spare part numbers 16, 40
- memory module
  - product description 1
  - removal 41
  - spare part numbers 14, 17, 41
- microphone
  - product description 1
- microphone (audio-in) jack, identifying 10
- model description 24
- model name 1
- mute light 7
- N**
- network jack, identifying 9
- O**
- operating system, product description 2
- optical drive
  - precautions 20
  - product description 1
  - spare part numbers 16, 17
- P**
- packaging guidelines 22
- plastic parts, service considerations 19
- pointing device, product description 2
- ports
  - HDMI 9
  - product description 2
  - USB 9, 10
- power button, identifying 5
- power connector 9
- power connector cable 18
  - removal 44
  - spare part number 14, 18
- power cord
  - set requirements 61
  - spare part numbers 16, 17
- power light 7
- power requirements, product description 2
- processor, product description 1
- product description
  - audio 1
  - chipset 1
  - display panel 1
  - Ethernet 1
  - external media cards 2
  - graphics 1
  - hard drives 1
  - keyboard 2
  - memory module 1
  - microphone 1
  - operating system 2
  - optical drive 1
  - pointing device 2
  - ports 2
  - power requirements 2
  - processors 1
  - product name 1
  - serviceability 2
  - video 1
  - wireless 1
- product name 1, 24
- product number 24
- R**
- rear components 8
- rear corner covers
  - spare part number 18
- recovering from the dedicated recovery partition 56
- recovering from the recovery discs 58
- recovery discs 55
- recovery, system 56
- removal/replacement
  - preliminaries 19
  - procedures 23
- restore points 60
- right-side components 10
- RJ-45 (network) jack, identifying 9
- RTC battery
  - removal 39
  - spare part numbers 14, 17, 39
- Rubber Feet Kit, spare part number 24
- Rubber Kit, spare part number 18, 24
- S**
- Screw Kit, spare part number 17, 18
- serial number 24
- service considerations
  - cables 19
  - connectors 19
  - plastic parts 19
- service tag 12, 23
- serviceability, product description 2
- slots
  - Digital Media 9
- solid-state drive, spare part number 14, 16, 18
- Speaker Kit, spare part number 18, 42
- speakers
  - removal 42
  - spare part number 14, 18, 42
- specifications
  - computer 53
  - display 53
- supported discs 55
- system board
  - removal 43
  - spare part numbers 17, 43
- system recovery 56
- system restore points 60

## T

- tools required 19
- top cover
  - removal 28
  - spare part numbers 14, 18, 28
- TouchPad button 8
- TouchPad button board
  - removal 31
  - spare part number 14, 31
- TouchPad components 8
- TouchPad light 8
- TouchPad on/off button 8
- TouchPad zone 8
- transporting guidelines 22

## U

- USB ports, identifying 9, 10
- USB/Audio board 15
  - spare part number 18
- using system restore 60

## V

- vent
  - location 8
- vents 11
- video, product description 1

## W

- warranty period 24
- webcam 4
- webcam light, identifying 7
- webcam, identifying 7
- Windows applications key 6
- Windows logo key 6
- wireless antenna
  - locations 4
- wireless light 7
- wireless, product description 1
- WLAN module
  - removal 36
  - spare part numbers 2, 14, 17, 36
- workstation guidelines 22

