

---

Thank you for selecting *the advanced guitar effects processor ZOOM Player 2020* (hereafter called “2020”).

The 2020 is a sophisticated multi-effect device with the following features and functions:

- **A total of 19 built-in individual effects, which can be combined in patches of up to six effects of five types. 20 preset patches and a user memory for 20 additional patches offer extraordinary flexibility.**
- **Integrated foot pedals and informative control panel show settings at a glance and allow easy operation like a compact effector.**
- **Compressor and distortion effects are generated using analog circuitry, to assure rich and natural-sounding sustain and distortion effects.**
- **By using the optional foot controllers FP01 or FS01, pedal wah effects and single effect on/off switching are possible, for further enhanced playability.**

Please take the time to read this manual carefully, in order to get the most out of your 2020 and to ensure optimum performance and reliability.

# Contents

<b>Safety Precautions</b> .....	3
<b>Usage Precautions</b> .....	3
<b>Terms Used in This Manual</b> .....	4
<b>Names and Functions of Controls and Connectors</b> .....	5
Front Panel .....	5
Rear Panel .....	6
<b>Connection Examples</b> .....	7
Connection to one guitar amplifier (Example 1) .....	7
Connection to two guitar amplifiers (Example 2) .....	7
Connection to a tape recorder or mixer (Example 3) .....	7
Using headphones for monitoring (Example 4) .....	7
<b>Playing a Patch (Use of the Play Mode)</b> .....	8
Selecting a Patch .....	8
Adjusting the patch level .....	9
Bypassing the Effects .....	9
<b>Editing a Patch (Use of the Edit Mode)</b> .....	10
What Is a Patch? .....	10
Entering the Edit mode .....	10
Panel Display in Edit Mode .....	11
Editing a Patch .....	11
Turning Effect Modules On and Off .....	12
Compare .....	12
Storing a Patch .....	12
<b>Effect Types and Parameters</b> .....	13
Effect Module 1: Compressor + distortion (COMP+DIST) .....	13
Effect Module 2: Equalizer (EQ) .....	14
Effect Module 3: Modulation .....	15
Effect Module 4: Delay .....	16
Effect Module 5: Reverb .....	17
Patch Level .....	17
<b>Other Functions</b> .....	18
Restoring Individual Factory Preset Patches (Patch Recall) .....	18
Restoring All Factory Preset Patches (Initialize) .....	18
<b>Application Examples for Use of Foot Pedal and Foot Switch</b> .....	19
Using the FP01 .....	19
Using the FS01 .....	19
<b>Specifications</b> .....	20

---

## Safety Precautions

Please observe the following safety tips and precautions to ensure hazard-free use of the 2020.

### • Power requirements

The 2020 is powered by the supplied AC adapter AD0003/AD0004. Do not use any other kind of AC adapter to prevent malfunction and safety hazards.

When wishing to use the 2020 in an area with a different line voltage, please consult your local ZOOM distributor about acquiring a proper AC adapter.

### • Environment

Avoid using your 2020 in environments where it will be exposed to:

- Temperature extremes
- High humidity or moisture
- Excessive dust or sand
- Excessive vibration or shock

### • Handling

Since the 2020 is a precision electronic device, avoid applying excessive force to the switches and buttons. Also take care not to drop the unit, and do not subject it to shock or excessive pressure.

### • Alterations

Never open the case of the 2020 or attempt to modify the product in any way since this can result in damage.

### • Connecting cables and input and output jacks

You should always turn off the power to the 2020 and all other equipment before connecting or disconnecting any cables. Also make sure to disconnect all cables and the AC adapter before moving the 2020.

## Usage Precautions

### • Electrical interference

The 2020 uses digital circuitry that may cause interference and noise if placed too close to other electrical equipment, such as TV sets and radio receivers. If such problems occur, move the 2020 further away from the affected equipment. Also, when fluorescent lights or devices with built-in motors are close to the 2020, the unit may not function properly.

### • Cleaning

Use a soft, dry cloth to clean the 2020. If necessary, slightly moisten the cloth. Do not use abrasive cleanser, wax, or solvents (such as paint thinner or cleaning alcohol), since these may dull the finish or damage the surface.

Please keep this manual in a convenient place for future reference.

# Terms Used in This Manual

This manual has been written so that it can be easily understood also by first-time users. However, the 2020 offers several special functions which are not available with a conventional compact effector. This section explains some of the terms used throughout the manual to describe such functions.

## • Effect Module

The 2020 offers five basic effect groups, as shown in the illustration below. Such an effect group is referred to as an “effect module”. Each effect module can be thought of as a single compact effector. The 2020 therefore operates like five compact effectors connected in series. The following effect modules are available:

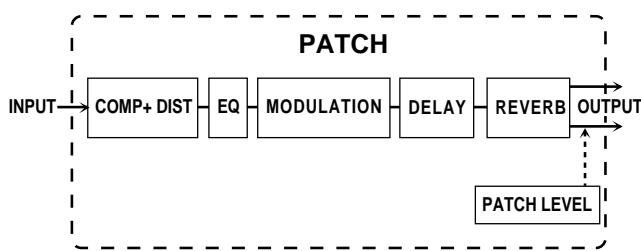

- **COMP+ DIST** (Analog compressor and distortion effects)
- **EQ** (Equalizer and wah effects)
- **MODULATION** (modulation effects such as chorus and flanger)
- **DELAY** (delay effects)
- **REVERB** (reverberation effects)

## • Effect Type

Each effect module contains several effect variations which are called “effect types”. Each effect module can use one effect type at a time. For a list of effect types in each effect module, see the table on page 13.

## • Patches and Groups

The 2020 allows you to use a maximum of five effect modules simultaneously. A combination of effect modules, each with individual parameter settings plus the final output level setting, is referred to as a “patch”.

The 2020 has two memory areas or “groups” where patches are stored: the user group for patches created by the user, and the preset group for factory defined patches where only the output level can be changed.

## • Bank

The 2020 calls up patches in sets of four, and the foot pedals serve to switch between patches. Such a set of four patches is referred to as a “bank”. To select a patch, first specify the group and the bank, and then use the foot pedals to select patch number 1 - 4.

GROUP	BANK No.	PATCH No.
USER	0	1 – 4
	1	1 – 4
	2	1 – 4
	3	1 – 4
	4	1 – 4
PRESET	0	1 – 4
	1	1 – 4
	2	1 – 4
	3	1 – 4
	4	1 – 4

## • Parameter

The elements which determine the sound of an effect are referred to as “parameters”. Parameter values can be adjusted for each effect module, to create your own patches with the 2020.

## • Mode

The functions of the 2020 can be roughly divided into three different categories. These are called “modes”, as described below.

### • Play Mode

In this mode, patches can be selected and played. This is the default mode of the 2020 when power is turned on.

### • Edit (Manual) Mode

In this mode, the parameters of each patch can be edited. The mode can also be used as a manual mode to switch effect modules on and off during a performance using a foot pedal.

### • Special Mode

Serves to return some or all patch data to the factory preset condition.

# Names and Functions of Controls and Connectors

## Front Panel

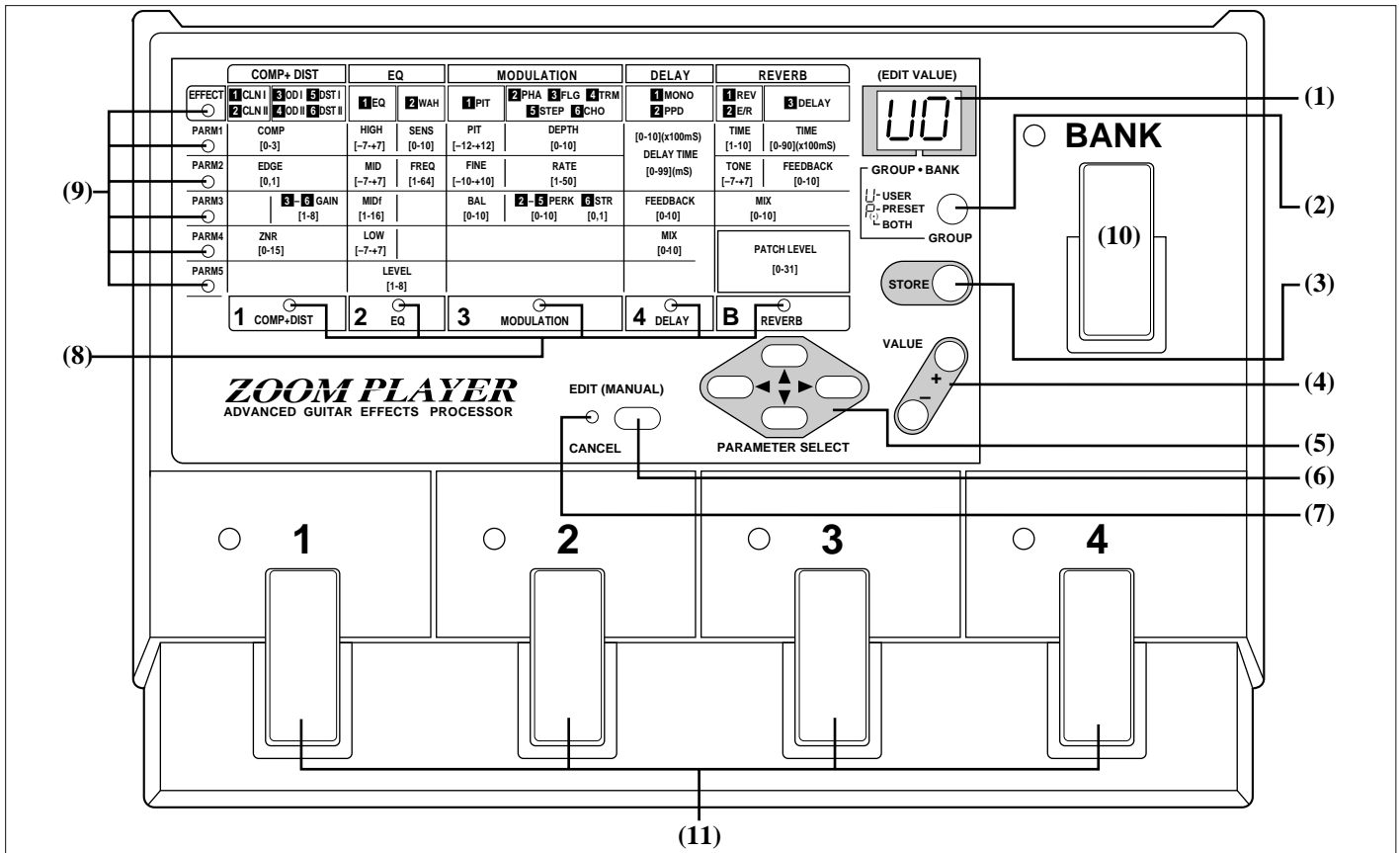

### (1) Display

The display shows vital information for operating the 2020, such as group and bank numbers of a patch, effect parameter values and other messages.

### (2) GROUP key

#### • In Play mode

Serves to select the memory group for the patch, as follows.

**USER** Only patches from the user group are available.

**PRESET** Only patches from the preset group are available.

**BOTH** Patches from both groups are available.

#### • In Edit mode

Serves to compare the currently edited patch with the patch before editing (compare function). For details, please refer to page 12.

### (3) STORE key

Serves to store an edited patch with its new parameter and level settings in the user group.

### (4) VALUE + / - keys

These keys serve to change the value of a parameter. Tapping the VALUE + key increases the value by one step, and tapping the VALUE - key decreases the value by one step. Keeping a key depressed changes the value continuously. To increase the speed of the change, press the other key as well.

#### • In Play mode

The keys serve to adjust the output level of the patch.

#### • In Edit mode

The keys serve to select an effect type and adjust the currently selected parameter.

### (5) PARAMETER SELECT keys

Serve to select the parameter to be edited in Edit mode.

### (6) EDIT (MANUAL) / CANCEL key

Pressing this key switches from Play mode to Edit mode. The Edit mode can also be used as Manual mode to switch effect modules on and off with a foot pedal.

The key also serves to return from the Edit mode to the Play mode, and to cancel a store process.

### (7) Edit mode LED

This LED lights up when the 2020 is in the Edit (Manual) mode.

### (8) Module cursor LED

#### • In Play mode

Lit LED indicates which effect module in the current patch is ON.

#### • In Edit mode

Lit LED indicates which effect module in the currently edited patch is ON, and flashing LED indicates the currently edited effect module.

### (9) Parameter cursor LED

Flashing LED indicates the currently edited parameter in Edit mode.

### (10) BANK pedal

#### • In Play mode

Selects the next higher bank.

#### • In Edit (Manual) mode

Switches REVERB for the effect module on and off. The pedal LED lights up when REVERB is on.

### (11) Pedal 1 - 4

#### • In Play mode

The pedals serve to select a patch. The respective pedal LED lights up.

#### • In Edit (Manual) mode

The pedals serve to switch the effect modules COMP+DIST, EQ, MODULATION, DELAY on and off. The respective pedal LED lights up.

## Rear Panel

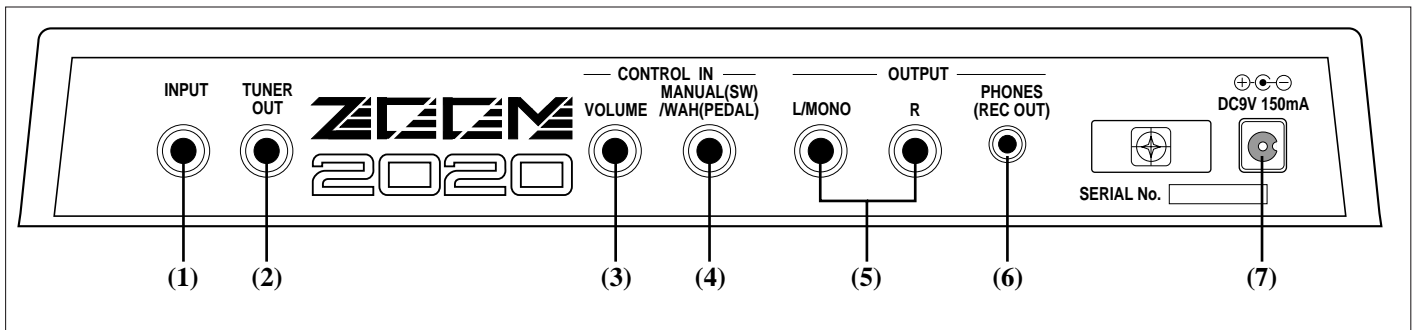

### (1) INPUT jack

Serves for connection of a guitar.

### (2) TUNER OUT jack

The guitar signal from the input is supplied without alteration at this output, to allow tuning without the need for cabling changes.

### (3) CONTROL IN VOLUME jack

This connector allows use of the optional foot pedal FP01 to control the volume level of the 2020. Since the level is adjusted between the EQ module and the MODULATION module, the volume can be changed without affecting reverberation.

### (4) CONTROL IN MANUAL/WAH jack

This jack serves for connection of the optional foot switch FS01 or foot pedal FP01. The FS01 can be used to switch between Play mode and Manual mode, and the FP01 can be used to control the wah effect of the EQ effect module.

### (5) OUTPUT L/MONO/R connectors

Serves for connection to a guitar amplifier. To use the 2020 in stereo, connect cables to both jacks. For a monaural setup, connect the cable to the L/MONO jack.

### (6) PHONES (REC OUT) jack

For connection of a pair of stereo headphones. Since the output at this jack has been processed by an amp simulator, it can also be used as recording output for connection to a tape recorder or mixer.

### (7) DC INPUT (AC adapter) jack

The supplied AC adapter is connected here. To guard against inadvertently disconnecting the adapter cable, wind the cable once around the hook. As long as the AC adapter is connected here, the unit is turned on. There is no separate power switch.



**NOTE** When connecting the FP01 to a CONTROL IN jack, use the EXP. OUT connector of the FP01.

# Connection Examples

## Connection to one guitar amplifier (Example 1)

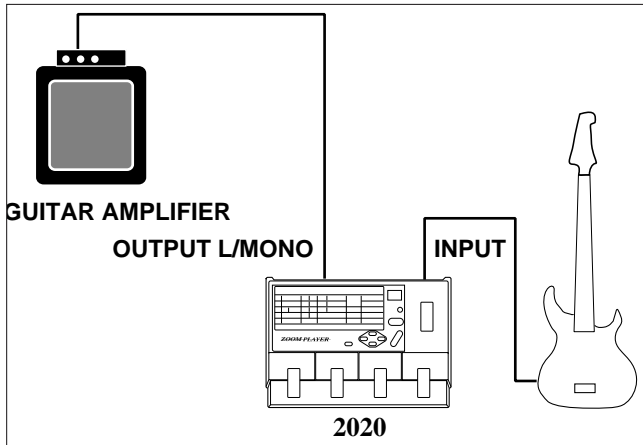

To use the 2020 with one guitar amplifier, connect the output of the musical instrument to the INPUT jack of the 2020, and the OUTPUT L/MONO jack of the 2020 to the amplifier. With this connection, stereo effects such as reverb and ping-pong delay are output in mono.

## Connection to two guitar amplifiers (Example 2)

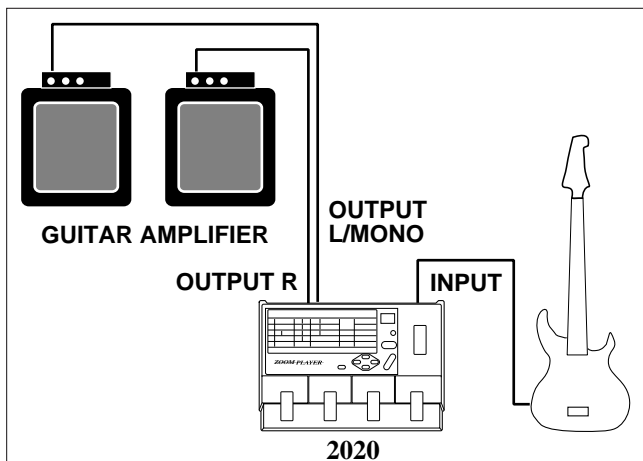

To use the 2020 with two guitar amplifiers, connect the OUTPUT L/R jacks of the 2020 to the amplifiers. A well balanced stereo sound can be obtained when the stereo effects are activated.

## Connection to a tape recorder or mixer (Example 3)

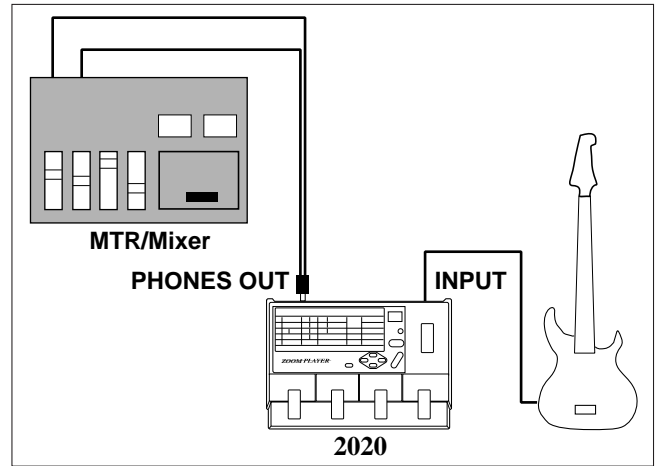

By connecting an adapter cable to the PHONES jack with a stereo miniature phone plug at one end and two standard mono phone plugs (or two RCA-type phono plugs) at the other end, the output of the 2020 can be fed directly to a multi-track tape recorder or a mixer. Since the PHONES jack output is processed by an amp simulator, the recording will have the characteristic guitar amplifier sound, although it is a line connection.

## Using headphones for monitoring (Example 4)

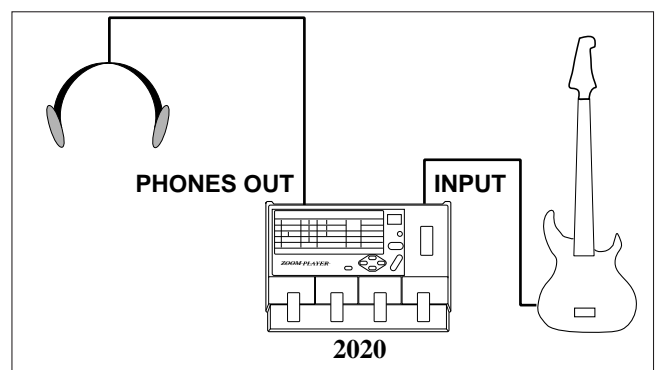

This setup is suitable for example to practice individually without disturbing others.

# Playing a Patch (Use of the Play Mode)

In the Play mode, a patch is selected and played. When the 2020 is turned on, it goes into the Play mode automatically. In the Play mode, the following information is shown on the display.

## (1) Group

The currently selected group is shown in the GROUP field.

## (2) Bank number

The currently selected bank number is shown in the BANK field.

## (3) Patch number

The currently selected patch number is indicated by the pedal LED (1 - 4).

## (4) Effect module on/off

The effect module on/off condition in the patch is indicated by the module cursor LED.

## Selecting a Patch

- Turn off the amplifier(s) and set the volume control to minimum. Then connect the 2020 to the instrument and amplifier(s).
- Turn on the amplifier(s) and adjust the volume to a suitable position while playing the instrument. The 2020 is turned on automatically when the cable from the AC adapter is connected to the 2020.
- Select the desired group with the GROUP key.

In the 2020, patches are divided into the user group for patches which can be created and altered freely by the user, and the preset group for factory defined patches where only the output level can be changed. Choose the group from which you want to select a patch. With each push of the GROUP key, the group setting cycles through the following three settings which are shown on the display.

- **U (USER)** User group only
- **P (PRESET)** Preset group only
- **U or P (BOTH)** User group and preset group

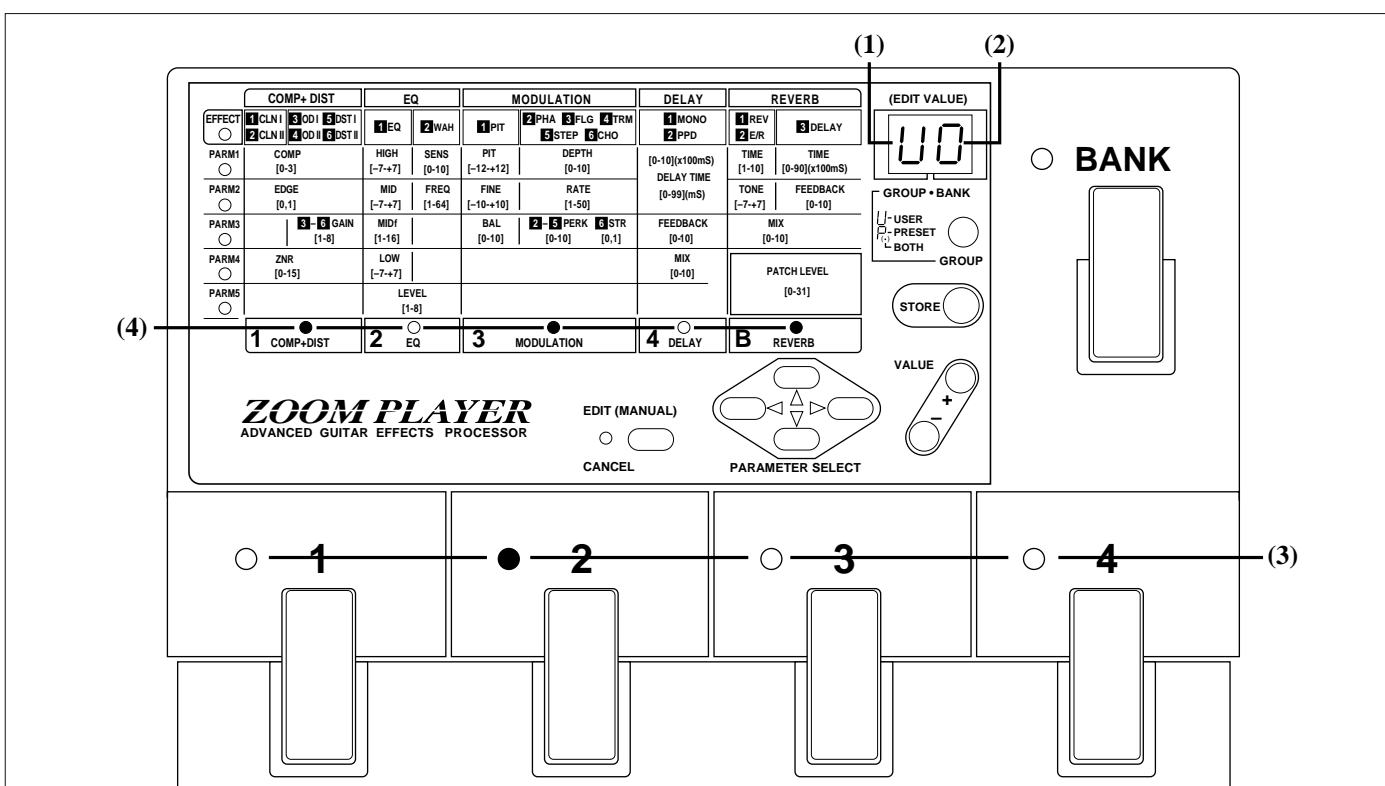
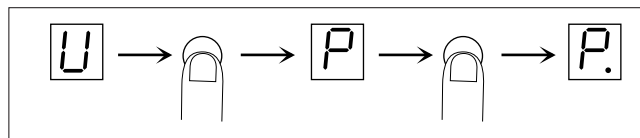

- Select the bank with the bank pedal.

A bank is a group of four patches. There are five banks each (numbered 0 through 4) for the user group and the preset group. With each push of the bank pedal, the bank number is incremented by one. The bank number display flashes.

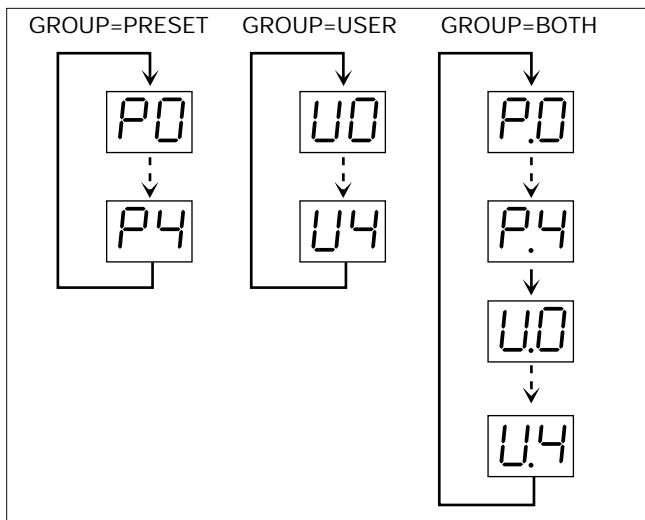

**NOTE** Only pressing the BANK key does not yet change the patch. To activate the patch and change the sound, press one of the pedals 1 - 4, as described below.

- Select the patch by pressing one of the pedals 1 - 4.

The LED of that pedal lights up, showing that the patch has been selected.

## Adjusting the patch level

The final output level of the patch — called the patch level — is also stored as a parameter along with the other parameters of the patch. In the Play mode, the patch level only can be adjusted.

- Press the VALUE + / - keys in the Play mode.

When one of the VALUE + / - keys is pressed, the current patch level setting is shown on the display as a numeric value (0 - 31). Pressing VALUE + increases the value and pressing VALUE - decreases it. To change values continuously, hold down the key. To change values more rapidly, press the other key as well.

**NOTE** The patch level setting change made in this way is only temporary. If you select a different patch without storing the new level setting first, the setting will be lost. (For details on how to store settings, please refer to page 12.)

- While other parameters of patches from the preset group cannot be altered, the patch level can be changed and stored. This is useful for example to match levels when combining user patches with preset patches.

## Bypassing the Effects

You can temporarily turn off all effects in a patch. This is useful for example to check the sonic character of a patch.

- In the Play mode, press the pedal whose LED is lit (the pedal that was used to choose the current patch number) once more.

All effects in the patch are now bypassed and the original instrument sound is heard. In the bypass condition, the LEDs of pedals 1 - 4 flash and the indication “bP” appears alternately on the group and bank number display.

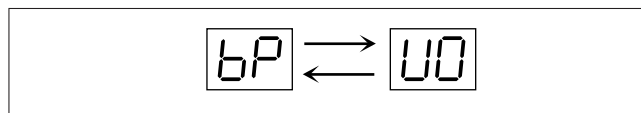

Press the same pedal again, or select a different patch to return to normal play mode.

# Editing a Patch (Use of the Edit Mode)

## What Is a Patch?

Before you attempt to edit a patch, you should have a general idea how patches are created. In the 2020, a patch can contain the following effect modules:

- **COMP+DIST** (Analog compressor and distortion effects)
- **EQ** (Equalizer and wah effects)
- **MODULATION** (modulation effects such as chorus and flanger)
- **DELAY** (delay effects)
- **REVERB** (reverberation effects)

A combination of these effect modules, each with individual parameter settings plus the final patch level setting, is referred to as a “patch”.

In the Edit mode, you can call up the various parameters of an effect module and change these parameters according to your wishes and preferences.

## Entering the Edit mode

- Select the desired patch in the Play mode (from the user group or the preset group) and press the **EDIT/CANCEL** key. The 2020 is now in the Edit mode, and the Edit mode LED lights up.
- Pressing the **EDIT/CANCEL** key once more returns the 2020 to the Play mode.

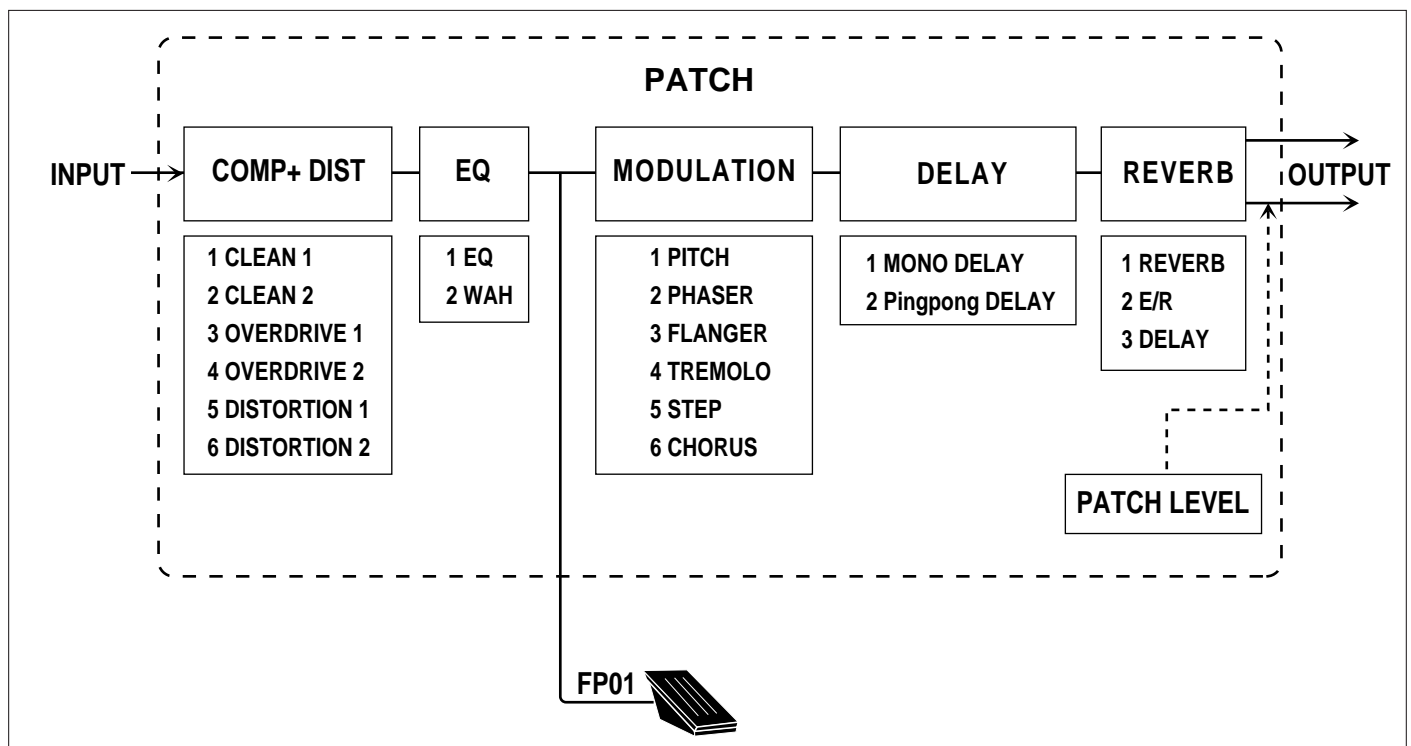

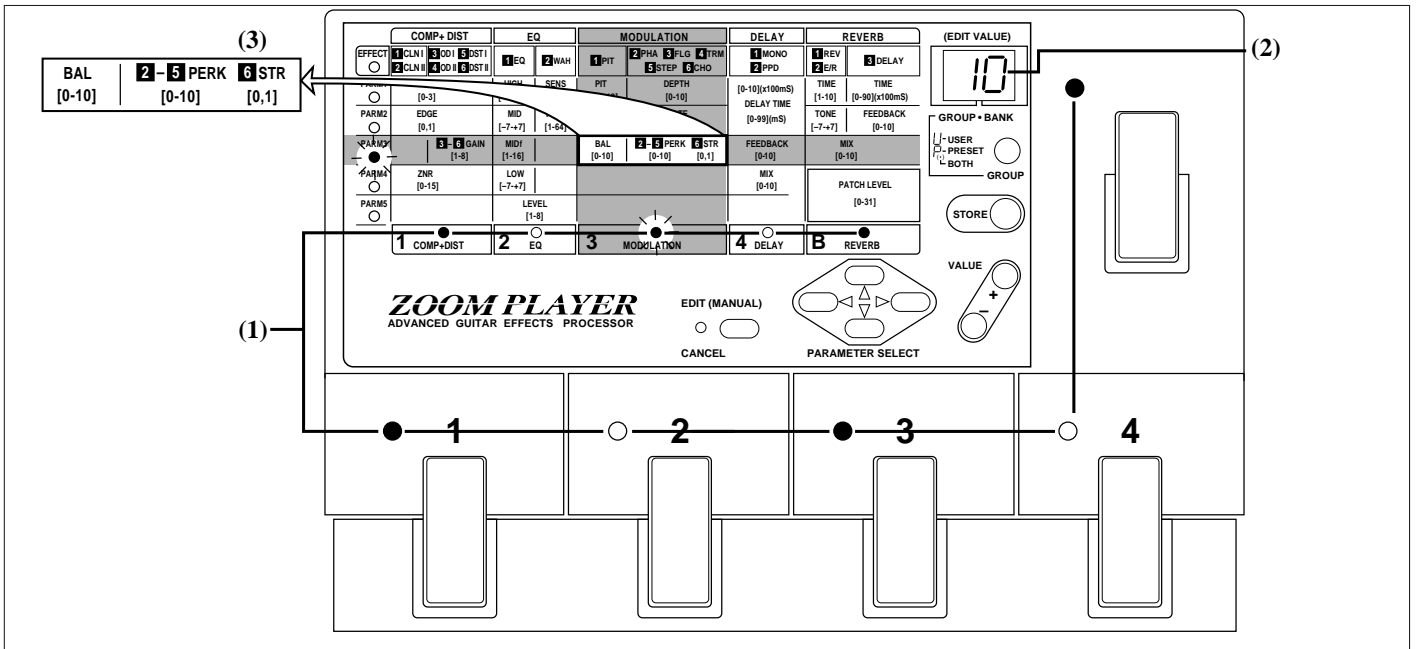

## Panel Display in Edit Mode

In the Edit mode, the following information is shown on the panel display.

### (1) Effect module on/off

The LEDs of pedals for effect modules which are on (pedals 1 - 4 and BANK pedal) are lit.



The pedals 1 - 4 and the BANK pedal correspond to the following effect modules.

Pedal 1	COMP+DIST
Pedal 2	EQ
Pedal 3	MODULATION
Pedal 4	DELAY
BANK pedal	REVERB

### (2) Parameter value

The value of the parameter currently selected for editing is shown on the display.

### (3) Parameter type

The type of the parameter currently selected for editing is indicated by the flashing module cursor LED and parameter cursor LED.

## Editing a Patch

- In the Edit mode, use the PARAMETER SELECT keys to select the desired parameter.

The left/right PARAMETER SELECT keys control the module cursor LEDs and the up/down PARAMETER SELECT keys control the parameter cursor LEDs. The display indication changes accordingly.



The topmost row of parameter LEDs corresponds to the EFFECT parameter which changes the effect type. When the effect type is changed, the setting of parameters 1 - 5 also changes. Therefore it is best to first select the effect type and then work on the other parameters when creating an effect from scratch.

- Use the VALUE +/- keys to change the parameter value.

The value of the currently selected parameter is changed. To change values continuously, hold down the key. To change values quickly, press the other key as well.

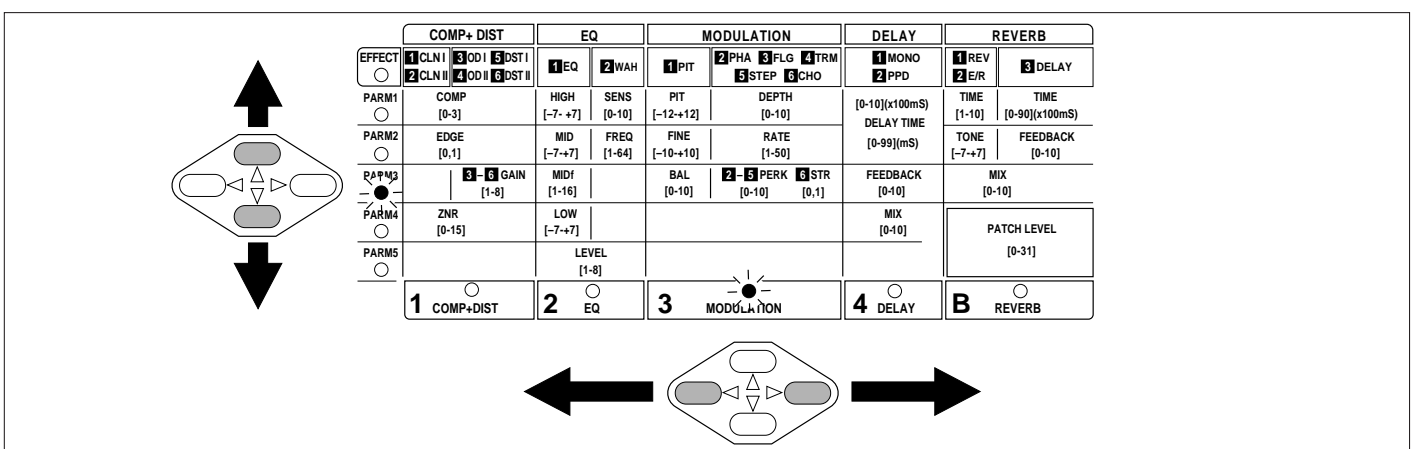



For details on the parameters of each effect module, please refer to “Effect Types and Parameters” on page 13.

- Change other parameters in the same way.



Parameter setting changes made in this way are only temporary. If you return to the Play mode or select a different patch without storing the new settings first, the settings will be lost. For details on how to store a patch, please refer to next section.

## Turning Effect Modules On and Off

In the Edit mode, each effect can be turned on and off independently from others.

- Pressing a pedal corresponding to an effect module that is currently on (pedal LED and effect module cursor LED are lit) turns the effect module off.

The LED goes out. Press the pedal again to turn the effect back on.



The effect module on/off setting can also be stored as part of a patch.

## Compare

During editing, it is possible to temporarily return to the setting that was active before starting the editing process. This is called the “compare” function.

- In the Edit mode, press the GROUP key.

The previous value of the parameter where the cursor is currently located and the indication “CP” appear alternately on the display.

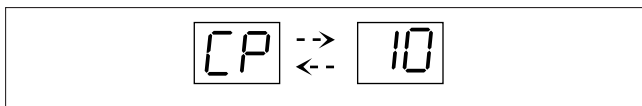

- Press the GROUP key once more.

The 2020 returns to the Edit mode.



The compare function is useful for example to check how a certain parameter change affects the overall sound. When the parameter is selected with the PARAMETER SELECT keys, the value of that parameter is shown on the display.

## Storing a Patch

If an edited patch (or a patch whose patch level setting was changed in the Play mode) is not stored, the change will be lost when another patch is selected. To preserve a setting, store the patch as described below.

- Press the STORE key in the Play mode or Edit mode.

This activates the store mode, and you can now choose the bank number and patch number in which you want to store the patch.



For patches from the preset group, parameters other than the patch level cannot be stored. Therefore, even if a patch was chosen from the preset group, the store destination will automatically become “U” (user group) if a parameter other than the patch level was changed. If only the patch level was changed, the store destination can also be “P” (preset group).

- Use the BANK pedal and pedals 1 - 4 to specify the bank number and patch number.

If no input is made, the patch will be stored in the original bank number and patch number.



When a patch is stored, the patch that was previously stored in that number will be overwritten (erased). Take care not to erase a patch that you want to keep. When wishing to restore the factory preset patches, please refer to the explanation on page 18.

- Press the STORE key again. The patch is stored, and the 2020 reverts to the Play mode.



If the STORE key has not yet been pressed for the second time, you can use the EDIT/CANCEL key to cancel the store process and return to the immediately preceding mode.



When connecting the FP01 to a CONTROL IN jack, use the EXP. OUT connector of the FP01.

# Effect Types and Parameters

In this section, all effect types and parameters of the 2020 are explained. Parameters that are the same for several effects are explained in detail only the first time they appear.

COMP+ DIST	EQ	MODULATION	DELAY	REVERB
1 CLEAN 1 2 CLEAN 2 3 OVERDRIVE 1 4 OVERDRIVE 2 5 DISTORTION 1 6 DISTORTION 2	1 EQ 2 WAH	1 PITCH 2 PHASER 3 FLANGER 4 TREMOLO 5 STEP 6 CHORUS	1 MONO DELAY 2 Pingpong DELAY	1 REVERB 2 E/R 3 DELAY
				PATCH LEVEL

## ■ Effect Module 1: Compressor + distortion (COMP+DIST)

The compressor effect maintains the volume at a certain level without impairing the sense of tone and attack. The distortion effect produces a characteristic tube- amplifier-like distortion combined with long sustain.

### 1 CLN I (Clean 1)

This effect type uses only the compressor, to obtain a clean sound without distortion. The effect is especially suitable for electric guitars.

Parameter 1	COMP	0 to 3
Parameter 2	EDGE	0, 1
Parameter 4	ZNR	0 to 15

#### Explanation

**(1)COMP (compressor):** determines the depth of the compression. The higher the value, the smaller the level difference, and the longer sustain is obtained.

**(2)EDGE:** At a setting of "1", the treble range is emphasized. This parameter makes the sound more distinct.

**(4)ZNR (Zoom Noise Reduction):** This parameter adjusts the threshold for the ZNR feature which cuts noise during performance pauses. You should set the parameter to a value as high as possible, but without causing the instrument release to sound unnatural.

### 2 CLN II (Clean 2)

Clean sound effect with flat characteristics that is suitable also for electro-acoustic guitar.

Parameter 1	COMP	0 to 3
Parameter 2	EDGE	0, 1
Parameter 4	ZNR	0 to 15

### 3 OD I (Overdrive 1)

Overdrive effect with the warm distortion sound that is typical for tube amplifiers.

Parameter 1	COMP	0 to 3
Parameter 2	EDGE	0, 1
Parameter 3	GAIN	1 to 8
Parameter 4	ZNR	0 to 15

#### Explanation

**(3)GAIN:** Determines distortion intensity in the overdrive circuit. The higher the value, the deeper the distortion.

### 4 OD II (Overdrive 2)

Overdrive effect with heavy, fuzzy distortion.

Parameter 1	COMP	0 to 3
Parameter 2	EDGE	0, 1
Parameter 3	GAIN	1 to 8
Parameter 4	ZNR	0 to 15

### 5 DST I (Distortion 1)

Hard distortion effect similar to a large amplifier driven to full capacity.

Parameter 1	COMP	0 to 3
Parameter 2	EDGE	0, 1
Parameter 3	GAIN	1 to 8
Parameter 4	ZNR	0 to 15

## 6 DST II (Distortion 2)

Distortion with a thick, full-bodied character that is ideal for the heavy metal genre.

Parameter 1	COMP	0 to 3
Parameter 2	EDGE	0, 1
Parameter 3	GAIN	1 to 8
Parameter 4	ZNR	0 to 15

## Effect Module 2: Equalizer (EQ)

This effect module comprises two effect types to control the tonal character of the sound.

### 1 EQ (Equalizer)

This is an equalizer with independent boost/cut for the high, medium, and low frequency range. The mid-range control is a parametric type allowing the user to freely select the center frequency.

Parameter 1	HI	-7 to +7
Parameter 2	MID	-7 to +7
Parameter 3	MID f	0 to 16
Parameter 4	LOW	-7 to +7
Parameter 5	LEVEL	1 to 8

#### Explanation

- (1)**HI (high range)**: Adjusts the high frequency range. A value of 0 (zero) signifies flat response. The higher the value, the stronger is the high frequency boost.
- (2)**MID (midrange)**: Adjusts the medium frequency range. A value of 0 (zero) signifies flat response. The higher the value, the stronger is the medium frequency boost.
- (3)**MID f (midrange frequency)**: Determines the center frequency for cut/boost. The higher the value, the higher

is the center frequency.

- (4)**LOW (low range)**: Adjusts the low frequency range. A value of 0 (zero) signifies flat response. The higher the value, the stronger is the low frequency boost.
- (5)**LEVEL**: Determines the EQ module output level.



The **LEVEL** parameter allows compensation for the change in output level due to a tone boost or cut.

When **HIGH**, **MID**, and **LOW** are all at the flat setting, the **LEVEL** setting "5" produces the same volume as **EQ OFF**.

### 2 WAH

This is an auto wah effect where the emphasized frequency range changes according to the dynamics of the input signal. If the optional foot pedal FP01 is used, manual pedal wah is also possible.

Parameter 1	SENS	0 to 10
Parameter 2	FREQ	1 to 64
Parameter 5	LEVEL	1 to 8

#### Explanation

- (1)**SENS (sensitivity)**: Determines the sensitivity of the auto wah effect. The bigger the value, the bigger the frequency change even at low volume levels. At a setting of 0 (zero), the frequency range emphasis acts as a fixed bandpass filter.
- (2)**FREQ (frequency)**: Determines the reference frequency.



At a **SENS** setting of 0 (zero), the foot pedal FP01 acts as a pedal wah, and at other settings as a controller which changes the auto wah sensitivity. For details, please refer to page 19.

Equalizer Operation

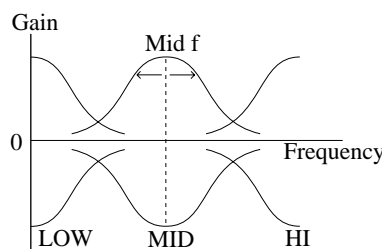

## ■ Effect Module 3: Modulation

This effect module has six effect types which vary the pitch over time.

### 1 PIT (Pitch)

This effect shifts the pitch up to one octave up or down, and adds the shifted signal to the direct sound.

Parameter 1	PIT	-12 to +12
Parameter 2	FINE	-10 to +10
Parameter 3	BAL	0 to 10

#### Explanation

- (1)**PIT (Pitch)**: Determines the pitch change in semitone steps. The setting range is one octave up or down.
- (2)**FINE**: Allows fine adjustment of pitch.
- (3)**BAL (Balance)**: Determines the balance between effect sound and direct sound. At a setting of 0 (zero), the output signal contains only the direct sound, and at a setting of 10 only the effect sound.



*By setting the pitch to 0 (zero) and somewhat raising the FINE parameter, you can create a chorus effect with slight modulation.*

### 2 PHA (Phase)

This effect adds a phase-shifted component to the direct sound, with a variable amount of phase shift. The effect creates a warm, distinct sound that is different for example from flanger or chorus.

Parameter 1	DEPTH	0 to 10
Parameter 2	RATE	1 to 50
Parameter 3	PEAK	0 to 10

#### Explanation

- (1)**DEPTH**: Determines the depth of phase shift.
- (2)**RATE**: Determines the speed of phase shift.
- (3)**PEAK**: Adds a distinct character to the sound by emphasizing the effect.

### 3 FLG (Flanger)

This effect adds a delayed component to the direct sound, with periodically changing delay time in the range of several to several tens of milliseconds. The result is an intense, distinct sound. When combined with distortion, a swirling “jet sound” type flanger effect can be obtained.

Parameter 1	DEPTH	0 to 10
Parameter 2	RATE	1 to 50
Parameter 3	PEAK	0 to 10

#### Explanation

- (1)**DEPTH**: Determines the depth of the flanger effect.
- (2)**RATE**: Determines the speed of the flanger variation.
- (3)**PEAK**: Determines the amount of feedback. Increasing this parameter stresses the modulation impression and adds a distinct character to the sound.

### 4 TRM (Tremolo)

This effect periodically varies the intensity of the sound. The effect can be adjusted from conventional tremolo to a strong clipping effect.

Parameter 1	DEPTH	0 to 10
Parameter 2	RATE	1 to 50
Parameter 3	PEAK	0 to 10

#### Explanation

- (1)**DEPTH**: Determines the depth of the tremolo effect.
- (2)**RATE**: Determines the speed of the tremolo variation.
- (3)**PEAK**: Increasing this parameter deforms the tremolo waveform to a trapezoid shape, which causes a strong clipping effect and adds a distinct character to the sound.

### 5 STEP

This effect causes random pitch changes and creates an auto arpeggio sound.

Parameter 1	DEPTH	0 to 10
Parameter 2	RATE	1 to 50
Parameter 3	PEAK	0 to 10

Effect of the PEAK Parameter

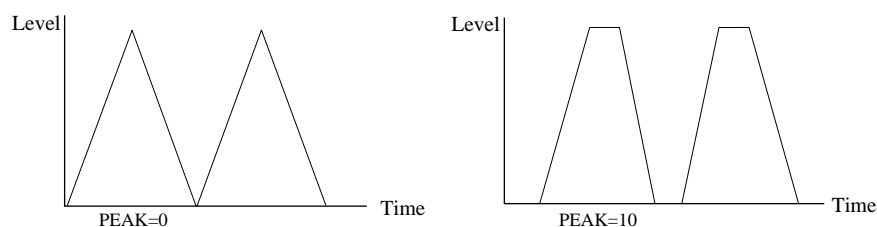

### Explanation

- (1)**DEPTH**: Determines the depth of the pitch change.
- (2)**RATE**: Determines the speed of the effect (arpeggio rate)
- (3)**PEAK**: Determines the amount of feedback. Increasing this parameter stresses the feeling of modulation and adds a distinct character to the sound.



*This effect creates a sound that is similar to the sample- and-hold function of a synthesizer.*

## 6 CHO (Chorus)

This effect adds a component with periodically changing pitch to the direct sound, which results in a spatially wide impression. The effect can be used in mono or stereo. In principle, this is similar to the flanger effect, but without the PEAK parameter.

<b>Parameter 1</b>	<b>DEPTH</b>	<b>0 to 10</b>
<b>Parameter 2</b>	<b>RATE</b>	<b>1 to 50</b>
<b>Parameter 3</b>	<b>STEREO</b>	<b>0, 1</b>

### Explanation

- (1)**DEPTH**: Determines the depth of the pitch change.
- (2)**RATE**: Determines the speed of the rate change.
- (3)**STEREO**: A setting of 0 (zero) gives a monaural effect and a setting of 1 a stereo effect.



*To obtain a pleasant chorus effect, adjust the depth according to the rate parameter.*

## Effect Module 4: Delay

This effect module adds an echo component to the direct sound. You can choose between simple monaural delay and stereo ping-pong delay.

## 1 MONO

Orthodox digital delay with a delay time of up to 1000 milliseconds.

<b>Parameter 1</b>	<b>DELAY TIME (x100 ms)</b>	<b>0 to 10</b>
<b>Parameter 2</b>	<b>DELAY TIME(x1 ms)</b>	<b>0 to 99</b>
<b>Parameter 3</b>	<b>FEEDBACK</b>	<b>0 to 10</b>
<b>Parameter 4</b>	<b>MIX</b>	<b>0 to 10</b>

### Explanation

- (1)**DELAY TIME (x100 ms)**: This parameter adjusts the delay time (interval between delayed sounds) in 100-ms steps.
- (2)**DELAY TIME (x1 ms)**: This parameter adjusts the delay time in 1-ms steps. The sum of parameters (1) and (2) becomes the final delay time. When parameter (1) is 10 (= 1000 ms), parameter (2) is fixed at 0 (zero).
- (3)**FEEDBACK**: Determines the number of repetitions of the delay sound. The higher the value, the more repetitions are added.
- (4)**MIX**: Determines the balance between effect sound and direct sound. At a setting of 0 (zero), the output signal contains only the direct sound, and at a setting of 10 only the effect sound.

## 2 PPD (Ping-pong delay)

This is a ping-pong type delay where the delayed sound alternates between the left and right channel.

<b>Parameter 1</b>	<b>DELAY TIME (x100 ms)</b>	<b>0 to 10</b>
<b>Parameter 2</b>	<b>DELAY TIME (x1 ms)</b>	<b>0 to 99</b>
<b>Parameter 3</b>	<b>FEEDBACK</b>	<b>0 to 10</b>
<b>Parameter 4</b>	<b>MIX</b>	<b>0 to 10</b>



*When the 2020 is used in a monaural configuration, only short delay signals are output from the OUTPUT L/MONO jack.*

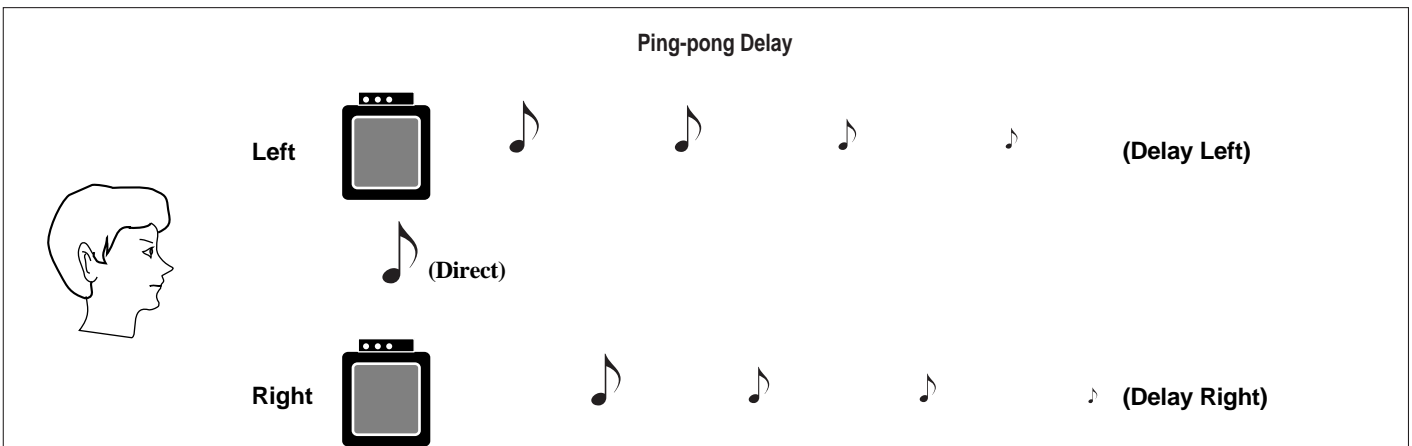

## ■ Effect Module 5: Reverb

This effect module includes three types of reverberation effects.

### 1 REV1 (Reverb 1)

This effect simulates hall-type reverberation, adding rich ambience to the sound.

Parameter 1	TIME	1 to 10
Parameter 2	TONE	-7 to +7
Parameter 3	MIX	0 to 10

#### Explanation

- (1)**TIME**: Determines the duration of the reverberation. Higher values increase the reverb time and the apparent room size.
- (2)**TONE**: Determines the tonal quality of the reverberation. The higher the value, the brighter the sound.
- (3)**MIX**: Determines the balance between effect sound and direct sound.

### 2 E/R (Early Reflections)

This is a short, room-type reverb effect, which adds body and ambience to the sound without causing excessive boominess.

Parameter 1	TIME	1 to 10
Parameter 2	TONE	-7 to +7
Parameter 3	MIX	0 to 10

### 3 Delay

This effect is similar to the ping-pong delay of the DELAY module, but with a maximum delay time of 900 milliseconds.

Parameter 1	TIME (x10 ms)	0 to 90
Parameter 2	FEEDBACK	0 to 10
Parameter 3	MIX	0 to 10

#### Explanation

- (1)**TIME (x10 ms)**: This parameter adjusts the delay time in 10-ms steps.
- (2)**FEEDBACK**: Determines the number of repetitions of the delay sound. The higher the value, the more repetitions are added.
- (3)**MIX**: Determines the balance between effect sound and direct sound. At a setting of 0 (zero), the output signal

contains only the direct sound, and at a setting of 10 only the effect sound.



*When the 2020 is used in a monaural configuration, only short delay signals are output from the OUTPUT L/MONO jack.*



*By combining this effect with the ping-pong delay of the DELAY module, complex multiple delay effects can be created.*

## ■ Patch Level

Parameters 4 and 5 of the REVERB module serve to set the patch level. This setting can also be stored as part of the patch.

Parameter 4	PATCH LEVEL	0 to 31
Parameter 5	PATCH LEVEL	0 to 31

#### Explanation

(4)/(5)**PATCH LEVEL**: Determines the individual output level for each patch.



*The patch level parameter can be set regardless of the REVERB module on/off status. It is also possible to change the patch level in the Play mode.*

*When all modules are OFF, the PATCH LEVEL setting "25" produces the same volume as in the bypass mode.*

# Other Functions

## Restoring Individual Factory Preset Patches (Patch Recall)

The 2020 contains a ROM (read-only memory) in which all factory preset patch data are permanently stored. Even if patches have been edited and stored in the user group (or patch level settings have been changed and stored in the preset group), the original factory preset patches can be individually recalled at any time.

- **Turn off the 2020 (with the amplifier volume set to minimum), and turn the unit back on while keeping the EDIT/CANCEL key depressed.**

The indication “FC” flashes on the display. This shows that the unit is ready for recalling individual patches from the internal ROM.

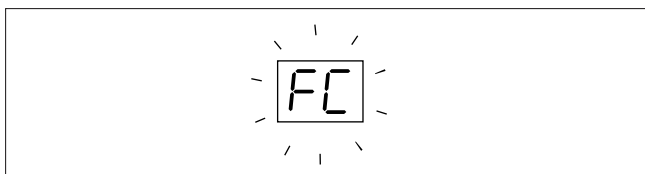

- **Press the STORE key.**

You now can select the group, bank number and patch number you want to restore.

The indication “FC” appears alternately on the group and bank number display.

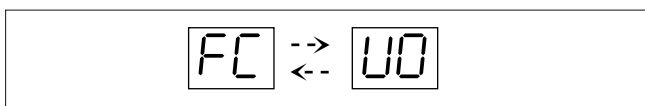

- **Use the GROUP key, BANK pedal, and pedals 1 - 4 to select the desired patch.**

At this time, the sound of the patch can be monitored.

- **Press the STORE key once more.**

The selected patch is now restored to the same setting as when the unit was shipped. (For patches in the preset group, the patch level is set to the initial value.)

- **Turn off the 2020, and then turn it on again for normal use.**

The 2020 will be in regular Play mode.

## Restoring All Factory Preset Patches (Initialize)

This special function returns all patches in the preset group and the user group to the factory preset condition. Use this function with care, because all patches you have stored in the user group will be lost.

- **Turn off the 2020 (with the amplifier volume set to minimum), and turn the unit back on while keeping the STORE key depressed.**

The indication “AL” flashes on the display. This shows that the unit is ready for recalling all patches from the internal ROM.

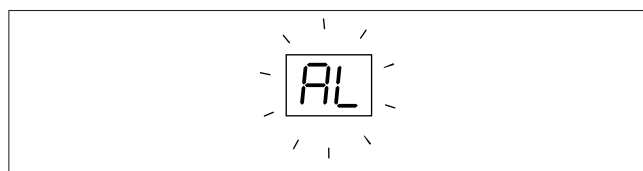

- **When wishing to initialize all patches**  
Press the STORE key once more. This restores all patches to their factory preset condition. The 2020 then switches to the Play mode.
- **When wishing to cancel the function**  
Press the EDIT/CANCEL key. The 2020 switches to the Play mode without changing the patch settings.

# Application Examples for Use of Foot Pedal and Foot Switch

The optional foot pedal FP01 and foot switch FS01 allow easy volume control and mode switching during a performance.

## Using the FP01

The optional foot pedal FP01 can serve to operate the volume control or WAH function of the 2020 and to switch effects.

- Using the FP01 to Control the Volume
- Connect the FP01 to the CONTROL IN VOLUME jack of the 2020.

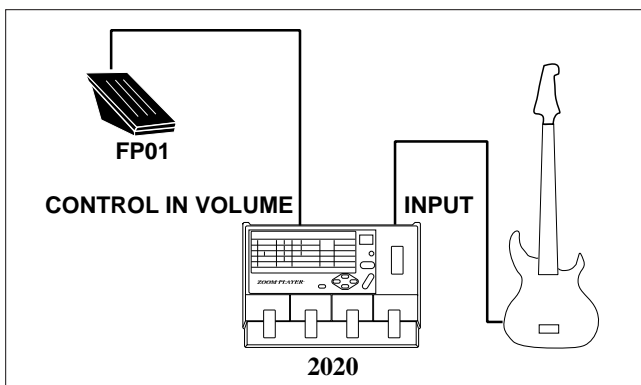

- In the Play mode of the 2020, use the foot pedal while playing the instrument.

**NOTE** The general volume control of the 2020 is independent of the individual patch level settings. Since the level is adjusted between the EQ module and the MODULATION module, operating the volume control does not affect reverberation.

- Using the FP01 for Pedal Wah
- Turn off the 2020, and connect the FP01 to the CONTROL IN MANUAL/WAH jack of the 2020.

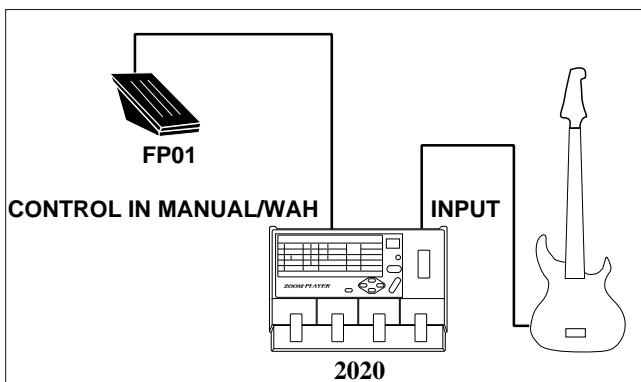

- Turn on the 2020 and select the effect type WAH in the EQ module.

The action of the FP01 depends on the SENS parameter setting of the WAH effect.

- If SENS is set to 0 (zero)  
The auto wah function of the effect is turned off, and the FP01 operates as a pedal wah.
- If SENS is not set to 0 (zero)  
The FP01 varies the auto wah SENS parameter between 0 and 10. This means that the FP01 acts as an auto wah controller.

**NOTE** When connecting the FP01 to a CONTROL IN jack, use the EXP. OUT connector of the FP01.

## Using the FS01

The optional foot switch FS01 can be used to switch between the normal Play mode and the Manual mode where effects can be individually switched on and off.

- Turn off the 2020, and connect the FS01 to the CONTROL IN MANUAL/WAH jack of the 2020.

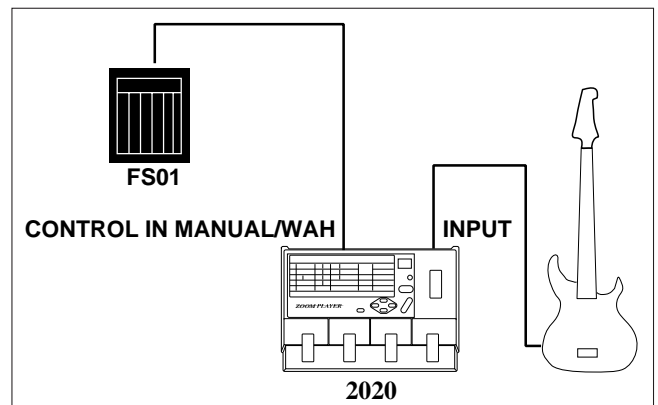

- Turn on the 2020 and select the patch.
- Push the FS01 once.

This switches the 2020 to the Manual (Edit) mode. The on/off status of individual effect modules can now be controlled with the BANK pedal and pedals 1 - 4.

**NOTE** In Manual mode, selecting patches is not possible.

- Push the FS01 once more.

# Specifications

The 2020 reverts to the normal Play mode, and patch selection is possible.

## ZOOM PLAYER 2020

<b>Number of effect programs:</b>	19 types (5 modules)
<b>A / D conversion:</b>	16-bit 64-times oversampling MASH converter
<b>D / A conversion:</b>	16-bit linear
<b>Inputs:</b>	Guitar input Phone Jack (Mono) x 1 (nominal input level -20 dBm, input impedance 470 k $\Omega$ )
<b>Outputs:</b>	Line Phone Jack (Mono) x 2 Headphones (also recording output): Mini phone jack (Stereo) PHONES (output power 35 mW into 32 ohms) REC OUT (nominal output level -20 dBm, recommended load impedance 10 K $\Omega$ or more) Tuner out Phone Jack (Mono) x 1 (nominal output level -20 dBm, recommended load impedance 47 K $\Omega$ or more)
<b>Control connectors:</b>	Foot pedal input Manual mode foot switch / wah control input
<b>Display:</b>	2-character, 7-segment LED display
<b>Power supply:</b>	9 V DC, 150 mA (from supplied AC adapter)
<b>Dimensions:</b>	300 x 210 x 42 (W x D x H)
<b>Weight:</b>	1.2 kg

\* 0 dBm=0.775 Vrms

\* Design and specifications subject to change without notice.