

Plan 2

Statistics

Area: 1098 sq ft
Living area: 116 sq ft
1 Floor
2 Bedrooms
2 Bathrooms

Ground Floor

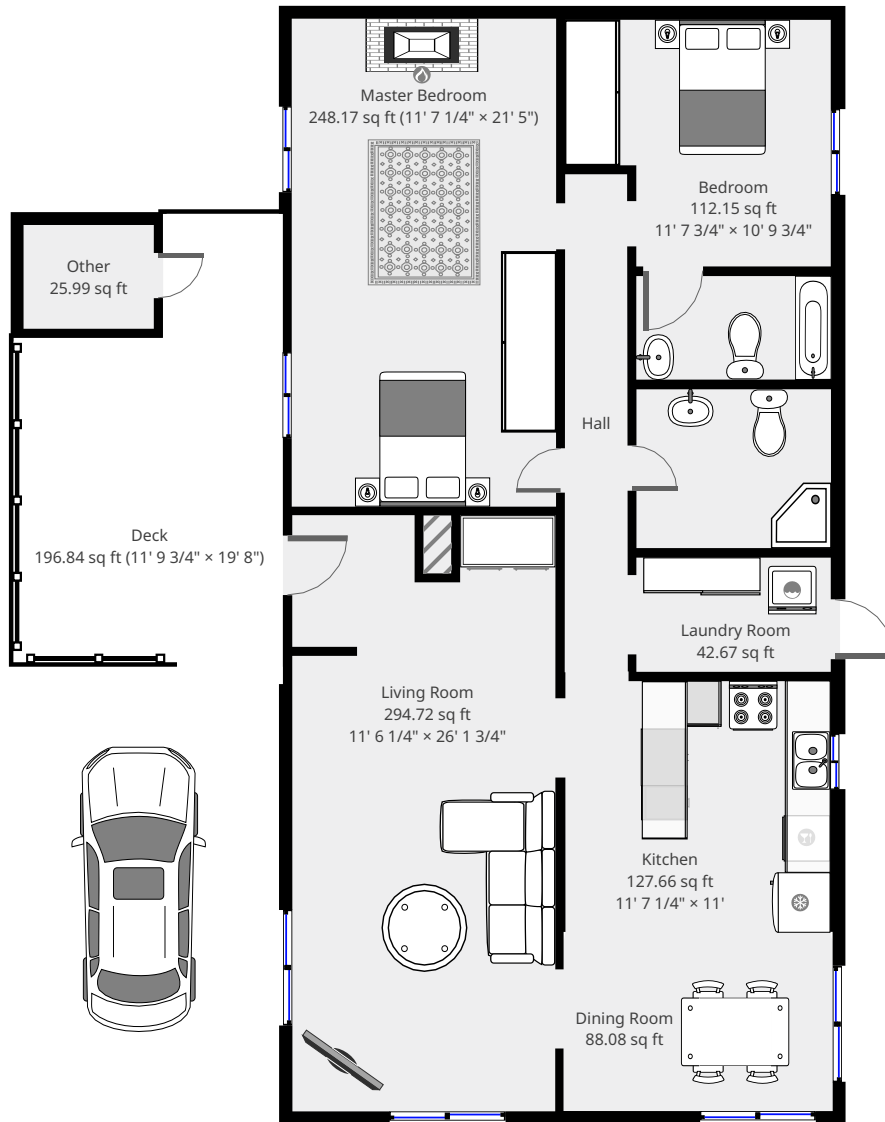

THIS FLOORPLAN IS PROVIDED WITHOUT WARRANTY OF ANY KIND. SENSOPIA DISCLAIMS ANY WARRANTY INCLUDING, WITHOUT LIMITATION, SATISFACTORY QUALITY OR ACCURACY OF DIMENSIONS.

Plan 2

Living Room

Width: 11' 6 1/4"
 Length: 26' 1 3/4"
 Area: 294.72 sq ft
 Perimeter: 86' 11 1/2"

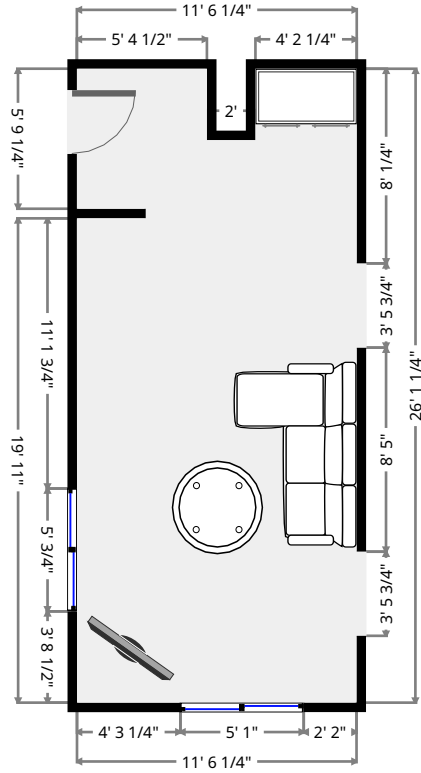

Dining Room

Width: 7' 5 1/2"
 Length: 11' 9 3/4"
 Area: 88.08 sq ft
 Perimeter: 38' 6 1/4"

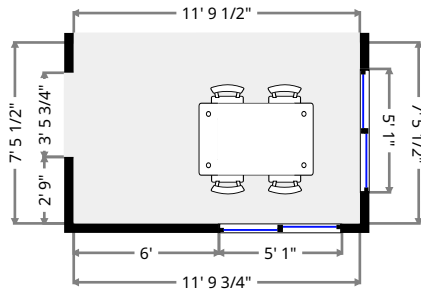

THIS FLOORPLAN IS PROVIDED WITHOUT WARRANTY OF ANY KIND. SENSOPIA DISCLAIMS ANY WARRANTY INCLUDING, WITHOUT LIMITATION, SATISFACTORY QUALITY OR ACCURACY OF DIMENSIONS.



Plan 2

Kitchen

Width: 11'
 Length: 11' 7 1/4"
 Area: 127.66 sq ft
 Perimeter: 45' 2 1/2"

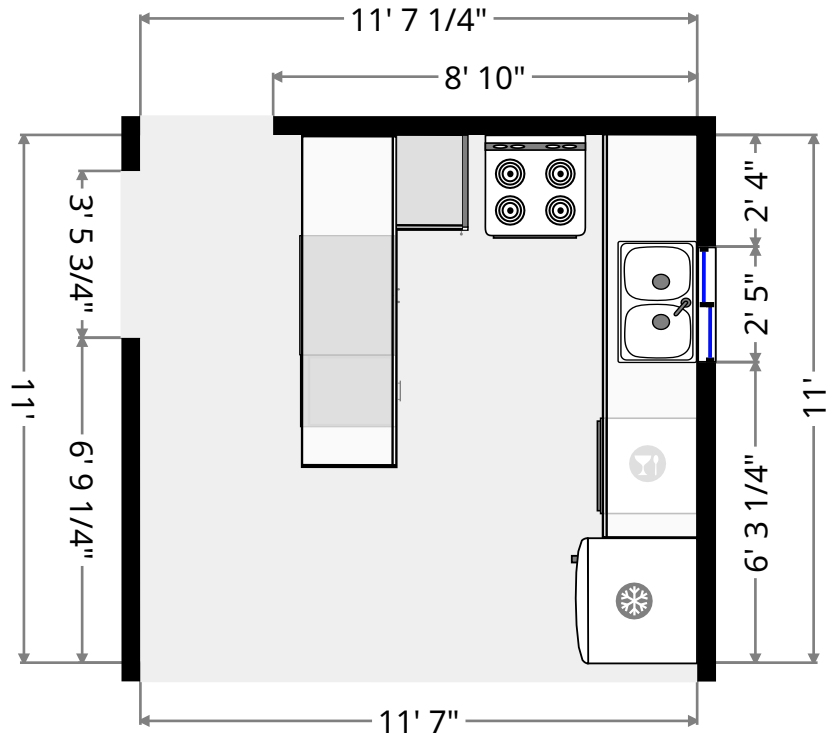

Laundry Room

Width: 5'
 Length: 8' 6 1/4"
 Area: 42.67 sq ft
 Perimeter: 27' 3/4"

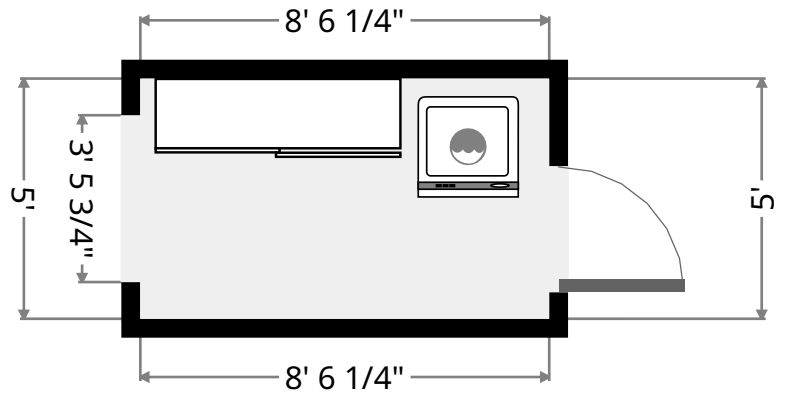

THIS FLOORPLAN IS PROVIDED WITHOUT WARRANTY OF ANY KIND. SENSOPIA DISCLAIMS ANY WARRANTY INCLUDING, WITHOUT LIMITATION, SATISFACTORY QUALITY OR ACCURACY OF DIMENSIONS.



Plan 2

Master Bedroom

Width: 11' 7 1/4"
 Length: 21' 5"
 Area: 248.17 sq ft
 Perimeter: 66'

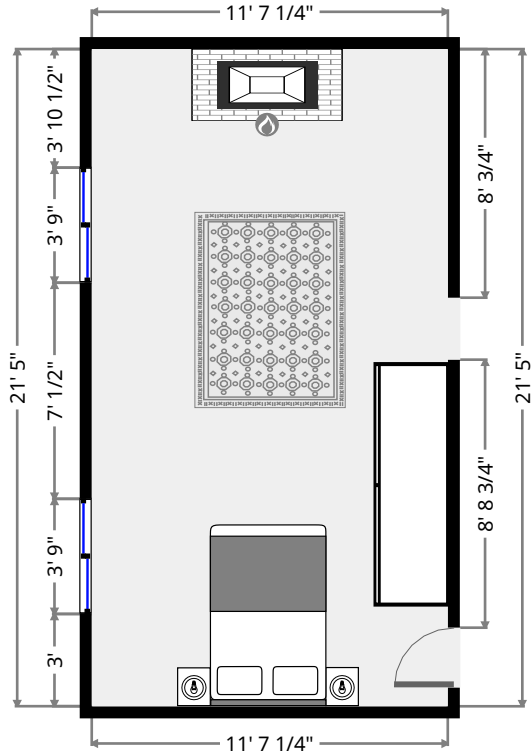

Bedroom

Width: 10' 9 3/4"
 Length: 11' 7 3/4"
 Area: 112.15 sq ft
 Perimeter: 44' 11 1/4"

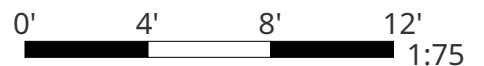
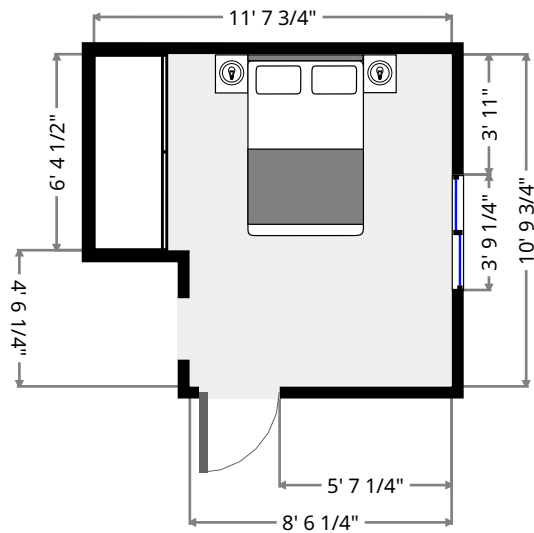

THIS FLOORPLAN IS PROVIDED WITHOUT WARRANTY OF ANY KIND. SENSOPIA DISCLAIMS ANY WARRANTY INCLUDING, WITHOUT LIMITATION, SATISFACTORY QUALITY OR ACCURACY OF DIMENSIONS.

Plan 2

Bathroom

Width: 4' 6 1/4"
 Length: 8' 6 1/2"
 Area: 38.78 sq ft
 Perimeter: 26' 2"

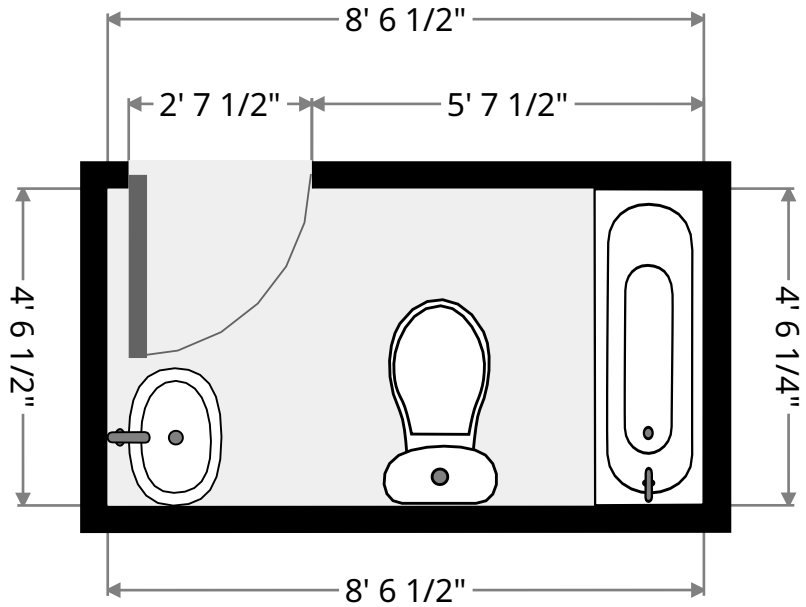

Bathroom

Width: 6' 11 1/2"
 Length: 8' 6 1/2"
 Area: 59.41 sq ft
 Perimeter: 31'

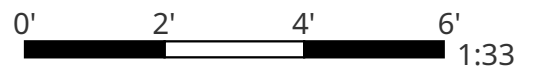
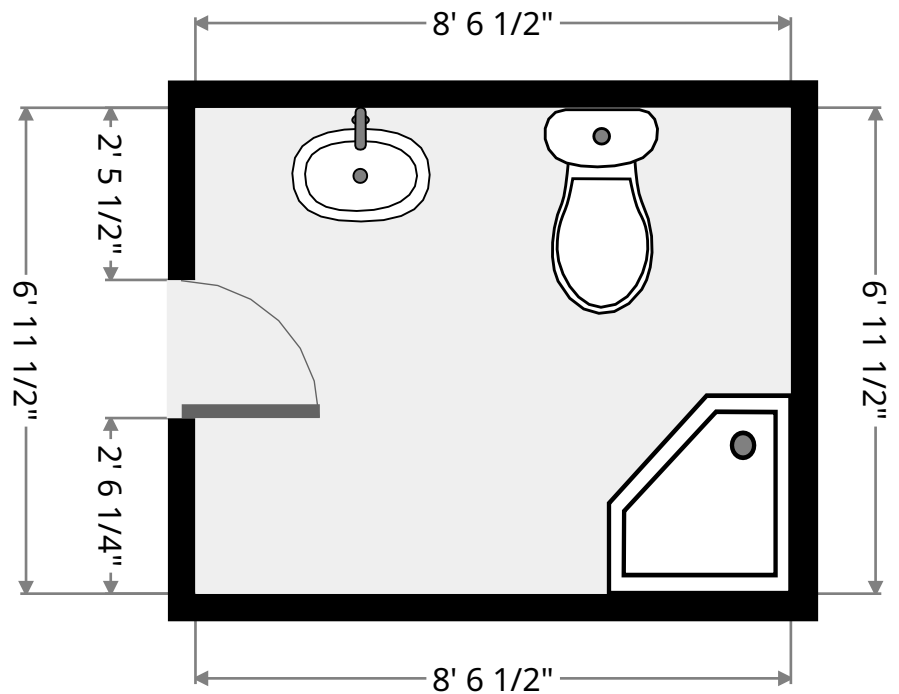

THIS FLOORPLAN IS PROVIDED WITHOUT WARRANTY OF ANY KIND. SENSOPIA DISCLAIMS ANY WARRANTY INCLUDING, WITHOUT LIMITATION, SATISFACTORY QUALITY OR ACCURACY OF DIMENSIONS.

Plan 2

Hall

Width: 2' 9 1/4"
 Length: 21' 10"
 Area: 59.90 sq ft
 Perimeter: 49' 2"

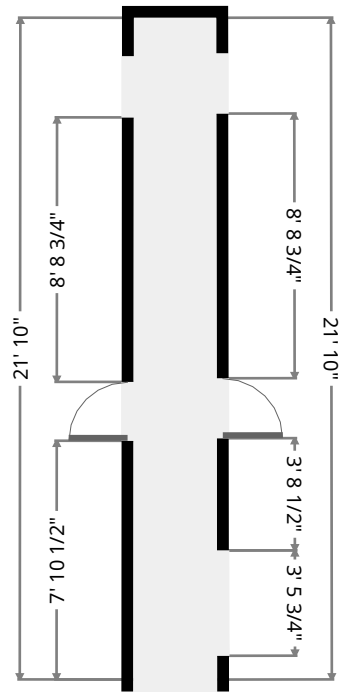

Deck

Width: 11' 9 3/4"
 Length: 19' 8"
 Area: 196.84 sq ft
 Perimeter: 62' 11 3/4"

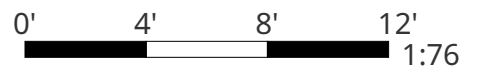
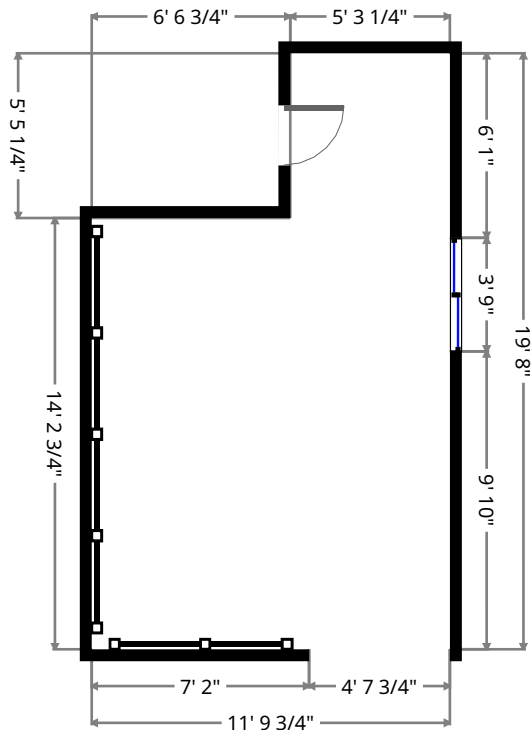

THIS FLOORPLAN IS PROVIDED WITHOUT WARRANTY OF ANY KIND. SENSOPIA DISCLAIMS ANY WARRANTY INCLUDING, WITHOUT LIMITATION, SATISFACTORY QUALITY OR ACCURACY OF DIMENSIONS.

Plan 2

Other

Width: 4' 6 1/2"
Length: 5' 8 1/2"
Area: 25.99 sq ft
Perimeter: 20' 6 1/4"

