

5 Nm RC65 10 and 17 Watts 10 W Part number made to order



- Torque rating of gearboxes : 5 Nm, metal gears
- Motors : nominal power 9 W to 15 W
- Speed range : 1.04 to 208 rpm
- Replaceable brushes

Part numbers

	Type	Type	Voltage	Output speed (rpm)	Ratios (i)
MADE TO ORDER	10 W	80 817 0	48 V	208	25/2

Specifications

General characteristics

Motor	82 810 0
Gearbox	81 037 0
Maximum permitted torque from gearmotor under continuous conditions for 1 million turns (Nm)	5
Axial load dynamic (daN)	2
Radial load dynamic (daN)	3
Max. output power (W)	9
Nominal output (W)	8,2
Gearbox case temperature rise (°C)	45
Weight (g)	710

Made to order products, available on request

Motors :

- Other supply voltages
- Motor with 1 ball bearing at front (essential for vertical motor)
- Shaft lengths at front and/or rear
- Special interference suppression
- 5 pulses/revolution magnetic encoder
- Other fixing flanges on front

Gearboxes :

- Drawn cup needle bearing for 81 032 6
- Special cover for 81 032 6
- Special greasing
- Special shaft
- Other reduction ratios

Dimensions (mm)

80 817 0 standard

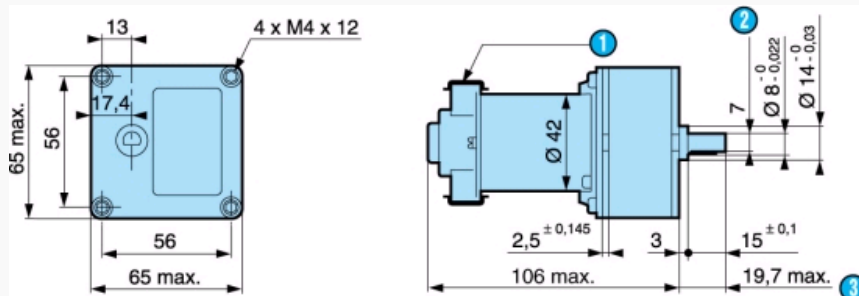

N°	Legend
①	2 tags IEC 760, series 4.8 x 0.5
②	7 across flats
③	(shaft pushed-in)

Dimensions (mm)

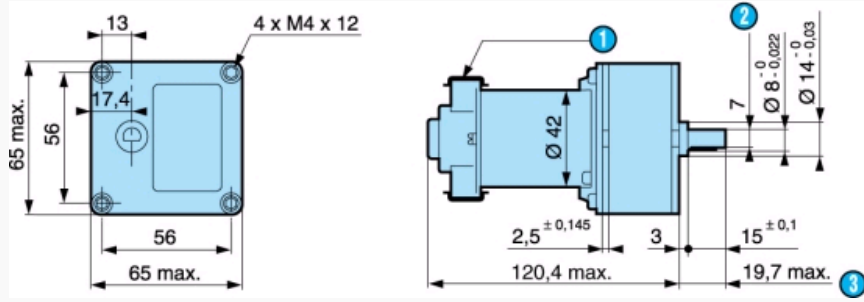

N°	Legend
1	2 tags IEC 760, series 4.8 x 0.5
2	7 across flats
3	(shaft pushed-in)

Dimensions (mm)

Gearbox shaft 79 206 478

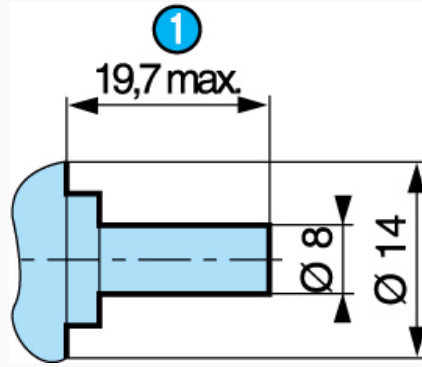

N°	Legend
1	(shaft pushed-in)

Curves

Curve : torque/nominal speed

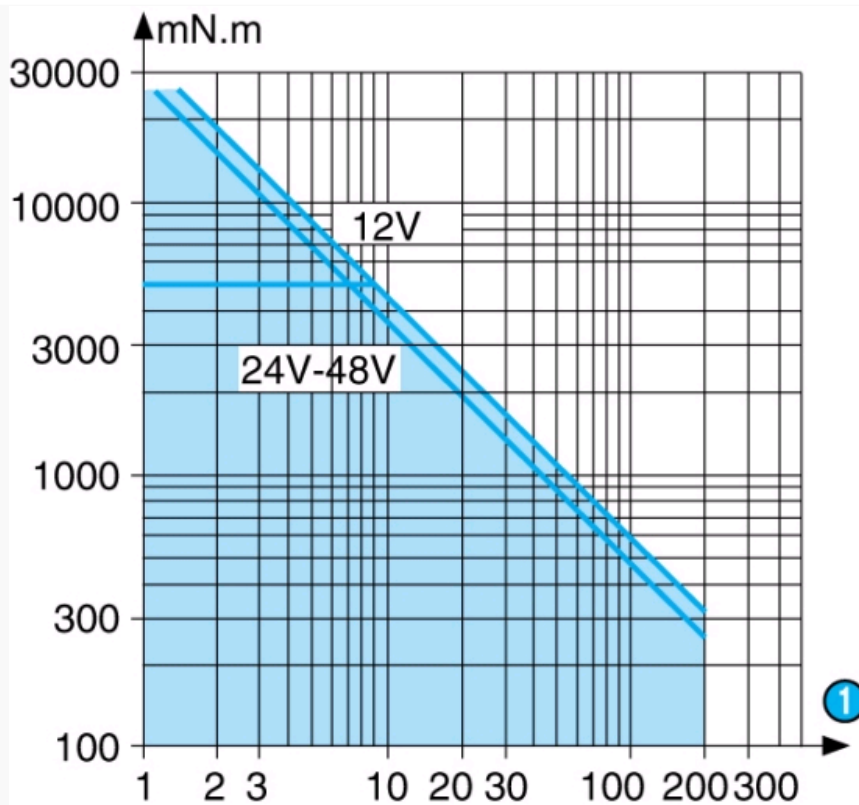

The shaded zone represents the operating range of the geared motor. The horizontal line marks the maximum torque available in continuous duty cycle for a given life. For higher torque ratings, service life will be reduced.

N°	Legend
1	rpm

Product adaptations



- Special supply voltage
- Optical or Hall effect encoder
- Special connections
- Special shaft
- Special reduction ratio (40 ratios available from 4 to 3750)
- Special materials for gears
- Special ball bearings
- Special adaptor plate
- With 828105 or 828005 motor
- With 82830 - 30 W motor