



2023

NX450h+ / NX350h / NX350 / NX250

MULTIMEDIA OWNER'S MANUAL



© 2022 TOYOTA MOTOR CORPORATION

All rights reserved. This material may not be reproduced or copied, in whole or in part, without the written permission of Toyota Motor Corporation.

Basic operation	Basic operation of multimedia system	1
Settings and registration	Registering and setting various features	2
Connecting a smartphone or communication device	Using Bluetooth® or Wi-Fi®	3
Navigation	Operating the map screen Searching the map Activating the route guidance	4
Audio system	Listening to the radio Enjoying music	5
Hands-free calls	For hands-free cellular phone use	6
Connected Services	Operating the connected services	7
Parking assist system	Checking the situation around the vehicle	8
Appendix	Reference Information Certification	9
Index	Search alphabetically	

Introduction

For your information.....	6
Safety instructions	9
Reading this manual	10
Pictorial index	12

1 Basic operation

1-1. Basic operation of multimedia system

Display and control.....	14
Multimedia screen overview.....	16
Main menu	17
Status icons	18
Operating the touch screen.....	20
Basic screen function.....	23
Entering letters and numbers.....	25

1-2. Basic operation of navigation system

Map screen overview	26
Operating the map screen	27

1-3. Basic operation of audio system

Audio system ON/OFF and volume adjustment.....	30
Changing the audio source.....	32
Connecting the USB port	34

1-4. Intelligent Assistant

Using the Intelligent Assistant system.....	35
Starting voice control	38
Speaking a voice command.....	41
Using the search function.....	44

2 Settings and registration

2-1. Multimedia system initial setup

Registering a user profile.....	46
---------------------------------	----

2-2. Various settings

Changing the various settings.....	51
------------------------------------	----

2-3. Driver settings

Changing and registering a user profile	53
Setting up how to identify a driver	55

2-4. General settings

Changing general multimedia system settings	57
---	----

2-5. Notification settings

Notifications settings	60
------------------------------	----

2-6. Screen settings

Changing the screen display settings	61
--	----

2-7. Voice control settings

Changing the voice control settings	63
---	----

2-8. Vehicle settings

Setting dealer information.....	64
Changing the security settings	65
Updating and checking the software information.....	67

2-9. Navigation system settings

Displaying the navigation system settings screen.....	72
Map details settings screen.....	73
Route options.....	75

2-10. Sound and media settings

Changing sound and media settings	76
---	----

2-11. Wi-Fi® Settings

Changing Wi-Fi® settings **80**

Setting Wi-Fi® Hotspot..... **82**

2-12. Bluetooth® Settings

Setting Bluetooth® devices..... **84**

2-13. Apps settings

Apps settings..... **87**

3

Connecting a smartphone or communication device

3-1. Using the Bluetooth® function

Precautions when using Bluetooth® devices..... **90**

Bluetooth® specifications and compatible profiles **93**

Registering a Bluetooth® device from the multimedia system..... **94**

Deleting a registered Bluetooth® device..... **97**

Connecting with a Bluetooth® device..... **98**

Setting a Bluetooth® device as a primary device..... **102**

Setting a Bluetooth® device as a secondary device..... **103**

3-2. Connecting to a Wi-Fi® network

Precautions when using Wi-Fi® devices **104**

Connecting to a network using Wi-Fi® **106**

Establishing a connection to Wi-Fi® Hotspot..... **109**

3-3. Using Apple CarPlay and Android Auto

Precautions when using Apple CarPlay and Android Auto..... **112**

Using Apple CarPlay with an unregistered smartphone..... **115**

Using Apple CarPlay with a registered smartphone **118**

Using Android Auto with an unregistered smartphone..... **121**

Using Android Auto with a registered smartphone **124**

When Apple CarPlay or Android Auto might be malfunctioning..... **127**

4

Navigation

4-1. Navigation

Navigation function **132**

4-2. Map information

Map options screen..... **133**

Information displayed on the map screen **134**

4-3. Searching for a destination

Destination search screen..... **136**

Destination search result list screen **140**

POI suggestion..... **141**

Destination Assist..... **142**

4-4. Starting route guidance

Starting route guidance..... **144**

Full route map screen **145**

4-5. Route guidance screen

Route guidance screen..... **147**

Typical voice guidance prompts..... **151**

5 Audio system

5-1. Radio operation

Listening to the radio **154**
 Troubleshooting guide..... **158**
 Refer to the table below to identify the problem and take the suggested corrective action..... **159**
 Handling the radio antenna..... **160**

5-2. USB flash drive operation

Precautions for playback of USB flash drive..... **161**
 Playing music files on a USB flash drive..... **163**

5-3. iPod/iPhone operation

Precautions for playback of iPod/iPhone..... **166**
 Playing iPod/iPhone..... **167**

5-4. Apple CarPlay operation

Precautions for playback of Apple CarPlay **170**
 Playing Apple CarPlay **171**

5-5. Android Auto operation

Precautions for playback of Android Auto..... **174**
 Playing Android Auto..... **175**

5-6. Bluetooth® audio operation

Precautions for Bluetooth® audio playback..... **177**
 Playing Bluetooth® audio **179**

5-7. Integrated Streaming

Playing Integrated Streaming.. **182**

6 Hands-free calls

6-1. Precautions when using hands-free calls

Precautions for hands-free calling..... **186**
 Precautions when selling or disposing of the vehicle **189**
 When hands-free calling might be malfunctioning **190**

6-2. Operating hands-free calls with the steering switches

Operating with the steering switches (Type A)..... **194**
 Operating with the steering switches (Type B) **196**

6-3. How to make calls

Making calls from call history.. **198**
 Making calls from the favorites list..... **199**
 Making calls from contacts..... **200**
 Making calls from keypad **201**

6-4. How to receive calls

Answering calls..... **202**
 Declining calls..... **204**

6-5. In-call operations

Perform operations from the in-call screen..... **205**
 Answer second call..... **207**
 Making a call to another party during an ongoing call..... **208**
 Making conference calls..... **209**
 Ending calls **210**

6-6. Changing phones for hands-free calls

Switching phones for hands-free calls..... **211**

6-7. Editing contact data

Transferring contact data..... **212**

6-8. How to use the message function

Precautions when using the message function..... **214**

Making calls from the message function..... **217**

7 Connected Services

7-1. Connected Services overview

Functional overview..... **220**

Type A: Function achieved by using DCM and the system... **221**

Type B: Function achieved by using DCM **222**

Type C: Function achieved by using DCM and a smart phone..... **223**

8 Parking assist system

8-1. Lexus parking assist monitor

Lexus parking assist monitor functions **226**

Displaying the guide screen.... **228**

Changing the guide line display mode **230**

Precautions for the Lexus parking assist monitor **235**

8-2. Panoramic view monitor

Panoramic view monitor functions..... **245**

Display mode when the shift position is in "P" **249**

Display mode when the shift position is in "D" or "N" **251**

Display mode when the shift position is in "R" **259**

The screen when the outside rear view mirrors are folded. **267**

Zooming in on the screen **268**

Displaying transparent under-floor vision **270**

Changing the panoramic view monitor settings..... **272**

Precautions for the panoramic view monitor..... **274**

If you notice any symptoms..... **291**

9 Appendix

9-1. Appendix

Information about media and data that can be used in the audio system..... **294**

HD Radio/SiriusXM Radio **302**

Certification..... **305**

Index..... **312**

For your information

Multimedia owner's manual

- This manual describes the operation of the multimedia system. Please read this manual and the "OWNER'S MANUAL" carefully to ensure proper use.
- Please be aware that the content of this manual may be different from the system in some cases, such as due to software updates and changes to specifications.
- This manual contains information related to system software Ver.1040 and earlier. For the latest information, refer to the following URL. Before using this system, be sure to read the information relating to the latest software version. For details of the current software version, see "Updating and checking the software information" (→ P.67).

Depending on the country or area, the software update service may not be available.

▶ NX450h+ (U.S.A.)

- URL:

<https://drivers.lexus.com/lexusdrivers/resources/owners-manuals/manual?om=om78359u.nx.2023.2210.phev.mm>

- QR code:



▶ NX450h+ (Canada)

- URL:

<https://www.lexus.ca/lexus/know-your-lexus/manual?om=om78359u.nx.2023.2210.phev.mm>

- QR code:



► **NX350h (U.S.A.)**

- URL:

<https://drivers.lexus.com/lexusdrivers/resources/owners-manuals/manual?om=om78359u.nx.2023.2210.hev.mm>

- QR code:



► **NX350h (Canada)**

- URL:

<https://www.lexus.ca/lexus/know-your-lexus/manual?om=om78359u.nx.2023.2210.hev.mm>

- QR code:



► **NX350/NX250 (U.S.A.)**

- URL:

<https://drivers.lexus.com/lexusdrivers/resources/owners-manuals/manual?om=om78359u.nx.2023.2210.cv.mm>

- QR code:



► **NX350/NX250 (Canada)**

- URL:

<https://www.lexus.ca/lexus/know-your-lexus/manual?om=om78359u.nx.2023.2210.cv.mm>

- QR code:



- The screens shown in this manual may differ from the actual screen of the system depending on availability of functions, subscription status, and map data available at the time this manual was produced.
- The company names and products listed in this manual are trademarks and/or registered trademarks of their respective companies.

Disclaimer about data compensation

This system saves data onto the internal memory. Data saved in the memory may become corrupted or lost due to system failure, repair, malfunction, bugs, or other causes.

Please note that Toyota takes no responsible whatsoever for direct and/or indirect damage, and offers no compensation for data if the data that was saved in the internal memory could not be saved properly.

Removal of the 12-volt battery

When the engine switch <power switch> is turned off, all data is saved in the system. If the 12-volt battery terminal is removed before the data is saved, the data may not be saved correctly.

Safety instructions

To use this system in the safest possible manner, follow all the safety tips shown below.

This system is intended to assist in reaching the destination and, if used properly, can do so. The driver is solely responsible for the safe operation of the vehicle and the safety of your passengers. Do not use any feature of this system to the extent it becomes a distraction and prevents safe driving. The first priority while driving should always be the safe operation of the vehicle. While driving, be sure to observe all traffic regulations. If a traffic sign on the road has been changed, route guidance may not have the updated information such as the direction of a one way street.

While driving, listen to the voice instructions as much as possible and glance at the screen briefly and only when it is safe. However, do not totally rely on voice guidance. Use it just for reference. If the system cannot determine the current position correctly, there is a possibility of incorrect or delayed guidance, or no voice guidance at all.

The data in the system may occasionally be incomplete. Road conditions, including driving restrictions (no left turns, street closures, etc.) frequently change. Therefore, before following any instructions from the system, look to see whether the instruction can be done safely and legally.

This system cannot warn about such things as the safety of an area, condition of streets, and availability of emergency services. If unsure about the safety of an area, do not drive into it. Under no circumstances is this system a substitute for the driver's personal judgement.



WARNING

- For safety, the driver should not operate the system while he/she is driving. Insufficient attention to the road and traffic may cause an accident.
- While driving, be sure to obey the traffic regulations and maintain awareness of the road conditions.

Reading this manual

Explains symbols used in this manual.

Symbols in this manual

Symbols	Meanings
	WARNING : Explains something that, if not obeyed, could cause death or serious injury to people.
	NOTICE : Explains something that, if not obeyed, could cause damage to or a malfunction in the vehicle or its equipment.
1 2 3...	Indicates operating or working procedures.
	Explains something other than descriptions about operation methods and functions that you should know and are useful to know.

Symbols in illustrations

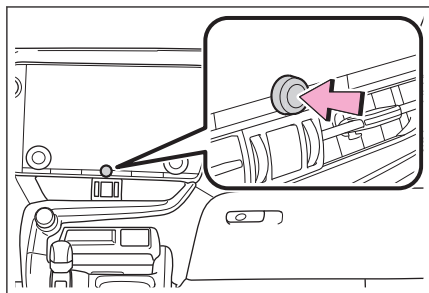

Symbols	Meanings
	Indicates the action (pushing, turning, etc.) used to operate buttons and other devices.

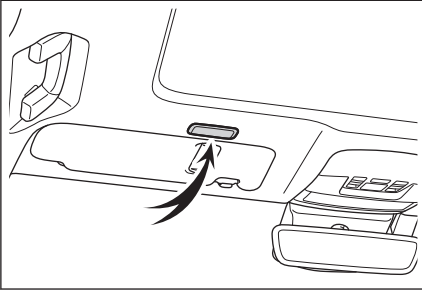

Symbols	Meanings
	Indicates the component or place being explained.

Pictorial index

Instrument panel

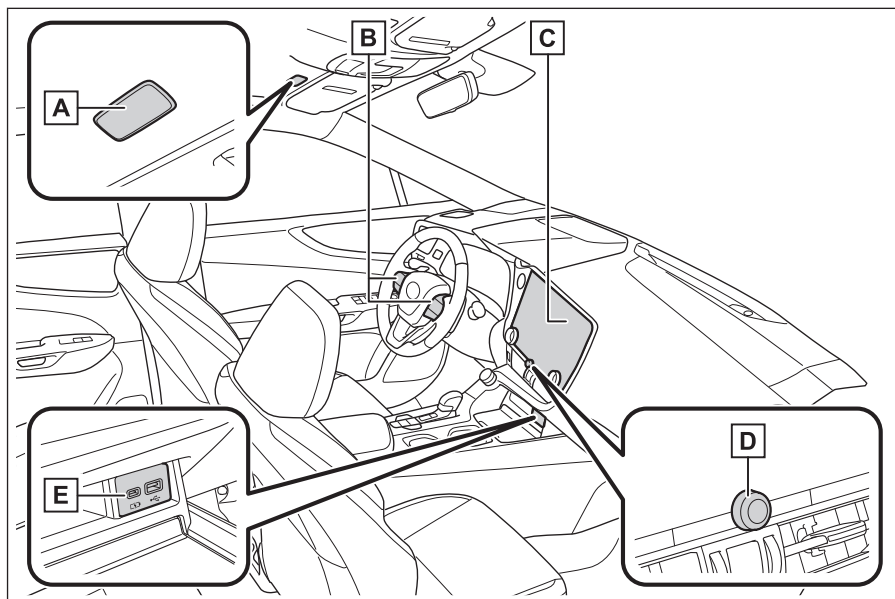

A	Microphone.....	P.37
B	Steering wheel switches	
	Controlling audio	P.32
	Operating the system with voice control	P.38
	Making a phone call	P.194,196
C	Display	P.14
D	[ VOL] knob.....	P.30
E	USB port.....	P.34

1-1. Basic operation of multimedia system

Display and control.....	14
Multimedia screen over- view	16
Main menu	17
Status icons	18
Operating the touch screen ..	20
Basic screen function.....	23
Entering letters and num- bers.....	25

1-2. Basic operation of navigation system

Map screen overview	26
Operating the map screen.....	27

1-3. Basic operation of audio system

Audio system ON/OFF and volume adjustment.....	30
Changing the audio source ...	32
Connecting the USB port.....	34

1-4. Intelligent Assistant

Using the Intelligent Assis- tant system.....	35
Starting voice control	38
Speaking a voice command....	41
Using the search function	44

Display and control

▶ 14-inch display

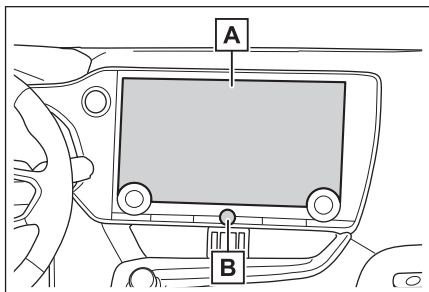

▶ 9.8-inch display

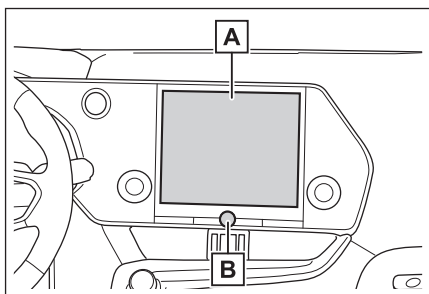

A Display

Operate the touch screen by directly touching it.

B [ON VOL] knob

Turn the audio on/off and adjust the volume.

☐ INFORMATION

- The LCD screen may appear washed out or dark depending on the surrounding environment or angle it is viewed.
- The screen may be difficult to see if sunlight or other external light hits the screen.
- The screen may appear dark or hard to see if you wear polarized sunglasses.

⚠ WARNING

For safety, the driver should operate the display as little as possible while driving and should stop the vehicle to operate the display. Operating the display while driving is dangerous such as mistakenly turning the steering wheel or other unforeseen accidents. Additionally, look at the display only as necessary and as briefly as possible when driving the vehicle.

⚠ NOTICE

Do not use the display for long periods of time with the engine <hybrid system> turned off. Doing so may deplete the 12-volt battery.

Restarting the system

When the system response is extremely slow, you can restart the system.

- Press and hold the [ VOL] knob for at least 3 seconds.

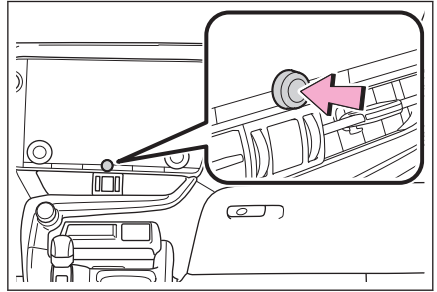

Multimedia screen overview

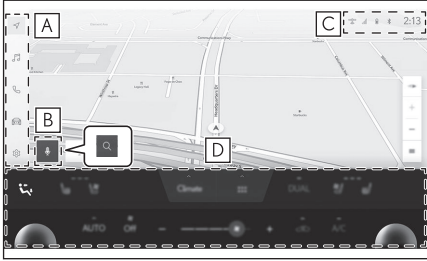

A Main menu

Changes the function to be displayed on the screen when an icon is touched.

B Microphone button

Displays the voice control screen enabling verbal operation of the navigation, audio, climate, and various other functions. The button will be change depending on the situation.



: While driving



: When stopped

C Status icons

The clock and icons with information about communication statuses, etc. are displayed at the top of the screen.

D Climate control buttons

Operate the air conditioner and vehicle functions.*1

INFORMATION

The displayed content may differ depending on the size of the multimedia screen.

Related Links

[Main menu\(P. 17\)](#)

[Starting voice control\(P. 38\)](#)

[Status icons\(P. 18\)](#)

*1: Refer to the "OWNER'S MANUAL".

Main menu

The function to be displayed on the screen can be changed by touching an icon.

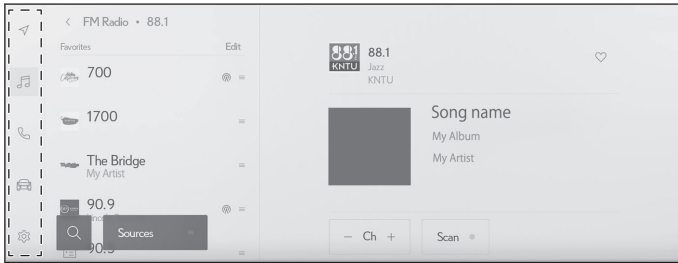

 : Apple CarPlay®

Displays the Apple CarPlay screen.

 : Android Auto™

Displays the Android Auto screen.

 : Navigation system

Displays the map screen. The navigation system can be operated to search for a destination or perform other navigation system-related tasks.

 : Audio

Displays the audio control screen. The desired source can be selected to play audio.

 : Phone

Displays the phone screen. A cellular phone connected via Bluetooth® can be used to make hands-free phone calls.

 : Vehicle information*1

Displays the vehicle information screen. Vehicle information such as fuel consumption displays and settings of vehicle equipment can be done.

 : Settings

Displays the settings screen. Multimedia system and vehicle settings can be changed.

INFORMATION

The Apple CarPlay/Android Auto icons are displayed when a supported device connects to the system and the applicable function is enabled.

*1: Refer to the "OWNER'S MANUAL".

Status icons

The time and icons with information about communication statuses are displayed at the top of the screen.

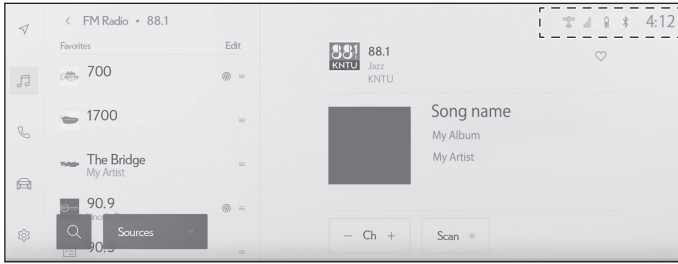

4:12

Displays the current time. Touching the clock displays the date and time settings screen.



Displays the connection status of the cellular phone connected via Bluetooth[®]. Touching the icon displays the Bluetooth[®] settings screen.



Displays the reception level of the connected cellular phone.



Displays the remaining battery charge of the connected cellular phone.



Displays the reception status of the Data Communication Module (DCM).^{*1}



Displays the Wi-Fi[®] reception level.



Displays the Wi-Fi[®] Hotspot reception level.^{*2}



Displayed when the Intuitive parking assist is active.^{*1}



Displayed when a hands-free call was made while a screen other than the phone screen was being displayed.



Displayed when the wireless charger is equipped. *1

INFORMATION

- The displayed remaining battery charge for the cellular phone may not match the display on the cellular phone. Additionally, the remaining battery charge may not be able to be displayed depending on the phone model.
- You may not be able to use Wi-Fi® if the reception level is poor.
- If you use your cellular phone at places or states like the following, you may not be able to connect via Bluetooth®:
 - The cellular phone is behind or under a seat, or inside the glove box or console box
 - The cellular phone is touching or covered with metallic materials
- If the cellular phone is set to power saving mode, the Bluetooth® connection may automatically be disconnected. If that happens, disable power saving mode on the cellular phone.

Related Links

[Changing general multimedia system settings\(P. 57\)](#)

[Setting Bluetooth® devices\(P. 84\)](#)

*1: If equipped

*2: This function is not available in some countries or areas.

Operating the touch screen

Operate the touch screen by directly touching it with a finger.

■ Touch

Gently touch the screen. You can select items on the screen.

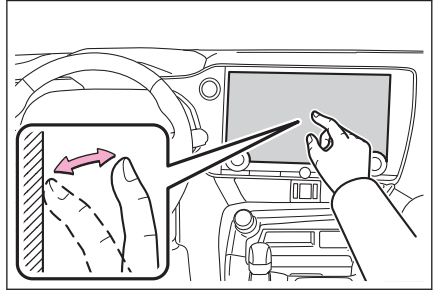

■ Drag

Move your finger while it is touching the screen. The list and map screens can be scrolled to the amount that the finger is moved.

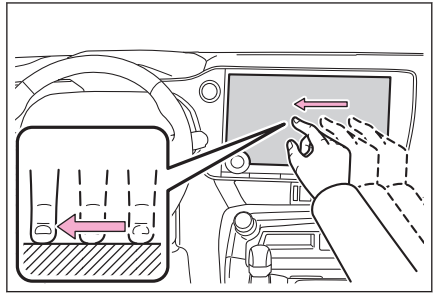

■ Flick

Quickly swipe your fingertip that touches the screen. The list and map screens are scrolled by larger amount than scrolls by dragging.

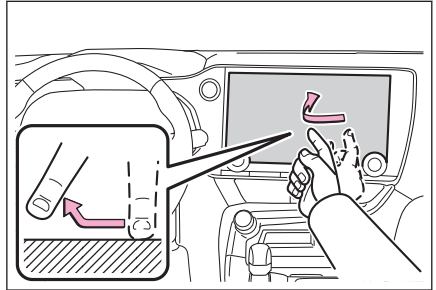

■ Pinch in/pinch out

Move two fingers in and out while touching the screen. You can zoom in and out on maps.

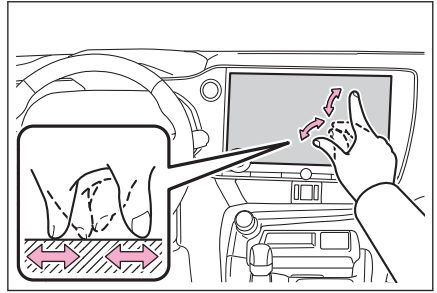

□ INFORMATION

- In order to operate some functions, it may be necessary to touch and hold or double tap (touch 2 times quickly) the screen.
- The sensitivity level when touching the screen can be changed.
- Response sound output either ON/OFF when the screen switch is touched can be changed.
- Flick operations may not work smoothly in high altitude areas.
- Operation of the screen is restricted while driving.

— Related Links —

[Changing general multimedia system settings\(P. 57\)](#)

Notes for operating the touch screen

□ INFORMATION

- If there is no response from the buttons on the screen, take your finger off the screen and try again.
- In the following situations, the screen buttons may not respond or malfunction:
 - If a glove is worn
 - If the screen is operated with a fingernail
 - If the screen is being touched with another finger or palm at the same time
 - Dirt or water is on the screen
 - If a plastic film or coating is on the screen
 - If the vehicle is near a TV tower, power plant, filling station, broadcast station, large display, airport, or any other place from which strong radio waves or noise eliminates

1-1. Basic operation of multimedia system

- When you are carrying or charging a portable wireless communication device, such as a radio or cellular phone, in the vehicle
- If the screen is touched or covered with a metallic object like one of the following, the screen buttons may not respond or malfunction:
 - A card covered in metal such as aluminum foil
 - A cigarette case that uses aluminum foil
 - A wallet, purse, or bag with metallic parts
 - Coins
 - Media, such as CDs and DVDs, a USB cable, etc.
- If the system is started with a finger touching the screen, the screen buttons may not respond. Remove any fingers off the screen and try again. If the buttons are still not responding, turn off the engine switch <power switch> and restart the system.
- The Apple CarPlay map application does not support the pinch in/pinch out feature.

NOTICE

- To protect the screen, gently touch the screen with your finger when operating it.
- Do not operate the touch screen with anything other than your finger.
- Gently clean the screen with a glasses cleaning cloth or similar soft cloth. Touching the screen forcibly with your finger or a hard cloth may scratch the surface of the screen.
- Do not use benzine or an alkaline solution to clean the screen. Doing so may damage the screen.
- Under certain conditions, the screen may feel slightly hot. Be careful as if it is touched for a long time, it may cause slight burns.

Basic screen function

A list screen will be displayed if there are multiple candidates such as settings and audio. Scroll the list to select the desired item.

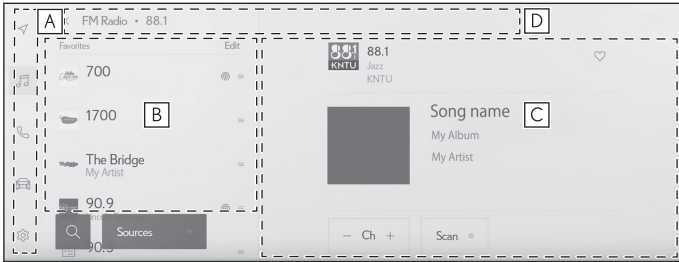

A Main menu

Changes the function to be displayed on the screen by touching an icon.

B Submenu

Displays items on a list. Scrolling the list can be done by dragging or flicking the screen.

C Description area

Displays detailed information about the item you selected on the submenu.

D Breadcrumb list

Displays screen titles in a hierarchy. Touching [] returns to the hierarchy one level up.

INFORMATION

Operation of the screen is restricted while driving.

■ Searching a list

Touching text in an index displays the desired item from the list.

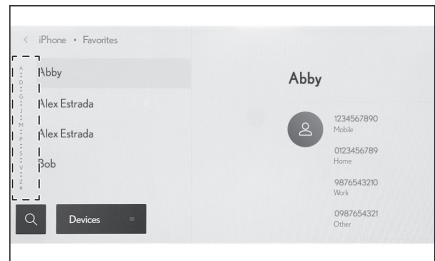

1-1. Basic operation of multimedia system

■ Turning the settings on or off

Touching an item turns the setting on or off.

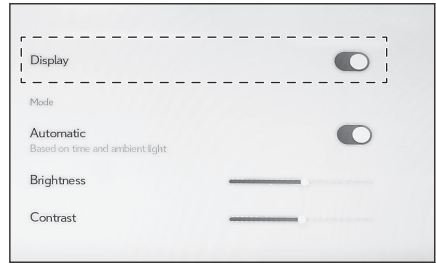

■ Multiple setting options

Touching an item that has [⋮] to it enables you to select an item from multiple options.

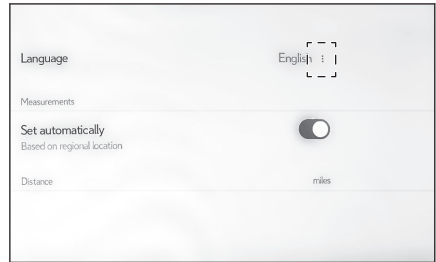

■ Adjusting the level

Dragging the slider enables the level of the setting to be adjusted.



Related Links

[Main menu\(P. 17\)](#)

Entering letters and numbers

Letters and numbers can be entered by using the keyboard. Entering letters displays predictive text.

► Screen example

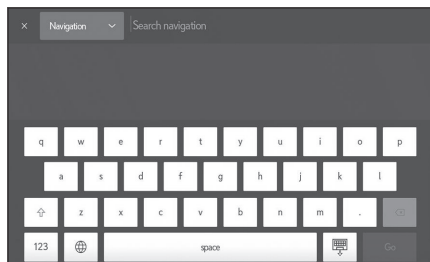

 : Closes the keyboard and returns to the previous screen.

 : Deletes one character.

 : Switches the keyboard.

 : Toggles between uppercase and lowercase.

[Go] : Perform search based on input text.

 : Closes the keyboard.

123 : Changes to the numbers and symbols input mode.

ABC : Changes to the alphabet text input mode.

INFORMATION

- The displayed keyboard type differs depending on the feature.
- Double tap [] to fix the letters to uppercase for input.

1-2. Basic operation of navigation system

Map screen overview

To display the map screen, touch [] on the main menu.



- A** Speed limit icon
Displays the speed limit of the road being driven on.
- B** North up, heading up or 3D heading up icon
- C** Zoom in/out buttons
Touch to increase or reduce the map scale.
- D** Map options button
Touch to display the map options screen.
- E** Current position icon
Displays the current position and orientation of the vehicle. Touch to display detailed information about the current position. Also, touch to share the current position of the vehicle.
- F** Map screen expand/collapse button
Touch to expand/collapse the display of the map screen.
- G** Destination search button
Touch to display the destination search screen.

Related Links

- [Current position\(P. 27\)](#)
- [Map scale\(P. 27\)](#)
- [Orientation of the map\(P. 27\)](#)
- [Map options screen\(P. 133\)](#)
- [Destination search result list screen\(P. 140\)](#)

Operating the map screen

This section explains the basic operations relating to the map display, such as the current position display and scrolling the map

Current position

Touch [▲] to display detailed information about the current position.

[Share location]: Touch to share the vehicle's current position with a registered contact.

To use this function, a smartphone must be connected to the navigation system.

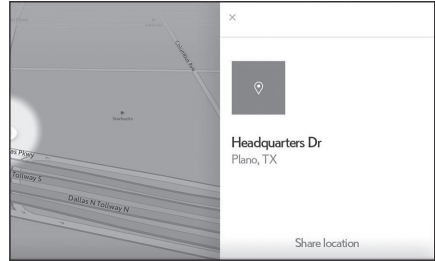

Map scale

Touch [+] or [-] to change the scale of the map screen.

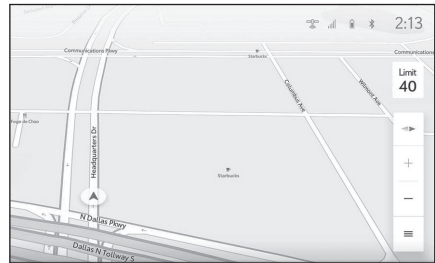

INFORMATION

- Pinch out on the screen to zoom in and pinch in to zoom out.
- Double tapping with 1 finger can also be used to zoom in. Double tapping with 2 fingers can be used to zoom out.
- Can also two finger tilt to change to 3D and back to 2D.

Orientation of the map

Touch [▲N] to change the orientation of the map screen between north up, heading up, and 3D heading up.

[▲N]: North up icon

The map is always displayed with north up, regardless of the direction travel of the vehicle.

1-2. Basic operation of navigation system

The letter(s) under this symbol indicate the vehicle' heading direction (e.g. N for north).

[]: Heading up icon

The map is always displayed with the direction of travel during an active route navigation.

[]: 3D Heading up icon

The map is always displayed with the direction of travel of the vehicle always up.

Map scrolling operation

The map can be moved and a touched point can be set as the center of the map screen.

Related Links

[Operating the touch screen\(P. 20\)](#)

Flick/drag operation

The map screen can be moved by touching, dragging or flicking it.

Touch [**Recenter**] to return to the center of the map to the current position.

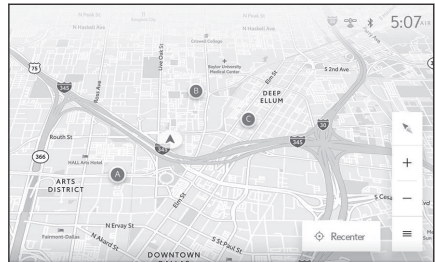

Touch and hold operation

If a desired point on the map screen is touched and held, the full route map screen to the selected point will be displayed.

1 Touch and hold the desired point.

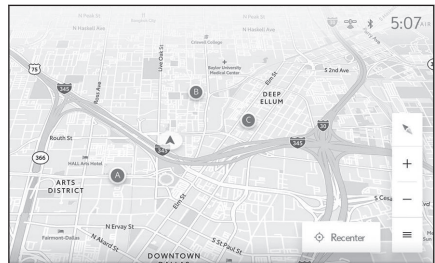

- 2 Full route map screen will be displayed for the selected point.

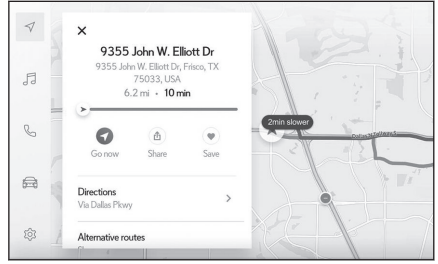

Related Links

[Full route map screen\(P. 145\)](#)

Audio system ON/OFF and volume adjustment

The audio can be turned off when not in use, or the volume can be adjusted to an appropriate level.

The system can be used when the engine switch <power switch> is in ACC or ON.

NOTICE

- Do not use the audio system for extended periods when the engine is not running <hybrid system is not operating>. Doing so may cause the 12-volt battery to run down.
- Listen to the audio at an appropriate volume that will not interfere with safe driving.

■ Operating with the knob

[VOL] knob

Press this to switch between on and off. Turn to adjust the volume.

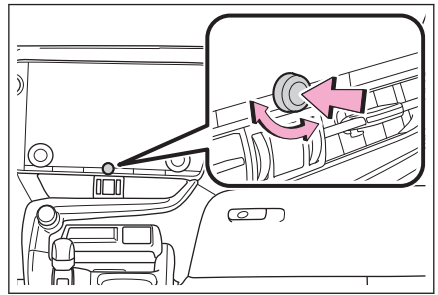

■ Operating with the steering switches

▶ Type A

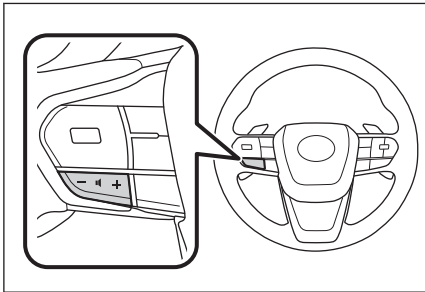

[+] switch

Turns the volume up.

Press and hold to adjust continuously.

[-] switch

Turns the volume down.

Press and hold to adjust continuously.

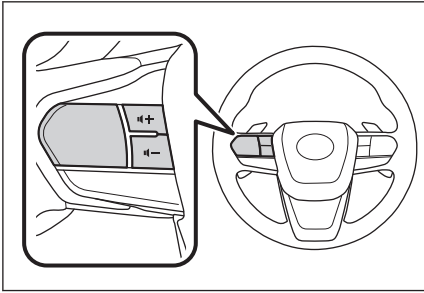
► Type B**Audio power switch**

This switch can be used if set as a favorite steering switch through customization. For the customization procedure, refer to the "OWNER'S MANUAL".

Press this to switch between on and off.

[+] switch

Turns the volume up.

Press and hold to adjust continuously.

[-] switch

Turns the volume down.

Press and hold to adjust continuously.

Changing the audio source

Source can be changed to radio, USB, etc.

- 1 Touch [] from the main menu.
- 2 Touch [Sources].
- 3 Touch the source you wish to select.



INFORMATION

- When no device is connected to the multimedia system, the switch does not appear on the source selection screen. (USB/iPod/Apple CarPlay/Android Auto/Bluetooth® Audio)
- If a cellular phone is used inside the vehicle or nearby while listening to audio, noise may be output from the audio speakers.
- The following functions cannot be used while Apple CarPlay is connected via USB.
 - iPod
 - USB audio
- USB audio cannot be used while Android Auto is connected via USB.

Changing the source with the steering switch

Changing the source with the steering switch is possible.

► Type A

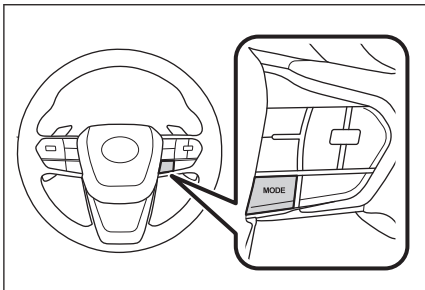

[MODE] switch

The sources will switch in order.

Press and hold to pause or mute. Press and hold again to cancel.

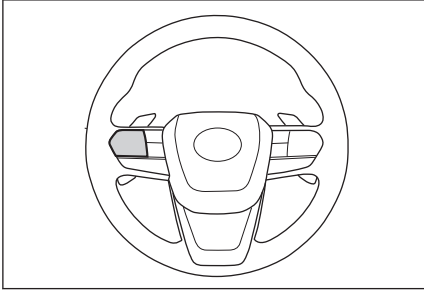
► Type B**Mode switch**

This switch can be used if set as a favorite steering switch through customization. For the customization procedure, refer to the "OWNER'S MANUAL".

The sources will switch in order.

Press and hold to pause or mute. Press and hold again to cancel.

Connecting the USB port

Connect a device such as smartphone or portable player.

● Connect the USB cable to the port.

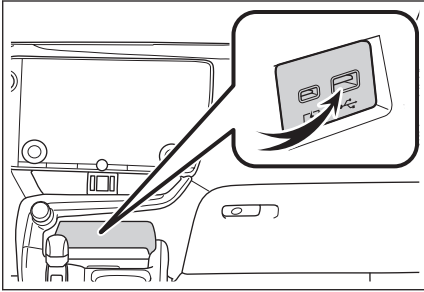

When connecting a USB flash drive, connect it directly to the USB port.

INFORMATION

- Viewing may not be possible, depending on your device.
- Refer to the instruction manual of the USB cable and the device to be connected.
- Use a power source such as the battery supplied with the connected device. Using the accessory socket installed in the vehicle may cause noise output. (Refer to the separate "OWNER'S MANUAL" for details on the accessory socket.)





NOTICE

- Do not push down on or subject the connected device to unnecessary pressure. The device or its terminal may be damaged.
- Keep the port free of foreign matter. The device or its port may be damaged.

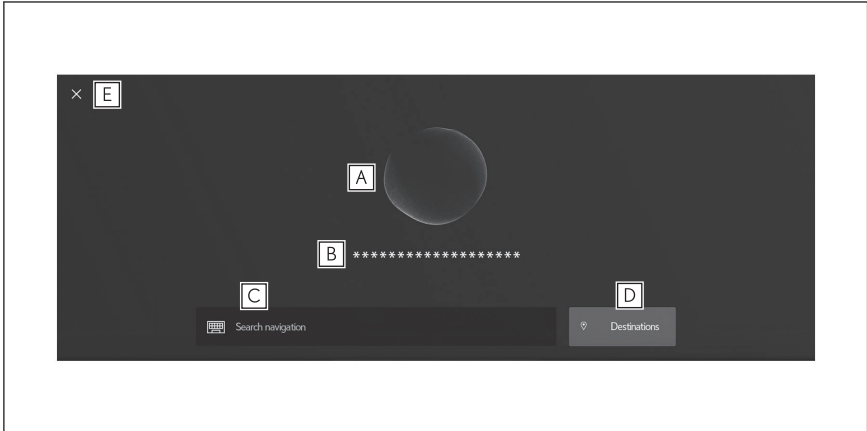
Using the Intelligent Assistant system

Intelligent Assistant is a subscription-based service that allows you to control the multimedia system with voice command and allows you to operate Navigation, Integrated Streaming, Radio, Phone and Climate. Without the subscription, the Assistant will only be able to support voice commands for Radio, Phone and Climate.



- A** Displays the voice recognition status.
-  /  : Waiting for user's voice command
 -  : Listening
 -  : Processing
- B** Displays the response of the Intelligent Assistant system.
- C** Displays the keyboard screen.
- Various items can be searched by using the keyboard.
- D** Sets a destination by selecting a previous destination.
- E** Closes the voice control screen.

INFORMATION

While driving, the voice control screen will appear as a bar at the bottom of the screen.



Related Links

[Using the search function\(P. 44\)](#)

[Searching for a destination by category\(P. 136\)](#)

Intelligent Assistant

The Intelligent Assistant allows the customer with the following enhancements:

- Enhanced Voice Recognition / Natural Language Understanding
Improved voice performance by utilizing both in-vehicle and cloud-based voice recognition.
- Personalized experience
Offers a unique experience catered to the particular user by utilizing learned user data stored in the cloud.
- Up-to-date information
Cloud content is constantly kept up-to-date in the Lexus cloud, so there is no need to visit dealer for a data update.

INFORMATION

You can update Intelligent Assistant cloud subscription by touching the [**Update subscription**] button or using Lexus app.

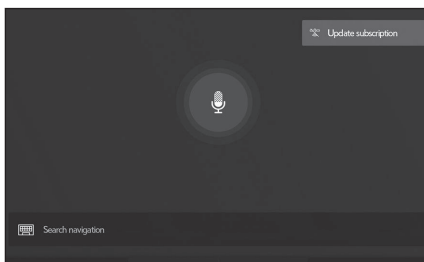

Microphones

Microphones are installed on the driver's side and the passenger's side, respectively.

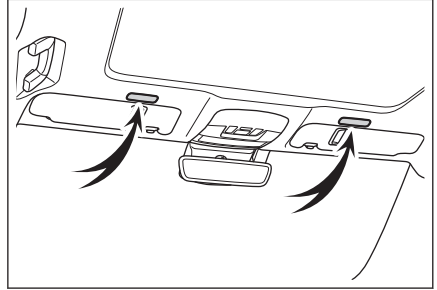

Supported languages

Languages that the Intelligent Assistant recognizes are English, French, and Spanish.

Starting voice control

Voice control can be started by any of the following operations:

■ Press the talk switch

Press [] switch (talk switch) on the steering wheel.

▶ Type A

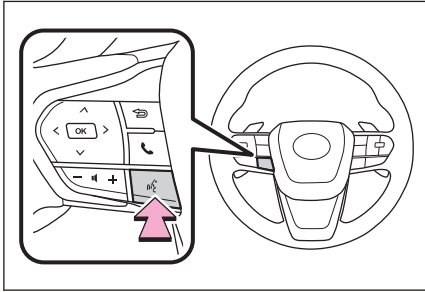

▶ Type B

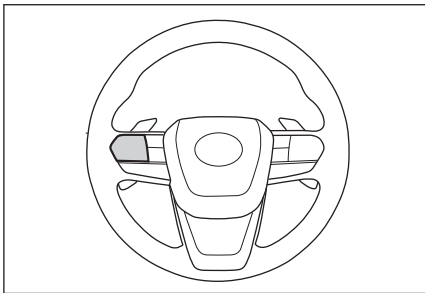

The position of each switch function will vary depending on the state of the vehicle and multimedia system.

■ Say the wake word

Say "Hey Lexus".

- The wake word can be turned on or off.
- The wake word can be used and then immediately issue a voice command.

Example: "Hey Lexus, take me to an Italian restaurant."

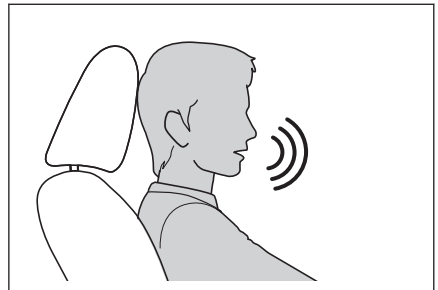

■ Touch the microphone button

Touch  or  on the screen.

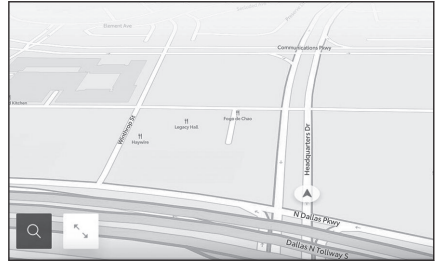

INFORMATION

- Voice operations can be done from the driver seat or passenger seat by activating the Intelligent Assistant system with wake word. On this occasion, voice commands from seats other than the Intelligent Assistant activating seats are not recognized.
- However, some features are not available for voice control from passenger seat.
- If the Intelligent Assistant was activated by the talk switch or microphone button, voice operations from the driver seat can be done.
- The Intelligent Assistant may not recognize commands if they are not said clearly. Take note of the following points when using it:
 - Speak in a clear voice.
 - Close the window as commands may not be recognized properly due to noise (wind noise or external noise).
 - If the air conditioner blows loudly, commands may not be recognized properly, so reduce the air volume.
 - If music is being played loudly while a command is issued, that command may not be recognized, so lower the music volume.
 - Commands may not be recognized if several people speak at once.
- You can interrupt the voice prompt by saying a voice command.
- You can turn voice prompt on or off on the voice control settings screen.
- You can adjust the system voice volume on the sound and media settings screen.

— Related Links —

[Changing the voice control settings\(P. 63\)](#)

[Changing sound and media settings\(P. 76\)](#)

Stopping voice control

Voice commands can end with one of the following operations:

- Say "Cancel".
- Touch  on the voice control screen.
- Press and hold the talk switch on the steering wheel.

Speaking a voice command

When the voice control screen appears, say a voice command. The system can recognize natural speech.

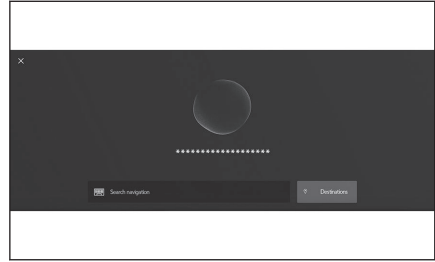

INFORMATION

- Commands may not be recognized if said with an accent or non-standard phrasing.
- If the Intelligent Assistant does not recognize aliases or abbreviations when searching for place names and facilities, say the official name.

Function list

The following tables list frequently used commands for each function category.

- The functions available may vary according to the system installed.
- Items with "Subscription" will require Intelligent Assistant functionality.

Common

Action	Example voice command	Subscription
Shows list of general commands	"Help"	No
Stops the current conversation and re-starts at the beginning	"Start over"	No
Cancels the Intelligent Assistant system	"Cancel"	No

Navigation

Intelligent Assistant system enables navigation voice search. This allows you with variety of features such as searching a point of interest (POI), navigate to an address as well as discovering new POIs.

1-4. Intelligent Assistant

Function	Example voice command	Subscription
Destination search	"Take me to <location category/business name>" "Take me to an Italian restaurant" "Take me to <address>" "Take me to 6565 Headquarters drive Plano TX" "Take me home" "Take me to work"	Yes
Map control	"Map zoom in" "Map zoom out"	Yes
Route information	"Cancel trip"	Yes
Telematics	"Call Destination Assist"	No

■ Multimedia control

Allows you to engage in a dialog with the Intelligent Assistant to complete various multimedia tasks via voice input.

Function	Example voice command	Subscription
Radio	"Tune to 99.5 FM" "Tune to Rock on FM" "Tune to channel 2 on SiriusXM"	No
Media	"Mute audio" "Next" "Previous"	No
Media Streaming	"Play <artist/album/song/genre/playlist>" "Play Frank Sinatra"	Yes

■ Hands-free phone operation

Allows you to engage in a dialog with the Intelligent Assistant to complete various tasks via voice input, such as making a phone call to a contact, or calling destination assist.

Function	Example voice command	Subscription
Phone call	"Call John Smith" "Dial 0123456789" "Call back" "Redial"	No
Message	"Send message to John Smith" "Read message"	No

■ Screen display switching

Allows you to easily change to various function screen by voice.

Function	Example voice command	Subscription
Navigation	"Show map"	Yes
Phone	"Show recent calls"	No
Multimedia	"Show the FM station list"	No
Settings	"Show display settings"	No

■ Vehicle device control

Allows you to easily change a vehicle setting or activate a function by voice.

Function	Example voice command	Subscription
Climate	"Turn on the air conditioner" "Set the temperature to 70 degrees" "Turn the fan speed up"	No

■ Notifications

Offers notifications based on user preferences, vehicle geolocation and learned behavior. Each service can be set to On/Off from the Lexus app.

Function	Detail	Subscription
POI suggestion (Navigation)	Parking suggestions near destination	Yes
Low fuel reminder (Navigation)	Automatically notifies user of low fuel level. If applicable, provides POI list nearby (ahead) or along route and allows user to select and navigate by touch.	Yes

Using the search function

The keyboard can be used to search for contacts, music, locations, and vehicle settings. If using the Intelligent Assistant, a destination that takes advantage of content in the cloud can be searched.

- 1 Touch .
- 2 Touch the desired domain to search.

[Navigation] : Searches by the address, intersection, Points of Interest, phone number, street name, etc.

[Media] : Searches by artist name, song title, album name, station name, genre, etc.

[Phone] : Searches by contact name or phone number.

[Vehicle] : Searches by entering the items you want to set, such as climate, seats, tire pressure.

[Settings] : Searches by entering the items you want to set, such as general, date & time, language & units, notifications.

- 3 Enter the search text and touch **[Go]**.

If multiple conditions need to be specified, search by inserting a space between words.

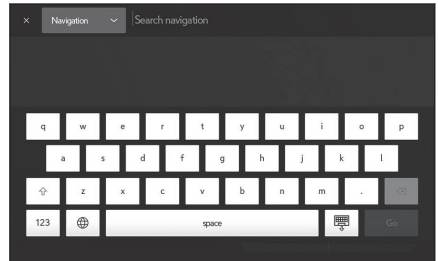

- 4 When the list of search results is displayed, touch the desired item.

INFORMATION

- Operation of the screen is restricted when the vehicle is moving exceeds about 5 mph (8 km/h).
- Keyboard search is not available when Apple CarPlay and Android Auto screens are active.

2-1. Multimedia system initial setup

Registering a user profile **46**

2-2. Various settings

Changing the various settings **51**

2-3. Driver settings

Changing and registering a user profile **53**

Setting up how to identify a driver **55**

2-4. General settings

Changing general multimedia system settings **57**

2-5. Notification settings

Notifications settings **60**

2-6. Screen settings

Changing the screen display settings **61**

2-7. Voice control settings

Changing the voice control settings **63**

2-8. Vehicle settings

Setting dealer information **64**

Changing the security settings **65**

Updating and checking the software information **67**

2-9. Navigation system settings

Displaying the navigation system settings screen **72**

Map details settings screen **73**

Route options **75**

2-10. Sound and media settings

Changing sound and media settings **76**

2-11. Wi-Fi® Settings

Changing Wi-Fi® settings **80**

Setting Wi-Fi® Hotspot **82**

2-12. Bluetooth® Settings

Setting Bluetooth® devices ... **84**

2-13. Apps settings

Apps settings **87**

Registering a user profile*¹

Register a user profile for the main user as the initial setup for the multimedia system.

By registering a user profile, you can save the driving position, multimedia, and various other settings as a profile for each driver. You can drive the vehicle without having to change the settings of other drivers in the case that multiple drivers, such as your friends and family, drive the vehicle.

You can drive the vehicle in guest mode if you do not want to use a user profile.

User profiles

Driving positions, multimedia settings, and other vehicle settings for each driver can be saved and the applicable driver can load them when driving the car.

- Up to three user profiles can be registered.
- The following setting information can be saved in a profile:
 - Some multimedia settings : Volume, navigation system, audio, etc.
 - Some vehicle settings : Driving position, meters, etc.
- Vehicle settings are automatically saved to the current profile when they are changed.
- Search history, individual settings, and other private information can be protected by setting up a profile.
- By registering a device to identify the driver, your profile will be automatically loaded. You can select a smartphone and smart key as the device to be registered.

■ Linking to a Lexus account*²

- An active Lexus account is required to use a profile.
- By using the Lexus app and linking to a Lexus account, a profile can be loaded from the cloud in any vehicle.
- The driver who is registered as the owner can delete all drivers registered in the vehicle. Drivers who are not the vehicle owner cannot delete the owner's profile.
- The same profile cannot be used in another vehicle at the same time.
- Changing the vehicle settings automatically updates the profile saved at the cloud and a screen notifying the driver that the profile has been updated appears.

*1: This function is not available in some countries or areas.

- User profile portability from vehicle to vehicle may not be available in the regions other than the U.S. 48 States.
- Registered profiles are saved in the cloud, so even if a profile is deleted in the vehicle, it is not deleted from the cloud.

Related Links

[Changing the user profile\(P. 49\)](#)

[Setting up how to identify a driver\(P. 55\)](#)

Registering a user profile for the first time

An active Lexus account is required to use a profile.

- 1 After the engine switch <power switch> is turned on, the language selection screen will be displayed. Touch the desired language.

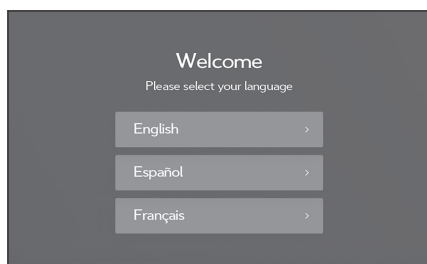

- 2 To use the Lexus app on a smartphone to register a profile, touch [Enter phone number].

If you do not want to register a profile, touch [Cancel]. If you touch [Do not show setup again], the profile registration screen will no longer be displayed.

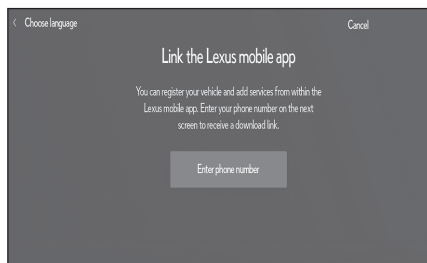

- 3 Enter your phone number and then touch [Send].
Download the Lexus app using the link sent by text to your smartphone.
- 4 Start the Lexus app and follow the instructions to scan the QR code on the screen or enter an authentication code.
- 5 Complete setup to enable the subscription or trial in the Lexus app and touch [I've completed app setup].
 - Once registration is complete, a message is displayed and your profile is saved.
 - If you completed the setup for the subscription or trial in the Lexus app, the map screen will be displayed and you can use the navigation system.

*2: This function is not available in some countries or areas.

2.1. Multimedia system initial setup

- If you do not complete the setup for the subscription or trial in the Lexus app, the subscription screen will be displayed and you cannot use the navigation system.

6 After registering your profile, register your Bluetooth® device in order to identify the driver. To continue with setup, touch [Yes].

You can also register a device at a later time.

INFORMATION

If a user profile was not registered, registration can be restarted on the driver setup screen.

Related Links

[Changing the user profile\(P. 49\)](#)

[Changing and registering a user profile\(P. 53\)](#)

Automatically loading a user profile

Taking a smartphone, smart key, or some other device in the vehicle to identify the driver enables the user profile to be automatically loaded.

- The vehicle detects the device registered in the profile when the engine switch <power switch> is turned to ACC or ON. When a registered device is detected, the profile that the device is assigned to is automatically loaded.
- If the device registered in the profile is not detected, the vehicle is used in guest driver mode.
- Touching [Settings] displays the driver settings screen enabling you to change profiles.
- You can select a smartphone, smart key or some other device as the device to identify the driver.

INFORMATION

- If multiple devices registered in a profile are detected, the driver is identified based on the information of the device detected first. If a highly trusted device is detected after that, the detection result is updated and the profile changed.
- Of the Bluetooth® devices registered to a user profile, only the Bluetooth® device of the most recent driver will be detected.

Related Links

[Changing and registering a user profile\(P. 53\)](#)

[Setting up how to identify a driver\(P. 55\)](#)

Changing the user profile

You can select the profile that you want to use on the user profile list registered on the vehicle.

- 1 Touch [] from the main menu.
- 2 From "Saved profiles", select the user profile name that you want to change to.

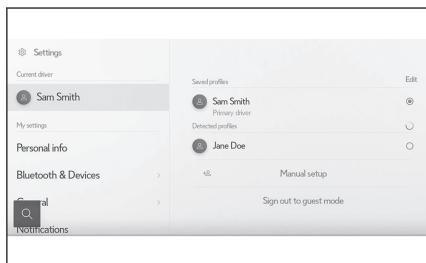

- 3 Enter the PIN code.
 - Enter the PIN code set on the Lexus app when the Lexus account was created.
 - Once the user profile has changed, a message is displayed on the screen.

INFORMATION

If the system detects a device set to another user profile, a pop-up message will appear. Touching [] will enable the user profile to be changed.

Loading detected profile

If the system detects a Lexus app on a smartphone that another driver is using, the detected profile name will appear on the screen. Touch the profile name desired to be used and enter the PIN code to change the profile.

- 1 Touch [] from the main menu.
- 2 From [Detected profiles], select the user profile name that you want to change to.

Touch [Refresh] to update the profile list.



- 3 Enter the PIN code.
 - Enter the PIN code that you set on the Lexus app when the Lexus account was created.

2.1. Multimedia system initial setup

- Once the profile has changed, a message is displayed on the screen.

4 To save the profile in the vehicle, touch [Continue].

- The loaded profile can be saved in the vehicle as a primary driver or a secondary driver.
- If you do not want to save the profile on this vehicle, you can use it temporarily.

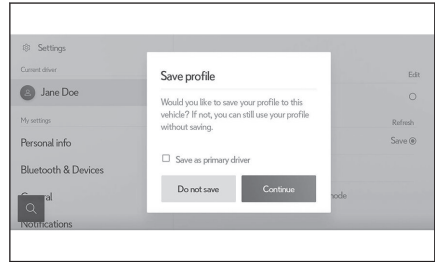



Changing the various settings

The various settings related to the multimedia system can be changed.

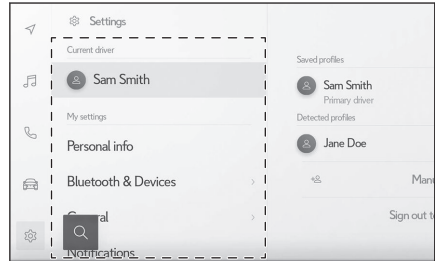
- 1 Touch [] from the main menu.
- 2 Select the desired item.



Setting	Description
"Current driver"	
[](User profile name)	Displays the name of the current user profile. Touching the profile enables you to change or register a user profile. (→ P.53)
[][Guest]	
"My settings"	
[Personal info]	Register a device to identify the driver. (→ P.55)
[Bluetooth & Devices]	Register or edit a Bluetooth® device. (→ P.84)
[General]	Change the time settings, display language, and other general multimedia settings.(→ P.57)
[Notifications]	Change software update and other notification settings.(→ P.60)
[Wi-Fi]	Configure Wi-Fi® settings.(→ P.80)
[Display]	Adjust the screen contrast and brightness, etc.(→ P.61)
[Sound & Media]	Change the system voice settings and radio settings.(→ P.76)
[Navigation]	Change settings related to map display and route guidance.(→ P.72)

2-2. Various settings

Setting	Description
[Vehicle customize] ^{*1}	Settings to door lock, lights, multi-information display and steering switches.
[Driving assist] ^{*1}	Change setting related to driver assist features like Intuitive parking assist, etc.
[Voice & Search]	Change setting for Intelligent Assistant.(→ P.63)
"Vehicle"	
[Dealer info]	Add, edit or delete dealer information.(→ P.64)
[Info & Security]	Change settings related to security and privacy.(→ P.65)
[Software update]	Check and update software information.(→ P.67)
[Apps]	Re-install applications and check information about the applications.(→ P.87)

INFORMATION

For safety purposes, there are functions that cannot be operated while the vehicle is moving.

*1: Refer to the "OWNER'S MANUAL".

Changing and registering a user profile^{*1}

The user profile can be registered or changed. By registering a user profile, driving positions, multimedia settings, and various other individual vehicle settings can be saved as a profile for each driver.

- 1 Touch [⚙️] from the main menu.
- 2 Touch [👤](profile name) or [👤][Guest] on the submenu.
- 3 Select the desired item.

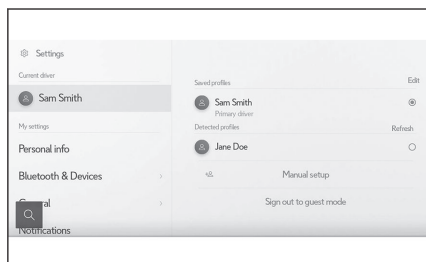

Setting	Description
[Get started]	If the primary user profile has not been registered, profile registration will start.(→ P.47)
[Saved profiles]	The user profiles registered on the vehicle are displayed in a list. Touch the profile that desired to be used and enter the PIN code to change the profile. Touching [Edit] enables you to delete saved profiles. Profile is still stored on Lexus cloud preserving all settings and personalization information. Up to three user profiles can be saved on the vehicle.
[Detected profile]	If the system detects a Lexus app on a smartphone that another driver is using, the detected profile name will appear on the screen. Touch the profile name that desired to be used and enter the PIN code to change the profile. Touch [Refresh] to update the profile list. Manually refreshes the detected profile list, when a Bluetooth® device is not found in the list.
[+👤][Manual setup]	Manually register a new user profile. You can register a user profile by entering your Lexus account ID and password.
[Sign out to guest mode]	Sign out of the current user profile to go to Guest mode. This feature can be used for Valet to protect personal information.

*1: This function is not available in some countries or areas.

 **INFORMATION**

For safety purposes, these settings cannot be operated while the vehicle is moving.

Setting up how to identify a driver

Set a device in order to identify a driver. When the engine switch <power switch> is turned to ACC or ON and a registered device is detected, the profile that the device is assigned to is automatically loaded. You can select a smartphone and smart key as the device to be registered.

- 1 Touch [] from the main menu.
- 2 Touch [Personal info] on the submenu.
- 3 Select the desired item.

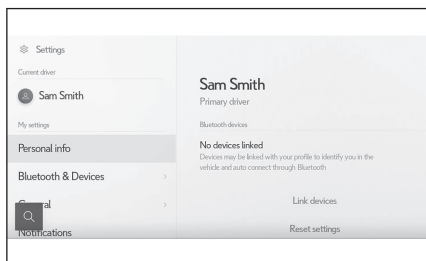

Setting	Description
"Profile Name"	The name of the user profile is displayed.
"Bluetooth devices"	Driver identification is performed using a smartphone or other Bluetooth [®] device and the applicable profile is loaded. Touch [Link devices] to register.(→ P.102)
[Link key] ^{*1*2}	Driver identification is performed using the vehicle's smart key and the applicable profile is loaded.
[Reset settings]	The settings for the selected user profile will be reset.
[Delete driver]	The selected user profile will be removed from the vehicle.

Troubleshooting

If there is a problem with the user profile function, first check the table below.

*1: Refer to the "OWNER'S MANUAL".

*2: Cannot be used with fleet vehicles such as rental cars.

2-3. Driver settings

Problem	Likely cause	Solution
Unable to load saved profile	System is not loading the previously saved profile.	Turn the Bluetooth [®] setting on and ensure the device is paired with the system and set as primary device.
Unable to load saved profile with Bluetooth [®] setting turned on		Ensure Bluetooth [®] setting is turned on and Lexus app is running on device.
Forgot PIN	PIN needs to be reset.	PIN can be reset using the Lexus app.
Unable to add a Bluetooth [®] device to a profile	System does not accept the Bluetooth [®] device thus preventing you to add the device to your profile.	Verify your device is not associated with other driver's profile.
Unable to detect profile	System does not show the profile in the detected list.	Verify your device's Bluetooth [®] setting is on and Lexus app is running on your device.
Unable to generate QR / authorization code	System is not loading your QR code or manual authorization code.	Verify that car is in good network area and DCM connection is active.
Failed to complete registration	QR and manual authorization code are valid for a limited time of few minutes.	Restart registration process by going back previous screen and entering phone number again to get a new QR code / manual authorization code.

Changing general multimedia system settings

The time settings, display language, and other general multimedia system settings can be changed.

- 1 Touch [] from the main menu.
- 2 Touch [General] on the submenu.
- 3 Select the desired item.

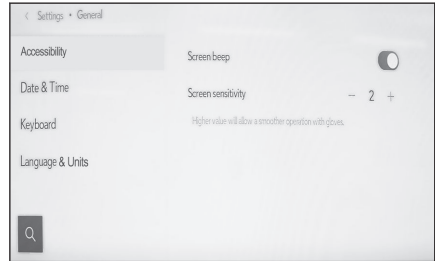

● [Accessibility]

Setting	Description
[Screen beep]	Turn the sound that is made when you touch the screen on or off.
[Screen sensitivity]	Adjust the screen touch sensitivity.

● [Date & Time]

Setting	Description
[Set date & time by GPS] ^{*1}	Use GPS information and map data to automatically set the time. Turning this setting off will enable you to set the time.
"Time"	
[24-hour time]	Change between 24-hour and 12-hour time display.
[Time zone]	When [Set date & time by GPS] is turned off, you can set the time zone.
[Daylight savings]	When [Set date & time by GPS] is turned off, you can set summer time to [Auto] ^{*1} , [On], [Off].
[Set time automatically]	Use GPS information to automatically set the time.

2-4. General settings

Setting	Description
[Set time manually]	When [Set time automatically] is turned off, you can set the time.
"Date"	
[Format]	Change the date display format. (MM/DD/YYYY, DD/MM/YYYY, YYYY/MM/DD, etc.)

● [Keyboard]

Setting	Description
"History"	
[Clear search history]	Delete the keyboard search history.

● [Language & Units]

Setting	Description
[Language]	Change languages. Both the language displayed on the screen and system voice language change.
"Measurements"	
[Set automatically]	Automatically sets the display units for distance, fuel economy, tire pressure, and so on based on the country information.
[Distance] ^{*2}	When [Set automatically] is turned off, you can manually set the distance display unit.
[Fuel/Electricity consumption]	When [Set automatically] is turned off, you can manually set the fuel economy display unit.
[Tire pressure]	When [Set automatically] is turned off, you can manually set the tire pressure display unit.

*1: With navigation function

*2: If equipped

 **INFORMATION**

- Even if you change the language settings, not all the displayed content and voice guidance will change to the selected language. Additionally, some guidance will no longer function after you change the language.
- Set the Apple CarPlay/Android Auto language using the connected device.

Notifications settings^{*1}

Software update and other notifications can be changed.

- 1 Touch [] from the main menu.
- 2 Touch [Notifications] on the submenu.
- 3 Select the desired item.

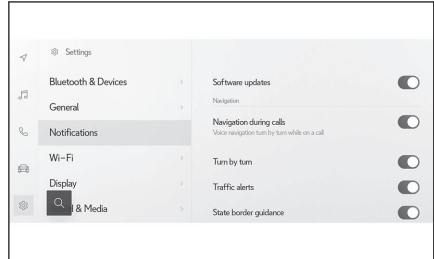

Setting	Description
[Software updates]	Turn the notification for software updates on or off.
[Vehicle suggestions]	Turn the notification for suggestions from the system on or off.
[Intelligent assistant]	Turn the notification from the Intelligent Assistant service on or off.
"Navigation"	
[Navigation during calls]	Turn the navigation system voice guidance on or off during a phone call.
[Turn by turn]	Turn the turn-by-turn voice guidance on or off.
[Traffic alerts]	Turn the traffic information voice guidance on or off.
[State border guidance]	Turn the voice guidance informing you that you have crossed a border on or off.
[Unverified roads]	Turn the guidance for unverified roads on or off.
[HOV/HOT lanes]	Turn the guidance for high-occupancy vehicles lane/high-occupancy toll lane on or off.

*1: This function is not available in some countries or areas.

Changing the screen display settings

The screen contrast and brightness can be adjusted.

- 1 Touch [] from the main menu.
- 2 Touch [Display] on the submenu.
- 3 Select the desired item.

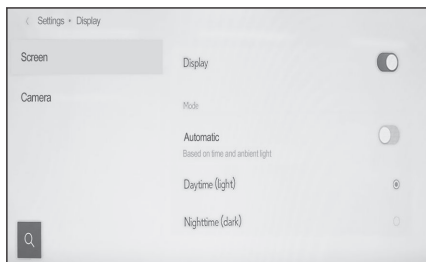

● [Screen]

Setting	Description
[Display]	Set whether to turn the screen display on or off. If the screen is turned off, nothing will be displayed on the screen and only audio will be played. To display the screen again, touch the screen and touch the button in the center of the screen.
"Mode"	
[Automatic] ^{*1}	The screen can automatically be changed between daytime mode and nighttime mode when the headlights illuminate or turn off.
[Daytime (light)]	When [Automatic] is turned off, the screen can be changed to daytime mode manually.
[Nighttime (dark)]	When [Automatic] is turned off, the screen can be changed to nighttime mode manually.
[Brightness]	Adjust the screen brightness.
[Contrast]	Adjust the strength of the screen contrast.

● [Camera]

2-6. Screen settings

Setting	Description
"Camera screen"	
[Brightness]	Adjust the screen brightness.
[Contrast]	Adjust the strength of the screen contrast.

INFORMATION

- Even if the screen is turned off, the GPS will continue to track the vehicle's current location.
- Screen
 - When the screen is off, if the screen is touched, the air conditioning system can be operated.
 - When the air conditioning system buttons or center button is displayed on the screen, if they are not operated for a certain amount of time, the screen will turn off again.
 - If a popup screen is displayed, such as when the talk switch has been pressed, or the "R" shift position has been selected and the rear camera view is displayed, when it is closed, the screen will turn off again.
 - If the screen is touched anywhere other than the center button, the screen will turn off again.

*1: While using the auto headlight feature, the screen may not automatically be changed between daytime mode and nighttime mode when the headlights illuminate or turn off.

Changing the voice control settings

The settings related to the voice recognition feature can be changed.

- 1 Touch [] from the main menu.
- 2 Touch [Voice & Search] on the submenu.
- 3 Select the desired item.

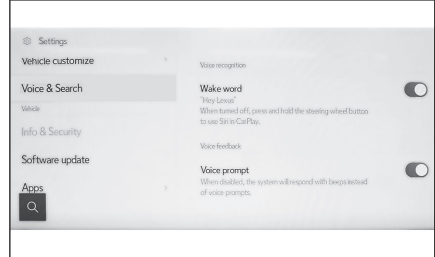

Setting	Description
"Voice recognition"	
[Wake word]	Voice control can be started by speaking the wake word.
"Voice feedback"	
[Voice prompt]	Turn the voice prompts on or off.

2-8. Vehicle settings

Setting dealer information ^{*1*2}

You can register and delete dealer information. Registering the information of the dealer at which you get your vehicle serviced enables you to contact the dealer from the settings screen when you want to reserve a service.

- 1 Touch [] from the main menu.
- 2 Touch [Dealer info] on the submenu.
- 3 Select the desired item.

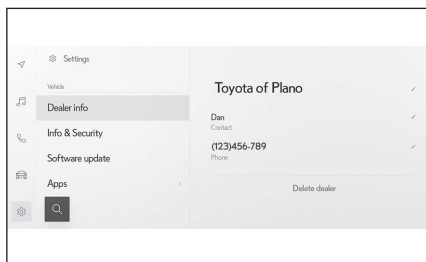

Setting	Description
[Add dealer]	Register the desired dealer.
[Dealer name]	Change the dealer name.
[Contact name]	Register or change the name of the person in charge at the dealer.
[Phone number]	Register or change the dealer phone number.
[Delete dealer]	Delete the dealer information.

*1: Vehicles equipped with DCM

*2: This function is not available in some countries or areas.

Changing the security settings

Settings related to security and privacy can be changed.

- 1 Touch [] from the main menu.
- 2 Touch [Info & Security] on the submenu.
- 3 Select the desired item.

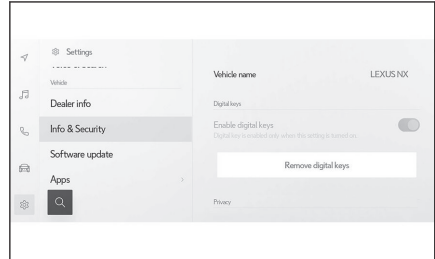

Setting	Description
[Vehicle name]	Displays the system name (vehicle name). This is the device name displayed when searching for a Bluetooth® device from an external device. You can change the name by touching it.
"Digital keys"*1*2	
[Enable digital keys]	Enable the use of digital keys.
[Remove digital keys]	Delete registered digital keys. When deleting the digital key, perform the operation in an area with good DCM reception. If deleting the digital key fails, wait about 1 minute and try again.
"Privacy"	
[Privacy lock]	Enable the password-protected security lock to protect personal information. When set ON, entering the password will be required when the 12-volt battery is replaced or the multimedia system is removed from the vehicle.
[Reset privacy lock password]	Reset the set security lock password.
[System reset]	Reset all of the system's data and restore the settings to the factory defaults.

INFORMATION

- Communication may be cut off after resetting the system. In that case, restart the system.
- After initializing all the information, all the data in the multimedia system will be initialized and returned to the factory default. It cannot be returned to the state before initialization.

Related Links

[Restarting the system\(P.15\)](#)

Setting up the security lock

- 1 Touch [] from the main menu.
- 2 Touch [Info & Security] on the submenu.
- 3 Touch [Privacy lock].
- 4 Touch [OK].
- 5 Set a password that contains between 4 and 15 alphanumeric characters.
- 6 Reenter your password.

A message will appear and the security lock is enabled.

INFORMATION

- After a password is set, if the system is reset after the 12-volt battery is replaced or the multimedia system is removed from the vehicle, a password to operate the multimedia system needs to be entered. Enter the password that you set.
- If the password is entered incorrectly a certain number of times, you will no longer be able to enter a password. If that happens, ask your Lexus dealer to unlock the system or reset it by touching [**System reset**].
- To ensure security, do not repeatedly use the same password or a word that can be found in the dictionary when setting a password.

*1: Refer to the "OWNER'S MANUAL".

*2: This function is not available in some countries or areas.

Updating and checking the software information*1

Software information can be checked or updated. The software is updated for the purpose of improving multimedia system functions and operations for more smoother usability.

- 1 Touch [] from the main menu.
- 2 Touch [Software update] on the submenu.
- 3 Select the desired item.

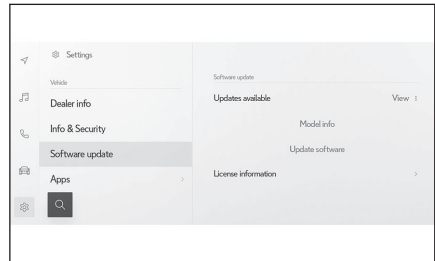

Setting	Description
"Software update"	
[Updates available]	Touch [View] to check software update information. After checking whether there is an update available and the content of the update, the updated data can be downloaded and software update can be installed. If there is no updated data available [No updates available] will be displayed.
[Model info]	Check the current software version etc.
[Update software]	Updating the software. This will not be displayed if there is no update data available.
[Output info to USB memory]	Copy the vehicle information to update the software to the USB flash drive. Download the update data from the user portal site based on the information written to the USB flash drive and update the software for the multimedia system.(→ P.70) This setting will not be displayed if the USB flash drive is not inserted into the USB port.
[History]	Check software update history. This setting will not be displayed if there is no update history.
[License information]	Check the software license information.

Updating the software

Use one of the following methods to update the software:

- Update the software using Data Communication Module (DCM)
- Update the software using Wi-Fi®
- Update the software using a USB flash drive

INFORMATION

- Map data cannot be updated using this service.
- Some operations cannot be performed while the software is updating.
- If there are any questions, contact your Lexus dealer.

NOTICE

- To update the software using a USB flash drive, a USB flash drive that has more than 4 GB of available space and a computer that can connect to the internet are required. Note that communication charges may be high depending on your computer environment.
- Update the software at your own risk.
- The software cannot be restored to the previous version once the software has been updated.
- The update software can only be used on this system. It cannot be used on any other device.
- Depending on the content of the software update, some settings may be reset. If that happens, reconfigure the applicable settings after the software has been updated.
- Although basic functions are possible during the software update, operation may be slow. If possible, do not operate the system.
- After the software is updated, the Toyota Motor Corporation distribution server will be automatically notified that the update has completed. Note that Toyota Motor Corporation does not use the information it receives for any purpose other than software updates. You may also be charged for communication fees depending on your subscription.

Updating the software using DCM*2 or Wi-Fi®*3

This system regularly accesses the distribution server to check for software updates.

*1: This function is not available in some countries or areas.

*2: Vehicles equipped with DCM

1. Touch [] on the software update notification.
2. Follow the on-screen instructions to check and agree to the update content and terms.
 - Downloading of the update data will start. Once the data has been downloaded, installation will begin. (This will take about 10 to 15 minutes)
 - The time required for download and installation may increase depending on the communications environment. If you turn off the engine switch <power switch> while the software is installing, installation will resume the next time the vehicle is started.
 - Once the update is complete, a message is displayed on the screen.
 - If the system needs to be restarted, a message will appear. Touching [**Yes**] restarts the system.
 - To check the software update history, touch [**History**] on the software update history screen.

■ Manually updating the software

1. Touch [] from the main menu.
2. Touch [**Software update**] on the submenu.
3. Touch [**View**] of "Updates available".
4. Follow the on-screen instructions to check and agree to the update content and terms.
 - Downloading of the update data will start. Once the data has been downloaded, installation will begin. (This will take about 10 to 15 minutes)
 - The time required for download and installation may increase depending on the communications environment. If you turn off the engine switch <power switch> while the software is installing, installation will resume the next time the vehicle is started.
 - Once the update is complete, a message is displayed on the screen.
 - If the system needs to be restarted, a message will appear. Touching [**Yes**] restarts the system.
 - To check the software update history, touch [**History**] on the software update history screen.

*3: This function is not available in some countries or areas.

INFORMATION

- If critical update data is available on the distribution server, a message will be displayed. Touch [OK] to download the update data.
- The following conditions must be met to use Wi-Fi® to update the software:
 - The system must be connected to a Wi-Fi® access point (e.g. home, work, etc.)
 - The vehicle must be in a location where it can access Wi-Fi®
 - The communications settings must be set to [Wi-Fi]
- A USB update process may be used if a Data Communication Module (DCM) or Wi-Fi® update is not possible.

Updating the software using a USB flash drive*4

■ Copying the update data to a USB flash drive

1. Touch [] from the main menu.
2. Touch [Software update] on the submenu.
3. Insert the USB flash drive into the USB port on the vehicle.
4. Touch [Output info to USB memory].

The vehicle information to update the software is copied to the USB flash drive.
5. Touch [OK] to remove the USB flash drive.
6. Insert the USB flash drive with the copied vehicle information into the USB port on a computer.
7. On the computer, go to the user portal site (<https://www.lexus.com/firmware-updates>) and download the update data onto the computer.
 - The update data will be downloaded based on the vehicle information written on the USB flash drive.
 - If you cannot find any update data, this means that there is currently no update data available for the applicable system. Update data is released as necessary.
8. Copy the update data that was downloaded to the computer onto the USB flash drive.

Save the update data in the root directory on the USB flash drive. If the update data is saved in folder that was created, the update software cannot be loaded.

*4: This function is not available in some countries or areas.

- Once the updated data has finished copying, remove the USB flash drive.

INFORMATION

The vehicle information written to the USB flash drive is also required when updating the software on this system, so do not delete the vehicle information on the USB flash drive until the update has completed.

■ Updating the software

- Touch [] from the main menu.
- Touch [**Software update**] on the submenu.
- Insert the USB flash drive with the copied update data into the USB port on the vehicle.
- Touch [**Update software**].
- Follow the on-screen instructions to check and agree to the update content and terms.
 - The update data is copied and installation begins. (This will take about 10 to 15 minutes)
 - Once installation is complete, a message is displayed stating that the update has finished.
 - System needs to be restarted, a message will appear. Touching [**Yes**] restarts the system.
- Remove the USB flash drive.
 - To check the software update history, touch [**History**] on the software update history screen.
 - If the software update was done offline, an update completion report data will be created on the USB flash drive. It is necessary to upload the update completion report data to the portal site.

NOTICE

Do not remove the USB flash drive while the software is updating.

— Related Links —

[Connecting the USB port\(P. 34\)](#)

Displaying the navigation system settings screen

Through the navigation system settings, various settings can be changed.

- 1 Touch [] from the main menu.
- 2 Touch [Navigation].
- 3 Touch the desired item.

Setting	Description
[Map details]	Touch to display the map details settings screen
[Route options]	Touch to display the route options

Related Links

[Map details settings screen\(P. 73\)](#)

[Route options\(P. 75\)](#)

Map details settings screen

- 1 Touch [] from the main menu.
- 2 Touch [Navigation].
- 3 Touch [Map details].
- 4 Touch the desired item.

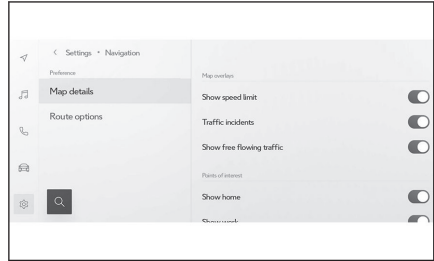



Setting	Content
[Map overlays]	
[Show speed limit]	Touch to turn the speed limit information on/off.
[Traffic incidents]	Touch to turn the display of the traffic incident display on/off.
[Show free flowing traffic]	Touch to turn the display of an arrow for free flowing traffic on/off.
[Points of interest]	
[Show home]	Touch to turn the icon of the home display on/off.*1
[Show work]	Touch to turn the icon of the work display on/off.*1
[Show favorites]	Touch to turn the icon of the favorites display on/off.
[Show nearby parking]	Touch to turn the icon of the nearby parking display on/off.
[Calibrate map]	Touch to adjust the position of the current position mark manually.

*1: Home and Work must be added via Lexus app.

Calibrating position/direction

When driving, the current position mark will be automatically corrected by GPS signals. If GPS reception is poor at the current location, the current position mark can be adjusted manually.

- 1 Touch [] from the main menu.
- 2 Touch [Navigation].
- 3 Touch [Map details].
- 4 Touch [Calibrate map].
- 5 Scroll the map to the desired point.
- 6 Touch or hold [] to change the heading.
- 7 Touch [Save].

[Reset]: Touch to return the current position mark to its previous position.

Route options

- 1 Touch [] from the main menu.
- 2 Touch [Navigation].
- 3 Touch [Route options].
- 4 Touch the desired item.

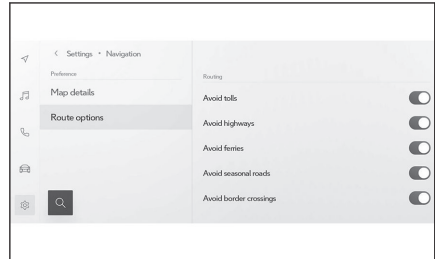

Settings	Content
[Avoid tolls]	Touch to avoid toll roads.
[Avoid highways]	Touch to avoid expressways.
[Avoid ferries]	Touch to avoid ferries.
[Avoid seasonal roads]	Touch to avoid seasonally restricted road segments.
[Avoid border crossings]	Touch to avoid border crossings.
[Predictive Efficient Drive]	Touch to turn predictive efficient drive on/off.
[Default]	Touch to reset all items to their default setting.

Related Links

[Predictive efficient drive\(P.134\)](#)

Changing sound and media settings

- 1 Touch [] from the main menu.
- 2 Touch [Sound & Media] on the submenu.
- 3 Touch the desired item.

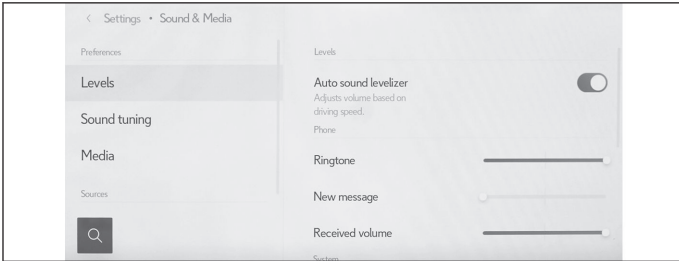

● [Levels] > [Levels]

Setting	Content
[Auto sound levelizer]	Automatically adjusts audio volume according to the vehicle speed.

● [Levels] > [Phone]

Setting	Content
[Ringtone]	Adjusts the ringtone volume.
[New message]	Adjusts the volume when a message is received.
[Received volume]	Adjusts the receiver volume.

● [Levels] > [System]

Setting	Content
[System voice]	Adjust the system volume.
[Driving assist]	Adjust the driving assist volume.

● [Levels] > [Speakers]

Setting	Content
[Surround sound]	Set to an immersive sound quality.

● [Sound tuning] > [Equalizer]

Setting	Content
[Treble]	Adjusts the level of the treble.
[Mid]	Adjusts the level of the midrange.

Setting	Content
[Bass]	Adjusts the level of the bass.
[Balance & Fade]	Adjust the fader and balance by moving []. Touch [Recenter] to return to the center.

● [Media] > [General]

Setting	Content
[Default source]* ¹	Preferred source for Integrated Streaming search by Intelligent Assistant.
[Display cover art]	Displays cover art such as for music albums.

● [Radio] > [Radio]

Setting	Content
[Display FM info]	Displays RDS (Radio Data System) text.
[HD Radio FM]	Receives HD radio in all frequency bands of FM radio.
[HD Radio AM]	Receives HD radio in all frequency bands of AM radio.
[Clear radio station history]	Clears the AM and FM reception history.

● [Radio] > [Gracenote database]

Setting	Content
[Enhance metadata/artwork]	Uses the Gracenote [®] radio recognition technology. <ul style="list-style-type: none"> • Displays the logos of the favorites and the station list. • Changes the category names of the station list. • Automatically updates the station list.

● [SiriusXM] > [Account information]*¹

Setting	Content
[Active] or [No Subscription]	Displays the current contract status. If the service cannot be used, contact the Customer Center as to what is shown on the screen.

● [SiriusXM] > [Preferences]*¹

2-10. Sound and media settings

Setting	Content
[Notifications]	Display notifications from SiriusXM® Satellite Radio.
[Block explicit]	Blocks harmful designated channels.
[Tune start]	Plays from the beginning of the track when a music channel is selected.
[Clear listening history]	Clears the SiriusXM Radio reception history.

● [Sports]^{*1}

Setting	Content
[Sports]	Notifications for the start of games involving sports teams registered as favorites.
NFL	Touch [Edit] to register your favorite NFL team.
MLB	Touch [Edit] to register your favorite MLB team.
NBA	Touch [Edit] to register your favorite NBA team.
NHL	Touch [Edit] to register your favorite NHL team.
College football	Touch [Edit] to register your favorite College football team.
College basketball	Touch [Edit] to register your favorite College basketball team.

● [Music]^{*1}

Setting	Content
[Artists & Songs]	Notification when an artist or song registered as a favorite is played on SiriusXM Radio.
[Edit]	Deletes the artist or song.
[Delete all]	Deletes all the artists or songs registered as favorites.

● [Help and support]^{*1}

Setting	Content
[Contact]	Displays the number of SiriusXM Radio Customer Care. Touch the number to call directly.
[Radio ID]	The Radio ID information required when calling SiriusXM Radio Customer Care is displayed.
[Version]	Version information is displayed.

 **INFORMATION**

Turning the [ VOL] knob during system voice guidance adjusts the volume of the voice guidance.

*1: This function is not available in some countries or areas.

Changing Wi-Fi® settings

Changes Wi-Fi® settings.

- 1 Touch [⚙️] from the main menu.
- 2 Touch submenu [Wi-Fi] > [Wi-Fi] in this order.
- 3 Set each item.

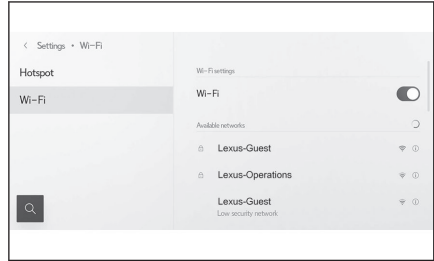

● "Wi-Fi settings"

Setting	Content
[Wi-Fi]	Enables or disables the Wi-Fi® function.

- A message may be displayed depending on the multimedia system settings. Perform the operation according to the guidance on the screen.
- Turning on [Wi-Fi] will display nearby networks that are available.
- Turning off [Wi-Fi] will disconnect the Wi-Fi® connection.

● "Available networks" ("Available networks" will display while [Wi-Fi] is on.)

Setting	Content
Name of network to connect to (Network SSID)	Connects to the network touched.
Name of network display (Network SSID) [ⓘ]	Displays the network information display.

- Network name may display as duplicate when more than one MAC address shares the same network.
- A maximum of 30 networks can be displayed. The list is automatically updated every six seconds.
- If there are devices using the same network name (SSID), it cannot identify which device to use. If using multiple devices, use different network names (Network SSIDs) for each device.

● Network information display (Displays when [ⓘ] for the network name is touched.)

Setting	Content
[Auto connect]*1	Turns on or off the setting to automatically connect when searching for networks.
"Network SSID"	Displays the network name (SSID).
"MAC address"	Displays the MAC address of the network.
"Security"	Displays the security protocol of the network.
"Frequency band"	Displays the network frequency.
[Forget this network]*1	Deletes the connection history of the selected network from the multimedia system. The deleted network will be recognized as a network which has never been connected to the system before.

- [Forget this network] does not disconnect the current Wi-Fi® network connection. The network information will not be remembered and not reconnect to this Wi-Fi® network when restarting Wi-Fi®.



INFORMATION

- The network connection history retains up to 20 items, deleting the oldest when a new one is saved.
- Insecure networks are not registered in the network connection history.

*1: Only networks with a connection history to the multimedia system are displayed.

Setting Wi-Fi® Hotspot

The access point settings can be changed via the Wi-Fi® Hotspot function.

Use of this function requires a Wi-Fi® Hotspot subscription that is provided by Wi-Fi® service provider.

Contact your Lexus dealer for details.

This function is not available in some countries or areas.

INFORMATION

- Cannot be used if the Wi-Fi® function is on.
- A total of ten Wi-Fi® devices (five using 2.4 GHz and five using 5 GHz) can be connected. Recommend connecting up to five devices at a time for optimum performance. If connected to Apple CarPlay or Android Auto over wireless, the limit will be five devices using 2.4 GHz.

- 1 Touch [] from the main menu.
- 2 Touch submenu [Wi-Fi] > [Hotspot] in this order.
- 3 Set each item.

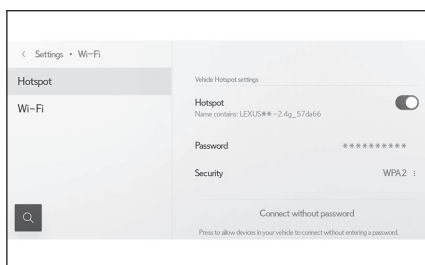

- "Vehicle Hotspot settings"

Setting	Content
[Hotspot]	Enables or disables the Wi-Fi® Hotspot function.
[Password]* ¹	Changes the access point password.
[Security]* ¹	Changes the security protocol for the access point.
[Connect without password]* ¹	<p>Accepts connections to the access point with the simple setup.</p> <ul style="list-style-type: none"> • No selections can be made when the maximum number of devices are already connected. • This cannot be selected if the acceptance time is exceeded. • This is only for WPS supported devices.

- A message may be displayed depending on the multimedia system settings. Follow the instructions on the screen.

INFORMATION

- When changing the setting, the Wi-Fi® Hotspot function will need to be restarted. All devices connected via Wi-Fi® will be disconnected.
- The following guidelines are recommended when setting a password, to prevent a third party from gaining unauthorized access.
 - Use at least 13 characters
 - Use a mixture of letters and numbers
 - Change it regularly
 - If the password is written down, do not store it out in the open
 - Do not reuse the same password, or use a similar password
 - Do not use the vehicle name or license plate number, or a common word found in the dictionary or the like
 - Do not substitute letters for common dictionary words in a way that would be easy to guess (for example, using "c@t" instead of "cat")

Related Links

[Precautions when using Bluetooth® devices\(P. 90\)](#)

[Establishing a connection to Wi-Fi® Hotspot\(P.109\)](#)

[Functional overview\(P. 220\)](#)

*1: This will only display when [Hotspot] is turned on.

Setting Bluetooth® devices

How to use the multimedia system and the connected Bluetooth® device can be set.

INFORMATION

- Settings details are set separately for each individual Bluetooth® device.
- Audio may skip if hands-free calling is selected while playing Bluetooth® audio.
- Depending on the Bluetooth® device model, it may be necessary to perform operations on the Bluetooth® device.
- A Bluetooth® device cannot be selected during an emergency call.
- Settings cannot be selected while driving.
- Settings may not be selectable depending on the status of the Bluetooth® device.

- 1 Touch [⚙️] from the main menu.
- 2 Touch [Bluetooth & Devices].
- 3 Touch the Bluetooth® device to configure from the submenu.

Nothing will display unless at least one Bluetooth® device is registered.

- 4 Set each item.

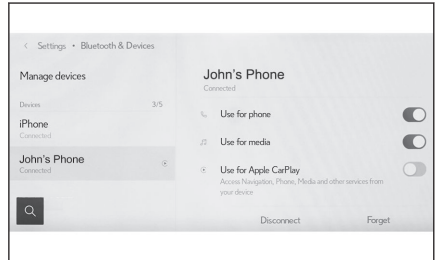

Setting	Description
[Use for phone]	Enables or disables the hands-free call function.*1
[Use for media]	Enables or disables the audio function.*1
[Use for Apple CarPlay]	Enables or disables the Apple CarPlay function.*1
[Use for Android Auto]	Enables or disables the Android Auto function.*1

- "General"

Setting	Description
[Sort contacts by]	The display of names registered in your contacts can be changed as follows. <ul style="list-style-type: none"> • Sort contacts by the first name. • Sort contacts by the last name.
[Do not disturb]	The following settings are available for hands-free calling for incoming calls.*2 <ul style="list-style-type: none"> • Set to [Off] to enable notification by ringtone and display. • Set to [Silent] to disable notification by ringtone. • Set to [On] to decline incoming calls and disable notification by audio and display.
[Auto read messages]	Enables or disables the automated message read out function.
[Clear call history]	Deletes hands-free call history data.*3

● "Syncing"

Setting	Description
[Sync contacts]	Enables or disables automatic transfer of contacts, favorites, and history to the multimedia system. When the setting is changed from disabled to enabled, the phone book of the connected phone will be transferred automatically. Favorites may not be transferred depending on the connected cell phone even if it is supported.
[Set as secondary device]	Sets the device as a secondary device.*4
[Remove secondary device setting]	Remove the device as a secondary device.
[Connect]	Connects the multimedia system to a Bluetooth® device.
[Disconnect]	Disconnects a Bluetooth® device from the multimedia system.
[Forget]	Allows registered Bluetooth® devices to be deleted.

— Related Links —

- Precautions when using Bluetooth® devices(P. 90)
- Bluetooth® specifications and compatible profiles(P. 93)
- Precautions for hands-free calling(P. 186)
- Precautions for Bluetooth® audio playback(P. 177)
- Precautions when using Apple CarPlay and Android Auto(P. 112)
- Setting a Bluetooth® device as a primary device(P. 102)
- Setting a Bluetooth® device as a secondary device(P. 103)
- Registering a user profile(P. 46)
- Changing and registering a user profile(P. 53)

- *1: Displayed only when the Bluetooth® device can execute this function. Toggling the function on or off will display or hide related functions, or turn them on or off. This cannot be used for calls or audio while Apple CarPlay or Android Auto is set to on. The same also applies in reverse. Connection does not start immediately just by switching. To start connection, touch the [**Connect**] button.
- *2: It cannot be used for the phone function of Apple CarPlay and Android Auto. While Android Auto is connected, it cannot be used for the hands-free function of multimedia.
- *3: Displayed when a cellular phone with [**Sync contacts**] turned off is connected.
- *4: This can be set while the driver is identified and the HFP-supported Bluetooth® device has not been set as the primary device. Once set as a secondary device, the device will be recognized as such. The priority of the vehicle's Bluetooth® connection will be in the sequence of main device, secondary device, and the most recently connected device.

Apps settings

Your navigation and multimedia system now have Apps that integrated in the system. These apps come pre-installed to provide a seamless experience without the need to connect your mobile device.

- 1 Touch [] from the main menu.
- 2 Touch [Apps].
- 3 Touch the desired item.



Setting	Description
[Reinstall All Apps]	Under some circumstances it is possible that the App may not be able to communicate and may require its memory to be cleaned out. The [Reinstall All Apps] will enable you to do this.
[Remote Connect]	For vehicles that are Remote capable, you may use the Remote feature from your mobile device to lock, unlock and many more features. When a mobile device requests a remote activation to a vehicle, you may select this feature and complete the authorization process.

3-1. Using the Bluetooth® function

- Precautions when using Bluetooth® devices..... **90**
- Bluetooth® specifications and compatible profiles **93**
- Registering a Bluetooth® device from the multimedia system **94**
- Deleting a registered Bluetooth® device **97**
- Connecting with a Bluetooth® device **98**
- Setting a Bluetooth® device as a primary device..... **102**
- Setting a Bluetooth® device as a secondary device..... **103**

3-2. Connecting to a Wi-Fi® network

- Precautions when using Wi-Fi® devices..... **104**
- Connecting to a network using Wi-Fi® **106**
- Establishing a connection to Wi-Fi® Hotspot..... **109**

3-3. Using Apple CarPlay and Android Auto

- Precautions when using Apple CarPlay and Android Auto **112**
- Using Apple CarPlay with an unregistered smartphone..... **115**

- Using Apple CarPlay with a registered smartphone **118**
- Using Android Auto with an unregistered smartphone... **121**
- Using Android Auto with a registered smartphone **124**
- When Apple CarPlay or Android Auto might be malfunctioning..... **127**

Precautions when using Bluetooth® devices

Pay special attention to the following information when using a Bluetooth® device on the multimedia system.

INFORMATION

- Bluetooth® is a best-effort function that performs wireless communication with the 2.4 GHz band frequency.
- Simultaneous use of Wi-Fi® using the same 2.4 GHz band wireless communication as Bluetooth® could cause mutual interference.
- Mutual interference between Bluetooth® and Wi-Fi® could cause issues such as garbled video, audio skipping, or reduced communication speed.
- The effect of interference will be reduced if a Bluetooth® device is connected. If a Bluetooth® device has been registered, connecting with the registered device could improve this issue. (The connection of a Bluetooth® device can be checked with by the status icon on the multimedia system screen.)
- Using a Bluetooth® cellular phone simultaneously with a wireless device could negatively affect communication for each.
- The simultaneous use of a Wi-Fi® function (Wi-Fi®, Wi-Fi® Hotspot) and Bluetooth® device that use the same 2.4 GHz band for wireless communication could negatively affect communication for each. Turning off the Wi-Fi® function will allow for use without issue.
- When a Bluetooth® device is connected via Bluetooth®, its battery will be consumed more quickly than normal.
- Bluetooth® connections will be disconnected during emergency calls. Any disconnected Bluetooth® devices will be reconnected once the emergency call is finished.

WARNING

- For safety, the driver should not operate the cellular phone itself while driving when using hands-free calling.
- Stop the vehicle in a safe location prior to calling. If a call is received while driving, be sure to drive safely and keep the call short.

NOTICE

- Do not use a Bluetooth® device near the multimedia system. Coming too close could worsen sound quality or the connection.

⚠ NOTICE

- Do not leave a cellular phone inside the vehicle. The inside of the vehicle can become hot, which could cause the cellular phone to malfunction.

■ Users with pacemakers or other electrical medical devices

Observe the following precautions with regard to radio waves during Bluetooth® communication.

⚠ WARNING

- The vehicle antenna for Bluetooth® communication is built into the multimedia system.
- People with implantable cardiac pacemakers, cardiac resynchronization therapy-pacemakers or implantable cardioverter defibrillators should maintain a reasonable distance between themselves and the Bluetooth® antennas. The radio waves may affect the operation of such devices.
- Before using Bluetooth® devices, users of any electrical medical device other than implantable cardiac pacemakers, cardiac resynchronization therapy-pacemakers or implantable cardioverter defibrillators should consult the manufacturer of the device for information about its operation under the influence of radio waves. Radio waves could have unexpected effects on the operation of such medical devices.

■ When used simultaneously with Bluetooth® audio

- The following behaviors will occur if a Bluetooth®-compatible device (cellular phone) is used hands-free and simultaneously with Bluetooth® audio.
 - The Bluetooth® connection of the cellular phone may be disconnected.
 - Noise may be introduced into audio on hands-free calling.
 - Hands-free call operation may lag.
- Audio may skip if the communication device selected for hands-free calling is changed during Bluetooth® audio playback.
- The portable device connection may be disconnected when transferring contact data. It will be reconnected once transfer is complete. (Reconnection may not be possible for some models)
- It may not be possible to make both a hands-free connection and audio connection, even for cellular phones that support both hands-free connections and audio connections.

3.1. Using the Bluetooth® function

- For a list of specific devices which operation has been confirmed on this system, check with your Lexus dealer or the following website: <https://lexusconnected-technologysupport.com/>

Related Links

[Precautions when using Wi-Fi® devices\(P.104\)](#)

[Precautions for Bluetooth® audio playback\(P.177\)](#)

[Precautions for hands-free calling\(P.186\)](#)

[Status icons\(P.18\)](#)

Bluetooth® specifications and compatible profiles

The multimedia system supports the following specifications and compatible profiles. Operation is not guaranteed for all Bluetooth® devices.

■ Supported Bluetooth® specifications

Bluetooth® Core Specification Ver. 2.1 or later

■ Compatible profiles

- HFP (Hands Free Profile) supported versions: Ver. 1.5 or later

This is a profile to allow hands-free phone calls using a cellular phone. It has outgoing and incoming call functions.

- PBAP (Phone Book Access Profile) supported versions: Ver. 1.0 or later

Profile for synchronizing data such as contact data and call history

- MAP (Message Access Profile) supported versions: Ver. 1.2 or later

This is a profile to use phone message functions.

- SPP (Serial Port Profile) supported versions: Ver. 1.1 or later

- Profile for converting Bluetooth®-equipped devices as virtual serial ports
- Profile for linking smartphones

- A2DP (Advanced Audio Distribution Profile) supported versions: Ver. 1.0 or later

This is a profile to transmit stereo audio or high quality sound to the audio system.

- AVRCP (Audio/Video Remote Control Profile) supported versions: Ver. 1.0 or later

Profile for controlling audio remotely

3.1. Using the Bluetooth® function

Registering a Bluetooth® device from the multimedia system

A cellular phone or portable device must be registered in order to use hands-free calling or Bluetooth® audio. Once registration is complete, Bluetooth® will automatically be connected each time the multimedia system is started.

When Apple CarPlay/Android Auto is connected via USB, the device will be registered automatically.

When no Bluetooth® devices are connected, the registration screen can be displayed by pressing and holding the  steering wheel switch.

INFORMATION

- A cellular phone can be registered as both a hands-free phone and Bluetooth® audio device.
- Although up to five Bluetooth® devices can be registered, up to two devices can be used as hands-free phones. (In order to connect two hands-free phones, driver identification is required.)
- Refer to the Bluetooth® device's instruction manual for information on how to operate the Bluetooth® device.
- Registration will need to be repeated once for each Bluetooth® device if multiple Bluetooth® devices will be used.
- A PIN code is a Verification code used when registering a Bluetooth® device to the multimedia system.
- Dialing may be locked out after connecting, depending on the cellular phone settings. Cancel the auto lock function on the cellular phone before use.
- If another device is registered while connected to a cellular phone or portable device, the connection to the portable device or cellular phone playing audio will be disconnected.
- For safety reasons, devices cannot be registered while driving.
- If the registration of the Bluetooth® device does not work, restart the Bluetooth® device.

- 1 Touch  from the main menu.
- 2 Touch [Bluetooth & Devices].
- 3 Touch [Manage devices].

4 Touch [Search for devices].

If the device is already registered, touch [Add another device] > [Search for devices] in order.

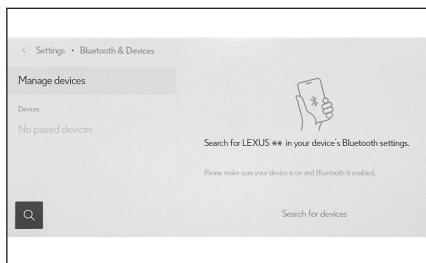

5 Touch the device to register from the main area.

- The Bluetooth® address may be displayed instead of the device name.
- Certain models of Bluetooth® devices may not be displayed in the device list, unless a certain screen is displayed on the Bluetooth® device. Refer to the Bluetooth® device's instruction manual for details.

6 Check that the displayed PIN code matches the PIN code displayed on the Bluetooth® device, and then touch [OK].

- Some Bluetooth® devices may need to be operated to complete registration.
- You may be prompted to install the Lexus Application on your phone. Please follow the displayed instruction.
- Primary device settings may be displayed. Perform the operation according to the screen guidance.
- The Apple CarPlay or Android Auto settings may be displayed. The Apple CarPlay or Android Auto screen will be displayed if the use of either is enabled.
- A message indicating that connection is complete is displayed, and the name of the registered Bluetooth® device is displayed in the submenu.
- If an operation failed screen is displayed, follow the operation instructions on the screen.

Related Links

[Registering a user profile\(P. 46\)](#)

[Changing and registering a user profile\(P. 53\)](#)

[Precautions when using Apple CarPlay and Android Auto\(P. 112\)](#)

Registering from a Bluetooth® device

If the Bluetooth® device cannot be found by searching with the multimedia system, register by searching for the multimedia system from the Bluetooth® device.

- 1 Touch [⚙️] from the main menu.
- 2 Touch [Bluetooth & Devices].

3.1. Using the Bluetooth® function

3 Touch [Manage devices].

If another device is already registered, touch [Add another device].

4 Register the multimedia system from the Bluetooth® device to be used.

- Perform the operation according to the operating procedure of the Bluetooth® device.
- Be sure to display this Bluetooth® connection screen before performing registration on the Bluetooth® device.

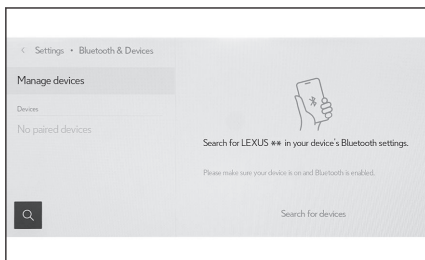

5 Check that the displayed PIN code matches the PIN code displayed on the Bluetooth® device, and then touch [OK].

- Some Bluetooth® devices may need to be operated to complete registration.
- Registration guidance for the user profile may be displayed. Perform the operation according to the screen guidance.
- Primary device settings may be displayed. Perform the operation according to the screen guidance.
- A message indicating that connection is complete is displayed, and the name of the registered Bluetooth® device is displayed in the submenu.
- If an operation failed screen is displayed, follow the operation instructions on the screen.

Related Links

[Registering a user profile\(P. 46\)](#)

[Changing and registering a user profile\(P. 53\)](#)

Deleting a registered Bluetooth® device

Registered Bluetooth® devices can be deleted.

- 1 Touch [⚙️] from the main menu.
- 2 Touch [Bluetooth & Devices].
- 3 Touch the Bluetooth® device to be deleted from the submenu.
- 4 Touch [Forget].

A device that has been set as the primary device of another user cannot be deleted.

- 5 Touch [Forget].

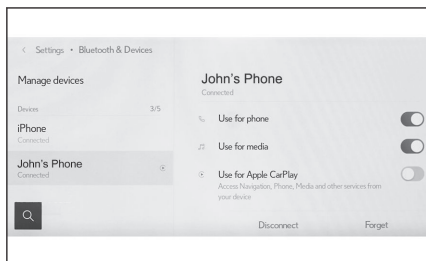

INFORMATION

- A registered cellular phone cannot be deleted during an emergency call.
- It may not be possible to delete on the first try, depending on the status of the Bluetooth® device.

Related Links

[Setting a Bluetooth® device as a primary device\(P. 102\)](#)

[Registering a user profile\(P. 46\)](#)

[Changing and registering a user profile\(P. 53\)](#)

Connecting with a Bluetooth® device

Connection with a Bluetooth® device is required to use various function of the multimedia system. There are two connection methods, automatic and manual.

INFORMATION

- Refer to the Bluetooth® device's instruction manual for information on how to operate the Bluetooth® device.
- If behavior is unstable when connecting a cellular phone, disconnect the call and try connecting again.
- A connection cannot be made if Bluetooth® on the Bluetooth® device is not turned on.
- When connection of the Bluetooth® device is completed, a message indicating so will be displayed at the top of the screen.
- While the Bluetooth® device is connected, the Bluetooth® connection status icon is displayed.
- The display area may illuminate and stay on while the engine switch <power switch> is turned on, depending on the model of cellular phone. If this occurs, turn illumination off on the cellular phone. (For information on setting, refer to the cellular phone instruction manual)
- The Bluetooth® function cannot be used on the device connected as Apple CarPlay.
- The Bluetooth® function except the hands-free function cannot be used on the device connected as Android Auto.

■ Bluetooth® reconnection

If a Bluetooth® connection that was once established is disconnected while the engine switch <power switch> is turned on, a reconnection will be automatically attempted.

■ Number of Bluetooth® device connections

- When the driver is identified
Up to two hands-free phones and one audio device will be connected automatically. (The hands-free phone and audio device can also be set as the same device.)
- When the driver is not identified
Up to one hands-free phone and one audio device will be connected automatically. (The hands-free phone and audio device can also be set as the same device.)

INFORMATION

- Try connecting manually if reconnection fails.
- If Apple CarPlay is connected, you may not be able to reconnect the Bluetooth® connection.

Related Links

[Status icons\(P. 18\)](#)

[Registering a user profile\(P. 46\)](#)

[Changing and registering a user profile\(P. 53\)](#)

[Manually connecting Bluetooth® devices\(P. 100\)](#)

Automatically connecting Bluetooth® devices

The multimedia system will automatically connect to Bluetooth® devices in the set priority order each time the engine switch <power switch> is turned from off to on.

- When the driver is identified

Automatically connects in order of the primary device, secondary device, and then devices in order of most recent connection.

Up to two hands-free phones and one audio device will be connected automatically. (The hands-free phone and audio device can also be set as the same device.)

- When the driver is not identified

Automatically connects in order of most recent connection.

Up to one hands-free phone and one audio device will be connected automatically. (The hands-free phone and audio device can also be set as the same device.)

Try connecting manually if reconnection fails.

INFORMATION

The Bluetooth® device may need to be operated, depending on the model of Bluetooth® device.

Related Links

[Setting a Bluetooth® device as a primary device\(P. 102\)](#)

[Setting a Bluetooth® device as a secondary device\(P. 103\)](#)

[Registering a user profile\(P. 46\)](#)

3.1. Using the Bluetooth® function

Changing and registering a user profile(P. 53)

Manually connecting Bluetooth® devices

In order to connect another Bluetooth® device, or if automatic connection fails, it is possible to connect to registered Bluetooth® devices.

- 1 Touch [⚙️] from the main menu.
- 2 Touch [Bluetooth & Devices] on the submenu.

The device search screen will display on the multimedia system if no Bluetooth® devices are registered. Register the Bluetooth® device.

- 3 Touch the Bluetooth® device to connect to on the submenu.

If the Bluetooth® device to connect to is not listed in the submenu, register the Bluetooth® device.

- 4 Touch [Connect] from the main area.

A confirmation screen may be displayed if another device is already connected.

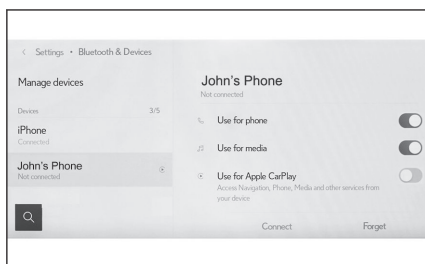

INFORMATION

It may not be possible to connect on the first try, depending on the status of the Bluetooth® device. If this occurs, try connecting again after a while.

Related Links

Registering a Bluetooth® device from the multimedia system(P. 94)

Disconnecting Bluetooth® devices

Connected Bluetooth® devices can be disconnected from the multimedia system.

- 1 Touch [⚙️] from the main menu.
- 2 Touch [Bluetooth & Devices] on the submenu.
- 3 Touch the Bluetooth® device to be disconnected on the submenu.

- 4 Touch [Disconnect] from the main area.



3.1. Using the Bluetooth® function

Setting a Bluetooth® device as a primary device

Setting a Bluetooth® device as the primary device makes it the first to be connected during automatic connection.

- The cellular phone that you want to set is necessary to be connected to multimedia system.
- The driver must be specified in order to set the primary device.

INFORMATION

A cellular phone set as the primary device of another user cannot be set as the primary device.

- 1 Touch [] from the main menu.
- 2 Touch [Personal info].
- 3 Touch [Link devices] from the main area.

The device search screen will be displayed if there is no hands-free phone that can be set as the primary device. Search for the cellular phone to set and newly register it to the multimedia system. A device can be set as the primary device when a new registration is made.

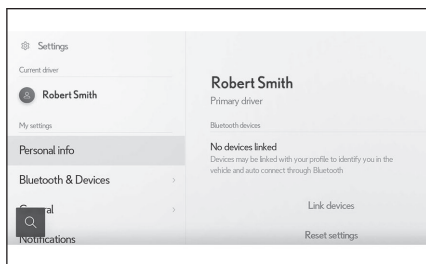

- 4 Select the cellular phone to be set as the primary device.

Disconnect the currently connected Bluetooth® device, then connect the primary device and secondary device.

Related Links

[Automatically connecting Bluetooth® devices\(P. 99\)](#)

[Setting Bluetooth® devices\(P. 84\)](#)

[Registering a user profile\(P. 46\)](#)

[Changing and registering a user profile\(P. 53\)](#)

[Registering a Bluetooth® device from the multimedia system\(P. 94\)](#)

Setting a Bluetooth® device as a secondary device

Setting a Bluetooth® device as a secondary device will set it as a secondary device when connected.

- This can be set while the driver is identified and the Bluetooth® device to be set has not been set as the primary device.
- A Bluetooth® device that supports HFP must be connected to the multimedia system.

- 1 Touch [] from the main menu.
- 2 Touch [Bluetooth & Devices] on the submenu.

The device search screen will display if no Bluetooth® devices are registered. Register a cellular phone.

- 3 Touch the cellular phone to be set as a secondary device.

If the cellular phone to be set is not listed, register the cellular phone.

- 4 Touch [Set as secondary device] from the main area.

This will change to a cancel switch if the device is already set as a secondary device.

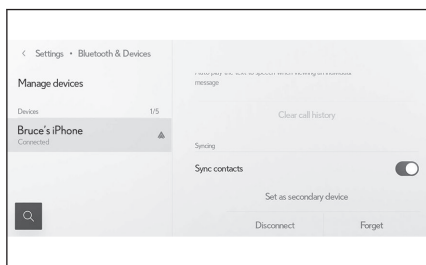

Related Links

[Automatically connecting Bluetooth® devices\(P. 99\)](#)

[Setting Bluetooth® devices\(P. 84\)](#)

[Registering a user profile\(P. 46\)](#)

[Changing and registering a user profile\(P. 53\)](#)

Precautions when using Wi-Fi® devices

Pay special attention to the following information when connecting to a Wi-Fi® network or using a Wi-Fi® service from a smartphone that supports tethering.

■ Users with pacemakers or other electrical medical devices

Observe the following precautions with regard to radio waves during Wi-Fi® communication.

⚠ WARNING

- Use Wi-Fi® devices only when safe and legal to do so.
- The vehicle antenna for Wi-Fi® communication is built into the multimedia system.
- People with implantable cardiac pacemakers, cardiac resynchronization therapy-pacemakers or implantable cardioverter defibrillators should maintain a reasonable distance between themselves and the Wi-Fi® antennas.

The radio waves may affect the operation of such devices.

- Before using Wi-Fi® devices, users of any electrical medical device other than implantable cardiac pacemakers, cardiac resynchronization therapy-pacemakers or implantable cardioverter defibrillators should consult the manufacturer of the device for information about its operation under the influence of radio waves.

Radio waves could have unexpected effects on the operation of such medical devices.

■ Using Wi-Fi® and Bluetooth® simultaneously

Wi-Fi® is a best-effort function that performs wireless communication with the 2.4 GHz or 5 GHz band frequency. Simultaneous use of Bluetooth® using the same 2.4 GHz band wireless communication as Wi-Fi® (2.4 GHz) could cause mutual interference.

■ Things to know about Wi-Fi®

□ INFORMATION

- Wi-Fi®, Miracast®, Wi-Fi Direct® and WMM® are registered trademarks of Wi-Fi Alliance®.
- Wi-Fi Protected Setup™, Wi-Fi CERTIFIED™, WPA™, WPA2™ and WPA3™ are trademarks of Wi-Fi Alliance®.
- This is a best-effort function.
- Use this function when connecting to a portable device. Connections to devices other than portable devices may be disconnected, depending on the environment.

- Leaving the Wi-Fi® area will disconnect communication.
- Leaving the DCM area will disconnect Wi-Fi® Hotspot function communication.
- If a connected device is taken out of the Wi-Fi® connection area, the connection will be severed.
- If the vehicle is driven out of the cellular communication coverage area, connecting to the internet via the Wi-Fi® Hotspot will not be possible.
- If a Bluetooth® device is used while a device is connected using the Wi-Fi® Hotspot function, the communication speed may decrease.
- Depending on the Wi-Fi® Hotspot environment, communication may be slow or impossible.
- If the vehicle is near a radio antenna, radio station or other source of strong radio waves and electrical noise, communication may be slow or impossible.
- The communication speed may drop or it even may become impossible to use this service in certain usage environments. (due to factors such as the wireless antenna location and any wireless devices being used nearby)

Compatible Wi-Fi® communication protocols

IEEE 802.11b/g/n (2.4GHz)

IEEE 802.11a/n/ac (5GHz)

Compatible security protocols

- WEP
- WPA™
- WPA2™
- WPA3™

Related Links

[Precautions when using Bluetooth® devices\(P. 90\)](#)

[Status icons\(P. 18\)](#)

[Changing Wi-Fi® settings\(P. 80\)](#)

[Setting Wi-Fi® Hotspot\(P. 82\)](#)

[Functional overview\(P. 220\)](#)

3-2. Connecting to a Wi-Fi® network

Connecting to a network using Wi-Fi®

The multimedia system can be connected to the Internet by connecting to a Wi-Fi® network.

This function is not available in some countries or areas.

INFORMATION

- The reception level is displayed at the top of the screen.
- It cannot be used if the Wi-Fi® Hotspot is on. Also, it cannot be used if Apple CarPlay or Android Auto is used with a wireless connection.
- Some smartphone models may require establishing a connection each time.
- If networks are detected while the Wi-Fi® function is on, automatic connection will prioritize connecting to the network with the most recent connection.

Related Links

[Changing Wi-Fi® settings\(P. 80\)](#)

Connecting to Wi-Fi® using a smartphone

Refer to the following operation example to establish a Wi-Fi® connection using a smartphone that supports Wi-Fi® tethering. For details on setting up tethering, refer to documents such as the instruction manual for the smartphone. Some smartphone models may require establishing a connection each time.

- 1 Touch [] from the main menu.
- 2 Touch submenu [Wi-Fi] > [Wi-Fi] in this order.
- 3 Set [Wi-Fi] in the main area to on.

- A message may be displayed depending on the multimedia system settings. Perform the operation according to the screen guidance.
- Turning on [Wi-Fi] will display nearby networks that are available.

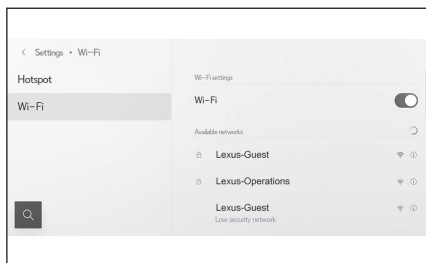

- 4 Select the name of the network that matches the name being broadcasted by the smartphone.
 - Network name may display as duplicate when more than one MAC address shares the same network.

- A maximum of 30 networks can be displayed. The list is automatically updated every six seconds.
- If there are devices using the same network name (SSID), it cannot identify which device to use. Use different network names (SSIDs) if using multiple devices.
- No selections can be made while driving.

5 Enter the corresponding password for this network.

- If no password is set, the connection will be made after selecting the network.
- If networks are detected with the automatic connection setting on, they will be connected to automatically.

INFORMATION

The network connection history retains up to 20 items, deleting the oldest when a new one is saved.

Establishing a Wi-Fi® connection to an available network

Connect to the Internet from a nearby network using Wi-Fi®.

Confirm the password of the network to be used in advance.

- 1 Touch [
 - A message may be displayed depending on the multimedia system settings. Perform the operation according to the screen guidance.
 - Turning on [Wi-Fi] will display nearby networks that are available.

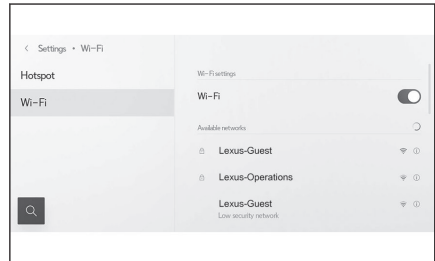

4 Touch the network to be connected to from [Available networks] in the main area.

- Network name may display as duplicate when more than one MAC address shares the same network.
- A maximum of 30 networks can be displayed. The list is automatically updated every six seconds.
- If there are devices using the same network name (SSID), it cannot identify which device to use. Use different network names (SSIDs) if using multiple devices.
- No selections can be made while driving.
- Touch [

3-2. Connecting to a Wi-Fi® network

5 Enter the corresponding password for this network.

- If no password is set, the connection will be made after selecting the network.
- If networks are detected with the automatic connection setting on, they will be connected to automatically.

INFORMATION

The network connection history retains up to 20 items, deleting the oldest when a new one is saved.

Disconnecting Wi-Fi®

Wi-Fi® can be disconnected by turning off the Wi-Fi® function.

- 1 Touch [] from the main menu.
- 2 Touch submenu [Wi-Fi] > [Wi-Fi] in this order.
- 3 Set [Wi-Fi] in the main area to off.

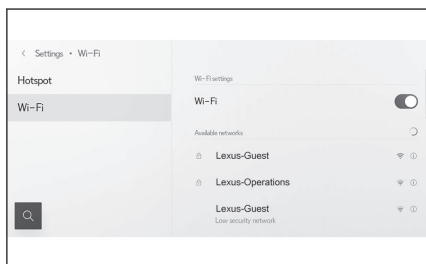

Establishing a connection to Wi-Fi® Hotspot

The Wi-Fi® Hotspot function can be used to set the Wi-Fi® access point and connect to a Wi-Fi® device.

This function is not available in some countries or areas.

Use of this function requires a Wi-Fi® Hotspot subscription that is provided by Wi-Fi® service provider.

Contact your Lexus dealer for details.

INFORMATION

- Cannot be used if the Wi-Fi® function is on.
- A total of ten Wi-Fi® devices (five using 2.4 GHz and five using 5 GHz) can be connected. If connected to Apple CarPlay or Android Auto over wireless, the limit will be five devices using 2.4 GHz.

- 1 Turn on the Wi-Fi® function of the Wi-Fi® device.
- 2 Touch [] from the main menu.
- 3 Touch submenu [Wi-Fi] > [Hotspot] in this order.
- 4 Turn on [Hotspot] in the main area.

A message may be displayed depending on the multimedia system settings. Perform the operation according to the screen guidance.

- 5 Connect to Wi-Fi® Hotspot of the multimedia system from the Wi-Fi® device.

- Refer to the Wi-Fi® device's instruction manual on how to connect using the Wi-Fi® device.
- The network name will be displayed under the Hotspot in the main area.
- The network password will be displayed in the main area.

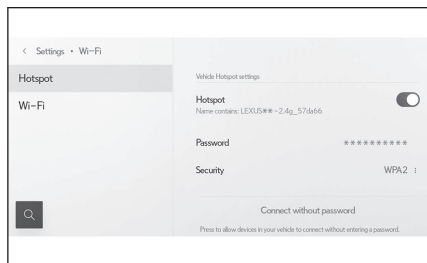

Related Links

[Setting Wi-Fi® Hotspot\(P. 82\)](#)

[Functional overview\(P. 220\)](#)

Connecting to Wi-Fi® Hotspot using easy setup

If the Wi-Fi® device is compatible with Wi-Fi Protected Setup™*1, connecting a device is even easier.

- 1 Touch [⚙️] from the main menu.
- 2 Touch submenu [Wi-Fi] > [Hotspot] in this order.

- 3 Turn on [Hotspot] in the main area.

A message may be displayed depending on the multimedia system settings. Perform the operation according to the screen guidance.

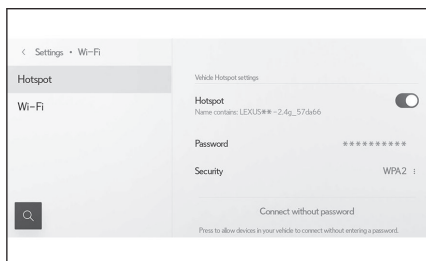

- 4 Touch [Connect without password] from the main area.

The multimedia system will begin accepting connections with easy setup.

- No selections can be made while driving.
 - This is only for WPS supported devices.
 - This cannot be selected when the maximum number of devices are already connected.
- 5 Operate the Wi-Fi® device to establish a connection.
 - Refer to the Wi-Fi® device's instruction manual for information on how to connect using the Wi-Fi® device's easy setup.
 - A connection failed message will be displayed if the acceptance time is exceeded.

Disconnecting Wi-Fi® Hotspot

Wi-Fi® Hotspot can be disconnected by turning off the Wi-Fi® Hotspot function.

- 1 Touch [⚙️] from the main menu.

*1: Wi-Fi Protected Setup™ is a trademark of Wi-Fi Alliance®.

- 2 Touch submenu [Wi-Fi] > [Hotspot] in this order.
- 3 Set [Hotspot] in the main area to off.

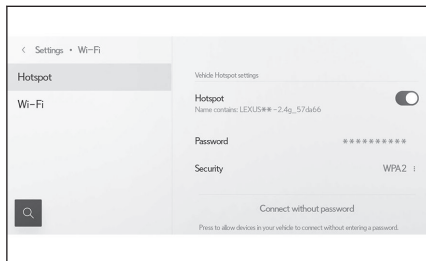

Precautions when using Apple CarPlay and Android Auto

Apple CarPlay and Android Auto allow for some applications (such as map, phone, and music applications) to be used by the multimedia system. While connected to Apple CarPlay or Android Auto, supported applications will display. Pay special attention to the following information when using Apple CarPlay or Android Auto.

To use Android Auto in your car, install the Android Auto app from Google's Play Store.

■ Compatible devices

- Apple iPhone devices that supports Apple CarPlay.

For details, refer to <https://www.apple.com/ios/carplay/>.^{*1}

- Android devices that supports Android Auto.

For details, refer to <https://www.android.com/auto/>.^{*1}

⚠ WARNING

For safety reasons, drivers should not operate the smartphone itself while driving.

⚠ NOTICE

- Do not leave the smartphone inside the vehicle. The inside of the vehicle can become hot, which could cause the smartphone to malfunction.
- Do not push down on or subject the smartphone to unnecessary pressure while it is connected. The smartphone or port may be damaged.
- Keep the USB port free of foreign matter. The smartphone or port may be damaged.

📄 INFORMATION

- For USB connections, use a data USB cable provided by the phone manufacturer.
- Some system button functions will change while connected to Apple CarPlay or Android Auto.
- The following functions will be replaced by similar Apple CarPlay or Android Auto functions or will be disabled for devices connected to Apple CarPlay or Android Auto.
 - Bluetooth[®] phone (Apple CarPlay only)
 - Bluetooth[®] audio

*1: Operation is not guaranteed.

- The guidance volume can be changed on the voice settings screen. It can also be changed using the [ VOL] knob.
- While Apple CarPlay or Android Auto of a device is connected, Apple CarPlay or Android Auto of a different device cannot be used.
- Apple CarPlay and Android Auto are applications developed by Apple and Google, respectively. The functions and services provided by connected devices may be removed or changed without prior notice, as changes are made to the operating system, hardware and software, or Apple CarPlay or Android Auto specifications.
- For applications that support Apple CarPlay or Android Auto, refer to the respective website.
- While using Apple CarPlay or Android Auto, vehicle and user information such as the location and vehicle speed will be shared with the application publisher and cellular phone service provider.
- Downloading and using an application signifies your consent with its terms of use.
- Data is sent over the Internet and may result in charges being incurred. For information on data rates, contact the cellular phone service provider
- Some functions including music playback may be restricted, depending on the application.
- Each function is an application provided by its respective company, and may be changed or suspended without prior notice. For details, refer to the website for the respective function.
- If the vehicle's navigation system is being used during route guidance and a new route is set using the Apple CarPlay or Android Auto map app, route guidance using the vehicle's navigation system will stop. If the Apple CarPlay or Android Auto map app is being used during route guidance and a new route is set using the vehicle's navigation system, route guidance using the Apple CarPlay or Android Auto map app will stop.
- Devices connected via Apple CarPlay cannot use Bluetooth® functions.
- Devices connected via Android Auto cannot use Bluetooth® functions other than hands-free calling.
- In case of USB connection, if the USB cable is unplugged, Apple CarPlay or Android Auto will stop operating. Audio output will stop and the screen will switch to the multimedia system screen.

Related Links

[Changing sound and media settings\(P. 76\)](#)

[Audio system ON/OFF and volume adjustment\(P. 30\)](#)

[Precautions for playback of iPod/iPhone\(P. 166\)](#)

[Precautions for playback of Apple CarPlay\(P. 170\)](#)

3-3. Using Apple CarPlay and Android Auto

Precautions for playback of Android Auto(P. 174)

Precautions when using Bluetooth® devices(P. 90)

Precautions when using Wi-Fi® devices(P. 104)

Precautions for Bluetooth® audio playback(P. 177)

Using Apple CarPlay with an unregistered smartphone

Apple CarPlay can be used by connecting an unregistered smartphone to the multimedia system. The procedure is different for registered smartphones.

This function is not available in some countries or areas.

Related Links

[Using Apple CarPlay with a registered smartphone\(P. 118\)](#)

Using Apple CarPlay with a USB connection

Apple CarPlay can be used by connecting a smartphone to the multimedia system using a data USB cable.

- 1 **Enable Siri from your smartphone's settings menu.**
- 2 **Connect the smartphone to the USB port.**

The Apple CarPlay home screen is displayed.

- It may take around three to six seconds to return to the original screen, depending on the smartphone being connected.
- If guidance is displayed on the smartphone screen, follow those operation instructions.

- 3 **Operate Apple CarPlay.**

iPhone applications that support Apple CarPlay can be used by touching the application.



Displays the multimedia system screen.

To display the Apple CarPlay home screen again, touch [] from the main menu.



Switch the screen display.

Touching and holding this will start Siri.

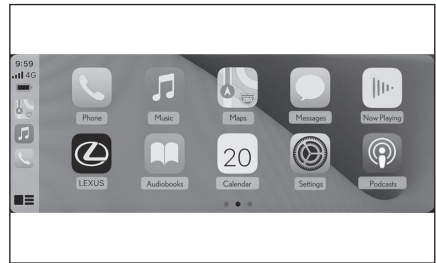

INFORMATION

- While Apple CarPlay is connected, press and hold the talk switch to start Siri. To cancel Siri, perform a short press of the talk switch.

- While **[Wake word]** is set to on and Apple CarPlay is connected, speaking the Siri wake word will start Siri.
The wake word function of Siri can only be used when the language is set to English. Also, the connected device must have iOS version 14.3 or later.
- If wireless connection is set to be used on the smartphone when registered via USB connection, wireless connection will be enabled from the next time onwards.

Related Links

[Connecting the USB port\(P. 34\)](#)

[Starting voice control\(P. 38\)](#)

[Changing the voice control settings\(P. 63\)](#)

Using Apple CarPlay with wireless connection

Apple CarPlay can be connected to the multimedia system wirelessly using vehicle's wireless connection capability.

- 1 **Enable Siri from your smartphone's settings menu.**
- 2 **Touch [] from the main menu.**
- 3 **Touch [Bluetooth & Devices].**
 - The device search screen will be displayed if there is no smartphone registered to the multimedia system. Proceed to Procedure 6.
- 4 **Touch [Manage devices].**
- 5 **Touch [Add another device].**
- 6 **Touch [Search for devices].**
- 7 **Select the smartphone to register.**
- 8 **Check that the displayed PIN code matches the PIN code displayed on the smartphone, and then touch [OK].**
 - Perform the operation according to the guidance on the screen.
- 9 **If Apple CarPlay settings are displayed, touch [Yes].**

The Apple CarPlay home screen is displayed.

 - It may take around three to six seconds to return to the original screen, depending on the smartphone being connected.
 - If an operation failed screen is displayed, follow the operation instructions on the screen.
 - If guidance is displayed on the smartphone screen, follow those operation instructions.

10 Operate Apple CarPlay.

iPhone applications that support Apple CarPlay can be used by touching the application.



Displays the multimedia system screen.

To display the Apple CarPlay home screen again, touch [] from the main menu.



Switch the screen display.

Touching and holding this will start Siri.



INFORMATION

- While Apple CarPlay is connected, press and hold the talk switch to start Siri. To cancel Siri, perform a short press of the talk switch.
- While [Wake word] is set to on and Apple CarPlay is connected, speaking the Siri wake word will start Siri.

The wake word function of Siri can only be used when the language is set to English. Also, the connected device must have iOS version 14.3 or later.

Related Links

[Starting voice control\(P. 38\)](#)

[Changing the voice control settings\(P. 63\)](#)

Using Apple CarPlay with a registered smartphone

Apple CarPlay can be used by connecting a registered smartphone to the multimedia system. The procedure is different for unregistered smartphones.

This function is not available in some countries or areas.

Related Links

[Using Apple CarPlay with an unregistered smartphone\(P. 115\)](#)

Using Apple CarPlay with a USB connection

Apple CarPlay can be used by connecting a smartphone to the multimedia system using a data USB cable.

- 1 Enable Siri from your smartphone's settings menu.
- 2 Connect the smartphone to the USB port.

The Apple CarPlay home screen is displayed.

- It may take around three to six seconds to return to the original screen, depending on the smartphone being connected.
- If an operation failed screen is displayed, follow the operation instructions on the screen.
- If guidance is displayed on the smartphone screen, follow those operation instructions.
- If the Apple CarPlay home screen is not displayed, operate as follows:
 - On the main menu, touch [⚙️] > [Bluetooth & Devices] > [Manage devices], then [Switch] of Apple CarPlay in order, and select the smartphone to use.
 - Touch [🎮] from the main menu.

- 3 Operate Apple CarPlay.

iPhone applications that support Apple CarPlay can be used by touching the application.



Displays the multimedia system screen.

To display the Apple CarPlay home screen again, touch [🎮] from the main menu.



Switch the screen display.



Touching and holding this will start Siri.

INFORMATION

- While Apple CarPlay is connected, press and hold the talk switch to start Siri. To cancel Siri, perform a short press of the talk switch.
- While **[Wake word]** is set to on and Apple CarPlay is connected, speaking the Siri wake word will start Siri.
The wake word function of Siri can only be used when the language is set to English. Also, the connected device must have iOS version 14.3 or later.

— Related Links —

[Connecting the USB port\(P. 34\)](#)

[Starting voice control\(P. 38\)](#)

[Changing the voice control settings\(P. 63\)](#)

Using Apple CarPlay with wireless connection

Apple CarPlay can be connected to the multimedia system wirelessly using vehicle's wireless connection capability.

- 1 **Enable Siri from the settings menu on the smartphone.**
- 2 **Touch  from the main menu.**
- 3 **Touch [Bluetooth & Devices].**
- 4 **Touch [Manage devices].**
- 5 **Touch [Switch] for Apple CarPlay.**
- 6 **Select the smartphone to be used with Apple CarPlay.**

The Apple CarPlay home screen is displayed.

- It may take around three to six seconds to return to the original screen, depending on the smartphone being connected.
- If an operation failed screen is displayed, follow the operation instructions on the screen.
- If guidance is displayed on the smartphone screen, follow those operation instructions.

7 Operate Apple CarPlay.

iPhone applications that support Apple CarPlay can be used by touching the application.



Displays the multimedia system screen.

To display the Apple CarPlay home screen again, touch [] from the main menu.



Switch the screen display.

Touching and holding this will start Siri.



INFORMATION

- While Apple CarPlay is connected, press and hold the talk switch to start Siri. To cancel Siri, perform a short press of the talk switch.
- While [**Wake word**] is set to on and Apple CarPlay is connected, speaking the Siri wake word will start Siri.

The wake word function of Siri can only be used when the language is set to English. Also, the connected device must have iOS version 14.3 or later.

Related Links

[Starting voice control\(P.38\)](#)

[Changing the voice control settings\(P.63\)](#)

Using Android Auto with an unregistered smartphone

Android Auto can be used by connecting an unregistered smartphone to the multimedia system. The procedure is different for registered smartphones.

This function is not available in some countries or areas.

Related Links

[Using Android Auto with a registered smartphone\(P. 124\)](#)

Using Android Auto with a USB connection

Android Auto can be used by connecting a smartphone to the multimedia system using a data USB cable.

- 1 **Confirm that the Android Auto application is installed on the smartphone to connect.**
- 2 **Connect the smartphone to the USB port.**

The Android Auto home screen is displayed.

- It may take around three to six seconds to return to the original screen, depending on the smartphone being connected.
- If guidance is displayed on the smartphone screen, follow those operation instructions.

- 3 **Operate Android Auto.**

Applications that support Android Auto can be used by touching the application.



Displays the multimedia system screen.

To display the Android Auto home screen again, touch [▲] from the main menu.



Start Google Assistant.

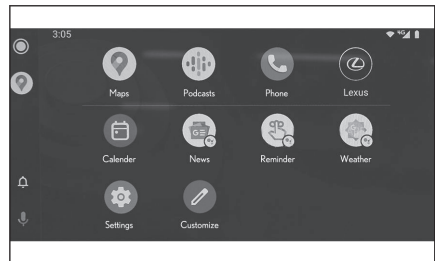

INFORMATION

While Android Auto is connected, press and hold the talk switch to start Google Assistant. To cancel Google Assistant, perform a short press of the talk switch.

Related Links

[Connecting the USB port\(P. 34\)](#)

[Starting voice control\(P. 38\)](#)

Using Android Auto with wireless connection

Android Auto can be connected to the multimedia system wirelessly using vehicle's wireless connection capability.

1 **Confirm that the Android Auto application is installed on the smartphone to connect.**

2 **Touch [] from the main menu.**

3 **Touch [Bluetooth & Devices].**

The device search screen will be displayed if there is no smartphone registered to the multimedia system. Proceed to Procedure 6.

4 **Touch [Manage devices].**

5 **Touch [Add another device].**

6 **Touch [Search for devices].**

7 **Select the smartphone to register.**

8 **Check that the displayed PIN code matches the PIN code displayed on the smartphone, and then touch [OK].**

● Perform the operation according to the guidance on the screen.

9 **If Android Auto settings are displayed, touch [Yes].**

The Android Auto home screen is displayed.

● It may take around three to six seconds to return to the original screen, depending on the smartphone being connected.

● If an operation failed screen is displayed, follow the operation instructions on the screen.

10 **Operate Android Auto.**

Applications that support Android Auto can be used by touching the application.



Displays the multimedia system screen.

To display the Android Auto home screen again, touch [] from the main menu.

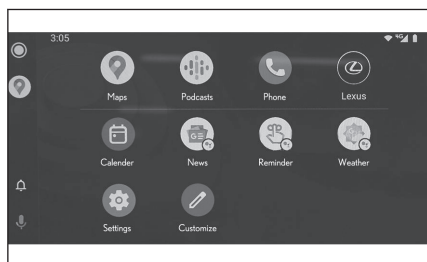



Start Google Assistant.

INFORMATION

While Android Auto is connected, press and hold the talk switch to start Google Assistant. To cancel Google Assistant, perform a short press of the talk switch.

Related Links

[Starting voice control\(P. 38\)](#)

Using Android Auto with a registered smartphone

Android Auto can be used by connecting a registered smartphone to the multimedia system. The procedure is different for unregistered smartphones.

This function is not available in some countries or areas.

Related Links

[Using Android Auto with an unregistered smartphone\(P. 121\)](#)

Using Android Auto with a USB connection

Android Auto can be used by connecting a smartphone to the multimedia system using a data USB cable.

1 **Confirm that the Android Auto application is installed on the smartphone to connect.**

2 **Connect the smartphone to the USB port.**

The Android Auto home screen is displayed.

- It may take around three to six seconds to return to the original screen, depending on the smartphone being connected.
- If an operation failed screen is displayed, follow the operation instructions on the screen.
- If guidance is displayed on the smartphone screen, follow those operation instructions.
- If the Android Auto home screen is not displayed, operate as follows:
 - On the main menu, touch [⚙️] > [Bluetooth & Devices] > [Manage devices], then [Switch] of Android Auto in order, and select the smartphone to use.
 - Touch [⏪] from the main menu.

3 **Operate Android Auto.**

Applications that support Android Auto can be used by touching the application.



Displays the multimedia system screen.

To display the Android Auto home screen again, touch [⏪] from the main menu.

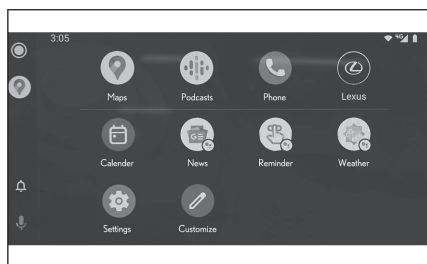



Start Google Assistant.

INFORMATION

While Android Auto is connected, press and hold the talk switch to start Google Assistant. To cancel Google Assistant, perform a short press of the talk switch.

Related Links

[Connecting the USB port\(P. 34\)](#)

[Starting voice control\(P. 38\)](#)

Using Android Auto with wireless connection

Android Auto can be connected to the multimedia system wirelessly using vehicle's wireless connection capability.

- 1 Confirm that the Android Auto application is installed on the smartphone to connect.
- 2 Touch [] from the main menu.
- 3 Touch [Bluetooth & Devices].
- 4 Touch [Manage devices].
- 5 Touch [Switch] for Android Auto.
- 6 Select the smartphone to be used with Android Auto.

The Android Auto home screen is displayed.

- It may take around three to six seconds to return to the original screen, depending on the smartphone being connected.
- If an operation failed screen is displayed, follow the operation instructions on the screen.
- If guidance is displayed on the smartphone screen, follow those operation instructions.

7 Operate Android Auto.

Applications that support Android Auto can be used by touching the application.



Displays the multimedia system screen.

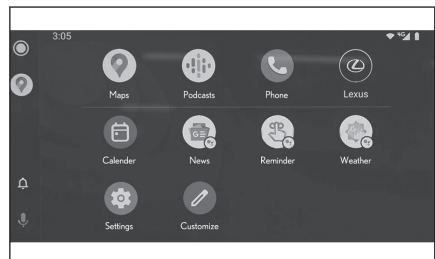

3-3. Using Apple CarPlay and Android Auto

To display the Android Auto home screen again, touch [] from the main menu.



Start Google Assistant.

INFORMATION

While Android Auto is connected, press and hold the talk switch to start Google Assistant. To cancel Google Assistant, perform a short press of the talk switch.

Related Links

[Starting voice control\(P. 38\)](#)

When Apple CarPlay or Android Auto might be malfunctioning

If having trouble with Apple CarPlay or Android Auto, check the following table first.

Symptom	Solution
Apple CarPlay or Android Auto does not start.	<p>Confirm that the smartphone being connected supports Apple CarPlay or Android Auto.</p> <p>Confirm that Apple CarPlay or Android Auto is enabled on the smartphone.</p> <p>Confirm that the Android Auto application is installed on the smartphone being connected.</p> <p>For details, refer to the following URL.</p> <ul style="list-style-type: none"> ● Apple CarPlay: https://www.apple.com/ios/car-play/ ● Android Auto: https://www.android.com/auto/
	<p>Confirm that the Apple CarPlay or Android Auto function on the registered smartphone is turned on in the multimedia system.</p>
	<p>If connecting with a USB cable, confirm that the USB cable is securely connected to the smartphone and the USB port. Connect the smartphone directly to the USB port. Do not use a USB hub.</p> <p>Make sure the correct USB port is used to connect Apple CarPlay and Android Auto. USB port used exclusively for charging cannot be used for smartphone apps. Wireless charging pad used for wireless charging will not start wireless Apple CarPlay or wireless Android Auto connection.</p> <p>For a wireless connection, check the following items.</p> <ul style="list-style-type: none"> ● Confirm that the smartphone can be connected via Bluetooth[®] to the multimedia system. ● Confirm that the smartphone is set to be able to use Wi-Fi[®]. <p>For Apple CarPlay: Confirm that the lightning cable being used is Apple-certified.</p> <p>Confirm that Siri is enabled.</p> <p>The smartphone linking function cannot be used with a charging-only USB cable.</p>

3-3. Using Apple CarPlay and Android Auto

Symptom	Solution
Apple CarPlay or Android Auto does not start.	<p>Use a cable capable of transferring data. Some cables may not be supported.</p> <p>Recommended USB cable requirements are listed below.</p> <ul style="list-style-type: none"> ● iPhone: Use an official Apple USB cable or a USB cable that has been Apple MFi certified. ● Android: Use a cable that is 6 ft. (1.8 m) or shorter, and do not use an extension cable. ● Use a cable displaying the USB logo . <p>If the smartphone linking function worked previously but no longer works, replacing the USB cable may resolve the issue.</p>
	After checking all of the above, connect Apple CarPlay or Android Auto.
When an Apple CarPlay/Android Auto connection is established and a video is being played, the video is not displayed, but audio is output through the system.	As the system is not designed to play video through Apple CarPlay/Android Auto, this is not a malfunction.
Audio is not output.	<p>The volume of the multimedia system may be muted or set too low. Increase the volume on the multimedia system.</p> <p>Make sure Apple supported apps are used for Apple CarPlay and Google supported apps are used for Android Auto. Playing music from web browser will lead to no or improper audio output.</p>
The screen flickers and audio is noisy.	<p>Check whether the USB cable connected to the multimedia system is damaged. To check whether there is internal damage to the USB cable, connect the smartphone to another system such as a PC, then confirm that charging starts and that it is recognized by the system.</p>
	Replace the USB cable with another cable.
The map display cannot be enlarged or shrunk using the Apple CarPlay map app.	Pinch operations are not supported for the Apple CarPlay map app.

Symptom	Solution
The Apple CarPlay screen is shown in the center and does not fill up the whole display.	Full-screen display is supported on iOS Ver. 10 or later. Update to the latest iOS version.
During Apple CarPlay music app (such as Spotify) playback, if an application that is not compatible with Apple CarPlay ⁽¹⁾ is started on the iPhone and audio is output and then the volume is changed on the multimedia system, the audio of the incompatible application stops and the system resumes playback on the original music application.	This operation is in accordance with the specifications of the multimedia system, and is not a malfunction.
During audio playback on the multimedia system (such as FM), if interrupt audio is output from an app that is not compatible with Apple CarPlay, the system does not return to the original audio source.	This operation is in accordance with the specifications of the multimedia system, and is not a malfunction. Manually change the audio source. Alternatively, avoid using apps that are not compatible with Apple CarPlay ⁽¹⁾ . Some navigation apps are compatible beginning with iOS 12. Update iOS and apps to the latest versions.
While using Apple CarPlay, the route guidance arrow and turn-by-turn navigation are not displayed on the multi-information display.	Depending on specifications with the multi-information display, this operation may not be displayed.
While using Android Auto, turn-by-turn navigation is not displayed on the multi-information display or the multimedia system screen.	
While using Android Auto, hands-free call audio cannot be heard from the vehicle's speakers.	End current call. Disconnect the USB cable from the smartphone and try using hands-free calling. Check whether audio can be heard now.
	Increase the volume on the multimedia system and check whether hands-free call audio can be heard. Try using another smartphone. Check whether audio can be heard now.

3-3. Using Apple CarPlay and Android Auto

- (1) "Apps that are not compatible with Apple CarPlay" refers to apps installed on an iPhone that are not displayed in the app list on the Apple CarPlay screen.

Related Links

[Setting Bluetooth® devices\(P. 84\)](#)

[Connecting the USB port\(P. 34\)](#)

[Connecting with a Bluetooth® device\(P. 98\)](#)

[Audio system ON/OFF and volume adjustment\(P. 30\)](#)

[Changing sound and media settings\(P. 76\)](#)

[Notes for operating the touch screen\(P. 21\)](#)

4-1. Navigation

Navigation function 132

4-2. Map information

Map options screen 133

Information displayed on
the map screen 134

4-3. Searching for a destination

Destination search screen 136

Destination search result list
screen 140

POI suggestion 141

Destination Assist 142

4-4. Starting route guidance

Starting route guidance 144

Full route map screen 145

4-5. Route guidance screen

Route guidance screen 147

Typical voice guidance
prompts 151

4.1. Navigation

Navigation function

The navigation system indicates your present position and assists in locating a desired destination.

The navigation function is a subscription service. It is necessary to enter a subscription service contract to use the navigation function.

If a subscription service contract has not been entered, the subscription service contract screen will be displayed when the engine switch <power switch> is turned to ON.

To enter a subscription service contract and use the navigation function, touch **[Subscribe]**.



Map options screen

- 1 Touch [≡] on the map screen.
- 2 Touch the desired item.
 - A Touch to turn the display of traffic information on/off.
 - B Touch to use Destination Assist.
 - C Touch to display the navigation settings screen.
 - D Touch to display the software version and license information.

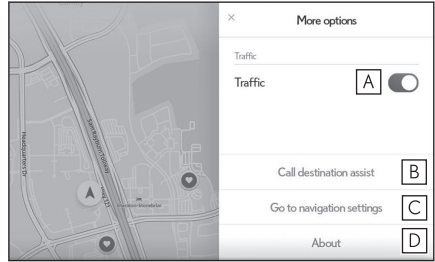

Related Links

[Displaying the navigation system settings screen\(P. 72\)](#)

Information displayed on the map screen

Traffic Information

Traffic data can be received via DCM (Data Communication Module) to display traffic information on the map screen.

- 1 Touch [≡] on the map screen.
- 2 Touch [Traffic].

Traffic information will be displayed on the map screen.

- Icons are used to indicate road conditions and incidents.
- Arrows indicate the direction of traffic.
- Colors indicate the speed at which traffic is moving.

If the traffic icon is touched, details about the touched traffic incident can be displayed.

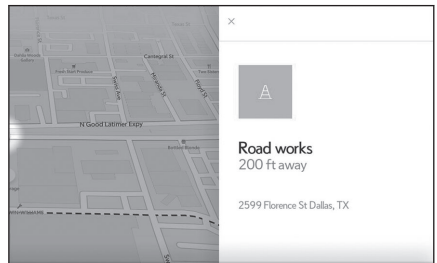

Predictive efficient drive^{*1*2*3}

The system operates based on the driving situation and traffic information to enhance fuel economy.

The predictive efficient drive function can be turned on/off.

Related Links

[Route options\(P. 75\)](#)

*1: Vehicles with hybrid system

*2: This function can only be used in the mainland U.S.A. It cannot be used in other states and territories, including Alaska and Hawaii.

*3: Refer to "OWNER'S MANUAL".

Predictive deceleration support

The system automatically stores and registers support points where the driver always decelerates or stops based on pedal operation and the vehicle speed of the driver.

Depending on the system or driving situation, the engine brake amount increases after releasing the accelerator pedal.

As a result, the battery charge amount can be increased when decelerating or stopping the vehicle to enhance fuel economy.

Predictive SOC*4 control

The system reads the road and traffic conditions ahead to efficiently control the charging and discharging of the hybrid battery according to the actual driving situation.

The capacity of the hybrid battery is limited. When it is fully charged, regeneration cannot occur, and when the battery is depleted, it may be forcibly charged by the engine. The system predicts these situations to adjust the battery charge level in advance, effectively utilizing the battery.

INFORMATION

- The system operates when starting route guidance and the position of the vehicle is along the guided route. (The system does not operate in parking lots, etc.)
- When multiple destinations are set the system will continue to operate to the last destination.

*4: SOC means state of charge.

4-3. Searching for a destination

Destination search screen

Searching for a destination using the keyboard

A destination can be searched for by entering keywords.

- 1 Touch [🗨️] or [🔍] on the map screen.
- 2 Touch [Search navigation].

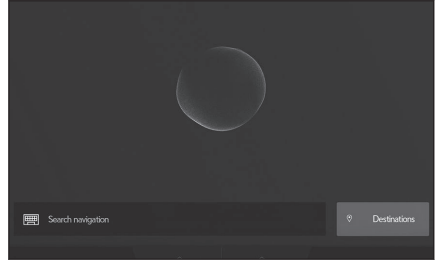

- 3 Enter characters using the keyboard.

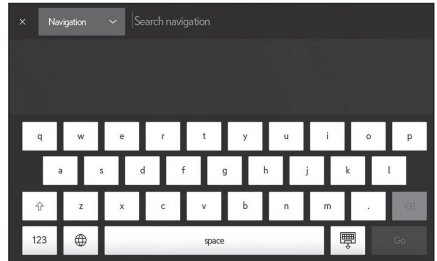

- 4 Touch [Go].
- 5 Touch the desired item from the list.

Related Links

[Destination search result list screen\(P. 140\)](#)

[Full route map screen\(P. 145\)](#)

Searching for a destination by category

A destination can be searched for from a list of categories.

- 1 Touch [🗨️] or [🔍] on the map screen.

2 Touch [Destinations].

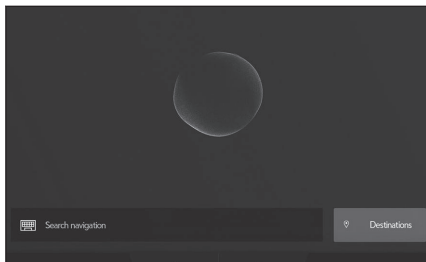

3 Touch the desired search method.

[Home]: Touch to set the registered home as the destination.

A point must be registered as home before using this function.*1

[Work]: Touch to set the registered workplace as the destination.

A point must be registered as a workplace before using this function.*1

[Favorites]: Touch to set a registered favorite as the destination.

A point must be registered as a favorite before using this function.

[Recents]: Touch to set a destination from the destination history as the destination.

[Send to car]: Send to car enables customer to send a destination or POI to the vehicle from Lexus app.

[Parking]: Touch to search for a nearby parking lot to set as a destination.

[Fuel / Charging]: Touch to search for a fuel station/charging facility to set as a destination.

[Food]: Touch to search for a restaurant to set as a destination.

[Hospitals]: Touch to search for a hospital to set as a destination.

When setting a business as a destination, if your estimated time of arrival is outside of business hours or near closing time, a notification asking to confirm the destination will be displayed.

4 Touch the desired destination from the list.

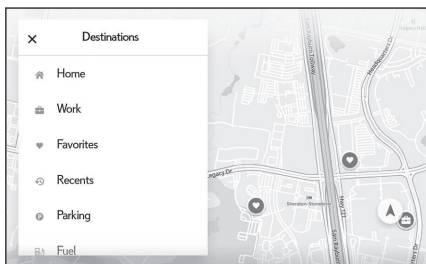

Related Links

[Destination search result list screen\(P. 140\)](#)

*1: Home and Work must be added via Lexus app.

4-3. Searching for a destination

Full route map screen(P.145)

Editing the favorites list

The favorites list can be edited.

- 1 Touch [🔊] or [🔍] on the map screen.
- 2 Touch [Destinations].
- 3 Touch [Favorites].
- 4 Touch [✎].

Touch [⊖] to delete a favorite.

The favorites list editing screen will be displayed.

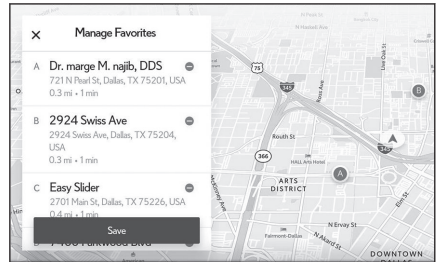

- 5 Touch [Save].

Editing the destination history

The destination history can be edited.

- 1 Touch [🔊] or [🔍] on the map screen.
- 2 Touch [Destinations].
- 3 Touch [Recents].
- 4 Touch [✎].

The destination history editing screen will be displayed.

Touch [⊖] to delete a destination history item.

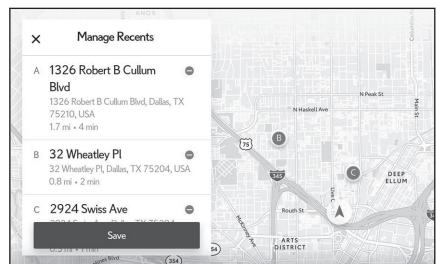

- 5 Touch [Save].

Searching for a destination using voice control

- 1 Touch [🔊] or [🔍] on the map screen.

- 2 Say the keyword you wish to use for the search.

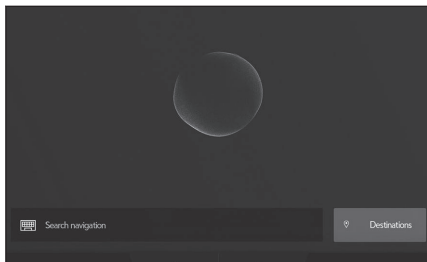

- 3 Touch the desired item from the list.

Related Links

[Starting voice control\(P. 38\)](#)

Destination search result list screen

When a destination has been searched for, a list of search results will be displayed.

- **Touch the desired destination from the list. The full route map screen will be displayed.**

By touching [], the order of the list can be filtered or sorted.

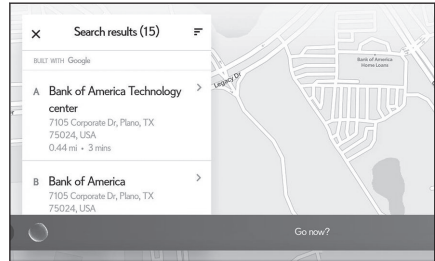

Related Links

[Full route map screen\(P.145\)](#)

Changing the order/filtering the suggested destination list

This function can only be used with an internet connection. As the results are obtained from the internet, the displayed content may change.

By touching [] on the suggested destination list screen, the order of the list can be changed or filtered.

- A Touch to clear the order/filter conditions.
- B Touch to filter the list by price.
- C Touch to filter the list by locations which are open now.
- D Touch to change the list order conditions.
- E Touch to apply the order/filter conditions and return to the list.

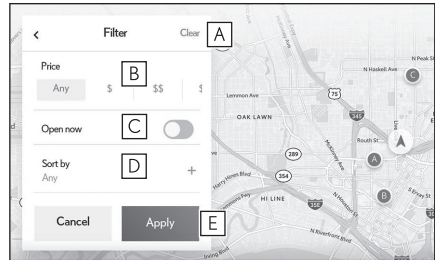

POI suggestion

Based on various information, such as the current position, fuel level, driving time, etc., the navigation system may suggest destinations.

For example:

- When the fuel level is low, fuel stations are suggested as a destination.
- When approaching the destination during route guidance, parking lots near the destination will be displayed.

1 When a destination is suggested by the navigation system, touch [☰].

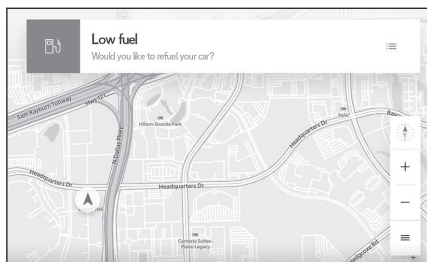

2 Touch the suggested point.

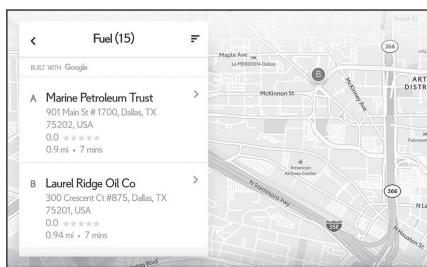

3 Touch [Go now].

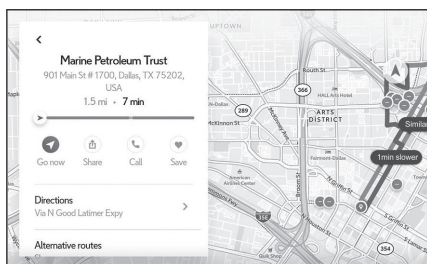

Related Links

[Full route map screen\(P.145\)](#)

Destination Assist

Destination Assist is subscription-based telematics services that use Global Positioning System (GPS) data and embedded cellular technology to provide safety and security as well as convenience features.

Destination Assist provides you with live assistance for finding destinations via the Lexus response center. You can request either a specific business, address, or ask for help locating your desired destination by category, such as restaurants, gas stations, shopping centers or other Points of Interest (POI).

After you tell the agent your choice of destination, its coordinates/address/destination name are sent wirelessly to your vehicle's navigation system.

The hands-free system cannot be used while Destination Assist is being used.

POI sent by Destination Assist agent cannot be added as favorites.

From the voice control screen

- 1 Touch [] or [] on the map screen.
- 2 Say [Destination Assist].

Related Links

[Starting voice control\(P. 38\)](#)

From steering wheel

- 1 Press the talk button on the steering wheel.
- 2 Say [Destination Assist].

Related Links

[Starting voice control\(P. 38\)](#)

Initiate Intelligent Assistant voice commands

- 1 Say the wake-up phrase [Hey Lexus].
- 2 Say [Destination Assist].

Related Links

[Starting voice control\(P. 38\)](#)

From the map screen

- 1 Touch [☰] on the map screen.

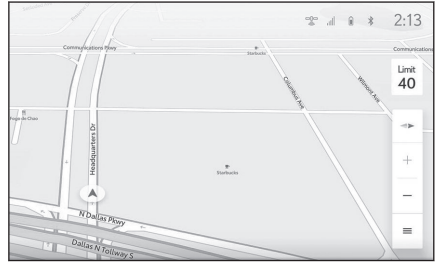

- 2 Touch [Call destination assist].

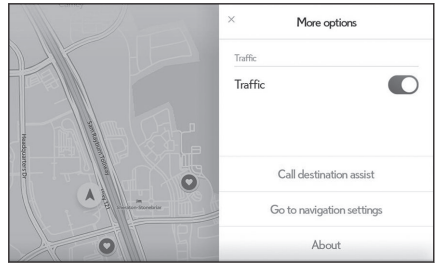

- 3 When the call is connected, speak to the operator.

The operator will confirm the desired destination information and send the destination to vehicle navigation screen. You can also ask agent to send additional destination to select destination as a way-point or replace the current destination.

- 4 Touch [Go now].

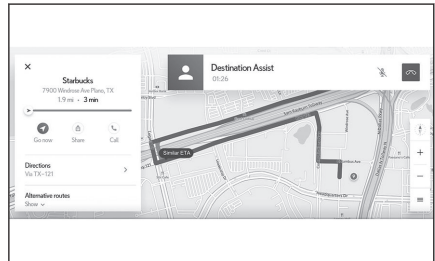
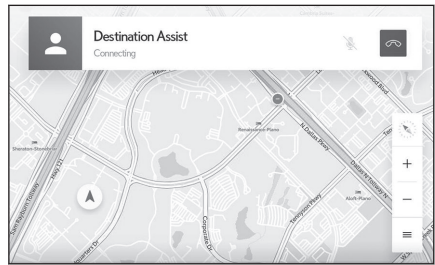

- 5 Touch [📞] to end the call.

- After the destination is set, you can also ask the agent to end the call.

4-4. Starting route guidance

Starting route guidance

After setting a destination, the search for a route will begin. When the search for a route is completed, the full route map screen (the full route from the current location to the destination) will be displayed. On the full route map screen, the desired route can be selected or the route information can be checked.

A route cannot be searched for if the destination is closer than 200 ft. (60 m) to your current vehicle location.

● Touch [Go now].

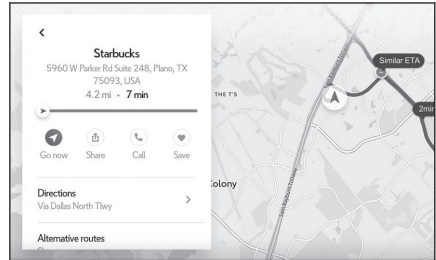

□ INFORMATION

- The route for returning may not be the same as that for going.
- The route guidance to the destination may not be the shortest route or a route without traffic congestion.
- Route guidance may not be available if there is no road data for the specified location.
- If a destination that is not located on a road is set, the vehicle will be guided to the point on a road nearest to the destination. The road nearest to the selected point is set as the destination.

▲ WARNING

Be sure to obey traffic regulations and keep road conditions in mind while driving. If a traffic sign on the road has been changed, the route guidance may not indicate such changed information.

— Related Links —

[Full route map screen\(P.145\)](#)

Full route map screen

A Colors denote congestion, aka traffic flow.

When congestion is low, it's green.
When congestion is severe, it's red. If the road is closed it's broken red line.

B Touch to start route guidance. Touch and hold to start demo mode.

C Touch to share position information with a registered contact.

To use this function, a smartphone must be connected to the navigation system.

D Touch to call the phone number registered to the POI.

E Touch to register the destination as a favorite.

F The directions list will be displayed.

G Touch to select another route.

● If POI is set as the destination, business hours etc. are also displayed.

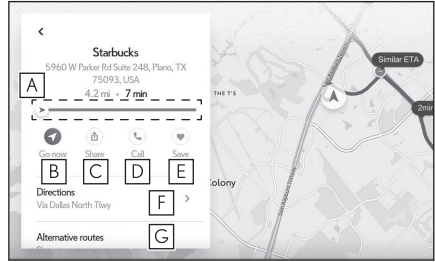

Related Links

[Searching for a destination by category\(P. 136\)](#)

[Perform operations from the in-call screen\(P. 205\)](#)

[Directions list screen\(P. 145\)](#)

[Route select screen\(P. 145\)](#)

[Starting demo mode\(P. 146\)](#)

Directions list screen

A directions list is displayed for the route.

Displays the names of intersections which are passed through or turned at, and their distance from the current position.

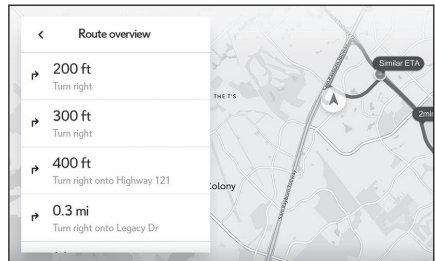

Route select screen

1 Touch [Alternative routes].

4-4. Starting route guidance

2 Touch the desired route.

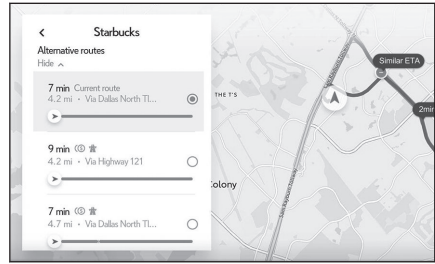

3 Touch [<].

Starting demo mode

After searching for a route, before route guidance is started, a demo of the route guidance can be viewed.

● Touch and hold [Go now] on the full route map screen.

To end the demo, touch [End] or begin driving.

Route guidance screen

During route guidance, various guidance screens can be displayed, depending on the situation.

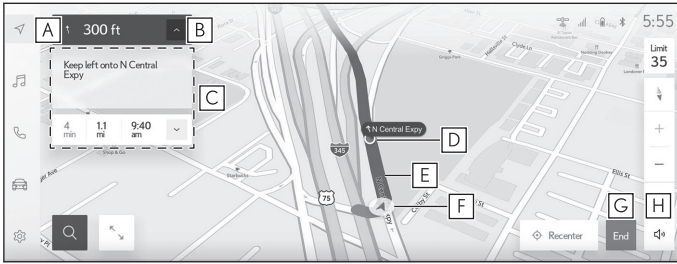

- A Displays the distance to the next turn and an arrow indicating the turn direction.
Touch to display the directions list.
- B Displays information about the next guidance point.
[^] [v]: Display/hide the information for the next guidance point.
- C Displays route information
 - When driving along the guidance route, displays the distance, estimated travel time, and estimated time of arrival at the destination.
 - When not driving along the guidance route, [Proceed to the highlighted] will be displayed.
 - Touch [v] to display the destination information screen.
- D Displays guidance points.
- E Displays the guidance route.
- F Displays the current position of the vehicle.
- G Active navigation ends.
- H Touch to mute voice guidance.
 - If the destination cannot be reached within the drivable distance, a notification suggesting a charging facility as a waypoint on the route will be displayed.
 - If a faster route is found during route guidance, a suggestion to change routes will be displayed.

INFORMATION

- If the vehicle goes off the guidance route, the route will be recalculated.

4-5. Route guidance screen

- For some areas, the roads have not been completely digitized in our database. For this reason, the route guidance may select a road that should not be traveled on.

Related Links

[Directions list screen\(P. 145\)](#)

[Destination information screen\(P. 148\)](#)

Destination information screen

- A Touch to return to the route guidance screen.
- B Active navigation ends.
- C Touch to add/edit destinations.
If multiple destinations are set, the edit stop screen will be displayed.
- D Touch to share your estimated time of arrival.

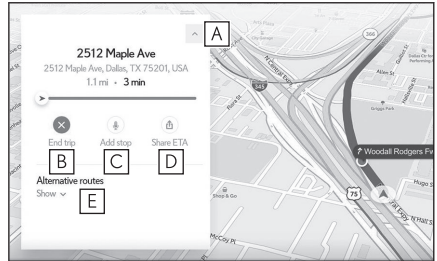

- D Touch to share your estimated time of arrival.

To use this function, a smartphone must be connected to the navigation system.

- E Touch to select another route.

Related Links

[Sharing your ETA\(P. 149\)](#)

[Route select screen\(P. 145\)](#)

Adding a destination

- 1 Display the destination information screen.
- 2 Touch [Add stop].
- 3 Search for a destination to add.
- 4 Touch [Add stop].

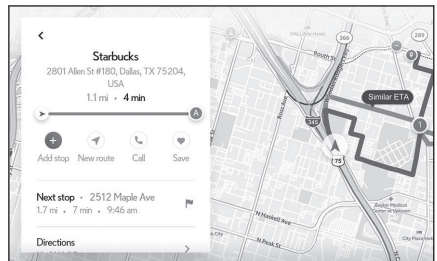

Deleting a destination (when multiple destinations have been set)

- 1 Display the destination information screen.
- 2 Touch [Edit stops].
- 3 Touch [−] for the destination you wish to delete.

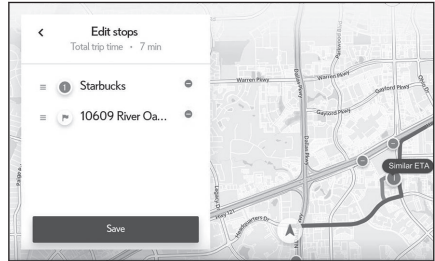

- 4 Touch [Save].

The destination order can also be changed by touching and dragging the name of a destination.

Sharing your ETA

- 1 Display the destination information screen.
- 2 Touch [Share ETA].
- 3 Touch the contact with whom you wish to share your estimated time of arrival.

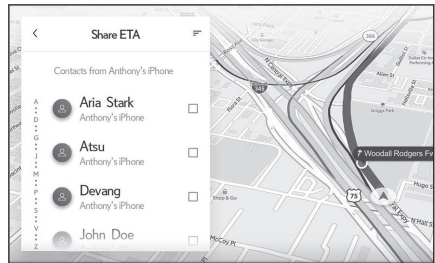

- 4 Touch [Share].

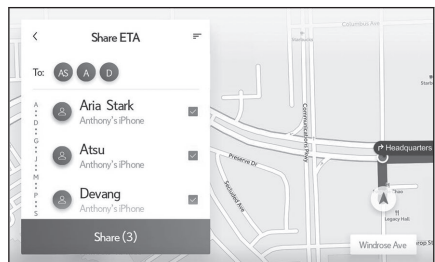

5 Touch [OK].

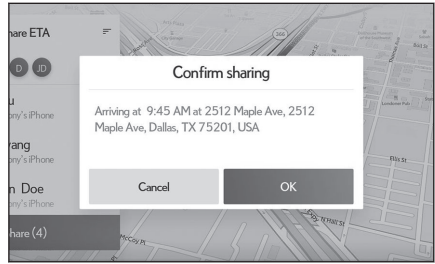

When you arrive at a destination

When you arrive at a destination, the destination arrival screen will be displayed.

- A** Touch to share position information with a registered contact.

To use this function, a smartphone must be connected to the navigation system.

- B** Touch to register the destination as a favorite.

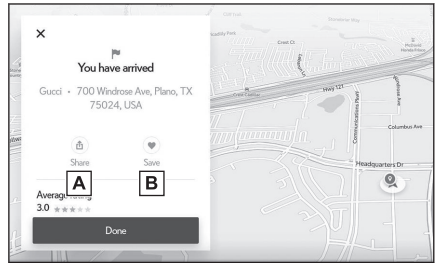

Typical voice guidance prompts

When a user is in active navigation and may or may not be on the navigation screen on the head unit; voice guidance for the active route will help user for maneuvers to turns, exits from highway/ freeway, entrance to highway/ freeway, U-turns, which lanes to stay in for these maneuvers, etc. Such maneuver points are referred to as guidance points. These voice prompts are audible to the user 2-3 times at specific distances when approaching a guidance point. Voice guidance can be heard in the language of user setting.

WARNING

Be sure to obey the traffic regulations and keep the road condition in mind especially when you are driving on IPD roads (roads that are not completely digitized in our database). The route guidance may not have the updated information such as the direction of a one way street.

Related Links

[Changing sound and media settings\(P. 76\)](#)

5-1. Radio operation

- Listening to the radio **154**
- Troubleshooting guide..... **158**
- Refer to the table below to identify the problem and take the suggested corrective action..... **159**
- Handling the radio antenna **160**

5-2. USB flash drive operation

- Precautions for playback of USB flash drive **161**
- Playing music files on a USB flash drive..... **163**

5-3. iPod/iPhone operation

- Precautions for playback of iPod/iPhone **166**
- Playing iPod/iPhone..... **167**

5-4. Apple CarPlay operation

- Precautions for playback of Apple CarPlay..... **170**
- Playing Apple CarPlay **171**

5-5. Android Auto operation

- Precautions for playback of Android Auto..... **174**
- Playing Android Auto..... **175**

5-6. Bluetooth® audio operation

- Precautions for Bluetooth® audio playback **177**
- Playing Bluetooth® audio..... **179**

5-7. Integrated Streaming

- Playing Integrated Streaming **182**

Listening to the radio

Switch to your preferred frequency or service and listen to the radio.

INFORMATION

- The radio automatically blends to an HD Radio signal in AM or FM where available. The radio automatically changes to stereo reception when a stereo broadcast is received.
- Radio mode has a mix preset function, which can store up to 20 stations from any of the AM, FM and SiriusXM bands.
- If you navigate to another radio screen while playing music, the playback screen is minimized. Selecting the minimized playback screen restores the playback screen to its original size.

1 Touch [] from the main menu.

2 Touch [Sources].

3 Touch [Radio].

4 Select the station selection method or service as necessary.

[Favorites]: Select a broadcasting station from those registered as favorites.

[Tune]: Select the broadcasting station by entering a frequency with the numeric keypad.

[FM Radio]: Switches to FM mode. The FM station list, the 3 most recently listened stations, and the receivable FM broadcasting stations are displayed.

[AM Radio]: Switches to AM mode. The AM station list, the 3 most recently listened stations, and the receivable AM broadcasting stations are displayed.

[SiriusXM]: Switches to SiriusXM Radio mode.

Displays [For You] and contents/Super Categories/[All channels]/[Listening History].

(This function is not available in some countries or areas)

5 Select the broadcasting station from the station list or genre.

6 Operate the radio that is being received as necessary.

- Operating AM/FM from the screen

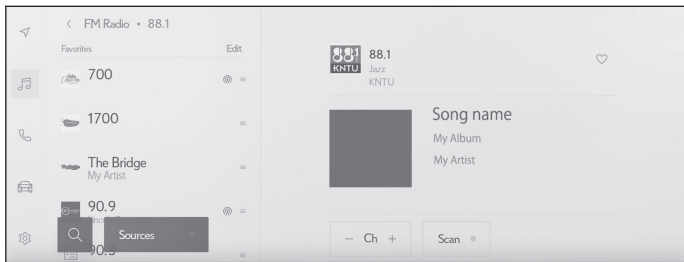

[Ch]: Touch [-] or [+] to search for the receivable broadcasting stations.

Touch and hold to switch frequencies. When released, the broadcasting station closest to that position with the best reception sensitivity is selected automatically.

[Scan]: SEEK UP and output the audio of the detected station for 10 sec. This is repeated.

[HD 12]: Displayed when Multicast CH is supported in FM mode. Touch to display the SPS channel list. The mode can be changed to the displayed SPS channel list.

[♥]: Registers the currently received broadcasting station in favorites. When registered, touch to cancel.

Preset switches of submenu: Receive the registered broadcasting stations.

● Operating SiriusXM Radio from the screen

(This function is not available in some countries or areas)

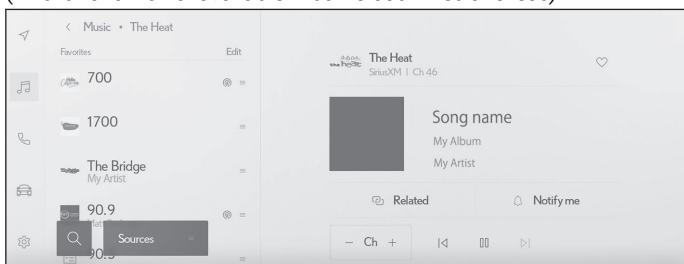

[Ch]: Touch [-] or [+] to search for the receivable channels.

Touch and hold to switch channels. When released, the current channel is received.

[⏮]/[⏭]: Fast rewind or fast forward the radio cache.

Touch and hold to jump to the start or end of the buffer.

[⏸]: Pause the radio cache.

[▶]: Play the radio cache.

[Related]: Displays related channels on the Related Channels drawer menu.

[Notify me]: Select an artist or song, or both an artist and song, to receive a notification when the corresponding broadcast starts. (When receiving a regular channel)

Select a sports team to receive a notification when the corresponding broadcast starts. (When receiving a sport channel)

[♡]: Registers the currently received channel in favorites. When registered, touch to cancel.

Preset switches of submenu: Receive the registered channels.

● Operating with the steering switches

▶ Type A

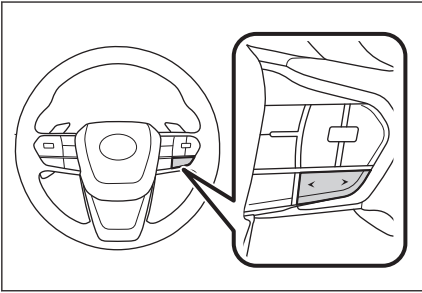

[<]/[>] switches

- AM/FM

Switches the frequencies or broadcasting stations registered in the preset switches in order.

Push and hold to switch frequencies. When released, the broadcasting station closest to that position with the best reception sensitivity is selected automatically.

- SiriusXM Radio

Switches the channels registered in the preset switches in order.

Push and hold to switch channels. When released, the channel closest to that position with the best reception sensitivity is selected automatically.

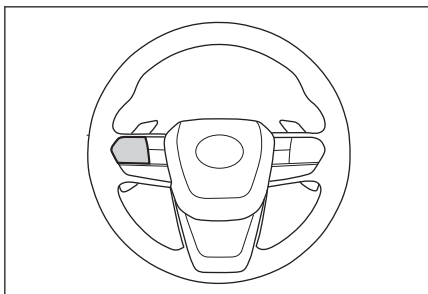
► Type B**[<]/[>] switches**

This switch can be used if set as a favorite steering switch through customization. For the customization procedure, refer to the "OWNER'S MANUAL".

- AM/FM

Switches the frequencies or broadcasting stations registered in the preset switches in order.

Push and hold to switch frequencies. When released, the broadcasting station closest to that position with the best reception sensitivity is selected automatically.

- SiriusXM Radio

Switches the channels registered in the preset switches in order.

Push and hold to switch channels. When released, the channel closest to that position with the best reception sensitivity is selected automatically.

Related Links

[Changing sound and media settings\(P. 76\)](#)

5.1. Radio operation

Troubleshooting guide

Experience	Cause	Action
Mismatch of time alignment- a user may hear a short period of programming replayed or an echo, stutter or skip.	The radio stations analog and digital volume is not properly aligned or the station is in ballgame mode.	None, radio broadcast issue. A user can contact the radio station.
Sound fades, blending in and out.	Radio is shifting between analog and digital audio.	Reception issue, may clear-up as the vehicle continues to be driven. Turning the indicator of the [HD Radio AM] and [HD Radio FM] button off can force radio in an analog audio.
Audio mute condition when an HD2/HD3 multicast channel had been playing.	The radio does not have access to digital signals at the moment.	This is normal behavior, wait until the digital signal returns. If out of the coverage area, seek a new station.
Audio mute delay when selecting an HD2/HD3 multicast channel preset.	The digital multicast content is not available until HD Radio™ broadcast can be decoded and make the audio available. This takes up to 7 seconds.	This is normal behavior, wait for the audio to become available.
Text information does not match the present song audio.	Data service issue by the radio broadcaster.	Broadcaster should be notified. Complete the form: https://hdradio.com/stations/feedback/ .
No text information shown for the present selected frequency.	Data service issue by the radio broadcaster.	Broadcaster should be notified. Complete the form: https://hdradio.com/stations/feedback/ .

Refer to the table below to identify the problem and take the suggested corrective action

When problems occur with the SiriusXM Radio tuner, a message will appear on the screen. Referring to the table below to identify the problem, take the suggested corrective action.

Message	Explanation
"SAT Antenna Error"	The SiriusXM Radio antenna is not connected. Check whether the SiriusXM Radio antenna cable is attached securely. Contact your Lexus certified dealer for assistance.
	A short circuit occurs in the antenna or the surrounding antenna cable. Contact your Lexus certified dealer for assistance.
"No Satellite Signal"	The SiriusXM Radio signal is too weak at the current location. Wait until your vehicle reaches a location with a stronger signal.
"Channel not available"	The channel you selected is not broadcasting any programming. Select another channel.
"SAT Hardware Error"	This indicates a problem in the SiriusXM Radio module. Contact your Lexus certified dealer for assistance.
"Something went wrong"	Please try another channel.

Handling the radio antenna

The antenna that receives the radio signals is embedded into the rear window glass.

 **NOTICE**

Clean the glass with the embedded antenna (interior side) by wiping gently with a moist cloth along the wire direction. Do not use glass cleaner or other detergents, because it may damage the antenna.

Do not attach the following things to the antenna wire of the rear window glass. This may reduce reception sensitivity or generate noise.

- Window film that contains metal
- Other metallic objects (such as antennas other than Lexus genuine parts)

Precautions for playback of USB flash drive

Pay special attention to the following information about playing a USB flash drive.

INFORMATION

- Removing a USB flash drive or disconnecting a connected device during playback may cause noise to be output.
- When a USB flash drive is connected and the source is switched from another source to the USB flash drive, the first file on the drive is played. If the same USB flash drive (without its contents changed) is inserted again, playback will be started from the previously played song.
- Reading a file in an unsupported format may affect operations.
- When a USB hub is used to connect multiple devices, devices other than the first device to be recognized cannot be used.

WARNING

For safety reasons, the driver should not operate the USB flash drive while driving.

NOTICE

- Do not leave a USB flash drive inside the vehicle. The inside of the vehicle can become hot, which could cause the USB flash drive to malfunction.
- Do not push down on or subject the connected USB flash drive to unnecessary pressure. The USB flash drive or port may be damaged.
- Keep the port free of foreign matter. The USB flash drive or port may be damaged.

■ Playback of MP3/WMA/AAC/WAV/FLAC/ALAC/Ogg Vorbis

When a USB flash drive storing MP3/WMA/AAC/WAV/FLAC/ALAC/Ogg Vorbis files is connected, first all the files on the USB flash drive are checked.

It is recommended that no files other than MP3/WMA/AAC/WAV/FLAC/ALAC/Ogg Vorbis files and no unnecessary folders are written onto the USB flash drive. This ensures that the USB flash drive check finishes quickly.

INFORMATION

Many types of encoder software, such as freeware, are available in the market for MP3/WMA/AAC/WAV/FLAC/ALAC/Ogg Vorbis. Depending on the encoder condition or file format, audio quality deterioration or noise at playback start may occur, or playback may not be possible.

NOTICE

Do not add an incorrect extension to a file. Adding an extension to a file that does not match the file contents may result in files being incorrectly recognized and played. This will output a loud noise that may damage the speakers.

Incorrect example:

- Adding the ".mp3" extension to a file that is not MP3
- Adding the ".wma" extension to a file that is not WMA

Related Links

[Information about media that can be used\(P. 294\)](#)

[Format information\(P. 294\)](#)

[Information USB memories\(P. 299\)](#)

Playing music files on a USB flash drive

Play music files on a USB flash drive connected to the USB port to enjoy music. When a USB flash drive is connected, a button with the device's name is displayed on the source selection screen. This may not be displayed for some devices.

Connect the USB flash drive.

- 1 Touch [] from the main menu.
- 2 Touch [Sources].
- 3 Touch the device name or [USB].
- 4 Operate the USB flash drive that is playing as necessary.

- Operating from the screen

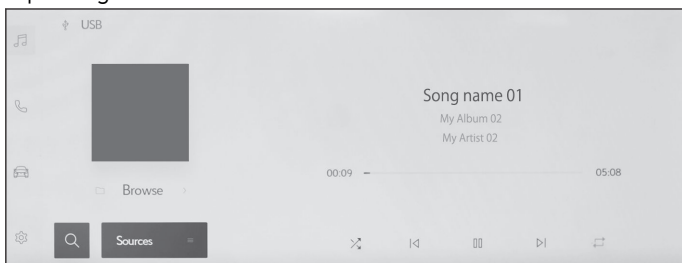

[]: Performs random playback.

Each time this is touched, the mode switches between random playback for all files or tracks, random playback canceled, and random playback of the currently playing folder or album.

[]: Plays the currently playing file or track from the beginning. When at the start of the file or track, the previous file or track will play from the beginning.

Touch and hold to fast rewind. Release to start playback from that position.

[]: Pauses playback.

[]: Plays.

[]: Switches the files or tracks.

Touch and hold to fast forward. Release to start playback from that position.

[]: Performs repeat playback.

Each time this is touched, the mode switches in order from repeat the currently playing file or track, repeat playback of the currently playing folder or album, and repeat playback of all files or tracks.

[**Browse**]: Displays the playback mode in the submenu.

Tracks can be selected from a list sorted by artist, album, folder, song, genre, or composer.

[**Shuffle play**] is displayed when playing a track selected from the list. Touch this to return to the playback screen and perform random playback.

- Operating with the steering switches

- ▶ **Type A**

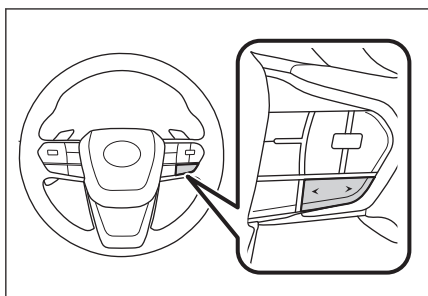

- [<]/[>] switches

- Switches the files or tracks.

- Hold to fast rewind or fast forward. Release to start playback from that position.

- ▶ **Type B**

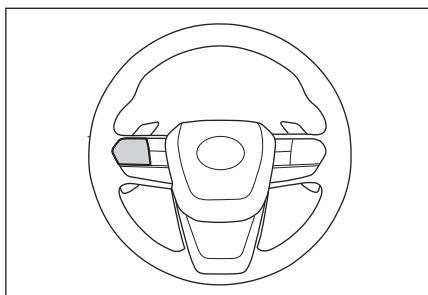

- [<]/[>] switches

- This switch can be used if set as a favorite steering switch through customization. For the customization procedure, refer to the "OWNER'S MANUAL".

- Switches the files or tracks.

Hold to fast rewind or fast forward. Release to start playback from that position.

Related Links

[Changing the audio source\(P. 32\)](#)

[Connecting the USB port\(P. 34\)](#)

[Changing sound and media settings\(P. 76\)](#)

Precautions for playback of iPod/iPhone

Pay special attention to the following information about playing iPod/iPhone.

INFORMATION

- This function cannot be used while Apple CarPlay or Android Auto is connected with a USB cable.
- Disconnecting a port or disconnecting a connected device while in iPod/iPhone mode may cause noise to be output.
- When a USB hub is used to connect multiple devices, devices other than the first device to be recognized cannot be used.
- When switching from a different source to an iPod/iPhone while the iPod/iPhone is connected, playback will be started from the previously played track.*¹

WARNING

For safety reasons, the driver should not operate the iPod/iPhone while driving.

NOTICE

- Do not leave the iPod/iPhone inside the vehicle. The inside of the vehicle can become hot, which could cause the iPod/iPhone to malfunction.
- Do not push down on or subject the connected iPod/iPhone to unnecessary pressure. The iPod/iPhone, or the port, may be damaged.
- Keep the port free of foreign matter. The iPod/iPhone or the port may be damaged.

Related Links

[iPod information\(P. 297\)](#)

*1: Depending on the device connected, operation may be different from described.

Playing iPod/iPhone

Play back music files on an iPod/iPhone connected to the USB port. When an iPod/iPhone is connected, a button with the device's name is displayed on the source selection screen. This may not be displayed for some devices.

INFORMATION

- Depending on the generation and model of iPod/iPhone that is connected, the cover art image may look grainy or list scroll display may be slow.
- Some operations may not be available or they may operate differently, depending on the generation and model of iPod/iPhone that is connected.

Connect an iPod or iPhone.

- 1 Touch [] from the main menu.
- 2 Touch [Sources].
- 3 Touch the device name or [USB].
- 4 Operate an iPod/iPhone that is playing as necessary.
 - Operating from the screen

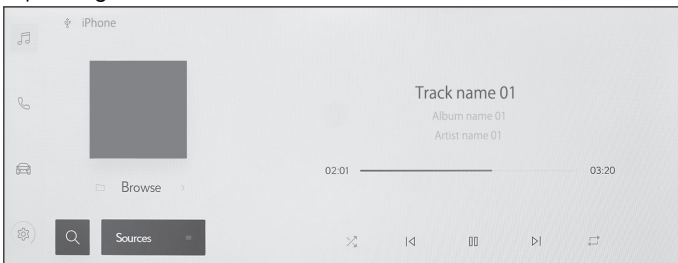

[]: Performs shuffle playback.

Each touch switches the shuffle setting.*1

[]: Plays the currently playing track from the beginning. When at the start of the track, the previous track will play from the beginning.

Touch and hold to fast rewind. Release to start playback from that position.

[]: Pauses playback.

[]: Plays.

[▶] : Switches the tracks.

Touch and hold to fast forward. Release to start playback from that position.

[↺] : Performs repeat playback.

Each touch during repeat playback switches the repeat setting.*¹

[Browse] : Displays the playback mode in the submenu.

Tracks can be selected from a list sorted by artist, album, song, playlist, genre, Podcast, composer, audiobook, or radio.

[Shuffle play] is displayed when playing a track selected from the list. Touch this to return to the playback screen and perform shuffle playback.

● Operating with the steering switches

▶ Type A

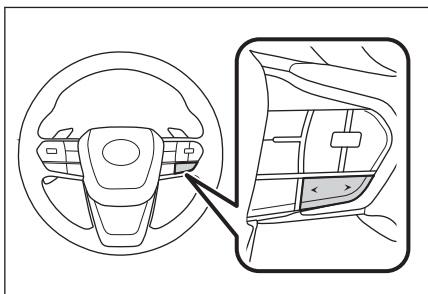

[<]/[>] switches

Switches the tracks.

Hold to fast rewind or fast forward. Release to start playback from that position.

▶ Type B

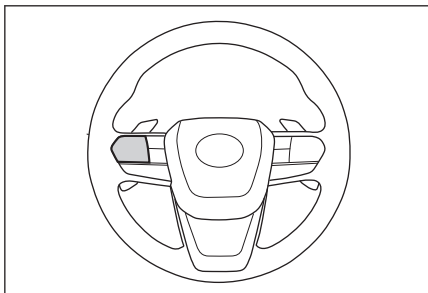

*1: The order in which shuffle or repeat settings switch depends on the connected device.

[<][>] switches

This switch can be used if set as a favorite steering switch through customization. For the customization procedure, refer to the "OWNER'S MANUAL".

Switches the tracks.

Hold to fast rewind or fast forward. Release to start playback from that position.

Related Links

[Changing the audio source\(P. 32\)](#)

[Connecting the USB port\(P. 34\)](#)

[Changing sound and media settings\(P. 76\)](#)

Precautions for playback of Apple CarPlay

Pay special attention to the following information about playing Apple CarPlay. This function is not available in some countries or areas.

INFORMATION

- This function cannot be used while Android Auto is connected.
- Disconnecting a connected device while Apple CarPlay is connected via USB may cause noise to be output.
- When a different source is switched to Apple CarPlay while an iPhone is connected, playback will be started from the previously played track.

WARNING

For safety reasons, the driver should not operate the iPhone while driving.

NOTICE

- Do not leave the iPhone inside the vehicle. The inside of the vehicle can become hot, which could cause the iPhone to malfunction.
- Do not push down on or subject the connected iPhone to unnecessary pressure. The iPhone or port may be damaged.
- Keep the port free of foreign matter. The iPhone or port may be damaged.

Related Links

[Precautions when using Apple CarPlay and Android Auto\(P. 112\)](#)

Playing Apple CarPlay

Play music files on an iPhone connected to the USB port or a wirelessly connected iPhone. When Apple CarPlay is connected, a button with the device's name is displayed on the source selection screen. This may not be displayed for some devices.

INFORMATION

- Some operations may not be available or they may operate differently, depending on the generation and model of iPhone that is connected.
- In cases such as the track not playing normally or audio skipping, update iOS to the latest version. Updating may resolve the issues.

Connect Apple CarPlay.

- 1 Touch [] from the main menu.
- 2 Touch [Sources].
- 3 Touch [Apple CarPlay] (device name).
- 4 Operate the Apple CarPlay that is playing as necessary.
 - Perform operations from the screen

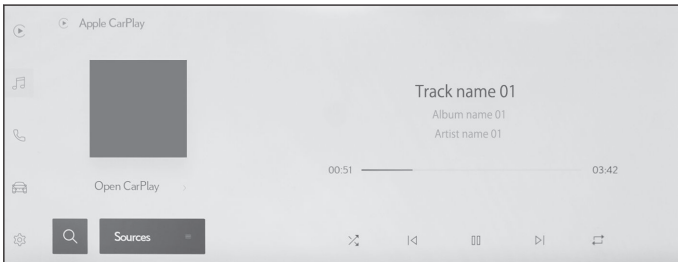

[]: Performs shuffle playback.

Each touch switches the shuffle setting.*1

[]: Plays the currently playing track from the beginning.

When at the start of the track, the previous track will play from the beginning.

Touch and hold to fast rewind. Release to start playback from that position.

[]: Pauses playback.

[]: Plays.

[▶] : Switches the tracks.

Touch and hold to fast forward. Release to start playback from that position.

[↺] : Performs repeat playback.

Each touch during repeat playback switches the repeat setting.*¹

[Open CarPlay] : Displays the Apple CarPlay screen.

- Operating with the steering switches

- ▶ **Type A**

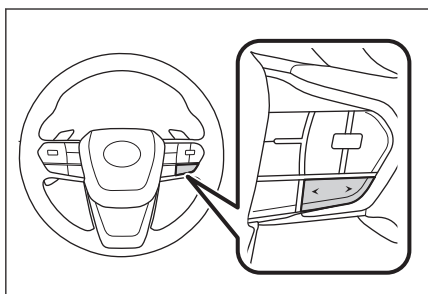

- [<]/[>] switches

- Switches the tracks.

- Hold to fast rewind or fast forward. Release to start playback from that position.

- ▶ **Type B**

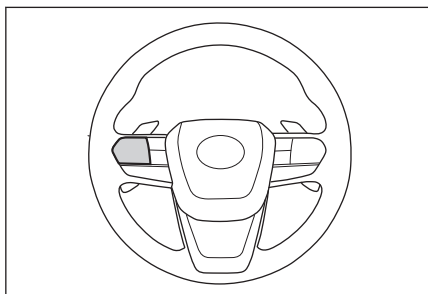

- [<]/[>] switches

- This switch can be used if set as a favorite steering switch through customization. For the customization procedure, refer to the "OWNER'S MANUAL".

- Switches the tracks.

- Hold to fast rewind or fast forward. Release to start playback from that position.

*1: The order in which shuffle or repeat settings switch depends on the connected device.

— Related Links —

[Changing the audio source\(P. 32\)](#)

[Changing sound and media settings\(P. 76\)](#)

[Setting Bluetooth® devices\(P. 84\)](#)

[Using Apple CarPlay with an unregistered smartphone\(P. 115\)](#)

[Using Apple CarPlay with a registered smartphone\(P. 118\)](#)

Precautions for playback of Android Auto

Pay special attention to the following information about playing Android Auto. This function is not available in some countries or areas.

INFORMATION

- This function cannot be used while Apple CarPlay is connected.
- Disconnecting a connected device while Android Auto is connected via USB may cause noise to be output.
- When a different source is switched to Android Auto while an Android device is connected, playback will be started from the previously played track.

WARNING

For safety reasons, the driver should not operate the Android device while driving.

NOTICE

- Do not leave the Android device inside the vehicle. The inside of the vehicle can become hot, which could cause the Android device to malfunction.
- Do not push down on or subject the connected Android device to unnecessary pressure. The Android device or port may be damaged.
- Keep the port free of foreign matter. The Android device or port may be damaged.

Related Links

[Precautions when using Apple CarPlay and Android Auto\(P. 112\)](#)

Playing Android Auto

Play music files on an Android device connected to the USB port or a wirelessly connected Android device. When an Android device is connected, a button with the device's name is displayed on the source selection screen. This may not be displayed for some devices.

Connect Android Auto.

- 1 Touch [] from the main menu.
- 2 Touch [Sources].
- 3 Touch [Android Auto] (device name).
- 4 Operate the Android Auto that is playing as necessary.

● Operating from the screen

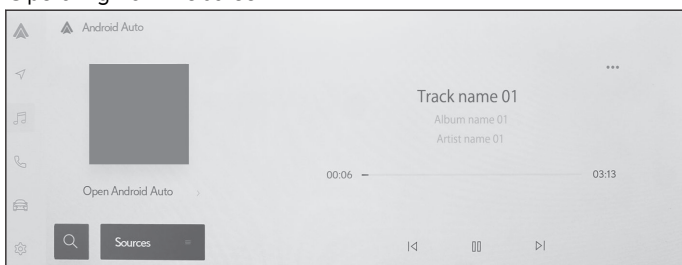

[]: Plays the currently playing track from the beginning. When at the start of the track, the previous track will play from the beginning.

[]: Pauses playback.

[]: Plays.

[]: Switches the tracks.

[Open Android Auto]: Displays the Android Auto screen.

● Operating with the steering switches

▶ **Type A**

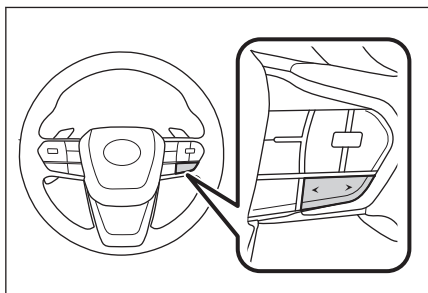

[<]/[>] switches

Switches the tracks.

► Type B

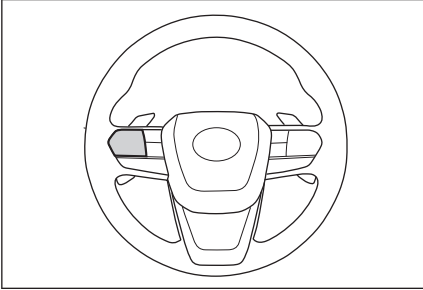

[<]/[>] switches

This switch can be used if set as a favorite steering switch through customization. For the customization procedure, refer to the "OWNER'S MANUAL".

Switches the tracks.

Related Links

[Changing the audio source\(P. 32\)](#)

[Changing sound and media settings\(P. 76\)](#)

[Setting Bluetooth® devices\(P. 84\)](#)

[Using Android Auto with an unregistered smartphone\(P. 121\)](#)

[Using Android Auto with a registered smartphone\(P. 124\)](#)

Precautions for Bluetooth® audio playback

Pay special attention to the following information when using Bluetooth® audio playback.

INFORMATION

- Registration of the cellular phone or other Bluetooth® portable audio player (hereafter referred to as portable device) in the multimedia system is required before use.
- Please be aware that some functions may be limited depending on the model of portable device.
- Using simultaneously with a wireless device could negatively affect communication for each.
- When the Wi-Fi® function is enabled in the multimedia system settings, the Bluetooth® audio sound may be interrupted.

WARNING

- For safety reasons, the driver should not operate the portable device while driving.
- The vehicle antenna for Bluetooth® communication is built into the multimedia system. People using electrical medical devices other than implantable cardiac pacemakers, implantable cardiac resynchronization therapy-pacemakers, or implantable cardioverter defibrillators should consult with their physician and the device manufacturer to determine whether electrical waves could adversely affect devices before use.

NOTICE

- Do not leave the portable device inside the vehicle. The inside of the vehicle can become hot, which could cause the portable device to malfunction.
- Do not push down on or subject the connected portable device to unnecessary pressure. The portable device or port may be damaged.
- Keep the port free of foreign matter. The portable device or port may be damaged.
- Do not use a portable device near the multimedia system. Bringing it too close could cause sound or connection quality to deteriorate.

Related Links

[Changing Wi-Fi® settings\(P. 80\)](#)

[Setting Wi-Fi® Hotspot\(P. 82\)](#)

[Precautions when using Bluetooth® devices\(P. 90\)](#)

5-6. Bluetooth® audio operation

Registering a Bluetooth® device from the multimedia system(P. 94)

Bluetooth® information(P. 300)

Playing Bluetooth® audio

By connecting a portable device, the portable device can be used without operating it directly.

INFORMATION

- The following information may not be displayed depending on the connected portable device.
 - Folder title
 - Song name
 - Album name
 - Artist name
 - Playback time
 - Total time
 - Random
 - Repeat
 - Playback/pause
 - Track up/down
- The following issues may occur depending on the connected device.
 - Operation cannot be performed from the multimedia system.
 - Operation or volume is different.
 - The display of data such as song information or time may differ between the multimedia system and the portable device.
 - The connection may disconnect when playback stops.
- When playing for a long time, the sound may skip.
- The volume while connected may differ depending on the portable device.

Connect a portable device to the multimedia system.

- 1 Touch [] from the main menu.
- 2 Touch [Sources].
- 3 Touch the device name or [Bluetooth].
- 4 Operate the Bluetooth® audio that is playing as necessary.
 - Operating from the screen

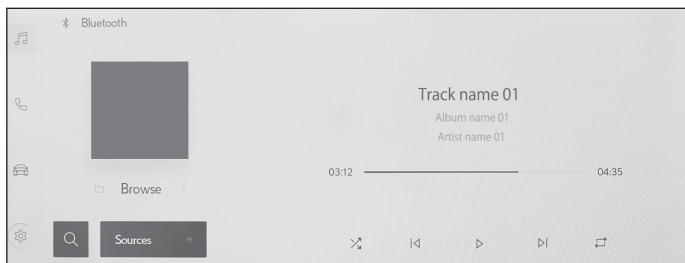



[]: Performs random playback.

Each touch switches the random setting.*¹

[]: Plays the currently playing track from the beginning. When at the start of the track, the previous track will play from the beginning.

Touch and hold to fast rewind. Release to start playback from that position.

[]: Pauses playback.

[]: Plays.

[]: Switches the tracks.

Touch and hold to fast forward. Release to start playback from that position.

[]: Performs repeat playback.

Each touch switches the repeat setting.*¹

[**Browse**]: Displays the playback mode in the submenu. Tracks can be selected from a list.

[**Shuffle play**] is displayed when playing a track selected from the list. Touch this to return to the playback screen and perform random playback.

- Operating with the steering switches

*1: The order in which random or repeat settings switch depends on the model.

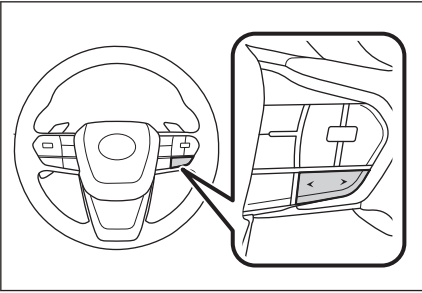
▶ **Type A****[<]/[>] switches**

Switches the tracks.

Hold to fast rewind or fast forward. Release to start playback from that position.

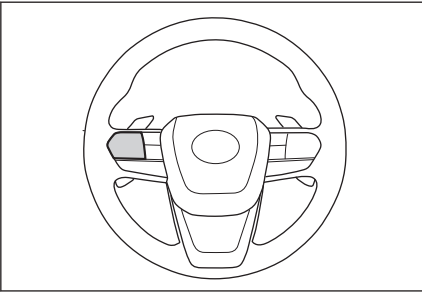
▶ **Type B****[<]/[>] switches**

This switch can be used if set as a favorite steering switch through customization. For the customization procedure, refer to the "OWNER'S MANUAL".

Switches the tracks.

Hold to fast rewind or fast forward. Release to start playback from that position.

Related Links

[Changing the audio source\(P. 32\)](#)

[Changing sound and media settings\(P. 76\)](#)

[Setting Bluetooth® devices\(P. 84\)](#)

Playing Integrated Streaming

The Integrated Streaming can be listened via audio system. In order to use this function, the customer needs to download and install the Lexus app to mobile device first. Your music account must be linked in Lexus app.

Go to <https://www.lexus.com> for more information.

This function is not available in some countries or areas.

INFORMATION

- The available functions may vary between music app.
- If you navigate to another Integrated Streaming screen while playing music, the playback screen is minimized. Selecting the minimized playback screen restores the playback screen to its original size.
- Screen layout may vary by music app.

- 1 Touch [] from the main menu.
- 2 Touch [Sources].
- 3 Select the desired streaming music service name to display each function playing screen.
- 4 As necessary, operate the following while playing music.

● Screen operation

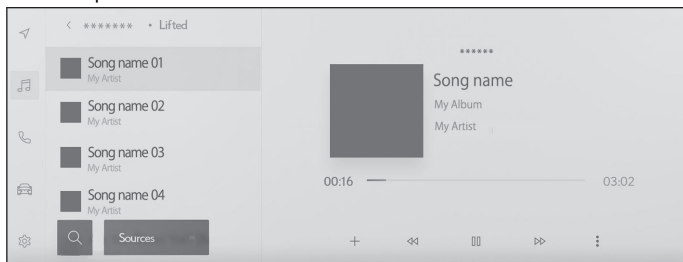

[]: Stores the current playing song to library.

[]/[]: Switches the track.

Touch and hold to fast rewind/fast forward. Release to start playback from that position.

[]: Stops the current playing music.

[]: Pauses playback.

[]: Plays.

[]: Displays the menu. The selectable contents as follow:

- **[Create station]**: Creates a station that play songs similar to current playing song.
- **[Shuffle]**: Performs shuffle playback. Tracks or albums can be automatically and randomly selected.
- **[Repeat]**: Each time this is touched, the mode switches in order of playlist, single track, and off.
- **[Love]/[Dislike]**: Helps to personalize recommended content in music app's homepage to better match your preferences.

Song name on submenu list: The current playing song can be changed by touching folder name or song name.

Related Links

[Changing sound and media settings\(P. 76\)](#)

6-1. Precautions when using hands-free calls

- Precautions for hands-free calling **186**
- Precautions when selling or disposing of the vehicle..... **189**
- When hands-free calling might be malfunctioning **190**

6-2. Operating hands-free calls with the steering switches

- Operating with the steering switches (Type A) **194**
- Operating with the steering switches (Type B)..... **196**

6-3. How to make calls

- Making calls from call history..... **198**
- Making calls from the favorites list..... **199**
- Making calls from contacts **200**
- Making calls from keypad..... **201**

6-4. How to receive calls

- Answering calls..... **202**
- Declining calls..... **204**

6-5. In-call operations

- Perform operations from the in-call screen..... **205**
- Answer second call **207**
- Making a call to another party during an ongoing call..... **208**
- Making conference calls..... **209**

- Ending calls..... **210**

6-6. Changing phones for hands-free calls

- Switching phones for hands-free calls **211**

6-7. Editing contact data

- Transferring contact data **212**

6-8. How to use the message function

- Precautions when using the message function..... **214**
- Making calls from the message function **217**

Precautions for hands-free calling

By connecting a Bluetooth® cellular phone (hereafter referred to as "cellular phone") that has been verified with the system, the phone function can be used to make and receive calls without operating the cellular phone directly. This is known as hands-free calling.

A cellular phone must support the multimedia system specifications in order to connect to the system. However, be aware that some functions may be limited depending on the model of cellular phone.

Even while connected to Apple CarPlay or Android Auto, the hands-free phone screen for Apple CarPlay or Android Auto may not be displayed, depending on conditions.

INFORMATION

- Observe the following precautions when using the cellular phone with the hands-free function.
 - A cellular phone must be registered to the multimedia system and connected with Bluetooth® before hands-free calling can be used. To use hands-free calling, first register a cellular phone.
 - Make sure the cellular phone is able to utilize the Bluetooth® function.
 - If attempting to make or receive a call during Bluetooth® audio playback, the screen display and dial tone or ringtone sound may be delayed.
- The multimedia system is not guaranteed to operate with all Bluetooth® devices. The following issues may occur depending on the cellular phone model.
 - When the engine switch <power switch> is operated during a hands-free call, the call may be disconnected.
 - The calling screen may not be displayed, or the in-call screen may be displayed before the other party answers the phone.
 - Even if numbers are entered using the numeric keypad on the calling screen, the tone signal may not be transmitted depending on the cellular phone service provider.
 - After dialing, it may be necessary to perform operations on the cellular phone.
- Hands-free calling may be unavailable in the following situations.
 - When outside of the calling area
 - When outgoing calls are restricted, such as when the lines are congested
 - During emergency calls
 - While contact data is being transferred from the cellular phone

- When dial lock is turned on for the cellular phone
 - When the cellular phone is in use, such as when transmitting data
 - When the cellular phone is malfunctioning
 - When the cellular phone is not connected
 - When the cellular phone has a low battery
 - When the cellular phone is turned off
 - When the settings prevent the cellular phone from being used for hands-free calls
 - When switching from data communication or contact transfer to hands-free calling with the multimedia system. (While switching, Bluetooth[®] connection status for the multimedia system will not be displayed)
 - When the cellular phone itself cannot be used for any other reason
- If hands-free calling and the Wi-Fi[®] function (Wi-Fi[®] or Wi-Fi[®] Hotspot^{*1}) are used simultaneously, the Bluetooth[®] connection of the cellular phone may be disconnected.

WARNING

- For safety reasons, the driver should not operate the cellular phone itself while driving.
- People with implantable cardiac pacemakers, cardiac resynchronization therapy-pacemakers or implantable cardioverter defibrillators should maintain a reasonable distance between themselves and the Bluetooth[®] antennas. The radio waves may affect the operation of such devices.
- Before using Bluetooth[®] devices, users of any electrical medical device other than implantable cardiac pacemakers, cardiac resynchronization therapy-pacemakers or implantable cardioverter defibrillators should consult the manufacturer of the device for information about its operation under the influence of radio waves. Radio waves could have unexpected effects on the operation of such medical devices.

NOTICE

Do not leave a cellular phone inside the vehicle. The inside of the vehicle can become hot, which could cause the cellular phone to malfunction.

Related Links

[Precautions when using Bluetooth[®] devices\(P. 90\)](#)

[Bluetooth[®] specifications and compatible profiles\(P. 93\)](#)

[Registering a Bluetooth[®] device from the multimedia system\(P. 94\)](#)

*1: This function is not available in some countries or areas.

Precautions for call audio

In a hands-free call, the car's built-in microphone can be used to speak. Pay special attention to the following information when making a hands-free call.

- The audio when receiving calls or when talking during calls are output from speakers on both sides of the front seats.
- The voice audio is muted when an audio or ringtone is output from the hands-free system.

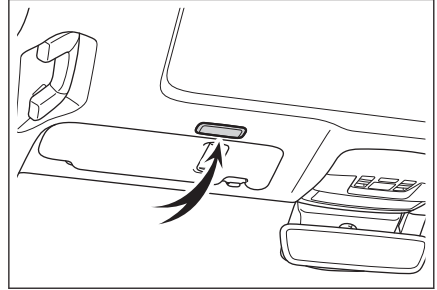

INFORMATION

- During calls, take turns speaking with the other party on the phone. If both parties speak at the same time, it may be difficult to hear what the other party is saying.
- If the receiver volume is too high, the other party's voice may be audible outside the vehicle or echoes may be heard.
- Speak clearly in a loud voice.
- In the following cases, it may be difficult for the other party to hear your voice.
 - Driving on an unpaved road.
 - Driving at high speeds.
 - The roof or windows are open.
 - The air conditioning vents are pointed towards the microphone.
 - The sound of the air conditioning fan is loud.
 - Bring your cellular phone closer to the microphone
- There is an adverse effect on sound quality (such as noise or echo) due to the phone or network being used.
- If other Bluetooth[®] devices are connected at the same time, noise may be generated in the hands-free system audio.
- If the multimedia system has been configured to use the Wi-Fi[®] function (Wi-Fi[®] or Wi-Fi[®] Hotspot^{*2}), noise may be generated in the hands-free system.

NOTICE

Do not touch or poke sharp objects into the microphone. This may cause a malfunction.

*2: This function is not available in some countries or areas.

Precautions when selling or disposing of the vehicle

A lot of personal information is registered when using the hands-free system. Make sure to clear all information before selling or disposing of the vehicle.

After initializing all the information, all the data in the multimedia system will be initialized and returned to the factory default. It cannot be returned to the state before initialization.

Related Links

[Changing the security settings\(P. 65\)](#)

6.1. Precautions when using hands-free calls

When hands-free calling might be malfunctioning

If you notice any of the following symptoms, refer to the following table for possible reasons and solutions, and check the symptom again.

■ Using hands-free calls

Symptom	Possible reason	Solution
Hands-free calls cannot be used	Your cellular phone does not support Bluetooth®.	For a list of specific devices which operation has been confirmed on multimedia system, check with your Lexus dealer or the following web-site: https://lexusconnectedtechnology.com/
	Your cellular phone version is not compatible with Bluetooth®.	Use a cellular phone compatible with Bluetooth® Core Specification Ver. 2.1 or later.

■ Cellular phone registration and connection

Symptom	Possible reason	Solution
Your cellular phone cannot be registered	The cellular phone registration operation has not been completed.	Select the authentication button when it is shown on your cellular phone and continue the registration operation.
	There is registration information remaining on either the cellular phone or the multimedia system.	Perform the registration operation again after deleting the registration information from both the multimedia system and the cellular phone.
Cannot connect via Bluetooth®	A cellular phone other than the one to use is already connected via Bluetooth®.	Manually connect the cellular phone to use via Bluetooth® from the multimedia system.
	The Bluetooth® function of the cellular phone is not activated.	While the engine switch <power switch> is in ACC or ON, activate the Bluetooth® function on the cellular phone.
	The cellular phone registration information has been deleted.	Perform the registration operation after deleting the registration information from both the multimedia system and the cellular phone.

■ Calling and receiving calls

Symptom	Possible reason	Solution
Cannot make or receive calls	Outside the service area	Move the vehicle into to a service coverage area.
	Call restriction (dial lock) is turned on for the cellular phone.	Turn off call restriction (dial lock) for the cellular phone.

■ Contacts

Symptom	Possible reason	Solution
Cannot transfer or automatically transfer contact data	The cellular phone profile does not support transferring contact data.	For a list of specific devices which operation has been confirmed on multimedia system, check with your Lexus dealer or the following website: https://lexusconnectedtechnologysupport.com/
	[Sync contacts] in the Bluetooth® settings on the multimedia system is set to off.	Set [Sync contacts] in the Bluetooth® settings on the multimedia system to on.
	The cellular phone is waiting for approval to transfer contacts.	Select the contacts transfer approval button on the cellular phone.
An approval confirmation screen is displayed on the cellular phone	Always allow is not selected during approval.	Select always allow and approve on the cellular phone.
The contact data is registered elsewhere	The contacts are not registered to the cellular phone.	Please register the contacts to the cellular phone.

■ When using the Bluetooth® message function

Symptom	Possible reason	Solution
New message notifications are not displayed.	Set [Do not disturb] on multimedia system to ON.	Set [Do not disturb] on multimedia system to OFF.

6-1. Precautions when using hands-free calls

Symptom	Possible reason	Solution
New message notifications are not displayed.	Automatic message transfer function is not enabled on the cellular phone.	Enable automatic transfer function on the cellular phone.

■ Other conditions

Symptom	Possible reason	Solution
If symptoms do not improve after applying possible solutions.	The cellular phone and multimedia system are too far apart.	Move the cellular phone and multimedia system closer together.
	Electromagnetic interference is being generated.	Turn the power off for any devices that may be generating electromagnetic waves, such as Wi-Fi® devices. Set the Wi-Fi® setting on the multimedia system to off.
	The cause lies in the cellular phone.	Turn the power off for the cellular phone, and remove the battery pack.
		Turn the cellular phone's Bluetooth® connection from off to on.
		Turn off the cellular phone's Wi-Fi® connection.
Stop any security software or background applications that are running on the cellular phone.		
Make sure to carefully confirm the provider and operating status of applications installed on the cellular phone before use.		

INFORMATION

For more details, refer to the instruction manual included with the cellular phone.

— Related Links —

[Registering a Bluetooth® device from the multimedia system\(P. 94\)](#)

[Deleting a registered Bluetooth® device\(P. 97\)](#)

Setting Bluetooth® devices(P. 84)

Disconnecting Wi-Fi®(P. 108)

Disconnecting Wi-Fi® Hotspot(P. 110)

Operating with the steering switches (Type A)

Some hands-free call functions can be operated from the steering switches, such as receiving or making calls. The steering switch functions change depending on the status of the multimedia system.

● Operate the switches as necessary.

[+] switch

Increases the ringtone volume or receiver volume.

Press and hold to adjust continuously.

[-] switch

Decreases the ringtone volume or receiver volume.



Press and hold to adjust continuously.

[] switch



Calls can be made using voice command.

To end voice command, press and hold the talk switch.

[] switch

- When the multimedia system shows a screen other than the phone screen, displays the history screen.
- When the multimedia system shows the phone screen with [] displayed, makes a call.
- When the multimedia system shows the phone screen with [] not displayed, displays the history screen.
- While making a call or during a call, ends the call.
- While receiving a call or during call waiting, answers the call.

INFORMATION

- While Apple CarPlay or Android Auto is connected, press [] to display the Apple CarPlay or Android Auto phone screen on the multimedia system.
- While Apple CarPlay and a hands-free phone are connected, press [] to display the Apple CarPlay or multimedia system phone screen. The function that was used last is prioritized. If neither has been used, the primary device is prioritized.
- While Android Auto and a hands-free phone are connected, press [] to display the multimedia system phone screen.

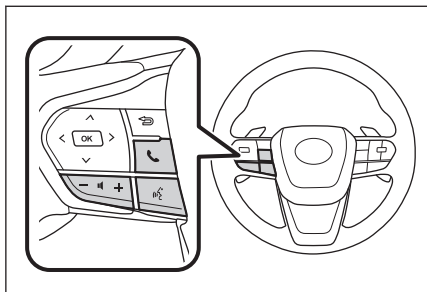

- While receiving a call, answer the call with  to display the phone screen for the incoming cellular phone (hands-free phone, Apple CarPlay or Android Auto).

Related Links

[Precautions when using Apple CarPlay and Android Auto\(P. 112\)](#)

[Starting voice control\(P. 38\)](#)

Operating with the steering switches (Type B)

Some hands-free call functions can be operated from the steering switches, such as receiving or making calls. The steering switch functions change depending on the status of the multimedia system.

The steering switches are an electrostatic type. A switch functions when the switch is touched. The displayed switch functions and their position will vary depending on the state of the vehicle and multimedia system.

● Operate the switches as necessary.

[+] switch

Increases the ringtone volume or receiver volume.

Press and hold to adjust continuously.

[-] switch

Decreases the ringtone volume or receiver volume.



Press and hold to adjust continuously.

[] switch

Calls can be made using voice command.

To end voice command, press and hold the talk switch.

[] switch



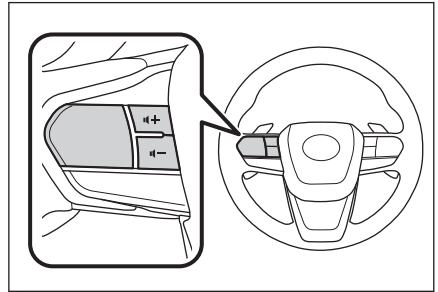

- When the multimedia system shows a screen other than the phone screen, displays the history screen.
- When the multimedia system shows the phone screen with [] displayed, makes a call.
- When the multimedia system shows the phone screen with [] not displayed, displays the history screen.
- Change calls/put a call on hold during a call.
- While receiving a call or during call waiting, answers the call.

[] switch

- While making a call or during a call, ends the call.
- Decline an incoming call/call waiting call.



 **INFORMATION**

- While Apple CarPlay or Android Auto is connected, press  to display the Apple CarPlay or Android Auto phone screen on the multimedia system.
- While Apple CarPlay and a hands-free phone are connected, press  to display the Apple CarPlay or multimedia system phone screen. The function that was used last is prioritized. If neither has been used, the primary device is prioritized.
- While Android Auto and a hands-free phone are connected, press  to display the multimedia system phone screen.
- While receiving a call, answer the call with  to display the phone screen for the incoming cellular phone (hands-free phone, Apple CarPlay or Android Auto).

Related Links

[Precautions when using Apple CarPlay and Android Auto\(P. 112\)](#)

[Starting voice control\(P. 38\)](#)

Making calls from call history

Calls can be made to phone numbers that have been recorded in the call history as outgoing or incoming calls.

- 1 Touch [] from the main menu.
- 2 Touch [Recents].
- 3 Select the contact.

For phone numbers that are not registered in the contact, the phone number will be displayed as it is.

- 4 Touch the desired phone number.

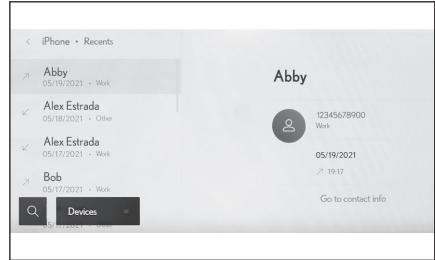

INFORMATION

- The latest 100 entries in the call history are shown. If the call history exceeds 100 entries, history items are automatically deleted starting from the oldest.
- The outgoing call history is registered as follows, depending on conditions.
 - If the call was placed to a phone number registered in contacts or to the navigation system, the name and image data are also registered if they exist.
 - If you make a call to the same phone number, the number of calls is displayed after the destination name.
- The incoming call history is registered as follows, depending on conditions.
 - If the call was received from a phone number registered in contacts, the name and image data are also registered if they exist.
 - If multiple calls were received from the same phone number, all are registered.
 - Missed calls and declined calls are also registered.
 - If the other party does not support caller ID, the call is registered as **"Unknown"**.
- Calls that were placed on hold are also registered to the call history.
- Depending on the model of cellular phone, it may not be possible to make international calls.

Making calls from the favorites list

Make a call from your favorites list.

- 1 Touch [] from the main menu.
- 2 Touch [Favorites].
- 3 Select the person you want to call from your favorites list.
- 4 Touch the desired phone number.

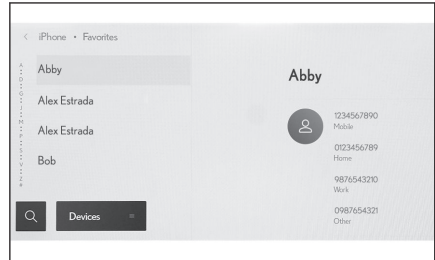

INFORMATION

- When [Sync contacts] is ON, cellular phone favorites are automatically transferred to the multimedia system.
- Depending on the cellular phone model, favorites cannot be transferred.

Related Links

[Transferring contact data\(P. 212\)](#)

Making calls from contacts

Make a call from the contacts registered on the multimedia system.

- 1 Touch [] from the main menu.
- 2 Touch [Contacts].
- 3 Select a contact.
- 4 Touch the desired phone number.

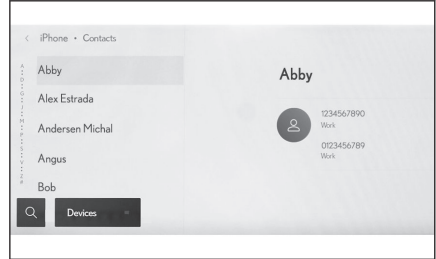

INFORMATION

- If no contact data has been registered, contact data must be transferred to the multimedia system.
- The contact data of each hands-free phone that is used is displayed on the multimedia system.



If two cellular phones are connected and the phone used for the hands-free call is switched, the contact data is also switched.

Related Links

[Transferring contact data\(P. 212\)](#)

Making calls from keypad

Enter the phone number on the keypad to make a call.

- 1 Touch [] from the main menu.
- 2 Touch [Keypad].
- 3 Enter the phone number.
- 4 Touch [], or press the [] steering wheel switch.

Calls can also be made by touching a contact displayed on the submenu.

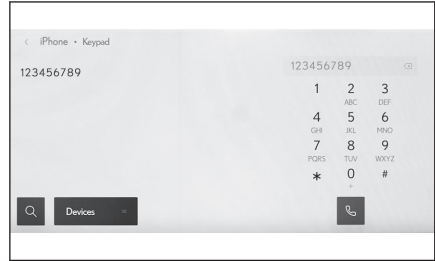



Related Links

- [Operating with the steering switches \(Type A\)\(P. 194\)](#)
- [Operating with the steering switches \(Type B\)\(P. 196\)](#)

Answering calls

When there is an incoming call, the incoming call sounds and the incoming call screen or incoming call notification is displayed.

● **Answer the call by doing one of the following.**

- Touch .
- Press the  switch on the steering switch.

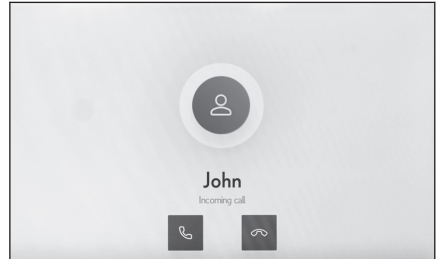

INFORMATION

- The incoming call screen is not displayed while the peripheral monitoring screen is being displayed. Incoming call notification is provided by ringtone only.
- During an incoming call, all sounds other than those coming from the hands-free call are muted. However, voice guidance with a higher priority than the hands-free call is not muted.
- Even if the cellular phone ringtone is set on the multimedia system, the multimedia system may output a different ringtone depending on the cellular phone settings.
- Depending on the cellular phone settings such as drive mode, you may not be able to receive calls.
- Depending on the cellular phone model, the following may occur.
 - The ringtone may be heard from both the vehicle speakers and the cellular phone.
 - When receiving a call, the caller's phone number may not be displayed.
 - If a call was received by operating the cellular phone directly, or if the cellular phone has been set to automatically answer calls, the call may stay on the cellular phone.
 - If there was an incoming call while the cellular phone is transmitting data, the incoming call screen may not be displayed on the multimedia system and the ringtone may not sound.
- The call is declined when a call is received from a phone number that is set to be declined in the cellular phone settings.

Related Links

[Changing the voice control settings\(P. 63\)](#)

[Operating with the steering switches \(Type A\)\(P. 194\)](#)

Operating with the steering switches (Type B)(P. 196)

Using the Intelligent Assistant system(P. 35)

Setting Bluetooth® devices(P. 84)

Declining calls

On the multimedia system, calls can be declined using several methods.

- **When receiving a call, perform any of the following operations to decline the call.**
 - Touch ].
 - Operate the cellular phone directly.
 - Speak a voice command to decline the call with the Intelligent Assistant system.

INFORMATION

- The call is declined when a call is received from a phone number that is set to be declined in the cellular phone settings.
- Setting [**Do not disturb**] in the Bluetooth[®] settings to on enables hands-free calls to be declined and notification by audio and display to be disabled. However, this is not applied to the phone function of Apple CarPlay or Android Auto. Even while a hands-free phone and Android Auto are connected, this is not applied to the hands-free call function.

Related Links

[Operating with the steering switches \(Type A\)\(P. 194\)](#)

[Operating with the steering switches \(Type B\)\(P. 196\)](#)

[Using the Intelligent Assistant system\(P. 35\)](#)

Perform operations from the in-call screen

During a call, various operations can be performed from the in-call screen.

[]: Mute the transmitted sound so that the other party cannot hear the spoken voice. The button turns blue during mute.

To cancel, touch the button again.

You will be able to hear what the other party is saying.

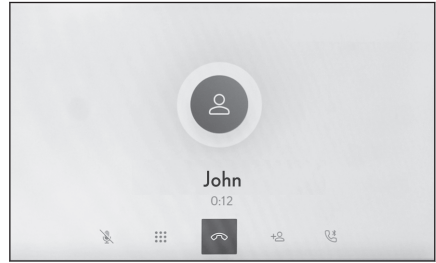



[]: Displays the keypad screen. The call screen will be displayed as small while the keypad screen is displayed.

[]: Hang up during a call.

[]: Display the contact list in the submenu to make a call to another person.

- You can make a call to another person by touching the phone number during a call to make a call.

[]: Allows a call to be switched between the cellular phone and the multimedia system. During a cellular phone call, the button changes to blue.

[]: Cancel the pending call. Only displayed on hold.

[]: Reduce the call screen.

[]: Display the call screen in the main area.

INFORMATION

- Depending on the state of the multimedia system, the call screen may be reduced or not displayed.
- Switching calls may not be possible depending on the cellular phone model.
- Calls cannot be switched from the hands-free system to the cellular phone while driving. Switching calls may not be possible depending on the cellular phone model.
- If the cellular phone you are talking on is connected to the multimedia system as a hands-free phone, the busy screen is displayed. Depending on the cellular phone model, the call can be either a cellular phone or a multimedia system.
- If you operate the engine switch <power switch> during a call with a hands-free phone, the call may be disconnected or continued on the cellular phone depending on the cellular phone model. If you want to continue on your cellular phone, you may need to operate your cellular phone.

— Related Links —

[Operating with the steering switches \(Type A\)\(P. 194\)](#)

[Operating with the steering switches \(Type B\)\(P. 196\)](#)

Answer second call

If you receive a second call from another party during an ongoing call, call-waiting can be used to handle both calls. When a second call is received, an incoming call notification is displayed at the top of the screen.

INFORMATION

- You must have a call waiting contract with your cellular phone provider.
- If the cellular phone does not support HFP Ver 1.5 or later, call-waiting will not be available.
- Depending on the cellular phone model and subscription details, it may not be possible to use this function.

- **When receiving a second call, touch [📞] on the screen, or press the [📞] switch on the steering switch.**

Answering the second call places the previous call on hold.

The caller will be switched each time [Swap calls] is touched.

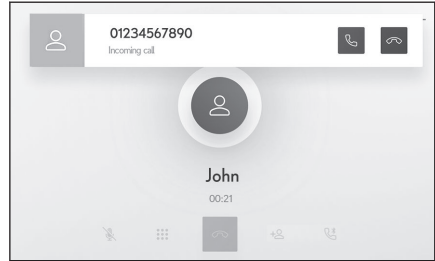

Related Links

[Operating with the steering switches \(Type A\)\(P. 194\)](#)

[Operating with the steering switches \(Type B\)\(P. 196\)](#)

Declining second calls

When a second call is received during another call, the call waiting call can be declined.

When receiving a second call, touch [📞].

INFORMATION

Depending on the model of cellular phone, both calls may be disconnected. Refer to the instruction manual included with the cellular phone.

Related Links

[Operating with the steering switches \(Type A\)\(P. 194\)](#)

[Operating with the steering switches \(Type B\)\(P. 196\)](#)

Making a call to another party during an ongoing call

You can call a new third party during an ongoing call.

- 1 Touch [] on the in-call screen.
- 2 Select the contact.
- 3 Select the phone number.

This function puts the other party on hold during a call.

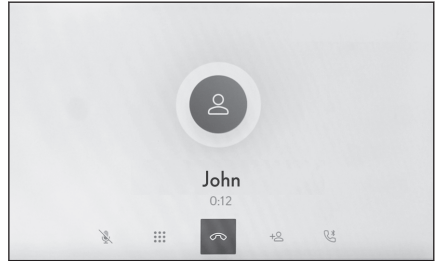

INFORMATION

- You must have a call waiting contract with your cellular phone provider.
- If the cellular phone does not support HFP Ver 1.5 or later, call-waiting will not be available.
- Depending on the cellular phone model and subscription details, it may not be possible to use this function.

Making conference calls

Add the person on hold when talking to another party while a call is on hold.

- **Touch [Merge calls] during an ongoing call with a third party.**

Calls on hold are taken off hold and switched to a conference call.



INFORMATION

- A subscription for conference calls must be purchased with the cellular phone provider.
- Depending on the cellular phone model and subscription details, it may not be possible to use this function.
- When the conference call ends, the call ends with all members of the conference call.

Ending calls

Several methods are available for ending a hands-free call.

● **Perform any of the following operations during a call.**

- Press the  switch on the steering switch.
If the switch is pressed and held, all calls will be ended, including calls on hold.
- Touch  while making a call or on the in-call screen.
- Operate the cellular phone to end the call.

Related Links

[Operating with the steering switches \(Type A\)\(P. 194\)](#)

[Operating with the steering switches \(Type B\)\(P. 196\)](#)

Switching phones for hands-free calls

If two cellular phones are connected as hands-free phones, each cellular phone can be used. Hands-free phones provide functionality to switch which cellular phone to use. The hands-free phone screen displays the selected cellular phone data, such as contacts and history. Functions such as incoming calls can also be used with the unselected cellular phone.

To connect two hands-free phones, you need to register a user profile and set the registered driver.

- 1 Touch [] from the main menu.
- 2 Touch [Devices].
- 3 Select the cellular phone you want to use.

A cellular phone that is on a call, receiving a call, or making a call cannot be selected.

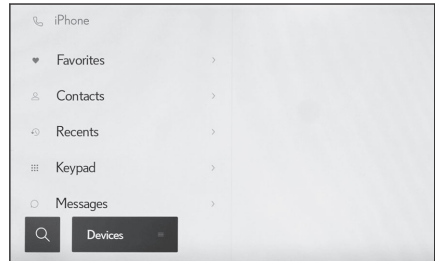

INFORMATION

- If making a call from a screen other than the hands-free phone screen, the call is placed as the primary device.
- If you are on a hands-free call using either one of the devices, calls cannot be placed from the other device.
- When a hands-free call is being made by any of the hands-free phones and an incoming call is answered by another hands-free phone, the first call is disconnected.
- The following functions are also available on the unselected cellular phone.
 - Phone incoming call function
 - Message receiving and sending functions (when receiving a message)
- The primary device will not necessarily be changed even if the cellular phone is switched.

Related Links

[Registering a user profile\(P. 46\)](#)

[Changing and registering a user profile\(P. 53\)](#)

[Setting a Bluetooth® device as a primary device\(P. 102\)](#)

Transferring contact data

Up to 5,000 contacts can be registered for each connected cellular phone. Only the contacts corresponding to the connected cellular phone can be displayed. In the contacts, up to 4 phone numbers can be registered for each contact. Contacts are managed for each connected phone.

This function can be used with cellular phones that support automatic contact data transfer (PBAP). Refer to the included instruction manual or compatible profiles for the connected cellular phone, to determine whether it supports automatic contact data transfer (PBAP).

To automatically transfer contacts (PBAP), you need to turn on [**Sync contacts**] in the Bluetooth[®] settings.

INFORMATION

- When transferring contact data, each data is subject to the following restrictions.
 - When five or more phone numbers are registered to a single contact, all phone numbers will be registered to the multimedia system as multiple contacts with the same name.
 - The name is transferred at the same time as the phone number. Depending on the model, kanji and symbols may not be transferred, or all characters may not be transferred. Also even if it is transferred, it may not be displayed correctly.
 - Typically, secret memory is not read. (It is possible in some cases, depending on cellular phone specifications)
 - The group names registered to the cellular phone are not transferred.
 - The phone number type shown in contacts on the multimedia system is automatically assigned based on information from the source device. However, depending on the model of cellular phone and usage environment, the icons may all be identical.
- Models of cellular phone that support batch transfer have the following characteristics when transferring contact data.
 - Transfer may take as long as 10 minutes.
 - Even if the contact data transfer screen is being displayed, it is possible to switch to another screen. In this case, contact data transfer will continue.
- If the engine switch <power switch> is turned off during contact list transfer, the transfer will be canceled. In this case, start the engine <hybrid system> and carry out transfer operations again.
- In the following cases, the contact data being transferred is not saved. (Some of the transferred data is not saved either.)

- When automatic transfer (PBAP) ends in the middle due to the memory capacity of the multimedia system.
- When automatic transfer (PBAP) is interrupted for some reason.
- The multimedia system's contact data cannot be transferred to the cellular phone.
- During contact data transfer, the Bluetooth® audio connection may be disconnected. It will be reconnected once transfer is complete. (Reconnection may not be possible for some models)
- When transferring, make sure the multimedia system has been started.
- The automatic contact data transfer (PBAP) function enables the transfer of contacts, favorites, and history to the multimedia system. Some cellular phone models do not allow favorites to be transferred.
- If [**Sync contacts**] is on, cellular phone favorites will be automatically transferred to the multimedia system.
- Depending on the model, it may be necessary to perform operations on the cellular phone when transferring contact data with automatic contact data transfer (PBAP).
- If you want to transfer contacts by automatic transfer (PBAP), you need to enable the contact sharing setting on your cellular phone.
- If automatic contact data transfer (PBAP) does not start, it may start when all other functions have completed.
- To transfer contact image data, you need to turn on [**Sync contacts**] in the Bluetooth® settings.

Related Links

[Bluetooth® specifications and compatible profiles\(P. 93\)](#)

[Setting Bluetooth® devices\(P. 84\)](#)

Precautions when using the message function

Messages are transferred from the cellular phone connected for hands-free calls. The multimedia system can be used to check, reply, and send messages. Depending on the cellular phone model being connected, it may not be possible to transfer messages to the multimedia system. If the cellular phone does not support messaging, this function cannot be used.

This function can be used with cellular phones that support HFP and MAP. To check if a mobile phone is compatible with HFP and MAP, check the user's manual that came with the mobile phone, or its compatible profiles.

INFORMATION

- You need to enable the message sharing setting from your cellular phone settings.
- This function cannot be used during emergency calls.
- E-mail function is not supported.
- Depending on the cellular phone model, it may not be possible to use the reply function.
- Cellular phone messages will be automatically transferred when each message function is used.
- Messages sent and received after connecting to the multimedia system are transferred to the multimedia system.
- Depending on the connected cellular phone model, it may be necessary to perform additional operations on the cellular phone.
- For SMS messages, the subject is not displayed.
- Depending on the cellular phone model, the subject name of a received MMS may not be displayed.
- Text messages can be replaced with voice data while driving.
- If [**Auto read messages**] is on, messages are read aloud.
- Outgoing messages created using Intelligent Assistant can be read aloud before being sent.
- Some information may not be displayed depending on your cellular phone model and registration status to the multimedia system.

Related Links

[Setting Bluetooth® devices\(P. 84\)](#)

[Bluetooth® specifications and compatible profiles\(P. 93\)](#)



Checking messages

Sent and received messages can be checked.

- 1 Touch [] from the main menu.
- 2 Touch [Messages].
- 3 Select the message sender.

If the body of the message fails to be read, start over from the beginning.

- 4 Select each item as necessary.

[]: Reads the message aloud. To stop the message being read aloud, touch [].

[Send message]: Intelligent Assistant system starts.

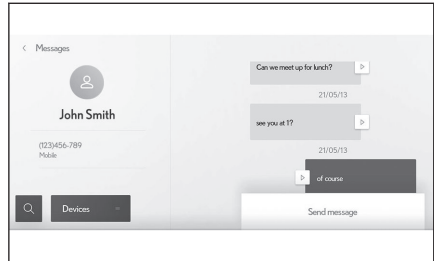

Related Links

[Replying to message\(P. 215\)](#)

[Making calls from the message function\(P. 217\)](#)

Checking new messages

When an SMS or MMS message is received, a new message notification is displayed at the top of the screen.

- The following operations can be performed when a message is received.

[]: Allows a reply to the message.

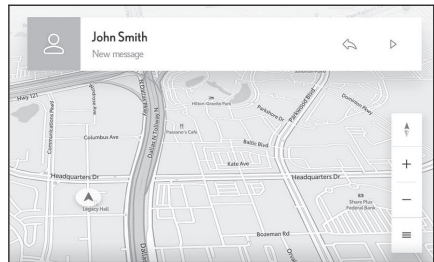

[]: Reads the message aloud.



Related Links

[Replying to message\(P. 215\)](#)

Replying to message

Reply to messages by selecting the Intelligent Assistant, touch [] or [], and saying "Send a message" and follow voice prompts. Also, reply to messages by using the hands-free screen, follow those operation instructions below.

6-8. How to use the message function

- 1 Touch [] from the main menu.
- 2 Touch [Messages].
- 3 Select the message sender.
- 4 Chat is displayed.
- 5 Touch [Send message].
- 6 Enter a message using Intelligent Assistant system.

- Replies can be sent with templates using Intelligent Assistant. (Quick reply)*¹
- If there is a valid subscription to the service *², Intelligent Assistant system can be used to enter the text of the message. (Templates can also be used to reply.)

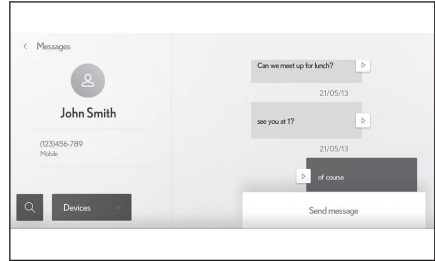

Related Links

[Using the Intelligent Assistant system\(P. 35\)](#)

Sending new messages

New SMS messages can be created. MMS is not supported.

- 1 Touch [] from the main menu.
- 2 Touch [Messages].
- 3 Touch [New message].
- 4 Follow voice prompt and on screen directions to complete your task.

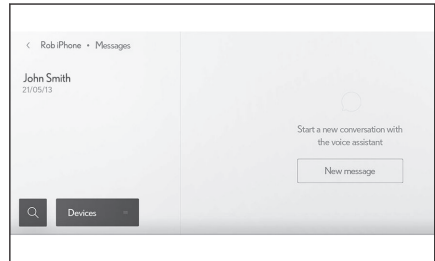

Related Links

[Using the Intelligent Assistant system\(P. 35\)](#)

*1: This function is SMS only.

*2: This function is not available in some countries or areas.

Making calls from the message function

Hands-free calls can be made using the message function.

- **Touch the blue number to make a call.**

Consecutive numbers may be recognized as phone numbers. In addition, some phone numbers, such as phone numbers from other countries, may not be recognized.

7.1. Connected Services overview

Functional overview	220
Type A: Function achieved by using DCM and the system.....	221
Type B: Function achieved by using DCM	222
Type C: Function achieved by using DCM and a smart phone.....	223

Functional overview

Connected Services include User Profile, Drive Connect (including Cloud Navigation, Intelligent Assistant, and Destination Assist), Wi-Fi® Connect (including AT&T Wi-Fi® Hotspot and Integrated Streaming), Safety Connect, Remote Connect, and Service Connect.

Types of functions

The functions included are classified into the following types.

- Type A: Function achieved by using DCM and the system
- Type B: Function achieved by using DCM
- Type C Function achieved by using DCM and a smart phone

Function	Type
User Profile, Drive Connect, Wi-Fi® Connect, OTA	Type A
Safety Connect	Type B
Remote Connect, Service Connect	Type C

INFORMATION

- These functions are not available in some countries, areas, or on some models
- Connected services functionality is dependent upon network reception level and signal strength.

Before using the function

■ Subscription

- After you have accepted the Connected Services Agreement ("Connected Services Terms of Use" and "Connected Services Privacy Notice") on the Lexus App when you register the vehicle to your account, you can begin receiving services. A variety of subscription agreements are available. Contact your Lexus dealer, or call 1-800-25-LEXUS (1-800-255-3987) in the United States, 1-877-539-8777 in Puerto Rico, or 1-800-26-LEXUS (1-800-265-3987) in Canada.

■ Availability of function(s)

These functions are not available in some countries, areas, or on some models.

Type A: Function achieved by using DCM and the system

The functionality of User Profile, Drive Connect (Cloud Navigation, Intelligent Assistant, Destination Assist), Wi-Fi® Connect (AT&T Wi-Fi® Hotspot, Integrated Streaming) is made possible through the shared work of the DCM and the system. These services are available by subscription on select, telematics hardware-equipped vehicles and supported by Lexus' designated response center, which operates 24 hours a day, 7 days a week.

Related Links

- [Using the Intelligent Assistant system\(P. 35\)](#)
- [Registering a user profile\(P. 46\)](#)
- [Updating and checking the software information\(P. 67\)](#)
- [Establishing a connection to Wi-Fi® Hotspot\(P. 109\)](#)
- [Navigation function\(P. 132\)](#)
- [Destination Assist\(P. 142\)](#)
- [Playing Integrated Streaming\(P. 182\)](#)

Type B: Function achieved by using DCM

The functionality of Safety Connect is made possible by the use of a DCM. For details, refer to vehicle "OWNER'S MANUAL".

INFORMATION

- Exposure to radio frequency signals: The system installed in your vehicle includes a low power radio transmitter and receiver. The system receives and also sends out radio frequency (RF) signals.
- In August 1996, the Federal Communications Commission (FCC) adopted RF exposure guidelines with safety levels for mobile wireless phones. Those guidelines are consistent with the safety standards previously set by both U.S. and international standards bodies.
 - ANSI (American National Standards Institute) C95.1 [1992]
 - NCRP (National Council on Radiation Protection and Measurement) Report 86 [1986]
 - ICNIRP (International Commission on Non-Ionizing Radiation Protection) [1996]
- These standards are based on comprehensive and periodic evaluations of the relevant scientific literature. Over 120 scientists, engineers, and physicians from universities, government health agencies, and industry reviewed the available body of research to develop the ANSI Standard (C95.1).
- The system complies with the FCC guidelines in addition to those standards.
- Contact with the Lexus response center is dependent upon the telematics device being in operative condition, cellular connection availability, navigation map data, and GPS satellite signal reception, which can limit the ability to reach the Lexus response center or receive support. Enrollment and Connected Services Agreement ("Connected Services Terms of Use" and "Connected Services Privacy Notice") required. A variety of subscription terms are available; charges vary by subscription term selected.
- The Lexus response center offers support in multiple languages.
- Select Safety Connect-subscribed vehicles are capable of communicating vehicle information. Please see the terms and conditions for additional details. Owners who do not wish to have their vehicle transmit this information can opt out at the time of enrollment or by calling 1-800-255-3987 in the United States, 1-877-539-8777 in Puerto Rico or 1-800-265-3987 in Canada and following the prompts for Safety Connect.
- For further details about the service, contact your Lexus dealer.
- The system functions are not subject to section 255 of the Telecommunications Act and the system is not TTY compatible.

Type C: Function achieved by using DCM and a smart phone

The functionality of Remote Connect and Service Connect are made possible by the use of a DCM and a smartphone.

For details about these services, refer to

www.lexus.com (U.S.A.), www.lexus.ca (Canada) or www.lexus.mx (Mexico).

Remote Connect

Remote Connect is a smartphone application that lets you view and remotely control certain aspects of your vehicle.

■ Availability of function

This function is not available in some countries or areas.

□ INFORMATION

- Availability of functions of the Remote Connect is dependent on network reception level.
- Remote Connect should only be used by authorized users.
- Laws in some communities may require that the vehicle be within view of the user when operating Remote Connect. In some states, use of Remote Connect may violate state or local laws. Before using Remote Connect, check your state and local laws.
- Any malfunction of the vehicle should be repaired by your Lexus dealer.
- Remote Connect is designed to work at temperatures above approximately -22 °F (-30 °C). This specification is related to the Remote Connect operation, but is dependent on the vehicle's operating temperature range which may be different.
- Content is subject to change without notice.
- Additional information can be found at

www.lexus.com (U.S.A.), www.lexus.ca (Canada) or www.lexus.mx (Mexico).

▲ WARNING

Operating Remote Connect incorrectly may lead to unforeseen accidents or malfunctions. Check the vehicle condition and assume full responsibility before using.

Service Connect

Service Connect uses DCM to collect and transmit vehicle data that allows Lexus to provide:

- Vehicle Health Report (VHR) (Safety Recalls, Service Campaigns, Current Vehicle Alerts, Required Maintenance, and Vehicle Condition Status)

- Maintenance Notifications
- Vehicle Alert Notifications
- **Availability of function**

This function is not available in some countries or areas.

 INFORMATION

Availability of functions of the Service Connect is dependent on network reception level.

8-1. Lexus parking assist monitor

- Lexus parking assist monitor functions **226**
- Displaying the guide screen **228**
- Changing the guide line display mode **230**
- Precautions for the Lexus parking assist monitor **235**

8-2. Panoramic view monitor

- Panoramic view monitor functions **245**
- Display mode when the shift position is in "P" **249**
- Display mode when the shift position is in "D" or "N" **251**
- Display mode when the shift position is in "R" **259**
- The screen when the outside rear view mirrors are folded **267**
- Zooming in on the screen **268**
- Displaying transparent underfloor vision **270**
- Changing the panoramic view monitor settings **272**
- Precautions for the panoramic view monitor **274**
- If you notice any symptoms.. **291**

8.1. Lexus parking assist monitor

Lexus parking assist monitor functions^{*1}

The Lexus parking assist monitor is a device that assists reversing when parking and in other situations by displaying vision from the rear camera installed on the vehicle.

INFORMATION

The illustrations of screens used in the descriptions are examples and may differ to the actual vision from the camera due to vehicle glare and such like.

WARNING

- Always make sure to visually check your surroundings while you are driving.
- The actual position and distance of people and obstacles that appear on the screen differ due to the characteristics of the camera lens.

Displaying the Lexus parking assist monitor screen

When the shift position is in "R" with the engine switch <power switch> turned ON, the Lexus parking assist monitor screen will be displayed.

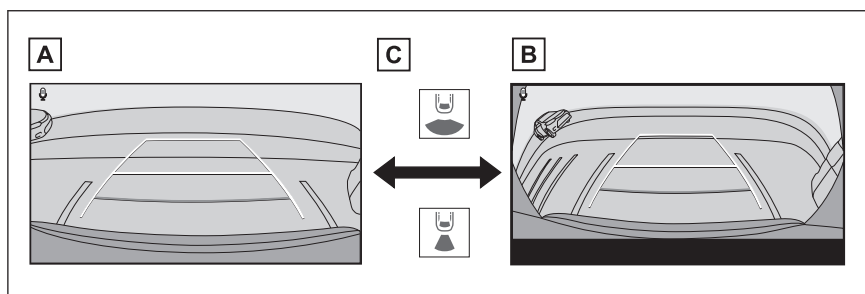

- A Rear view
- B Wide rear view
- C Touch the display mode switching button

INFORMATION

- Display settings, such as the guide line modes, can be saved as My Setting by registering to user profiles. They can be recalled when the driver is recognized.
- The Intelligent Assistant can be used to change the screen mode.

*1: If equipped

Related Links

[Registering a user profile\(P. 46\)](#)

[Starting voice control\(P. 38\)](#)

Displaying the guide screen

Shift the shift position to "R".

The mode switches each time touch the display mode button.

■ Rear view

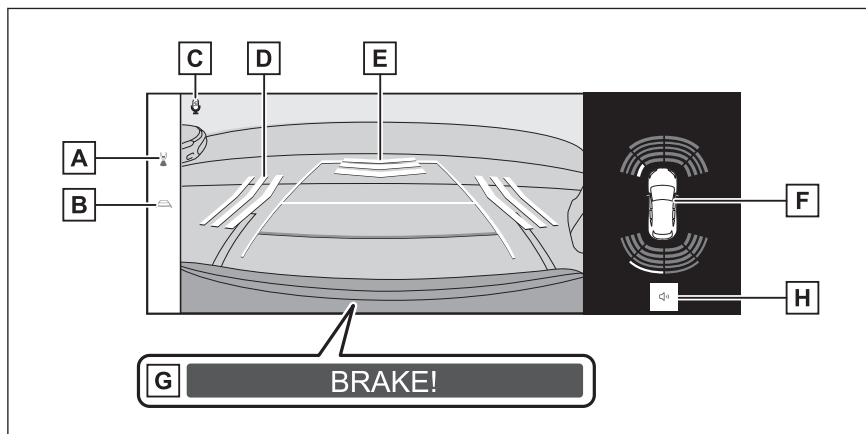

■ Wide rear view

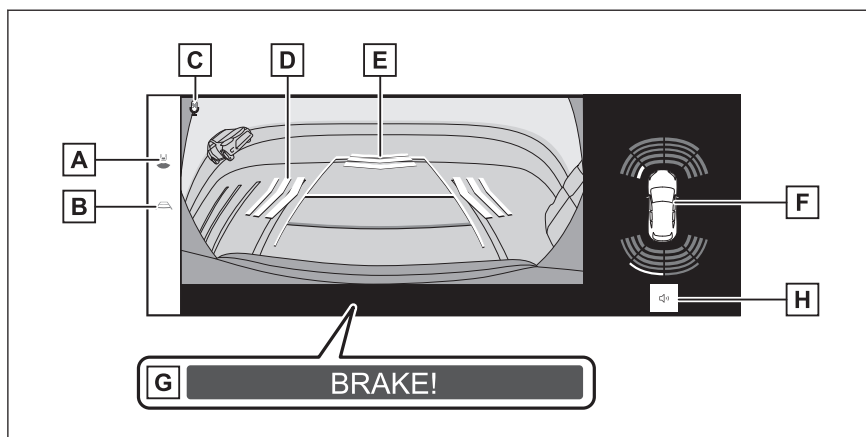

A Display mode switching button

Switches display mode between the rear view and the wide rear view.

B Guide line switching button

Switches the guide line mode.

C Voice recognition icon

This icon is displayed when the Intelligent Assistant is in operation.

D RCTA (Rear Cross Traffic Alert)/RCD (Rear Camera Detection)*¹

In the following situations, an indicator is displayed on the screen.

- When the rear radar detects a vehicle that is approaching from the rear or an object.
- When the rear camera detection function detects a pedestrian in the rear.

(For details about RCTA (Rear Cross Traffic Alert)/RCD (Rear Camera Detection), see the "OWNER'S MANUAL".)

E RCD (Rear Camera Detection)*¹

If the rear camera detects a pedestrian behind the vehicle, an indicator is displayed on the screen and a buzzer sounds. (For details about RCD (Rear Camera Detection), see the "OWNER'S MANUAL".)

F Intuitive parking assist

When the sensor detects a stationary object, a pop-up is displayed on the top-left of the guide screen. (For details about the intuitive parking assist, see the "OWNER'S MANUAL".)

G PKSB (Parking Support Brake)*¹

If an obstacle that you may collide with is detected, a message is displayed on the screen. (For details about PKSB (Parking Support Brake), see the "OWNER'S MANUAL".)

H Intuitive parking assist/RCTA (Rear Cross Traffic Alert)/RCD (Rear Camera Detection)*¹ mute button

This button temporarily mutes the intuitive parking assist/RCTA (Rear Cross Traffic Alert)/RCD (Rear Camera Detection) sound.

▲ WARNING

- The position of the guide lines displayed on the screen may change due to factors such as number of passengers, load capacity, and road gradient. Always make sure to visually check behind you and your surroundings while you are driving.
- As the intuitive parking assist, Rear Cross Traffic Alert (RCTA), and Rear Camera Detection (RCD) displays are overlaid on the camera image, the surrounding brightness and colors may make them difficult to see.

Turning off the Lexus parking assist monitor

The Lexus parking assist monitor turns off when the shift position is in any position other than "R".

*1: If equipped

Changing the guide line display mode

The guide line display mode changes every time you touch the guide line switching button.

■ Estimated course lines mode

This mode displays estimated course lines that move in accordance with the operation of the steering wheel.

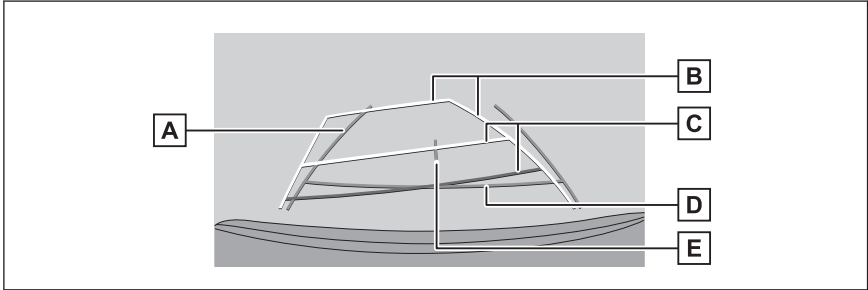

A Vehicle width guide lines

Displays course lines when the vehicle is being reversed in a straight line.

- The lines are wider than the actual width of the vehicle.
- When the vehicle is straight, the guide lines will overlap with the estimated course lines.

B Estimated course lines

Displays course lines (yellow) that are linked to operation of the steering wheel.

C Distance guide lines

Displays the distance behind the vehicle.

- The distance guide line is linked to the estimated course lines.
- Displays about 1.5 ft. (0.5 m) (red) and 3 ft. (1 m) (yellow) from the center of the end of the rear bumper.

D Distance guide line

Displays about 1.5 ft. (0.5 m) (blue) from the end of the rear bumper.

E Vehicle center guide line

Displays the center of the vehicle width guide lines.

■ Parking assist guide lines mode

This mode displays the steering wheel return points (parking assist guide lines).

This mode is recommended for those who have a sense of the vehicle and can park the vehicle without the aid of the estimated course lines.

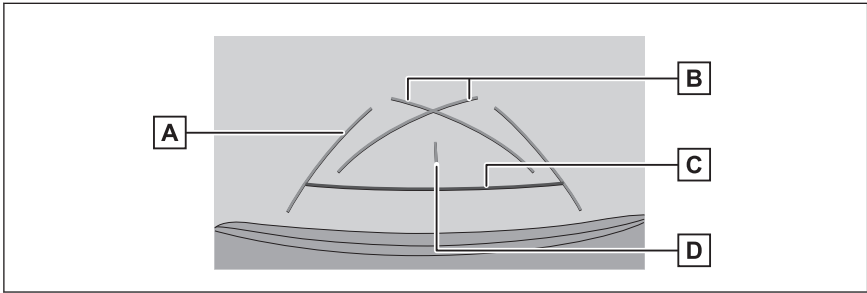

A Vehicle width guide lines

Displays course lines when the vehicle is being reversed in a straight line.

- The lines are wider than the actual width of the vehicle.

B Parking assist guide lines

Displays the course lines of the smallest turn possible behind the vehicle.

- Use the position of operating the steering wheel when parking as a guide.

C Distance guide line

Displays the distance behind the vehicle.

- Displays about 1.5 ft. (0.5 m) (red) from the center of the end of the rear bumper.

D Vehicle center guide line

Displays the center of the vehicle width guide lines.

■ **Distance guide line mode**

This mode only displays the distance guide line. It is recommended for those who do not need the guide lines.

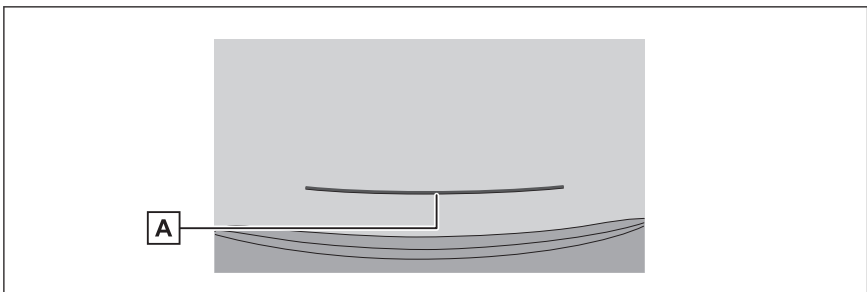

A Distance guide line

Displays the distance behind the vehicle.

- Displays about 1.5 ft. (0.5 m) (red) from the center of the end of the rear bumper.

■ **Estimated course center line mode^{*1}**

*1: If equipped

8.1. Lexus parking assist monitor

This mode displays estimated course lines and a vehicle center guide line that move in accordance with the operation of the steering wheel.

Use this mode when you are approaching a signpost or pole with the center of the rear bumper.

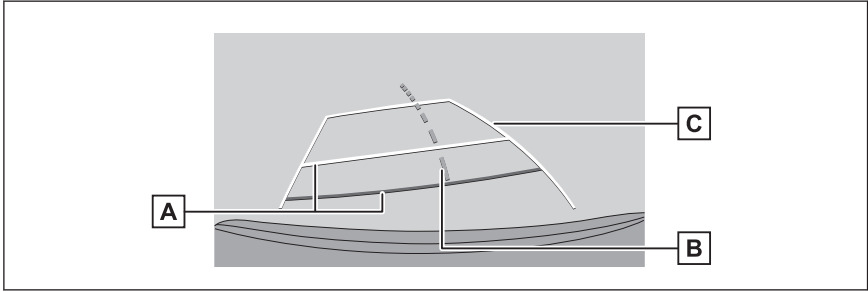

A Distance guide lines

Displays the distance behind the vehicle.

- The distance guide line is linked to the estimated course lines.
- Displays about 1.5 ft. (0.5 m) (red) and 3 ft. (1 m) (yellow) from the center of the end of the rear bumper.

B Estimated course center line

Displays the vehicle center guide line (green) that is linked to operation of the steering wheel.

C Estimated course lines

Displays course lines (yellow) that are linked to operation of the steering wheel.

INFORMATION

- The guide lines will not be displayed if the back door is not closed. If the back door is closed but the guide lines are still not displayed, have the vehicle inspected by your Lexus dealer.
- The intuitive parking assist is a feature that notifies the driver of nearby objects and displays an image of the direction of the detected object on the screen.
- The intuitive parking assist display position and the position of the object displayed on the camera image may not correspond.

WARNING

The vehicle width guide lines are wider than the actual width of the vehicle. Always make sure to visually check behind you and your surroundings when you are reversing.

Parking using the estimated course lines mode

- 1 Shift the shift position to "R".
- 2 Turn the steering wheel so that the estimated course lines are within the parking space and then reverse slowly.

A Estimated course lines

B Parking space

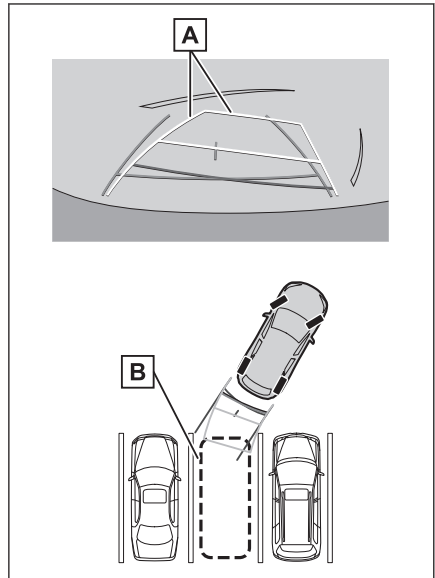

- 3 When the rear of the vehicle has entered the parking space, turn the steering wheel so that the vehicle width guide lines are within the left and right dividing lines of the parking space.

A Vehicle width guide lines

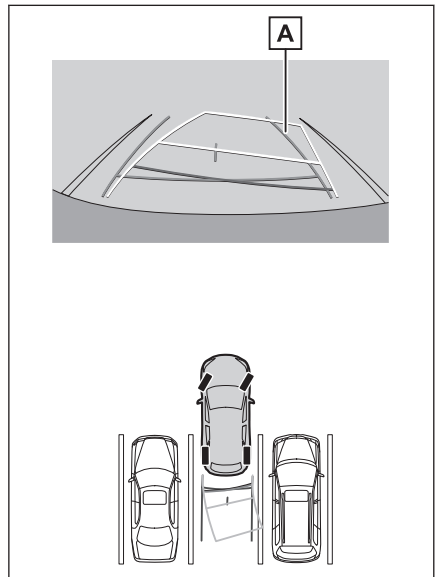

- 4 Once the vehicle width guide lines and the parking space lines are parallel, straighten the steering wheel and reverse slowly until the vehicle has completely entered the parking space.

- 5 Stop the vehicle in an appropriate place to finish parking.

Parking using the parking assist guide lines mode

- 1 Shift the shift position to "R".
- 2 Reverse until the parking assist guide lines align with the left-hand dividing line of the parking space.

- A Parking space dividing line
- B Parking assist guide lines

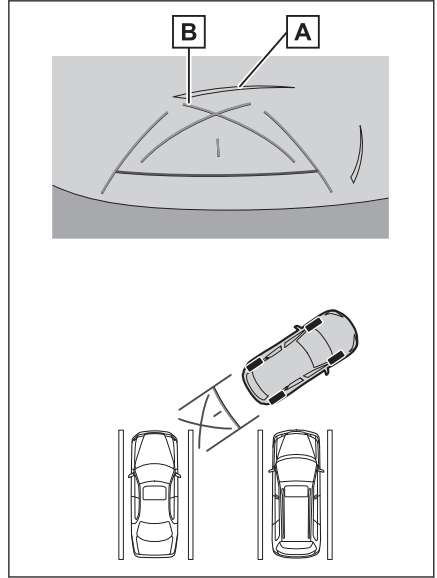

- 3 Turn the steering wheel all the way to the right, and reverse slowly.
- 4 Once the vehicle is parallel with the parking space, straighten the steering wheel and reverse slowly until the vehicle has completely entered the parking space.
- 5 Stop the vehicle in an appropriate place to finish parking.

Precautions for the Lexus parking assist monitor

Driving precautions

The Lexus parking assist monitor is equipment that assists the driver reverse the vehicle. Always make sure to visually check behind you and your surroundings when reversing. If not, you may collide with other vehicles or an unforeseen accident may occur. Follow the below precautions when using the Lexus parking assist monitor.

▲ WARNING

- Never reverse only looking at the screen. The images displayed on the screen may differ to the actual situation. Hence, if only looking at the screen when reversing, you may collide with another vehicle or have an unforeseen accident. In particular, be careful not to collide with vehicles parked nearby or other objects. Always make sure to use the rear-view and side mirrors as well as visually check behind you and your surroundings when reversing.
- Depress the brake pedal to adjust your speed and slowly reverse the vehicle.
- If collision is likely with a nearby vehicle, obstacle, or person, or mount the shoulder of the road, depress the brake pedal to stop the vehicle.
- The instructions given for the Lexus parking assist monitor modes are only guidelines. When and how much to turn the steering wheel will vary according to traffic conditions, road surface conditions, vehicle condition, and so on when parking. It is necessary to be fully aware of this before using the Lexus parking assist monitor.
- When parking, be sure to check that the parking space will accommodate your vehicle before reversing into it.
- Do not use the Lexus parking assist monitor in the following cases:
 - On icy or slick road surfaces, or in snow
 - When using tire chains or emergency tires
 - When the back door is not closed completely
 - On roads that are not flat or straight, such as hills or bends
- In low external temperatures, the screen may darken or the image may become faint. The image could distort when the vehicle is moving, or you may not be able to see the image on the screen, so always visually check your surroundings while you are driving.
- If tire sizes are changed, the position of the guide lines displayed on the screen may be incorrect.
- The actual position and distance of people and obstacles that appear on the screen differ due to the characteristics of the camera lens.

NOTICE

The camera may not function correctly and the image may be displayed on the screen in the following manner:

- When the shift position is in "R", part or all of the screen may appear black
- When the shift position is in "R", the screen may not change to the camera image
- The guide lines are not displayed on the camera image, and attention symbols and caution notices are displayed

Area displayed on the screen

■ Rear view

- A Area displayed on the screen
- B Objects not displayed on the screen

Areas close to both corners of the bumper will not appear on the screen.

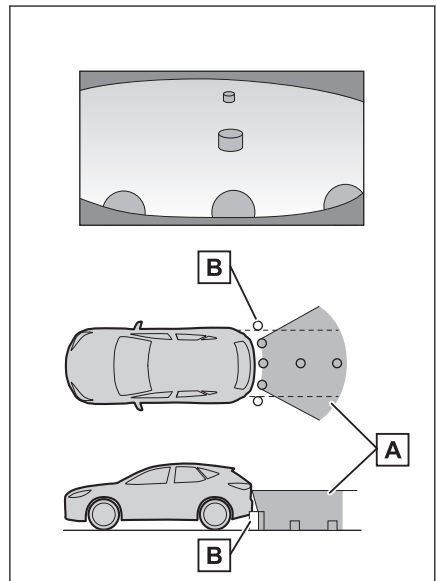

■ Wide rear view

- A Area displayed on the screen
- B Objects not displayed on the screen

Areas close to both corners of the bumper will not appear on the screen.

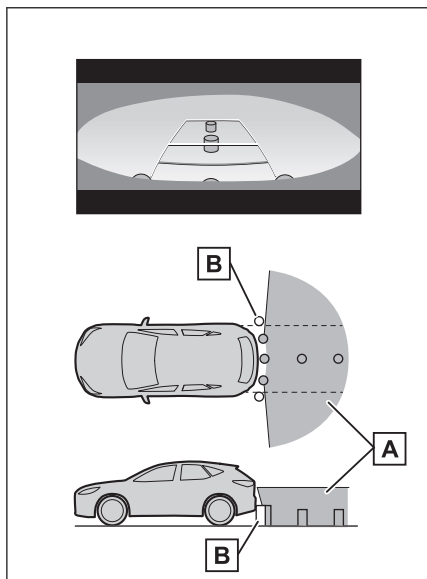

□ INFORMATION

- The range that is displayed on the screen may differ due to the state of the vehicle and road surface.
- Areas close to both corners of the bumper and under the bumper will not appear on the screen.
- The depth perception of the image displayed on the screen differs to the actual distance due to the camera lens characteristics.
- Objects that are higher than the camera may not appear in the monitor.

— Related Links —

[Changing the screen display settings\(P. 61\)](#)

Camera position

The Lexus parking assist monitor camera is in the locations shown in the figure.

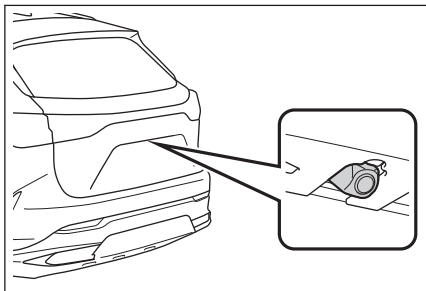

Cleaning the camera

If dirt or foreign matter, such as water droplets, snow, or mud, has stuck to the camera, you will not be able to see the image clearly. If that happens, splash the camera with a large amount of water and then wipe the camera lens clean with a soft, damp cloth.

NOTICE

- The Lexus parking assist monitor may stop functioning correctly. Take note of the following items:
 - Do not hit or apply a forceful impact on the camera. Doing so may change the position and mounting angle of the camera.
 - The camera is designed to be waterproof. Do not detach, disassemble, or modify it.
 - When washing the camera lens, splash the camera with a large amount of water and then wipe the camera lens clean with a soft, damp cloth. Rubbing the camera lens forcibly may scratch the camera lens and images may no longer be able to be seen clearly.
 - The camera cover is made of resin. Do not allow an organic solvent, car wax, window cleaner, or glass coating to adhere to the camera. If this happens, wipe it off immediately.
 - Do not pour hot water on the vehicle in cold weather or apply other rapid changes of temperature.
 - If you wash the vehicle with a high pressure car washer, do not point the hose directly at the camera or camera area. Applying strong water pressure may result in the camera malfunctioning.
- If the camera is hit, it may cause a camera malfunction. If this happens, have the vehicle inspected by your Lexus dealer as soon as possible.

■ Cleaning the rear camera with washer fluid

Dirt on the rear camera lens can be cleaned by operating the dedicated camera cleaning washer. For details, refer to "OWNER'S MANUAL".

- When cleaning the camera, it may be difficult to see the image due to the washer fluid. When backing up, be sure to visually check all around the vehicle both directly and using the mirrors before proceeding.
- If washer fluid remains on the camera lens surface after cleaning, the image may be difficult to see at night due to the height or inclination of the headlights of the vehicle behind.
- Some dirt may not be removed completely after cleaning. In this case, rinse the camera lens with a large quantity of water and then wipe it clean with a soft cloth dampened with water.
- Washer fluid is sprayed onto the camera lens surface. Therefore, the ice, snow, etc. adhering around the camera cannot be removed.

NOTICE

Do not strike or hit the washer nozzle or subject it to a strong impact, as the washer nozzle installation position and angle may be changed.

Differences between the screen and the actual road

- The distance guide lines and the vehicle width guide lines may not actually be parallel with the dividing lines of the parking space, even when they appear to be so. Be sure to check visually.
- The distances between the vehicle width guide lines and the left and right dividing lines of the parking space may not be equal, even when they appear to be so. Be sure to check visually.
- The distance guide lines show a distance guide for flat road surfaces. Therefore, there is a margin of error between the guide lines on the screen and the actual distance and course on the road.

■ When the ground behind the vehicle slopes up sharply

The distance guide lines will appear to be closer to the vehicle than the actual distance. Thus, objects on up-slopes will appear to be farther away than they actually are. In the same way, there will be a margin of error between the guidelines and the actual distance and course on the road.

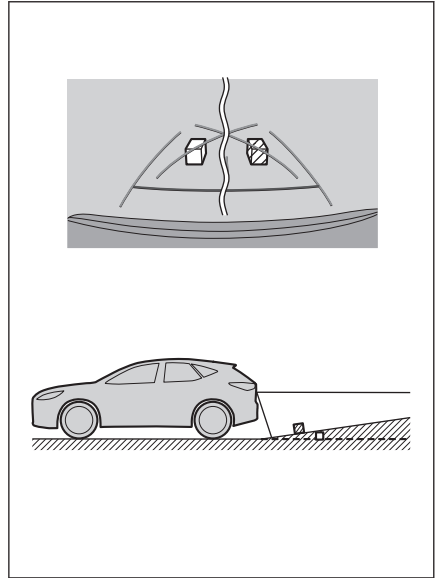

■ When the ground behind the vehicle slopes down sharply

The distance guide lines will appear to be further from the vehicle than the actual distance. Thus, objects on down-slopes will appear to be closer than they actually are. In the same way, there will be a margin of error between the guidelines and the actual distance and course on the road.

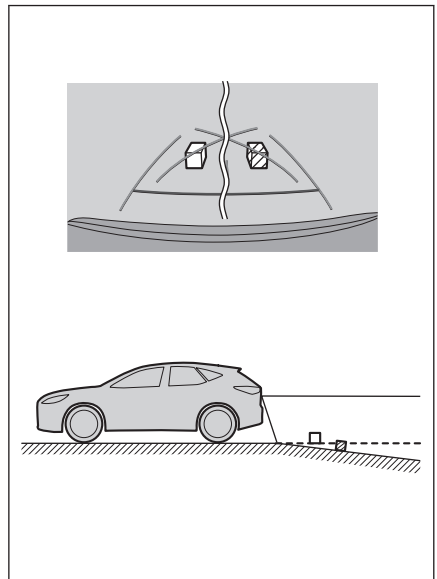

■ When any part of the vehicle sags

When any part of the vehicle sags due to the number of passengers or the distribution of the load, there is a margin of error between the guide lines on the screen and the actual distance and course on the road.

A Margin of error

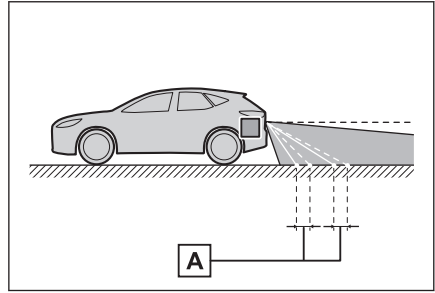

■ Estimated course center line*1

As the guide lines are shown midair near the rear bumper, there are times that they may look like they are off-center.

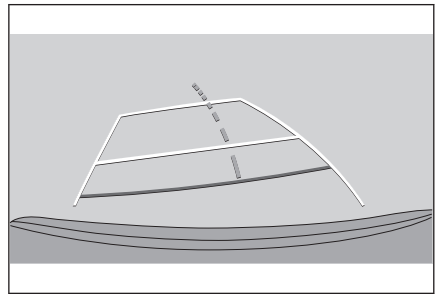

Differences between the screen and actual 3D objects

Since the estimated course lines and distance guide lines are displayed for a flat road surface, it is not possible to determine the position of three-dimensional objects. When approaching a three-dimensional object that extends outward (such as the flatbed of a truck), take note of the following cautions.

*1: If equipped

■ Estimated course lines

Make sure to visually check behind you and your surroundings. On the screen, a truck flatbed may appear to be outside of the estimated course lines and the vehicle does not look as if it will collide with the truck. However, the flatbed may actually cross over the estimated course lines and if you reverse as guided by the estimated course lines, the vehicle may hit the truck.

A Estimated course lines

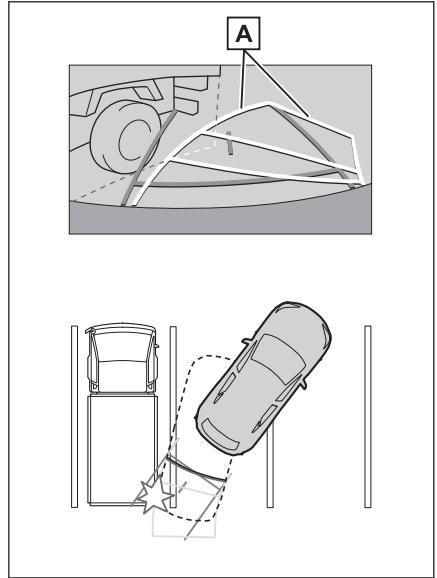

■ Distance guide lines

Make sure to visually check behind you and your surroundings. On the screen, the distance guide lines shows that a truck is parking at point **B**. However, in reality if you reverse to point **A**, you will collide with the truck. On the screen, it appears that point **A** is closest followed by points **B** and **C**. However, in reality, the distance to points **A** and **C** is the same, and point **B** is farther than **A** and **C**. The distance to point **D** is about 3 ft. (1 m).

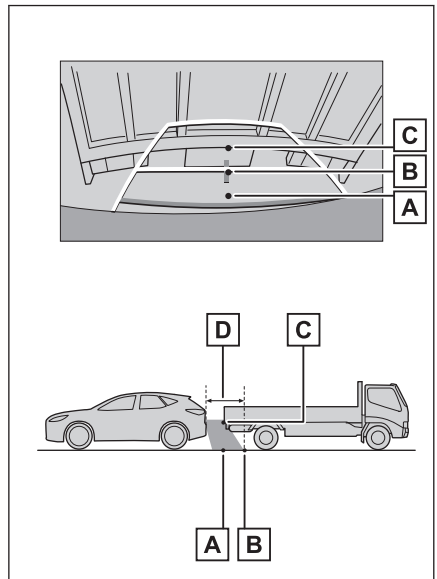

If you notice any symptoms

If you notice or are troubled by any of the symptoms below, check the issue again referring to the likely cause and solution.

If the symptom is not resolved by the solution, have the vehicle inspected by your Lexus dealer.

Symptom	Likely cause	Solution
The screen is difficult to see	<ul style="list-style-type: none"> ● The vehicle is in a dark area or it is night. ● The temperature around the lens is either high or low. ● The outside temperature is low. ● There are water droplets on the camera. ● It is raining or humid. ● Foreign matter (mud etc.) is stuck to the camera. ● Sunlight or headlights are shining directly into the camera. ● The vehicle is under fluorescent lights, sodium lights, mercury lights, etc. 	<p>Visually check your vehicle's surroundings while you are driving. (Use the Lexus parking assist monitor again once the camera and conditions have improved.)</p> <p>The procedure for adjusting the picture quality of the Lexus parking assist monitor is the same as the procedure for adjusting the multimedia screen.</p>
The image is blurry	Dirt or foreign matter, such as water droplets, snow, or mud, has stuck to the camera lens.	<p>Splash the camera with a large amount of water and then wipe the camera lens clean with a soft, damp cloth.</p> <p>Operate the dedicated camera cleaning washer and clean the camera lens. For details, refer to "OWNER'S MANUAL".</p>
The screen is misaligned	The camera has received a strong impact.	Have the vehicle inspected by your Lexus dealer.
The guide lines are significantly misaligned	The camera position is misaligned.	Have the vehicle inspected by your Lexus dealer.
	<ul style="list-style-type: none"> ● The vehicle is tilted (There is a heavy load on the vehicle, tire pressure is low due to a tire puncture, etc.). ● The vehicle is on an incline. 	Visually check your vehicle's surroundings while you are driving.

8-1. Lexus parking assist monitor

Symptom	Likely cause	Solution
The estimated course lines move even though the steering wheel is straight (the vehicle width guide lines and estimated course lines are out of alignment)	There is a malfunction in the signals being output by the steering sensor.	Have the vehicle inspected by your Lexus dealer.
The guide lines are not displayed	The back door is open.	Close the back door. If this does not resolve the issue, have the vehicle inspected by your Lexus dealer.

Related Links

[Changing the screen display settings\(P. 61\)](#)

Panoramic view monitor functions^{*1}

The panoramic view monitor is a device that assists you in driving at low speeds by displaying seamless vision from above the vehicle on the screen that is a composite of images from the front, side, and rear cameras installed on the vehicle.

INFORMATION

The illustrations of screens used in the descriptions are examples and may differ to the actual vision from the camera due to vehicle glare and such like.

WARNING

- The panoramic view monitor is a device that assists you in checking around the vehicle. Always make sure to visually check your surroundings while you are driving.
- The actual position and distance of people and obstacles that appear on the screen differ due to the characteristics of the camera lens.

Camera switch

Displays the panoramic view monitor and switches the display mode.

The vehicle customization feature enables the steering wheel switch to be used to change the panoramic view monitor display and screen. For details, see the "OWNER'S MANUAL".

▶ Type A

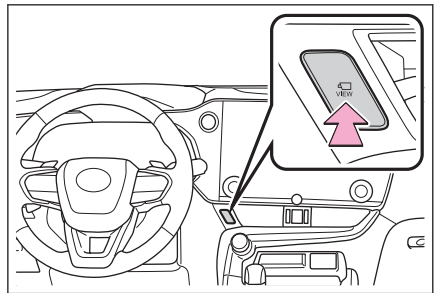

▶ Type B

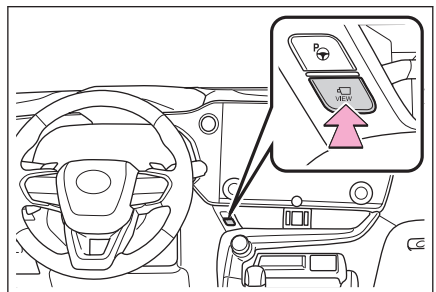

*1: If equipped

Displaying the panoramic view monitor screen

When you press the camera switch or shift the shift position to "R" while the engine switch <power switch> is in ON, the panoramic view monitor operates.

■ Display mode when the shift position is in "P"

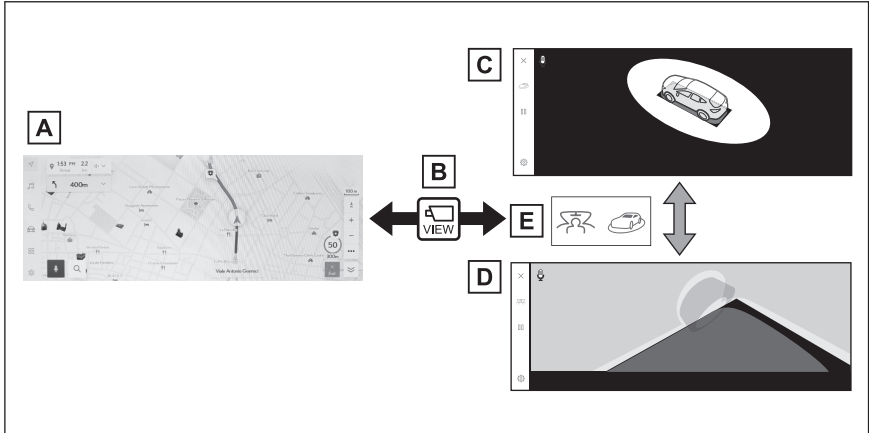

- A Navigation screen, audio screen, etc.
- B Pressing the camera switch
- C Moving view
- D See-through view
- E Touch the display mode switching button

■ Display mode when the shift position is in "D" or "N"

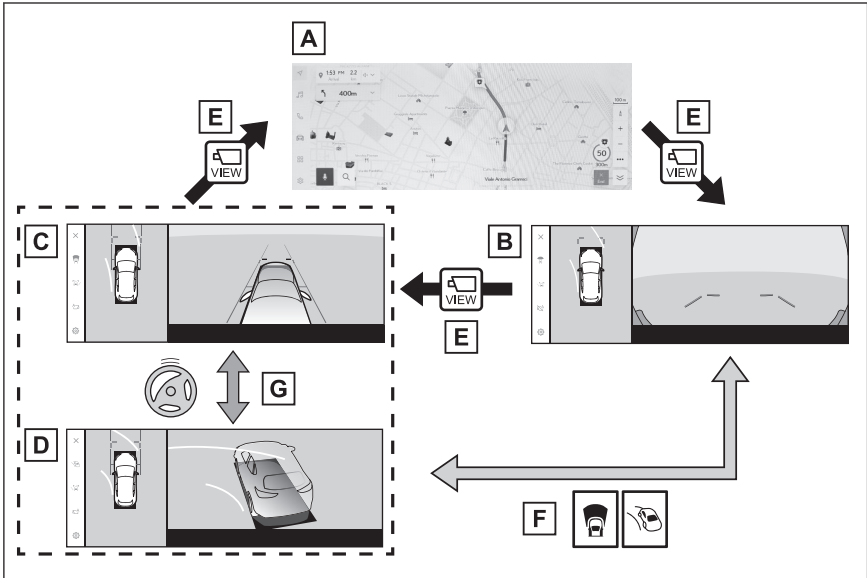

- A Navigation screen, audio screen, etc.
- B Wide front view & panoramic view
- C Side clearance view & panoramic view
- D Cornering view & panoramic view
- E Pressing the camera switch
- F Touch the display mode switching button
- G When the steering wheel is turned by 180 degrees or more from the center (straight-line) position

■ Display mode when the shift position is in "R"

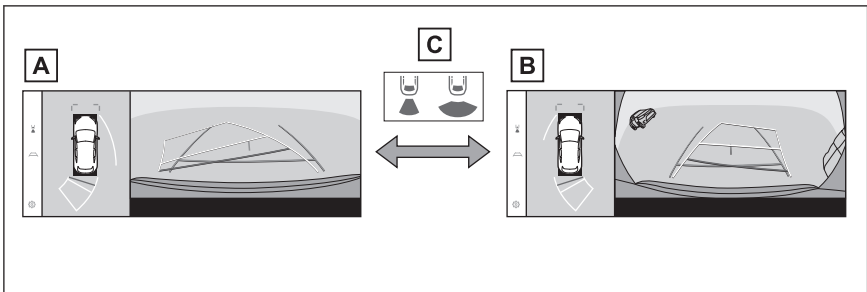

- A Rear view & panoramic view
- B Wide rear view & panoramic view
- C Touch the display mode switching button

INFORMATION

- If the camera switch is pressed when the vehicle is moving at about 7 mph (12 km/h) or less, the panoramic view monitor screen will be displayed. When the vehicle exceeds about 7 mph (12 km/h), the panoramic view monitor screen will disappear and the previous screen will be displayed.
- Display settings, such as the guide line modes, can be saved as My Setting by registering to user profiles. They can be recalled when the driver is recognized.
- The Intelligent Assistant can be used to display the panoramic view monitor screen, change the screen mode and for other operations.

Related Links

[Registering a user profile\(P. 46\)](#)

[Starting voice control\(P. 38\)](#)

Display mode when the shift position is in "P"

This is a mode that displays images combined from the cameras to enable you to check obstacles around the vehicle. Images are displayed as if seen from the driver's seat and on an angle from above the vehicle.

1. Shift the shift position to "P".
2. Press the camera switch.
 - The mode changes every time the display mode switching button is touched.
 - Pressing the camera switch again returns the display to the previous screen, such as the navigation screen.

■ See-through view

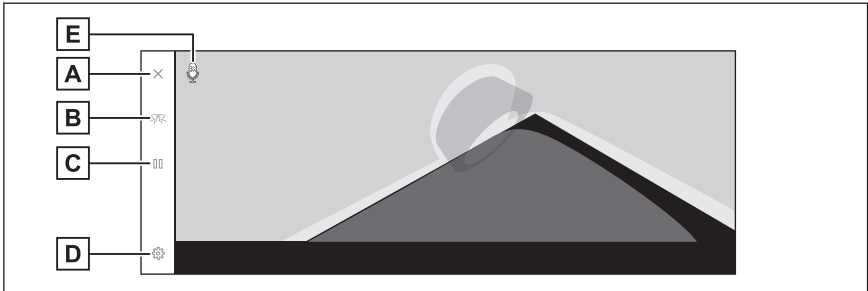

■ Moving view

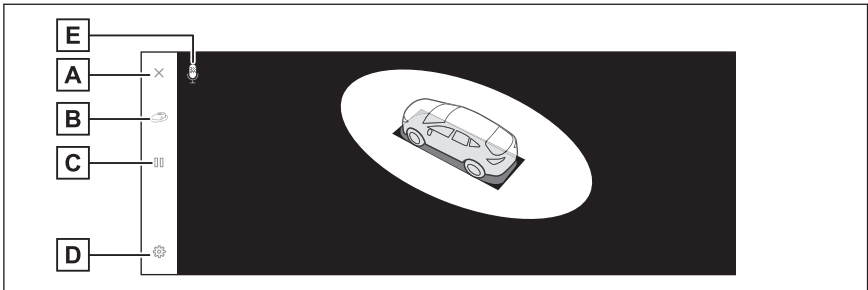

- A** Screen off button
Turns off the camera screen and returns the previous screen, such as the navigation.
- B** Display mode switching button
Switches between see-through view and moving view.
- C** Rotation pause/resume button
Pauses and resumes the rotation of the display.
- D** Customize settings button

8-2. Panoramic view monitor

Changes settings, such as the automatically display cornering view, the vehicle body color, the intuitive parking assist detection distance.

E Voice recognition icon

This icon is displayed when the Intelligent Assistant is in operation.

INFORMATION

- When the intuitive parking assist is turned on, you can display see-through view or moving view. (For details about the intuitive parking assist, see the "OWNER'S MANUAL".)
- You can also pause and resume the rotation of the see-through view and moving view screen by touching any point on the screen.

Related Links

[Changing the panoramic view monitor settings\(P. 272\)](#)

Display mode when the shift position is in "D" or "N"

You can check for nearby pedestrians, bicycles, and vehicles at intersections with poor visibility and T-junctions by displaying vision of your surroundings on the screen. This mode also provides support to check both sides of the vehicle for safety, avoid collisions on narrow roads, and pulling over to the side of the road.

1. Shift the shift position to "D" or "N".
2. Press the camera switch.
 - The mode changes every time you press the camera switch.
 - If the cornering view mode is on and you turn the steering wheel more than 180 degrees from the straight position, the display will change from side clearance view & panoramic view to cornering view & panoramic view.

■ Wide front view & panoramic view

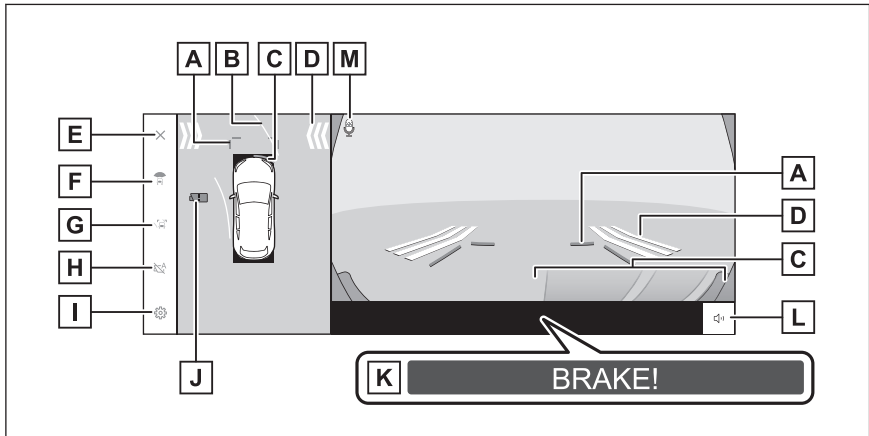

A Front distance guide lines

Displays about 3 ft. (1 m) in front of the vehicle.

B Forward estimated course lines

Displays course lines that are linked to operation of the steering wheel. (Yellow)

These lines are displayed when the steering wheel is turned more than 90 degrees from the straight position.

C Intuitive parking assist

Displays an indicator on the screen and sounds a buzzer when an object is detected by a sensor. (For details about the intuitive parking assist, see the "OWNER'S MANUAL".)

D FCTA (Front Cross Traffic Alert)

8-2. Panoramic view monitor

If FCTA detects nearby vehicles and/or obstacles from the front or rear of the vehicle, an indicator is displayed on the screen.

E Screen off button

Turns off the camera screen and returns the previous screen, such as the navigation.

F Display mode switching button

Switches display mode every time touch the button.

G Guide line switching button

Switches guide line mode every time touch the button.

H Automatic display button

Turns auto display mode on or off. When the shift position is in "D" or "N", wide front view & panoramic view or clearance view/cornering view & panoramic view will be automatically displayed in accordance with the vehicle speed.

I Customize settings button

Changes settings, such as the automatically display cornering view, the vehicle body color, the intuitive parking assist detection distance.

J Camera dirt detection icon

This icon is displayed when dirt is detected on the camera.

K PKSB (Parking Support Brake)

If an obstacle that you may collide with is detected, a message is displayed on the screen. (For details about PKSB (Parking Support Brake), see the "OWNER'S MANUAL".)

L Intuitive parking assist mute button

This button temporarily mutes the intuitive parking assist sound.

M Voice recognition icon

This icon is displayed when the Intelligent Assistant is in operation.

Side clearance view & panoramic view

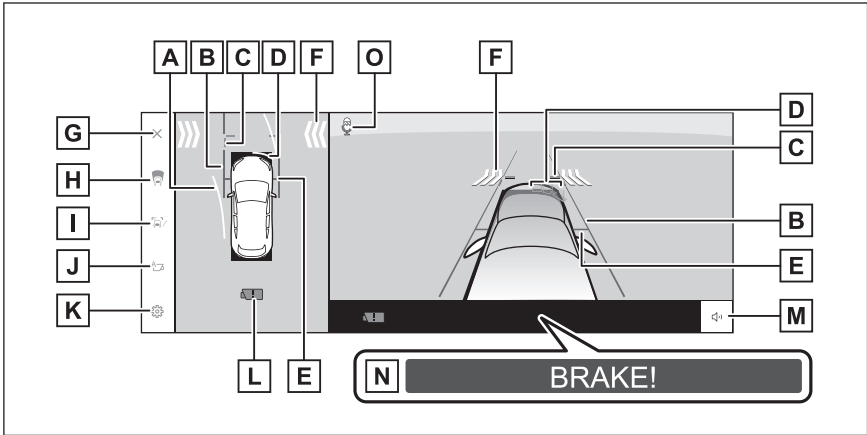

Cornering view & panoramic view

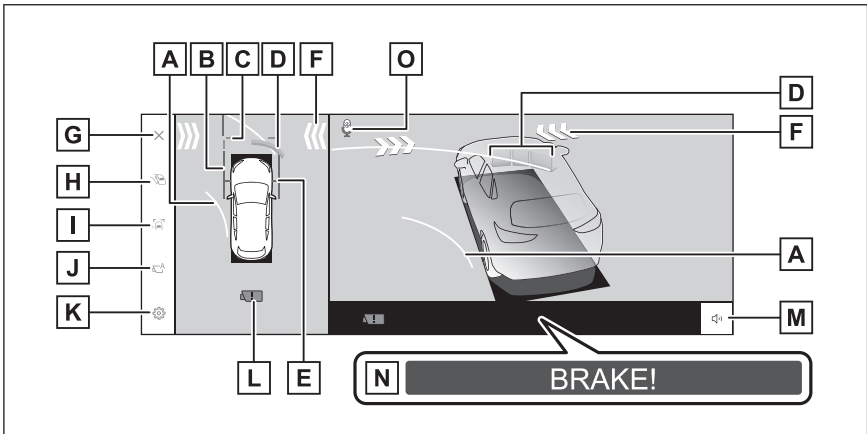

A Forward estimated course lines

Displays course lines that are linked to operation of the steering wheel. (Yellow)

These lines are displayed when the steering wheel is turned more than 90 degrees from the straight position.

B Vehicle width guide lines

Shows guide lines of the vehicle's width including the outside rear view mirrors.

C Front distance guide lines

Displays about 3 ft. (1 m) in front of the vehicle.

D Intuitive parking assist

Displays an indicator on the screen and sounds a buzzer when an object is detected by a sensor. (For details about the intuitive parking assist, see the "OWNER'S MANUAL".)

8-2. Panoramic view monitor

E Front tire guide lines

Displays the position of the front tires.

F FCTA (Front Cross Traffic Alert)

If FCTA detects nearby vehicles and/or obstacles from the front or rear of the vehicle, an indicator is displayed on the screen.

G Screen off button

Turns off the camera screen and returns the previous screen, such as the navigation.

H Display mode switching button

Switches display mode every time touch the button.

I Guide line switching button

Switches guide line mode every time touch the button.

J Automatic display button

Turns the auto display mode on or off. When the shift position is in "D" or "N", wide front view & panoramic view or clearance view/cornering view & panoramic view will be automatically displayed in accordance with the vehicle speed.

K Customize settings button

Changes settings, such as the automatically display cornering view, the vehicle body color, the intuitive parking assist detection distance.

L Camera dirt detection icon

This icon is displayed when dirt is detected on the camera.

M Intuitive parking assist mute button

This button temporarily mutes the intuitive parking assist sound.

N PKSBS (Parking Support Brake)

If an obstacle that you may collide with is detected, a message is displayed on the screen. (For details about PKSBS (Parking Support Brake), see the "OWNER'S MANUAL".)

O Voice recognition icon

This icon is displayed when the Intelligent Assistant is in operation.

 **INFORMATION**

- When the intuitive parking assist is turned on, you can display side clearance view & panoramic view/cornering view. (For details about the intuitive parking assist, see the "OWNER'S MANUAL".)
- The display position of the intuitive parking assist may not match the position of the obstacle displayed in the camera image.

⚠ WARNING

- The position of the guide lines displayed on the screen may change due to factors such as number of passengers, load capacity, and road gradient. Always make sure to visually check behind you and your surroundings while you are driving.
- The intuitive parking assist and FCTA displays are overlapped and displayed on the camera image, so it may be difficult to see depending on the brightness of the surroundings and colors.

Related Links

[Changing the guide line display mode\(P. 255\)](#)

[Auto display mode\(P. 256\)](#)

[Changing the panoramic view monitor settings\(P. 272\)](#)

Changing the guide line display mode

The guide line display mode changes every time the guide line display mode button is touched.

■ Distance guide lines mode

Displays about 3 ft. (1 m) in front of the vehicle. (blue)

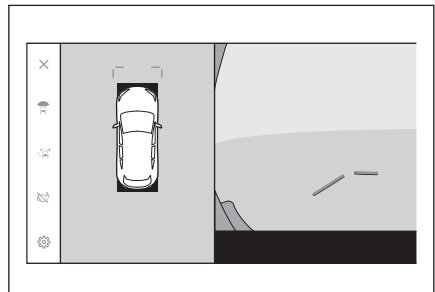
**■ Estimated course lines mode**

Displays course lines that are linked to operation of the steering wheel. (Yellow)
These lines are displayed when the steering wheel is turned more than 90 degrees from the straight position.

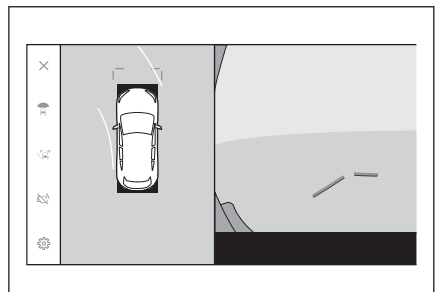

Auto display mode

Although you can display wide front view & panoramic view and side clearance view & panoramic view/cornering view by pressing the camera switch, you can also set auto display mode to display the views automatically in accordance with the vehicle speed.

- Touching the automatic display button [] turns on auto display mode.
- Turning on auto display mode automatically displays the views in the following situations:
 - When the shift position is in "D" or "N"
 - The vehicle decelerates to less than 6 mph (10 km/h) (the shift lever is in any position other than "R")

Cornering view auto display

You can set the cornering view auto display mode to automatically display cornering view & panoramic view in accordance with the operation of the steering wheel.

- Turning on cornering view auto display mode automatically displays cornering view in the following situations:
 - When the shift position is in "D" or "N"
 - The vehicle decelerates to less than 6 mph (10 km/h)
 - When the steering wheel is turned by 180 degrees or more from the center (straight-line) position

INFORMATION

You can change cornering view auto mode in the custom settings.

Related Links

[Changing the panoramic view monitor settings\(P. 272\)](#)

Intuitive parking assist linked display

Depending on the intuitive parking assist detection state, wide front view & panoramic view/Side clearance view/Cornering view & panoramic view will be displayed.

- The views are displayed automatically when the intuitive parking assist detects an obstacle (when the shift position is in "D" or "N").
- The display returns to the previous screen automatically when the intuitive parking assist stops detecting an obstacle.

INFORMATION

- Press the camera switch while the screen is displayed to return to the original screen.
- If the panoramic view monitor screen is canceled when an obstacle is detected, the panoramic view monitor screen can be displayed again by touching the intuitive parking assist mark shown on the multimedia system screen.

Using the vehicle width guide lines

Side clearance view & panoramic view

- Check the positional relationship between the vehicle width guide lines and an obstacle.
- Turn the steering wheel and drive forward so that the vehicle width guide lines do not overlap the actual obstacle.

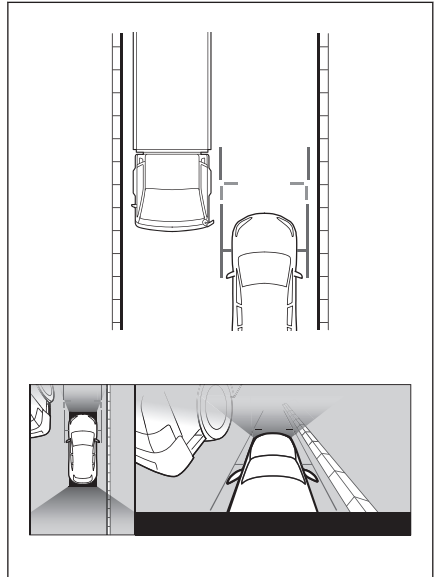

8-2. Panoramic view monitor

- Check the positional relationship between the vehicle width guide lines and an object such as curbs on the shoulder of a road.
- Pull the vehicle over so that the vehicle width guide lines do not overlap the obstacle as shown in the figure.
- By driving with the vehicle width guide lines parallel to the object, you can park alongside the object.

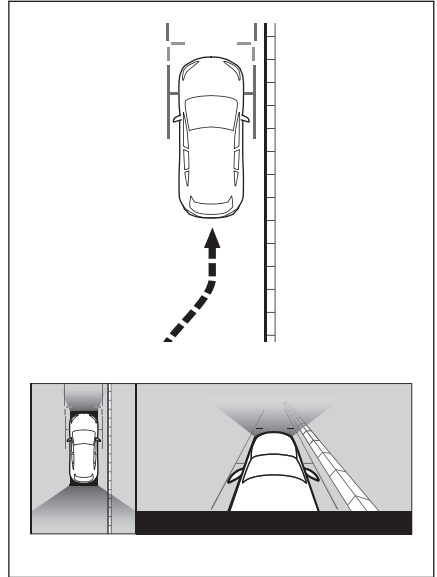

Using the forward estimated course lines

■ Cornering view & panoramic view

- Check the positional relationship between the forward estimated course lines and an obstacle.
- Turn the steering wheel and drive forward so that the forward estimated course lines do not overlap the actual obstacle.

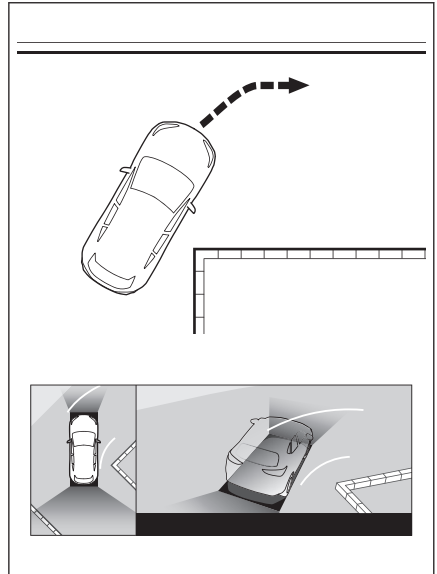

Display mode when the shift position is in "R"

To check for safety when parking the vehicle, an image is displayed from above the vehicle and from the rear camera.

1. Shift the shift position to "R".

- The mode changes every time you touch the display mode switching button.

■ Rear view & panoramic view

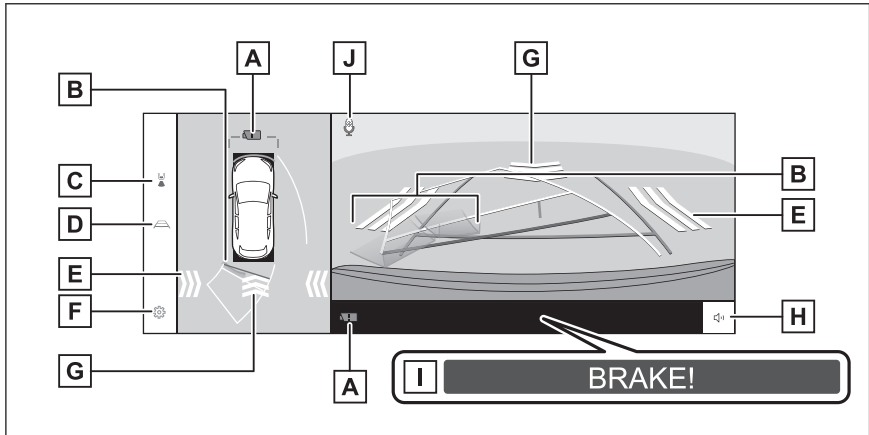

■ Wide rear view & panoramic view

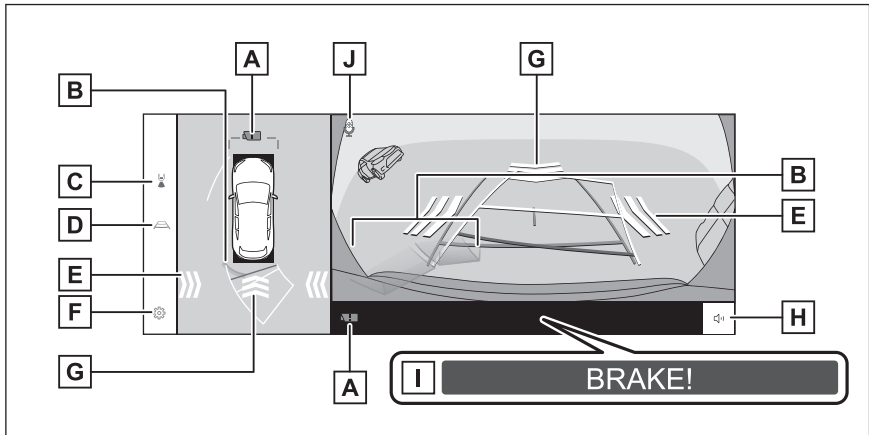

A Camera dirt detection icon

This icon is displayed when dirt is detected on the camera.

B Intuitive parking assist

Displays an indicator on the screen and sounds a buzzer when an object is detected by a sensor. (For details about the intuitive parking assist, see the "OWNER'S MANUAL".)

8-2. Panoramic view monitor

C Display mode switching button

Switches display mode every time touch the button.

D Guide line switching button

Switches guide line mode every time touch the button.

E RCTA (Rear Cross Traffic Alert)/RCD (Rear Camera Detection)

In the following situations, an indicator is displayed on the screen.

- When the rear radar detects a vehicle that is approaching from the rear or an object.
- When the rear camera detection function detects a pedestrian in the rear.

(For details about RCTA (Rear Cross Traffic Alert)/RCD (Rear Camera Detection), see the "OWNER'S MANUAL".)

F Customize settings button

Changes settings, such as the automatically display cornering view, the vehicle body color, the intuitive parking assist detection distance.

G RCD (Rear Camera Detection)

If the rear camera detects a pedestrian behind the vehicle, an indicator is displayed on the screen. (For details about RCD (Rear Camera Detection), see the "OWNER'S MANUAL".)

H Intuitive parking assist/RCTA (Rear Cross Traffic Alert)/RCD (Rear Camera Detection) mute button

This button temporarily mutes the intuitive parking assist/RCTA (Rear Cross Traffic Alert)/RCD (Rear Camera Detection) sound.

I PKSB (Parking Support Brake)

If an obstacle that you may collide with is detected, a message is displayed on the screen. (For details about PKSB (Parking Support Brake), see the "OWNER'S MANUAL".)

J Voice recognition icon

This icon is displayed when the Intelligent Assistant is in operation.

 **INFORMATION**

- Pressing the camera switch when the shift position is in "R" enables you to change to panoramic view & wide front view.
- The display position of the intuitive parking assist may not match the position of the obstacle displayed in the camera image.

⚠ WARNING

- The position of the guide lines displayed on the screen may change due to factors such as number of passengers, load capacity, and road gradient. Always make sure to visually check behind you and your surroundings while you are driving.
- The intuitive parking assist, RCTA and RCD displays are overlapped and displayed on the camera image, so it may be difficult to see depending on the brightness of the surroundings and colors.

Related Links

[Changing the guide line display mode\(P. 261\)](#)

[Auto display mode\(P. 256\)](#)

[Changing the panoramic view monitor settings\(P. 272\)](#)

Changing the guide line display mode

The guide line display mode changes every time you touch the guide line switching button.

■ Estimated course lines mode

This mode displays estimated course lines that move in accordance with the operation of the steering wheel.

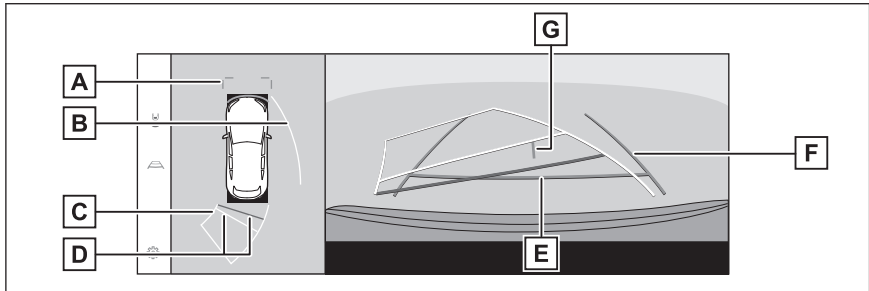

- A** Front distance guide lines
Displays about 3 ft. (1 m) (blue) in front of the vehicle.
- B** Side estimated course lines
Displays course lines (yellow) that are linked to operation of the steering wheel.
- C** Reverse estimated course lines
Displays course lines (yellow) that are linked to operation of the steering wheel.
- D** Rear distance guide lines
Displays the distance behind the vehicle.
- The distance guide line is linked to the estimated course lines.

8-2. Panoramic view monitor

- Displays about 1.5 ft. (0.5 m) (red) and 3 ft. (1 m) (yellow) from the center of the end of the rear bumper.

E Rear distance guide line

Displays about 1.5 ft. (0.5 m) (blue) from the end of the rear bumper.

F Vehicle width guide lines

Displays course lines when the vehicle is being reversed in a straight line.

- The lines are wider than the actual width of the vehicle.
- When the vehicle is straight, the guide lines will overlap with the estimated course lines.

G Vehicle center guide line

Displays the center of the vehicle width guide lines.

■ Parking assist guide lines mode

This mode displays the steering wheel return points (parking assist guide lines). This mode is recommended for those who have a sense of the vehicle and can park the vehicle without the aid of the estimated course lines.

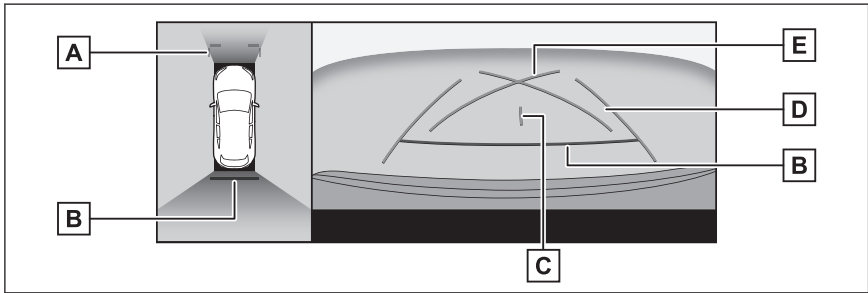

A Front distance guide lines

Displays about 3 ft. (1 m) (blue) in front of the vehicle.

B Rear distance guide lines

Displays the distance behind the vehicle.

- Displays about 1.5 ft. (0.5 m) (red) from the center of the end of the rear bumper.

C Vehicle center guide line

Displays the center of the vehicle width guide lines.

D Vehicle width guide lines

Displays course lines when the vehicle is being reversed in a straight line.

- The lines are wider than the actual width of the vehicle.

E Parking assist guide lines

Displays the course lines of the smallest turn possible behind the vehicle.

- Use the position of operating the steering wheel when parking as a guide.

■ Distance guide lines mode

This mode only displays the distance guide lines. It is recommended for those who do not need the guide lines.

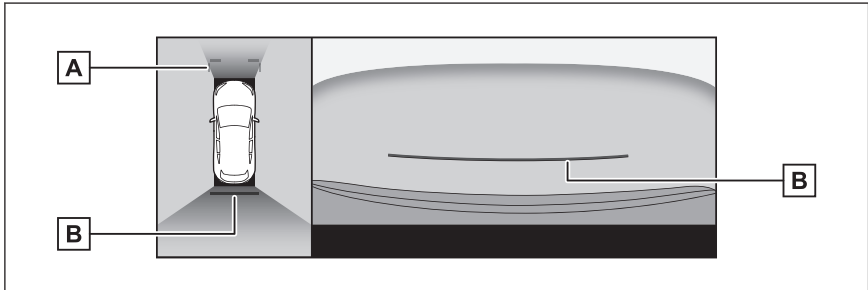

A Front distance guide lines

Displays about 3 ft. (1 m) (blue) in front of the vehicle.

B Rear distance guide lines

Displays the distance behind the vehicle.

- Displays about 1.5 ft. (0.5 m) (red) from the center of the end of the rear bumper.

■ Estimated course center line mode

This mode displays estimated course lines and a vehicle center guide line that move in accordance with the operation of the steering wheel.

Use this mode when approaching a signpost or pole with the center of the rear bumper.

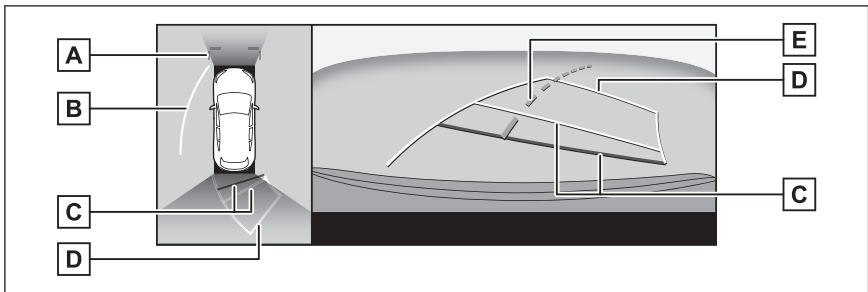

A Front distance guide lines

Displays about 3 ft. (1 m) (blue) in front of the vehicle.

B Side estimated course lines

Displays course lines (yellow) that are linked to operation of the steering wheel.

C Rear distance guide lines

Displays the distance behind the vehicle.

- The distance guide line is linked to the estimated course lines.

8-2. Panoramic view monitor

- Displays about 1.5 ft. (0.5 m) (red) and 3 ft. (1 m) (yellow) from the center of the end of the rear bumper.

D Reverse estimated course lines

Displays course lines (yellow) that are linked to operation of the steering wheel.

E Estimated course center line

Displays the vehicle center guide line (green) that is linked to operation of the steering wheel.

INFORMATION

The guide lines will not be displayed if the back door is not closed. If the back door is closed but the guide lines are still not displayed, have the vehicle inspected by your Lexus dealer.

WARNING

The rear vehicle width guide lines are wider than the actual width of the vehicle. Always make sure to visually check behind you and your surroundings when you are reversing.

Parking using the estimated course lines mode

- 1 Shift the shift position to "R".
- 2 Turn the steering wheel so that the estimated course lines are within the parking space and then reverse slowly.

A Parking space

B Estimated course lines

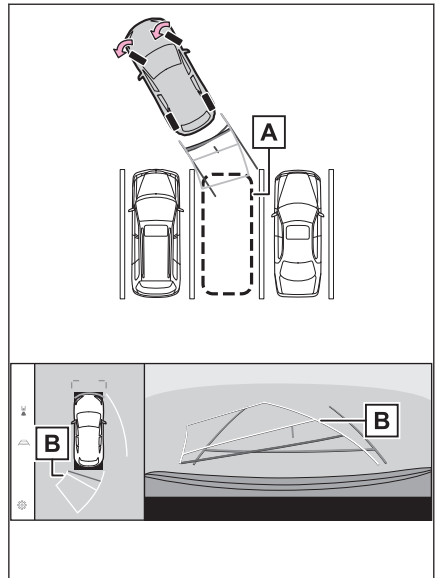

- 3 When the rear of the vehicle has entered the parking space, turn the steering wheel so that the vehicle width guide lines are within the left and right dividing lines of the parking space.

A Vehicle width guide lines

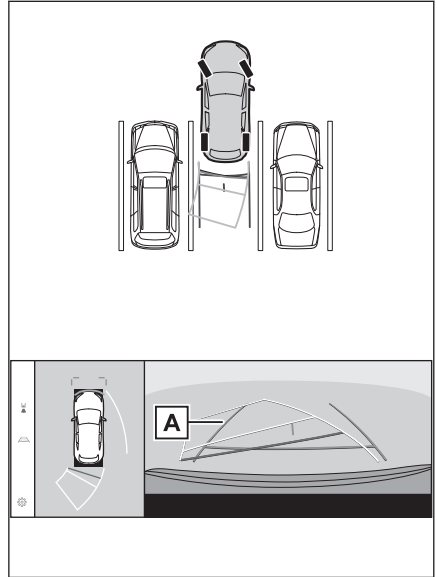

- 4 Once the vehicle width guide lines and the parking space lines are parallel, straighten the steering wheel and reverse slowly until the vehicle has completely entered the parking space.
- 5 Stop the vehicle in an appropriate place to finish parking.

Parking using the parking assist guide lines mode

- 1 Shift the shift position to "R".

- 2 Reverse until the parking assist guide lines align with the left-hand dividing line of the parking space.

- A Parking assist guide lines
- B Parking space dividing line

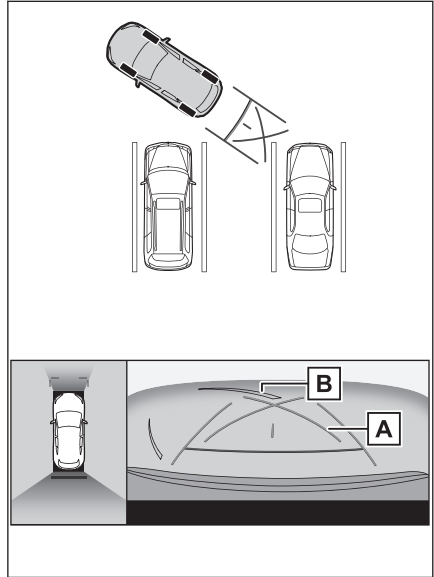

- 3 Turn the steering wheel all the way to the left, and reverse slowly.
- 4 Once the vehicle is parallel with the parking space, straighten the steering wheel and reverse slowly until the vehicle has completely entered the parking space.
- 5 Stop the vehicle in an appropriate place to finish parking.

The screen when the outside rear view mirrors are folded

When the outside rear view mirrors are folded, an image from the side cameras rather than panoramic view will be displayed. This can assist you in confirming that the vicinity of the vehicle is safe when you are parking in a narrow place.

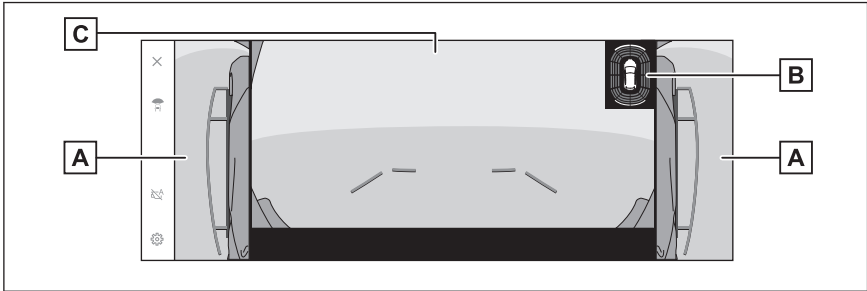

A Side views

B Intuitive parking assist

Displays an indicator on the screen and sounds a buzzer when an object is detected by a sensor. (For details about the intuitive parking assist, see the "OWNER'S MANUAL".)

C Front view/Rear view/Wide rear view

INFORMATION

The display position of the intuitive parking assist may not match the position of the obstacle displayed in the camera image.

Zooming in on the screen

Zooming in on the screen can be done if the image on the screen is too small and hard to see.

Touch the area that you want to zoom in on the panoramic view or wide front view.

► Panoramic view (14-inch display)

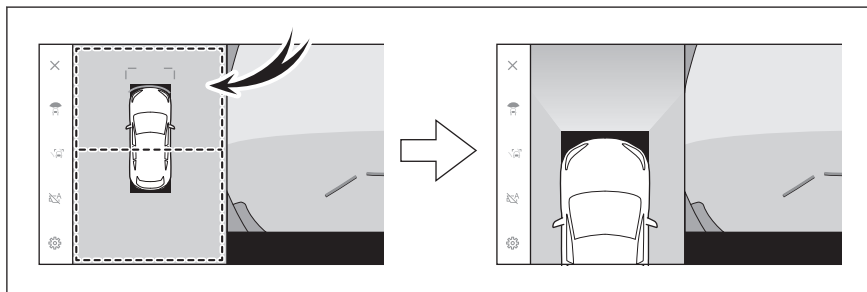

► Panoramic view (9.8-inch display)

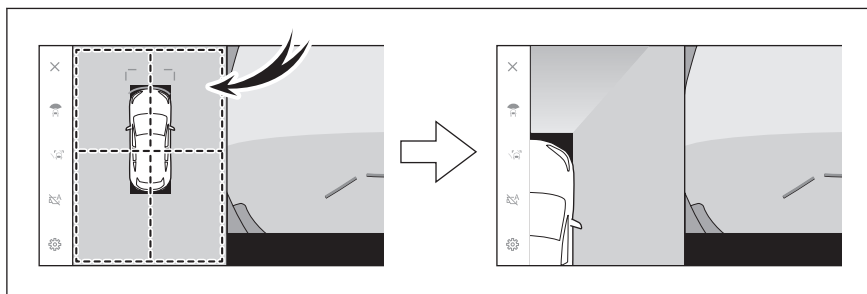

► Wide front view (9.8-inch display)

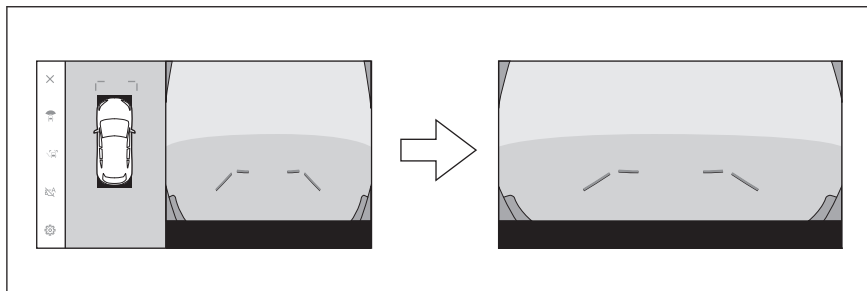

- The selected area is zoomed in on.
- In panoramic view, you can zoom in one of the two places in front or rear of the vehicle (or one of the four places in front right/left or rear right/left of the vehicle*1).
- To cancel the zoom, touch the screen again.

 **INFORMATION**

- The zoom feature is enabled when all of the following conditions are met:
 - The vehicle speed is below 7 mph (12 km/h)
 - The intuitive parking assist is turned on
- In any of the following situations, the zoom feature will be canceled automatically:
 - The vehicle speed is above 7 mph (12 km/h)
 - The intuitive parking assist is turned off
- The guide lines will not be displayed when the panoramic view is zoomed.

Displaying transparent underfloor vision

A composite of camera vision captured in the past from the current vehicle position to assist understanding of the situation under the vehicle, tire positions, and so on can be displayed. The vision is displayed in panoramic view, side clearance view, or cornering view.

Transparent underfloor vision is displayed when the setting on the customized setting screen is turned on and the vehicle is moving forward or backward.

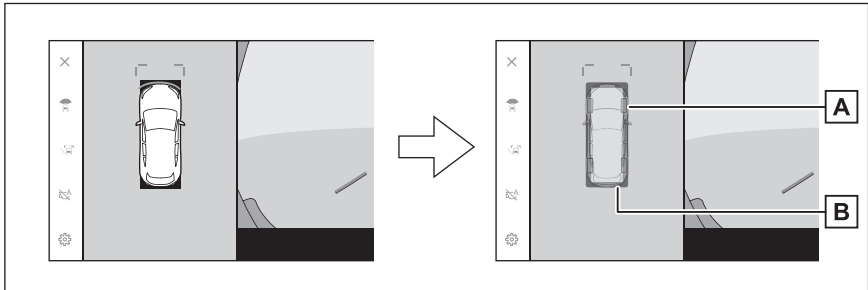

A Tire tracks

Displays the tire position guides linked to the steering wheel.

B Vehicle guide lines

Displays the exterior of the vehicle.

INFORMATION

- Transparent underfloor vision is not displayed in the following cases:
 - The vehicle speed is above 7 mph (12 km/h)
 - The vehicle stops and a certain amount of time passes
 - If the vehicle does not move a certain distance after it is started
 - The side mirrors are folded
 - ABS is operating
 - The system is not functioning correctly
- The system may not function correctly in the following situations:
 - Snow covered roads
 - There are shadows from lights and so forth
 - There is dirt or a foreign object on the camera lens
 - Water (river, sea, etc.)
 - Optional equipment has been installed
 - There is an obstacle in front of the camera

- The tires were replaced
- The back door is open and the camera is not in the correct position
- The road surface is slippery or the wheels slip
- The vehicle is on a hill or other steep roads
- As vision that was captured in the past is being displayed, the screen and the actual situation may differ in the following cases:
 - An obstacle appears or moves after vision is captured
 - Sand or snow crumbles and moves after vision is captured
 - Mud or puddles are in the display range
 - When the vehicle slips
- Part or all of the transparent underfloor vision may appear black in the following cases:
 - The vehicle starts moving with no captured vision
 - The steering wheel is turned more than a certain angle
 - The vehicle stops and a certain amount of time passes

▲ WARNING

- The tire and vehicle guide lines may not align correctly with the actual vehicle position due to the number of passengers, vehicle load, road gradient, road surface conditions, brightness of the surroundings, optional equipment, tire replacements, and other reasons. Always make sure to check your surroundings while you are driving.
- Displayed vision is vision that was captured in the past. Therefore, if obstacles and other objects move after being captured, the transparent underfloor vision and the actual situation may not always match.

Related Links

[Changing the panoramic view monitor settings\(P. 272\)](#)

Changing the panoramic view monitor settings

Settings related to panoramic view monitor such as the cornering view auto display and vehicle body color can be changed.

1 Touch [].

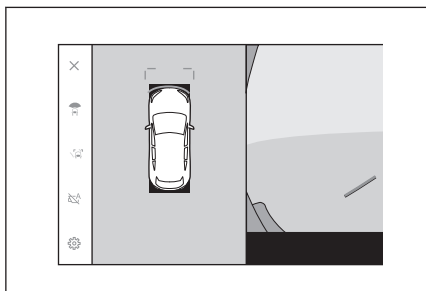

2 Select the desired item.

- [Cornering View]

Enable or disable the automatic display of the cornering view.

- [View Under Vehicle]

Turn the transparent underfloor vision display setting on or off. Setting it to on and moving the vehicle forward or backwards displays a composite of camera vision captured in the past from the current vehicle position to assist understanding of the situation under the vehicle, front tire positions, and so on. The vision is displayed in panoramic view, side clearance view, or cornering view.

- [LEXUS Park Assist 3D Display]

Show or hide the intuitive parking assist 3D display

- [LEXUS Park Assist Distance]

Change the distance that the intuitive parking assist starts detecting obstacles.

- [Vehicle Body Color]

Change the vehicle body color displayed on the screen.

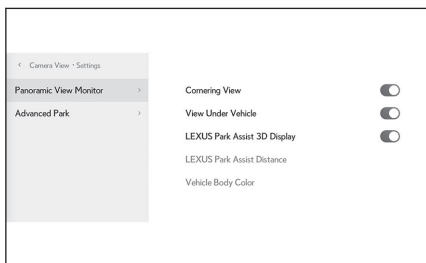

INFORMATION

For safety purposes, you cannot display the custom settings screen while the vehicle is moving.

Related Links

[Changing the body color\(P. 273\)](#)

Changing the body color

Change the vehicle body color displayed on the screen.

- 1 Touch [Vehicle Body Color].
- 2 Select the desired body color.
- 3 Touch [OK].

Changing the intuitive parking assist detection distance

Change the distance that the intuitive parking assist starts detecting obstacles.

- 1 Touch [LEXUS Park Assist Distance].
- 2 Select the distance at which you want to start detecting objects.
- 3 Touch [OK].

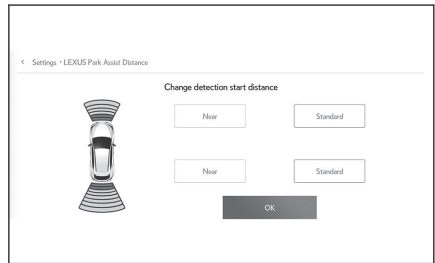

Precautions for the panoramic view monitor

Always make sure to visually check behind you and your surroundings while driving. If not, collision with other vehicles or an unforeseen accident may occur. Follow the below precautions when using the panoramic view monitor.

WARNING

- Never depend on the panoramic view monitor entirely. Always make sure to visually check behind you and your surroundings as you would when driving any other vehicle. In particular, be careful not to collide with vehicles parked nearby or other objects.
- Always make sure to visually check behind you and your surroundings while you are driving.
- Never drive while looking only at the screen. The image on the screen may be different to the actual conditions. Moreover, there is a limit to the range of image that the camera can capture. Never turn or reverse only looking at the screen. Doing so may result in a collision with another vehicle or some other unforeseen accident. Be sure to visually check the vehicle's surroundings and use the vehicle's rear-view and side mirrors.
- The position of the guide lines displayed on the screen may change due to factors such as number of passengers, load capacity, and road gradient. Always make sure to visually check behind you and your surroundings while you are driving.
- Do not use the panoramic view monitor in the following cases:
 - On icy or slick road surfaces, or in snow
 - When using tire chains or emergency tires
 - When the front door(s) or back door are not closed completely
 - On roads that are not flat, such as hills
 - If the tires of a size other than specified by Lexus are installed
 - If the suspension has been modified
 - If a non-Lexus product is installed on the area displayed on the screen
- In low external temperatures, the screen may darken or the image may become faint. The image could distort when the vehicle is moving, or you may not be able to see the image on the screen, so always visually check your surroundings while you are driving.
- If you replace your tires, the position of the guide lines displayed on the screen may be incorrect.

NOTICE

- See-through view, moving view, panoramic view, side clearance view, and cornering view produce an image that is a composite of images captured by the front camera,

⚠ NOTICE

rear camera, and side cameras. As there is a limit to the displayable range and content, make sure you fully understand the features of the panoramic view monitor before you use it.

- The four corners of the see-through view, moving view, panoramic view, side clearance view, and cornering view have a video composition processing region centered on borders of the cameras, and image clarity may decline. However this is not a fault.
- Depending on lighting conditions near each camera, bright and dark patches may appear on the see-through view, moving view, panoramic view, side clearance view, and cornering view.
- See-through view, moving view, panoramic view, side clearance view, and cornering view does not extend higher than the installation position and image capture range of each camera.
- There are blind spots around the vehicle and as such there are regions not displayed on the panoramic view monitor.
- Three-dimensional objects displayed in wide front view, rear view, wide rear view or side view may not be displayed in see-through view, moving view, panoramic view, side clearance view, and cornering view.
- People and other three-dimensional obstacles may appear differently when displayed on the panoramic view monitor. (These differences include cases in which displayed objects appear to have fallen over, disappear near image processing regions, appear from video composition processing areas, or when the actual distance to an object differs from the displayed position.)
- When the back door, which is equipped with the rear camera, or front doors, which are equipped with side mirrors that have the built-in side cameras, are open, images will not be displayed properly on the panoramic view monitor.
- The vehicle icon displayed in see-through view, moving view, panoramic view, side clearance view, and cornering view is a computer generated image, so the color, shape and size will differ from the actual vehicle. Therefore, nearby three-dimensional objects may appear to be touching the vehicle, and actual distances to three-dimensional objects may differ from those displayed.
- The camera may not function correctly and the image may be displayed on the screen in the following manner:
 - When the shift position is in "R", part or all of the screen may appear black
 - When the shift position is in "R", the screen may not change to the camera image
 - The guide lines are not displayed on the camera image, and attention symbols and caution notices are displayed

Area displayed on the screen

There are blind spots around the vehicle and as such there are regions not displayed on the screen. Even if nothing around the vehicle is displayed on the screen, there may actually be obstacles on the road, which you may collide with. Always make sure to visually check your surroundings.

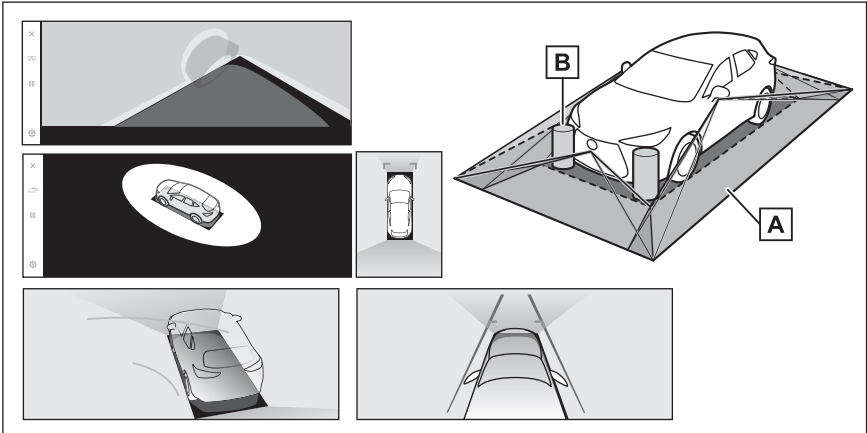

A Area displayed on the screen

B Objects not displayed on the screen

Objects in the black areas do not appear on the screen.

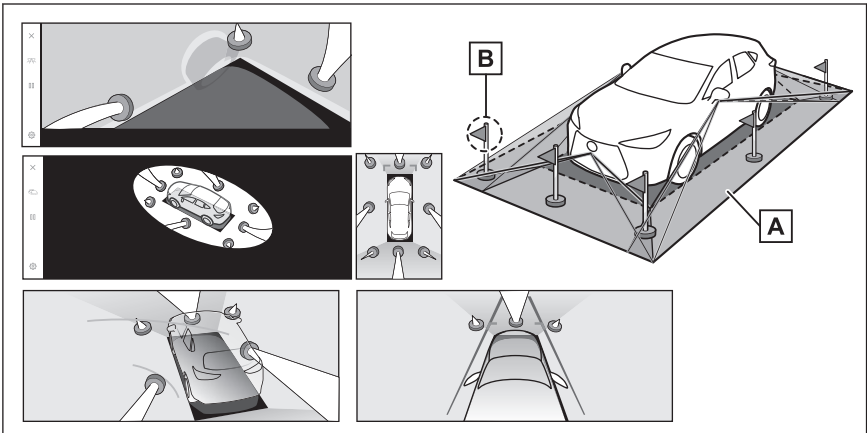

A Area displayed on the screen

B Parts of objects not displayed on the screen

Parts higher than the road do not appear on the screen.

INFORMATION

- The black parts around the vehicle icon are not displayed by the camera. Visually check those areas.
- As the images are obtained from four cameras are processed and displayed on the standard of a flat road surface, see-through view, moving view, panoramic view (including zoomed display), side clearance view, and cornering view may be displayed as follows:
 - Objects may look collapsed; thinner or bigger than usual.
 - An object with a higher position than the road surface may look further away than it actually is or may not appear at all.
 - Tall objects may appear protruding from the non-displayed areas of the image.
- Variations in the brightness of the image may appear for every camera due to lighting conditions.
- The displayed image may be misaligned due to inclination of the vehicle body or change in vehicle height caused by the number of passengers, vehicle load, and quantity of fuel.
- If the doors are not completely closed, the image and the guide lines may not be displayed correctly.
- The positional relationship of the road surface and objects with the vehicle icon displayed on see-through view, moving view, panoramic view (including zoomed display), side clearance view, and cornering view may differ to the actual positions.
- Images indicated by [○] in the figure are a composite, and hence some areas may be difficult to see.

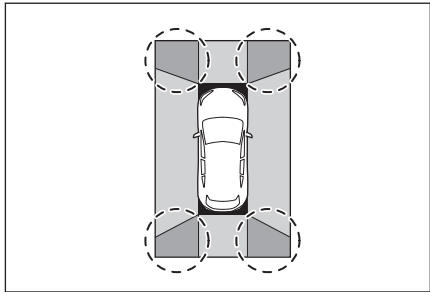

■ Wide front view

- A Area displayed on the screen
- B Objects not displayed on the screen

Areas close to both corners of the bumper will not appear on the screen.

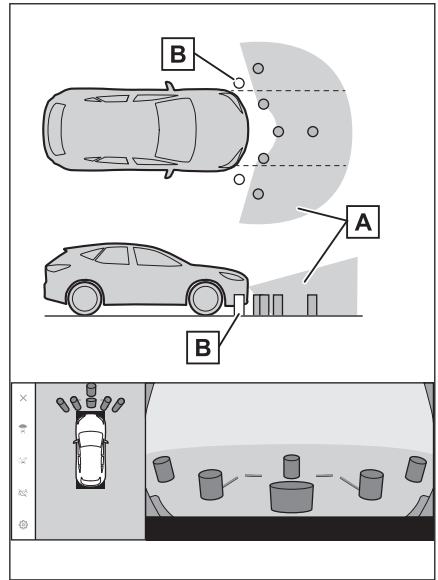

□ INFORMATION

- The area covered by the camera is limited. Objects that are close to either corner of the bumper or under the bumper cannot be displayed on the screen.
- The depth perception of the image displayed on the screen differs to the actual distance.
- The wide front view camera uses a special lens, so the depth perception of the image displayed on the screen differs to the actual distance.

■ Both side views (when the side mirrors are folded)

A Area displayed on the screen

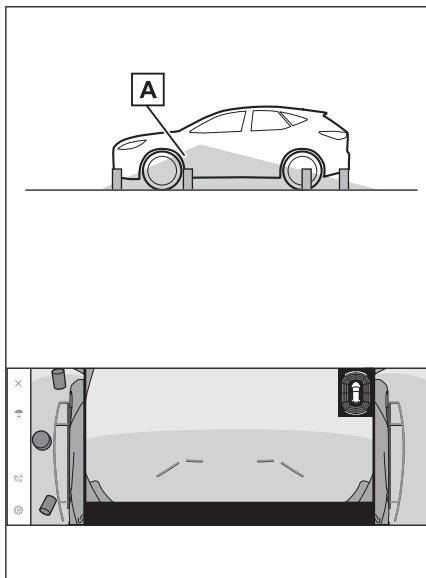

☐ INFORMATION

- The range that is displayed on the screen may differ due to the state of the vehicle and road surface.
- The area covered by the camera is limited. Objects that are close to the bumper on the passenger's side or under the bumper cannot be displayed on the screen.
- The depth perception of the image displayed on the screen differs to the actual distance.
- The cameras on both side views use a special lens, so the depth perception of the image displayed on the screen differs to the actual distance.

■ Rear view

- A** Area displayed on the screen
- B** Objects not displayed on the screen

Areas close to both corners of the bumpers will not appear on the screen.

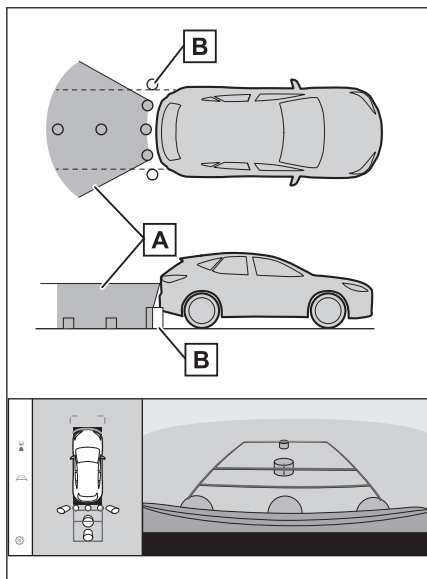

■ Wide rear view

- A** Area displayed on the screen
- B** Objects not displayed on the screen

Areas close to both corners of the bumpers will not appear on the screen.

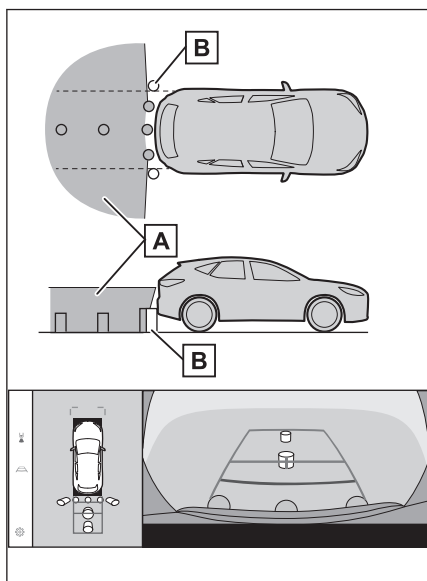

□ INFORMATION

- The range that is displayed on the screen may differ due to the state of the vehicle and road surface.

- The area covered by the camera is limited. Objects that are close to either corner of the bumper or under the bumper cannot be displayed on the screen.
- The depth perception of the image displayed on the screen differs to the actual distance.
- The rear view and wide rear view cameras use a special lens, so the depth perception of the image displayed on the screen differs to the actual distance.
- Objects that are higher than the rear camera may not appear in the monitor.

Camera position

The panoramic view monitor cameras are in the locations shown in the figures.

■ Front camera

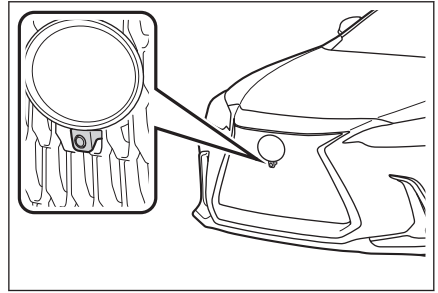

■ Side cameras

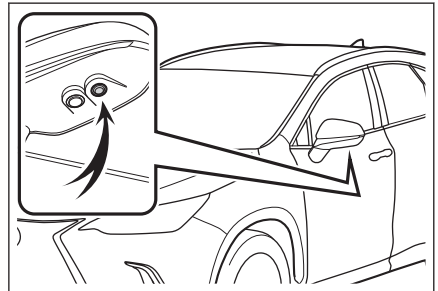

■ Rear camera

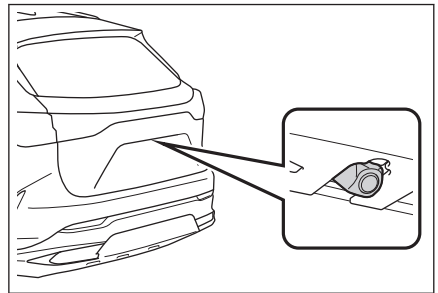

Cleaning the camera

If dirt or foreign matter, such as water droplets, snow, or mud, has stuck to the camera, you will not be able to see the image clearly. If that happens, splash the camera with a large amount of water and then wipe the camera lens clean with a soft, damp cloth.

⚠ NOTICE

- The panoramic view monitor may stop functioning correctly. Take note of the following items:
 - Do not hit or apply a forceful impact on the camera. Doing so may change the position and mounting angle of the camera.
 - The camera is designed to be waterproof. Do not detach, disassemble, or modify it.
 - When washing the camera lens, splash the camera with a large amount of water and then wipe the camera lens clean with a soft, damp cloth. Rubbing the camera lens forcibly may scratch the camera lens and you may no longer be able to see images clearly.
 - The camera cover is made of resin. Do not allow an organic solvent, car wax, window cleaner, or glass coating to adhere to the camera. If this happens, wipe it off immediately.
 - Do not pour hot water on the vehicle in cold weather or apply other rapid changes of temperature.
 - If you wash the vehicle with a high pressure car washer, do not point the hose directly at the camera or camera area. Applying strong water pressure may result in the camera malfunctioning.
- If the camera is hit, it may cause a camera malfunction. If this happens, have the vehicle inspected by your Lexus dealer as soon as possible.

■ Cleaning the rear camera with washer fluid

Dirt on the rear camera lens can be cleaned by operating the dedicated camera cleaning washer. For details, refer to "OWNER'S MANUAL".

- When cleaning the camera, it may be difficult to see the image due to the washer fluid. When backing up, be sure to visually check all around the vehicle both directly and using the mirrors before proceeding.
- If washer fluid remains on the camera lens surface after cleaning, the image may be difficult to see at night due to the height or inclination of the headlights of the vehicle behind.
- Some dirt may not be removed completely after cleaning. In this case, rinse the camera lens with a large quantity of water and then wipe it clean with a soft cloth dampened with water.
- Washer fluid is sprayed onto the camera lens surface. Therefore, the ice, snow, etc. adhering around the camera cannot be removed.

NOTICE

Do not strike or hit the washer nozzle or subject it to a strong impact, as the washer nozzle installation position and angle may be changed.

Parking assist lights

The parking assist lights of the panoramic view monitor system are installed in the locations shown in the figure.

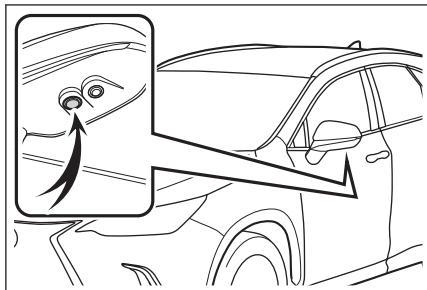

NOTICE

- Make sure to observe the following precautions, otherwise the panoramic view monitor system may not operate correctly:
 - Do not apply excessive force to a light or subject it to a strong impact. Doing so may cause the position or installation angle of the light to deviate.
 - Do not remove, disassemble, or modify the lights as they have a waterproof construction.
 - When cleaning the lights, wash them with a large amount of water, and then wipe them with a soft wet cloth.
 - Do not apply organic solvents, waxes, oil removing solvents, glass coatings, etc. to the covers of the lights, as they are made of resin. If such is applied, remove it immediately.
 - Do not expose the lights to sudden temperature changes, such as applying hot water to them when it is cold.
 - When washing the vehicle with a high-pressure washer, do not spray water directly on the lights or their surrounding area. High-pressure water can damage the lights and cause them to not operate correctly.
- If a light has been subjected to a strong impact, it may be damaged. Have the vehicle inspected by your Lexus dealer as soon as possible.

Differences between the screen and the actual road

The composite images on the panoramic view monitor and guide lines give a distance guide for road surfaces. Therefore, there is a margin of error between the guide lines on the screen and the actual distance and course on the road.

■ When the ground behind the vehicle slopes up sharply

The distance guide lines will appear to be closer to the vehicle than the actual distance. Thus, objects on up-slopes will appear to be farther away than they actually are. In the same way, there will be a margin of error between the guidelines and the actual distance and course on the road.

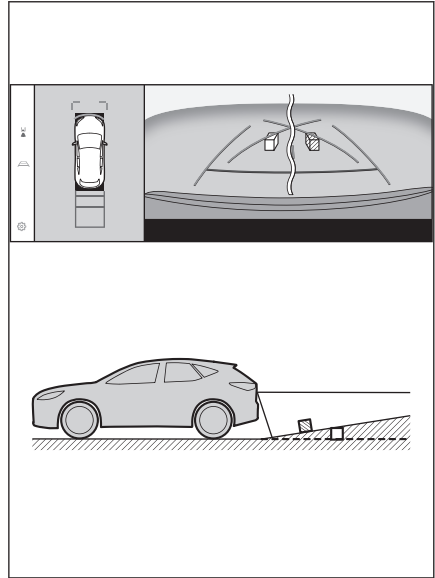

■ **When the ground behind the vehicle slopes down sharply**

The distance guide lines will appear to be further from the vehicle than the actual distance. Thus, objects on down-slopes will appear to be closer than they actually are. In the same way, there will be a margin of error between the guidelines and the actual distance and course on the road.

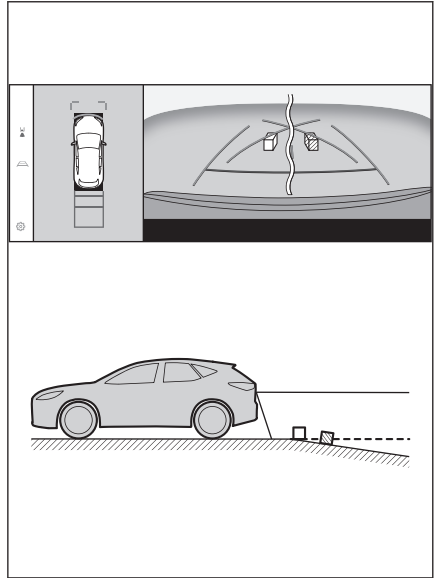

■ **When any part of the vehicle sags**

When any part of the vehicle sags due to the number of passengers or the distribution of the load, there is a margin of error between the guide lines on the screen and the actual distance and course on the road.

A Margin of error

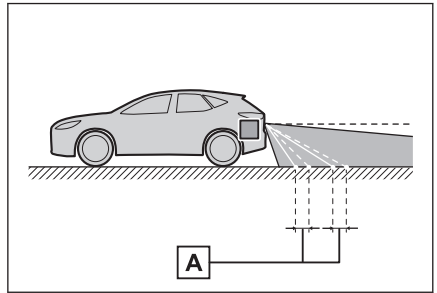

■ **Estimated course center line**

As the guide lines are shown midair near the rear bumper, there are times that they may look like they are off-center.

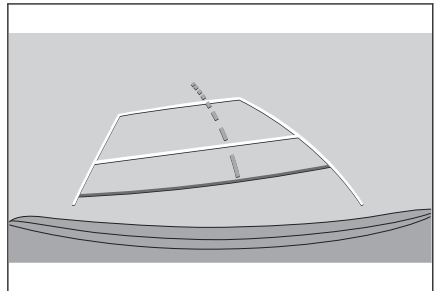

Differences between the screen and actual 3D objects

Since the guide lines and displayed on the screen are displayed for a flat road surface, it is not possible to determine the position of three-dimensional objects. When approaching a three-dimensional object that extends outward (such as the flatbed of a truck), take note of the following cautions.

⚠ WARNING

When the intuitive parking assist display is red, make sure to visually check before moving the vehicle any further. There is the danger that you may collide with another vehicle or have some other unforeseen accident.

■ Displaying panoramic view (including zoom display)

On the screen, it appears that there is a gap between the vehicle's bumper and another object or vehicle, and it does not look as if the vehicle will collide with the object or vehicle. However, the vehicle is over the course lines, so the vehicle may collide with the object or vehicle. Make sure to visually check your surroundings.

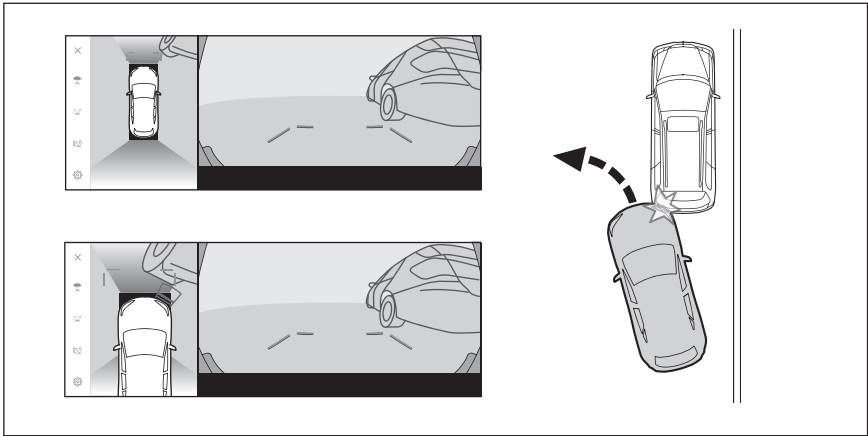

■ **Estimated course lines**

- On the screen, it appears that the vehicle's bumper is outside of the estimated course lines, and it does not look as if the vehicle will collide with the object or vehicle. However, the vehicle is over the course lines, so the vehicle may collide with the object or vehicle. Make sure to visually check your surroundings.

A Estimated course lines

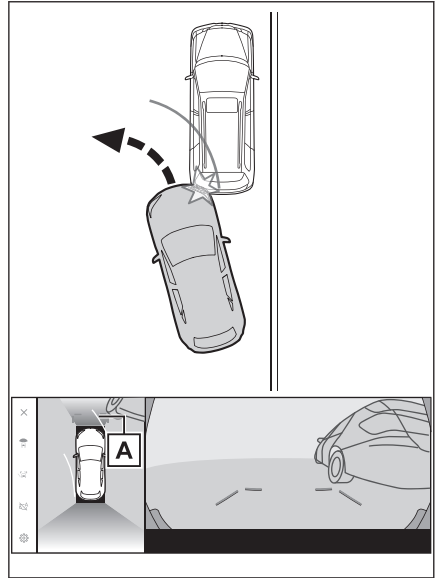

- Three-dimensional objects in high positions (such as the overhang of a wall or loading platform of a truck) may not appear on the screen. Make sure to visually check your surroundings.

A Overhang of a wall

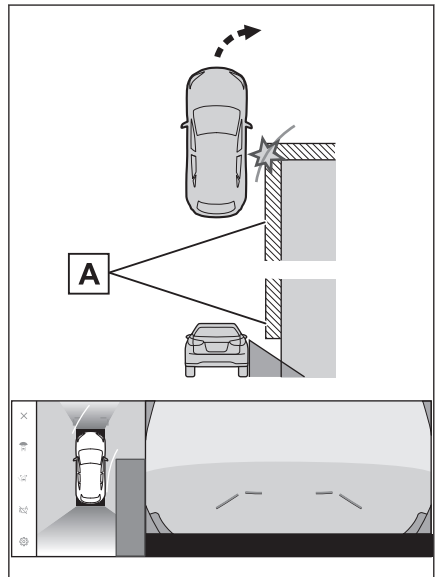

- On the screen, a truck flatbed may appear to be outside of the estimated course lines and the vehicle does not look as if it will collide with the truck. However, the flatbed may actually cross over the estimated course lines and if you reverse as guided by the estimated course lines, the vehicle may hit the truck. Make sure to visually check your surroundings.

A Estimated course lines

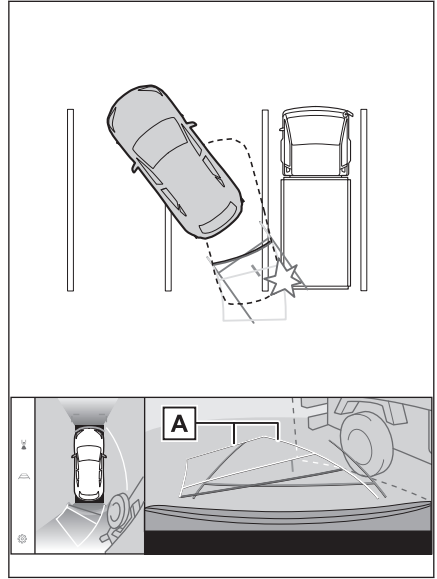

■ Distance guide lines

On the screen, the distance guide lines shows that a truck is parking at point **B**. However, in reality if you reverse to point **A**, you will collide with the truck. On the screen, it appears that point **A** is closest followed by points **B** and **C**. However, in reality, the distance to points **A** and **C** is the same, and point **B** is farther than **A** and **C**. Make sure to visually check behind you and your surroundings. The distance to point **D** is about 3 ft. (1 m).

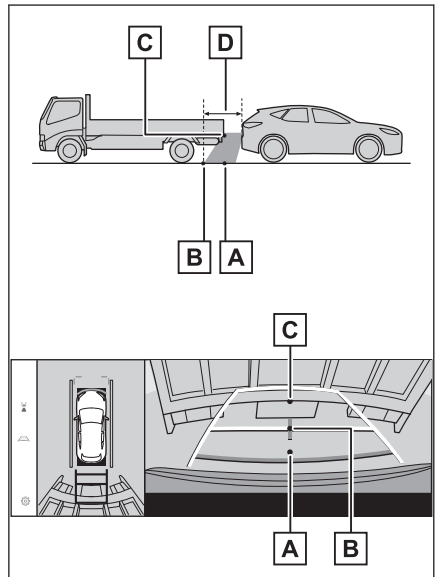

■ **Overhang of a diagonal beam**

In panoramic view, a diagonal beam may appear straight and seems likely not to be struck, however, since the top part of the is actually overhanging, the vehicle may hit it. Make sure to visually check the rear and surroundings.

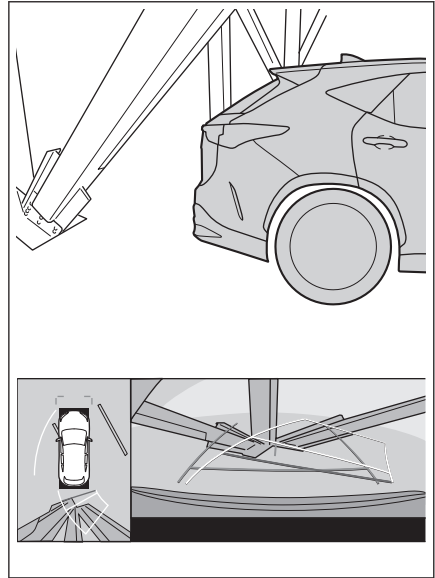

■ **Magnifying function**

Unlike the normal panoramic view, the panoramic view magnifying function zooms in on the vehicle icon. Therefore, white lines on the road, walls, and other objects may look bent.

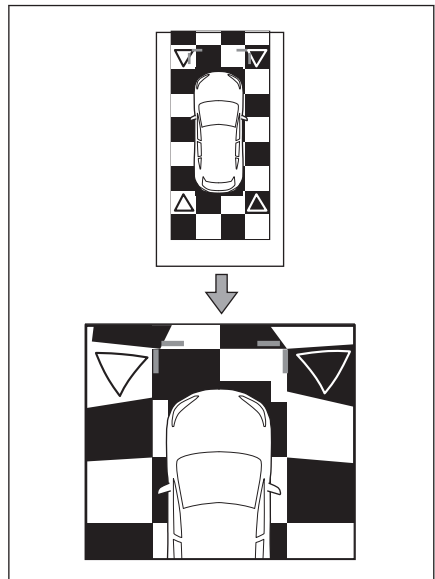

If you notice any symptoms

If you notice or are troubled by any of the symptoms below, check the issue again referring to the likely cause and solution.

If the symptom is not resolved by the solution, have the vehicle inspected by your Lexus dealer.

Symptom	Likely cause	Solution
The screen is difficult to see	<ul style="list-style-type: none"> ● The vehicle is in a dark area or it is night. ● The temperature around the lens is either high or low. ● The outside temperature is low. ● There are water droplets on the camera. ● It is raining or humid. ● Foreign matter (mud etc.) is stuck to the camera. ● Sunlight or headlights are shining directly into the camera. ● The vehicle is under fluorescent lights, sodium lights, mercury lights, etc. 	<p>Visually check the vehicle's surroundings while you are driving.</p> <p>Use the panoramic view monitor again once the camera and conditions have improved.</p> <p>The procedure for adjusting the picture quality of the panoramic view monitor is the same as the procedure for adjusting the multimedia screen.</p>
The image is blurry	Dirt or foreign matter, such as water droplets, snow, or mud, has stuck to the camera lens.	<p>Splash the camera with a large amount of water and then wipe the camera lens clean with a soft, damp cloth.</p> <p>Operate the dedicated camera cleaning washer and clean the camera lens. For details, refer to "OWNER'S MANUAL".</p>
The screen is misaligned	The camera has received a strong impact.	Have the vehicle inspected by your Lexus dealer.
The guide lines are significantly misaligned	The camera position is misaligned.	Have the vehicle inspected by your Lexus dealer.

8-2. Panoramic view monitor

Symptom	Likely cause	Solution
The guide lines are significantly mis-aligned	<ul style="list-style-type: none">● The vehicle is tilted (There is a heavy load on the vehicle, tire pressure is low due to a tire puncture, etc.).● The vehicle is on an incline.	Visually check the vehicle's surroundings while you are driving.
The estimated course lines move even though the steering wheel is straight (the vehicle width guide lines and estimated course lines are out of alignment).	There is a malfunction in the signals being output by the steering sensor.	Have the vehicle inspected by your Lexus dealer.
The guide lines are not displayed	The back door is open.	Close the back door. If this does not resolve the issue, have the vehicle inspected by your Lexus dealer.
The panoramic view display cannot be enlarged. The see-through view/moving view, side clearance view, and cornering view cannot be displayed.	The intuitive parking assist may be malfunctioning or dirty.	Follow the correction procedures for malfunctions of the intuitive parking assist. (For details about the intuitive parking assist, see the "OWNER'S MANUAL".)

Related Links

[Changing the screen display settings\(P. 61\)](#)

Information about free/open source software

This product contains free/open source software.

You can get information about free/open source software and/or source codes from the following URL:

<https://www.denso.com/global/en/opensource/svss/toyota>

9-1. Appendix

Information about media and data that can be used in the audio system.....	294
HD Radio/SiriusXM Radio.....	302
Certification.....	305

Information about media and data that can be used in the audio system

Information about media that can be used

The specifications of the media and other devices that can be used are as follows.

■ Formats and specifications of USB flash drives

The formats and standards of the USB flash drives that can be used, and the restrictions for use, are as follows.

USB communication format	USB 2.0 HS(480MBPS)
File format	FAT 16/32
Communication class	Mass storage class
Maximum number of folders	3000 (including root)
Maximum number of folder levels	8
Maximum number of files	9999 (maximum of 255 files per folder)
Memory capacity	Up to 32 GB
Maximum size of one file	2GB

- Files other than the formats above may not be played correctly, or information such as the file or folder name may not display correctly.
- Please understand in advance that this device may not be able to play your USB flash drive.
- Depending on the computer used to save files on a USB flash drive, hidden files may be saved in addition to the playback files. Deletion of such hidden files is recommended. They may have a negative effect during playback and prevent files from being switched correctly.

Format information

The specifications of the music data that can be used are as follows.

■ MP3

Supported standard	MP3 (MPEG1 LAYER 3, MPEG2 LSF LAYER 3)
Supported sampling frequency (kHz)	MPEG1 LAYER 3:32, 44.1, 48 MPEG2 LSF LAYER 3:16, 22.05, 24

Supported bit rate (kbps) ⁽¹⁾	MPEG1 LAYER 3:32 to 320 MPEG2 LSF LAYER 3:8 to 160
Supported channel mode	Stereo, joint stereo, dual channel, monaural
ID3 tag	ID3 Ver. 1.0, 1.1, 2.2, 2.3 (number of characters as specified by each version)

(1) VBR (Variable Bit Rate) is supported.

■ WMA

Supported standard	WMA Ver. 7, 8, 9 (9.1, 9.2)
Supported sampling frequency (kHz)	32, 44.1, 48
Supported bit rate (kbps) ⁽¹⁾⁽²⁾	Ver. 7, 8: CBR (Constant Bit Rate) 48 to 192 Ver. 9 (9.1/9.2): CBR 48 to 320

(1) VBR (Variable Bit Rate) is supported.

(2) Multi-channel audio sources are converted to 2ch.

■ AAC

Supported standard ⁽¹⁾	MPEG4 AAC-LC
Supported sampling frequency (kHz)	11.025, 12, 16, 22.05, 24, 32, 44.1, 48
Supported bit rate (kbps) ⁽²⁾	8 to 320
Supported channel mode ⁽³⁾	1ch (1/0), 2ch (2/0)

(1) ADIF is not supported.

(2) VBR (Variable Bit Rate) is supported.

(3) Dual channel is not supported.

■ WAV(LPCM)

Supported sampling frequency (kHz) ⁽¹⁾	8, 11.025, 12, 16, 22.05, 24, 32, 44.1, 48, 88.2, 96, 176.4, 192
Supported number of quantization bits (bit) ⁽²⁾	16/24
Supported channel mode	1ch (1/0), 2ch (2/0)

(1) Audio sources higher than 96 kHz/24 bit are down-converted to 96 kHz/24 bit.

(2) Multi-channel audio sources are converted to 2ch.

■ **FLAC**

Supported sampling frequency (kHz) ⁽¹⁾	8, 11.025, 12, 16, 22.05, 24, 32, 44.1, 48, 88.2, 96, 176.4, 192
Supported number of quantization bits (bit) ⁽²⁾	16/24

- (1) Audio sources higher than 96 kHz/24 bit are down-converted to 96 kHz/24 bit.
- (2) Multi-channel audio sources are converted to 2ch.

■ **ALAC**

Supported sampling frequency (kHz) ⁽¹⁾	8, 11.025, 12, 16, 22.05, 24, 32, 44.1, 48, 64, 88.2, 96
Supported number of quantization bits (bit) ⁽²⁾	16/24

- (1) Audio sources higher than 96 kHz/24 bit are down-converted to 96 kHz/24 bit.
- (2) Multi-channel audio sources are converted to 2ch.

■ **Ogg Vorbis**

Supported sampling frequency (kHz) ⁽¹⁾	8, 11.025, 16, 22.05, 32, 44.1, 48
Supported bit rate (kbps) ⁽²⁾	32 to 500

- (1) Audio sources higher than 96 kHz/24 bit are down-converted to 96 kHz/24 bit.
- (2) VBR (Variable Bit Rate) is supported.

■ **File names**

The only files that can be recognized as MP3/WMA/AAC/WAV(LPCM)/FLAC/ALAC/OGG Vorbis and played are those with the extension ".mp3"/".wma"/".m4a"/".3gp"/".aac"/".wav"/".flac"/".fla"/".ogg"/".ogx"/".oga". Save MP3/WMA/AAC/WAV(LPCM)/FLAC/ALAC/OGG Vorbis files with a ".mp3"/".wma"/".m4a"/".3gp"/".aac"/".wav"/".flac"/".fla"/".ogg"/".ogx"/".oga".

■ **About ID3 tags, WMA tags, AAC tags, tags, and Vorbis comments**

- MP3 files have ancillary character information called ID3 tags that can store song artist names, title names, album names, and more.
- WMA files have ancillary character information called WMA tags that can store song artist names, title names, album names, and more.
- AAC files have ancillary character information called AAC tags that can store song artist names, title names, album names, and more.

- WAV (LPCM) files have ancillary character information called tags that can store song artist names, title names, album names, and more.
- FLAC files have ancillary character information called tags that can store song artist names, title names, album names, and more.
- ALAC files have ancillary character information called tags that can store song artist names, title names, album names, and more.
- Ogg Vorbis files have ancillary text information called Vorbis comment that allows saving of the song artist names, title names, album names, and more.

■ High resolution sound sources

This device supports high-resolution sound sources. "High-resolution" sound source is based on the definition of the Japan Electronics and Information Technology Industries Association (JEITA). Supported formats and playable media are as follows.

Supported formats

WAV, FLAC, ALAC, Ogg Vorbis

Playable media

USB flash drive

iPod information

□ INFORMATION

■ Trademark and design certification information

- Use of the Made for Apple badge means that an accessory has been designed to connect specifically to the Apple product(s) identified in the badge, and has been certified by the developer to meet Apple performance standards.

Apple is not responsible for the operation of this vehicle or its compliance with safety and regulatory standards.

Please note that the use of this accessory with an Apple product may affect wireless performance.

iPhone, iPod, iPod touch and Lightning are trademarks of Apple Inc., registered in the U.S. and other countries.



Made for

- iPhone 12 Pro Max

- iPhone 12 Pro
- iPhone 12
- iPhone 12 mini
- iPhone SE (2nd generation)
- iPhone 11 Pro Max
- iPhone 11 Pro
- iPhone 11
- iPhone XS Max
- iPhone XS
- iPhone XR
- iPhone X
- iPhone 8 Plus
- iPhone 8
- iPhone 7 Plus
- iPhone 7
- iPhone SE
- iPhone 6s Plus
- iPhone 6s
- iPod touch (7th generation)

Apple CarPlay information

INFORMATION

■ Trademark and design certification information

- Use of the Apple CarPlay logo means that a vehicle user interface meets Apple performance standards. Apple is not responsible for the operation of this vehicle or its compliance with safety and regulatory standards. Please note that the use of this product with iPhone, iPod, or iPad may affect wireless performance.

Apple CarPlay is a trademark of Apple Inc.

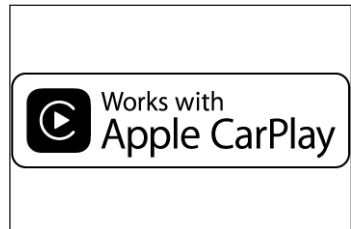

Android Auto information

INFORMATION

■ Trademark and design certification information

- Android and Android Auto are trademarks of Google LLC.



androidauto

Information USB memories

■ Music files recorded using a computer

The following music files can be played.

- MP3
- WMA
- AAC
- FLAC
- WAV
- ALAC
- OGG Vorbis

MP3/WMA/AAC specifications

Certain restrictions apply to the standards of the MP3/WMA/AAC files that can be used, and the media and formats that store such files. Microsoft, Windows, and Windows Media are the registered trademarks of Microsoft Corporation in the USA and other countries.

The specifications of the music data that can be used are as follows.

MP3

MP3 (MPEG Audio LAYER 3) is the standard format related to audio compression technology. When MP3 is used, the file can be compressed to approximately 1/10 the size of the original file.

WMA

WMA (Windows Media Audio) is the audio compression format of Microsoft Corporation. This can compress files to an even smaller size than MP3.

This product is protected by certain intellectual property rights of Microsoft. Use or distribution of such technology outside of this product is prohibited without a license from Microsoft.

AAC

AAC (Advanced Audio Coding) is the standard format related to audio compression technology that is used in MPEG2 and MPEG4.

Bluetooth® information

The Bluetooth® specifications and profiles that can be used are as follows.

Item	Bluetooth® audio
Supported Bluetooth® specifications	Bluetooth® Core Specification Ver.2.1 or later
Supported profiles	<ul style="list-style-type: none"> ● A2DP (Advanced Audio Distribution Profile) profile for transmitting music data: Ver. 1.0 or later ● AVRCP (Audio/Video Remote Control Profile) profile for controlling (playing, stopping, etc.) portable audio from a multimedia system: Ver. 1.0 or later
Supported codecs	LDAC/AAC/SBC

INFORMATION

- Connectivity between this system and all Bluetooth® devices is not guaranteed.

Certification

Bluetooth is a registered trademark of Bluetooth SIG, Inc.



■ LDAC

LDAC and LDAC logo are trademarks of Sony Corporation.



Gracenote® information

When music is played, the database of the multi media system is searched for the album name, artist name, genre, and track name. If the corresponding information is stored in the database, then the information is assigned automatically. The Gracenote® media database is used for the database information stored in this multi media system.

INFORMATION

■ Gracenote® media database

- The title information assigned automatically may differ from the actual title information.
- The contents of the data provided by the "Gracenote media database" is not guaranteed to be 100% accurate.
- Gracenote, the Gracenote logo and logotype, and the "Powered by Gracenote" logo are either a registered trademark or a trademark of Gracenote, Inc. in the United States and/or other countries.



HD Radio/SiriusXM Radio

Using HD Radio™ technology

HD Radio™ Technology is the digital evolution of analog AM/FM radio. Your radio product has a special receiver which allows it to receive digital broadcasts (where available) in addition to the analog broadcasts it already receives. Digital broadcasts have better sound quality than analog broadcasts as digital broadcasts provide free, crystal clear audio with no static or distortion. For more information, and a guide to available radio stations and programming, refer to www.hdradio.com.

This function is not available in some countries or areas.

HD Radio features included in this radio:

- **Digital Sound:** HD Radio broadcasts deliver crystal-clear, digital audio quality to listeners.
- **Multicast Channels (HD2/HD3):** FM stations can provide additional digital only audio programming with expanded content and format choices on HD2/HD3 channels.
- **Program Service Data (PSD):** PSD gives you on-screen information such as artist name and song title.
- **Artist Experience Images** related to the broadcast are displayed on the radio screen, such as album cover art and station logos.

□ INFORMATION

■ Certification

HD Radio Technology manufactured under license from iBiquity Digital Corporation. U.S. and Foreign Patents. For patents see <http://dts.com/patents>.

HD Radio, Artist Experience, and the HD, HD Radio, and "ARC" logos are registered trademarks or trademarks of iBiquity Digital Corporation in the United States and/or other countries.



HOW TO SUBSCRIBE TO SiriusXM Radio Radio Services

All SiriusXM Radio services, including satellite radio and data services, plus streaming services, require a subscription, sold separately or as a package by Sirius XM Radio Inc. (or, in Canada, Sirius XM Canada Inc.), after any trial subscription which may be included with your vehicle purchase or lease. To subscribe after your trial subscription, call 1-877-447-0011 (U.S.A.) or 1-877-438-9677

(Canada). SiriusXM Radio and all related marks and logos are trademarks of Sirius XM Radio Inc.

Note: If a trademark notice is elsewhere, you don't need to add it here too.

This function is not available in some countries or areas.

■ IMPORTANT INFORMATION ABOUT YOUR TRIAL SUBSCRIPTION:

Your SiriusXM Radio services will automatically stop at the end of your trial unless you decide to continue service. If you decide to continue service, the paid subscription plan you choose will automatically renew and you will be charged the rate in effect at that time and according to your chosen payment method. Fees and taxes apply. You may cancel at any time by calling 1-866-635-2349. See SiriusXM Radio Customer Agreement and Privacy Policy for complete terms at www.siriusxm.com (U.S.A.) or www.siriusxm.ca (Canada). All fees, content and features subject to change. Traffic information not available in all markets. Certain features and/or content may not be available in vehicles with SiriusXM Radio with 360L unless an active data connection is enabled in the vehicle.

■ ABOUT SiriusXM Radio Services

Most in-car trials today include SiriusXM Radio's All Access package. It includes every channel available on your radio.

■ SiriusXM Radio All Access Subscription

Listen everywhere with All Access. You get every channel available in your ride, plus you can listen on the app and online - so you can enjoy the best SiriusXM Radio has to offer, anywhere life takes you. It's the only package that gives you all of our premium programming, including Howard Stern, every NFL, MLB[®] and NBA game, every NASCAR[®] race, NHL[®] games, 24/7 talk channels dedicated to the biggest leagues, and more. You get all kinds of ad-free music, including artist-dedicated channels and more, plus sports, news, talk and entertainment.

All content subject to change.

This device complies with Part 15 of the FCC rules. Operation is subject to the following two conditions: (1) This device may not cause harmful interference, and (2) this device must accept any interference received, including interference that may cause undesired operation. Changes or modifications not expressly approved by the party responsible for compliance could void the user's authority to operate the equipment.

■ RADIO OPERATION

Look for the Sirius, XM, SiriusXM, Band, SAT, AUX, Radio or Source button and you're in. If you can't hear us, it's easy to get started: Locate your Radio ID, or check [**Help and support**] on the SiriusXM Radio setting screen. If you

don't see your number there, go to siriusxm.com/activationhelp to find it. Visit siriusxm.com/refresh or call 1-855-MYREFRESH (697-3373) to send a refresh signal to your radio. Canadian Customers: Locate your Radio ID, or check [**Help and support**] on the SiriusXM Radio setting screen. Visit siriusxm.ca/refresh to send a refresh signal to your radio or call 1-888-539-7474 for service.

NOTICE

- It is prohibited to copy, decompile, disassemble, reverse engineer, hack, manipulate, or otherwise make available any technology or software incorporated in receivers compatible with the SiriusXM Satellite Radio System or that support the SiriusXM Radio website, the streaming service or any of its content. Furthermore, the AMBE[®] voice compression software included in this product is protected by intellectual property rights including patent rights, copyrights, and trade secrets of Digital Voice Systems, Inc.
- Note: this applies to SiriusXM Satellite Radio receivers only and not SiriusXM Radio Ready devices.

Displaying the radio ID

Each SiriusXM Radio tuner is identified with a unique radio ID. The radio ID is required when activating an SiriusXM Radio service or when reporting a problem.

This function is not available in some countries or areas.

- To see radio ID on the screen, go to [**Sound & Media**] in the setting screen and select SiriusXM Radio, and then select [**Help and support**].

Certification

FCC ID: ACJ932AT2103

NOTE:

<§15.19(a)(3)> This device complies with part 15 of the FCC Rules. Operation is subject to the following two conditions: (1) This device may not cause harmful interference, and (2) this device must accept any interference received, including interference that may cause undesired operation.

FCC WARNING:

<§15.21> Changes or modifications not expressly approved by the party responsible for compliance could void the user's authority to operate the equipment.

CAUTION:

<§2.1091> Radio frequency radiation exposure information:
This equipment complies with FCC radiation exposure limits set forth for an uncontrolled environment. This equipment should be installed and operated with minimum distance of 20cm between the radiator and your body. This transmitter must not be co-located or operated in conjunction with any other antenna or transmitter.

This device contains licence-exempt transmitter(s)/receiver(s) that comply with Innovation, Science and Economic Development Canada's licence-exempt RSS(s). Operation is subject to the following two conditions:

- (1) This device may not cause interference.
- (2) This device must accept any interference, including interference that may cause undesired operation of the device.

L'émetteur/récepteur exempt de licence contenu dans le présent appareil est conforme aux CNR d'Innovation, Sciences et Développement économique Canada applicables aux appareils radio exempts de licence. L'exploitation est autorisée aux deux conditions suivantes :

- 1) L'appareil ne doit pas produire de brouillage;
- 2) L'appareil doit accepter tout brouillage radioélectrique subi, même si le brouillage est susceptible d'en compromettre le fonctionnement.

CAUTION

This equipment complies with ISED radiation exposure limits set forth for an uncontrolled environment and meets RSS-102 of the ISED radio frequency (RF) Exposure rules. This equipment should be installed and operated keeping the radiator at least 20cm or more away from person's body.

Cet équipement est conforme aux limites d'exposition aux rayonnements énoncés pour un environnement non contrôlé et respecte les règles d'exposition aux fréquences radioélectriques (RF) CNR-102 de l'ISDE. Cet équipement doit être installé et utilisé en gardant une distance de 20 cm ou plus entre le radiateur et le corps humain.

FCC ID: JOYCW1011

NOTE

This device complies with part 15 of the FCC Rules. Operation is subject to the following two conditions: (1) This device may not cause harmful interference, and (2) this device must accept any interference received, including interference that may cause undesired operation.

FCC WARNING

Changes or modifications not expressly approved by the party responsible for compliance could void the user's authority to operate the equipment.

Co-location: This transmitter must not be co-located or operated in conjunction with any other antenna or transmitter.

CAUTION : Radio Frequency Radiation Exposure

This equipment complies with FCC radiation exposure limits set forth for an uncontrolled environment and meets the FCC radio frequency (RF) Exposure Guidelines. This equipment should be installed and operated keeping the radiator at least 20cm or more away from person's body.

IC: 574B-CW1011

NOTE

This device contains licence-exempt transmitter(s)/receiver(s) that comply with Innovation, Science and Economic Development Canada's licence-exempt RSS(s). Operation is subject to the following two conditions:

- (1) This device may not cause interference.
- (2) This device must accept any interference, including interference that may cause undesired operation of the device.

The antenna cannot be removed (and changed) by user.

Co-location: This transmitter must not be co-located or operated in conjunction with any other antenna or transmitter.

CAUTION: Radio Frequency Radiation Exposure

This equipment complies with ISED radiation exposure limits set forth for an uncontrolled environment and meets RSS-102 of the ISED radio frequency (RF) Exposure rules. This equipment should be installed and operated keeping the radiator at least 20 cm or more away from person's body.

NOTE

L'émetteur/récepteur exempt de licence contenu dans le présent appareil est conforme aux CNR d'Innovation, Sciences et Développement économique Canada applicables aux appareils radio exempts de licence.

L'exploitation est autorisée aux deux conditions suivantes :

- (1) L'appareil ne doit pas produire de brouillage;
- (2) L'appareil doit accepter tout brouillage radioélectrique subi, même si le brouillage est susceptible d'en compromettre le fonctionnement.

L'utilisateur n'est pas autorisé à retirer (ou modifier) l'antenne.

Emplacement: Cet émetteur ne doit pas être installé ou utilisé conjointement avec d'autres antennes ou émetteurs.

ATTENTION : exposition aux radiofréquences

Cet équipement est conforme aux limites d'exposition aux rayonnements ISDE établies pour un environnement non contrôlé et satisfait à la norme CNR-102 de la réglementation ISDE sur l'exposition aux radiofréquences (RF). Cet équipement doit être installé et utilisé avec un minimum de 20 cm de distance entre la source de rayonnement et le corps.

La operación de este equipo está sujeta a las siguientes dos condiciones: (1) es posible que este equipo o dispositivo no cause interferencia perjudicial y (2) este equipo o dispositivo debe aceptar cualquier interferencia, incluyendo la que pueda causar su operación no deseada.

Módulo celular instalado dentro de este Módulo de Comunicación de Datos (Data Communication Module, DCM)

- Instituto Federal de Telecomunicaciones (IFT)
- Número de aprobación: RTIKYAL20-2500
- Tipo de módulo aprobado: AL-T51A2-2
- Nombre del fabricante (nombre de la marca) del módulo aprobado: Kyocera Corporation
- Número de IMEI : vea el producto.

This device complies with part 15 of the FCC Rules. Operation is subject to the following two conditions: (1) This device may not cause harmful interference, and (2) this device must accept any interference received, including interference that may cause undesired operation.

Information to User - Alteration or modifications carried out without appropriate authorization may invalidate the user's right to operate the equipment.

**FEDERAL COMMUNICATIONS COMMISSION
SUPPLIER'S DECLARATION OF CONFORMITY**

Product Name: In-vehicle equipment

Model Number: GM-4219,GM-4419,GM-4319,GM-4519

Responsible Party Name: PIONEER ELECTRONICS (USA) INC.
SERVICE SUPPORT DIVISION

Address: 2050 W. 190TH STREET, SUITE 100, TORRANCE,
CA 90504, U.S.A.

Phone: 1-800-421-1404

URL: <http://www.pioneerelectronics.com>

La operación de este equipo está sujeta a las siguientes dos condiciones: (1) es posible que este equipo o dispositivo no cause interferencia perjudicial y (2) este equipo o dispositivo debe aceptar cualquier interferencia, incluyendo la que pueda causar su operación no deseada.

Any unauthorized changes or modifications to this equipment would void the user's authority to operate this device.

This product is licensed under the MPEG-4 patent portfolio license and AVC patent portfolio license for the personal use of a consumer or other uses in which it does not receive remuneration to

(i) encode video in compliance with the MPEG-4 Visual Standard and AVC Standard ("MPEG-4/AVC Video") and/or

(ii) decode MPEG-4/AVC Video that was encoded by a consumer engaged in a personal activity and/or was obtained from a video provider licensed to provide MPEG-4/AVC Video.

No license is granted or shall be implied for any other use.

Additional information may be obtained from MPEG LA, L.L.C. See

<http://www.mpegla.com>.

This product is licensed under the AVC patent portfolio license for the personal use of a consumer or other uses in which it does not receive remuneration to

(i) encode video in compliance with the AVC Standard ("AVC Video") and/or

(ii) decode AVC Video that was encoded by a consumer engaged in a personal activity and/or was obtained from a video provider licensed to provide AVC Video.

No license is granted or shall be implied for any other use.

Additional information may be obtained from MPEG LA, L.L.C. See

<http://www.mpegla.com>.

DCM

Free/Open Source Software Information

This product contains Free/Open Source Software (FOSS). The license information and/or the source code of such FOSS can be found at the following URL.

<https://www.denso.com/global/en/opensource/dcm/toyota/>

QR Code

The word "QR Code" is registered trademark of DENSO WAVE INCORPORATED in Japan and other countries.

Map data

©2021 HERE

Visit the link below for the data license.

<https://legal.here.com/terms/general-content-supplier/terms-and-notice/>

END USER LICENSE AGREEMENT

<https://legal.here.com/en-gb/terms/end-user-license-agreement>

- A**
- Adding a destination..... 148
 - Adjustment
 - Brightness..... 61
 - Clock..... 57
 - Contrast..... 61
 - AM radio..... 154
 - Android Auto..... 175
 - Answering calls/Receiving calls..... 202
 - Antenna
 - Radio..... 160
 - Apple CarPlay..... 171
 - Apps
 - Settings..... 87
 - Audio..... 154
 - Audio system on/off..... 30
 - Auto sound levelizer..... 76
- B**
- Bluetooth® audio..... 179
 - Bluetooth® devices
 - Connect..... 98
 - Delete..... 97
 - Register..... 94
 - Setting as a primary device..... 102
 - Setting as a secondary device..... 103
- C**
- Cellular phone
 - Connect..... 98
 - Delete..... 97
 - Register..... 94
 - Cleaning the camera..... 235,274
 - Climate control buttons..... 16
 - Clock settings..... 57
 - Compatible profiles..... 93
 - Connected Services..... 220
 - Connecting
 - Bluetooth® devices..... 98
 - iPod..... 34
 - USB port..... 34
 - Wi-Fi®..... 106
 - Wi-Fi® Hotspot..... 109
 - Connecting to Wi-Fi® Hotspot..... 109
 - Contact data (Phone number)
 - Transfer..... 212
 - Contrast and brightness..... 61
 - Current position..... 27,74
- D**
- Date & Time settings..... 57
 - Dealer information registration..... 64
 - Declining calls..... 204
 - Deleting
 - Bluetooth® devices..... 97
 - User profile..... 55
 - Deleting a destination..... 148
 - Destination..... 136
 - Destination history..... 138
 - Destination Assist..... 142
 - Destination search..... 136,140
 - Category..... 136
 - Destination history..... 136
 - Favorite..... 136
 - Home..... 136
 - Keyboard..... 136
 - Voice control..... 138

Work.....	136
Digital keys.....	65
Display ON/OFF.....	61

E

Ending calls.....	210
Entering letters.....	25
Entering numbers.....	25

F

Favorite.....	73,136,145
Editing the favorites list.....	138
FM radio.....	154
Format information.....	294
Function achieved by using DCM.....	222
Function achieved by using DCM and a smart phone.....	223
Function achieved by using DCM and the system.....	221

G

General settings.....	57
Gracenote®.....	294

H

Hands-free (Phone).....	186
HD radio.....	154
High resolution sound sources.....	294
Home.....	73,136

I

In-call operations.....	205
Intelligent Assistant system.....	35
iPod/iPhone.....	167

K

Keyboard

Entering letters and numbers.....	25
-----------------------------------	----

L

Language settings.....	57
Lexus account.....	46
Lexus parking assist monitor.....	226
Displaying the guide screen.....	228
Listening to the radio.....	154

M

Main menu.....	17
Making calls	
Contacts.....	200
Favorites list.....	199
History.....	198
In-call.....	208
Message.....	217
Numeric keypad input.....	201
Making conference calls.....	209

Map

Full route map.....	145
Information.....	134
Navigation.....	132
Options.....	133
Route guidance.....	147
Map scale.....	27
Map screen.....	26
Message.....	214

N

Navigation.....	26
Adding a destination.....	148
Deleting a destination.....	148

Destination Assist..... 142
 Destination search..... 136,140
 Full route map..... 145
 Information..... 134
 Map options..... 133
 POI suggestion..... 141
 Route guidance..... 144,147
 Subscription..... 132
 Voice guidance..... 151
Notifications settings..... 60

O

Orientation of the map..... 27

P

Panoramic view monitor..... 245
Parking..... 73
Playback
 Android Auto..... 175
 Apple CarPlay..... 171
 Bluetooth® audio..... 179
 iPod/iPhone..... 167
 USB flash drive..... 163
POI suggestion..... 141

Precautions for the Lexus parking assist monitor

Camera position..... 238

Predictive efficient drive..... 75,134

Privacy lock..... 65

R

Receiving calls or answering calls

Second call..... 207

Registering

Bluetooth® devices..... 94

Dealer information..... 64
 User profile..... 46
 User profile settings..... 53
Remote Connect..... 223
Replying messages..... 215
Replying new messages..... 216
Restarting the system..... 15
Route guidance..... 144

S

Searching by keywords..... 44

Security settings..... 65

Service Connect..... 223

Settings

Apps..... 87
 Bluetooth® device settings..... 84
 Dealer information settings..... 64
 General settings..... 57
 Map details screen..... 73
 Navigation setting screen..... 72
 Notifications settings..... 60
 Panoramic view monitor settings..... 272
 Privacy settings..... 65
 Radio settings..... 76
 Route option..... 75
 Screen display settings..... 61
 Security settings..... 65
 Sound and media settings..... 76
 User profile settings..... 55
 Various settings..... 51
 Voice control settings..... 63
 Wi-Fi® Hotspot settings..... 82
 Wi-Fi® settings..... 80



MULTIMEDIA OWNER'S MANUAL:

Publication No. OM78359J

Part No. 01999-78359

Printed in Japan 01-2210-00 Z

NX450h+ / NX350h / NX350 / NX250 マルチメディア (北米U)