



2010

RX 350

OWNER'S MANUAL

TABLE OF CONTENTS

1	Before driving	Adjusting and operating features such as door locks, mirrors, and steering column
2	When driving	Driving, stopping and safe-driving information
3	Interior features	Air conditioning and audio systems, as well as other interior features for a comfortable driving experience
4	Maintenance and care	Cleaning and protecting your vehicle, performing do-it-yourself maintenance, and maintenance information
5	When trouble arises	What to do if the vehicle needs to be towed, gets a flat tire, or is involved in an accident
6	Vehicle specifications	Detailed vehicle information
7	For owners	Reporting safety defects for U.S. owners and seat belt instructions for Canadian owners
	Index	Alphabetical listing of information contained in this manual

1 Before driving

1-1. Key information

Keys 24

1-2. Opening, closing and locking the doors

Smart access system with push-button start 29

Wireless remote control 40

Side doors 44

Back door 47

1-3. Adjustable components (seats, mirrors, steering wheel)

Front seats 58

Rear seats 63

Driving position memory 67

Head restraints 70

Seat belts 72

Steering wheel 80

Anti-glare inside rear view mirror 82

Outside rear view mirrors 83

1-4. Opening and closing the windows and moon roof

Power windows 86

Moon roof 89

1-5. Refueling

Opening the fuel tank cap 92

1-6. Theft deterrent system

Engine immobilizer system 96

Alarm 98

Theft prevention labels (for U.S.A.) 100

1-7. Safety information

Correct driving posture 101

SRS airbags 103

Front passenger occupant classification system 115

Child restraint systems 120

Installing child restraints 124

2 When driving

2-1. Driving procedures

Driving the vehicle 136

Engine (ignition) switch 145

Automatic transmission 151

Turn signal lever 155

Parking brake 156

Horn 157

2-2. Instrument cluster

Gauges and meters	158
Indicators and warning lights ...	160
Multi-information display.....	165
Head-up display	171

2-3. Operating the lights and windshield wipers

Headlight switch.....	176
Automatic High Beam	181
Fog light switch	187
Windshield wipers and washer.....	189
Rear window wiper and washer.....	194
Headlight cleaner switch	195

2-4. Using other driving systems

Cruise control	196
Dynamic radar cruise control.....	200
Intuitive parking assist	211
Electronically modulated air suspension	218
Rear view monitor system (rear view mirror-attached type).....	224
Driving assist systems.....	228
All-wheel drive lock switch (AWD models)	234
Hill-start assist control.....	235
Pre-Collision System.....	237

2-5. Driving information

Utility vehicle precautions.....	242
Cargo and luggage.....	247
Vehicle load limits.....	251
Winter driving tips	252
Trailer towing.....	256
Dinghy towing	269

3 Interior features

3-1. Using the air conditioning system and defogger

Automatic air conditioning system	272
Rear window defogger switch	279
Windshield wiper de-icer.....	280

3-2. Using the audio system

Audio system	281
Using the radio.....	285
Using the CD player.....	295
Playing MP3 and WMA discs	305
Operating an iPod® player.....	315
Operating a USB memory player.....	323
Optimal use of the audio system	332
Using the AUX adapter.....	335
Using the steering wheel audio switches	337

3-3. Using the Bluetooth® audio system	
Bluetooth® audio system	340
Using the Bluetooth® audio system	343
Operating a Bluetooth® enabled portable player	348
Setting up a Bluetooth® enabled portable player	352
Bluetooth® audio system setup	359
3-4. Using the hands-free phone system (for mobile phones)	
Hands-free system for mobile phones	360
Using the hands-free system (for mobile phones)	364
Making a phone call	372
Setting a mobile phone	377
Security and system setup	383
Using the phone book	387
3-5. Using the interior lights	
Interior lights list	394
• Interior lights	395
• Personal lights	395
3-6. Using the storage features	
List of storage features	397
• Glove box	398
• Bottle holders/door pockets	399
• Cup holders	400
• Console box	402
• Auxiliary boxes	404
• Under tray	405
3-7. Other interior features	
Sun visors	406
Vanity mirrors	407
Clock	408
Outside temperature display (vehicles without a navigation system)	409
Multi-display light control (vehicles without a navigation system)	410
Power outlets	411
Seat heaters and ventilators	414
Armrest	416
Coat hooks	417
Floor mat	418
Luggage compartment features	419
Garage door opener	424
Compass	430

4 Maintenance and care

4-1. Maintenance and care

- Cleaning and protecting the vehicle exterior 436
- Cleaning and protecting the vehicle interior 439

4-2. Maintenance

- Maintenance requirements 442
- General maintenance 444
- Emission inspection and maintenance (I/M) programs 448

4-3. Do-it-yourself maintenance

- Do-it-yourself service precautions 449
- Hood 452
- Positioning a floor jack 453
- Engine compartment 455
- Tires 471
- Tire inflation pressure 480
- Wheels 483
- Air conditioning filter 485
- Electronic key battery 488
- Checking and replacing fuses 490
- Headlight aim (discharge headlights) 501
- Light bulbs 503

5 When trouble arises

5-1. Essential information

- Emergency flashers 516
- If your vehicle needs to be towed 517
- If you think something is wrong 522
- Fuel pump shut off system 523
- Event data recorder 524

5-2. Steps to take in an emergency

- If a warning light turns on or a warning buzzer sounds... 526
- If a warning message is displayed 536
- If you have a flat tire 555
- If the engine will not start 568
- If the shift lever cannot be shifted from P 570
- If you lose your keys 571
- If the electronic key does not operate properly 572
- If the battery is discharged 575
- If your vehicle overheats 578
- If the vehicle becomes stuck 581

1

2

3

4

5

6

7

6 Vehicle specifications

6-1. Specifications

Maintenance data (fuel, oil level, etc.).....	584
Fuel information.....	595
Tire information.....	598

6-2. Customization

Customizable features.....	610
----------------------------	-----

6-3. Initialization

Items to initialize	619
---------------------------	-----

7 For owners

Reporting safety defects for U.S. owners.....	622
Seat belt instructions for Canadian owners (in French).....	623

Index

Abbreviation list.....	628
Alphabetical index	630
What to do if... ..	641

1

2

3

4

5

6

7





*: If equipped

Pictorial index

Interior

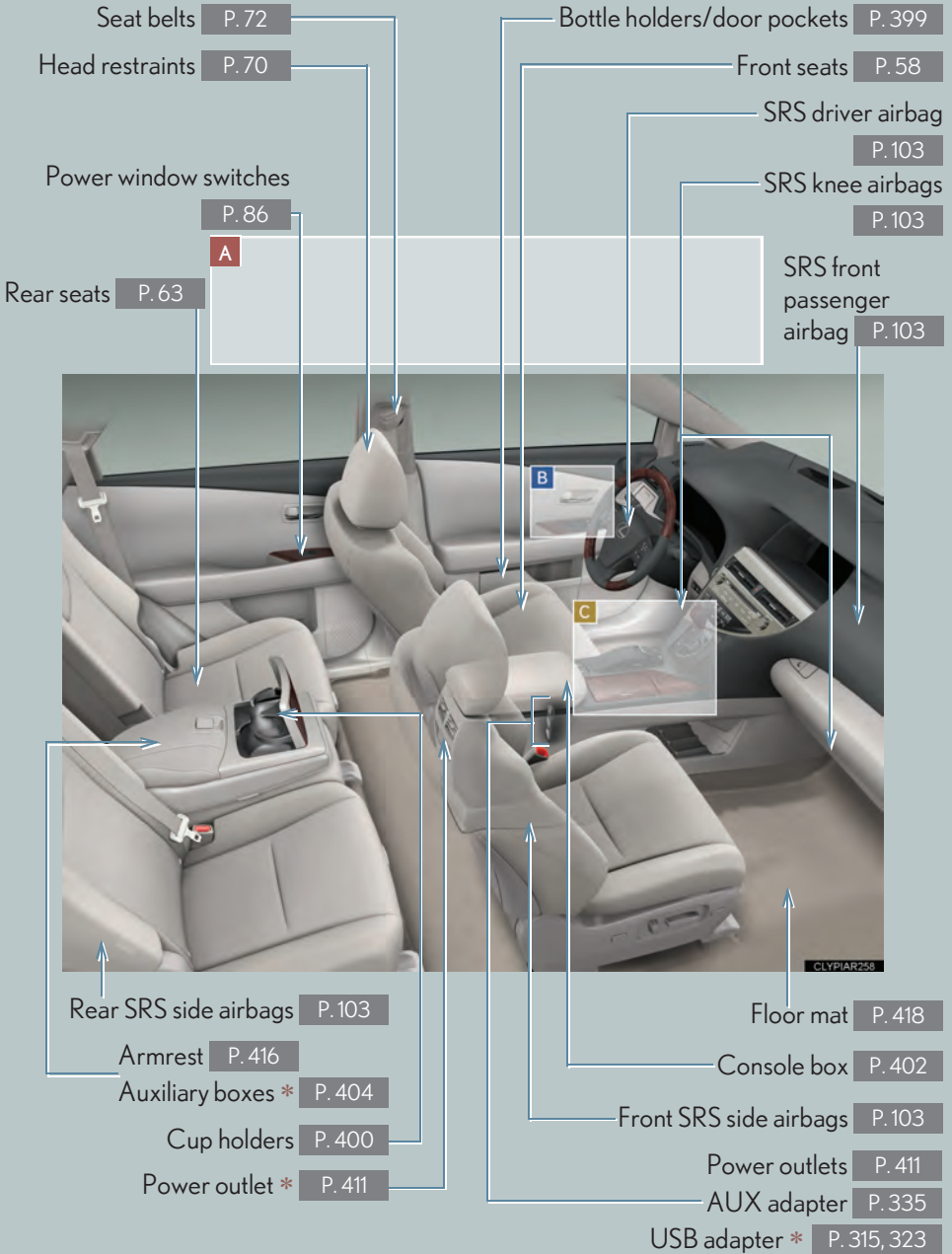

A

Rear view monitor system * P. 224

Auxiliary boxes P. 404

Personal lights P. 395

Interior lights P. 395

Interior lights P. 395

Personal lights P. 395

SRS curtain shield airbags P. 103

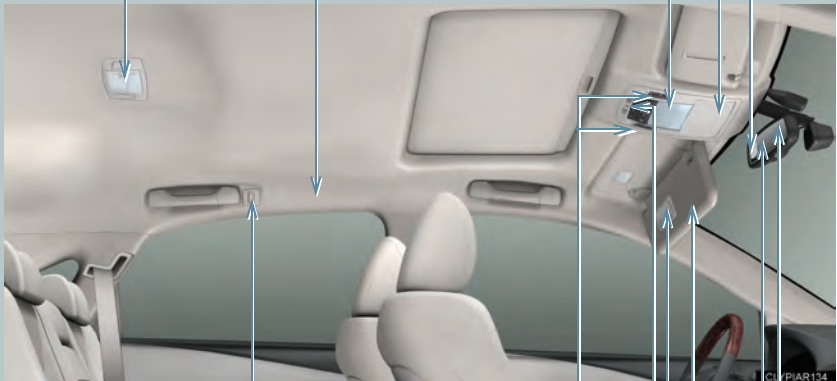

Coat hooks P. 417

Moon roof switches * P. 89

Garage door opener switches P. 424

Vanity mirrors P. 407

Sun visors P. 406

Anti-glare inside rear view mirror P. 82

Compass P. 430

*: If equipped

B

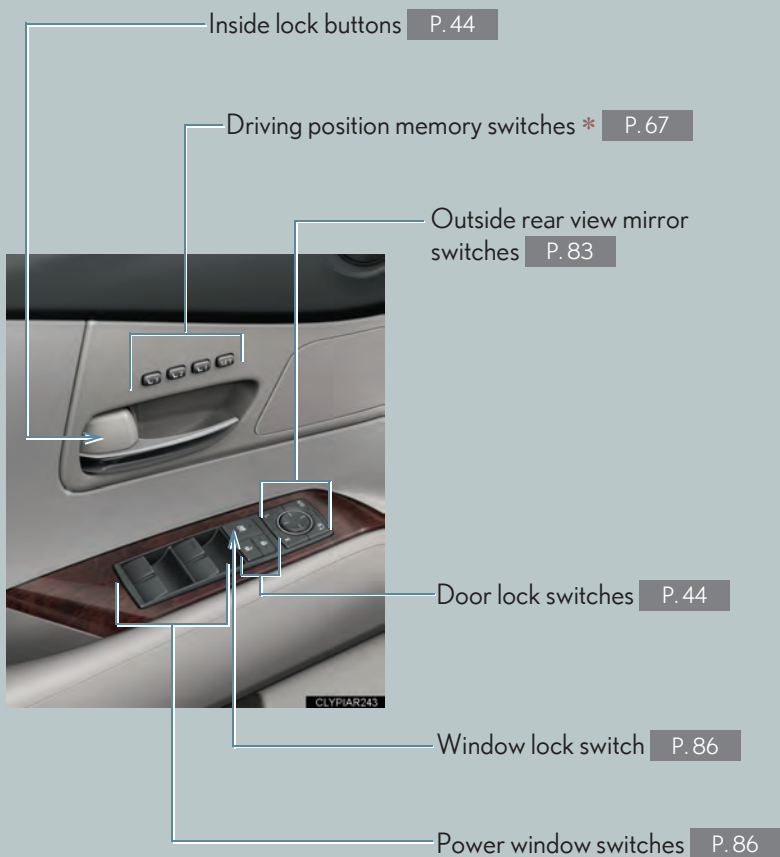

C

Automatic transmission shift lever P. 151

Shift lock override button P. 570

Remote Touch * *

Cup holders P. 400

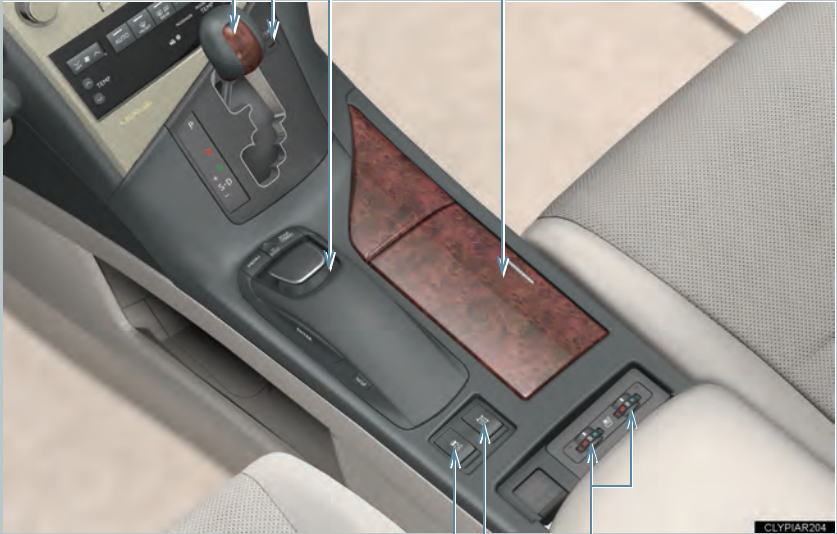

VSC off switch P. 230

All-wheel drive lock switch * P. 234

Seat heater switches * /

Seat heater and ventilator switches * P. 414

*: If equipped

*: Refer to "Navigation System Owner's Manual".

Headlight switch P. 176
Turn signal lever P. 155
Fog light switch P. 187

Glove box P. 398
Power back door main switch * P. 49

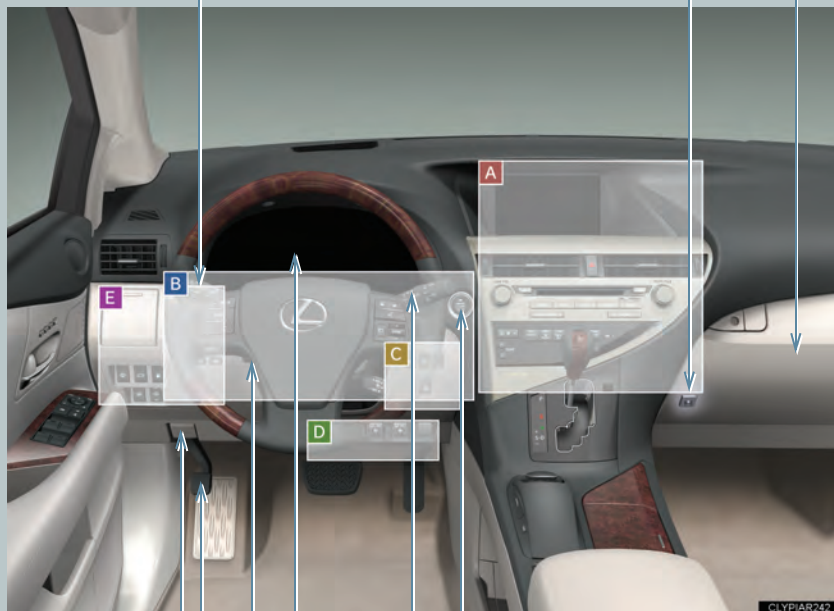

Engine (ignition) switch P. 145
Windshield wipers and washer switch P. 189
Rear window wiper and washer switch P. 194
Gauges and meters P. 158
Tilt and telescopic steering control switch P. 80
Parking brake pedal P. 156
Hood lock release lever P. 452

A

► With navigation system

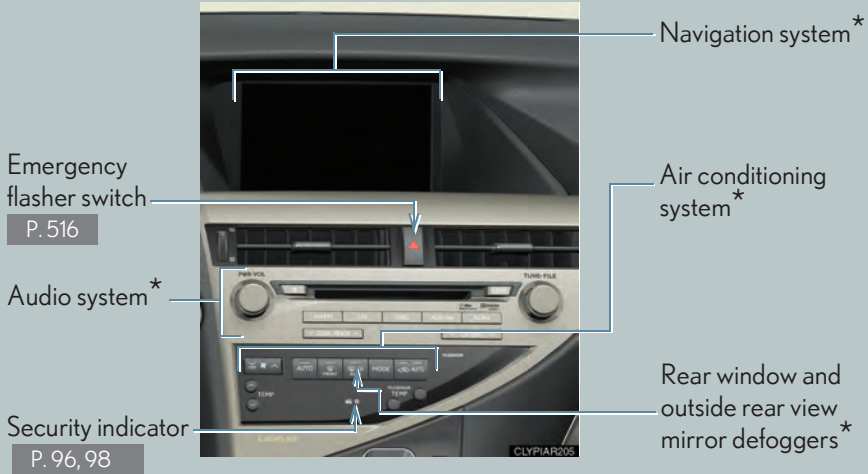

► Without navigation system

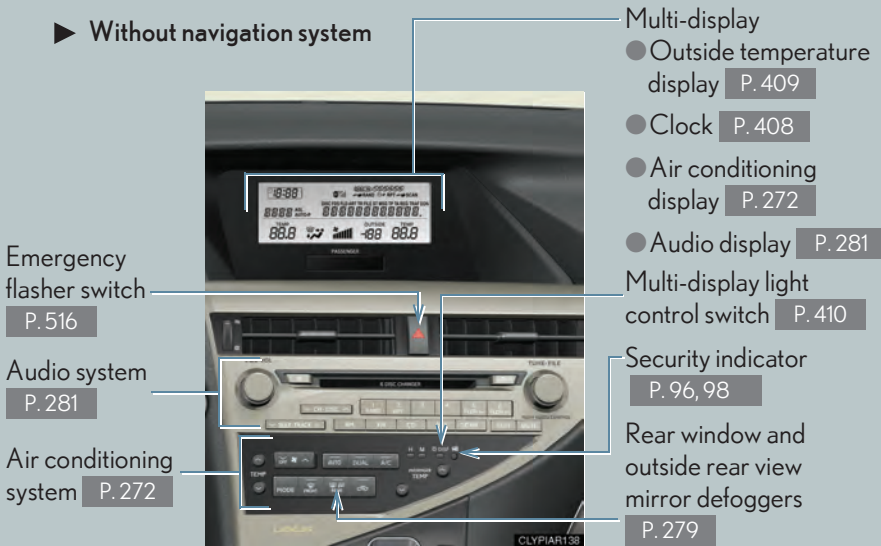

*: If equipped

*: Refer to "Navigation System Owner's Manual".

B

Audio remote control switches * P. 337 *2

Talk switch * P. 365 *2

Telephone switches * P. 365 *2

Multi-information switch P. 165



Side camera switch *

Horn P. 157

Cruise control switch P. 196, 200

Distance switch * P. 200

CLYPIAR089

C

Display position adjustment switch * P. 173

Head-up display main switch * P. 173



Display contrast adjustment switch * P. 173

Power outlet main switch * P. 411

CLYPIAR041

D

Tire pressure warning reset switch P. 473



Height control off switch * P. 220

E

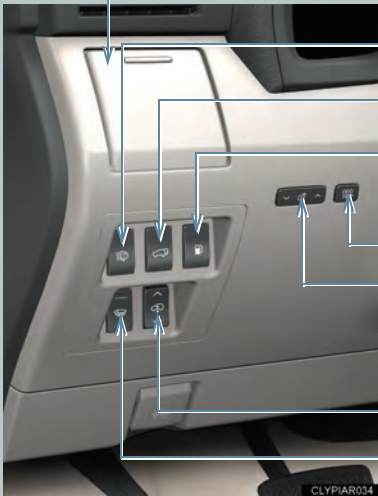

Cup holder P. 400

Headlight cleaner switch * P. 195

Power back door switch * P. 48

Fuel filler door opener P. 92

ODO/TRIP button P. 159

Instrument panel light control switch P. 159

Height selector switch * P. 219

Windshield wiper de-icer switch * P. 280

*: If equipped

*: Refer to "Navigation System Owner's Manual".

*2: For vehicles with a navigation system, refer to the "Navigation System Owner's Manual".

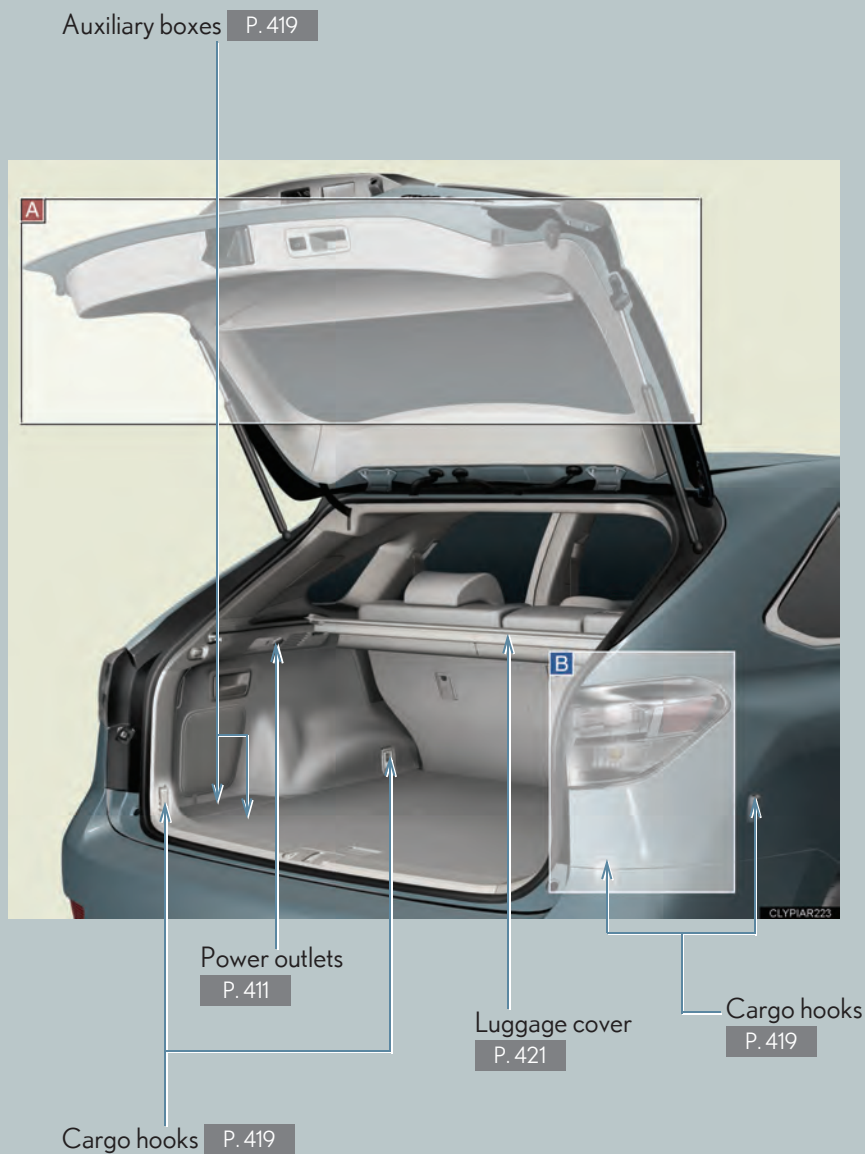

A

Power back door switch * P. 47



B

Luggage compartment lights P. 50



Rear seatback lock release lever P. 64

Height selector switch * P. 219

*: If equipped

For your information

Main Owner's Manual

Please note that this manual applies to all models and explains all equipment, including options. Therefore, you may find some explanations for equipment not installed on your vehicle.

All specifications provided in this manual are current at the time of printing. However, because of the Lexus policy of continual product improvement, we reserve the right to make changes at any time without notice.

Depending on specifications, the vehicle shown in the illustrations may differ from your vehicle in terms of color and equipment.

Noise from under vehicle after turning off the engine

Approximately five hours after the engine is turned off, you may hear sound coming from under the vehicle for several minutes. This is the sound of a fuel evaporation leakage check and, it does not indicate a malfunction.

Accessories, spare parts and modification of your Lexus

A wide variety of non-genuine spare parts and accessories for Lexus vehicles are currently available in the market. You should know that Toyota does not warrant these products and is not responsible for their performance, repair, or replacement, or for any damage they may cause to, or adverse effect they may have on, your Lexus vehicle.

This vehicle should not be modified with non-genuine Lexus products. Modification with non-genuine Lexus products could affect its performance, safety or durability, and may even violate governmental regulations. In addition, damage or performance problems resulting from the modification may not be covered under warranty.

Installation of a mobile two-way radio system

As the installation of a mobile two-way radio system in your vehicle could affect electronic systems such as the multiport fuel injection system/sequential multiport fuel injection system, cruise control system, anti-lock brake system, SRS airbag system and seat belt pretensioner system, be sure to check with your Lexus dealer for precautionary measures or special instructions regarding installation.

Scrapping of your Lexus

The SRS airbag and seat belt pretensioner devices in your Lexus contain explosive chemicals. If the vehicle is scrapped with the airbags and seat belt pretensioners left as they are, this may cause an accident such as fire. Be sure to have the systems of the SRS airbag and seat belt pretensioner removed and disposed of by a qualified service shop or by your Lexus dealer before you scrap your vehicle.

Perchlorate Material

Special handling may apply, See www.dtsc.ca.gov/hazardouswaste/perchlorate.

Your vehicle has components that may contain perchlorate. These components may include airbag, seat belt pretensioners, and wireless remote control batteries.

CAUTION

■ General precautions while driving

Driving under the influence: Never drive your vehicle when under the influence of alcohol or drugs that have impaired your ability to operate your vehicle. Alcohol and certain drugs delay reaction time, impair judgment and reduce coordination, which could lead to an accident that could result in death or serious injury.

Defensive driving: Always drive defensively. Anticipate mistakes that other drivers or pedestrians might make and be ready to avoid accidents.

Driver distraction: Always give your full attention to driving. Anything that distracts the driver, such as adjusting controls, talking on a cellular phone or reading can result in a collision with resulting death or serious injury to you, your occupants or others.

■ General precaution regarding children's safety

Never leave children unattended in the vehicle, and never allow children to have or use the key.

Children may be able to start the vehicle or shift the vehicle into neutral. There is also a danger that children may injure themselves by playing with the cigarette lighter, the windows, the moon roof, or other features of the vehicle. In addition, heat build-up or extremely cold temperatures inside the vehicle can be fatal to children.

Symbols used throughout this manual

Cautions & Notices

CAUTION

This is a warning against something which, if ignored, may cause injury to people. You are informed about what you must or must not do in order to reduce the risk of injury to yourself and others.

NOTICE

This is a warning against something which, if ignored, may cause damage to the vehicle or its equipment. You are informed about what you must or must not do in order to avoid or reduce the risk of damage to your Lexus and its equipment.

Symbols used in illustrations





Safety symbol

The symbol of a circle with a slash through it means “Do not”, “Do not do this”, or “Do not let this happen”.



Arrows indicating operations

 Indicates the action (pushing, turning, etc.) used to operate switches and other devices.

 Indicates the outcome of an operation (e.g. a lid opens).

1-1. Key information	1-5. Refueling
Keys 24	Opening the fuel tank cap 92
1-2. Opening, closing and locking the doors	1-6. Theft deterrent system
Smart access system with push-button start 29	Engine immobilizer system.... 96
Wireless remote control 40	Alarm..... 98
Side doors..... 44	Theft prevention labels (for U.S.A.) 100
Back door 47	1-7. Safety information
1-3. Adjustable components (seats, mirrors, steering wheel)	Correct driving posture 101
Front seats 58	SRS airbags 103
Rear seats 63	Front passenger occupant classification system..... 115
Driving position memory 67	Child restraint systems 120
Head restraints 70	Installing child restraints..... 124
Seat belts 72	
Steering wheel..... 80	
Anti-glare inside rear view mirror 82	
Outside rear view mirrors 83	
1-4. Opening and closing the windows and moon roof	
Power windows 86	
Moon roof 89	

1-1. Key information

Keys

The following keys are provided with the vehicle.

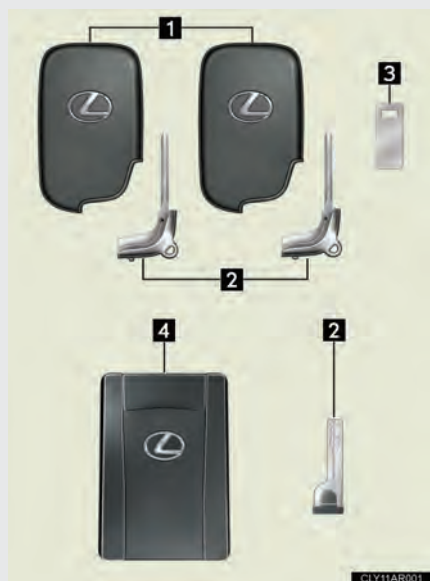

1 Electronic keys

- Operating the smart access system with push-button start (→P. 29)
- Operating the wireless remote control function (→P. 40)

2 Mechanical keys

3 Key number plate

4 Card key (electronic key) (if equipped)

Operating the smart access system with push-button start (→P. 29)

The card key comes with an information card that includes instructions for use. Lexus recommends that you carry the information card with the card key.

Using the mechanical key



To take out the mechanical key:

Electronic keys: Slide the release lever and take the key out.

Card key: Press the lock release button and take the key out.

If the key cannot be inserted in a lock cylinder, turn it over and re-attempt to insert it. Mechanical keys with grooves on one side can be inserted in one direction only.

After using the mechanical key, store it in the electronic key. Carry the mechanical key together with the electronic key. If the electronic key battery is depleted or the entry function does not operate properly, you will need the mechanical key. (→P. 572)

1

Before driving

■ Card key

- The mechanical key that is stored inside the card key should be used only if a problem arises, such as when the key does not operate properly.
- If it is difficult to take out the mechanical key, press down the lock release button using a pen tip etc. If it is still difficult to pull it out, use a coin etc.



- To store the mechanical key in the card key, insert it while pressing the lock release button.



- If the battery cover is not installed and the battery falls out or if the battery was removed because the key got wet, reinstall the battery with the positive terminal facing the Lexus emblem.

- The card key is not waterproof.

■ When required to leave the vehicle's key with a parking attendant

Lock the glove box as circumstances demand. (→P. 398)

Remove the mechanical key for your own use and provide the attendant with the electronic key only.

■ Key number plate

Keep the plate in a safe place such as your wallet, not in the vehicle. In the event that a mechanical key is lost, a new key can be made at your Lexus dealer using the key number plate. (→P. 571)

■ When riding in an aircraft

When bringing an electronic key onto an aircraft, make sure you do not press any buttons on the electronic key while inside the aircraft cabin. If you are carrying an electronic key in your bag etc, ensure that the buttons are not likely to be pressed accidentally. Pressing a button may cause the electronic key to emit radio waves that could interfere with the operation of the aircraft.

 NOTICE**■ To prevent key damage**

Observe the following:

- Do not drop the keys, subject them to strong shocks or bend them.
- Do not expose the keys to high temperatures for a long period of time.
- Do not get the keys wet or wash them in an ultrasonic washer etc.
- Do not attach metallic or magnetic materials to the keys or place the keys close to such materials.
- Do not disassemble the keys.
- Do not attach a sticker or anything else to the surface of the electronic key.
- Do not place the keys near objects that produce magnetic fields, such as TVs, audio systems, glass top ranges, or medical electrical equipment, such as low-frequency therapy equipment.

■ Carrying the electronic key on your person

Carry the electronic key 3.9 in. (10 cm) or more away from electric appliances that are turned on.

■ In case of a smart access system with push-button start malfunction or other key-related problems

Take your vehicle with all the electronic keys provided with your vehicle, including the card key, to your Lexus dealer.

■ When a vehicle key is lost

If the key remains lost, the risk of vehicle theft increases significantly. Visit your Lexus dealer immediately with all remaining electronic keys and the card key that was provided with your vehicle.

NOTICE

■ Precautions for handling the card key

- Do not apply excess force when inserting the mechanical key to the card key. Doing so may damage the card key.
- If the battery or card key terminals get wet, the battery may corrode. If the key is dropped into water, or if drinking water etc. is spilled on the key, immediately remove the battery cover and wipe the battery and terminals. (To remove the battery cover, lightly grasp and pull it.) If the battery is corroded, have your Lexus dealer replace the battery.
- Do not crush the battery cover or use a screwdriver to remove the battery cover. Forcibly removing the battery cover may bend or damage the key.
- If the battery cover is frequently removed, the battery cover may become loose.
- When installing the battery, make sure to check the direction of the battery. Installing the battery in the wrong direction may cause the battery to deplete rapidly.
- The surface of the card key may be damaged, or its coating may peel off in the following situations:
 - The card key is carried together with hard objects, such as coins and keys.
 - The card key is scraped with a sharp object, such as the tip of a mechanical pencil.
 - The surface of the card key is wiped with thinner or benzene.

1-2. Opening, closing and locking the doors

Smart access system with push-button start

The following operations can be performed simply by carrying the electronic key (including the card key) on your person, for example in your pocket.

(The driver should always carry the electronic key.)

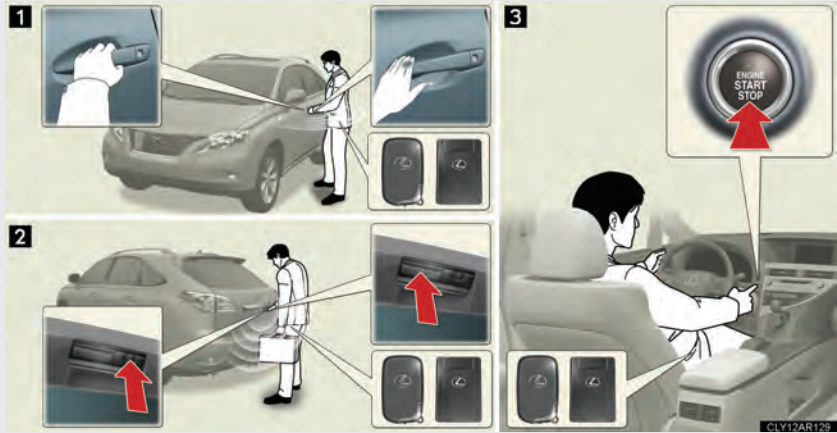

1 Locks and unlocks the side doors (→P. 30)

2 Locks and unlocks the back door (→P. 30)

3 Starts the engine (→P. 145)

Unlocking and locking the side doors (front door handles only)

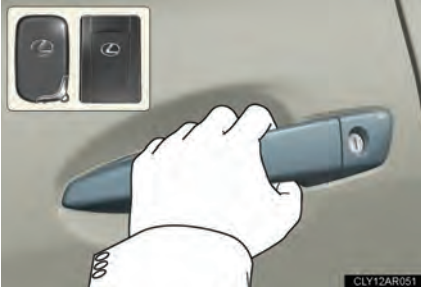

Grip the handle to unlock the door.

Make sure to touch the sensor on the back of the handle.

The doors cannot be unlocked for 3 seconds after the doors are locked.

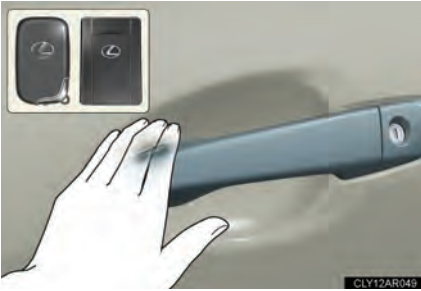

Touch the lock sensor (the indentation on the upper part of the door handle) to lock the doors.

Unlocking and locking the back door



Press the button to unlock the door.

The door cannot be unlocked for 3 seconds after the door is locked.



Press the button to lock the door.

1

Before driving

Antenna location and effective range

■ Antenna location

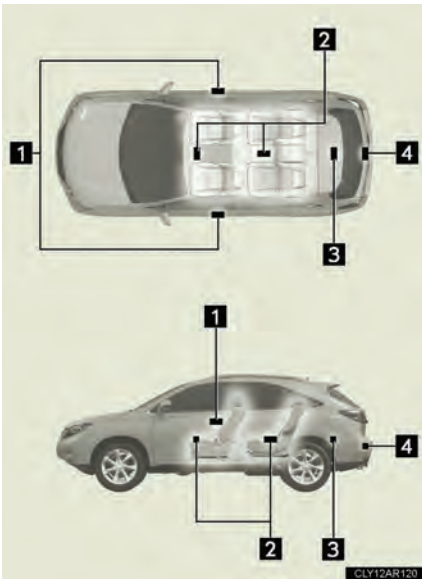

- 1 Antennas outside the cabin
- 2 Antennas inside the cabin
- 3 Antenna inside the luggage compartment
- 4 Antenna outside the luggage compartment

■ Effective range (areas within which the electronic key is detected)

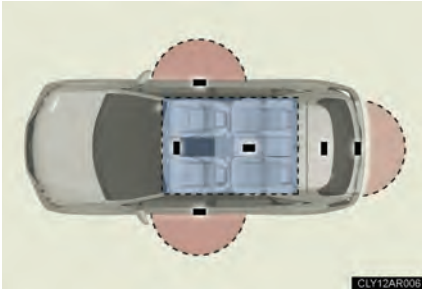

- When locking or unlocking the doors

The system can be operated when the electronic key is within about 2.3 ft. (0.7 m) of an outside door handle. (Only the doors detecting the key can be operated.)

- When starting the engine or changing "ENGINE START STOP" switch modes

The system can be operated when the electronic key is inside the vehicle.

■ Operation signals

A buzzer sounds and the emergency flashers flash to indicate that the doors have been locked/unlocked. (Locked: Once; Unlocked: Twice)

■ When the door cannot be locked by the lock sensor on the upper part of the door handle



Touch both lock sensors on the upper and lower part of the door handle simultaneously.

■ Alarms and warning indicators

A combination of exterior and interior alarms as well as warning messages shown on the multi-information display is used to prevent theft of the vehicle and accidents resulting from erroneous operation. Take appropriate measures in response to any warning message on the multi-information display. (→P. 536)

The following table describes circumstances and correction procedures when only alarms are sounded.

Alarm	Situation	Correction procedure
Exterior alarm sounds once for 10 seconds.	An attempt was made to lock the vehicle while a door was open.	Close all of the doors and lock the doors again.
Interior alarm pings repeatedly	The "ENGINE START STOP" switch was turned to ACCESSORY mode while the driver's door is open (The driver's door was opened when the "ENGINE START STOP" switch is in ACCESSORY mode.)	Close the driver's door.
	The "ENGINE START STOP" switch was turned off while the driver's door is open.	Close the driver's door.

■ Security feature

If a door is not opened within approximately 60 seconds after the vehicle is unlocked, the security feature automatically locks the vehicle again.

■ Battery-saving function

In the following circumstances, the entry function is disabled in order to prevent the vehicle battery from discharging and the electronic key battery from depleting.

- When the entry function has not been used for 5 days or more
- When the electronic key has been left within approximately 6 ft. (2 m) of the vehicle for 10 minutes or more
- If the entry function has not been used for 14 days or more, the vehicle cannot be unlocked by a door other than the driver's door. To unlock the vehicle, grip the driver's door handle or use the wireless remote control or the mechanical key.

The system will resume operation when:

- The vehicle is locked using the lock sensor.
- The vehicle is locked/unlocked using the wireless remote control function. (→P. 40)
- The vehicle is locked/unlocked using the mechanical key. (→P. 572)

■ Conditions affecting operation

The smart access system with push-button start uses weak radio waves. In the following situations, the communication between the electronic key and the vehicle may be affected, preventing the smart access system with push-button start, wireless remote control and immobilizer system from operating properly.

(Ways of coping: →P. 572)

- When the electronic key battery is depleted
- Near a TV tower, electric power plant, gas station, radio station, large display, airport or other facility that generates strong radio waves or electrical noise
- When carrying a portable radio, cellular phone, cordless phone or other wireless communication devices
- When the electronic key is in contact with, or is covered by the following metallic objects
 - Cards to which aluminum foil is attached
 - Cigarette boxes that have aluminum foil inside
 - Metallic wallets or bags
 - Coins
 - Hand warmers made of metal
 - Media such as CDs and DVDs

- When multiple electronic keys are in the vicinity
- When another wireless key (that emits radio waves) is being used nearby
- When carrying the electronic key together with the following devices that emit radio waves
 - Another vehicle's electronic key or a wireless key that emits radio waves
 - Personal computers or personal digital assistants (PDAs)
 - Digital audio players
 - Portable game systems
- If window tint with a metallic content or metallic objects are attached to the rear window

■ Note for the entry function

- Even when the electronic key is within the effective range (detection areas), the system may not operate properly in the following cases:
 - The electronic key is too close to the window or outside door handle, near the ground, or in a high place when the doors are locked or unlocked.
 - The electronic key is on the instrument panel, luggage cover or floor, or in the glove box.
- As long as the electronic key is within the effective range, the doors may be locked or unlocked by anyone. However, only the doors detecting the electronic key can be used to unlock the vehicle.
- The doors may lock or unlock if the electronic key is within the effective range and a large amount of water splashes on the door handle, such as in the rain or in a car wash. The doors will automatically be locked after approximately 60 seconds if a door is not opened and closed.
- If the wireless remote control is used to lock the doors when the electronic key is near the vehicle, there is a possibility that the door may not be unlocked by the entry function. (Use the wireless remote control to unlock the doors.)

■ Notes for locking the doors

- Touching the door lock sensor while wearing gloves may delay or prevent lock operation. Remove the gloves and touch the lock sensor again.
- When the lock operation is performed using the lock sensor, recognition signals will be shown up to two consecutive times. After this, no recognition signals will be given.
- If the door handle becomes wet while the electronic key is within the effective range, the door may lock and unlock repeatedly. Place the key in a position 6 ft. (2 m) or more separate from the vehicle while the vehicle is being washed. (Take care to ensure that the key is not stolen.)
- If the electronic key is inside the vehicle and a door handle becomes wet during a car wash, a message may be shown on the multi-information display and a buzzer will sound outside the vehicle. To turn off the alarm, lock all the doors.
- The lock sensor may not work properly if it comes into contact with ice, snow, mud, etc. Clean the lock sensor and attempt to operate it again, or use the lock sensor on the lower part of the door handle.
- Fingernails may scrape against the door during operation of the door handle. Be careful not to injure fingernails or damage the surface of the door.

■ Notes for the unlocking function

- Gripping the door handle when wearing a glove may not unlock the door.
- A sudden approach to the effective range or door handle may prevent the doors from being unlocked. In this case, return the door handle to the original position and check that the doors unlock before pulling the door handle again.
- If there is another electronic key in the detection area, it may take slightly longer to unlock the doors after the door handle is gripped.

■ When the vehicle is not driven for extended periods

- To prevent theft of the vehicle, do not leave the electronic key within 6 ft. (2 m) of the vehicle.
- The smart access system with push-button start can be deactivated in advance. (→P. 610)

■ To operate the system properly

Make sure to carry the electronic key when operating the system. Do not get the electronic key too close to the vehicle when operating the system from the outside of the vehicle.

Depending on the position and holding condition of the electronic key, the key may not be detected correctly and the system may not operate properly. (The alarm may go off accidentally, or the door lock prevention may not function.)

■ If the smart access system with push-button start does not operate properly

- Locking and unlocking the doors: Use the mechanical key. (→P. 572)
- Starting the engine: →P. 573

■ Electronic key battery depletion

- The standard battery life is 1 to 2 years. (The card key battery life is about a year and a half.)
- As the electronic key always transmits radio waves, the battery will become depleted even if the electronic key is not used. The following symptoms indicate that the electronic key battery may be depleted. Replace the battery when necessary. (→P. 488)
 - The smart access system with push-button start or the wireless remote control does not operate.
 - The detection area becomes smaller.
 - The LED indicator on the key surface does not turn on.
- To avoid serious deterioration, do not leave the electronic key within 3 ft. (1 m) of the following electrical appliances that produce a magnetic field:
 - TVs
 - Personal computers
 - Cellular phones, cordless phones and battery chargers
 - Recharging cellular phones or cordless phones
 - Glass top ranges
 - Table lamps

■ When the electronic key battery is fully depleted

→P. 488

■ Customization

Settings (e.g. smart access system with push-button start) can be changed.
(Customizable features →P. 610)

■ Certification for the smart access system with push-button start

► For vehicles sold in the U.S.A.

FCC ID: NI4TMLF8-6

FCC ID: HYQ13CZF

FCC ID: HYQ14ACX

FCC ID: HYQ14AEB

FCC ID: HYQ14ACX

FCC ID: HYQ14AEB

FCC ID: HYQ13CZF

NOTE:

This device complies with Part 15 of the FCC Rules. Operation is subject to the following two conditions: (1) this device may not cause harmful interference, and (2) this device must accept any interference received, including interference that may cause undesired operation.

FCC WARNING:

Changes or modifications not expressly approved by the party responsible for compliance could void the user's authority to operate the equipment.

► For vehicles sold in Canada

NOTE:

Operation is subject to the following two conditions; (1) this device may not cause interference, and (2) this device must accept any interference, including interference that may cause undesired operation of the device.

 **CAUTION****■ Caution regarding interference with electronic devices**

- People with implanted pacemakers or cardiac defibrillators should keep away from the smart access system antennas. (→P. 31)

The radio waves may affect the operation of such devices. If necessary, the entry function can be disabled. Ask your Lexus dealer for details, such as the frequency of radio waves and timing of emitting the radio waves. Then, consult your doctor to see if you should disable the entry function.

- User of any electrical medical device other than implanted pacemakers and implanted cardiac defibrillators should consult the manufacturer of the device for information about its operation under the influence of radio waves.

Radio waves could have unexpected effects on the operation of such medical devices.

Ask your Lexus dealer for disabling the entry function.

1-2. Opening, closing and locking the doors

Wireless remote control

The wireless remote control can be used to lock and unlock the vehicle. It also opens and closes the back door.

► Vehicles without a power back door



1 Locks all the doors

2 Unlocks all the doors

Pressing the button unlocks the driver's door. Pressing the button again within 3 seconds unlocks the other doors.

3 Opens the windows and moon roof (press and hold)*

4 Sounds the alarm (press and hold) (→P. 42)

*: This setting must be customized at your Lexus dealer.

► Vehicles with a power back door



- 1 Locks all the doors
- 2 Unlocks all the doors

Pressing the button unlocks the driver's door. Pressing the button again within 3 seconds unlocks the other doors.

- 3 Opens the windows and moon roof (press and hold)*
- 4 Opens and closes the back door (press and hold)
- 5 Sounds the alarm (press and hold) (→P. 42)

*: This setting must be customized at your Lexus dealer.

■ Operation signals

Side doors: A buzzer sounds and the emergency flashers flash to indicate that the doors have been locked/unlocked. (Locked: Once; Unlocked: Twice)

Back door: A buzzer sounds and the emergency flashers flash twice to indicate that the back door is opening/closing.

Windows and moon roof: A buzzer sounds to indicate that the windows and moon roof are opening.

■ Door lock buzzer

If an attempt to lock the doors is made when a door is not fully closed, a buzzer sounds continuously. Fully close the door to stop the buzzer, and lock the vehicle once more.

■ Security feature

→P. 33

■ Panic mode



When  is pressed for longer than about one second, an alarm will sound intermittently and the vehicle lights will flash to deter any person from trying to break into or damage your vehicle.

To stop the alarm, press any button on the electronic key.

■ Back door operation

The back door can be opened even if it is locked. Lock the back door again when you leave the vehicle. The back door will not lock automatically after it has been opened and then closed.

■ Alarm

Using the wireless remote control to lock the doors will set the alarm system. (→P. 98)

■ Reversing the operation of the power back door

Pressing the wireless remote control switch again while the power back door is operating will cause the operation to reverse.

■ Conditions affecting operation

→P. 34

■ If the wireless remote control does not operate properly

Locking and unlocking the doors: Use the mechanical key. (→P. 572)

■ Electronic key battery depletion

→P. 37

■ When the electronic key battery is fully depleted

→P. 488

■ Customization

Settings (e.g. door unlocking function) can be changed.
(Customizable features →P. 610)

■ Certification for wireless remote control

► For vehicles sold in the U.S.A.

FCC ID: NI4TMLF8-6

FCC ID: HYQ13CZF

FCC ID: HYQ14ACX

FCC ID: HYQ14AEB

FCC ID: HYQ14ACX

FCC ID: HYQ14AEB

FCC ID: HYQ13CZF

NOTE:

This device complies with Part 15 of the FCC Rules. Operation is subject to the following two conditions: (1) this device may not cause harmful interference, and (2) this device must accept any interference received, including interference that may cause undesired operation.

FCC WARNING:

Changes or modifications not expressly approved by the party responsible for compliance could void the user's authority to operate the equipment.

► For vehicles sold in Canada

NOTE:

Operation is subject to the following two conditions; (1) this device may not cause interference, and (2) this device must accept any interference, including interference that may cause undesired operation of the device.

1-2. Opening, closing and locking the doors

Side doors

The vehicle can be locked and unlocked using the entry function, wireless remote control or door lock switch.

■ Entry function

→P. 30

■ Wireless remote control

→P. 40

■ Door lock switches



- 1 Locks all the doors
- 2 Unlocks all the doors

■ Inside lock button

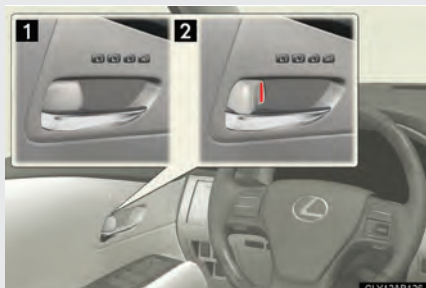

- 1 Locks the door
- 2 Unlocks the door

The front doors can be opened by pulling the inside handle even if the lock buttons are in the lock position.

Locking the front doors from the outside without a key

STEP 1 Move the inside lock button to the lock position.

STEP 2 Close the door.

The door cannot be locked if the “ENGINE START STOP” switch is in ACCESSORY or IGNITION ON mode, or the electronic key is left inside the vehicle.

The key may not be detected correctly and the door may be locked.

Rear door child-protector lock



The door cannot be opened from inside the vehicle when the lock is set.

These locks can be set to prevent children from opening the rear doors. Push down on each rear door switch to lock both rear doors.

■ Impact detection door lock release system

In the event that the vehicle is subject to a strong impact, all the doors are unlocked. Depending on the force of the impact or the type of accident, however, the system may not operate.

■ Using the mechanical key

The doors can also be locked and unlocked with the mechanical key. (→P. 572)

■ If a wrong key is used

The key cylinder rotates freely to isolate inside mechanism.

■ Customization

Settings (e.g. unlocking function using a key) can be changed.
(Customizable features →P. 610)

CAUTION

■ To prevent an accident

Observe the following precautions while driving the vehicle.

Failure to do so may result in a door opening and an occupant falling out, resulting in death or serious injury.

- Always use a seat belt.
- Always lock all the doors.
- Ensure that all the doors are properly closed.
- Do not pull the inside handle of the doors while driving.

The doors may be opened and the passengers are thrown out of the vehicle and it may result in serious injury or death.

Be especially careful for the front doors, as the doors may be opened even if the inside lock buttons are in locked position.

- Set the rear door child-protector locks when children are seated in the rear seats.

■ When opening or closing a door

Check the surroundings of the vehicle such as whether the vehicle is on an incline, whether there is enough space for a door to open and whether a strong wind is blowing.

When opening or closing the door, hold the door handle tightly to prepare for any unpredictable movement.

Back door

The back door can be locked/unlocked and opened/closed by the following procedures.

■ Locking and unlocking the back door

- ▶ Door lock switch
→P. 44
- ▶ Entry function
→P. 29
- ▶ Wireless remote control
→P. 40

■ Opening the back door from outside the vehicle

- ▶ Back door opener button

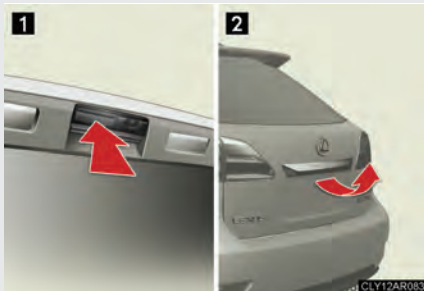

- 1 Press the back door opener button to release the lock.
- 2 Raise the back door.

- ▶ Wireless remote control (vehicles with a power back door)
→P. 40

■ Opening the back door from inside the vehicle (vehicles with a power back door)



Press the switch to open/close.

Pressing the switch again while the power back door is operating will cause the operation to reverse.

Power back door switch (vehicles with a power back door)



Press the switch to close the back door.

Pressing the switch again while the power back door is closing will cause it to open again.

Canceling the power back door system (vehicles with a power back door)

Turn off the main switch in the glove box to disable the power back door system.

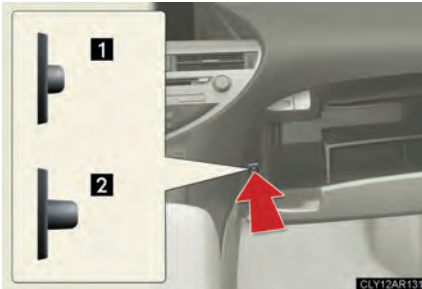

- 1 On
- 2 Off

The back door cannot be opened even with the wireless remote control or power back door switch.

1

Before driving

■ The power back door can be operated when

- The back door is unlocked. (Except for using the wireless remote control)
- The power back door main switch is on.
- To open the power back door when the “ENGINE START STOP” switch is in IGNITION ON mode, the power back door main switch must be on, the vehicle speed must be lower than 1 mph (3 km/h) and the shift lever must be in P.

■ Back door handle

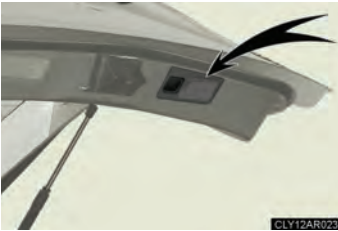

Use the back door handle when lowering the back door.

Do not close the back door fully while still holding the door handle as an injury may result.

■ Luggage compartment lights

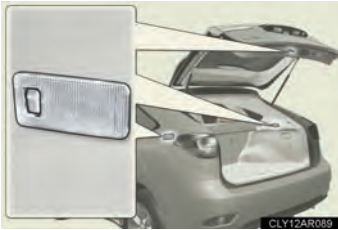

The luggage compartment lights turn on when the back door is opened with the luggage compartment light switch on.

■ Back door closer (vehicles with a power back door)

In the event that the back door is left slightly open, the back door closer will automatically close it to the fully closed position.

- The back door closer will operate regardless of the “ENGINE START STOP” switch mode.
- The back door can be opened while the back door closer is operating by pressing the back door opener button.

■ Power back door operation

- A buzzer sounds and the emergency flashers flash twice to indicate that the back door is opening/closing.
- The back door can still be opened and closed manually, even when the power back door main switch is off.
- Pressing the back door opener button while the power back door system is operating will cause the back door to switch to manual operation.
- If anything obstructs the power back door while it is closing/opening, a buzzer will sound and the back door will automatically operate in the opposite direction.
- If two or more successive attempts are made to close the back door, a buzzer will sound and the back door will switch to manual operation.

■ Jam protection function (vehicles with a power back door)



Sensors are attached to the left and right sides of the power back door. If these sensors detect an obstruction while the power back door is closing, the jam protection function will return the door to the fully open position.

■ After the back door has been opened and then closed

Lock the back door again as the back door will not lock automatically.

■ Luggage mode (vehicles with electronically modulated air suspension)

Pressing the vehicle height selector switch to lower the vehicle height makes loading luggage easier. (→P. 219)

■ If the back door opener is inoperative

The back door can be opened from the inside.

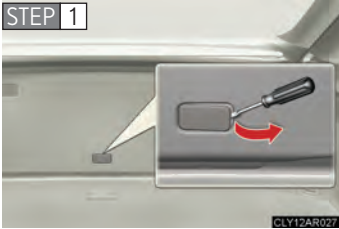

Remove the cover.

STEP 2 Move the lever.

► Vehicles with a power back door



► Vehicles without a power back door



■ When re-connecting the battery or changing a fuse

To enable the power back door system to operate properly, perform the following procedures to initialize the system:

- Unlock the back door using the door lock switch.
- Lower the back door manually using the back door handle and fully close the back door by pushing it down.

 **CAUTION****■ Caution while driving**

- Keep the back door closed while driving.

If the back door is left open, it may hit near-by objects while driving or luggage may be unexpectedly thrown out, causing an accident.

In addition, exhaust gases may enter the vehicle, causing death or a serious health hazard. Make sure to close the back door before driving.

- Before driving the vehicle, make sure that the back door is fully closed. If the back door is not fully closed, it may open unexpectedly while driving, causing an accident.
- Never let anyone sit in the luggage compartment. In the event of sudden braking or a collision, they are susceptible to death or serious injury.

■ When children are in the vehicle

Observe the following precautions.

Failure to do so may result in death or serious injury.

- Do not leave children alone in the luggage compartment.

If a child is accidentally locked in the luggage compartment, they could overheat.

- Do not allow a child to open or close the back door.

Doing so may cause the back door to operate unexpectedly, or cause the child's hands, head, or neck to be caught by the closing back door, which may result in death or serious injury of the child.

■ Operating the back door

Observe the following precautions.

Failure to do so may cause parts of the body to be caught, resulting in serious injury.

- Remove any heavy loads, such as snow and ice, from the back door before opening it. Failure to do so may cause the back door fall closed again after it is opened.

CAUTION

- When opening or closing the back door, thoroughly check to make sure the surrounding area is safe.
- If anyone is in the vicinity, make sure they are safe and let them know that the back door is about to open or close.
- Use caution when opening or closing the back door in windy weather as it may move abruptly in strong wind.



- The back door may fall if it is not opened fully. It is more difficult to open or close the back door on an incline than on a level surface, so beware of the back door unexpectedly opening or closing by itself. Make sure that the back door is fully open and secure before using the luggage compartment.
- When closing the back door, take extra care to prevent your fingers etc. from being caught.
- When closing the back door, make sure to press it lightly on its outer surface. If the back door strap is used to fully close the back door, it may result in hands or arms being caught.

- Do not pull on the back door damper stay to close the back door, and do not hang on the back door damper stay. Doing so may cause hands to be caught or the back door damper stay to break, causing an accident.
- Do not attach any accessories other than genuine Lexus parts to the back door. Such additional weight on the back door may cause the back door to fall closed again after it is opened.

⚠ CAUTION

■ Back door closer



- In the event that the back door is left slightly open, the back door closer will automatically close it to the fully closed position. It takes several seconds before the back door closer begins to operate. Be careful not to catch fingers or anything else in the back door, as this may cause bone fractures or other serious injuries.

- Use caution when using the back door closer as it still operates when the power back door system is cancelled.

■ Power back door

Observe the following precautions when operating the power back door. Failure to do so may cause serious injury.

- Check the safety of the surrounding area to make sure there are no obstacles or anything that could cause any of your belongings to get caught.
- If anyone is in the vicinity, make sure they are safe and let them know that the back door is about to open or close.
- If the operating conditions of the power back door are no longer met, a buzzer may sound and the back door may stop opening or closing. The back door then has to be operated manually. Take extra care in this situation, as the back door may move abruptly.
- If the power back door main switch is turned off while the power back door is operating, the back door will change to manual operation. In this case, be careful as the back door may move suddenly.
- On an incline, the back door may fall after it opens automatically. Make sure the back door is fully open and secure.
- In the following situations, the power back door may detect an abnormality and automatic operation may be stopped. In this case, the back door has to be operated manually. Take extra care in this situation, as the stopped back door may suddenly fall, causing an accident.
 - When the back door contacts an obstacle
 - When the battery voltage suddenly drops, such as when the "ENGINE START STOP" switch is turned to IGNITION ON mode or the engine is started during automatic operation

CAUTION

- Do not attach any accessories other than genuine Lexus parts to the back door. The power back door may not operate, causing itself to malfunction, or the back door may fall closed again after it is opened.
- In cases such as when replacing tires, make sure to turn off the power back door main switch. Failure to do so may cause the back door to operate unintentionally if the power back door switch is accidentally touched, resulting in hands and fingers being caught and injured.

■ Jam protection function

Observe the following precautions.
Failure to do so may cause serious injury.

- Be careful while the jam protection function is operating. Being hit by the back door may result in an injury.
- If anything obstructs the power back door while it is closing, the jam protection function will cause the back door to automatically operate in the opposite direction. However, be careful not to jam body parts in the doorframe, as an injury may result.
- Never use any part of your body to intentionally activate the jam protection function.
- The jam protection function may not work if something gets caught just before the back door fully closes. Be careful not to catch fingers or anything else.
- The jam protection function may not work depending on the shape of the object that is caught. Be careful not to catch fingers or anything else.
- The sensors located on the right and left sides of the power back door detect obstructions and prevent them from becoming jammed in the door. Some objects may not be detected depending on their shape or how they are jammed. Be careful not to get fingers or other body parts caught in the back door while it is operating as this may result in a serious injury.

 NOTICE

■ Back door damper stays

The back door is equipped with damper stays that hold the back door in place.

Observe the following precautions.

Failure to do so may cause damage to the back door damper stay, resulting in malfunction.



- Do not attach any foreign objects, such as stickers, plastic sheets, or adhesives to the damper stay rod.
- Do not touch the damper stay rod with gloves or other fabric items.
- Do not attach any accessories other than genuine Lexus parts to the back door.
- Do not place your hand on the damper stay or apply lateral forces to it.

■ To prevent back door closer malfunction

- Do not apply excessive force to the back door while the back door closer is operating.
- If the back door is opened and closed repeatedly in a short amount of time, the back door closer may stop operating. In this case, manually open the back door once and wait for a while before attempting to close it again.

■ To prevent damage to the power back door

- Make sure that there is no ice between the back door and frame that would prevent movement of the back door. Operating the power back door when excessive load is present on the back door may cause a malfunction.
- Do not apply excessive force to the back door while the power back door is operating.
- Take care not to damage the sensors (installed on the right and left edges of the power back door) with a knife or other sharp object. If the sensor is disconnected, the power back door will not operate in automatic operation.
- When manually closing the back door immediately after the power back door has been automatically opened fully, some resistance may be felt.

1-3. Adjustable components (seats, mirrors, steering wheel)

Front seats

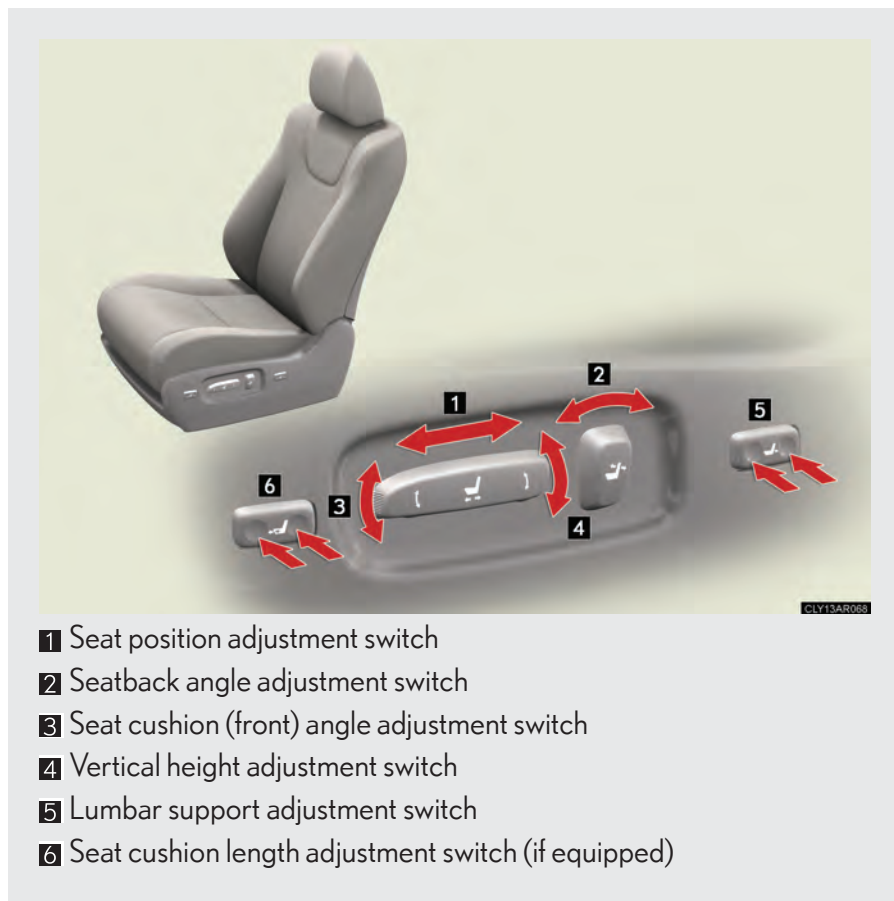

- 1 Seat position adjustment switch
- 2 Seatback angle adjustment switch
- 3 Seat cushion (front) angle adjustment switch
- 4 Vertical height adjustment switch
- 5 Lumbar support adjustment switch
- 6 Seat cushion length adjustment switch (if equipped)

Flattening the front seatbacks

■ Before flattening the front seatbacks

Slide the rear seats as far back as possible. (→P. 63)

■ Flattening the front seatbacks

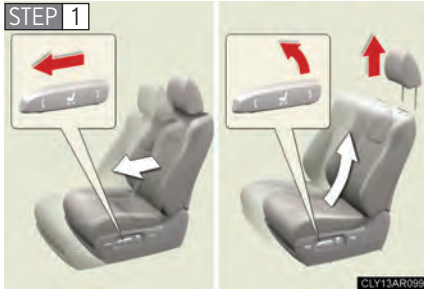

Move the front seat forward, raise the seat, and remove the head restraint (→P.70).

After returning the seat to its original position, make sure to replace the head restraint.

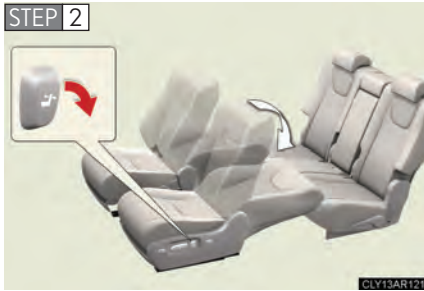

Move the seatback angle adjustment switch backward to flatten the seatback.

Power easy access system (vehicles with driving position memory)

When the driver enters and exits the vehicle, the driver's seat and steering wheel will automatically perform the following operations:



Exiting the vehicle: When all of the following actions have been performed, the steering wheel will move up and back to the point farthest away from the driver and the seat will move backward (auto away function):

- The shift lever has been shifted to P
- The “ENGINE START STOP” switch has been turned off
- The driver seat belt has been unfastened

Entering the vehicle: When either of the following actions has been performed, the steering wheel will move toward the driver and seat will move forward (auto return function):

- The “ENGINE START STOP” switch has been turned to ACCESSORY mode
- The driver seat belt has been fastened

Active head restraints

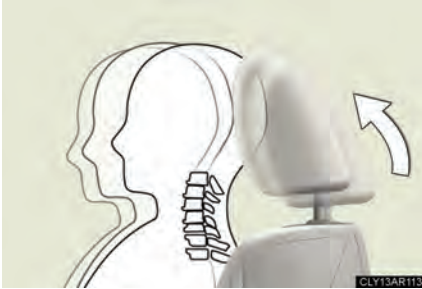

When the occupant's lower back presses against the seatback during a rear-end collision, the head restraint moves slightly forward and upward to help reduce the risk of whiplash on the seat occupant.

1
Before driving

■ The auto away function for exiting the driver seat

If the seat is already close to the rearmost position, the auto away function may not operate when the driver exits the vehicle.

■ Active head restraints

Even small forces applied to the seatback may cause the head restraint to move. Pushing up a locked head restraint forcibly may appear the head restraint inner structure. These do not indicate problems.

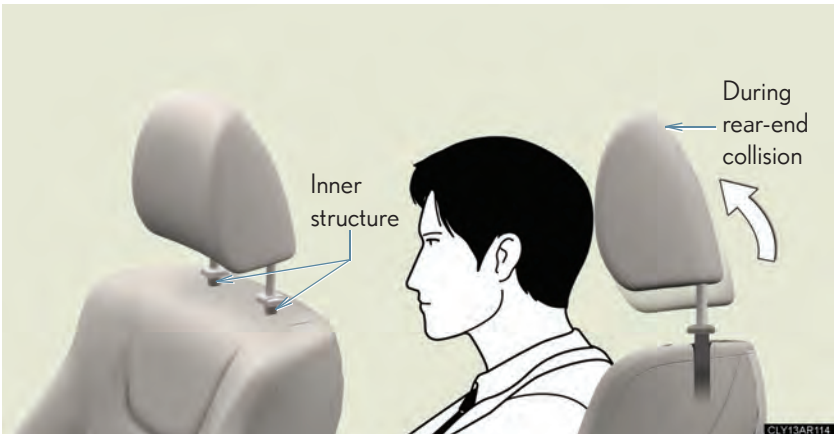

■ Customization

The distance that the driver's seat moves backward during the auto away function can be changed. (Customizable features→P. 610)

 **CAUTION**

■ **Seat adjustment**

- To reduce the risk of sliding under the lap belt during a collision, do not recline the seat more than necessary.

If the seat is too reclined, the lap belt may slide past the hips and apply restraint forces directly to the abdomen, or your neck may contact the shoulder belt, increasing the risk of death or serious injury in the event of an accident.

- Adjustments should not be made while driving as the seat may unexpectedly move and cause the driver to lose control of the vehicle.

■ **While driving**

Do not allow passengers to ride on the flattened seat.

1-3. Adjustable components (seats, mirrors, steering wheel)

Rear seats

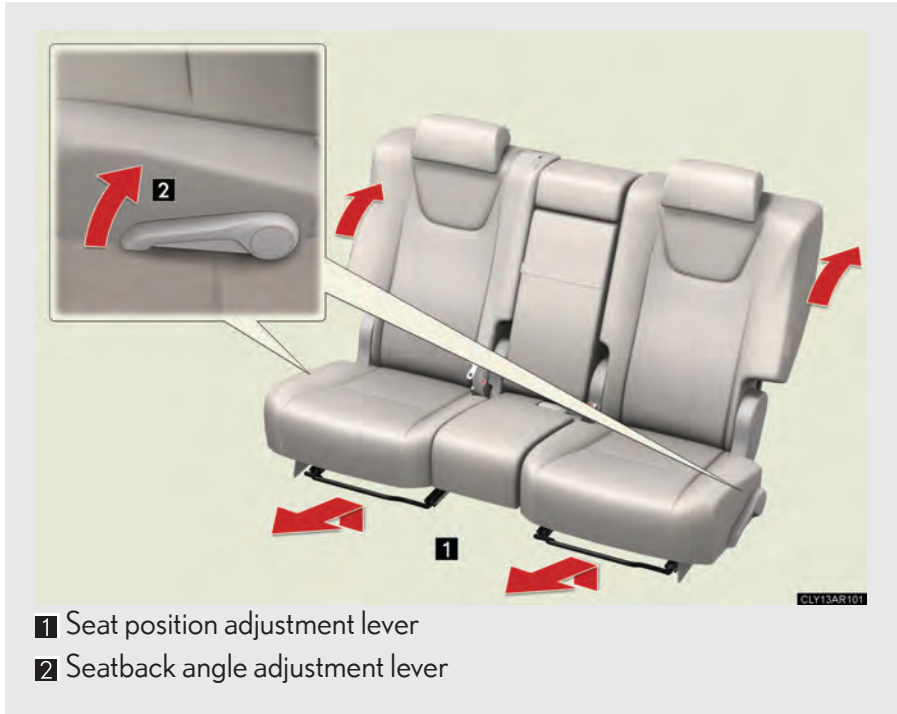

1

Before driving

Folding down the rear seatbacks

■ Before folding down the rear seatbacks



Stow all the head restraints and the rear center seat belt buckle.

1-3. Adjustable components (seats, mirrors, steering wheel)



Stow the seat belts inside the rear seat side pockets.

When not in use, the seat belts should be stored inside the rear seat side pockets at all times.

■ Folding down the rear seatbacks

► From inside

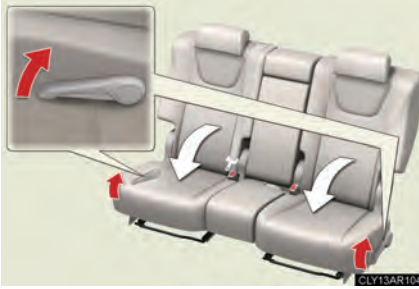

Pull the seatback angle adjustment lever.

To return the rear seatbacks to their original positions, lift them up until they lock.

► From outside

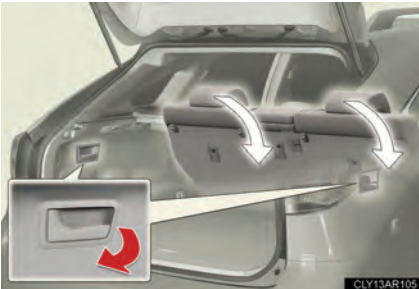

Pull the levers.

Left side lever: Folds down the left side rear seat

Right side lever: Folds down the right side and center rear seats

To return the rear seatbacks to their original positions, lift them up until they lock.

■ Folding down the rear center seatback



Pull the center seatback angle lever behind the seatback and fold the seatback down.

To return the rear center seatback to its original position, lift it up until it locks.

⚠ CAUTION

■ When folding the rear seatbacks down

Observe the following precautions. Failure to do so may result in death or serious injury.

- Do not fold the seatbacks down while driving.
- Do not fold seatbacks down while passengers are seated or luggage is placed on the seats.
- Stop the vehicle on level ground, set the parking brake and shift the shift lever to P.
- After folding the seatback, lightly move the seat back and forth to lock it in place.
- Do not allow anyone to sit on a folded seatback or in the luggage compartment while driving.
- Do not allow children to enter the luggage compartment.

■ Seat adjustment

- To reduce the risk of sliding under the lap belt during a collision, do not recline the seat more than necessary.

If the seat is too reclined, the lap belt may slide past the hips and apply restraint forces directly to the abdomen, or your neck may contact the shoulder belt, increasing the risk of death or serious injury in the event of an accident.

- Adjustments should not be made while driving as the seat may unexpectedly move and cause the driver to lose control of the vehicle.

 **CAUTION**

■ **After returning the rear seatback to the upright position**

Observe the following precautions. Failure to do so may result in death or serious injury.

- Make sure the seatback is securely locked by pushing it forward and rearward on the top.
- Check that the seat belts are not twisted or caught in the seatback.

 **NOTICE**

■ **Stowing the center seat belt buckle**

Before folding down the rear seatbacks, stow the center seat belt buckle to prevent it from becoming caught in the seatbacks.

1-3. Adjustable components (seats, mirrors, steering wheel)

Driving position memory*

Your preferred driving position (the position of the driver's seat, steering wheel and outside rear view mirrors) can be memorized and recalled with the touch of a button. It is also possible to set this function to activate automatically when the doors are unlocked.

Three different driving positions can be entered into memory.

■ Entering a position to memory

STEP 1 Turn the "ENGINE START STOP" switch to IGNITION ON mode.

STEP 2 Adjust the driver's seat, steering wheel and outside rear view mirrors to the desired positions.



Press the "SET" button, then within 3 seconds press button "1", "2" or "3" until the signal beeps.

If the selected button has already been preset, the previously recorded position will be overwritten.

■ Recalling the memorized position

STEP 1 Check that the shift lever is set in P.

STEP 2 Turn the "ENGINE START STOP" switch to IGNITION ON mode.



Press button "1", "2" or "3" until the signal beeps to recall the desired position.

*: If equipped

Linking driving position memory with door unlock operation

Record your driving position to button “1”, “2” or “3” before performing the following:

Carry only the key (including the card key) to which you want to link the driving position. If 2 or more keys are in the vehicle, the driving position cannot be linked properly.

STEP 1 Shift the shift lever to P and close the driver's door. Turn the “ENGINE START STOP” switch to IGNITION ON mode.

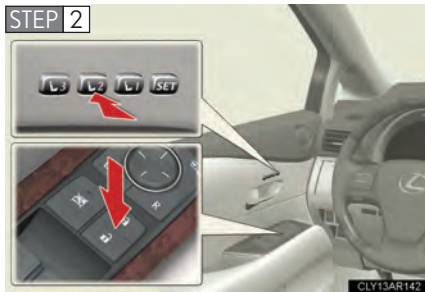

Press the desired button (“1”, “2” or “3”) to recall the position. Then, while keep pressing the button, press the driver's door lock switches (either lock or unlock) until the signal beeps.

The driving position is recalled when the driver's door is unlocked using the entry function or wireless remote control and the driver's door is opened.

■ Operating the driving position memory after turning the “ENGINE START STOP” switch off

Memorized positions (except for the steering wheel position) can be activated up to 180 seconds after the driver’s door is opened and another 60 seconds after it is closed again, even after turning the “ENGINE START STOP” switch off.

■ Canceling the linked door unlock operation

STEP 1 Turn the “ENGINE START STOP” switch to IGNITION ON mode and close the driver’s door.

STEP 2 While pressing the “SET” button, press the driver’s door lock switches (either lock or unlock) until the signal beeps.

■ Stopping seat position operation part-way through

Perform any of the following operations:

- Press the “SET” button.
- Press button “1”, “2” or “3”.
- Adjust the seat using the switches (only cancels seat position recall).
- Adjust the steering wheel using the tilt and telescopic steering control switch (only cancels steering wheel position recall).

■ Correct seat position

When the seat is in the most forward or most backward position, and the seat is being moved in those directions, the system may not correctly recognize the current position and the memorized position will not be correctly recalled.

■ When the power easy access system (→P. 60) is activated

If a seat position is memorized, the driver seat will move back the set distance (→P. 610) from that memorized position.

CAUTION

■ Seat adjustment caution

Take care during seat adjustment so that the seat does not strike the rear passenger or squeeze your body against the steering wheel.

1-3. Adjustable components (seats, mirrors, steering wheel)

Head restraints

Head restraints are provided for all seats.

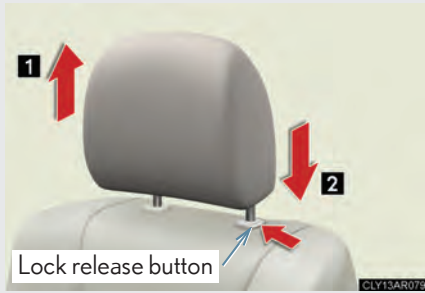

1 Up

Pull the head restraints up.

2 Down

Push the head restraint down while pressing the lock release button.

■ Removing the head restraints



Pull the head restraint up while pressing the lock release button.

■ Installing the head restraints



Align the head restraint with the installation holes and push it down to the lock position.

Press and hold the lock release button when lowering the head restraint.

■ Adjusting the height of the head restraints (front seats)



Make sure that the head restraints are adjusted so that the center of the head restraint is closest to the top of your ears.

■ Adjusting the rear seat head restraints

Always raise the head restraints to the uppermost lock position during use.

⚠ CAUTION

■ Head restraint precautions

Observe the following precautions regarding the head restraints. Failure to do so may result in death or serious injury.

- Use the head restraints designed for each respective seat.
- Adjust the head restraints to the correct position at all times.
- After adjusting the head restraints, push down on them and make sure they are locked in position.
- Do not drive with the head restraints removed.

Seat belts

Make sure that all occupants are wearing their seat belts before driving the vehicle.

■ Correct use of the seat belts



- Extend the shoulder belt so that it comes fully over the shoulder, but does not come into contact with the neck or slide off the shoulder.
- Position the lap belt as low as possible over the hips.
- Adjust the position of the seatback. Sit up straight and well back in the seat.
- Do not twist the seat belt.

■ Fastening and releasing the seat belt



- 1 To fasten the seat belt, push the plate into the buckle until a click sound is heard.
- 2 To release the seat belt, press the release button.

■ Adjusting the seat belt shoulder anchor height (front seats)

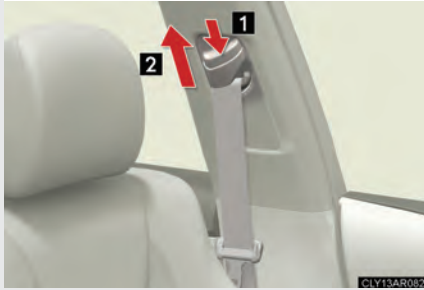

1 Push the seat belt shoulder anchor down while pressing the release button.

2 Push the seat belt shoulder anchor up.

Move the height adjuster up and down as needed until you hear a click.

1

Before driving

■ Seat belt comfort guide (outside rear seats)

If the shoulder belt sits close to a person's neck, use the seat belt comfort guide.

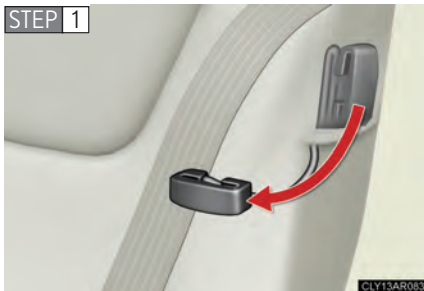

Pull the comfort guide from the pocket.

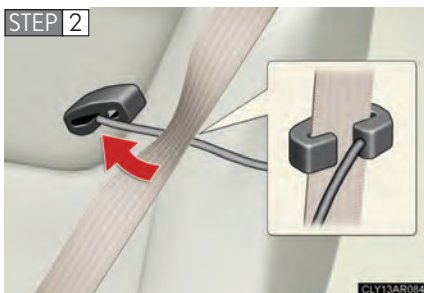

Slide the belt past the slot of the guide.

The elastic cord must be behind the seat belt.

STEP 3



Buckle the seat belt and position it comfortably.

Seat belt pretensioners (front and outside rear seats)



The pretensioner helps the seat belt to quickly restrain the occupant by retracting the seat belt when the vehicle is subjected to certain types of severe frontal collision.

The pretensioner may not activate in the event of a minor frontal impact, a side impact or a rear impact.

Pre-collision seat belts (front seats of vehicles with pre-collision system)

If the pre-collision sensor detects that a collision is unavoidable, the pre-collision system will retract the seat belt, thus enhancing the effectiveness of the seat belt pretensioner in a crash.

The same will happen if the driver makes an emergency braking or loses control of the vehicle. (→P. 237)

■ Emergency locking retractor (ELR)

The retractor will lock the belt during a sudden stop or on impact. It may also lock if you lean forward too quickly. To allow the belt to extend, retract the belt and then pull it slowly.

■ Automatic locking retractor (ALR)

When a passenger's shoulder belt is completely extended and then retracted even slightly, the belt is locked in that position and cannot be extended. This feature is used to hold the child restraint system (CRS) firmly. To free the belt again, fully retract the belt and then pull the belt out once more. (→P. 124)

■ Pregnant women



Obtain medical advice and wear the seat belt in the proper way. (→P. 72)

Women who are pregnant should position the lap belt as low as possible over the hips in the same manner as other occupants. Extend the shoulder belt completely over the shoulder and position the belt across the chest. Avoid belt contact over the round part of the abdominal area.

If the seat belt is not worn properly, not only the pregnant woman, but also the fetus could suffer death or serious injury as a result of sudden braking or a collision.

■ People suffering illness

Obtain medical advice and wear the seat belt in the proper way.

■ Child seat belt usage

The seat belts of your vehicle were principally designed for persons of adult size.

- Use a child restraint system appropriate for the child, until the child becomes large enough to properly wear the vehicle's seat belt. (→P. 120)
- When the child becomes large enough to properly wear the vehicle's seat belt, follow the instructions on P. 72 regarding seat belt usage.

■ Replacing the belt after the pretensioner has been activated

If the vehicle is involved in multiple collisions, the pretensioner will activate for the first collision, but will not activate for the second or subsequent collisions.

■ Seat belt extender



If your seat belts cannot be fastened securely because they are not long enough, a personalized seat belt extender is available from your Lexus dealer free of charge.

 **CAUTION****■ Wearing a seat belt**

Observe the following precautions to reduce the risk of injury in the event of sudden braking or an accident.

Failing to do so may cause death or serious injury.

- Ensure that all passengers wear a seat belt.
- Always wear a seat belt properly.
- Each seat belt should be used by one person only. Do not use a seat belt for more than one person at once, including children.
- Lexus recommends that children be seated in the rear seat and always use a seat belt and/or an appropriate child restraint system.
- To achieve a proper seating position, do not recline the seat more than necessary. The seat belt is most effective when the occupants are sitting up straight and well back in the seats.
- Do not wear the shoulder belt under your arm.
- Always wear your seat belt low and snug across your hips.

■ Adjustable shoulder anchor

Always make sure the shoulder belt is positioned across the center of your shoulder. The belt should be kept away from your neck, but not falling off your shoulder. Failure to do so could reduce the amount of protection in an accident and cause death or serious injuries in a collision. (→P. 73)

■ Seat belt pretensioners

- Do not place anything, such as a cushion, on the front passenger's seat. Doing so will disperse the passenger's weight, which prevents the sensor from detecting the passenger's weight properly. As a result, the seat belt pretensioner for the front passenger's seat may not activate in the event of a collision.
- If the pretensioner has activated, SRS warning light will come on. In that case, the seat belt cannot be used again and must be replaced at your Lexus dealer.

CAUTION

■ Child restraint lock function belt precaution

Do not allow children to play with the child restraint lock function belt. If the belt becomes twisted around a child's neck, it will not be possible to pull the belt out leading to choking or other serious injuries that could result in death.

If this occurs and the buckle cannot be unfastened, scissors should be used to cut the belt.

■ Seat belt damage and wear

- Do not damage the seat belts by allowing the belt, plate, or buckle to be jammed in the door.
- Inspect the seat belt system periodically. Check for cuts, fraying, and loose parts. Do not use a damaged seat belt until it is replaced. Damaged seat belts cannot protect an occupant from death or serious injury.
- Ensure that the belt and tab are locked and the belt is not twisted. If the seat belt does not function correctly, immediately contact your Lexus dealer.
- Replace the seat assembly, including the belts, if your vehicle has been involved in a serious accident, even if there is no obvious damage.
- Do not attempt to install, remove, modify, disassemble or dispose of the seat belts. Have any necessary repairs carried out by your Lexus dealer. Inappropriate handling of the pretensioner may prevent it from operating properly, resulting in death or serious injury.

■ Using a seat belt comfort guide

Failure to observe the following precautions could reduce the effectiveness of the seat belt in an accident, causing death or serious injury.

- Make sure the belt is not twisted and that it lies flat. The elastic cord must be behind the belt and the guide must be on the front.
- To reduce the chance of injury in case of an accident or a sudden stop while driving, remove and store the comfort guide in its pocket when it is not in use.
- Always make sure the shoulder belt is positioned across the center of the shoulder. The belt should be kept away from the neck, and should not fall off the shoulder.

 CAUTION

■ **Using a seat belt extender**

- Do not wear the seat belt extender if you can fasten the seat belt without the extender.
- Do not use the seat belt extender when installing a child restraint system because the belt will not securely hold the child restraint system, increasing the risk of death or serious injury in the event of an accident.
- The personalized extender may not be safe on another vehicle, when used by another person, or at a different seating position other than the one originally intended.

 NOTICE

■ **When using a seat belt extender**

When releasing the seat belt, press on the buckle release button on the extender, not on the seat belt.

This helps prevent damage to the vehicle interior and the extender itself.

1-3. Adjustable components (seats, mirrors, steering wheel)

Steering wheel

The steering wheel can be adjusted to a comfortable position.

Operating the switch moves the steering wheel in the following directions:



- 1 Up
- 2 Down
- 3 Away from the driver
- 4 Toward the driver

Auto tilt away



When the “ENGINE START STOP” switch is turned off, the steering wheel returns to its stowed position by moving up and away to enable easier driver entry and exit.

Turning the “ENGINE START STOP” switch to ACCESSORY or IGNITION ON mode will return the steering wheel to the original position.

■ The steering wheel can be adjusted when

The “ENGINE START STOP” switch is in ACCESSORY or IGNITION ON mode*.

*: Vehicles with driving position memory: If the driver's seat belt is fastened, the steering wheel can be adjusted regardless of “ENGINE START STOP” switch mode.

■ Automatic adjustment of the steering position (vehicles with driving position memory)

A desired steering position can be entered to memory and recalled automatically by the driving position memory. (→P. 67)

■ Notes for the auto tilt away function (vehicles with driving position memory)

The auto tilt away function can only operate when the “ENGINE START STOP” switch has been turned off, the driver seat belt has been unfastened and the driver's seat movement (→P. 610) is in a setting other than off.

When the driver fastens the seat belt again, the steering wheel will return to the original position. (→P. 60)

⚠ CAUTION**■ Caution while driving**

Do not adjust the steering wheel while driving.

Doing so may cause the driver to mishandle the vehicle and cause an accident, resulting in death or serious injury.

1-3. Adjustable components (seats, mirrors, steering wheel)

Anti-glare inside rear view mirror

In automatic mode, sensors are used to detect the headlights of vehicles behind and the reflected light is automatically reduced.

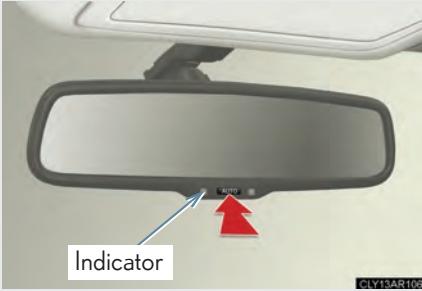

Turns automatic mode on/ off

The indicator comes on when automatic mode is turned on.

The mirror will revert to automatic mode each time the "ENGINE START STOP" switch is turned to IGNITION ON mode.

■ To prevent sensor error



To ensure that the sensors operate properly, do not touch or cover them.

⚠ CAUTION

■ Caution while driving

Do not adjust the position of the mirror while driving.

Doing so may lead to mishandling of the vehicle and cause an accident, resulting in death or serious injury.

1-3. Adjustable components (seats, mirrors, steering wheel)

Outside rear view mirrors

Mirror angle can be adjusted using the switch.

STEP 1



To select a mirror to adjust, press the switch.

- 1 Left
- 2 Right

Pressing the same switch again will put the switch in neutral.

STEP 2



To adjust the mirror, press the switch.

- 1 Up
- 2 Right
- 3 Down
- 4 Left

Manually folding and extending the mirrors



Push the mirror back in the direction of the vehicle's rear.

Automatically folding and extending the mirrors (if equipped)

■ Using the switch



Press the switch to fold the mirrors.

Press it again to return them.

■ Setting automatic mode

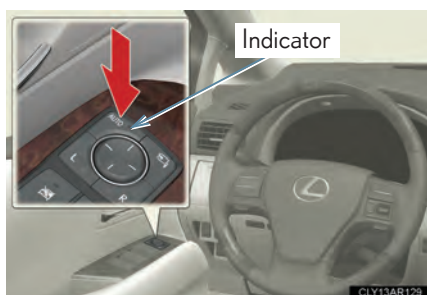

Automatic mode allows the folding or extending of the mirrors to be linked to locking/unlocking of the doors.

Press the "AUTO" button to set automatic mode.

The indicator will come on.

■ Mirror angle can be adjusted when

The "ENGINE START STOP" switch is in ACCESSORY or IGNITION ON mode.

■ Linked mirror function when reversing

The outside rear view mirrors will automatically angle downwards when the vehicle is reversing in order to give a better view of the ground. This function only operates when either the "L" or "R" mirror select button is selected.

■ When the mirrors are fogged up

Turn on the mirror defoggers to defog the mirrors. (→P. 279)

■ **Automatic adjustment of the mirror angle (vehicles with driving position memory)**

A desired mirror face angle can be entered to memory and recalled automatically by the driving position memory. (→P. 67)

■ **Auto anti-glare function (if equipped)**

When the anti-glare inside rear view mirror is set to automatic mode, the outside rear view mirrors will activate in conjunction with the anti-glare inside rear view mirror to reduce reflected light. (→P. 82)

 **CAUTION**

■ **When driving the vehicle**

Observe the following precautions while driving.

Failing to do so may result in loss of control of the vehicle and cause an accident, resulting in death or serious injury.

- Do not adjust the mirrors while driving.
- Do not drive with the mirrors folded.
- Both the driver and passenger side mirrors must be extended and properly adjusted before driving.

■ **When a mirror is moving**

To avoid personal injury and mirror malfunction, be careful not to get your hand caught by the moving mirror.

■ **When the mirror defoggers are operating**

Do not touch the rear view mirror surfaces, as they can become very hot and burn you.

1-4. Opening and closing the windows and moon roof

Power windows

The power windows can be opened and closed using the switches.

Operating the switch moves the windows as follows:



- 1 Closing
- 2 One-touch closing*
- 3 Opening
- 4 One-touch opening*

*: Pushing the switch in the opposite direction will stop window travel partway.



Window lock switch

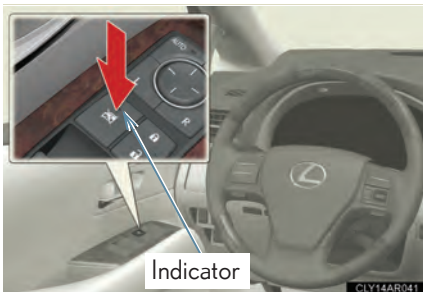

Press the switch to lock the passenger window switches.

The indicator will come on.

Use this switch to prevent children from accidentally opening or closing a passenger window.

The passenger windows can still be opened and closed using the power window switches on the driver's side even if the lock switch is on.

■ The power windows can be operated when

The “ENGINE START STOP” switch is in IGNITION ON mode.

■ Operating the power windows after turning the engine off

The power windows can be operated for approximately 45 seconds even after the “ENGINE START STOP” switch is turned to ACCESSORY mode or turned off. They cannot, however, be operated once either front door is opened.

■ Jam protection function

If an object becomes caught between the window and the window frame, window travel is stopped and the window is opened slightly.

■ Door lock linked window operation

- The power windows can be opened and closed using the mechanical key. (→P. 572)
- The power windows can be opened using the wireless remote control if customized at your Lexus dealer. (→P. 40)

■ When the battery is disconnected

The window lock switch is disabled. If necessary, press the window lock switch after reconnecting the battery.

■ Customization

Settings (e.g. linked door lock operation) can be changed. (Customizable features →P. 610)

 **CAUTION**

■ **Closing the windows**

Observe the following precautions.

Failing to do so may result in death or serious injury.

- Check to make sure that all passengers do not have any part of their body in a position where it could be caught when a window is being operated.
- Do not allow children to operate the power windows.
Closing a power window on someone can cause serious injury, and in some instances, even death.

■ **Jam protection function**

- Never use any part of your body to intentionally activate the jam protection function.
- The jam protection function may not work if something gets caught just before the window fully closes. Also, the jam protection does not operate when the power window switch is pulled up continually to close the windows.

1-4. Opening and closing the windows and moon roof

Moon roof*

Use the overhead switches to open and close the moon roof and tilt it up and down.

■ Opening and closing

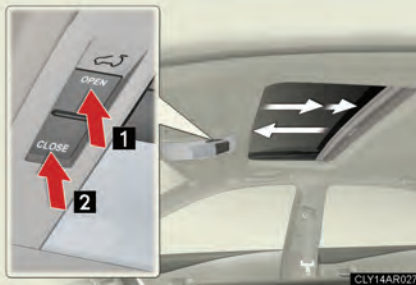

1 Opens the moon roof*

The moon roof stops slightly before the fully open position to reduce wind noise.

Press the switch again to fully open the moon roof.

2 Closes the moon roof*

*: Lightly press either of the moon roof switches to stop the moon roof partway.

■ Tilting up and down

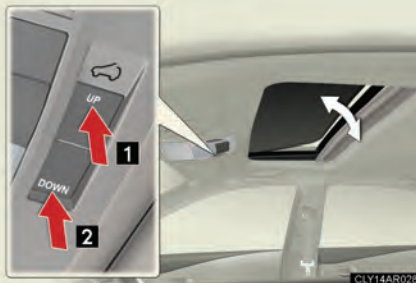

1 Tilts the moon roof up*

2 Tilts the moon roof down*

*: Lightly press either of the moon roof switches to stop the moon roof partway.

■ The moon roof can be operated when

The “ENGINE START STOP” switch is in IGNITION ON mode.

■ Operating the moon roof after turning the engine off

The moon roof can be operated for approximately 45 seconds even after the “ENGINE START STOP” switch is turned to ACCESSORY mode or turned off. It cannot, however, be operated once either front door is opened.

■ Jam protection function

If an object is detected between the moon roof and the frame while closing or tilting down, travel is stopped and the moon roof opens slightly.

■ Sunshade

The sunshade can be opened and closed manually. However, the sunshade will open automatically when the moon roof is opened.

■ Door lock linked moon roof operation

- The moon roof can be opened and closed using the mechanical key. (→P. 572)
- The moon roof can be opened using the wireless remote control if customized at your Lexus dealer. * (→P. 40)

*: This function cannot be customized unless power window operation using the wireless remote control is enabled.

■ When the moon roof does not close normally

Pressing and holding the “CLOSE” switch will close the moon roof.

■ Customization

Settings (e.g. linked door lock operation) can be changed.
(Customizable features →P. 610)

 **CAUTION****■ Opening the moon roof**

Observe the following precautions.

Failing to do so may cause death or serious injury.

- Do not allow any passengers to put their hands or heads outside the vehicle while it is moving.
- Do not sit on top of the moon roof.

■ Closing the moon roof

Observe the following precautions.

Failing to do so may result in death or serious injury.

- Check to make sure that all passengers do not have any part of their body in a position where it could be caught when the moon roof is being operated.
- Do not allow children to operate the moon roof.
Closing the moon roof on someone can cause death or serious injury.

■ Jam protection function

- Never use any part of your body to intentionally activate the jam protection function.
- The jam protection function may not work if something gets caught just before the moon roof fully closes.

1-5. Refueling

Opening the fuel tank cap

Perform the following steps to open the fuel tank cap:

■ Before refueling the vehicle

Turn the “ENGINE START STOP” switch off and ensure that all the doors and windows are closed.

■ Opening the fuel tank cap

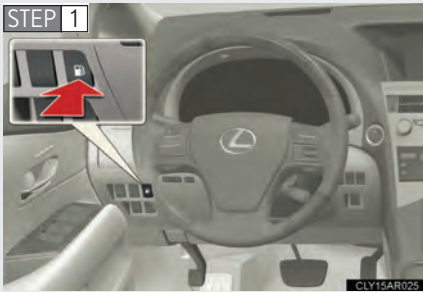

Press the opener to open the fuel filler door.

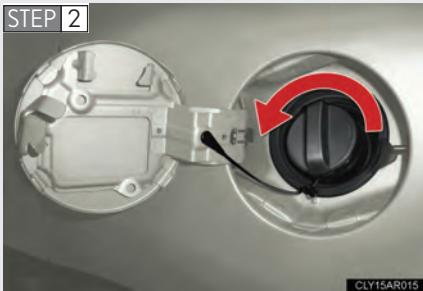

Turn the fuel tank cap slowly to open.

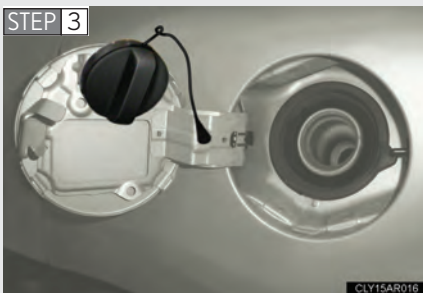

Hang the fuel tank cap on the back of the fuel filler door.

Closing the fuel tank cap



After refueling, turn the fuel tank cap until you hear a click. Once the cap is released, it will turn slightly in the opposite direction.

1

Before driving

■ Use of ethanol blended gasoline in a gasoline engine

Lexus allows the use of ethanol blended gasoline where the ethanol content is up to 10%. Make sure that the ethanol blended gasoline to be used has a Research Octane Number that follows the above.

■ If the fuel filler door opener is inoperable

STEP 1 Pull the lever upwards to lift the deck board up. (→P. 419)

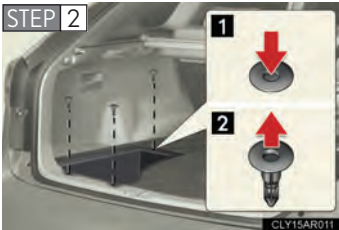

Remove the auxiliary box.



Pull the lever.

The lever can be used to open the fuel filler door if the fuel filler door cannot be opened using the inside switch.

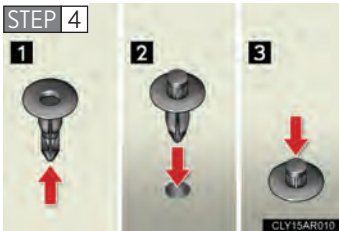

Install the clips.

⚠ CAUTION

■ When refueling the vehicle

Observe the following precautions while refueling the vehicle. Failure to do so may result in death or serious injury.

- After exiting the vehicle and before opening the fuel door, touch an unpainted metal surface to discharge any static electricity. It is important to discharge static electricity before refueling because sparks resulting from static electricity can cause fuel vapors to ignite while refueling.
- Always hold the grips on the fuel tank cap and turn it slowly to remove it. A whooshing sound may be heard when the fuel tank cap is loosened. Wait until the sound cannot be heard before fully removing the cap. In hot weather, pressurized fuel may spray out of the filler neck and cause injury.
- Do not allow anyone that has not discharged static electricity from their body to come close to an open fuel tank.
- Do not inhale vaporized fuel.
Fuel contains substances that are harmful if inhaled.
- Do not smoke while refueling the vehicle.
Doing so may cause the fuel to ignite and cause a fire.
- Do not return to the vehicle or touch any person or object that is statically charged.
This may cause static electricity to build up, resulting in a possible ignition hazard.

 **CAUTION****■ When refueling**

Securely insert the fuel nozzle into the fuel filler neck. If fuel is added with the nozzle slightly lifted away from the fuel filler neck, the automatic shut off function may not operate, resulting in fuel overflowing from the tank.

■ When replacing the fuel cap

Do not use anything but a genuine Lexus fuel tank cap designed for your vehicle. Doing so may cause a fire or other incident which may result in death or serious injury.

 **NOTICE****■ Refueling**

Do not spill fuel during refueling.

Doing so may damage the vehicle, such as causing the emission control system to operate abnormally or damaging fuel system components or the vehicle's painted surface.

1-6. Theft deterrent system

Engine immobilizer system

The vehicle's keys have built-in transponder chips that prevent the engine from starting if the key has not been previously registered in the vehicle's on-board computer.

Never leave the keys inside the vehicle when you leave the vehicle.



The indicator light flashes after the “ENGINE START STOP” switch has been turned off to indicate that the system is operating.

■ System maintenance

The vehicle has a maintenance-free type engine immobilizer system.

■ Conditions that may cause the system to malfunction

- If the grip portion of the key is in contact with a metallic object
- If the key is in close proximity to or touching a key to the security system (key with a built-in transponder chip) of another vehicle

■ Certifications for the engine immobilizer system

- ▶ For vehicles sold in the U.S.A.

FCC ID: NI4TMIMB-1

This device complies with Part 15 of the FCC Rules. Operation is subject to the following two conditions: (1) this device may not cause harmful interference, and (2) this device must accept any interference received, including interference that may cause undesired operation.

- ▶ For vehicles sold in Canada

Operation is subject to the following two conditions: (1) this device may not cause interference, and (2) this device must accept any interference, including interference that may cause undesired operation of the device.

 **CAUTION****■ Certifications for the immobilizer system**

Changes or modifications not expressly approved by the party responsible for compliance could void the user's authority to operate the equipment.

 **NOTICE****■ To prevent damage to the key**

Do not modify, remove or disable the system. If any unauthorized changes or modifications are made, the proper operation of the system cannot be guaranteed.

1-6. Theft deterrent system

Alarm

The system sounds the alarm and flashes the lights when forcible entry is detected.

■ Triggering of the alarm

The alarm is triggered in the following situations:

- A locked doors are unlocked or opened in any way other than using the entry function, wireless remote control or mechanical key with the alarm being set.
- The hood is opened with the alarm being set.
- Some models: The back door window is tapped or broken.

■ Setting the alarm system



Close the doors and hood, and lock all the doors.

The system will be set automatically after 30 seconds.

The indicator light changes from being on to flashing when the system is set.

■ Deactivating or stopping the alarm

Do one of the following to deactivate or stop the alarms:

- Unlock the doors.
- Start the engine. (The alarm will be deactivated or stopped after a few seconds.)

■ Items to check before locking the vehicle

To prevent unexpected triggering of the alarm and vehicle theft, make sure of the following:

- Nobody is in the vehicle.
- The windows and moon roof are closed before the alarm is set.
- No valuables or other personal items are left in the vehicle.

■ Triggering of the alarm

The alarm may be triggered in the following situations:
(Stopping the alarm deactivates the alarm system.)

- A person inside the vehicle opens a door or the hood.
- The battery is recharged or replaced when the vehicle is locked.

1-6. Theft deterrent system

Theft prevention labels (for U.S.A.)



These labels are attached to the vehicle to reduce vehicle theft by facilitating the tracing and recovery of parts from stolen vehicles. Do not remove under penalty of law.

Correct driving posture

Drive in a good posture as follows:



- 1 Sit upright and well back in the seat. (→P. 58)
- 2 Adjust the position of the seat forward or backward to ensure the pedals can be reached and easily depressed to the extent required. (→P. 58)
- 3 Adjust the seatback so that the controls are easily operable. (→P. 58)
- 4 Adjust the tilt and telescopic positions of the steering wheel downward so the airbag is facing your chest. (→P. 80)
- 5 Lock the head restraint in place with the center of the head restraint closest to the top of your ears. (→P. 70)
- 6 Wear the seat belt correctly. (→P. 72)

 **CAUTION**

■ **While driving**

- Do not adjust the position of the driver's seat.
Doing so could cause the driver to lose control of the vehicle.
- Do not place a cushion between the driver or passenger and the seatback.
A cushion may prevent correct posture from being achieved, and reduce the effectiveness of the seat belt and head restraint, increasing the risk of death or serious injury to the driver or passenger.
- Do not place anything under the front seats.
Objects placed under the front seats may become jammed in the seat tracks and stop the seat from locking in place. This may lead to an accident, resulting in death or serious injury. The adjustment mechanism may also be damaged.

■ **Adjusting the seat position**

- Take care when adjusting the seat position to ensure that other passengers are not injured by the moving seat.
- Do not put your hands under the seat or near the moving parts to avoid injury.
Fingers or hands may become jammed in the seat mechanism.

1-7. Safety information

SRS airbags

The SRS airbags inflate when the vehicle is subjected to certain types of severe impacts that may cause significant injury to the occupants. They work together with the seat belts to help reduce the risk of death or serious injury.

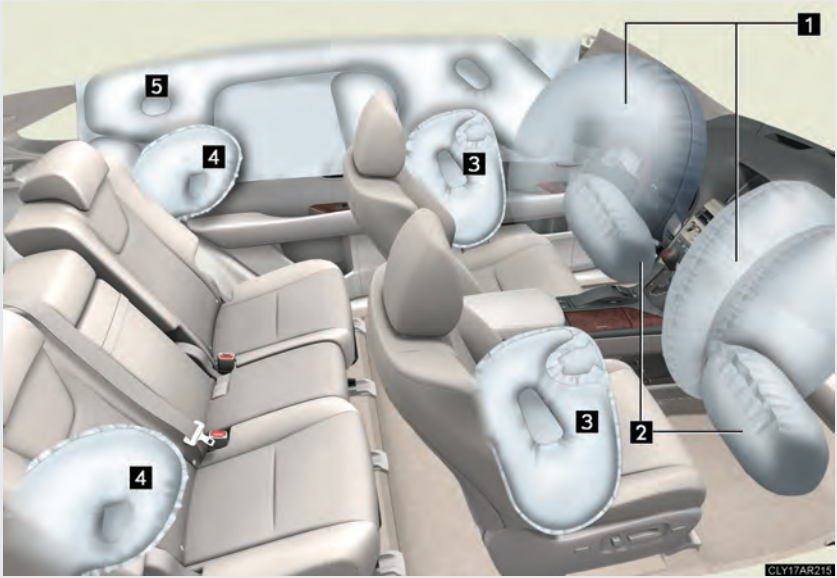

► SRS front airbags

- 1 SRS driver airbag/front passenger airbag
Can help protect the head and chest of the driver and front passenger from impact with interior components
- 2 SRS knee airbags
Can help provide driver and front passenger protection

1

Before driving

- ▶ SRS side and curtain shield airbags
- 3 Front SRS side airbags
 - Can help protect the torso of the front seat occupants
- 4 Rear SRS side airbags
 - Can help protect the torso of occupants in the rear outer seats
- 5 SRS curtain shield airbags
 - Can help protect primarily the head of occupants in the outer seats

SRS airbag system components

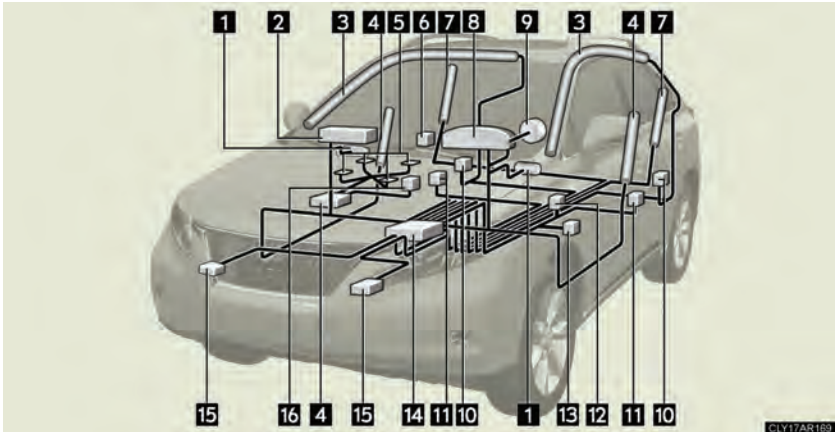

- | | |
|--|---|
| 1 Knee airbags | 10 Curtain shield airbag sensors |
| 2 Front passenger airbag | 11 Side and curtain shield airbag sensors |
| 3 Curtain shield airbags | 12 Driver's seat belt buckle switch |
| 4 Front side airbags | 13 Driver's seat position sensor |
| 5 Occupant detection system (ECU and sensors) | 14 Airbag sensor assembly |
| 6 "AIR BAG ON" and "AIR BAG OFF" indicator lights | 15 Front airbag sensors |
| 7 Rear side airbags | 16 Front passenger's seat belt buckle switch |
| 8 SRS warning light | |
| 9 Driver airbag | |

Your vehicle is equipped with ADVANCED AIRBAGS designed based on US motor vehicle safety standards (FMVSS208). The airbag system controls airbag deployment power for the driver and front passenger. The driver airbag system consists of the driver seat's position sensor etc. The front passenger's airbag system consists of the front passenger occupant classification sensor etc.

The main SRS airbag system components are shown above. The SRS airbag system is controlled by the airbag sensor assembly. The airbag sensor assembly consists of a safing sensor and an airbag sensor.

In certain types of severe frontal or side impacts, the SRS airbag system triggers the airbag inflators. A chemical reaction in the inflators quickly fills the airbags with non-toxic gas to help restrain the motion of the occupants.

■ If the SRS airbags deploy (inflate)

- Bruising and slight abrasions may result from contact with a deploying (inflating) SRS airbag.
- A loud noise and white powder will be emitted.
- Parts of the airbag module (steering wheel hub, airbag cover and inflator) as well as the seats, and parts of the front and rear pillars, and roof side rails, may be hot for several minutes. The airbag itself may also be hot.
- The windshield may crack.

■ SRS airbag deployment conditions (SRS front airbags)

- The front SRS airbags will deploy in the event of an impact that exceeds the set threshold level (the level of force corresponding to a 12 - 18 mph [20 - 30 km/h] frontal collision with a fixed wall that does not move or deform).

However, this threshold velocity will be considerably higher if the vehicle strikes an object, such as a parked vehicle or sign pole, which can move or deform on impact, or if the vehicle is involved in an underride collision (e.g. a collision in which the front of the vehicle “underrides”, or goes under, the bed of a truck, etc.).

- It is possible that in some collisions where the forward deceleration of the vehicle is very close to the designed threshold level, the SRS front airbags and the seat belt pretensioners may not activate together.
- The SRS front passenger airbag will not activate if there is no passenger sitting in the front passenger seat. However, the SRS front passenger airbag may deploy if luggage is put in the seat, or the seat belt is fastened, even if the seat is unoccupied. (→P. 72)

■ SRS airbag deployment conditions (SRS side airbags and curtain shield airbags)

The SRS side airbags and curtain shield airbags will deploy in the event of an impact that exceeds the set threshold level (the level of force corresponding to the impact force produced by a 3300 lb. [1500 kg] vehicle colliding with the vehicle cabin from a direction perpendicular to the vehicle orientation at a speed of 12 - 18 mph [20 - 30 km/h]).

■ Conditions under which the SRS airbags may deploy (inflate), other than a collision (SRS front airbags)

The SRS front airbags may also deploy if a serious impact occurs to the underside of your vehicle. Some examples are shown in the illustration.

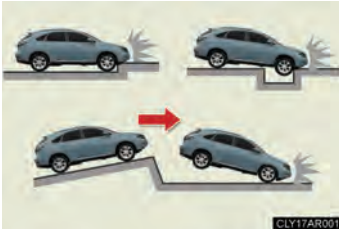

- Hitting a curb, edge of pavement or hard surface
- Falling into or jumping over a deep hole
- Landing hard or vehicle falling

The SRS curtain shield airbags may also deploy under the situations shown in the illustration.



- The angle of vehicle tip-up is marginal.
- The vehicle skids and hits a curb stone.

■ Types of collisions that may not deploy the SRS airbags (SRS front airbags)

The SRS front airbags are generally not designed to inflate if the vehicle is involved in a side or rear collision, if it rolls over, or if it is involved in a low-speed frontal collision. But, whenever a collision of any type causes sufficient forward deceleration of the vehicle, deployment of the SRS front airbags may occur.



- Collision from the side
- Collision from the rear
- Vehicle rollover

■ Types of collisions that may not deploy the SRS airbags (SRS side airbags and curtain shield airbags)

The SRS side airbag and curtain shield airbag system may not activate if the vehicle is subjected to a collision from the side at certain angles, or a collision to the side of the vehicle body other than the passenger compartment.



- Collision from the side to the vehicle body other than the passenger compartment
- Collision from the side at an angle

The SRS side airbags and curtain shield airbags are not generally designed to inflate if the vehicle is involved in a frontal or rear collision, if it rolls over, or if it is involved in a low-speed side collision.



- Collision from the front
- Collision from the rear
- Vehicle rollover

■ When to contact your Lexus dealer

In the following cases, contact your Lexus dealer as soon as possible. Do not disconnect the battery cables before contacting your Lexus dealer.

- Any of the SRS airbags has been inflated.

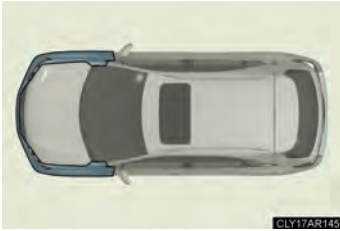

- The front of the vehicle is damaged or deformed, or was involved in an accident that was not severe enough to cause the SRS airbags to inflate.

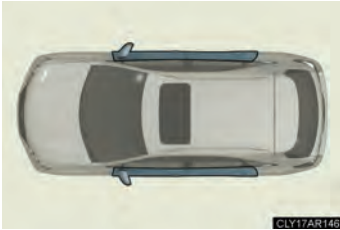

- A portion of the doors is damaged or deformed, or the vehicle was involved in an accident that was not severe enough to cause the SRS side airbags and curtain shield airbags to inflate.



- The pad section of the steering wheel, dashboard near the front passenger airbag or lower portion of the instrument panel is scratched, cracked, or otherwise damaged.



- The surface of the seats with the side airbag is scratched, cracked, or otherwise damaged.
- The portion of the front pillars, rear pillars or roof side rail garnishes (padding) containing the curtain shield airbags inside is scratched, cracked, or otherwise damaged.

 CAUTION

■ **SRS airbag precautions**

Observe the following precautions regarding the SRS airbags. Failure to do so may cause death or serious injury.

- The driver and all passengers in the vehicle must wear their seat belts properly. The SRS airbags are supplemental devices to be used with the seat belts.
- The SRS driver airbag deploys with considerable force, and can cause death or serious injury especially if the driver is very close to the airbag. The National Highway Traffic Safety Administration (“NHTSA”) advises:

Since the risk zone for driver’s airbag is the first 2 - 3 in. (50 - 75 mm) of inflation, placing yourself 10 in. (250 mm) from your driver airbag provides you with a clear margin of safety. This distance is measured from the center of the steering wheel to your breastbone. If you sit less than 10 in. (250 mm) away now, you can change your driving position in several ways:

- Move your seat to the rear as far as you can while still reaching the pedals comfortably.
- Slightly recline the back of the seat.
Although vehicle designs vary, many drivers can achieve the 10 in. (250 mm) distance, even with the driver seat all the way forward, simply by reclining the back of the seat somewhat. If reclining the back of your seat makes it hard to see the road, raise yourself by using a firm, non-slippery cushion, or raise the seat if your vehicle has that feature.
- If your steering wheel is adjustable, tilt it downward. This points the airbag toward your chest instead of your head and neck.

The seat should be adjusted as recommended by NHTSA above, while still maintaining control of the foot pedals, steering wheel, and your view of the instrument panel controls.

 CAUTION

 SRS airbag precautions

- If the seat belt extender has been connected to the driver's seat belt buckle but the seat belt extender has not also been fastened to the latch plate of the driver's seat belt, the SRS driver's airbag system will judge that the driver is wearing the seat belt even though the seat belt has not been connected. In this case, the driver's airbag may not activate correctly in a collision, resulting in death or serious injury in the event of collision. Be sure to wear the seat belt with the seat belt extender.
- The SRS front passenger airbag also deploys with considerable force, and can cause death or serious injury especially if the front passenger is very close to the airbag. The front passenger seat should be as far from the airbag as possible with the seatback adjusted, so the front passenger sits upright.
- Improperly seated and/or restrained infants and children can be killed or seriously injured by a deploying airbag. An infant or child who is too small to use a seat belt should be properly secured using a child restraint system. Lexus strongly recommends that all infants and children be placed in the rear seats of the vehicle and properly restrained. The rear seats are safer for infants and children than the front passenger seat. (→P. 120)

⚠ CAUTION

■ SRS airbag precautions



● Do not sit on the edge of the seat or lean against the dashboard.

● Do not allow a child to stand in front of the SRS front passenger airbag unit or sit on the knees of a front passenger.

● Do not allow the front seat occupants to hold items on their knees.

● Do not lean against the door, the roof side rail or the front, side and rear pillars.

● Do not allow anyone to kneel on the passenger seats toward the door or put their head or hands outside the vehicle.

CAUTION

■ SRS airbag precautions

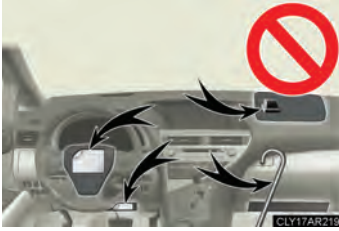

- Do not attach anything to or lean anything against areas such as the dashboard, steering wheel pad or lower portion of the instrument panel.
These items can become projectiles when SRS driver, front passenger and knee airbags deploy.
 - Do not attach anything to areas such as the door, windshield glass, side door glass, front and rear pillars, roof side rail or assist grip.
 - Do not hang coat hangers or other hard objects on the coat hooks. All of these items could become projectiles and may cause death or serious injury, should the SRS curtain shield airbags deploy.
- If a vinyl cover is put on the area where the SRS knee airbags will deploy, be sure to remove it.
 - Do not use seat accessories which cover the parts where the SRS side airbags inflate as they may interfere with inflation of the airbags. Such accessories may prevent the side airbags from activating correctly, disable the system or cause the side airbags to inflate accidentally, resulting in death or serious injury.
 - Do not strike or apply significant levels of force to the area of the SRS airbag components.
Doing so can cause the SRS airbags to malfunction.
 - Do not touch any of the component parts immediately after the SRS airbags have deployed (inflated) as they may be hot.
 - If breathing becomes difficult after the SRS airbags have deployed, open a door or window to allow fresh air in, or leave the vehicle if it is safe to do so. Wash off any residue as soon as possible to prevent skin irritation.
 - If the areas where the SRS airbags are stored, such as the steering wheel pad and front and rear pillar garnishes, are damaged or cracked, have them replaced by your Lexus dealer.

 **CAUTION**

■ **SRS airbag precautions**

- Do not place anything, such as a cushion, on the front passenger's seat. Doing so will disperse the passenger's weight, which prevents the sensor from detecting the passenger's weight properly. As a result, the SRS front passenger airbag may not deploy in the event of a collision.

■ **Modification and disposal of SRS airbag system components**

Do not dispose of your vehicle or perform any of the following modifications without consulting your Lexus dealer.

The SRS airbags may malfunction or deploy (inflate) accidentally, causing death or serious injury.

- Installation, removal, disassembly and repair of the SRS airbags
- Repairs, modifications, removal or replacement of the steering wheel, instrument panel, dashboard, seats or seat upholstery, front, side and rear pillars or roof side rails
- Repairs or modifications of the front fender, front bumper, or side of the occupant compartment
- Installation of snow plows, winches, etc. to the front grille (bull bars or kangaroo bar etc.)
- Modifications to the vehicle's suspension system
- Installation of electronic devices such as mobile two-way radios or CD players
- Modifications to your vehicle for a person with a physical disability

1-7. Safety information

Front passenger occupant classification system

Your vehicle is equipped with a front passenger occupant classification system. This system detects the conditions of the front passenger seat and activates or deactivates the devices for the front passenger.

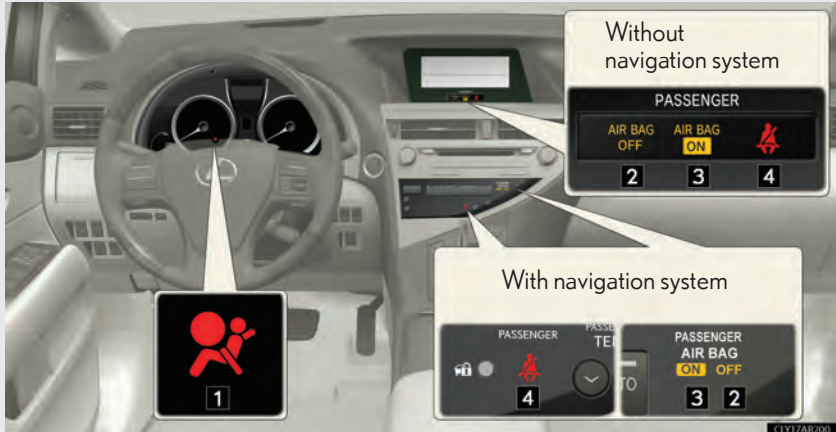

- 1 SRS warning light
- 2 "AIR BAG OFF" indicator light
- 3 "AIR BAG ON" indicator light
- 4 Front passenger's seat belt reminder light

1

Before driving

Condition and operation in the front passenger occupant classification system

■ Adult *1

Indicator/ warning light	“AIR BAG ON” and “AIR BAG OFF” indicator lights	“AIR BAG ON”
	SRS warning light	Off
	Front passenger’s seat belt reminder light	Flashing *2
Devices	Front passenger airbag	Activated
	Side airbag on the front passenger seats	
	Curtain shield airbag in the front passenger side	
	Front passenger knee airbag	
	Front passenger’s seat belt pretensioner	

■ Child *3 or child restraint system *4

Indicator/ warning light	“AIR BAG ON” and “AIR BAG OFF” indicator lights	“AIR BAG OFF” *5
	SRS warning light	Off
	Front passenger’s seat belt reminder light	Flashing *2
Devices	Front passenger airbag	Deactivated
	Side airbag on the front passenger seats	Activated
	Curtain shield airbag in the front passenger side	
	Front passenger knee airbag	Deactivated
	Front passenger’s seat belt pretensioner	Activated

■ Unoccupied

Indicator/ warning light	“AIR BAG ON” and “AIR BAG OFF” indicator lights	Not illuminated
	SRS warning light	Off
	Front passenger’s seat belt reminder light	
Devices	Front passenger airbag	Deactivated
	Side airbag on the front passenger seats	Activated
	Curtain shield airbag in the front passenger side	
	Front passenger knee airbag	Deactivated
	Front passenger’s seat belt pretensioner	

■ There is a malfunction in the system

Indicator/ warning light	“AIR BAG ON” and “AIR BAG OFF” indicator lights	“AIR BAG OFF”
	SRS warning light	On
	Front passenger’s seat belt reminder light	Off
Devices	Front passenger airbag	Deactivated
	Side airbag on the front passenger seats	Activated
	Curtain shield airbag in the front passenger side	
	Front passenger knee airbag	Deactivated
	Front passenger’s seat belt pretensioner	Activated

- *1: The system judges a person of adult size as an adult. When a smaller adult sits in the front passenger seat, the system may recognize him/her as a child depending on his/her physique and posture.
- *2: In the event the front passenger does not wear a seat belt.
- *3: When a larger child who has outgrown a child restraint system sits in the front passenger seat, the system may recognize him/her as an adult depending on his/her physique or posture.

- *4: Never install a rear-facing child restraint system on the front passenger seat. A forward-facing child restraint system should only be installed on the front passenger seat when it is unavoidable. (→P. 120)
- *5: In case indicator light is not illuminated, consult this manual on how to install the child restraint system properly. (→P. 124)

CAUTION

■ Front passenger occupant classification system precautions

Observe the following precautions regarding front passenger occupant classification system.

Failure to do so may cause death or serious injury.

- Wear the seat belt properly.
- Make sure the front passenger's seat belt tab has not been left inserted into the buckle before someone sits in the front passenger seat.
- Make sure the "AIR BAG OFF" indicator light is not illuminated when using the seat belt extender for the front passenger seat. If the "AIR BAG OFF" indicator light is illuminated, disconnect the extender tongue from the seat belt buckle, then reconnect the seat belt. Reconnect the seat belt extender after making sure the "AIR BAG ON" indicator light is illuminated. If you use the seat belt extender while the "AIR BAG OFF" indicator light is illuminated, the front passenger airbag, side airbag on the front passenger side and front passenger knee airbag may not activate correctly, which could cause death or serious injury in the event of collision.
- Do not apply a heavy load to the front passenger seat or equipment.
- Do not put weight on the front passenger seat by putting your hands or feet on the front passenger seat seatback from the rear passenger seat.
- Do not let a rear passenger lift the front passenger seat with their feet or press on the seatback with their legs.
- Do not put objects under the front passenger seat.

 **CAUTION****■ Front passenger occupant classification system precautions**

- Do not recline the front passenger seatback so far that it touches a rear seat. This may cause the “AIR BAG OFF” indicator light to be illuminated, which indicates that the passenger’s airbags will not deploy in the event of a severe accident. If the seatback touches the rear seat, return the seatback to a position where it does not touch the rear seat. Keep the front passenger seatback as upright as possible when the vehicle is moving. Reclining the seatback excessively may lessen the effectiveness of the seat belt system.
- If an adult sits in the front passenger seat, the “AIR BAG ON” indicator light is illuminated. If the “AIR BAG OFF” indicator is illuminated, ask the passenger to sit up straight, well back in the seat, feet on the floor, and with the seat belt worn correctly. If the “AIR BAG OFF” indicator still remains illuminated, either ask the passenger to move to the rear seat, or if that is not possible, move the front passenger seat fully rearward.
- When it is unavoidable to install the forward-facing child restraint system on the front passenger seat, install the child restraint system on the front passenger seat in the proper order. (→P. 124)
- Do not modify or remove the front seats.
- Do not kick the front passenger seat or subject it to severe impact. Otherwise, the SRS warning light may come on to indicate a malfunction of the detection system. In this case, contact your Lexus dealer immediately.
- Child restraint systems installed on the rear seat should not contact the front seatbacks.
- Do not use a seat accessory, such as a cushion or seat cover, that covers the seat cushion surface.
- Do not modify or replace the upholstery of the front seat.

1-7. Safety information

Child restraint systems

A child restraint system for a small child or baby must itself be properly restrained on the seat with the lap portion of the lap/shoulder belt.

The laws of all 50 states of the U.S.A. and Canada now require the use of child restraint systems.

Points to remember

Studies have shown that installing a child restraint on a rear seat is much safer than installing one to the front passenger seat.

- Choose a child restraint system that suits your vehicle and is appropriate to the age and size of the child.
- For installation details, follow the instructions provided with the child restraint system.
General installation instructions are provided in this manual. (→P.124)

Types of child restraints

Child restraint systems are classified into the following 3 types according to the age and size of the child.

- ▶ Rear facing — Infant seat/convertible seat



▶ Forward facing — Convertible seat



▶ Booster seat



■ Selecting an appropriate child restraint system

- Use a child restraint system appropriate for the child until the child becomes large enough to properly wear the vehicle's seat belt.
- If the child is too large for a child restraint system, sit the child on a rear seat and use the vehicle's seat belt. (→P. 72)

CAUTION

■ Child restraint precautions

- For effective protection in automobile accidents and sudden stops, a child must be properly restrained, using a seat belt or child restraint system depending on the age and size of the child. Holding a child in your arms is not a substitute for a child restraint system. In an accident, the child can be crushed against the windshield, or between you and the vehicle's interior.
- Lexus strongly urges the use of a proper child restraint system that conforms to the size of the child, installed on the rear seat. According to accident statistics, the child is safer when properly restrained in the rear seat than in the front seat.
- Never install a rear-facing child restraint system on the front passenger seat even if the "AIR BAG OFF" indicator light is illuminated. In the event of an accident, the force of the rapid inflation of the front passenger airbag can cause death or serious injury to the child if a rear-facing child restraint system is installed on the front passenger seat.
- A forward-facing child restraint system may be allowed to be installed on the front passenger seat only when it is unavoidable. A child restraint system that requires a top tether strap should not be used in the front passenger seat since there is no top tether strap anchor for the front passenger seat. Adjust the seatback as upright as possible and always move the seat as far back as possible even if the "AIR BAG OFF" indicator light is illuminated, because the front passenger airbag could inflate with considerable speed and force. Otherwise, the child may be killed or seriously injured.
- Do not use the seat belt extender when installing a child restraint system on the front or rear passenger seat. If installing a child restraint system with the seat belt extender connected to the seat belt, the seat belt will not securely hold the child restraint system, which could cause death or serious injury to the child or other passengers in the event of an accident.
- Do not allow the child to lean his/her head or any part of his/her body against the door or the area of the seat, front and rear pillars or roof side rails from which the SRS side airbags or SRS curtain shield airbags deploy even if the child is seated in the child restraint system. It is dangerous if the side airbags and curtain shield airbags inflate, and the impact could cause death or serious injury to the child.

 **CAUTION****■ Child restraint precautions**

- Make sure you have complied with all installation instructions provided by the child restraint manufacturer and that the system is properly secured. If it is not secured properly, it may cause death or serious injury to the child in the event of a sudden stop or an accident.

■ Child restraint lock function belt precaution

Do not allow children to play with the child restraint lock function belt. If the belt becomes twisted around a child's neck, it will not be possible to pull the belt out leading to choking or other serious injuries that could result in death.

If this occurs and the buckle cannot be unfastened, scissors should be used to cut the belt.

■ When the child restraint system is not in use

- Keep the child restraint system properly secured on the seat even if it is not in use. Do not store the child restraint system unsecured in the passenger compartment.
- If it is necessary to detach the child restraint system, remove it from the vehicle or store it securely in the luggage compartment. This will prevent it from injuring passengers in the event of a sudden stop or accident.

1-7. Safety information

Installing child restraints

Follow the child restraint system manufacturer's instructions. Firmly secure child restraints to the seats using the LATCH anchors or a seat belt. Attach the top tether strap when installing a child restraint.

The lap/shoulder belt can be used if your child restraint system is not compatible with the LATCH (Lower Anchors and Tethers for Children) system.



Child restraint LATCH anchors
LATCH anchors are provided for the outer rear seats. (Buttons displaying the location of the anchors are attached to the seats.)



Seat belts equipped with a child restraint locking mechanism (ALR/ELR belts except driver's seat belt) (→P. 72)



Anchor brackets (for top tether strap)
An anchor bracket is provided for each rear seat.

Installation with LATCH system

STEP 1

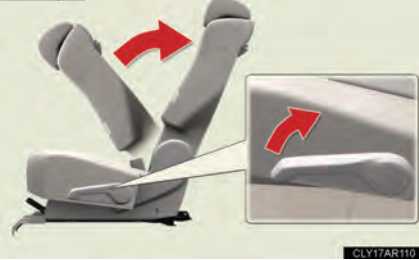

Fold the seatback while pulling the seatback angle adjustment lever. Return the seatback and secure it at the first lock position. (→P. 63)

STEP 2

Widen the gap between the seat cushion and seatback slightly.

► Type A

STEP 3

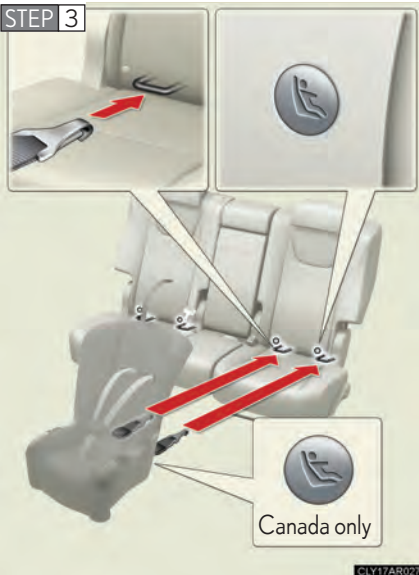

Latch the hooks of the lower straps onto the LATCH anchors. If the child restraint has a top tether strap, the top tether strap should be latched onto the top tether strap anchor bracket.

For owners in Canada:
The symbol on a child restraint system indicates the presence of a lower connector system.

► Type B

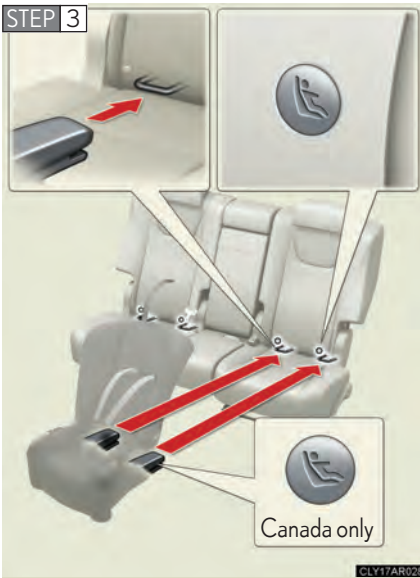

Latch the buckles onto the LATCH anchors. If the child restraint has a top tether strap, the top tether strap should be latched onto the top tether strap anchor bracket.

For owners in Canada:
The symbol on a child restraint system indicates the presence of a lower connector system.

Installing child restraints using a seat belt (child restraint lock function belt)

■ Rear-facing — Infant seat/convertible seat

STEP 1

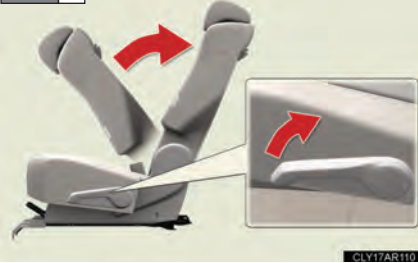

Fold the seatback while pulling the seatback angle adjustment lever. Return the seatback and secure it at the first lock position. (→P. 63)

STEP 2



Place the child restraint system on the rear seat facing the rear of the vehicle.

STEP 3



Run the seat belt through the child restraint system and insert the plate into the buckle. Make sure that the belt is not twisted.

1

Before driving

STEP 4



Fully extend the shoulder belt and allow it to retract to put it in lock mode. In lock mode, the belt cannot be extended.

STEP 5



While pushing the child restraint system down into the rear seat, allow the shoulder belt to retract until the child restraint system is securely in place.

After the shoulder belt has retracted to a point where there is no slack in the belt, pull the belt to check that it cannot be extended.

■ Forward-facing — Convertible seat

STEP 1

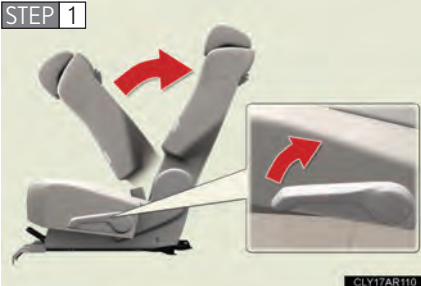

Fold the seatback while pulling the seatback angle adjustment lever. Return the seatback and secure it at the first lock position. (→P. 63)

STEP 2



Place the child restraint system on the seat facing the front of the vehicle.

STEP 3



Run the seat belt through the child restraint system and insert the plate into the buckle. Make sure that the belt is not twisted.

STEP 4



Fully extend the shoulder belt and allow it to retract to put it in lock mode. In lock mode, the belt cannot be extended.

STEP 5



While pushing the child restraint system into the rear seat, allow the shoulder belt to retract until the child restraint system is securely in place.

After the shoulder belt has retracted to a point where there is no slack in the belt, pull the belt to check that it cannot be extended.

STEP 6 If the child restraint has a top tether strap, the top tether strap should be latched onto the top tether strap anchor. (→P. 131)

■ Booster seat

STEP 1

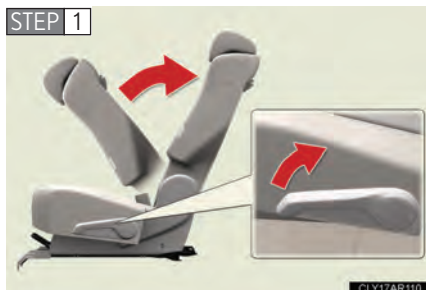

Fold the seatback while pulling the seatback angle adjustment lever. Return the seatback and secure it at the first lock position. (→P. 63)

STEP 2



Place the child restraint system on the seat facing the front of the vehicle.

STEP 3



Sit the child in the child restraint system. Fit the seat belt to the child restraint system according to the manufacturer's instructions and insert the plate into the buckle. Make sure that the belt is not twisted.

Check that the shoulder belt is correctly positioned over the child's shoulder, and that the lap belt is as low as possible. (→P. 72)

Removing a child restraint installed with a seat belt

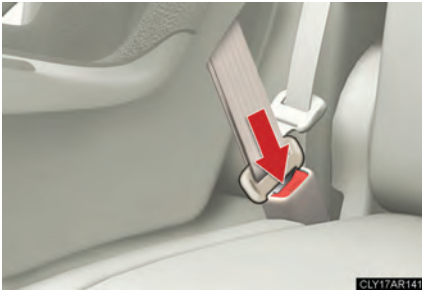

Press the buckle release button and fully retract the seat belt.

1

Before driving

Child restraint systems with a top tether strap

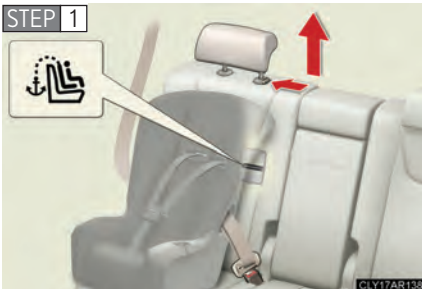

Secure the child restraint system using a seat belt or the lower anchors, and remove the head restraint.



Open the anchor bracket cover, latch the hook onto the anchor bracket and tighten the top tether strap.

Make sure the top tether strap is securely latched.

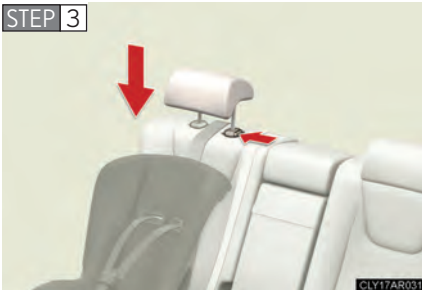

Replace the head restraint and lift it up to the uppermost lock position.

■ Laws and regulations pertaining to anchors

The LATCH system conforms to FMVSS225 or CMVSS210.2.

Child restraint systems conforming to FMVSS213 or CMVSS213 specifications can be used.

This vehicle is designed to conform to the SAE J1819.

⚠ CAUTION

■ When installing a booster seat

To prevent the belt from going into ALR lock mode, do not fully extend the shoulder belt. ALR mode causes the belt to tighten only. This could cause injury or discomfort to the child. (→P. 75)

⚠ CAUTION

■ When installing a child restraint system

Follow the directions given in the child restraint system installation manual and fix the child restraint system securely in place.

If the child restraint system is not correctly fixed in place, the child or other passengers may be injured or even killed in the event of sudden braking or an accident.



- If the driver's seat interferes with the child restraint system and prevents it from being attached correctly, attach the child restraint system to the right-hand rear seat.
- Adjust the front passenger seat so that it does not interfere with the child restraint system.
- Only put a forward-facing child restraint system on the front seat when unavoidable. When installing a forward-facing child restraint system on the front passenger seat, move the seat as far back as possible even if the "AIR BAG OFF" indicator light is illuminated. Failure to do so may result in death or serious injury if the airbags deploy (inflate).
- When installing a child restraint system in the rear center seat, adjust both seat cushions to the same position and align both seatbacks at the same angle. The seatbacks must be adjusted to the same angle. Otherwise, the child restraint system cannot be securely restrained and this may cause death or serious injuries in an accident.
- When using the LATCH system, move the seat as far back as possible and adjust the seatback as upright as possible.
- When a booster seat is installed, always ensure that the shoulder belt is positioned across the center of the child's shoulder. The belt should be kept away from the child's neck, but not so that it could fall off the child's shoulder. Failing to do so may result in death or serious injury in the event of an accident or sudden braking.
- Ensure that the belt and tab are securely locked and the seat belt is not twisted.

CAUTION

■ **When installing a child restraint system**

- Push and pull the child restraint system from side to side and forward to be sure it is secure.
- After securing a child restraint system, never adjust the seat.
- Follow all installation instructions provided by the child restraint system manufacturer.

■ **Do not use a seat belt extender**

If a seat belt extender is used when installing a child restraint system, the seat belt will not securely hold the child restraint system, which could cause death or serious injury to the child or other passengers in the event of an accident.

■ **To correctly attach a child restraint system to the anchors**

When using the LATCH anchors, be sure that there are no foreign objects around the anchors and that the seat belt is not caught behind the child restraint system. Make sure the child restraint system is securely attached, or it may cause death or serious injury to the child or other passengers in the event of a sudden stop or accident.

2-1. Driving procedures

Driving the vehicle.....	136
Engine (ignition) switch.....	145
Automatic transmission	151
Turn signal lever	155
Parking brake	156
Horn.....	157

2-2. Instrument cluster

Gauges and meters	158
Indicators and warning lights	160
Multi-information display	165
Head-up display	171

2-3. Operating the lights and windshield wipers

Headlight switch.....	176
Automatic High Beam.....	181
Fog light switch	187
Windshield wipers and washer	189
Rear window wiper and washer	194
Headlight cleaner switch.....	195

2-4. Using other driving systems

Cruise control.....	196
Dynamic radar cruise control	200
Intuitive parking assist.....	211
Electronically modulated air suspension.....	218
Rear view monitor system (rear view mirror-attached type).....	224
Driving assist systems.....	228
All-wheel drive lock switch (AWD models).....	234
Hill-start assist control	235
Pre-Collision System.....	237

2-5. Driving information

Utility vehicle precautions.....	242
Cargo and luggage	247
Vehicle load limits	251
Winter driving tips	252
Trailer towing	256
Dinghy towing.....	269

2-1. Driving procedures

Driving the vehicle

The following procedures should be observed to ensure safe driving.

■ Starting the engine

→P. 145

■ Driving

STEP 1 With the brake pedal depressed, shift the shift lever to D.
(→P. 151)

STEP 2 Release the parking brake. (→P. 156)

STEP 3 Gradually release the brake pedal and gently depress the accelerator pedal to accelerate the vehicle.

■ Stopping

STEP 1 With the shift lever in D, depress the brake pedal.

STEP 2 If necessary, set the parking brake.

If the vehicle is to be stopped for an extended period of time, shift the shift lever to P or N. (→P. 151)

■ Parking the vehicle

STEP 1 With the shift lever in D, depress the brake pedal.

STEP 2 Set the parking brake. (→P. 156)

STEP 3 Shift the shift lever to P. (→P. 151)

If parking on a hill, block the wheels as needed.

STEP 4 Press the “ENGINE START STOP” switch to stop the engine.

STEP 5 Lock the door, making sure that you have the electronic key on your person.

Starting off on a steep uphill

STEP 1 Make sure that the parking brake is set and shift the shift lever to D.

STEP 2 Gently depress the accelerator pedal.

STEP 3 Release the parking brake.

■ Driving in the rain

- Drive carefully when it is raining, because visibility will be reduced, the windows may become fogged-up, and the road will be slippery.
- Drive carefully when it starts to rain, because the road surface will be especially slippery.
- Refrain from high speeds when driving on an expressway in the rain, because there may be a layer of water between the tires and the road surface, preventing the steering and brakes from operating properly.

■ Breaking in your new Lexus

To extend the life of the vehicle, observing the following precautions is recommended:

- For the first 200 miles (300 km):
Avoid sudden stops.
- For the first 500 miles (800 km):
Do not tow a trailer.
- For the first 1000 miles (1600 km):
 - Do not drive at extremely high speeds.
 - Avoid sudden acceleration.
 - Do not drive continuously in low gears.
 - Do not drive at a constant speed for extended periods.

■ Drum-in-disc type parking brake system

Your vehicle has a drum-in-disc type parking brake system. This type of brake system needs bedding-down of the brake shoes periodically or whenever the parking brake shoes and/or drum are replaced. Have your Lexus dealer perform the bedding down operation.

■ Operating your vehicle in a foreign country

Comply with the relevant vehicle registration laws and confirm the availability of the correct fuel. (→P. 586)

CAUTION

■ When starting the vehicle

Always keep your foot on the brake pedal while stopped with the engine running. This prevents the vehicle from creeping.

■ When driving the vehicle

- Do not drive if you are unfamiliar with the location of the brake and accelerator pedals to avoid depressing the wrong pedal.
 - Accidentally depressing the accelerator pedal instead of the brake pedal will result in sudden acceleration that may lead to an accident that could result in death or serious injury.
 - When backing up, you may twist your body around, leading to a difficulty in operating the pedals. Make sure to operate the pedals properly.
 - Make sure to keep a correct driving posture even when moving the vehicle only slightly. This allows you to depress the brake and accelerator pedals properly.
 - Depress the brake pedal using your right foot. Depressing the brake pedal using your left foot may delay response in an emergency, resulting in an accident.
- Do not drive the vehicle over or stop the vehicle near flammable materials. The exhaust system and exhaust gases can be extremely hot. These hot parts may cause a fire if there is any flammable material nearby.
- Do not let the vehicle roll backwards while the shift lever is in a driving position, or roll forward while the shift lever is in R. Doing so may cause the engine to stall or lead to poor brake and steering performance, resulting in an accident or damage to the vehicle.
- If the smell of exhaust is noticed inside the vehicle, open the windows and check that the back door is closed. Large amounts of exhaust in the vehicle can cause driver drowsiness and an accident, resulting in death or a serious health hazard. Have the vehicle inspected by your Lexus dealer immediately.

 **CAUTION**

- Do not under any circumstances shift the shift lever to P while the vehicle is moving.
Doing so can cause significant damage to the driveline and may result in a loss of vehicle control.
- Do not under any circumstances shift the shift lever to R while the vehicle is moving forward.
Doing so can cause significant damage to the driveline and may result in a loss of vehicle control.
- Do not shift the shift lever to N while the vehicle is moving.
Doing so may cause insufficient engine braking, resulting in an accident.
- Do not turn the engine off while driving.
The power steering and brake booster will not operate properly if the engine is not running.
- Use engine braking (downshift) to maintain a safe speed when driving down a steep hill.
Using the brakes continuously may cause the brakes to overheat and lose effectiveness. (→P. 151)
- When stopped on an incline, use the brake pedal and parking brake to prevent the vehicle from rolling backward or forward, causing an accident.
- Do not adjust the position of the steering wheel, the seat, or the inside or outside rear view mirrors while driving.
Doing so may result in a loss of vehicle control that can cause accidents, resulting in death or serious injury.
- Always check that all passengers' arms, heads or other parts of their body are not outside the vehicle, as this may result in death or serious injury.

CAUTION

- Do not drive in excess of the speed limit. Even if the legal speed limit permits it, do not drive over 85 mph (140 km/h) unless your vehicle has high-speed capability tires. Driving over 85 mph (140 km/h) may result in tire failure, loss of control and possible injury. Be sure to consult a tire dealer to determine whether the tires on your vehicle are high-speed capability tires or not before driving at such speeds.
- On vehicles with an electronically modulated air suspension, if you drive through water, such as when crossing shallow streams, first check the depth of the water and the firmness of the river bed. Put the vehicle in “HI” (high) mode with the height selector switch and then turn off the electronically modulated air suspension by pressing the height control switch. Drive your vehicle at 19 mph (30 km/h) or lower.

■ When driving on slippery road surfaces

- Sudden braking, acceleration and steering may cause tire slippage and reduce your ability to control the vehicle, resulting in an accident.
- Sudden changes in engine speed, such as engine braking caused by up-shifting and down-shifting, may cause the vehicle to skid, resulting in an accident.
- After driving through a puddle, lightly depress the brake pedal to make sure that the brakes are functioning properly. Wet brake pads may prevent the brakes from functioning properly. If the brakes on only one side are wet and not functioning properly, steering control may be affected, resulting in an accident.

■ When shifting the shift lever

Be careful not to shift the shift lever with the accelerator pedal depressed. This may lead to unexpected rapid acceleration of the vehicle that may cause an accident and result in death or serious injury.

■ When the vehicle is stopped

- Do not race the engine.
If the vehicle is in any gear other than P or N, the vehicle may accelerate suddenly and unexpectedly, causing an accident.
- Do not leave the vehicle with the engine running for a long time.
If such a situation cannot be avoided, park the vehicle in an open space and check that exhaust fumes do not enter the vehicle interior.
- Always keep a foot on the brake pedal while the engine is running to prevent an accident caused by the vehicle moving.

 **CAUTION**

- When stopped on an incline, use the brake pedal and parking brake to prevent the vehicle from rolling backward or forward, causing an accident.

■ When the vehicle is parked

- Do not leave glasses, cigarette lighters, spray cans, or soft drink cans in the vehicle when it is in the sun.

Doing so may result in the following:

- Gas may leak from a cigarette lighter or spray can, and may lead to a fire.
 - The temperature inside the vehicle may cause the plastic lenses and plastic material of glasses to deform or crack.
 - Soft drink cans may fracture, causing the contents to spray over the interior of the vehicle, and may also cause a short circuit in the vehicle's electrical components.
- Do not leave cigarette lighters in the vehicle. If a cigarette lighter is in a place such as the glove box or on the floor, it may be lit accidentally when luggage is loaded or the seat is adjusted, causing a fire.
 - Do not attach adhesive discs to the windshield or windows. Do not place containers such as air fresheners on the instrument panel or dashboard. Adhesive discs or containers may act as lenses, causing a fire in the vehicle.
 - Do not leave a door or window open if the curved glass is coated with a metalized film such as a silver-colored one. Reflected sunlight may cause the glass to act as a lens, causing a fire.
 - Always apply the parking brake, shift the shift lever to P, stop the engine and lock the vehicle.
Do not leave the vehicle unattended while the engine is running.
 - Do not touch the exhaust pipes while the engine is running or immediately after turning the engine off.
Doing so may cause burns.
 - Do not leave the engine running in an area with snow build-up, or where it is snowing. If snowbanks build up around the vehicle while the engine is running, exhaust gases may collect and enter the vehicle. This may lead to death or a serious health hazard.

CAUTION

■ Exhaust gases

Exhaust gases include harmful carbon monoxide (CO) that is colorless and odorless. Inhaling exhaust gases may lead to death or a serious health hazard.

- If the vehicle is in a poorly ventilated area, stop the engine. In a closed area, such as a garage, exhaust gases may collect and enter the vehicle. This may lead to death or a serious health hazard.
- The exhaust system should be checked occasionally. If there is a hole or crack caused by corrosion, damage to a joint or abnormal exhaust noise, be sure to have the vehicle inspected and repaired by your Lexus dealer. Failure to do so may allow exhaust gases to enter the vehicle, resulting in death or a serious health hazard.

■ When taking a nap in the vehicle

Always turn the engine off. Otherwise, if you accidentally move the shift lever or depress the accelerator pedal, this could cause an accident or fire due to engine overheating. Additionally, if the vehicle is parked in a poorly ventilated area, exhaust gases may collect and enter the vehicle, leading to death or a serious health hazard.

■ When braking the vehicle

- When the brakes are wet, drive more cautiously.
Braking distance increases when the brakes are wet, and this may cause one side of the vehicle to brake differently than the other side. Also, the parking brake may not securely hold the vehicle.
- If the power brake assist function does not operate, do not follow other vehicles closely and avoid hills or sharp turns that require braking.
In this case, braking is still possible, but the brake pedal should be depressed more firmly than usual. Also, the braking distance will increase.
- Do not pump the brake pedal if the engine stalls.
Each push on the brake pedal uses up the reserve for the power-assisted brakes.
- The brake system consists of 2 individual hydraulic systems: if one of the systems fails, the other will still operate. In this case, the brake pedal should be depressed more firmly than usual and the braking distance will increase.
If this happens, do not drive the vehicle. Have your brakes fixed immediately.

 CAUTION**■ If the vehicle becomes stuck**

Do not spin the wheels excessively when any of the tires is up in the air, or the vehicle is stuck in sand, mud, etc. This may damage the driveline components or propel the vehicle forward or backward, causing an accident.

 NOTICE**■ When driving the vehicle**

Do not use the accelerator pedal or depress the accelerator and brake pedals at the same time to hold the vehicle on a hill.

■ When parking the vehicle

Always shift the shift lever to P. Failure to do so may cause the vehicle to move or the vehicle may accelerate suddenly if the accelerator pedal is accidentally depressed.

■ Avoiding damage to vehicle parts

- Do not turn the steering wheel fully in either direction and hold it there for an extended period of time.
Doing so may damage the power steering motor.
- When driving over bumps in the road, drive as slowly as possible to avoid damaging the wheels, underside of the vehicle, etc.

■ If you hear a squealing or scraping noise (brake pad wear limit indicators)

Have your Lexus dealer check and replace the brake pads as soon as possible. The rotor damage can result if the pads are not replaced when needed.

It is dangerous to drive the vehicle when the wear limits of the brake pads and/or those of the brake discs are exceeded.

NOTICE

■ If you get a flat tire while driving

A flat or damaged tire may cause the following situations. Hold the steering wheel firmly and gradually depress the brake pedal to slow down the vehicle.

- It may be difficult to control your vehicle.
- The vehicle will make abnormal sounds.
- The vehicle will behave abnormally.

Replace a flat tire with a new one. (→P. 555)

■ When encountering flooded roads

Do not drive on a road that has flooded after heavy rain etc. Doing so may cause the following serious damage to the vehicle:

- Engine stalling
- Short in electrical components
- Engine damage caused by water immersion

In the event that you drive on a flooded road and the vehicle is flooded, be sure to have your Lexus dealer check the following:

- Brake function
- Changes in quantity and quality of oil and fluid used for the engine, transaxle, transfer (AWD models), differential, etc.
- Lubricant condition for the propeller shaft (AWD models), bearings and suspension joints (where possible) and the function of all joints, bearings, etc.

2-1. Driving procedures

Engine (ignition) switch

Performing the following operations when carrying the electronic key on your person starts the engine or changes “ENGINE START STOP” switch modes.

■ Starting the engine

STEP 1 Check that the parking brake is set.

STEP 2 Check that the shift lever is set in P.

STEP 3 Firmly depress the brake pedal.

The “ENGINE START STOP” switch indicator will turn green. If the indicator does not turn green, the engine cannot be started.



Press the “ENGINE START STOP” switch.

The engine will crank until it starts or for up to 30 seconds, whichever is less.

Continue depressing the brake pedal until the engine is completely started.

The engine can be started from any mode.



■ Stopping the engine

STEP 1 Stop the vehicle.

STEP 2 Shift the shift lever to P.

STEP 3 Set the parking brake. (→P. 156)

STEP 4 Press the “ENGINE START STOP” switch.

STEP 5 Release the brake pedal and check that the indicator on the “ENGINE START STOP” switch is off.

■ Changing “ENGINE START STOP” switch modes

Modes can be changed by pressing the “ENGINE START STOP” switch with the brake pedal released. (The mode changes each time the switch is pressed.)

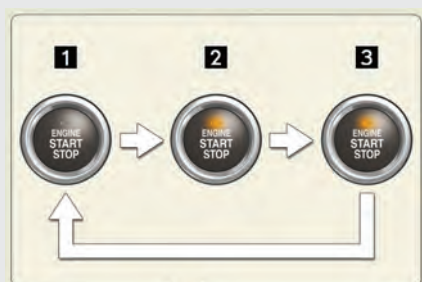

1 OFF*

The emergency flashers can be used.

2 ACCESSORY mode

Some electrical components such as the audio system can be used.

The “ENGINE START STOP” switch indicator turns amber.

3 IGNITION ON mode

All electrical components can be used.

The “ENGINE START STOP” switch indicator turns amber.

*: If the shift lever is in a position other than P when turning off the engine, the “ENGINE START STOP” switch will be turned to ACCESSORY mode, not to OFF.

When stopping the engine with the shift lever in a position other than P

If the engine is stopped with the shift lever in a position other than P, the “ENGINE START STOP” switch will not be turned off but instead be turned to ACCESSORY mode. Perform the following procedure to turn the switch off:

STEP 1 Check that the parking brake is set.

STEP 2 Shift the shift lever to P.

STEP 3 Check that the indicator on the “ENGINE START STOP” switch is illuminated in amber and then press the “ENGINE START STOP” switch once.

STEP 4 Check that the indicator on the “ENGINE START STOP” switch is off.

■ Auto power off function

If the vehicle is left in ACCESSORY or IGNITION ON mode (the engine is not running) for more than an hour with the shift lever in P, the “ENGINE START STOP” switch will automatically turn off. However, this function cannot entirely prevent battery discharge. Do not leave the vehicle with the “ENGINE START STOP” switch in ACCESSORY or IGNITION ON mode for long periods of time when the engine is not running.

■ Operation of the “ENGINE START STOP” switch

When operating the “ENGINE START STOP” switch, one short, firm press is enough. If the switch is pressed improperly, the engine may not start or the “ENGINE START STOP” switch mode may not change. It is not necessary to press and hold the switch.

■ Electronic key battery depletion

→P. 37

■ Conditions affecting operation

→P. 34

■ Note for the entry function

→P. 29

■ If the engine does not start

The engine immobilizer system may not have been deactivated. (→P. 96)

■ Steering lock

After turning the “ENGINE START STOP” switch off and opening and closing the doors, the steering wheel will be locked due to the steering lock function. Operating the “ENGINE START STOP” switch again automatically cancels the steering lock.

■ When the steering lock cannot be released



The green indicator light on the “ENGINE START STOP” switch will flash and a message will be shown on the multi-information display. Press the “ENGINE START STOP” switch again while turning the steering wheel left and right.

■ Steering lock motor overheating prevention

To prevent the steering lock motor from overheating, the motor may be suspended if the engine is turned on and off repeatedly in a short period of time. In this case, refrain from operating the engine. After about 2 seconds, the steering lock motor will resume functioning.

■ When the “ENGINE START STOP” switch indicator flashes in amber

The system may be malfunctioning. Have the vehicle inspected by your Lexus dealer immediately.

■ If the electronic key battery is depleted

→P. 488

 **CAUTION****■ When starting the engine**

Always start the engine while sitting in the driver's seat. Do not depress the accelerator pedal while starting the engine under any circumstances.

Doing so may cause an accident resulting in death or serious injury.

■ Caution while driving

If the vehicle begins to slide due to engine failure or other circumstances, do not lock or open the doors until the vehicle reaches a safe and complete stop. Activation of the steering lock in this circumstance may lead to an accident, resulting in death or serious injury.

■ Stopping the engine in an emergency

If you want to stop the engine in an emergency while driving the vehicle, press and hold the "ENGINE START STOP" switch for more than 3 seconds.

However, do not touch the "ENGINE START STOP" switch while driving unless in an emergency. If the engine stops while driving, this could lead to an accident.

NOTICE

■ To prevent battery discharge

- Do not leave the “ENGINE START STOP” switch in ACCESSORY or IGNITION ON mode for long periods of time without the engine running.
- If the indicator on the “ENGINE START STOP” switch is illuminated, the “ENGINE START STOP” switch is not off. When exiting the vehicle, always check that the “ENGINE START STOP” switch is off.
- Do not stop the engine when the shift lever is in a position other than P. If the engine is stopped in another shift lever position, the “ENGINE START STOP” switch will not be turned off but instead be turned to ACCESSORY mode. If the vehicle is left in ACCESSORY mode, battery discharge may occur.

■ When starting the engine

- Do not race a cold engine.
- If the engine becomes difficult to start or stalls frequently, have the engine checked immediately.

■ Symptoms indicating a malfunction with the “ENGINE START STOP” switch

If the “ENGINE START STOP” seems to be operating somewhat differently than usual, such as the switch sticking slightly, there may be a malfunction. Contact your Lexus dealer immediately.

2-1. Driving procedures

Automatic transmission

Select a shift position appropriate for the driving conditions.

■ Shifting the shift lever

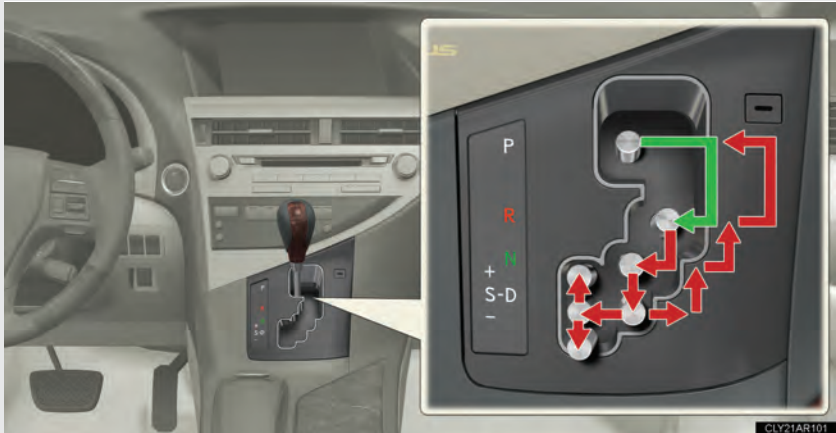

← While the “ENGINE START STOP” switch is in IGNITION ON mode, depress the brake pedal and move the shift lever.

■ Shift position purpose

Shift position	Function
P	Parking the vehicle/starting the engine
R	Reversing
N	Neutral
D	Normal driving*1
S	S mode driving*2 (→P.153)

*1: Shifting to the D position allows the system to select a gear suitable for the driving conditions. Setting the shift lever to the D position is recommended for normal driving.

*2: Selecting shift ranges using S mode restricts the upper limit of the possible gear ranges, controls engine braking forces, and prevents unnecessary upshifting.

■ Selecting snow mode

Use snow mode for accelerating and driving on slippery road surfaces such as snow.

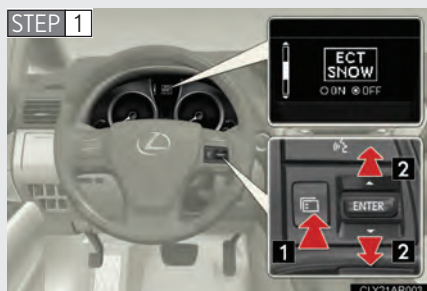

- 1 Press the menu switch.

The multi-information display will change modes to electronic features control mode.

- 2 Press the “ENTER” switch upwards or downwards until “ECT SNOW” appears.



Press the “ENTER” switch to change to “ON”.

The “ECT SNOW” indicator will be displayed.

Each pressing of the switch turns snow mode on and off.

Press the menu switch to change to the normal display.

Changing shift ranges in S mode

When the shift lever is in the S position, the shift lever can be operated as follows:

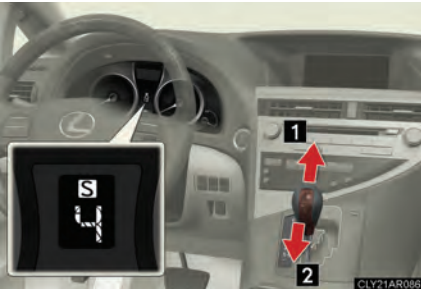

1 For upshifting

2 For downshifting

The initial shift range in S mode is set automatically to “5” or “4” according to vehicle speed. However, the initial shift range may be set to “3” if AI-SHIFT has operated while the shift lever was in the D position. (→P.154)

Shift ranges and their functions

- You can choose from 6 levels of engine braking force.
- A lower shift range will provide greater engine braking force than a higher shift range, and the engine speed will also increase.

■ Snow mode automatic deactivation

Snow mode is automatically deactivated if the “ENGINE START STOP” switch is turned off after driving in snow mode.

■ S mode

- When the shift range is “5” or lower, holding the shift lever toward “+” sets the shift range to “6”.
- To prevent the engine from over-revving, upshifting may automatically occur.
- To protect the automatic transmission, a function is adopted that automatically shifts to the top range when the temperature is too hot.

■ AI-SHIFT

AI-SHIFT automatically selects the optimal gear according to driver performance and driving conditions.

AI-SHIFT automatically operates when the shift lever is in the D position. (Shifting the shift lever to the S position cancels the function.)

■ When driving with the cruise control or dynamic radar cruise control

Engine braking will not occur in S mode, even when downshifting to “5” or “4”. (→P. 196, 200)

■ If the shift lever cannot be shifted from P

→P. 570

■ If S does not come on even after shifting the shift lever to S

This may indicate a malfunction in the automatic transmission system. Have the vehicle inspected by your Lexus dealer immediately.

(In this situation, the transmission will operate in the same as manner as when the shift lever is in D.)

■ Downshift restriction warning buzzer (S mode)

To help ensure safety and driving performance, downshifting operation may sometimes be restricted. In some circumstances, downshifting may not be possible even when the shift lever is operated. (The buzzer will sound twice.)

2-1. Driving procedures

Turn signal lever

The turn signal lever can be used to show the following intention of the driver:

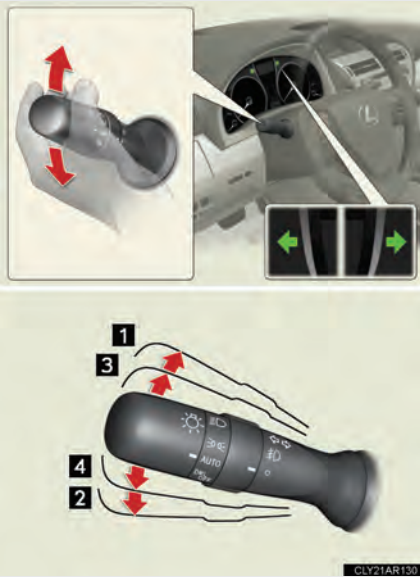

- 1 Right turn
- 2 Left turn
- 3 Lane change to the right (push and hold the lever partway)

The right hand signals will flash until you release the lever.

- 4 Lane change to the left (push and hold the lever partway)

The left hand signals will flash until you release the lever.

■ Turn signals can be operated when

The "ENGINE START STOP" switch is in IGNITION ON mode.

■ If the indicators flash faster than usual

Check that a light bulb in the front or rear turn signal lights has not burned out.

2-1. Driving procedures

Parking brake



To set the parking brake, fully depress the parking brake pedal with your left foot while depressing the brake pedal with your right foot.

(Depressing the pedal again releases the parking brake.)

■ Usage in winter time

See "Winter driving tips" for parking brake usage in winter time. (→P. 252)

⚠ NOTICE

■ Before driving

Fully release the parking brake.

Driving the vehicle with the parking brake set will lead to brake components overheating, which may affect braking performance and increase brake wear.

2-1. Driving procedures

Horn



To sound the horn, press on or close to the  mark.

2-2. Instrument cluster

Gauges and meters

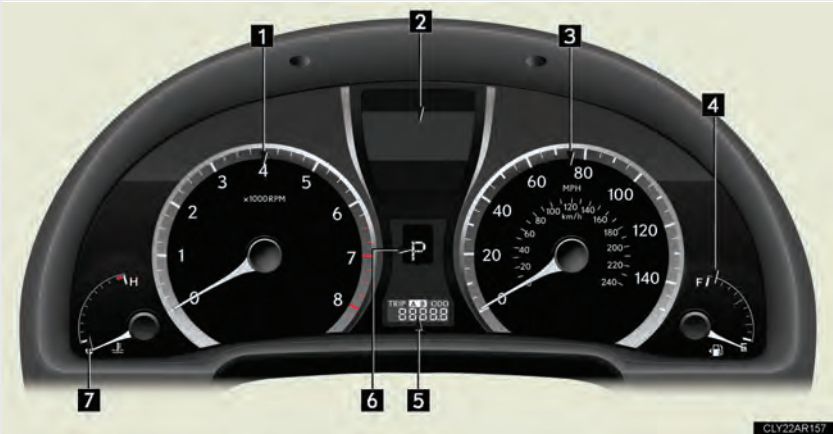

- 1** Tachometer
Displays the engine speed in revolutions per minute
- 2** Multi-information display
→P. 165
- 3** Speedometer
Displays the vehicle speed
- 4** Fuel gauge
Displays the quantity of fuel remaining in the tank
- 5** Odometer and trip meter
Odometer: Displays the total distance the vehicle has been driven
Trip meter: Displays the distance the vehicle has been driven since the meter was last reset. Trip meters "A" and "B" can be used to record and display different distances independently.
- 6** Automatic transmission shift position indicator
→P. 151
- 7** Engine coolant temperature gauge
Displays the engine coolant temperature

Changing the display



Switches between odometer and trip meter displays. When the trip meter is displayed, pressing and holding the button will reset the trip meter.

Instrument panel light control buttons

The brightness of the instrument panel lights can be adjusted.



- 1 Darker
- 2 Brighter

■ The meters and display illuminate when

The "ENGINE START STOP" switch is in IGNITION ON mode.

⚠ NOTICE

■ To prevent damage to the engine and its components

- Do not let the indicator needle of the tachometer enter the red zone, which indicates the maximum engine speed.
- The engine may be overheating if the engine coolant temperature gauge is in the red zone (H). In this case, immediately stop the vehicle in a safe place, and check the engine after it has cooled completely. (→P. 578)

2-2. Instrument cluster

Indicators and warning lights

The indicator and warning lights on the instrument cluster and center panel inform the driver of the status of the vehicle's various systems.

► Instrument cluster



► Center panel (without navigation system)

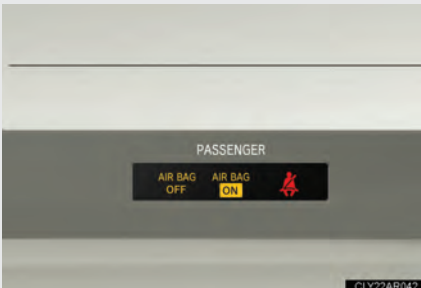

► Center panel (with navigation system)



■ Indicators

The indicators inform the driver of the operating state of the vehicle's various systems.



Turn signal indicator
(→P. 155)



Headlight high beam indicator (→P. 178)



(if equipped)

Automatic High Beam indicator (→P. 181)



(U.S.A.)

Headlight indicator (→P. 176)



(Canada)

Tail light indicator (→P. 176)



Front fog light indicator (→P. 187)



Cruise control indicator (→P. 196, 200)



(if equipped)

Radar cruise control indicator (→P. 200)



(if equipped)

Intuitive parking assist indicator (→P. 211)



(if equipped)

* "AFS OFF" indicator (→P. 178)



* Slip indicator (→P. 229)



* VSC off indicator (→P. 230)



(AWD models only)

* All-wheel drive lock indicator (→P. 234)



(if equipped)

* Electronically modulated air suspension indicator (→P. 218)



* "ECT SNOW" indicator (→P. 152)



(with navigation system)

SRS airbag on-off indicator (→P. 115)



(without navigation system)

SRS airbag on-off indicator (→P. 115)



Eco Driving Indicator Light (→P. 169)

*: These lights turn on when the “ENGINE START STOP” switch is turned to IGNITION ON mode to indicate that a system check is being performed. They will turn off after the engine is started, or after a few seconds. There may be a malfunction in a system if a light does not come on, or if the lights do not turn off. Have the vehicle inspected by your Lexus dealer, for details.

■ Warning lights

Warning lights inform the driver of malfunctions in any of the vehicle's systems. (→P. 526)

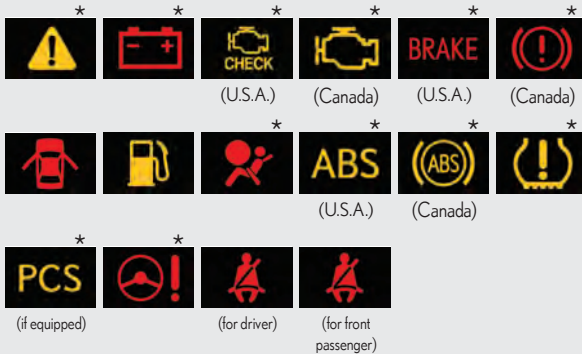

*: These lights turn on when the “ENGINE START STOP” switch is turned to IGNITION ON mode to indicate that a system check is being performed. They will turn off after the engine is started, or after a few seconds. There may be a malfunction in a system if a light does not come on, or if the lights do not turn off. Have the vehicle inspected by your Lexus dealer, for details.

▲ CAUTION

■ If a safety system warning light does not come on

Should a safety system light such as the ABS and SRS airbag warning light not come on when you start the engine, this could mean that these systems are not available to help protect you in an accident, which could result in death or serious injury. Have the vehicle inspected by your Lexus dealer immediately if this occurs.

Multi-information display

The multi-information display presents the driver with a variety of driving-related data including the current outside air temperature.

■ Multi-information Switches



1 Menu switch

Changes modes to electronic features control mode, customization mode or back to normal display mode

2 "ENTER" switch

Changes trip information items. This switch is also used to turn on/off electronic features controls and to change customization settings.

■ Display contents

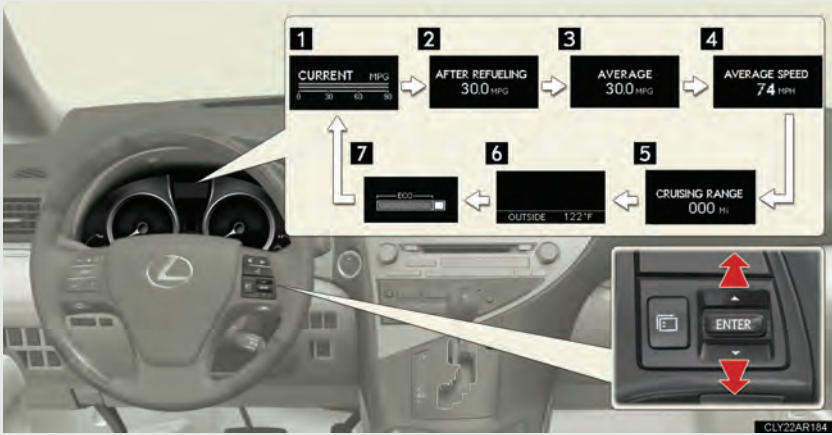

Trip information contents	Switching display items
1 Current fuel consumption	Pressing the “ENTER” switch upwards or downwards.
2 Average fuel consumption after refueling	
3 Average fuel consumption	
4 Average vehicle speed	
5 Cruising range	
6 Multi-information display OFF	
7 Eco Driving Indicator Zone Display	

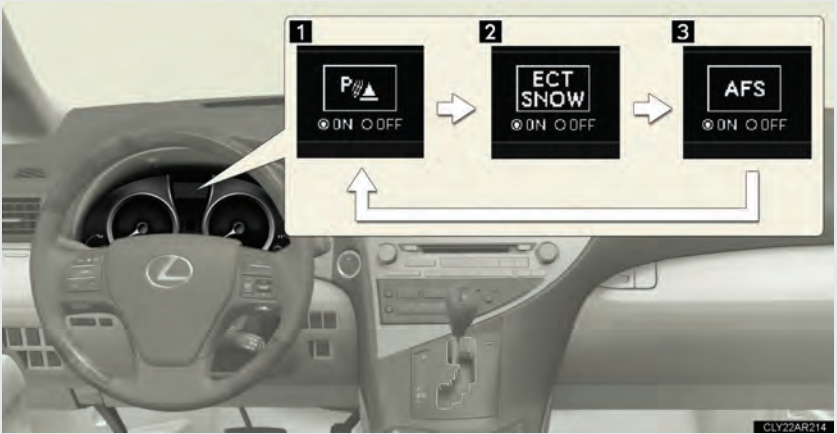

Electronic features control contents

1 Intuitive parking assist
(if equipped)

2 Snow mode

3 AFS (if equipped)

Setting electronic features controls

→P. 211

→P. 152

→P. 178

Other contents	Details
Outside temperature	Displays the outside temperature
Dynamic radar cruise control display (if equipped) (→P. 200)	Automatically displayed when using dynamic radar cruise control
Customization (→P. 610)	Settings of functions such as the door lock and light illumination time can be changed
Warning message (→P. 536)	Automatically displayed when a mal- function occurs in one of the vehi- cle's systems

Trip information

■ Current fuel consumption

Displays the current rate of fuel consumption

■ Average fuel consumption after refueling

Displays the average fuel consumption since the vehicle was last refueled

■ Average fuel consumption

Displays the average fuel consumption since the function was reset

The function can be reset by pushing the “ENTER” switch for longer than one second when the average fuel consumption is displayed.

■ Average vehicle speed

Displays the average vehicle speed since the function was reset

The function can be reset by pushing the “ENTER” switch for longer than one second when the average vehicle speed is displayed.

■ Cruising range

Displays the estimated maximum distance that can be driven with the quantity of fuel remaining

- This distance is computed based on your average fuel consumption. As a result, the actual distance that can be driven may differ from that displayed.
- When only a small amount of fuel is added to the tank, the display may not be updated.

■ Eco Driving Indicator Zone Display

→P. 169

■ Electronic features control can be turned on/off when

“ENGINE START STOP” switch is in IGNITION ON mode.

■ Conditions for ending electronic features control

In the following situations, the electronic features control will end automatically:

- The menu switch is pressed
- The radar cruise control is operated
- Intuitive parking assist starts operating
- No action is performed for some time after the electronic features control screen is displayed
- A warning message appears after the electronic features control screen is displayed

■ Eco Driving Indicator

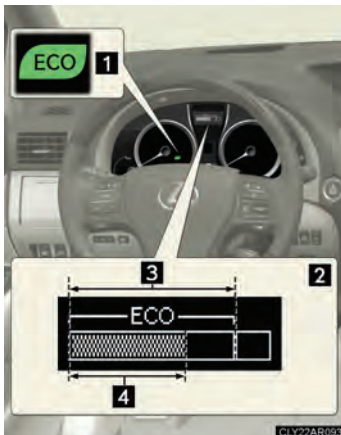

1 Eco Driving Indicator Light

During environment-friendly acceleration operation (Eco driving), Eco Driving Indicator Light will turn on.

2 Eco Driving Indicator Zone Display

Suggests Eco driving range with current Eco driving ratio based on accelerator pedal operation.

3 Zone of Eco driving

4 Eco driving ratio based on accelerator pedal operation

Vehicle to exceed the Eco driving range, the right of Eco Driving Indicator Zone Display will blink and Eco Driving Indicator Light will turn off.

Eco Driving Indicator will operate when the vehicle is being driven with the shift lever in D. Eco Driving Indicator will not operate when the vehicle is in ECT SNOW mode.

■ Outside temperature display

In the following situations, the correct outside temperature may not be displayed, or the display may take longer than normal to change.

- When stopped, or driving at low speeds (less than 15 mph [25 km/h])
- When the outside temperature has changed suddenly (at the entrance/exit of a garage, tunnel, etc.)

■ Customization

Settings (e.g.available languages) can be changed.
(Customizable features →P. 610)

CAUTION

■ Caution while driving

When operating the electronic features control while driving, take extra notice of the vehicle's surrounding area.

NOTICE

■ The multi-information display at low temperatures

Allow the interior of the vehicle to warm up before using the liquid crystal information display. At extremely low temperatures, the information display monitor may respond slowly, and display changes may be delayed.

2-2. Instrument cluster Head-up display*

The head-up display can be used to project vehicle speed and other information onto the windshield.



1 Head-up display

Display brightness will change automatically according to the brightness of the surrounding area.

2 Head-up display main switch button

3 Display contrast adjustment switch

Display brightness can be adjusted to the desired level.

4 Display position adjustment switch

*: If equipped

■ Head-up display contents

In addition to vehicle speed, the following information will be displayed:

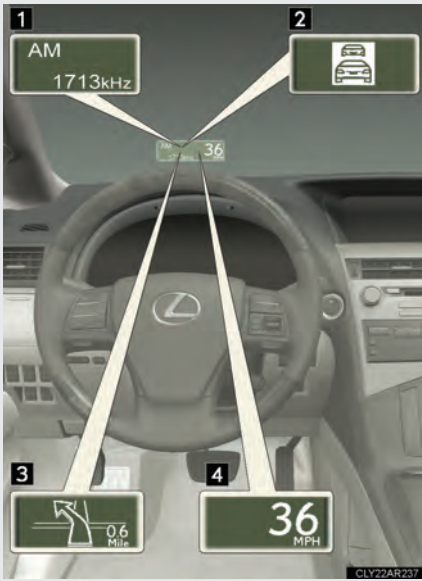

1 Audio display

Displays audio information for approximately 3 seconds when the audio system is operated

2 Dynamic radar cruise control (if equipped)

Displays the approach warning message (→P. 542)

3 Turn-by-turn navigation*

Displays a notification of upcoming intersections during navigation system route guidance

4 Vehicle speed display

*: Refer to “Navigation System Owner’s Manual”.

Head-up display main switch button



Pressing the button turns the head-up display on/off and changes the vehicle speed display units as follows:

- ▶ Vehicles sold in the U.S.A.
OFF → ON (mph) → ON (km/h) → OFF
- ▶ Except vehicles sold in the U.S.A.
OFF → ON (km/h) → ON (mph) → OFF

Display adjustment

- ▶ Adjusting display contrast



- 1 Brighter
- 2 Darker

- ▶ Adjusting display position



- 1 Higher
- 2 Lower

Display customization

The audio mode display can be shown or hidden.



Pressing and holding the head-up display main switch button for more than 2 seconds changes the display to audio display on/off mode. Press the head-up display main switch button to turn the audio display on/off.

Customization can be performed when the head-up display is on and the vehicle is traveling at less than 5 mph (8 km/h).

■ Brightness of the head-up display

The headlight control sensor detects the brightness of the area surrounding the head-up display and adjusts the brightness accordingly. (→P. 179)

■ Head-up display

The head-up display may seem dark and hard to see when viewed through sunglasses.

Adjust the brightness of the head-up display or remove your sunglasses.

⚠ CAUTION

■ Before using the head-up display

Check that the position and brightness of the head-up display image does not interfere with safe driving. Incorrect adjustment of the image's position or brightness may obstruct the driver's view and lead to an accident, resulting in death or serious injury.

 NOTICE**■ To prevent damage to components**

If an object falls into the opening of the head-up display, remove it immediately. Also, avoid spilling water or other liquids near the head-up display opening as this may cause mechanical damage.



2-3. Operating the lights and windshield wipers

Headlight switch

The headlights can be operated manually or automatically.

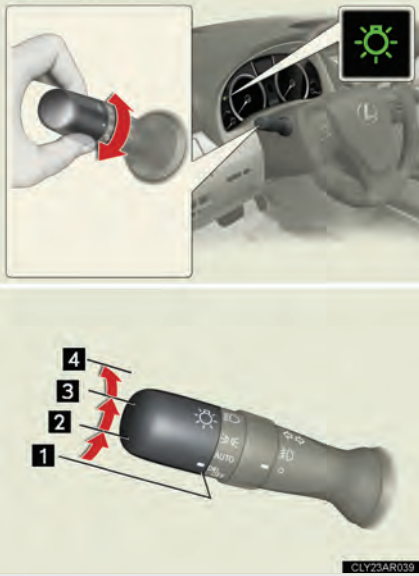



► U.S.A.

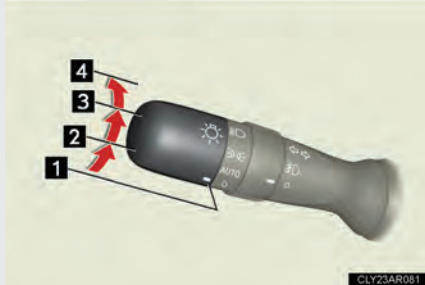
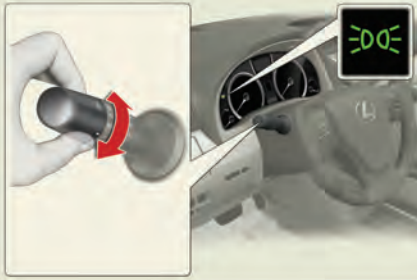

- 1**  Turn off the daytime running light system
- 2** **AUTO** The headlights and side marker, parking, tail, license plate and instrument panel lights turn on and off automatically (when the "ENGINE START STOP" switch is in IGNITION ON mode).
- 3**  The side marker, parking, tail, license plate and instrument panel lights turn on.
- 4**  The headlights and all the lights listed above turn on.

► Canada



- 1  Off
- 2  The headlights and side marker, parking, tail, license plate and instrument panel lights turn on and off automatically (when the "ENGINE START STOP" switch is in IGNITION ON mode).
- 3  The side marker, parking, tail, license plate and instrument panel lights turn on.
- 4  The headlights and all the lights listed above turn on.

Turning on the high beam headlights

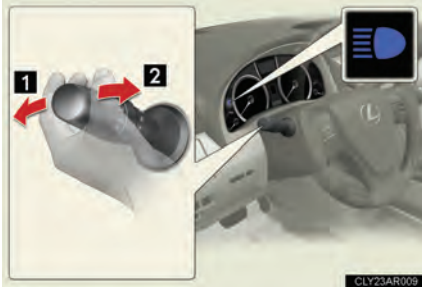

- 1 With the headlights on, push the lever away from you to turn on the high beams.

When the light switch is in “AUTO” position, the Automatic High Beam system will be activated. (→P. 181)

Pull the lever toward you to the center position to turn the high beams off.

- 2 Pull the lever toward you to turn on the high beams.

Release to turn them off. You can flash the high beams with the headlights on or off.

AFS (Adaptive Front-lighting System) (if equipped)

AFS (Adaptive Front-lighting System) improves visibility at intersections and on curves by automatically adjusting the direction of the light axis of the headlights according to vehicle speed and the degree of the tire angle that are controlled by steering input.

AFS operates at speeds of 6 mph (10 km/h) or higher.

■ Deactivating AFS



- 1 Press the menu switch.

The multi-information display will change modes to electronic features control mode.

- 2 Press the “ENTER” switch upwards or downwards until “AFS” appears.



Press the “ENTER” switch to change to “OFF”. The “AFS OFF” indicator will be displayed.

Each pressing of the switch turns “AFS” on and off.

Press the menu switch to change to the normal display.

■ Daytime running light system

To make your vehicle more visible to other drivers, the daytime running lights turn on automatically whenever the engine is started and the parking brake is released. Daytime running lights are not designed for use at night.

For the U.S.A.: Daytime running lights can be turned off by operating the switch.

■ Headlight control sensor



The sensor may not function properly if an object is placed on the sensor, or anything that blocks the sensor is affixed to the windshield.

Doing so interferes with the sensor detecting the level of ambient light and may cause the automatic headlight system to malfunction.

■ Automatic light off system

- When the headlights come on: The headlights and tail lights turn off 30 seconds after a door is opened and closed if the “ENGINE START STOP” switch is turned to ACCESSORY mode or turned off. (The lights turn off immediately if  on the key is pressed after all the doors are locked.)
- When only the tail lights come on: The tail lights turn off automatically if the “ENGINE START STOP” switch is turned to ACCESSORY mode or turned off and the driver’s door is opened.

To turn the lights on again, turn the “ENGINE START STOP” switch to IGNITION ON mode, or turn the light switch off once and then back to  or .

■ Automatic headlight leveling system (if equipped)

The level of the headlights is automatically adjusted according to the number of passengers and the loading condition of the vehicle to ensure that the headlights do not interfere with other road users.

■ If the "AFS OFF" indicator flashes

It may indicate a malfunction in the system. Contact your Lexus dealer.

■ Customization

Settings (e.g. light sensor sensitivity) can be changed.
(Customizable features →P. 610)

NOTICE

■ To prevent the battery discharge

Do not leave the lights on longer than necessary when the engine is not running.

2-3. Operating the lights and windshield wipers

Automatic High Beam*

The Automatic High Beam uses an in-vehicle camera sensor to assess the brightness of streetlights, the lights of oncoming and preceding vehicles, etc., and automatically turns high beam on or off as necessary.

■ Activating the Automatic High Beam system

STEP 1

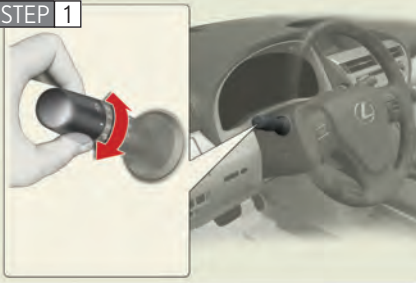

Head light switch in "AUTO" position.



CLY23AR108

STEP 2

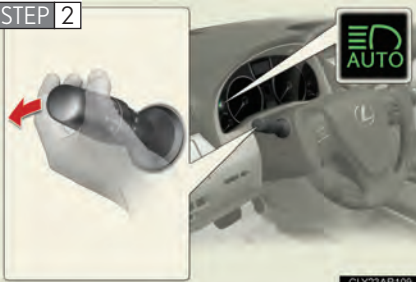

Push the lever away from you.

The Automatic High Beam indicator will come on when the headlights are turned on automatically to indicate that the system is active.

■ Turning the high beam on/off manually

▶ Switching to low beam

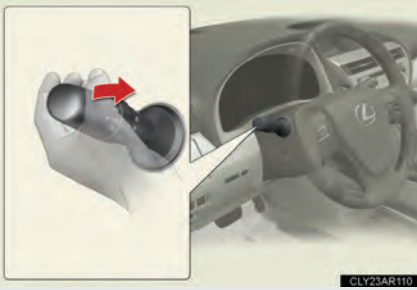

Pull the lever to original position.

▶ Switching to high beam



Turn the light switch to  position.

■ High beam automatic turning on or off conditions

When all of the following conditions are fulfilled, high beam will be automatically turned on (after approximately 1 second):

- Vehicle speed is above approximately 20 mph (32 km/h).
- The area ahead of the vehicle is dark.
- There are no oncoming or preceding vehicles with headlights or tail lights turned on.

If any of the following conditions are fulfilled, high beam will be automatically turned off:

- Vehicle speed drops below approximately 20 mph (32 km/h).
- The area ahead of the vehicle is not dark.
- Oncoming or preceding vehicles have headlights or tail lights turned on.

■ The Automatic High Beam can be operated when

The “ENGINE START STOP” switch is IGNITION ON mode.

■ Limitations of the Automatic High Beam

Do not rely on the Automatic High Beam. Always drive safely, taking care to observe your surroundings and turning high beam on or off manually if necessary.

■ Camera sensor detection information

- High beam may not be automatically turned off in the following situations:
 - When oncoming vehicles suddenly appear from a curve.
 - When the vehicle is cut in front of by another.
- High beam may be turned off if an oncoming vehicle that is using fog lights without using the headlights is detected.
- House lights, street lights, red traffic signals, and illuminated billboards or signs may cause the high beam to turn off.

2-3. Operating the lights and windshield wipers

- The following factors may affect the amount of time taken to turn high beam on or off:
 - The brightness of headlights, fog lights, and tail lights of oncoming and preceding vehicles
 - Road conditions (wetness, ice, snow etc.)
 - The number of passengers and amount of baggage
- High beam may be turned on or off when unexpected by the driver.
- In the situations below, the system may not be able to correctly detect the surrounding brightness levels, and may flash or expose nearby pedestrians to the high beam. Therefore, you should consider turning the high beams on or off manually rather than relying on the Automatic High Beam System.
 - In bad weather (rain, snow, fog, sandstorms etc.)
 - The windshield is obscured by fog, mist, ice, dirt etc.
 - The windshield is cracked or damaged.
 - The inside rear view mirror or camera sensor is deformed or dirty.
 - Surrounding brightness levels are equal to those of headlights, tail lights or fog lights.
 - Vehicles ahead have headlights that are either switched off, dirty, are changing color, or have are not aimed properly.
 - When driving through an area of intermittently changing brightness and darkness
 - When frequently and repeatedly driving ascending/descending roads, or roads with rough, bumpy or uneven surfaces (such as stone-paved roads, gravel tracks etc.)
 - When frequently and repeatedly taking curves or driving on a winding road
 - There is a highly reflective object ahead of the vehicle, such as a sign or a mirror.
 - The vehicle's headlights are damaged or dirty.
 - The vehicle is listing or tilting, due to a flat tire, a trailer being towed etc.
 - The Automatic High Beam indicator is flashing.
 - The high beam and low beam are repeatedly being switched between in an abnormal manner.
 - The driver believes that the high beam may be causing problems or distress to other drivers or pedestrians nearby.

■ If the Automatic High Beam indicator flashes

It may indicate a malfunction in the system. Contact your Lexus dealer.

■ Temporary lowering sensor sensitivity

The sensitivity of the sensor can be temporarily lowered.

To lower the sensitivity, push and hold the “AUTO” button on the inside rear view mirror for 15 to 20 seconds, and release. The indicator light on the inside rear view mirror will flash to indicate that the sensitivity has been lowered.

When the “ENGINE START STOP” switch is turned off, the sensitivity will be returned to its normal level.

■ Customization that can be configured at your Lexus dealer

The Automatic High Beam can be turned off.

NOTICE

■ Notes when using the Automatic High Beam system



Observe the following to ensure that the Automatic High Beam functions correctly.

- Do not touch the camera sensor.
- Do not subject the inside rear view mirror or the camera sensor to a strong impact.
- Do not disassemble the camera sensor.
- Do not spill liquid onto the inside rear view mirror or the camera sensor.
- Do not apply window tinting or stickers to the camera sensor or the area of windshield near the camera sensor.
- Do not place items on the dashboard. There is a possibility that the camera sensor will mistake items reflected in the windshield for streetlights, the headlights of other vehicles, etc.
- Do not install a parking tag or any other accessories near or around the inside rear view mirror and the camera sensor.
- Do not overload the vehicle.
- Do not modify the vehicle.
- Do not replace windshield with non-genuine windshield.
Contact your Lexus dealer.

2-3. Operating the lights and windshield wipers

Fog light switch

The fog lights improve visibility in difficult driving conditions, such as in rain and fog.

► U.S.A.

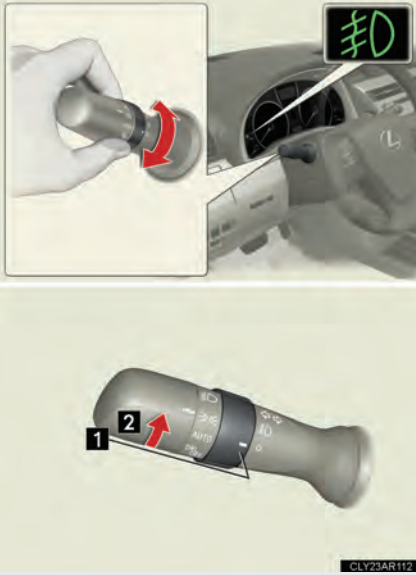

- 1 **○** Turns the front fog lights off
- 2 **F** Turns the front fog lights on

► Canada

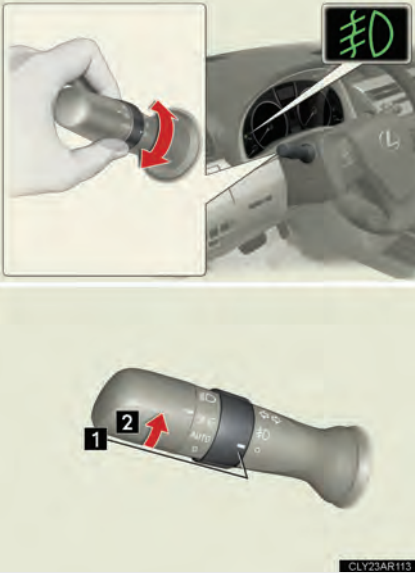

- 1 **0** Turns the front fog lights off
- 2 **F** Turns the front fog lights on

- Fog lights can be used when
The head lights are on in low beam.





2-3. Operating the lights and windshield wipers

Windshield wipers and washer



► Intermittent wipers with interval adjuster

When intermittent wiper operation is selected, wiper intervals can be adjusted as follows by turning the switch ring:



- 1  Off
- 2  Intermittent windshield wiper operation
- 3  Low speed windshield wiper operation
- 4  High speed windshield wiper operation
- 5  Temporary operation



- 6  Increases the intermittent windshield wiper frequency
- 7  Decreases the intermittent windshield wiper frequency



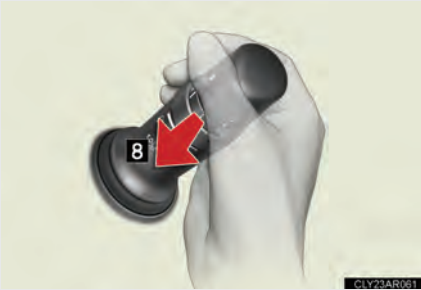

8 Washer/wiper dual operation

The wipers will automatically operate a couple of times after the washer squirts.





If the headlights are on, the headlight cleaners will operate once.

► Rain-sensing windshield wipers

When **AUTO** is selected, the wipers will operate automatically when the sensor detects falling rain. The system automatically adjusts wiper timing in according to rain volume and vehicle speed.

When **AUTO** is selected, the sensor sensitivity can be adjusted as follows by turning the switch ring:



- 1  Off
- 2 **AUTO** Rain-sensing wiper operation
- 3  Low speed wiper operation
- 4  High speed wiper operation
- 5  Temporary operation



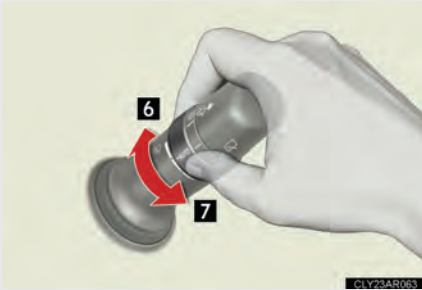

6 Sensor sensitivity (high)

7 Sensor sensitivity (low)



8 Washer/wiper dual operation

The wipers will automatically operate a couple of times after the washer squirts.

(After operating several times, the wipers operate one more time after a short delay to prevent dripping.)

If the headlights are on, the headlight cleaners will operate once.

■ The windshield wipers and washer can be operated when

The “ENGINE START STOP” switch is in IGNITION ON mode.

■ Effects of vehicle speed on wiper operation

Vehicle speed affects the following even when the wipers are not in “AUTO” mode:

- Intermittent wiper interval
- Wiper operation when the washer is being used (delay until drip prevention wiper sweep occurs)

When low speed wiper operation is selected, wiper operation will be switched from low speed to intermittent wiper operation only when the vehicle is stationary.

(However, when the sensor sensitivity is adjusted to the highest, the mode cannot be switched.)

■ Rain drop sensor (vehicles with rain-sensing windshield wipers)



The raindrop sensor judges the amount of raindrops.

An optical sensor is adopted. It may not operate properly when sunlight from the rising or setting of the sun intermittently strikes the windshield, or if bugs etc. are present on the windshield.

If the wiper switch is turned to the **AUTO** while the “ENGINE START STOP” switch is in IGNITION ON mode, the wipers will operate once to show that “AUTO” mode is activated.

■ In extremely hot or cold weather (vehicles with rain-sensing windshield wipers)

The rain-sensing wiper operation will turn off if the windshield gets extremely hot (at more than 194°F [90°C]) or cold (at less than 5.0°F [-15°C]). If the windshield wipers cease operation while in AUTO mode, change to a mode other than AUTO.

■ If no windshield washer fluid sprays

Check that the washer nozzles are not blocked if there is washer fluid in the windshield washer fluid reservoir.

CAUTION

■ Caution regarding the use of windshield wipers in “AUTO” mode (vehicles with rain-sensing windshield wipers)

The windshield wipers may operate unexpectedly if the sensor is touched or the windshield is subject to vibration in “AUTO” mode. Take care that your fingers or anything else do not become caught in the windshield wipers.

 NOTICE**■ When the windshield is dry**

Do not use the wipers, as they may damage the windshield.

■ When the washer fluid tank is empty

Damage to the washer fluid pump may be caused if the lever is pulled toward you and held continually.

■ When a nozzle becomes blocked





Do not try to clear it with a pin or other object. The nozzle will be damaged.

2-3. Operating the lights and windshield wipers

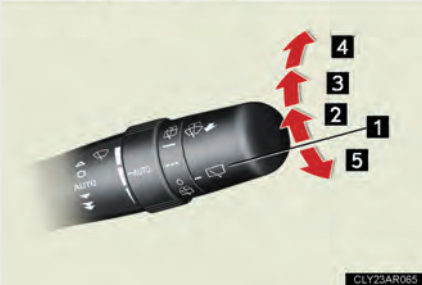
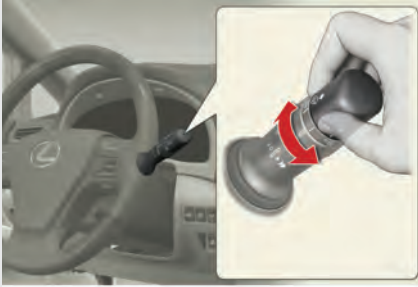
Rear window wiper and washer

The wiper operation is selected by moving the lever as follows:



- 1  Off
- 2  Intermittent window wiper operation
- 3  Normal window wiper operation
- 4  Washer/wiper dual operation
- 5  Washer/wiper dual operation

- The rear window wiper and washer can be operated when the “ENGINE START STOP” switch is in IGNITION ON mode.

NOTICE

- **When the rear window is dry**

Do not use the wipers, as they may damage the rear window.

- **When the washer fluid tank is empty**

Damage to the washer fluid pump may be caused if the lever is operated continually.

- **When a nozzle becomes blocked**

Do not try to clear it with a pin or other object. The nozzle will be damaged.

2-3. Operating the lights and windshield wipers

Headlight cleaner switch*

Washer fluid can be sprayed on the headlights.



Press the switch to clean the headlights.

2

When driving

■ The headlight cleaner can be operated when

The "ENGINE START STOP" switch is in IGNITION ON mode and the headlight switch is turned on.

NOTICE

■ When the washer fluid tank is empty

Do not press the switch continually as the washer fluid pump may overheat.

*: If equipped

2-4. Using other driving systems

Cruise control*

Use the cruise control to maintain a set speed without depressing the accelerator pedal.

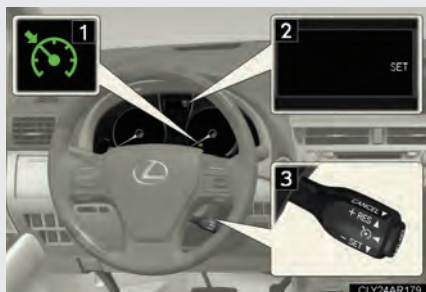

- 1 Indicator
- 2 Display
- 3 Cruise control switch

■ Setting the vehicle speed

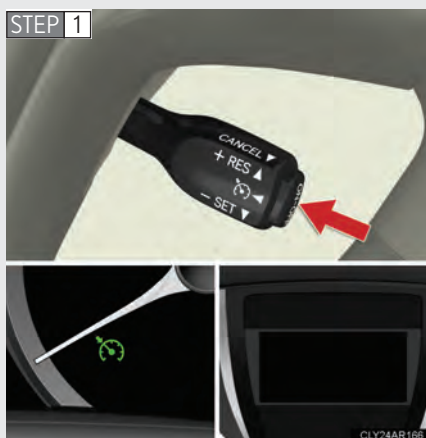

STEP 1

Press the "ON-OFF" button to activate the cruise control.

Press the button again to deactivate the cruise control.

STEP 2



■ Adjusting the set speed

Accelerate or decelerate to the desired speed, and push the lever down to set the speed.

“SET” will be displayed.

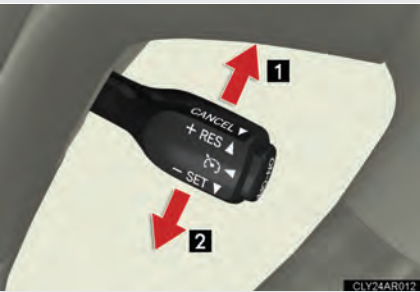

- 1 Increases the speed
- 2 Decreases the speed

Hold the lever until the desired speed setting is obtained.

Fine adjustment of the set speed can be made by lightly pushing the lever up or down and releasing it.

■ Canceling and resuming the constant speed control

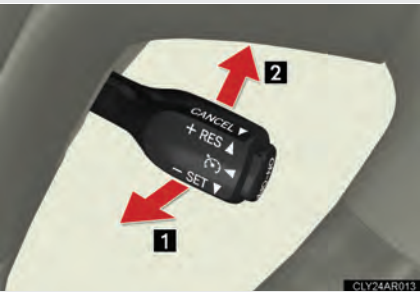

- 1 Pulling the lever towards you cancels the constant speed control.

The speed setting is also canceled when the brakes are applied.

- 2 Pushing the lever up resumes the constant speed control.

■ Cruise control can be set when

- The shift lever is in D or “4”, “5” or “6” range of S has been selected.
- Vehicle speed is above 25 mph (40 km/h).

■ Accelerating

The vehicle can be accelerated normally. After acceleration, the set speed resumes.

■ Automatic cruise control cancelation

The cruise control will stop maintaining the vehicle speed in any of the following situations:

- Actual vehicle speed falls more than 10 mph (16 km/h) below the preset vehicle speed.
At this time, the memorized set speed is not retained.
- Actual vehicle speed is below 25 mph (40km/h).
- VSC is activated.

■ If the cruise control indicator light flashes

Press the “ON-OFF” button once to deactivate the system, and then press the button again to reactivate the system.

If the cruise control speed cannot be set or if the cruise control cancels immediately after being activated, there may be a malfunction in the cruise control system. Have the vehicle inspected by your Lexus dealer.

 **CAUTION****■ To avoid operating the cruise control by mistake**

Switch the cruise control off using the “ON-OFF” button when not in use.

■ Situations unsuitable for cruise control

Do not use cruise control in any of the following situations.

Doing so may result in loss of control and could cause an accident resulting in death or serious injury.

- In heavy traffic
- On roads with sharp bends
- On slippery roads, such as those covered with rain, ice or snow
- On winding roads
- On steep hills
Vehicle speed may exceed the set speed when driving down a steep hill.
- When your vehicle is towing anything

2-4. Using other driving systems

Dynamic radar cruise control*

Dynamic radar cruise control supplements conventional cruise control with a vehicle-to-vehicle distance control. In the vehicle-to-vehicle distance control mode, the vehicle automatically accelerates or decelerates in order to maintain a set following distance from vehicles ahead.

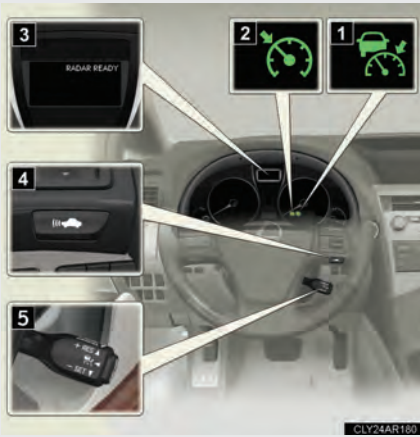

- 1 Indicator (vehicle-to-vehicle distance control mode)
- 2 Indicator (constant speed control mode)
- 3 Display
- 4 Vehicle-to-vehicle distance switch
- 5 Cruise control switch

■ Selecting cruise mode



Selecting vehicle-to-vehicle distance control mode:

Press the "ON-OFF" button to activate the cruise control.

Press the button again to deactivate the cruise control.

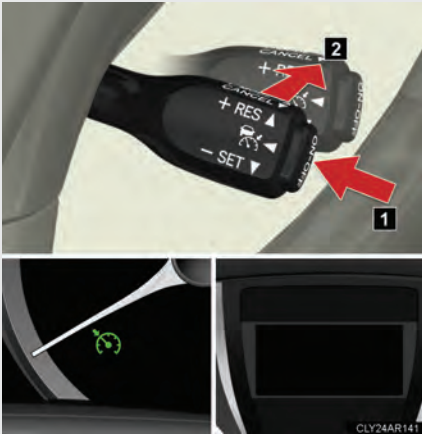

Selecting conventional constant speed control mode:

- 1 Press the “ON-OFF” button to activate the cruise control.

Press the button again to deactivate the cruise control.

- 2 Switch to constant speed control mode.

(Push and hold for approximately one second.)

Constant speed control mode indicator will come on.

Vehicle-to-vehicle distance control mode is always reset when the “ENGINE START STOP” switch is turned to IGNITION ON mode.

■ Driving in the selected cruise control mode



Accelerate or decelerate to the desired speed, and push the lever down to set the speed.

“SET” will be displayed.

■ Adjusting the speed setting

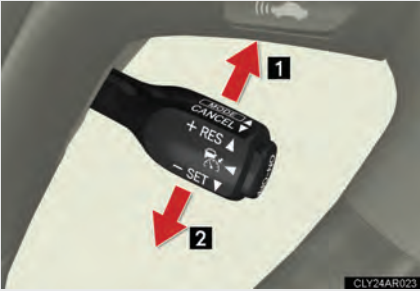

- 1 Increases the speed
- 2 Decreases the speed

Hold the lever until the desired speed setting is displayed.

Fine adjustment of the set speed can be made by lightly pushing the lever up or down and releasing it.

■ Canceling and resuming the constant speed control

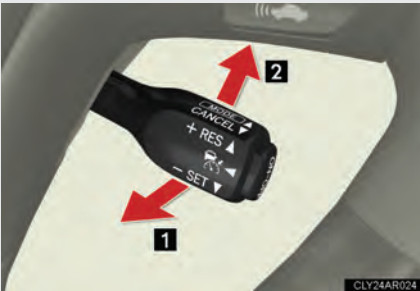

- 1 Pulling the lever toward you cancels the constant speed control.

The speed setting is also canceled when the brakes are applied.

- 2 Pushing the lever up resumes the constant speed control.

■ Changing the vehicle-to-vehicle distance

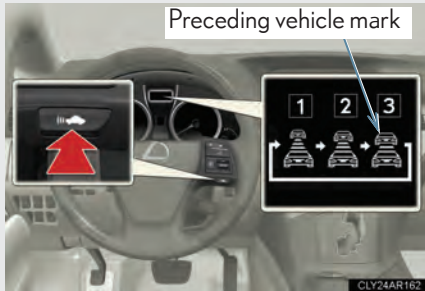

Pressing the button changes the vehicle-to-vehicle distance as follows:

- 1 Long
- 2 Medium
- 3 Short

The vehicle-to-vehicle distance is set automatically to long mode when the “ENGINE START STOP” switch is turned to IGNITION ON mode.

If a vehicle is running ahead of you, the preceding vehicle mark will be also displayed.

Driving in vehicle-to-vehicle distance control mode

This mode employs a sensor to detect the presence of vehicles up to approximately 400 ft. (120 m) ahead and to judge the distance between your vehicle and the vehicle ahead of you.

Note that vehicle-to-vehicle distance will close in when traveling on long downhill slopes.

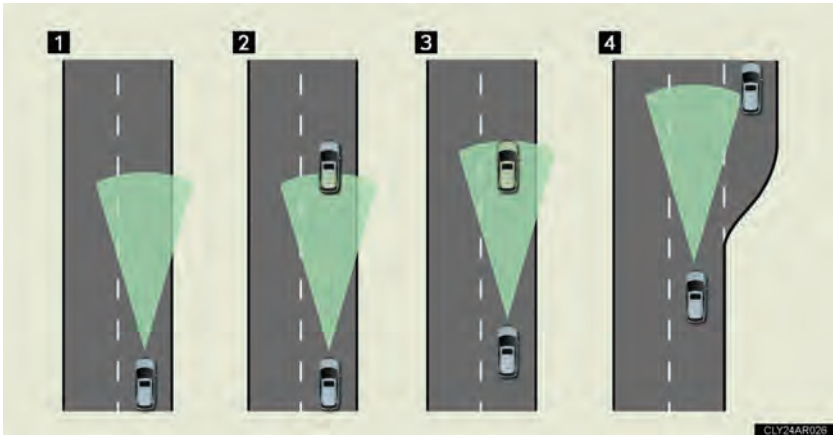

1 Example of constant speed cruising
When there are no vehicles ahead

The vehicle travels at the speed set by the driver. The desired vehicle-to-vehicle distance can also be set by operating the vehicle-to-vehicle distance control.

2 Example of deceleration cruising
When the vehicle ahead is driving slower than the set speed

When a vehicle is detected running ahead of you in the same lane, the system automatically decelerates your vehicle. When a greater reduction in vehicle speed is necessary, the system applies the brakes. A warning tone warns you when the system cannot decelerate sufficiently to prevent your vehicle from closing in on the vehicle ahead.

3 Example of follow-up cruising

When following a vehicle driving slower than the set speed

The system continues follow-up cruising while adjusting for changes in the speed of the vehicle ahead in order to maintain the vehicle-to-vehicle distance set by the driver.

4 Example of acceleration

When there no longer are vehicles driving slower than the set speed in the lane ahead

When the vehicle ahead of you executes a lane change, the system slowly accelerates until the set speed is reached. The system then returns to constant speed cruising.

Approach warning

When your vehicle is too close to a vehicle ahead, and sufficient automatic deceleration via the cruise control is not possible, the display will flash and a buzzer will sound to alert the driver. An example of this would be if another driver cuts in front of you while you are following a vehicle. Apply the brakes to ensure an appropriate vehicle-to-vehicle distance.

Dynamic radar cruise can be set when

- The shift lever is in D. (Recommended)

Dynamic radar cruise control can also be set when the shift lever is in the S position and range “4”, “5”, or “6” has been selected.

- Vehicle speed is above approximately 30 mph (50 km/h).

Switching modes

The mode cannot be switched to constant speed control mode if vehicle-to-vehicle distance control mode has been used. The mode also cannot be switched from constant speed control to vehicle-to-vehicle distance control mode. Turn the system off by pressing the “ON-OFF” button, and turn it on again.

Accelerating

The vehicle can accelerate normally. After acceleration, the set speed resumes.

■ Automatic cancelation of vehicle-to-vehicle distance control

Vehicle-to-vehicle distance control driving is automatically canceled in the following situations:

- Actual vehicle speed falls below approximately 25 mph (40 km/h).
- VSC is activated.
- The sensor cannot operate correctly because it is covered in some way.
- The windshield wipers are operating at high speed.
- When snow mode is set.

If vehicle-to-vehicle distance control driving is automatically canceled for any other reason, there may be a malfunction in the system. Contact your Lexus dealer.

■ Automatic cancelation of constant speed control

The cruise control will stop maintaining the vehicle speed in the following situations:

- Actual vehicle speed is more than 10 mph (16 km/h) below the set vehicle speed.
At this time, the memorized set speed is not retained.
- Vehicle speed falls below approximately 25 mph (40 km/h).
- VSC is activated.

■ Vehicle-to-vehicle distance settings

Select a distance from the table below. Note that the distances shown correspond to a vehicle speed of 50 mph (80 km/h). Vehicle-to-vehicle distance increases/decreases in accordance with vehicle speed.

Distance options	Vehicle-to-vehicle distance
Long	Approximately 164 ft. (50 m)
Medium	Approximately 132 ft. (40 m)
Short	Approximately 82 ft. (25 m)

■ Radar sensor and grille cover

Always keep the sensor and grille cover clean to ensure that the vehicle-to-vehicle distance control operates properly. (Some obstructions, such as snow, ice and plastic objects, cannot be detected by the obstruction sensor.)

Dynamic radar cruise control is canceled if an obstruction is detected.

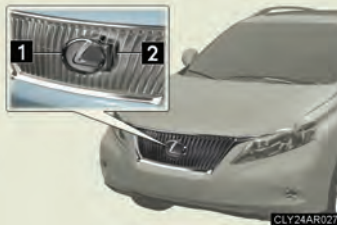

- 1 Grille cover
- 2 Radar sensor

■ Warning lights and messages for dynamic radar cruise control

Warning lights and messages are used to indicate a system malfunction or to inform the driver of the need for caution while driving. (→P. 542)

■ Approach warning

In the following instances, there is a possibility that the approach warnings will not occur:

- When the speed of the vehicle ahead matches or exceeds your vehicle speed
- When the vehicle ahead is traveling at an extremely slow speed
- Immediately after the cruise control speed was set
- At the instant the accelerator is applied

■ Certification

► For vehicles sold in U.S.A.

FCC ID: HYQDNMWR005

This device complies with Part 15 of the FCC Rules. Operation is subject to the following two conditions: (1) this device may not cause harmful interference, and (2) this device must accept any interference received, including interference that may cause undesired operation.

FCC WARNING

Changes or modifications not expressly approved by the party responsible for compliance could void the use's authority to operate the equipment.

Radio frequency radiation exposure Information:

This equipment complies with FCC radiation exposure limits set forth for an uncontrolled environment.

This equipment should be installed and operated with minimum distance of 20 cm between the radiator and your body.

This transmitter must not be co-located or operating in conjunction with any other antenna or transmitter.

► For vehicles sold in Canada

Operation is subject to the following two conditions: (1) this device may not cause interference, and (2) this device must accept any interference, including interference that may cause undesired operation of the device.

CAUTION

■ Before using dynamic radar cruise control

Do not overly rely on vehicle-to-vehicle distance control.

Be aware of the set speed. If automatic deceleration/acceleration is not appropriate, adjust the vehicle speed, as well as the distance between your vehicle and vehicles ahead by applying the brakes etc.

■ To avoid inadvertent dynamic radar cruise control activation

Switch the cruise control off using the "ON-OFF" button when not in use.

 **CAUTION****■ Situations unsuitable for dynamic radar cruise control**

Do not use dynamic radar cruise control in any of the following situations. Doing so may result in inappropriate speed control and could cause an accident resulting in death or serious injury.

- In heavy traffic
- On roads with sharp bends
- On winding roads
- On slippery roads, such as those covered with rain, ice and snow
- On steep downhill, or where there are sudden changes between sharp up and down gradients
- At entrances to expressways
- When weather conditions are bad enough that they may prevent the sensors from functioning correctly (fog, snow, sandstorm, heavy rain, etc.)
- Where a buzzer is heard often
- When your vehicle is towing anything

■ When the sensor may not be correctly detecting the vehicle ahead

Apply the brakes as necessary when any of the following types of vehicles are in front of you.

As the sensor may not be able to correctly detect these types of vehicles, the approach warning (→P. 205) will not be activated, and an accident may result.

- Vehicles that cut in suddenly
- Vehicles traveling at low speeds
- Vehicles that are not moving
- Vehicles with small rear ends (trailers with no load on board etc.)
- Motorcycles traveling in the same lane

CAUTION

■ Conditions under which the vehicle-to-vehicle distance control may not function correctly

Apply the brakes as necessary in the following conditions as the radar sensor may not be able to correctly detect vehicles ahead, and an accident may result:

- When water or snow thrown up by the surrounding vehicles hinders the functioning of the radar sensor
- When your vehicle is pointing upwards (caused by a heavy load in the luggage compartment etc.)
- When the road curves or when the lanes are narrow
- When steering wheel operation or your position in the lane is unstable
- When the vehicle ahead of you decelerates suddenly

■ To ensure the radar sensor functions correctly

Do not do the following to the sensor or grille as doing so may cause the sensor not to function correctly and could result in an accident:

- Sticking or attaching anything to them
- Leaving them dirty
- Disassembling or subjecting them to strong shocks
- Modifying or painting them
- Replacing them with non-genuine parts

■ Handling the radar sensor

Observe the following to ensure the cruise control system can function effectively:

- Keep the sensor and front grille clean at all times.
Clean the sensor and front grille with a soft cloth so you do not mark or damage them.
- Do not subject the sensor or surrounding area to a strong impact.
If the sensor moves even slightly off position, the system may malfunction. If the sensor or surrounding area is subject to a strong impact, always have the area inspected and adjusted by your Lexus dealer.
- Do not disassemble the sensor.
- Do not attach accessories or stickers to the sensor, grille or surrounding area.
- Do not modify or paint the sensor and grille.

2-4. Using other driving systems

Intuitive parking assist*

The distance to obstacles measured by the sensors is communicated via the multi-information display and a buzzer when parallel parking or maneuvering into a garage is conducted. Always check the surrounding area when using this system.

■ Types of sensors



- 1 Front corner sensors
- 2 Rear corner sensors
- 3 Rear center sensors

■ Setting the Intuitive parking assist mode



- 1 Press the menu switch.
The multi-information display will change modes to electronic features control mode.
- 2 Press the "ENTER" switch upwards or downwards until the intuitive parking assist mark appears in the multi-information display.

*: If equipped

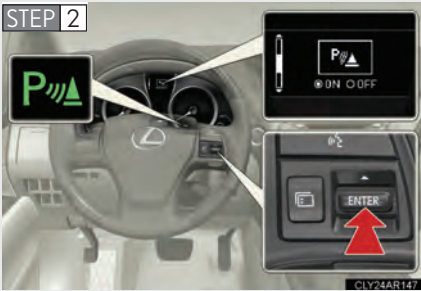

Press the “ENTER” switch to change to “ON”.

The intuitive parking assist indicator will be displayed.

Each pressing of the switch turns the intuitive parking assist on and off.

When on, the buzzer sounds to inform the driver that the system is operational.

Press the menu switch to change to the normal display.

Display

When the sensors detect an obstacle, the graphic is shown on the multi-information display depending on the position and distance to the obstacle.





- 1 Front corner sensor operation
- 2 Rear corner sensor operation
- 3 Rear center sensor operation



The distance display and buzzer

When a sensor detects an obstacle, the direction of and the approximate distance to the obstacle are displayed and the buzzer sounds.





■ Front corner sensors

Detection level	Multi-information display	Approximate distance to obstacle	Buzzer
2		2.0 to 1.6 ft. (60 to 47.5 cm)	Medium
3		1.6 to 1.2 ft. (47.5 to 35 cm)	Fast
4		1.2 ft. (35 cm) or less	Continuous

■ Rear corner sensors

Detection level	Multi-information display	Approximate distance to obstacle	Buzzer
2		1.6 to 1.2 ft. (50 to 37.5 cm)	Medium
3		1.2 to 0.8 ft. (37.5 to 25 cm)	Fast
4		0.8 ft. (25 cm) or less	Continuous

■ Rear center sensors

Detection level	Multi-information display	Approximate distance to obstacle	Buzzer
1		4.9 to 2.0 ft. (150 to 60 cm)	Slow
2		2.0 to 1.5 ft. (60 to 45 cm)	Medium
3		1.5 to 1.2 ft. (45 to 35 cm)	Fast
4		1.2 ft. (35 cm) or less	Continuous

Detection range of the sensors

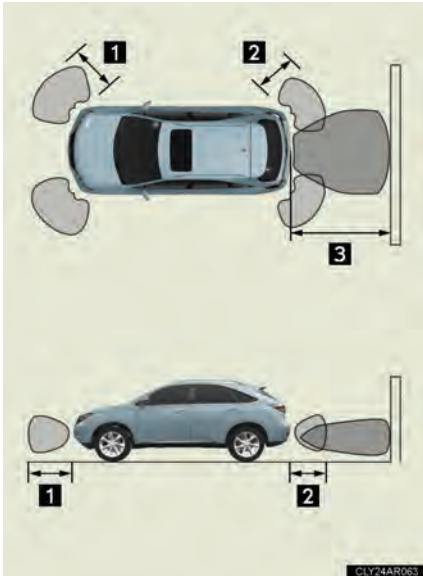

- 1 Approximately 2.0 ft. (60 cm)
- 2 Approximately 1.6 ft. (50 cm)
- 3 Approximately 4.9 ft. (150 cm)

The diagram shows the detection range of the sensors. Note that the sensors cannot detect obstacles that are extremely close to the vehicle.

The range of the sensors may change depending on the shape of the object etc.

2

When driving

■ The intuitive parking assist can be operated when

- Front corner sensors:
 - The “ENGINE START STOP” switch is in IGNITION ON mode.
 - The shift lever is in a position other than P.
 - The vehicle speed is less than about 6 mph (10 km/h).
- Rear corner and center sensors:
 - The “ENGINE START STOP” switch is in IGNITION ON mode.
 - The shift lever is in R.

■ Sensor detection information

- Certain vehicle conditions and the surrounding environment may affect the ability of a sensor to correctly detect an obstacle. Particular instances where this may occur are listed below.
 - There is dirt, snow or ice on a sensor.
 - A sensor is frozen.
 - A sensor is covered in any way.
 - The vehicle is leaning considerably to one side.
 - On an extremely bumpy road, on an incline, on gravel, or on grass
 - The vicinity of the vehicle is noisy due to vehicle horns, motorcycle engines, air brakes of large vehicles, or other loud noises producing ultrasonic waves.
 - There is another vehicle equipped with parking assist sensors in the vicinity.
 - A sensor is coated with a sheet of spray or heavy rain.
 - The vehicle is equipped with a fender pole or radio antenna.
 - Towing eyelets are installed.
 - A bumper or sensor receives a strong impact.
 - The vehicle is approaching a tall or right-angled curb.
 - In harsh sunlight or intense cold weather.
 - A non-genuine Lexus suspension (lowered suspension, etc.) is installed.

In addition to the examples above, there are instances in which, because of their shapes, signs and other objects may be judged by a sensor to be closer than they are.

- The shape of the obstacle may prevent a sensor from detecting it. Pay particular attention to the following obstacles:
 - Wires, fences, ropes, etc.
 - Cotton, snow and other materials that absorb sound waves
 - Sharply-angled objects
 - Low obstacles
 - Tall obstacles with upper sections projecting outwards in the direction of your vehicle

■ If a message is displayed

→P. 536

■ Certification (Canada only)

This ISM device complies with Canadian ICES-001.

■ Customization

Settings (e.g. buzzer volume) can be changed. (Customizable features →P. 610)

CAUTION

■ Caution when using the intuitive parking assist

Observe the following precautions.

Failing to do so may result in the vehicle being unable to be driven safely and possibly cause an accident.

- Do not use the sensor at speeds in excess of 6 mph (10 km/h).
- Do not attach any accessories within the sensor range.

NOTICE

■ Notes when washing the vehicle

Do not apply intensive bursts of water or steam to the sensor area.
Doing so may result in the sensor malfunctioning.

■ Conditions possibly indicating system malfunctions

If any of the following occurs, the system may be malfunctioning due to a sensor failure etc. Have the vehicle inspected by your Lexus dealer.

- The buzzer does not sound when the intuitive parking assist mode is set.
- The sensor operation display flashes and the buzzer sounds even when no obstacle is detected.
- An area of the sensors is hit or subjected to a strong impact.
- Either bumper is hit.
- The sensor operation display remains on even though no buzzer sounds.

2-4. Using other driving systems

Electronically modulated air suspension *

The electronically modulated air suspension allows the driver to control vehicle height in order to adjust driving conditions.

Select the desired height with the height selector switch.

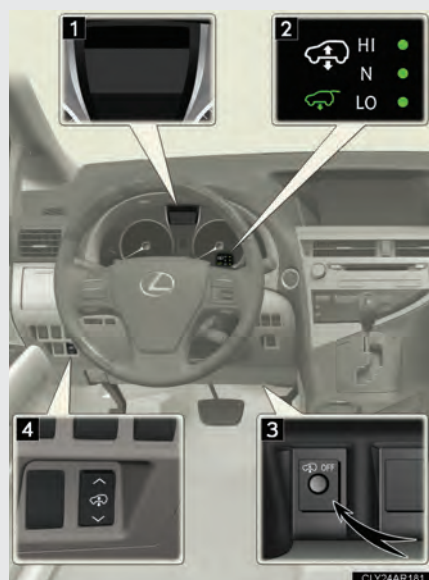

- 1 Multi-information display
- 2 Electronically modulated air suspension indicator
- 3 Height control off button
- 4 Height selector switch (driver's side instrument panel)
- 5 Height selector switch (luggage compartment)



*: If equipped

Selecting vehicle height

■ Height modes

- “HI” mode: For driving on bumpy roads

1.2 in. (30 mm) higher than the normal height

“HI” mode cannot be selected when vehicle speed exceeds 19 mph (30 km/h).

- “N” mode: For ordinary driving

Normal height

- “LO” mode: For sporty driving

Vehicle front: 0.8 in. (20 mm) lower than the normal height

Vehicle rear: 0.2 in. (5 mm) lower than the normal height

- Luggage mode: For easy entry/exit and easy luggage loading/unloading

1.2 in. (30 mm) lower than the normal height

■ Height selector switch

Press the height selector switch for approximately 1 second.

► Driver's side instrument panel



1 Higher

Pressing this switch while the vehicle is in luggage mode changes the vehicle height to that of “N” mode.

2 Lower

Pressing the switch while the vehicle is in “LO” mode changes the vehicle height to that of luggage mode.

► Luggage compartment



1 Higher

Pressing this switch while the vehicle is in luggage mode changes the vehicle height to that of "N" mode.

2 Lower

Pressing this switch while the vehicle is in "N" mode changes the vehicle height to that of luggage mode, not "LO" mode.

■ Electronically modulated air suspension indicator



The indicator for the selected mode will come on.

The indicator will flash while the vehicle height is being changed to the height of the selected mode.

Disabling the height control



Press the height control off button while the vehicle is stopped. A message will appear on the multi-information display, and vehicle height will be fixed in the current mode.

When vehicle speed exceeds 19 mph (30 km/h), the electronically modulated air suspension is re-enabled automatically.

■ Operating conditions

After stopping the engine, the vehicle will remain lowered for a maximum of 60 seconds.

- Height selector switch (driver's side instrument panel)
 - While the engine is running, any vehicle height mode can be selected.
 - Luggage mode can only be selected when the shift lever is in the P position.
- Height selector switch (luggage compartment)
 - When the engine is running and the shift lever is in the P position, any vehicle height other than "LO" mode can be selected.
 - When the "ENGINE START STOP" switch is turned off, the vehicle height can only be lowered (only the "V" side of the switch can be operated).

This switch can only be operated when the back door is open.

● Height control button

When the vehicle is stopped with the "ENGINE START STOP" switch in IGNITION ON mode, vehicle height control can be disabled/re-enabled.

■ When changing vehicle height modes

Before operating the height selector switch to raise/lower the vehicle height, ensure that there are no objects in the surrounding area that could damage the vehicle.

■ When "N" mode is selected

During high speed driving, the vehicle height will automatically change to that of "LO" mode.

■ When "HI" mode is selected

The vehicle height will change to that of "N" mode when vehicle speed reaches 31 mph (50 km/h) or when vehicle speed has exceeded 19 mph (30 km/h) for approximately 10 seconds. Even if vehicle speed is reduced below 19 mph (30 km/h) the vehicle height will not automatically return to "HI" mode.

■ When "LO" mode is selected

The vehicle height will change to that of "N" mode when the engine is restarted.

■ When luggage mode is selected

If the vehicle begins to move while still in luggage mode, the vehicle will automatically change to "N" mode once speed exceeds 5 mph (8 km/h). Even if vehicle speed is reduced below 5 mph (8 km/h), the vehicle height will not automatically return to luggage mode.

■ Operating sound of the air suspension

When the vehicle height is lowered, such as when entering and loading the vehicle, or when the height selector switch is operated, the sound of the compressor operating or the mode changing may be heard. This does not indicate a malfunction.

■ Automatic leveling function

Regardless of the number of occupants and the luggage load, vehicle height in any mode is always adjusted to a fixed height by the automatic leveling function.

■ Vehicle height mode change time

- If the height control is operated continuously to lower the vehicle, the suspension air tank may become full, causing operation of the vehicle height lowering control to become slow.
- To protect the compressor, the system will only raise the vehicle for a total of 100 consecutive seconds. If it takes longer than this to reach the selected height, operation may be suspended shortly and then restart. However, it may not be possible to change the vehicle's height mode at this time.

■ The electronically modulated air suspension will not operate when:

The vehicle height control may not be able to change modes when the vehicle runs over a high curb or other rugged surfaces where the suspension is stretched.

CAUTION

■ The electronically modulated air suspension must be disabled when

The electronically modulated air suspension must be disabled in the following situations as vehicle height may change, resulting in accidental damage:

- Any of the wheels is stuck in a ditch.
- It is necessary to jack up the vehicle.
- It is necessary to tow the vehicle with part of it lifted.
- When connecting/disconnecting a trailer.

For safety, stop the engine if necessary.

 NOTICE**■ “HI” mode**

- “HI” mode should be used for off-road driving. As the vehicle's center of gravity is higher in this setting, the vehicle may become unstable if an abrupt turn is made.
- Do not select “HI” mode when loading cargo on the roof luggage carrier. This may result in a loss of control or vehicle rollover.

■ Do not select “LO” mode when driving on bumpy roads.

If the underbody of the vehicle touches a rugged road surface, the vehicle may be damaged. Also be careful when driving while the vehicle is automatically returning from luggage or “LO” mode to “N” mode.

■ Automatic return to “N” mode

In the following situations, the height of the vehicle will automatically increase. Be careful in any place where overhead space is limited.

- The vehicle begins to move while still in luggage mode.
- The engine is restarted while the vehicle is in “LO” mode.

■ Vehicle height while parked

If the temperature changes or the vehicle is parked for a long time, the vehicle height may decrease.

2-4. Using other driving systems

Rear view monitor system (rear view mirror-attached type)*

The rear view monitor system assists the driver by displaying an image of the area behind the vehicle. The image is displayed in reverse on the screen. This reversed image is a similar image to the one on the inside rear view mirror.



The rear view image is displayed when the shift lever is in the R position.

If the shift lever is shifted out of R, the screen is turned off.

■ The rear view monitor system can be operated when

The "ENGINE START STOP" switch is in IGNITION ON mode and the back door is fully closed.

■ Switching the screen on/off



When the screen is displayed, press the "AUTO" button on the inside rear view mirror to switch the screen on/off

Screen on: Green indicator comes on.

Screen off: Orange indicator comes on.

The auto anti-glare inside rear view mirror will revert to the screen on each time the "ENGINE START STOP" switch to the IGNITION ON mode.

■ Displayed area

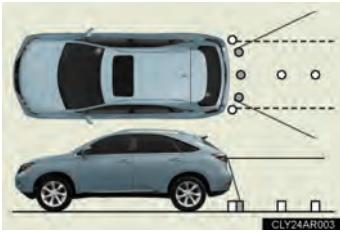

The area covered by the camera is limited. Objects that are close to either corner of the bumper or under the bumper cannot be seen on the screen.

The area displayed on the screen may vary according to vehicle orientation or road conditions.



■ Rear view monitor system camera



In the following cases, it may become difficult to see the images on the screen, even when the system is functioning correctly:

- The vehicle is in a dark area, such as at night.
- The temperature near the lens is extremely high or low.
- Water droplets are on the camera lens or humidity is high, such as when it rains.
- Foreign matter, such as snow or mud, adheres to the camera lens.
- The sun or headlights are shining directly into the camera lens.

■ Smear effect



If a bright light, such as sunlight reflected off the vehicle body, is picked up by the camera, a smear effect* characteristic to the camera may occur.

*: Smear effect — A phenomenon that occurs when a bright light is picked up by the camera; when transmitted by the camera, the light source appears to have a vertical streak above and below it.

 **CAUTION**

- **When using the rear view monitor system, observe the following precautions to avoid an accident that could result in death or serious injuries:**
 - Never depend solely on the monitor system when reversing.
 - Always check visually and with the mirrors to confirm your intended path is clear.
 - Depicted distances between objects and flat surfaces differ from actual distances.
- **Conditions which may affect the rear view monitor system**
 - If the back of the vehicle has been hit, the camera's position and mounting angle may have changed. Have the vehicle inspected by your Lexus dealer.
 - Rapid temperature changes, such as when hot water is poured on the vehicle in cold weather, may cause the system to function abnormally.
 - If the camera lens is dirty, it cannot transmit a clear image. Rinse with water and wipe with a soft cloth. If extremely dirty, wash with a mild cleanser and rinse.
 - The displayed image may be darker and moving images may be slightly distorted when the system is cold.

Driving assist systems

To help enhance driving safety and performance, the following systems operate automatically in response to various driving situations. Be aware, however, that these systems are supplementary and should not be relied upon too heavily when operating the vehicle.

■ ABS (Anti-lock Brake System)

Helps to prevent wheel lock when the brakes are applied suddenly, or if the brakes are applied while driving on a slippery road surface

■ Brake assist

Generates an increased level of braking force after the brake pedal is depressed, when the system detects a panic stop situation

■ VSC (Vehicle Stability Control)

Helps the driver to control skidding when swerving suddenly or turning on slippery road surfaces

■ TRAC (Traction Control)

Maintains drive power and prevents any of the drive wheels from spinning when starting the vehicle or accelerating on slippery roads

■ Hill-start assist control

→P. 235

■ EPS (Electric Power Steering)

Employs an electric motor to reduce the amount of effort needed to turn the steering wheel

■ Active torque control 4WD system (AWD models only)

Automatically switches from front-wheel drive to AWD (All-Wheel Drive) according to driving conditions, helping to ensure reliable handling and stability. Examples of conditions where the system will switch to AWD are when cornering, going uphill, starting off or accelerating, and when the road surface is slippery due to snow or rain etc.

■ Enhanced VSC (Enhanced vehicle stability control)

Provides cooperative control of the ABS, TRAC, VSC and EPS.
Helps to maintain directional stability when swerving on slippery road surfaces by controlling steering performance.

■ VDIM (Vehicle Dynamics Integrated Management) (if equipped)

Provides integrated control of the ABS, brake assist, TRAC, VSC, enhanced VSC, and hill-start assist control systems
Maintains vehicle stability when swerving on slippery road surfaces by controlling the brakes and engine output

■ PCS (Pre-Collision System) (if equipped)

→P. 237

When the VSC/TRAC systems are operating



If the vehicle is in danger of slipping or rolling backward when starting on an incline, or if any of the drive wheels spins, the slip indicator light flashes to indicate that the VSC/TRAC systems are operating.

A buzzer (intermittent) sounds to indicate that VSC is operating.

Disabling the TRAC/VSC systems

If the vehicle gets stuck in fresh snow or mud, the TRAC/VSC systems may reduce power from the engine to the wheels. You may need to turn the system off to enable you to rock the vehicle in order to free it.

■ Turning off the TRAC system only



To turn the TRAC system off, quickly press and release the button.

A message will be shown on the multi-information display.

Press the button again to turn the system back on.

■ Turning off both TRAC and VSC systems



To turn the TRAC and VSC systems off, press and hold the button for more than 3 seconds while the vehicle is stopped.

A message will be shown on the multi-information display and VSC off indicator light will come on.

Press the button again to turn the systems back on.

■ Sounds and vibrations caused by the ABS, brake assist, VSC and TRAC systems

- A sound may be heard from the engine compartment when the engine is started or just after the vehicle begins to move. This sound does not indicate that a malfunction has occurred in any of these systems.
- Any of the following conditions may occur when the above systems are operating. None of these indicates that a malfunction has occurred.
 - Vibrations may be felt through the vehicle body and steering.
 - A motor sound may be heard after the vehicle comes to a stop.
 - The brake pedal may pulsate slightly after the ABS is activated.
 - The brake pedal may move down slightly after the ABS is activated.

■ EPS operation sound

When the steering wheel is operated, a motor sound (whirring sound) may be heard. This does not indicate a malfunction.

■ Reactivation of the TRAC /VSC systems after turning off the engine

Turning off the engine after turning off the TRAC/VSC systems will automatically reactivate them.

■ Reactivation of the TRAC system linked to vehicle speed

When only the TRAC system is turned off, the TRAC system will turn on when vehicle speed increases. However, when both TRAC and VSC systems are turned off, the systems will not turn on even when vehicle speed increases.

■ Reduced effectiveness of the EPS system

The effectiveness of the EPS system is reduced to prevent the system from overheating when there is frequent steering input over an extended period of time. The steering wheel may feel heavy as a result. Should this occur, refrain from excessive steering input or stop the vehicle and turn the engine off. The EPS system should return to normal within 10 minutes.

CAUTION

■ The ABS does not operate effectively when

- Tires with inadequate gripping ability are used (such as excessively worn tires on a snow covered road).
- The vehicle hydroplanes while driving at high speed on a wet or slick road.

■ Stopping distance when the ABS is operating will exceed that of normal conditions

The ABS is not designed to shorten the vehicle's stopping distance. Always maintain a safe distance from the vehicle in front of you in the following situations:

- When driving on dirt, gravel or snow-covered roads
- When driving with tire chains
- When driving over bumps in the road
- When driving over roads with potholes or roads with uneven surfaces

■ TRAC may not operate effectively when

Directional control and power may not be achievable while driving on slippery road surfaces, even if the TRAC system is operating.

Do not drive the vehicle in conditions where stability and power may be lost.

 **CAUTION****■ When the VSC is activated**

The slip indicator light flashes and a warning buzzer sounds. Always drive carefully. Reckless driving may cause an accident. Exercise particular care when the indicator light flashes and a buzzer sounds.

■ When the TRAC/VSC systems are turned off

Be especially careful and drive at a speed appropriate to the road conditions. As these are the systems to ensure vehicle stability and driving force, do not turn the TRAC/VSC systems off unless necessary.

■ Replacing tires

Make sure that all tires are of the same size, brand, tread pattern and total load capacity. In addition, make sure that the tires are inflated to the recommended tire inflation pressure level.

The ABS and VSC systems will not function correctly if different tires are installed on the vehicle.

Contact your Lexus dealer for further information when replacing tires or wheels.

■ Handling of tires and suspension

Using tires with any kind of problem or modifying the suspension will affect the driving assist systems, and may cause a system malfunction.

2-4. Using other driving systems

All-wheel drive lock switch (AWD models)

All-wheel drive lock mode can be used when a large amount of drive power needs to be applied to all the wheels, such as when the vehicle gets stuck in mud and you need to free it.



Press the switch.

The torque of the engine is distributed to the rear wheels to the maximum extent possible in accordance with driving conditions.

Pressing the switch again cancels all-wheel drive lock mode and returns the active torque control 4WD system to normal mode. (→P. 228)

■ All-wheel drive lock mode

- All-wheel drive lock mode is canceled when the brakes are applied to ensure the ABS and VSC systems operate effectively.
- All-wheel drive lock mode is canceled when the vehicle speed exceeds 25 mph (40 km/h).

2-4. Using other driving systems

Hill-start assist control

Hill-start assist control helps to prevent the vehicle from rolling backwards when starting on an incline or slippery slope.



To engage hill-start assist control, further depress the brake pedal when the vehicle is stopped completely.

A buzzer will sound once to indicate the system is activated. The slip indicator will also start flashing.

■ Hill-start assist control can be operated when

- The shift lever is in a position other than P.
- The parking brake is not applied.
- The accelerator pedal is not depressed.

■ Hill-start assist control

- While hill-start assist control is operating, the brakes remain automatically applied after the driver releases the brake pedal. The stop lights and the high mounted stoplight turn on.
- Hill-start assist control operates for about 2 seconds after the brake pedal is released.
- If the slip indicator does not flash and the buzzer does not sound when the brake pedal is further depressed, slightly reduce the pressure on the brake pedal (do not allow the vehicle to roll backward) and then firmly depress it again. If the system still does not operate, check if the operating conditions explained above have been met.

■ Hill-start assist control buzzer

- When hill-start assist control is activated, the buzzer will sound once.
- In the following situations, hill-start assist control will be canceled and the buzzer will sound twice.
 - No attempt is made to drive the vehicle within approximately 2 seconds of releasing the brake pedal.
 - The shift lever is moved to P.
 - The parking brake is applied.
 - The brake pedal is depressed again.
 - The brake pedal has been depressed for more than approximately 3 minutes.

■ If the slip indicator comes on

It may indicate a malfunction in the system. Contact your Lexus dealer.

CAUTION

■ Hill-start assist control

- Do not overly rely on hill-start assist control. Hill-start assist control may not operate effectively on extremely steep inclines or roads covered in ice.
- Unlike the parking brake, hill-start assist control is not intended to hold the vehicle stationary for an extended period of time. Do not attempt to use hill-start assist control to hold the vehicle on an incline for an extended period of time, as doing so may lead to an accident.

Pre-Collision System *

When the radar sensor detects an unavoidable frontal collision, safety systems such as the brakes and seat belts are automatically engaged in an attempt to lessen vehicle damage.

■ Pre-collision seat belts (front seatbelt only)

If the pre-collision sensor detects that a collision is unavoidable, the pre-collision system will retract the seat belt before the collision occurs.

The same will happen if the driver makes an emergency braking or loses control of the vehicle. (→P. 75)

However, the system will not operate in the event of skidding when the TRAC/VSC systems are disabled.

■ Pre-collision brake assist

When there is a high possibility of a frontal collision, the system applies greater braking force in relation to how strongly the brake pedal is depressed.

Radar sensor



The radar sensor detects vehicles or other obstacles on or near the road ahead and determines whether a collision is imminent based on the position, speed, and heading of the obstacles.

■ The pre-collision system is operational when

- Pre-collision seat belts linked to the radar sensor
 - Vehicle speed is greater than about 3 mph (5 km/h).
 - The speed at which your vehicle is approaching the obstacle or oncoming vehicle is greater than about 18 mph (30 km/h).
 - The front occupants are wearing a seat belt.
- Pre-collision seat belts in the event of sudden braking or skidding
 - Vehicle speed is greater than about 18 mph (30 km/h).
 - The system detects sudden braking or skidding.
 - The front occupants are wearing a seat belt.
- Pre-collision brake assist
 - Vehicle speed is greater than about 18 mph (30 km/h).
 - The speed at which your vehicle is approaching the obstacle or the vehicle running ahead of you is greater than about 18 mph (30 km/h).
 - The brake pedal is depressed.

■ Conditions that may trigger the system even if there is no danger of collision

- When there is an object by the roadside at the entrance to a curve
- When passing an oncoming vehicle on a curve
- When driving over a narrow iron bridge
- When there is a metal object on the road surface
- When driving on an uneven road surface
- When passing an oncoming vehicle on a left-turn
- When your vehicle rapidly closes on the vehicle in front

When the system is activated in the situations described above, there is also a possibility that the seat belts will retract quickly and the brakes will be applied with a force greater than normal. When the seat belt is locked in the retracted position, stop the vehicle in a safe place, release the seat belt and refasten it.

■ Obstacles not detected

The sensor cannot detect plastic obstacles such as traffic cones. There may also be occasions when the sensor cannot detect pedestrians, animals, bicycles, motorcycles, trees, or snowdrifts.

■ When there is a malfunction in the system

Warning lights and/or warning messages will turn on or flash. (→P. 526, 536)

■ Certification

► For vehicles sold in U.S.A.

FCC ID: HYQDNMWR005

This device complies with Part 15 of the FCC Rules. Operation is subject to the following two conditions: (1) this device may not cause harmful interference, and (2) this device must accept any interference received, including interference that may cause undesired operation.

FCC WARNING

Changes or modifications not expressly approved by the party responsible for compliance could void the user's authority to operate the equipment.

Radio frequency radiation exposure Information:

This equipment complies with FCC radiation exposure limits set forth for an uncontrolled environment.

This equipment should be installed and operated with minimum distance of 20 cm between the radiator and your body.

This transmitter must not be co-located or operating in conjunction with any other antenna or transmitter.

► For vehicles sold in Canada

Operation is subject to the following two conditions: (1) this device may not cause interference, and (2) this device must accept any interference, including interference that may cause undesired operation of the device.

 **CAUTION****■ Limitations of the pre-collision system**

Do not rely on the pre-collision system. Always drive safely, taking care to observe your surroundings and checking for any obstacles or other road hazards.

■ When the sensor may not be correctly detecting the vehicle ahead

Apply the brakes as necessary in any of the following situations.

- When water or snow thrown up by the surrounding vehicles hinders the functioning of the sensor
- When your vehicle is pointing upwards (caused by a heavy load in the luggage compartment etc.)
- Vehicles that cut in suddenly
- Vehicles with small rear ends (trailers with no load on board etc.)
- Motorcycles traveling in the same lane

■ Handling the radar sensor

Observe the following to ensure the pre-collision system can function effectively:

- Keep the sensor and front grille clean at all times.
Clean the sensor and front grille with a soft cloth so you do not mark or damage them.
- Do not subject the sensor or surrounding area to a strong impact.
If the sensor moves even slightly off position, the system may malfunction. If the sensor or surrounding area is subject to a strong impact, always have the area inspected and adjusted by your Lexus dealer.
- Do not disassemble the sensor.
- Do not attach accessories or stickers to the sensor, grille or surrounding area.
- Do not modify or paint the sensor and grille cover.

Utility vehicle precautions

This vehicle belongs to the utility vehicle class, which has higher ground clearance and narrower tread in relation to the height of its center of gravity to make it capable of performing in a wide variety of off-road applications.

Off-road vehicle feature

- Specific design characteristics give it a higher center of gravity than ordinary passenger cars. This vehicle design feature causes this type of vehicle to be more likely to rollover. And, utility vehicles have a significantly higher rollover rate than other types of vehicles.
- An advantage of the higher ground clearance is a better view of the road allowing you to anticipate problems.
- It is not designed for cornering at the same speeds as ordinary passenger cars any more than low-slung sports cars designed to perform satisfactorily under off-road conditions. Therefore, sharp turns at excessive speeds may cause rollover.

 **CAUTION****■ Off-road vehicle precautions**

Always observe the following precautions to minimize the risk of death or serious injury or damage to your vehicle:

- In a rollover crash, an unbelted person is significantly more likely to die than a person wearing a seat belt. Therefore, the driver and all passengers should fasten their seat belts whenever the vehicle is moving.
- Avoid sharp turns or abrupt maneuvers, if at all possible.
Failure to operate this vehicle correctly may result in loss of control or vehicle rollover causing death or serious injury.
- Loading cargo on the roof luggage carrier will make the center of the vehicle gravity higher. Avoid high speeds, sudden starts, sharp turns, sudden braking or abrupt maneuvers, otherwise it may result in loss of control or vehicle rollover due to failure to operate this vehicle correctly.
- Always slow down in gusty crosswinds. Because of its profile and higher center of gravity, your vehicle is more sensitive to side winds than an ordinary passenger car. Slowing down will allow you to have better control.
- Do not drive horizontally across steep slopes. Driving straight up or straight down is preferred. Your vehicle (or any similar off-road vehicle) can tip over sideways much more easily than forward or backward.

Off-road driving

When driving your vehicle off-road, please observe the following precautions to ensure your driving enjoyment and to help prevent the closure of areas to off-road vehicles.

- Drive your vehicle only in areas where off-road vehicles are permitted to travel.
- Respect private property. Get owner's permission before entering private property.
- Do not enter areas that are closed. Honor gates, barriers and signs that restrict travel.
- Stay on established roads. When conditions are wet, driving techniques should be changed or travel delayed to prevent damage to roads.

■ Additional information for off-road driving

► For owners in U.S. mainland, Hawaii and Puerto Rico:

To obtain additional information pertaining to driving your vehicle off-road, consult the following organizations.

- State and Local Parks and Recreation Departments
- State Motor Vehicle Bureau
- Recreational Vehicle Clubs
- U.S. Forest Service and Bureau of Land Management

 CAUTION**■ Off-road driving precautions**

Always observe the following precautions to minimize the risk of death or serious injury or damage to your vehicle:

- Drive carefully when off the road. Do not take unnecessary risks by driving in dangerous places.
- Do not grip the steering wheel spokes when driving off-road. A bad bump could jerk the wheel and injure your hands. Keep both hands and especially your thumbs on the outside of the rim.
- Always check your brakes for effectiveness immediately after driving in sand, mud, water or snow.
- After driving through tall grass, mud, rock, sand, water, etc., check that there is no grass, bush, paper, rags, stone, sand, etc. adhering or trapped to the underbody. Clear off any such matter from the underbody. If the vehicle is used with these materials trapped or adhering to the underbody, a breakdown or fire could occur.
- When driving off-road or in rugged terrain, do not drive at excessive speeds, jump, make sharp turns, strike objects, etc. This may cause loss of control or vehicle rollover causing death or serious injury. You are also risking expensive damage to your vehicle's suspension and chassis.

 NOTICE**■ To prevent water damage**

Take all necessary safety measures to ensure that water damage to the engine or other components does not occur.

- Water entering the engine air intake will cause severe engine damage.
- Water entering the automatic transmission will cause deterioration in shift quality, locking up of your transmission accompanied by vibration, and ultimately damage.
- Water can wash the grease from wheel bearings, causing rusting and premature failure, and may also enter the differentials, transmission and transfer case, reducing the gear oil's lubricating qualities.

NOTICE

■ When you drive through water

If driving through water, such as when crossing shallow streams, first check the depth of the water and the bottom of the stream for firmness. Drive slowly and avoid deep water.

■ Inspection after off-road driving

- Sand and mud that has accumulated around brake discs may affect braking efficiency and may damage brake system components.
- Always perform a maintenance inspection after each day of off-road driving that has taken you through rough terrain, sand, mud, or water. For scheduled maintenance information, refer to the "Warranty and Services Guide/Owner's Manual Supplement/Scheduled Maintenance".

Cargo and luggage

Take notice of the following information about storage precautions, cargo capacity and load:

- Stow cargo and luggage in the luggage compartment whenever possible.
- Be sure all items are secured in place.
- Be careful to keep the vehicle level. Placing the weight as far forward as possible helps maintain vehicle balance.
- For better fuel economy, do not carry unnecessary weight.

Capacity and distribution

Cargo capacity depends on the total weight of the occupants.

(Cargo capacity) = (Total load capacity) – (Total weight of occupants)

Steps for Determining Correct Load Limit—

- (1) Locate the statement “The combined weight of occupants and cargo should never exceed XXX kg or XXX lbs.” on your vehicle’s placard.
- (2) Determine the combined weight of the driver and passengers that will be riding in your vehicle.
- (3) Subtract the combined weight of the driver and passengers from XXX kg or XXX lbs.
- (4) The resulting figure equals the available amount of cargo and luggage load capacity.

For example, if the “XXX” amount equals 1400 lbs. and there will be five 150 lb. passengers in your vehicle, the amount of available cargo and luggage load capacity is 650 lbs. (1400 – 750 (5 × 150) = 650 lbs.)

- (5) Determine the combined weight of luggage and cargo being loaded on the vehicle. That weight may not safely exceed the available cargo and luggage load capacity calculated in Step 4.

(6) If your vehicle will be towing a trailer, load from your trailer will be transferred to your vehicle. Consult this manual to determine how this reduces the available cargo and luggage load capacity of your vehicle. (→P. 584)

Example based on your vehicle

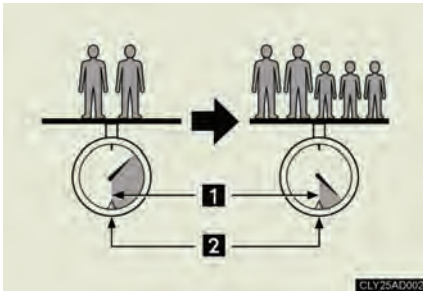

- 1 Cargo capacity
- 2 Total load capacity

When 2 people with the combined weight of 366 lb. (166 kg) are riding in your vehicle, which has a total load capacity of 825 lb. (370 kg), the available amount of cargo and luggage load capacity will be as follows:

$$825 \text{ lb.} - 366 \text{ lb.} = 459 \text{ lb.} \quad (370 \text{ kg} - 166 \text{ kg} = 204 \text{ kg})$$

In this condition, if 3 more passengers with the combined weight of 388 lb. (176 kg) get on, the available cargo and luggage load will be reduced as follows:

$$459 \text{ lb.} - 388 \text{ lb.} = 71 \text{ lb.} \quad (204 \text{ kg} - 176 \text{ kg} = 28 \text{ kg})$$

As shown in the example above, if the number of occupants increases, the cargo and luggage load will be reduced by an amount that equals the increased weight due to the additional occupants. In other words, if an increase in the number of occupants causes an excess of the total load capacity (combined weight of occupants plus cargo and luggage load), you must reduce the cargo and luggage on your vehicle.

 **CAUTION**
■ Things that must not be carried in the luggage compartment

The following things may cause a fire if loaded in the luggage compartment:

- Receptacles containing gasoline
- Aerosol cans

■ Storage precautions

Observe the following precautions.

Failure to do so may result in death or serious injury.

- Stow cargo and luggage in the luggage compartment whenever possible.
 - Do not stack anything in the luggage compartment higher than the seatbacks. Such items may be thrown about and possibly injure people in the vehicle in the event of sudden braking or in an accident.
 - Do not place cargo or luggage in or on the following locations as the item may get under the brake or accelerator pedal and prevent pedals from being depressed properly, block the driver's vision, or hit the driver or passengers, causing an accident:
 - Driver's feet
 - Front passenger or rear seats (when stacking items)
 - Luggage cover
 - Instrument panel
 - Dashboard
 - Secure all items in the occupant compartment, as they may shift and injure someone in the event of an accident or sudden braking.
 - Never allow anyone to ride in the luggage compartment. It is not designed for passengers. They should ride in their seats with their seat belts properly fastened. Otherwise, they are much more likely to suffer death or serious bodily injury, in the event of sudden braking or an accident.
- Capacity and distribution**
- Do not exceed the maximum axle weight rating or the total vehicle weight rating.
 - Even if the total load of occupant's weight and the cargo load is less than the total load capacity, do not apply the load unevenly. Improper loading may cause deterioration of steering or braking control which may cause death or serious injury.

CAUTION

■ Roof luggage carrier precautions

To use the roof rails as a roof luggage carrier, you must fit the roof rails with two or more genuine Lexus cross rails or their equivalent.

When you load cargo on the roof luggage carrier, observe the following:

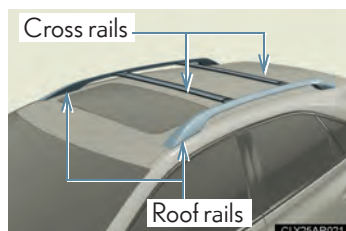

- Place the cargo so that its weight is distributed evenly between the front and rear axles.
- If loading long or wide cargo, never exceed the vehicle's overall length or width. (→P. 584)

- Before driving, make sure the cargo is securely fastened on the roof luggage carrier.
- Loading cargo on the roof luggage carrier will make the center of gravity of the vehicle higher. Avoid high speeds, sudden starts, sharp turns, sudden braking or abrupt maneuvers, otherwise the result may be a loss of control or vehicle roll-over due to failure to operate this vehicle correctly and result in death or serious injury.
- If driving for a long distances, on rough roads, or at high speeds, stop the vehicle now and then during the trip to make sure the cargo remains in its place.
- Do not exceed 165 lb. (75 kg) cargo weight on the roof luggage carrier.

NOTICE

■ When loading cargo

Be careful not to scratch the surface of the moon roof.

2-5. Driving information

Vehicle load limits

Vehicle load limits include total load capacity, seating capacity, towing capacity and cargo capacity.

■ Total load capacity: 825 lb. (370 kg)

Total load capacity means the combined weight of occupants, cargo and luggage.

■ Seating capacity: 5 occupants (Front 2, Rear 3)

Seating capacity means the maximum number of occupants whose estimated average weight is 150 lb. (68 kg) per person.

■ Towing capacity

Without a towing package: 2000 lb. (907 kg)

With a towing package: 3500 lb. (1588 kg)

Towing capacity means the maximum gross trailer weight (trailer weight plus its cargo weight) that your vehicle is able to tow.

■ Cargo capacity

Cargo capacity may increase or decrease depending on the weight and the number of occupants.

■ Total load capacity and seating capacity

These details are also described on the tire and loading information label. (→P. 480)

CAUTION

■ Overloading the vehicle

Do not overload the vehicle.

It may not only cause damage to the tires, but also degrade steering and braking ability, resulting in an accident.

Winter driving tips

Carry out the necessary preparations and inspections before driving the vehicle in winter. Always drive the vehicle in a manner appropriate to the prevailing weather conditions.

■ Pre-winter preparations

- Use fluids that are appropriate to the prevailing outside temperatures.
 - Engine oil
 - Engine coolant
 - Washer fluid
- Have a service technician inspect the level and specific gravity of battery electrolyte.
- Have the vehicle fitted with four snow tires or purchase a set of tire chains for the front tires.

Ensure that all tires are the same size and brand, and that chains match the size of the tires.

■ Before driving the vehicle

Perform the following according to the driving conditions:

- Do not try to forcibly open a window or move a wiper that is frozen. Pour warm water over the frozen area to melt the ice. Wipe away the water immediately to prevent it from freezing.
- To ensure proper operation of the climate control system fan, remove any snow that has accumulated on the air inlet vents in front of the windshield.
- Remove any ice that has accumulated on the vehicle chassis.
- Periodically check for and remove any excess ice or snow that may have accumulated in the wheel well or on the brakes.

■ When driving the vehicle

Accelerate the vehicle slowly and drive at a reduced speed suitable to the road conditions.

■ When parking the vehicle

Park the vehicle and move the shift lever to P without setting the parking brake. The parking brake may freeze up, preventing it from being released. If necessary, block the wheels to prevent inadvertent sliding or creeping.

2

When driving

Selecting tire chains

Use the correct tire chain size when mounting the tire chains. Chain size is regulated for each tire size.

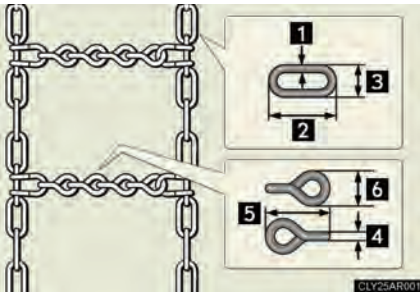

Side chain:

- 1 0.12 in. (3 mm) in diameter
- 2 0.98 in. (25 mm) in length
- 3 0.43 in. (10.8 mm) in width

Cross chain:

- 4 0.15 in. (3.9 mm) in diameter
- 5 1.00 in. (25.3 mm) in length
- 6 0.54 in. (13.8 mm) in width

Regulations on the use of tire chains

Regulations regarding the use of tire chains vary depending on location and type of road. Always check local regulations before installing chains.

■ Tire chain installation

Observe the following precautions when installing and removing chains:

- Install and remove tire chains in a safe location.
- Install tire chains on the front tires only. Do not install tire chains on the rear tires.
- Install the tire chains on front tires as tightly as possible. Retighten chains after driving 1/4 — 1/2 mile (0.5 — 1.0 km).
- Install tire chains following the instructions provided with the tire chains.

CAUTION

■ Driving with snow tires

Observe the following precautions to reduce the risk of accidents.

Failure to do so may result in a loss of vehicle control and cause death or serious injury.

- Use tires of the size specified for your vehicle.
- Maintain the recommended level of air pressure.
- Do not drive in excess of 75 mph (120 km/h), regardless of the type of snow tires being used.
- Use snow tires on all, not just some wheels.

■ Driving with tire chains

Observe the following precautions to reduce the risk of accidents.

Failure to do so may result in the vehicle being unable to be driven safely, and may cause death or serious injury.

- Do not drive in excess of the speed limit specified for the tire chains being used, or 30 mph (50 km/h), whichever is lower.
- Avoid driving on bumpy road surfaces or over potholes.
- Avoid sudden turns and braking, as use of chains may adversely affect vehicle handling.
- Slow down sufficiently before entering a curve to ensure that vehicle control is maintained.

 NOTICE**■ Repairing or replacing snow tires**

Request repairs or replacement of snow tires from Lexus dealers or legitimate tire retailers.

This is because the removal and attachment of snow tires affects the operation of the tire pressure warning valves and transmitters.

■ Fitting tire chains

The tire pressure warning valves and transmitters may not function correctly when tire chains are fitted.

2-5. Driving information

Trailer towing

Your vehicle is designed primarily as a passenger-and-load carrying vehicle. Towing a trailer will have an adverse effect on handling, performance, braking, durability, and fuel consumption. For your safety and the safety of others, do not overload the vehicle or trailer.

To tow a trailer safely, use extreme care and drive the vehicle in accordance with the trailer's characteristics and operating conditions.

The vehicle stability and braking performance are affected by trailer stability, brake setting and performance, and the hitch.

Lexus warranties do not apply to damage or malfunction caused by towing a trailer for commercial purposes.

Contact your Lexus dealer for further information about additional requirements such as a towing kit etc.

Weight limits

Confirm that the gross trailer weight, gross vehicle weight, gross axle weight and trailer tongue load are all within the limits.

- The gross trailer weight must never exceed the following:

Without towing package: 2000lb. (907kg)

With towing package: 3500lb. (1588kg)

- The gross combined weight must never exceed the following:

Without towing package

2WD: 7560lb. (3429kg)

AWD: 7650lb. (3470kg)

With towing package

2WD: 9060lb. (4109kg)

AWD: 9150lb. (4150kg)



- The gross vehicle weight must never exceed the GVWR indicated on the Certification Label.
- The gross axle weight on each axle must never exceed the GAWR indicated on the Certification Label.

Towing related term

Towing related term	Meaning
GVWR (Gross Vehicle Weight Rating)	The maximum allowable gross vehicle weight. The gross vehicle weight is the total weight of the vehicle. When towing a trailer, it is the sum of the vehicle weight (including the occupants, cargo and any optional equipment installed on the vehicle) and the tongue load.
GAWR (Gross Axle Weight Rating)	The maximum allowable gross axle weight. The gross axle weight is the load placed on each axle (front and rear).
GCWR (Gross Combination Weight Rating)	The maximum allowable gross combination weight. The gross combination weight is the sum of the total vehicle weight (including the occupants, cargo and any optional equipment installed on the vehicle) and the weight of the trailer being towed (including the cargo in the trailer).
Gross trailer weight	The sum of the trailer weight and the weight of the cargo in the trailer
Towing capacity	The maximum allowable gross trailer weight. Towing capacity is calculated considering the base vehicle with necessary vehicle equipment and occupants. Additional optional equipment, passengers and cargo in the vehicle will reduce the towing capacity, gross trailer weight include the trailer, cargo and necessary equipment for towing.
Tongue load	The load placed on the trailer hitch ball

Trailer tongue load

- A recommended tongue load varies in accordance with the types of trailers or towing as described below.
- In order to ensure the recommended values shown below, the trailer must be loaded by referring to the following instructions. The trailer cargo load should be distributed so that the tongue load is 9 to 11% of the gross trailer weight, not exceeding the following:

Without towing package: 200 lb. (90 kg)

With towing package: 350 lb. (158 kg)

(Tongue load / Gross trailer weight x 100 = 9 to 11%)

If the gross trailer weight is over 2000 lbs. (900 kg), it is necessary to use a sway control device with sufficient capacity.

The gross trailer weight and tongue load can be measured with platform scales found at a highway weighing station, building supply company, trucking company, junk yard, etc.

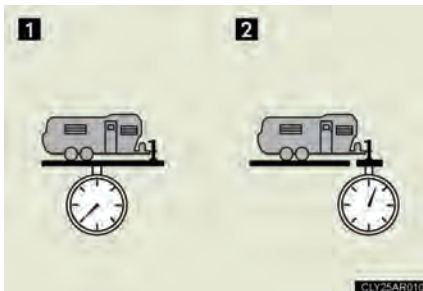

1 Gross trailer weight

2 Tongue load

Hitch and tow hitch receiver

Hitch

Trailer hitch assemblies have different weight capacities established by the hitch manufacturer. Even though the vehicle may be rated for towing a higher weight, the operator must never exceed the maximum weight rating specified for the trailer hitch.

■ Tow hitch receiver (if equipped)



A tow hitch receiver installed under the rear bumper is rated for weight that does not exceed the vehicle's total towing weight.

Selecting trailer ball

Use the correct trailer ball for your application.

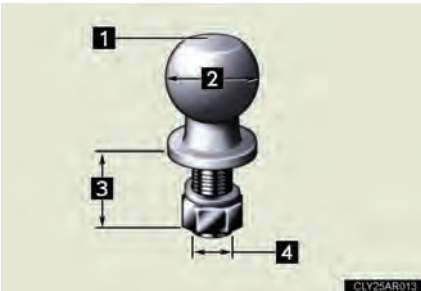

1 Trailer ball load rating

Matches or exceeds the gross trailer weight rating of the trailer.

2 Ball diameter

Matches the size of the trailer coupler. Most couplers are stamped with the required trailer ball size.

3 Shank length

Protrudes beyond the bottom of the lock washer and nut at least 2 threads.

4 Shank diameter

Matches the ball mount hole diameter size.

Connecting trailer lights

Without towing package: Please consult your dealer when installing trailer lights, as incorrect installation may cause damage to the vehicle's lights. Please take care to comply with your state's laws when installing trailer lights.

With towing package: Use the 4 pin connector located under the rear bumper.

■ Auto current cut-off function (vehicles with towing package)

In case of over current, the auto cut-off function stops the power flowing to the trailer lights to prevent damage to the vehicle's electrical system.

This function is activated when the rated current of any of the following trailer light circuit components is exceeded:

- Tail lights: maximum 7.8 A
- Stop/turn signal light (right): maximum 4.5 A
- Stop/turn signal light (left): maximum 4.5 A

■ When the auto current cut function is activated

If a trailer light does not come on due to the activation of the auto current cut function, the light system will need to be reset.

Follow the reset procedure shown below.

- If a tail light does not come on, turn off the headlight switch.
- If the right-side stop/turn signal light does not come on, put the turn signal in the off position or remove foot from the brake pedal.
- If the left-side stop/turn signal light does not come on, put the turn signal in the off position or remove foot from the brake pedal.

If the emergency flashers do not operate, press the emergency flasher switch to turn them off.

After the light system is reset, operate the light switches again to see if the lights operate normally.

If the lights do not operate normally, have the vehicle inspected by your Lexus dealer.

Trailer towing tips

Your vehicle will handle differently when towing a trailer. The 3 main causes of vehicle-trailer accidents are driver error, excessive speed and improper trailer loading. Keep the following in mind when towing:

- Before starting out, check the trailer lights and the vehicle-trailer connections. Recheck after driving a short distance.
- Practice turning, stopping and reversing with the trailer attached in an area away from traffic until you become accustomed to the feel of the vehicle.
- Reversing with a trailer attached is difficult and requires practice. Grip the bottom of the steering wheel and move your hand to the left to move the trailer to the left. Move your hand to the right to move the trailer to right. (This is generally opposite to reversing without a trailer attached.) Avoid sharp or prolonged turning. Have someone guide you when reversing to reduce the risk of an accident.
- As stopping distance is increased when towing a trailer, vehicle-to-vehicle distance should be increased. For each 10 mph (16 km/h) of speed, allow at least one vehicle and trailer length.
- Avoid sudden braking as you may skid, resulting in jackknifing and loss of control. This is especially true on wet or slippery surfaces.
- Avoid jerky starts or sudden acceleration.
- Avoid jerky steering and sharp turns, and slow down before making turns.
- Note that when making a turn, the trailer wheels will be closer than the vehicle wheels to the inside of the turn. Compensate by making a larger than normal turning radius.

- Crosswinds and rough roads will adversely affect handling of your vehicle and trailer, causing sway. Periodically check the rear to prepare for being passed by large trucks or buses, which may cause your vehicle and trailer to sway. If swaying occurs, firmly grip the steering wheel, reduce speed immediately but gradually, and steer straight ahead. Never increase speed. If you make no extreme correction with the steering or brakes, your vehicle and trailer will stabilize.
- Take care when passing other vehicles. Passing requires considerable distance. After passing a vehicle, do not forget the length of your trailer, and be sure you have plenty of room before changing lanes.
- In order to maintain engine braking efficiency when driving on a long steep downgrade, do not use overdrive. Transmission shift range position must be in 4 in S mode.
- Due to the added load of the trailer, your vehicle's engine may overheat on hot days (at temperatures over 85°F [30°C]) when driving up a long or steep grade. If the engine coolant temperature gauge indicates overheating, immediately turn off the air conditioning (if in use), pull your vehicle off the road and stop in a safe spot. (→P. 578)
- Always place wheel blocks under both the vehicle and the trailer wheels when parking. Apply the parking brake firmly, and put the transmission in P. Avoid parking on a slope, but if unavoidable, do so only after performing the following:
 - STEP 1** Apply the brakes and keep them applied.
 - STEP 2** Have someone place wheel blocks under both the vehicle and trailer wheels.
 - STEP 3** When the wheel blocks are in place, release the brakes slowly until the blocks absorb the load.
 - STEP 4** Apply the parking brake firmly.
 - STEP 5** Shift into P and turn off the engine.

- When restarting after parking on a slope:

STEP 1 With the transmission in the P position, start the engine. Be sure to keep the brake pedal depressed.

STEP 2 Shift into 3, 2, 1, or the R position (if reversing).

STEP 3 Release the parking brake and brake pedal, and slowly pull or back away from the wheel blocks. Stop and apply the brakes.

STEP 4 Have someone retrieve the blocks.

- **When connecting and disconnecting a trailer (vehicles with electrically modulated air suspension)**

- Connecting

STEP 1 Set the electronically modulated air suspension to LO mode.

STEP 2 Press the height control off button to turn off the electronically modulated air suspension.

STEP 3 Turn off the “ENGINE START STOP” switch.

STEP 4 Connect the trailer.

STEP 5 Turn on the “ENGINE START STOP” switch.

STEP 6 Press the height control off button again to turn on the electronically modulated air suspension.

STEP 7 Set the electronically modulated air suspension to N mode.

- Disconnecting

STEP 1 Set the electronically modulated air suspension to LO mode.

STEP 2 Press the height control off button to turn off the electronically modulated air suspension.

STEP 3 Turn off the “ENGINE START STOP” switch.

STEP 4 Set the supporting leg of the trailer on the ground and raise the hitch by 4 in. (100 mm)

STEP 5 Turn on the “ENGINE START STOP” switch.

STEP 6 Press the height control off button again to turn on the electronically modulated air suspension.

STEP 7 Wait until vehicle height is stabilized.

Make sure the hitch is disconnected. If the hitch does not disconnect, raise the hitch higher and repeat steps 2 through 7.

■ Before towing

Check that the following conditions are met:

- The vehicle's tires are properly inflated. (→P. 480)
- Trailer tires are inflated according to the trailer manufacturer's recommendation.
- All trailer lights work.
- All lights work each time you connect them.
- The vehicle remains level when a loaded or unloaded trailer is hitched. Do not drive if the vehicle is not level, and check for improper tongue load, overloading, worn suspension, or other possible causes.
- The trailer cargo is securely loaded.
- The rear view mirrors conform to all applicable federal, state/provincial or local regulations. If they do not, install rear view mirrors appropriate for towing purposes.

■ Break-in schedule

If your vehicle is new or equipped with any new power train components (such as an engine, transmission, differential and wheel bearing), Lexus recommends that you do not tow a trailer until it has been driven for over 500 miles (800 km). However, avoid full throttle acceleration.

■ Maintenance

- If you tow a trailer, your vehicle will require more frequent maintenance due to the additional load. (See "Warranty and Services Guide", "Owner's Manual Supplement" or "Scheduled Maintenance".)
- Retighten the fixing bolts of the towing ball and bracket after approximately 600 miles (1000 km) of trailer towing.

CAUTION

■ Trailer towing precautions

- Follow all the instructions described in this section. Failure to do so could cause an accident resulting in death or serious injury.
- Exceeding the towing capacity, GVWR or GAWR can cause an accident resulting in death or serious personal injuries.

■ To avoid accident or injury

- Do not exceed the trailer hitch assembly weight, gross vehicle weight, gross axle weight and trailer tongue load capacities.
- Never load more weight in the back than in the front of the trailer. About 60% of the load should be in the front half of the trailer, and the remaining 40% in the rear.
- Vehicles with an electronically modulated air suspension, set the vehicle height to LO mode and turn off the electronically modulated air suspension to prevent the vehicle height from automatically changing.
- The tow hitch receiver installed on your vehicle must never be used on another vehicle.
- Do not exceed 45 mph (72 km/h) or the posted towing speed limit, whichever is lower. As instability (swaying) of the towing vehicle-trailer combination increases as speed increases, exceeding 45 mph (72 km/h) may cause loss of control.
- Slow down and downshift before descending steep or long downhill grades. Do not make sudden downshifts.
- Avoid holding the brake pedal down too long or applying the brakes too frequently. This could cause the brakes to overheat and result in reduced braking efficiency.
- Do not tow the vehicle with the compact spare tire installed.

 **CAUTION****■ Hitches**

- If you wish to install a trailer hitch, contact your Lexus dealer.
- Use only a hitch that conforms to the gross trailer weight requirement.
- Follow the directions supplied by the hitch manufacturer.
- Lubricate the hitch ball with a light coat of grease.
- Remove the trailer hitch whenever you are not towing a trailer. After removing the hitch, seal any mounting hole in the vehicle body to prevent entry of any substances into the vehicle.

■ When towing a trailer

- If the gross trailer weight exceeds 1000 lb. (450 kg), trailer brakes are required. Lexus recommends trailers with brakes that conform to all applicable federal and state/provincial regulations.
- Never tap into your vehicle's hydraulic system, as this will lower the vehicle's braking effectiveness.
- Never tow a trailer without using a safety chain securely attached to both the trailer and the vehicle. If damage occurs to the coupling unit or hitch ball, there is danger of the trailer wandering into another lane.

NOTICE

■ **When installing a trailer hitch**

- Use only the position recommended by your Lexus dealer. Do not install the trailer hitch on the bumper; this may cause body damage.
- Do not use axle-mounted hitches, as they can cause damage to the axle housing, wheel bearings, wheels or tires.

■ **Safety chain**

A safety chain must always be used between the towing vehicle and the trailer. Leave sufficient slack in the chain for turns. The chain should cross under the trailer tongue to prevent the tongue from dropping to the ground in the case that it becomes damaged or separated. For the correct safety chain installation procedure, ask your Lexus dealer.

■ **Do not directly splice trailer lights**

Directly splicing trailer lights may damage your vehicle's electrical system and cause a malfunction.

Dinghy towing

Your vehicle is not designed to be dinghy towed (with 4 wheels on the ground) behind a motor home.



 NOTICE

■ To avoid serious damage to your vehicle

Do not tow your vehicle with four wheels on the ground.

3-1. Using the air conditioning system and defogger

Automatic air conditioning system	272
Rear window defogger switch	279
Windshield wiper de-icer	280

3-2. Using the audio system

Audio system	281
Using the radio	285
Using the CD player	295
Playing MP3 and WMA discs	305
Operating an iPod® player	315
Operating a USB memory player	323
Optimal use of the audio system	332
Using the AUX adapter	335
Using the steering wheel audio switches	337

3-3. Using the Bluetooth[®] audio system

Bluetooth [®] audio system ...	340
Using the Bluetooth [®] audio system	343
Operating a Bluetooth [®] enabled portable player ...	348
Setting up a Bluetooth [®] enabled portable player ...	352
Bluetooth [®] audio system setup	359

3-4. Using the hands-free phone system (for mobile phones)

Hands-free system for mobile phones	360
Using the hands-free system (for mobile phones)	364
Making a phone call	372
Setting a mobile phone	377
Security and system setup	383
Using the phone book	387

3-5. Using the interior lights

Interior lights list	394
• Interior lights	395
• Personal lights	395

3-6. Using the storage features

List of storage features	397
• Glove box	398
• Bottle holders/door pockets	399
• Cup holders	400
• Console box	402
• Auxiliary boxes	404
• Under tray	405

3-7. Other interior features

Sun visors	406
Vanity mirrors	407
Clock	408
Outside temperature display (vehicles without a navigation system)	409
Multi-display light control (vehicles without a navigation system)	410
Power outlets	411
Seat heaters and ventilators	414
Armrest	416
Coat hooks	417
Floor mat	418
Luggage compartment features	419
Garage door opener	424
Compass	430

3-1. Using the air conditioning system and defogger

Automatic air conditioning system

Air outlets and fan speed are automatically adjusted according to the temperature setting.

▶ Vehicles with a navigation system

Owners of models equipped with a navigation system should refer to the "Navigation System Owner's Manual".

▶ Vehicles without a navigation system





Using automatic air conditioning system

STEP 1 Press .

The air conditioning system begins to operate. Air outlets and fan speed are automatically adjusted according to the temperature setting.

STEP 2 Press “^” on  to increase the temperature and “v” to decrease the temperature.

When  is pressed (the indicator on  is on) or the passenger's side temperature control button is pressed, the temperature for the driver and passenger seats can be adjusted separately.

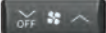

Adjusting the settings manually

Basic setting

STEP 1 To turn on the air conditioning system and adjust the fan speed, press “^” on  to increase the fan speed and “OFF v” to decrease the fan speed.

To turn the fan off, press and hold “OFF v” on .

STEP 2 To adjust the temperature setting, press “^” on  to increase the temperature and “v” to decrease the temperature.

When  is pressed (the indicator on  is on) or the passenger's side temperature control button is pressed, the temperature for the driver and passenger seats can be adjusted separately.

STEP 3 To change the air outlets, press .

The air outlets used are switched each time the button is pressed. The air flow shown on the display indicates the following:

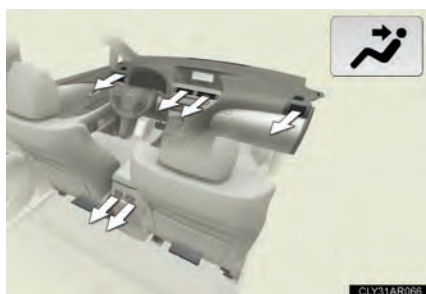

Air flows to the upper body.

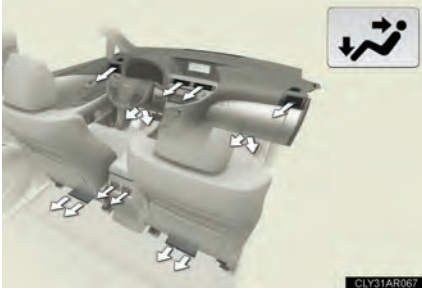

Air flows to the upper body and feet.

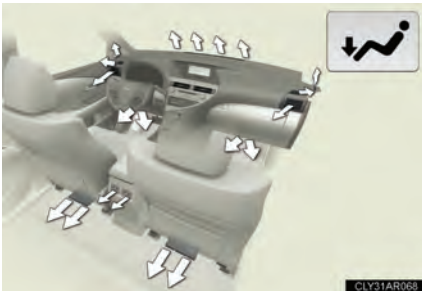

Air flows to the feet.



Air flows to the feet and the windshield defogger operates.

■ Switching between outside air and recirculated air modes

Press .

The mode switches between outside air mode (the indicator is off) and recirculated air mode (the indicator is on) each time the button is pressed.

Defogging the windshield

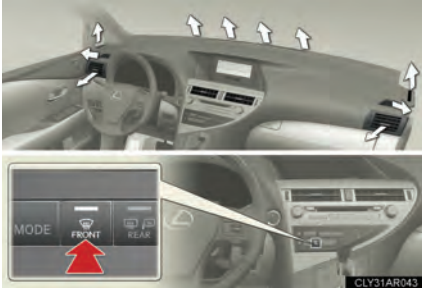

Defogging

The air conditioning system operates automatically.

Recirculated air mode will automatically switch to outside air mode. It is not possible to return to recirculated air mode when the switch is on.

Adjusting the position of and opening and closing the air outlets

► Front center outlets

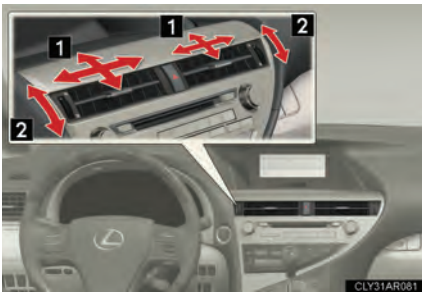

- 1 Direct air flow to the left or right, up or down.
- 2 Turn the knob to open or close the vent.

► Front side outlets



- 1 Direct air flow to the left or right, up or down.
- 2 Turn the knob to open or close the vent.

► Rear outlets

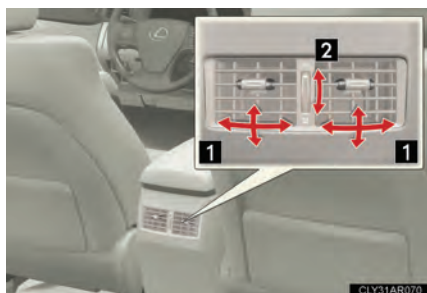

- 1 Direct air flow to the left or right, up or down.
- 2 Turn the knob to open or close the vent.

■ Air conditioning system settings

When the “ENGINE START STOP” switch is turned on, the air conditioning system settings will be set to those that were in use the last time the “ENGINE START STOP” switch was turned off.

Air conditioning system settings are memorized individually on each electronic key, so the settings reproduced will be specific to the key that is used.

■ Using automatic mode

Fan speed is adjusted automatically according to the temperature setting and ambient conditions. As a result, the following may occur:

- The system may switch automatically to recirculated air mode when the coolest temperature setting is selected in summer.
- Immediately after the button is pressed, the fan may stop for a while until warm or cool air is ready to flow.

■ Using the system in recirculated air mode

The windows will fog up more easily if recirculated air mode is used for an extended period.

■ Window defogger feature

Recirculated air mode may automatically switch to outside air mode in situations where the windows need to be defogged.

■ When outside air temperature is below 32°F (0°C)

The cooling and dehumidification function may not operate even when  is pressed.

■ When the indicator light on flashes

Press  to turn off the cooling and dehumidification function and turn it on again. There may be a problem in the air conditioning system if the indicator light continues to flash. Turn the air conditioning system off and have it inspected by your Lexus dealer.

CAUTION

■ To prevent the windshield from fogging up

Do not use  during cool air operation in extremely humid weather. The difference between the temperature of the outside air and that of the windshield can cause the outer surface of the windshield to fog up, blocking your vision.

NOTICE

■ To prevent battery discharge

Do not leave the air conditioning system on longer than necessary when the engine is stopped.

3-1. Using the air conditioning system and defogger

Rear window defogger switch

Defoggers are used to defog the rear window, and to remove raindrops, dew and frost from the outside rear view mirrors.



Turns the rear window and outside rear view mirror defoggers on/off

The defoggers will automatically turn off after 15 to 60 minutes. The operation time changes according to the ambient temperature and vehicle speed.

■ The defoggers can be operated when

The "ENGINE START STOP" switch is in IGNITION ON mode.

■ The outside rear view mirror defoggers

Turning the rear window defogger on will turn the outside rear view mirror defoggers on.

⚠ CAUTION

■ When the outside rear view mirror defoggers are on

Do not touch the outside surface of the rear view mirrors, as they can become very hot and burn you.

3-1. Using the air conditioning system and defogger

Windshield wiper de-icer*

This feature is used to prevent ice from building up on the windshield and wiper blades.



Turns the windshield wiper de-icer on/off

The windshield wiper de-icer will automatically turn off after approximately 15 minutes.

■ The windshield wiper de-icer can be operated when

The "ENGINE START STOP" switch is in IGNITION ON mode.

⚠ CAUTION

■ When the windshield wiper de-icer is on

Do not touch the lower part of the windshield or the side of the front pillars, as the surfaces can become very hot and burn you.

*: If equipped

3-2. Using the audio system

Audio system

▶ Vehicles with a navigation system

Owners of models equipped with a navigation system should refer to the “Navigation System Owner’s Manual”.

▶ Vehicles without a navigation system

CD player with a changer and AM/FM radio

▶ Type A



► Type B



CLY32AR083

► Type C



Title	Page
Using the radio	P. 285
Using the CD player	P. 295
Playing MP3 and WMA discs	P. 305
Operating an iPod® player	P. 315
Operating a USB memory player	P. 323
Optimal use of the audio system	P. 332
Using the AUX adapter	P. 335
Using the steering wheel audio switches	P. 337

■ Using mobile phones

Interference may be heard through the audio system's speakers if a mobile phone is being used inside or close to the vehicle while the audio system is operating.

CAUTION

■ Certification

● Part 15 of the FCC Rules

FCC Warning:

Any unauthorized changes or modifications to this equipment will void the user's authority to operate this device.

● Laser products

- Do not take this unit apart or attempt to make any changes by yourself.

This is an intricate unit that uses a laser pickup to retrieve information from the surface of compact discs. The laser is carefully shielded so that its rays remain inside the cabinet. Therefore, never try to disassemble the player or alter any of its parts since you may be exposed to laser rays and dangerous voltages.

- This product utilizes a laser.

Use of controls or adjustments or performance of procedures other than those specified herein may result in hazardous radiation exposure.

NOTICE

■ To prevent battery discharge

Do not leave the audio system on longer than necessary with the engine off.

■ To avoid damaging the audio system

Take care not to spill drinks or other fluids over the audio system.

3-2. Using the audio system

Using the radio

► Type A

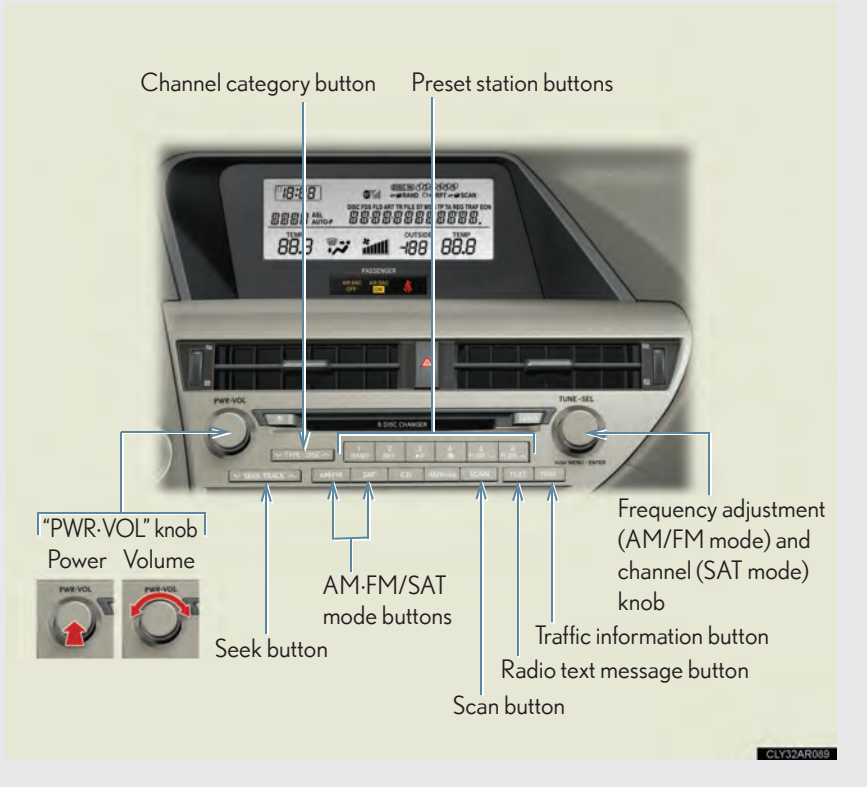

► Type B

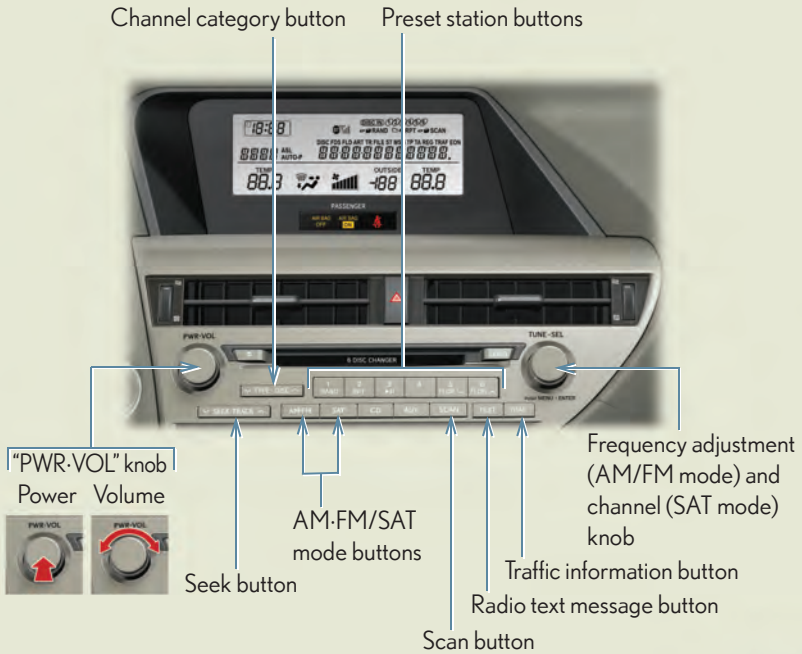



CLY32AR090

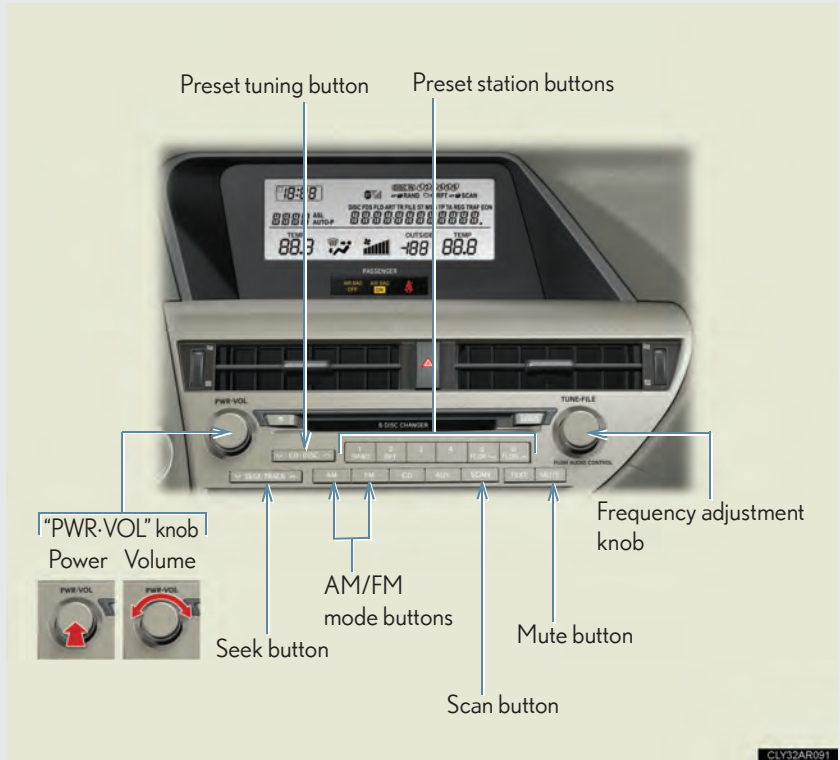

► Type C



CLY32AR031

Setting station presets (excluding XM® Satellite Radio)

STEP 1 Search for the desired stations by turning  or  or pressing “^” or “v” on .

STEP 2 Press and hold the button (from  to ) the station is to be set to until you hear a beep.

Scanning radio stations (excluding XM® Satellite Radio)

■ Scanning the preset radio stations

STEP 1 Press and hold  until you hear a beep.
Preset stations will be played for 5 seconds each.

STEP 2 When the desired station is reached, press the button again.

■ Scanning all the radio stations within range

STEP 1 Press .

All the stations with reception will be played for 5 seconds each.

STEP 2 When the desired station is reached, press the button again.

RDS (Radio Data System) (type A and B)

This feature allows your radio to receive station identification information and program information (classical, jazz, etc.) from radio stations which broadcast this information.



■ Receiving RDS broadcasts

STEP 1 Press “^” or “v” on  during FM reception.

The type of program changes each time the button is pressed.

- “ROCK”
- “EASYLIS” (Easy listening)
- “CLS/JAZZ” (Classical music and Jazz)
- “R & B” (Rhythm and Blues)
- “INFORM” (Information)
- “RELIGION”
- “MISC” (Miscellaneous)
- “ALERT” (Emergency messages)

If the system receives no RDS stations, “NO PTY” appears on the display.

STEP 2 Press , or “^” or “v” on .

The radio seeks or scans for stations of the relevant program type.



■ Displaying radio station names

Press .

■ Displaying radio text messages

Press  twice.

A text message is displayed when “MSG” is shown on the screen.



If the text continues past the end of the display,  is displayed. Press and hold  until you hear a beep.

XM[®] Satellite Radio (type A and B)



■ Receiving XM[®] Satellite Radio

STEP 1 Press .

The display changes as follows each time the button is pressed:
“SAT1” → “SAT2” → “SAT3”

STEP 2 Turn  to select the desired channel in all the categories or press “^” or “v” on  to select the desired channel in the current category.

■ Setting XM[®] Satellite Radio channel presets

Select the desired channel. Press and hold the button (from  to ) the channel is to be set to until you hear a beep.

■ Changing the channel category

Press “^” or “v” on .

■ Scanning the XM[®] Satellite Radio channels

- Scanning the channels in the current category

STEP 1 Press **SCAN** .

STEP 2 When the desired channel is reached, press the button again.

- Scanning the preset channels

STEP 1 Press and hold **SCAN** until you hear a beep.

STEP 2 When the desired channel is reached, press the button again.

■ Displaying text information

Press **TEXT** .

The display will show up to 10 characters.

The display changes as follows each time the button is pressed:

- CH NAME
- TITLE (SONG/PROGRAM TITLE)
- NAME (ARTIST NAME/FEATURE)
- CH NUMBER

■ When the battery is disconnected

All preset stations are erased.

■ Reception sensitivity

- Cargo loaded on the roof luggage carrier, especially metal objects, may adversely affect the reception of XM[®] Satellite Radio.
- It is difficult to maintain perfect radio reception at all times due to the continually changing position of the antenna, differences in signal strength and surrounding objects, such as trains and transmitters.
- The radio antenna is mounted inside the rear spoiler and the rear window. To maintain clear radio reception, do not attach metallic window tinting or other metallic objects to the antenna wire mounted inside the rear window.

■ Receiving XM[®] Satellite Radio

An XM[®] Satellite Radio is a tuner designed exclusively to receive broadcasts provided under a separate subscription. Availability is limited to the 48 contiguous states and 10 Canadian provinces.

● XM[®] subscriptions

For detailed information about XM[®] Satellite Radio or to subscribe:
U.S.A.—

Visit on the web at www.xmradio.com or call 1-877-515-3987.

Canada—

Visit on the web at www.xmradio.ca or call 1-877-515-3987.

● Radio ID

You will need the radio ID when activating XM[®] service or reporting a problem.

Select "CH000" using , and the receiver's 8-character ID number will appear.

● Satellite tuner

The tuner supports only Audio Services (Music and Talk) and the accompanying Text Information of XM[®] Satellite Radio.

■ **If the satellite radio does not operate normally**

If a problem occurs with the XM[®] tuner, a message will appear on the display. Refer to the table below to identify the problem, and take the suggested corrective action.

ANTENNA	The XM [®] antenna is not connected. Check whether the XM [®] antenna cable is attached securely.
	There is a short-circuit in the antenna or the surrounding antenna cable. See a Lexus certified dealer.
UNAUTH	You have not subscribed to the XM [®] Satellite Radio. The radio is being updated with the latest encryption code. Contact the XM [®] Satellite Radio for subscription information. When a contract is canceled, you can choose the "CH000" and all the free-to-air channels.
	The premium channel you selected is not authorized. Wait for about 2 seconds until the radio returns to the previous channel or "CH001". If it does not change automatically, select another channel. If you want to listen to the premium channel, contact the XM [®] Satellite Radio.
NO SIGNAL	The XM [®] signal is too weak at the current location. Wait until your vehicle reaches a location with a stronger signal.
LOADING	The unit is acquiring audio or program information. Wait until the unit has received the information.
OFF AIR	The channel you selected is not broadcasting any programming. Select another channel.

-----	There is no song/program title or artist name/feature associated with the channel at that time. No action needed.
CH UNAVL	The channel you selected is no longer available. Wait for about 2 seconds until the radio returns to the previous channel or "CH001". If it does not change automatically, select another channel.

Contact the XM[®] Listener Care Center at 1-877-515-3987.

■ Certifications for the radio tuner

This equipment has been tested and found to comply with the limits for a class B digital device, pursuant to Part 15 of the FCC Rules. These limits are designed to provide reasonable protection against harmful interference in a residential installation. This equipment generates, uses and can radiate radio frequency energy and, if not installed and used in accordance with the instructions, may cause harmful interference to radio communications. However, there is no guarantee that interference will not occur in a particular installation.

If this equipment does cause harmful interference to radio or television reception, which can be determined by turning the equipment off and on, the user is encouraged to try to correct the interference by trying one or more of the following:

- Reorienting or relocate the receiving antenna.
- Increasing the separation between the equipment and receiver.
- Connecting the equipment into an outlet on a circuit different from that to which the receiver is connected.
- Consulting the dealer or an experienced radio/TV technician for help.

3-2. Using the audio system Using the CD player

▶ Type A

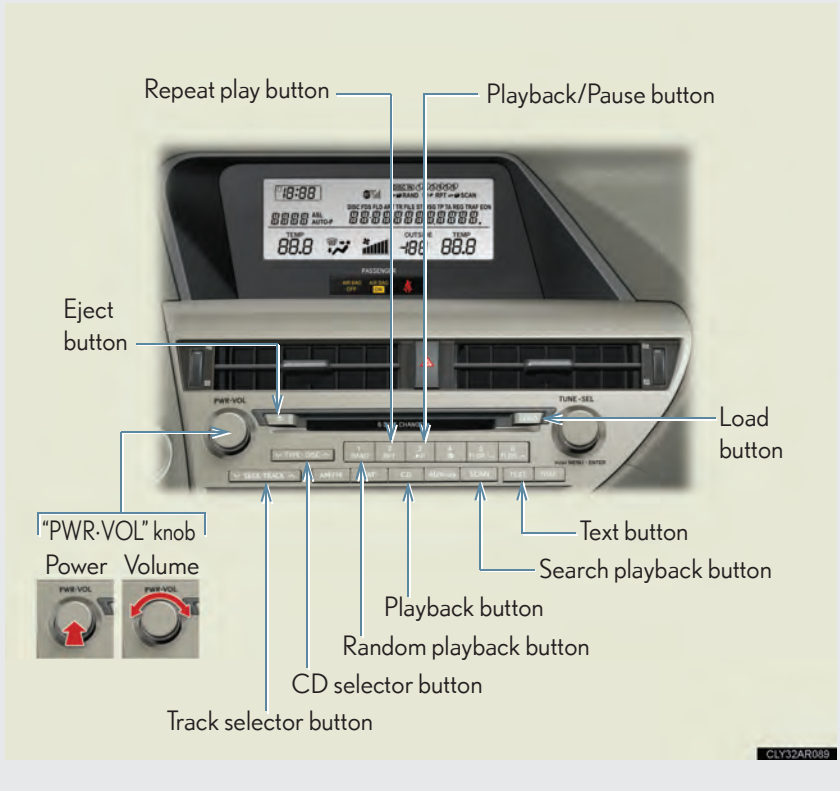

► Type B

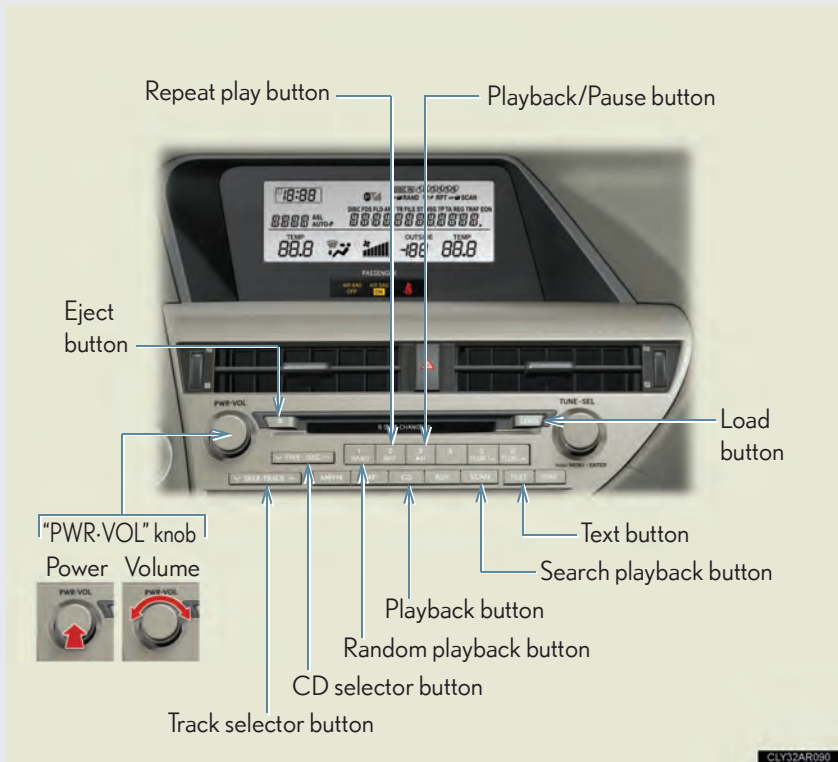

▶ Type C

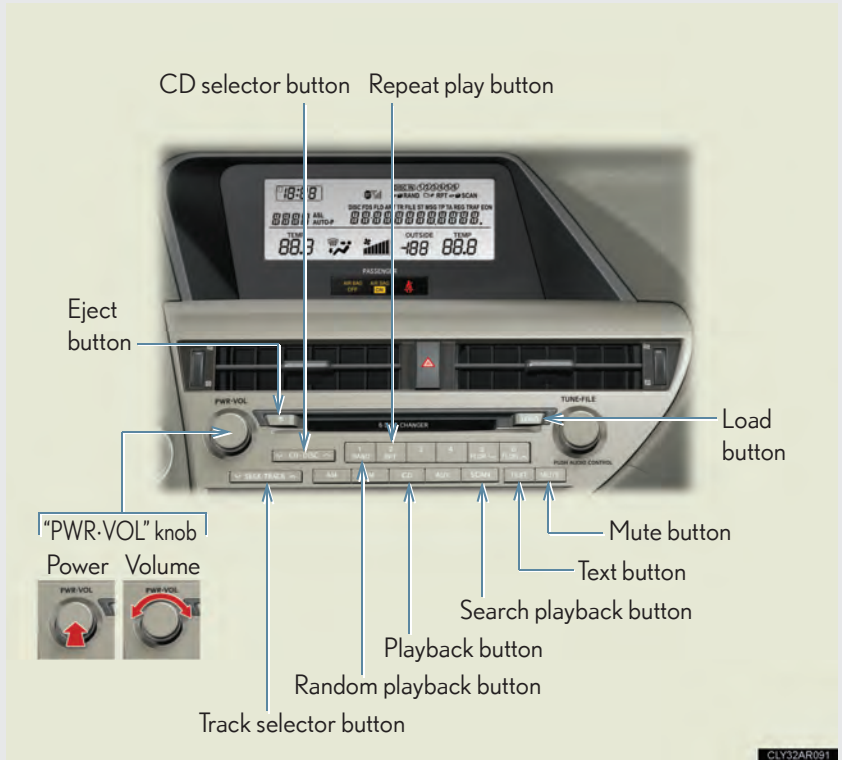

Loading a CD

■ Loading a CD

STEP 1 Press .

"WAIT" is shown on the display.

STEP 2 When the indicator on the slot turns from amber to green, insert a CD.

The display changes from "WAIT" to "LOAD".

■ Loading multiple CDs

STEP 1 Press and hold  until you hear a beep.

"WAIT" is shown on the display.

STEP 2 When the indicator on the slot turns from amber to green, insert a CD.

The display changes from "WAIT" to "LOAD".

The indicator on the slot turns to amber when the CD is being inserted.

STEP 3 When the indicator on the slot turns from amber to green, insert the next CD.

Repeat the procedure for the remaining CDs.

To cancel the operation, press . If you do not insert a disc within 15 seconds, loading will be canceled automatically.

Ejecting CDs

Ejecting a CD



To select the CD to be ejected, press “^” or “v” on **TYPE: DISC** or **CH: DISC**.

The selected disc number is shown on the display.

STEP 2 Press  and remove the CD.

Ejecting all the CDs

Press and hold  until you hear a beep, and then remove the CDs.

Selecting, fast-forwarding, reversing and scanning tracks

Selecting a track

Press “^” to move up or “v” to move down using **SEEK TRACK** until the desired track number is displayed.

Fast-forwarding and reversing tracks

To fast-forward or reverse, press and hold “^” or “v” on **SEEK TRACK** until you hear a beep.

Scanning tracks

STEP 1 Press **SCAN**.

The first ten seconds of each track will be played.

To cancel, press **SCAN** again.

STEP 2 Press the button again when the desired track is reached.

Selecting a CD

■ Selecting a CD to play

To select the desired CD, press “^” or “v” on  or .

■ Scanning loaded CDs

STEP 1 Press and hold  until you hear a beep.

The first ten seconds of the first track on each CD will be played.

To cancel, press  again.

STEP 2 Press the button again when the desired CD is reached.

Playing and pausing tracks (type A and B)

To play or pause a track, press .

Random playback

■ Current CD

Press .

Songs are played in random order.

To cancel, press  again.

■ All CDs

Press and hold  until you hear a beep.

Tracks on all loaded CDs are played in random order.

To cancel, press  again.

Repeat play

■ Repeating a track

Press .

To cancel, press  again.

■ Repeating all of the tracks on a CD

Press and hold  until you hear a beep.

To cancel, press  again.

Switching the display

Press .

Each time the button is pressed, the display changes in the following order:
Elapsed time → CD title → Track title

■ CD player protection feature

To protect the internal components, playback is automatically stopped when a problem is detected.

■ Display

Up to 12 characters can be displayed at a time.

If there are 13 or more characters, pressing and holding  for 1 second or more enables to display the remaining characters.

A maximum of 24 characters can be displayed.

If  is pressed for more than 1 second again or has not been operated for more than 6 seconds, the display will return to the first 12 characters.

Depending on the contents recorded, the characters may not be displayed properly or may not be displayed at all.

■ When “ERROR” or “WAIT” is shown on the display

“ERROR”: This indicates a trouble either in the CD or inside the player. The CD may be dirty, damaged, or inserted up-side down.

“WAIT”: This indicates that operation is stopped due to a high temperature inside the player. Wait for a while and then press . If the CD still cannot be played back, contact your Lexus dealer.

■ Discs that can be used

Discs with the marks shown below can be used.

Playback may not be possible depending on recording format or disc features, or due to scratches, dirt or deterioration.



CDs with copy-protection features may not be used.

■ Lens cleaners

Do not use lens cleaners. Doing so may damage the CD player.

■ If discs are left inside the CD player or in the ejected position for extended periods of time

The discs may be damaged and may not play properly.

 NOTICE

■ CDs and adapters that cannot be used

Do not use the following types of CDs, 3 in. (8 cm) CD adapters or Dual Discs. Doing so may damage the CD player and/or the CD load/eject function.



- CDs that have a diameter that is not 4.7 in. (12 cm)

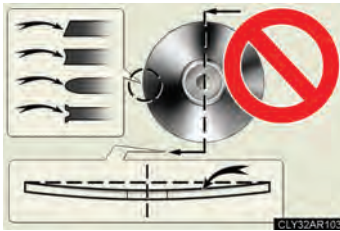

- Low-quality and deformed CDs



- CDs with a transparent or translucent recording area



- CDs that have had tape, stickers or CD-R labels attached to them, or that have had the label peeled off

NOTICE

■ CD player precautions

Failure to follow the precautions below may result in serious damage to the CDs or the player itself.

- Do not insert anything other than CDs into the CD slot.
- Do not apply oil to the CD player.
- Store CDs away from direct sunlight.
- Never try to disassemble any part of the CD player.



- Do not insert more than one CD at a time.

3-2. Using the audio system

Playing MP3 and WMA discs

▶ Type A

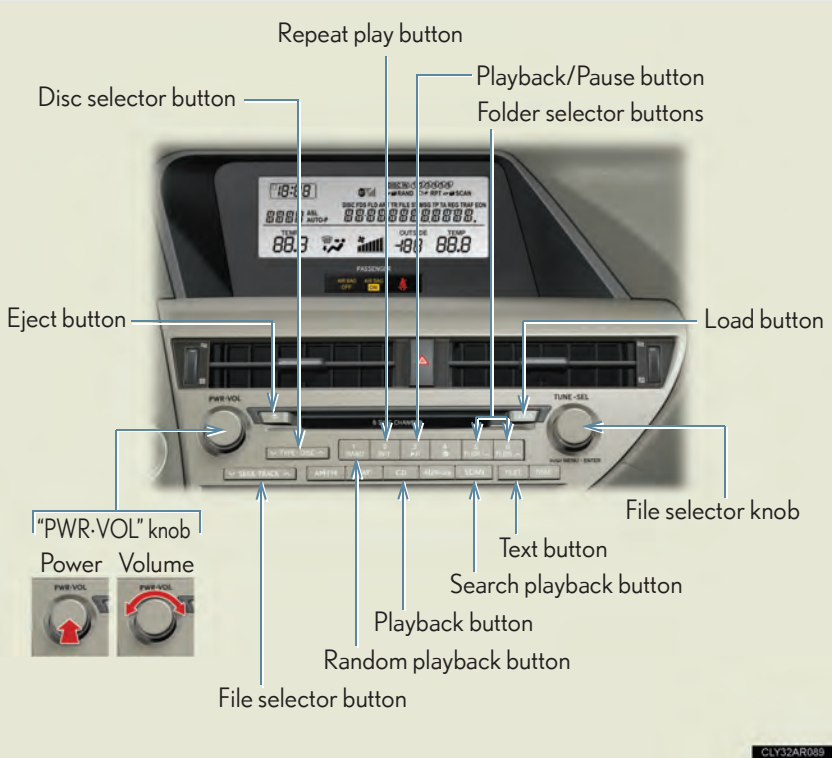

► Type B

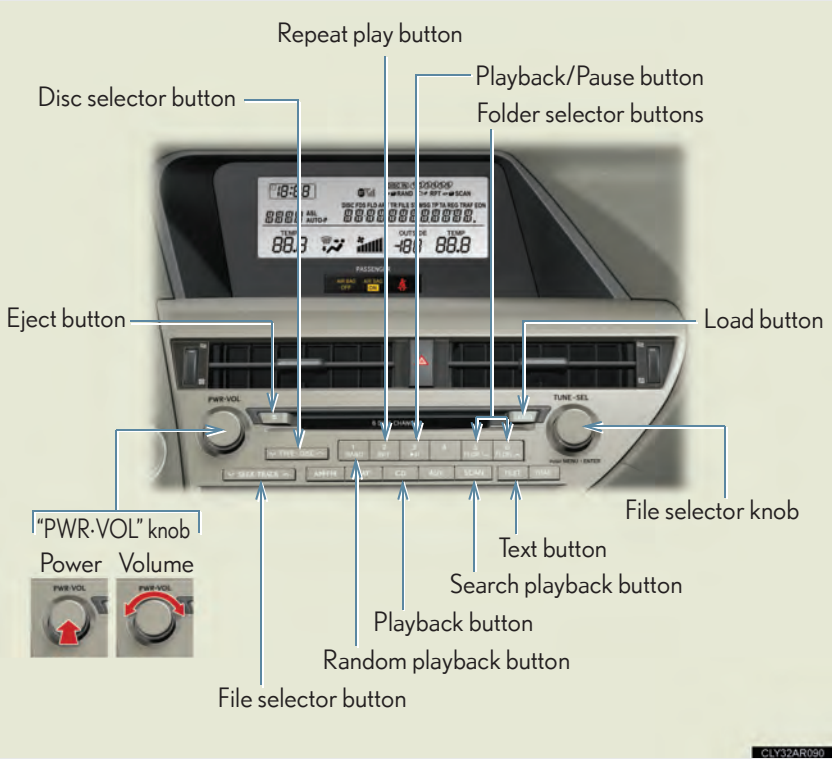

► Type C

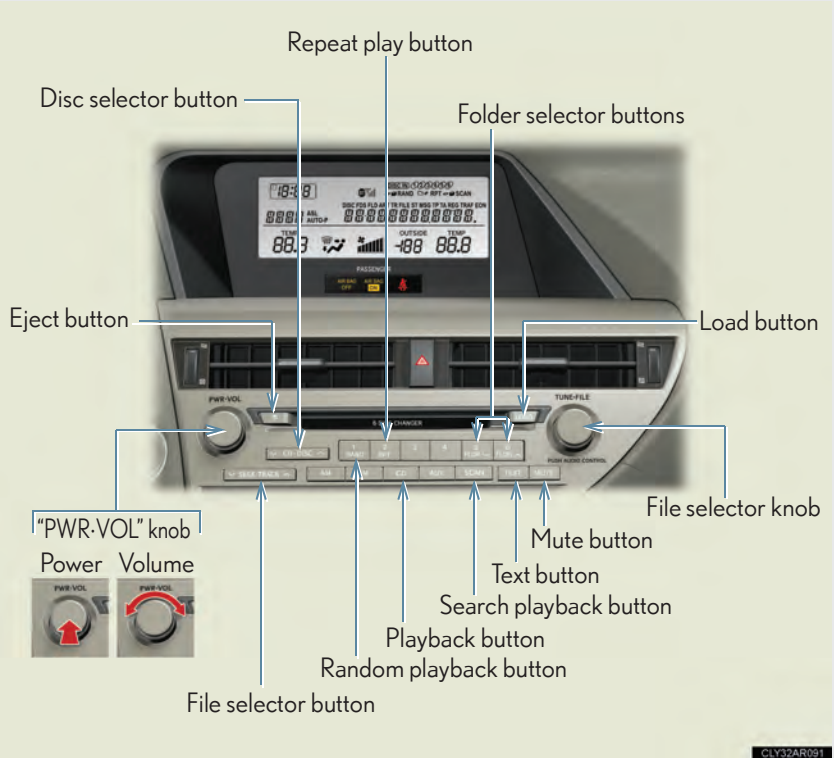

Loading and ejecting MP3 and WMA discs



→P. 298, 299

Selecting MP3 and WMA discs

→P. 300

Selecting and scanning a folder

■ Selecting a folder one at a time

Press  or  to select the desired folder.

■ Returning to the first folder

Press and hold  until you hear a beep.

■ Scanning the first file of all the folders

STEP 1 Press and hold  until you hear a beep.

The first ten seconds of the first file in each folder will be played.



STEP 2 When the desired folder is reached, press  again.

Fast-forwarding and reversing files

To fast-forward or reverse, press and hold “^” or “v” on  until you hear a beep.

Selecting and scanning files

■ Selecting a file

Turn  or  or press “^” or “v” on  to select the desired file.

■ Scanning the files in a folder

Press .

The first ten seconds of each file will be played.

To cancel, press  again.

When the desired file is reached, press  again.

Playing and pausing files (type A and B)

To play or pause a file, press .

Random playback

■ Playing files from a folder in random order

Press .

To cancel, press  again.

■ Playing all the files from a disc in random order

Press and hold  until you hear a beep.

To cancel, press  again.

Repeat play

■ Repeating a file

Press  .

To cancel, press  again.

■ Repeating all the files in a folder

Press and hold  until you hear a beep.

To cancel, press  again.

Switching the display

Press  .

Each time the button is pressed, the display changes in the following order:
Folder no./File no./Elapsed time → Folder name → File name → Album title
(MP3 only) → Track title → Artist name

- **CD player protection feature**

→P. 301

- **Display**

→P. 301

- **When “ERROR”, “WAIT” or “NO MUSIC” is shown on the display**

“ERROR”: This indicates a problem either in the CD or inside the player. The CD may be dirty, damaged, or inserted up-side down.

“WAIT”: This indicates that operation is stopped due to a high temperatures inside the player. Wait for a while and then press . If the CD still cannot be played back, contact your Lexus dealer.

“NO MUSIC”: This indicates that an MP3/WMA file is not included in the CD.

- **Discs that can be used**

→P. 302

- **Lens cleaners**

→P. 302

- **If discs are left inside the CD player or in the ejected position for extended periods of time**

→P. 302

■ MP3 and WMA files

MP3 (MPEG Audio LAYER 3) is a standard audio compression format.

Files can be compressed to approximately 1/10 of their original size by using MP3 compression.

WMA (Windows Media™ Audio) is a Microsoft audio compression format.

This format compresses audio data to a size smaller than that of the MP3 format.

There is a limit to the MP3 and WMA file standards that can be used and to the media/formats on which the files are recorded.

● MP3 file compatibility

- Compatible standards
MP3 (MPEG1 LAYER3, MPEG2 LSF LAYER3)
- Compatible sampling frequencies
MPEG1 LAYER3: 32, 44.1, 48 (kHz)
MPEG2 LSF LAYER3: 16, 22.05, 24 (kHz)
- Compatible bit rates (compatible with VBR)
MPEG1 LAYER3: 64, 80, 96, 112, 128, 160, 192, 224, 256, 320 (kbps)
MPEG2 LSF LAYER3: 64, 80, 96, 112, 128, 144, 160 (kbps)
- Compatible channel modes: stereo, joint stereo, dual channel and monaural

● WMA file compatibility

- Compatible standards
WMA Ver. 7, 8, 9
- Compatible sampling frequencies
32, 44.1, 48 (kHz)
- Compatible bit rates (only compatible with 2-channel playback)
Ver. 7, 8: CBR 48, 64, 80, 96, 128, 160, 192 (kbps)
Ver. 9: CBR 48, 64, 80, 96, 128, 160, 192, 256, 320 (kbps)

● Compatible media

Media that can be used for MP3 and WMA playback are CD-Rs and CD-RWs.

Playback in some instances may not be possible if the CD-R or CD-RW is not finalized. Playback may not be possible or the audio may jump if the disc is scratched or marked with fingerprints.

- Compatible disc formats

The following disc formats can be used:

- Disc formats: CD-ROM Mode 1 and Mode 2
CD-ROM XA Mode 2, Form 1 and Form 2
- File formats: ISO9660 Level 1, Level 2, (Romeo, Joliet)
MP3 and WMA files written in any format other than those listed above may not play correctly, and their file names and folder names may not be displayed correctly.

Items related to standards and limitations are as follows:

- Maximum directory hierarchy: 8 levels (including the root)
- Maximum length of folder names/file names: 32 characters
- Maximum number of folders: 192 (including the root)
- Maximum number of files per disc: 255

- File names

The only files that can be recognized as MP3/WMA and played are those with the extension .mp3 or .wma.

- Discs containing multi-session recordings

As the audio system is compatible with multi-sessions, it is possible to play discs that contain MP3 and WMA files. However, only the first session can be played.

- ID3 and WMA tags

ID3 tags can be added to MP3 files, making it possible to record the track title, artist name, etc.

The system is compatible with ID3 Ver. 1.0, 1.1, and Ver. 2.2, 2.3 ID3 tags. (The number of characters is based on ID3 Ver. 1.0 and 1.1.)

WMA tags can be added to WMA files, making it possible to record the track title and artist name in the same way as with ID3 tags.

● MP3 and WMA playback

When a disc containing MP3 or WMA files is inserted, all files on the disc are first checked. Once the file check is finished, the first MP3 or WMA file is played. To make the file check finish more quickly, we recommend you do not write in any files other than MP3 or WMA files or create any unnecessary folders.

Discs that contain a mixture of music data and MP3 or WMA format data cannot be played.

● Extensions

If the file extensions .mp3 and .wma are used for files other than MP3 and WMA files, they will be mistakenly recognized and played as MP3 and WMA files. This may result in large amounts of interference and damage to the speakers.

● Playback

- To play MP3 files with steady sound quality, we recommend a fixed bit rate of at least 128 kbps and a sampling frequency of 44.1 kHz.
- CD-R or CD-RW playback may not be possible in some instances, depending on the characteristics of the disc.
- There is a wide variety of freeware and other encoding software for MP3 and WMA files on the market, and depending on the status of the encoding and the file format, poor sound quality or noise at the start of playback may result. In some cases, playback may not be possible at all.
- When files other than MP3 or WMA files are recorded on a disc, it may take more time to recognize the disc and in some cases, playback may not be possible at all.
- Microsoft, Windows, and Windows Media are the registered trademarks of Microsoft Corporation in the U.S.A. and other countries.

NOTICE

■ CDs and adapters that cannot be used

→P. 303

■ CD player precautions

→P. 304

3-2. Using the audio system

Operating an iPod® player*

Connecting an iPod® player enables you to enjoy music from the vehicle speakers.

■ Connecting an iPod® player

STEP 1

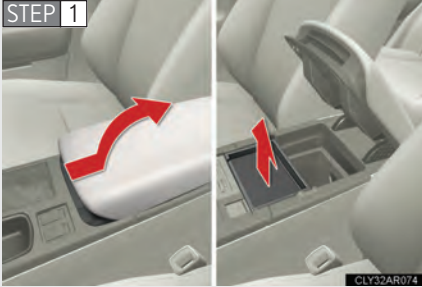

Slide the armrest while pulling up the lever, and lift the armrest. Remove the upper tray.

STEP 2



Remove the lower tray.

STEP 3



Open the cover and connect an iPod® player using an iPod® cable.

STEP 4 Press .

*: If equipped

■ Control panel

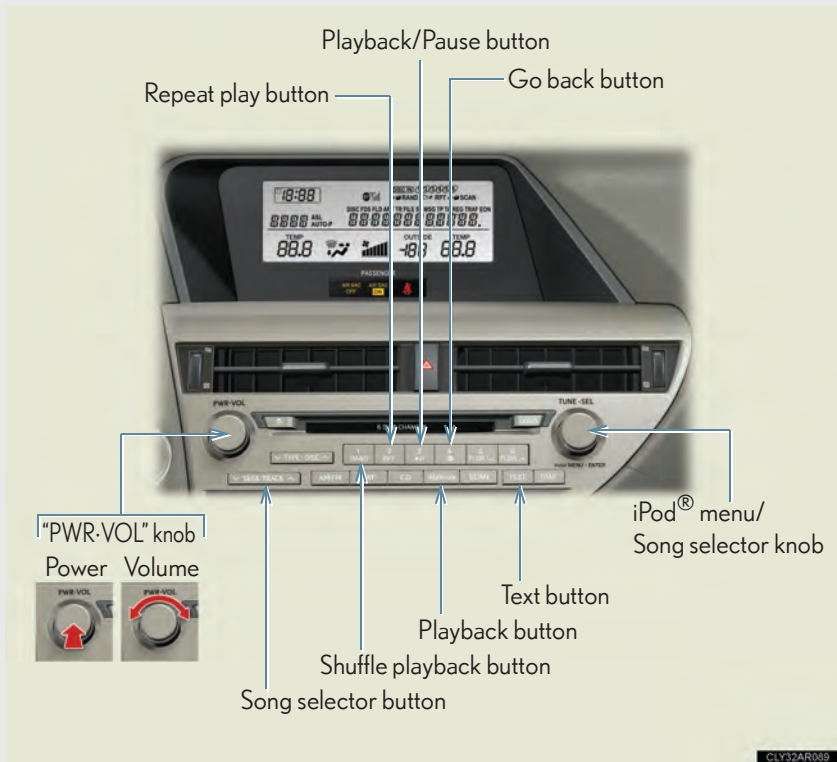

Selecting a play mode

STEP 1 Press  to select iPod® menu mode.

STEP 2 Turning  changes the play mode in the following order:

“PLAYLISTS” → “ARTISTS” → “ALBUMS” → “SONGS” →
 “PODCASTS” → “GENRES” → “COMPOSERS” →
 “AUDIOBOOKS”

STEP 3 Press  to select the desired play mode.

■ Play mode list

Play mode	First selection	Second selection	Third selection	Fourth selection
"PLAYLISTS"	Playlists select	Songs select	-	-
"ARTISTS"	Artists select	Albums select	Songs select	-
"ALBUMS"	Albums select	Songs select	-	-
"SONGS"	Songs select	-	-	-
"PODCASTS"	Albums select	Songs select	-	-
"GENRES"	Genre select	Artists select	Albums select	Songs select
"COMPOSERS"	Composers select	Albums select	Songs select	-
"AUDIOBOOKS"	Songs select	-	-	-

■ Selecting a list

STEP 1 Turn  to display the first selection list.

STEP 2 Press  to select the desired item.

Pressing the knob changes to the second selection list.

STEP 3 Repeat the same procedure to select the desired song name.

To return to the previous selection list, select "GO BACK" or press



Selecting songs

Turn  or press “^” or “v” on  to select the desired song.

Playing and pausing songs

To play or pause a song, press .

Fast-forwarding and rewinding songs

To fast-forward or rewind, press and hold “^” or “v” on  until you hear a beep.

Shuffle playback

■ Playing songs from one playlist or album in random order

Press .

To cancel, press  again.

■ Playing songs from all the playlists or albums in random order

Press and hold  until you hear a beep.

To cancel, press  again.

Repeat play

Press .

To cancel, press  again.

Switching the display

Press .

Each time the button is pressed, the display changes in the following order:
Elapsed time → Album title → Track title → Artist name

Adjusting sound quality and volume balance

STEP 1 Press  to enter iPod® menu mode.

STEP 2 Pressing  changes sound modes. (→P. 333)

■ About iPod®

iPod is registered trademarks of Apple, Inc.

■ iPod® player functions

- When an iPod® player is connected and the audio source is changed to iPod® player mode, the iPod® player will resume play from the same point in which it was last used.
- Depending on the iPod® player that is connected to the system, certain functions may not be available. Disconnecting the device and reconnecting it once again may resolve some malfunctions.
- While connected to the system, the iPod® player cannot be operated with its own controls. It is necessary to use the controls of the vehicle's audio system instead.

■ iPod® player problems

To resolve most problems encountered when using your iPod® player, disconnect your iPod® player from the vehicle iPod® player connection and reset it. For instructions on how to reset your iPod® player, refer to your iPod® player Owner's Manual.

■ Display

→P. 301

■ Routing portable audio device cables



When the cover is slide open, portable audio device cables can be pulled through the opening.

■ Error messages

“ERROR”: This indicates a problem in the iPod® player or its connection.

“NO MUSIC”: This indicates that there is no music data in the iPod® player.

“EMPTY”: This indicates that an empty playlist is selected.

“UPDATE”: This indicates that the version of the iPod® player is not compatible. Upgrade your iPod® software to the latest version.

■ Compatible models

- iPod® 5th generation Ver. 1.2 or later
- iPod® nano 3rd generation Ver. 1.0 or later
- iPod® nano 2nd generation Ver. 1.1.2 or later
- iPod® nano Ver. 1.2 or later
- iPod® touch Ver. 1.1 or later
- iPod® classic Ver. 1.0 or later

iPhone®, iPod® mini, iPod® shuffle, iPod® photo and 4th generation and earlier models of iPod® are not compatible with this system.

Items related to standards and limitations are as follows:

- Maximum number of lists in device: 9999
- Maximum number of songs in device: 65025
- Maximum number of songs per list: 65025

CAUTION

■ Caution while driving

Do not connect iPod® players or operate the controls.

NOTICE

■ To prevent damage to iPod® players

- Do not leave iPod® players in the vehicle. The temperature inside the vehicle may become high, resulting in damage to the player.
- Do not push down on or apply unnecessary pressure to the iPod® player while it is connected as this may damage the iPod® player or its terminal.
- Do not insert foreign objects into the port as this may damage the iPod® player or its terminal.

3-2. Using the audio system

Operating a USB memory player*

Connecting a USB memory player enables you to enjoy music from the vehicle speakers.

■ Connecting a USB memory player

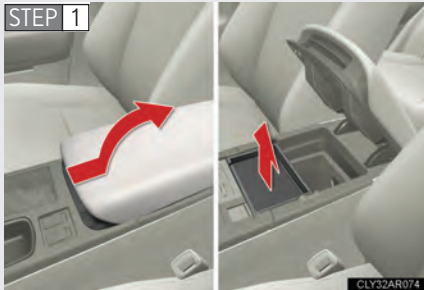

Slide the armrest while pulling up the lever, and lift the armrest. Remove the upper tray.

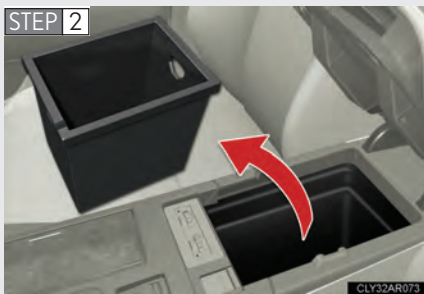

Remove the lower tray.



Open the cover and connect a USB memory player.

STEP 4 Press .

Control panel

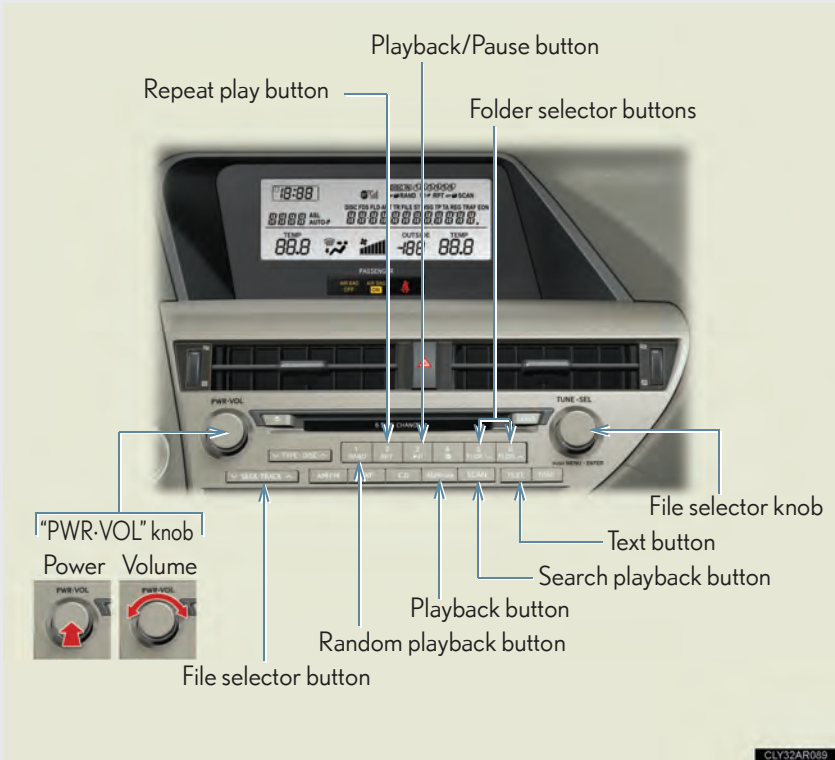

Selecting and scanning a folder

■ Selecting folders one at a time

Press  or  to select the desired folder.

■ Returning to the first folder

Press and hold  until you hear a beep.

■ Scanning the first file of all the folders

STEP 1 Press and hold  until you hear a beep.

The first ten seconds of the first file in each folder will be played.

STEP 2 When the desired folder is reached, press  again.

Selecting and scanning files

■ Selecting a file

Turn  or press “^” or “v” on  to select the desired file.

■ Scanning the files in a folder

Press .

The first ten seconds of each file will be played.

To cancel, press  again.

When the desired file is reached, press  again.

Playing and pausing files

To play or pause a file, press .

Fast-forwarding and rewinding files

To fast-forward or rewind, press and hold “^” or “v” on  until you hear a beep.

Random playback

■ Playing files from a folder in random order

Press .

To cancel, press  again.

■ Playing all the files from a USB memory player in random order

Press and hold  until you hear a beep.

To cancel, press  again.

Repeat play

■ Repeating a file

Press .

To cancel, press  again.

■ Repeating all the files in a folder

Press and hold  until you hear a beep.

To cancel, press  again.

Switching the display

Press .

Each time the button is pressed, the display changes in the following order:
Elapsed time → Folder name → File name → Album title → Track title →
Artist name

■ USB memory player functions

- Depending on the USB memory player that is connected to the system, the device itself may not be operable and certain functions may not be available. If the device is inoperable or a function is unavailable due to a malfunction (as opposed to a system specification), disconnecting the device and reconnecting it once again may resolve the problem.
- If the USB memory player still does not begin operation after being disconnected and reconnected, format the memory.

■ Display

→P. 301

■ Routing portable audio device cables

→P. 321

■ Error messages

- “ERROR”: This indicates a problem in the USB memory player or its connection.
- “NO MUSIC”: This indicates that no MP3/WMA files are included in the USB memory player.

■ USB memory player

● Compatible devices

USB memory players that can be used for MP3 and WMA playback

● Compatible device formats

The following device formats can be used:

- USB communication formats: USB2.0 FS (12mbps)
- File formats: FAT16/32 (Windows)
- Correspondence class: Mass storage class

MP3 and WMA files written in any format other than those listed above may not play correctly, and their file names and folder names may not be displayed correctly.

Items related to standards and limitations are as follows:

- Maximum directory hierarchy: 8 levels
- Maximum number of folders in a device: 999 (including the root)
- Maximum number of files in a device: 65025
- Maximum number of files per folder: 255

● MP3 and WMA files

MP3 (MPEG Audio LAYER 3) is a standard audio compression format.

Files can be compressed to approximately 1/10 of their original size using MP3 compression.

WMA (Windows Media™ Audio) is a Microsoft audio compression format.

This format compresses audio data to a size smaller than that of the MP3 format.

There is a limit to the MP3 and WMA file standards that can be used and to the media/formats on which the files are recorded.

- MP3 file compatibility

- Compatible standards
MP3 (MPEG1 AUDIO LAYERII, III, MPEG2 AUDIO LAYERII, III, MPEG2.5)
- Compatible sampling frequencies
MPEG1 AUDIO LAYERII, III: 32, 44.1, 48 (kHz)
MPEG2 AUDIO LAYERII, III: 16, 22.05, 24 (kHz)
MPEG2.5: 8, 11.025, 12 (kHz)
- Compatible bit rates (compatible with VBR)
MPEG1 AUDIO LAYERII, III: 32-320 (kbps)
MPEG2 AUDIO LAYERII, III: 32-160 (kbps)
MPEG2.5: 32-160 (kbps)
- Compatible channel modes: stereo, joint stereo, dual channel and monaural

- WMA file compatibility

- Compatible standards
WMA Ver. 9
- Compatible sampling frequencies
HIGH PROFILE 32, 44.1, 48 (kHz)
- Compatible bit rates
HIGH PROFILE 32-320 (kbps, VBR)

- File names

The only files that can be recognized as MP3/WMA and played are those with the extension .mp3 or .wma.

- ID3 and WMA tags

ID3 tags can be added to MP3 files, making it possible to record the track title, artist name, etc.

The system is compatible with ID3 Ver. 1.0, 1.1, and Ver. 2.2, 2.3, 2.4 ID3 tags. (The number of characters is based on ID3 Ver. 1.0 and 1.1.)

WMA tags can be added to WMA files, making it possible to record the track title and artist name in the same way as with ID3 tags.

● MP3 and WMA playback

- When a device containing MP3 or WMA files is connected, all files in the USB memory device are checked. Once the file check is finished, the first MP3 or WMA file is played. To make the file check finish more quickly, we recommend that you do not include any files other than MP3 or WMA files or create any unnecessary folders.
- When the USB device is connected and the audio source is changed to USB memory player mode, the USB device will start playing the first file in the first folder. If the same device is removed and reinserted (and the contents have not been changed), the USB device will resume play from the same point in which it was last used.

● Extensions

If the file extensions .mp3 and .wma are used for files other than MP3 and WMA files, they will be mistakenly recognized and played as MP3 and WMA files. This may result in large amounts of interference and damage to the speakers.

● Playback

- To play MP3 files with steady sound quality, we recommend a fixed bit rate of at least 128 kbps and a sampling frequency of 44.1 kHz.
- There is a wide variety of freeware and other encoding software for MP3 and WMA files on the market, and depending on the status of the encoding and the file format, poor sound quality or noise at the start of playback may result. In some cases, playback may not be possible at all.
- Microsoft, Windows, and Windows Media are registered trademarks of Microsoft Corporation in the U.S.A. and other countries.

CAUTION

Caution while driving

Do not connect USB players or operate the controls.

 NOTICE**■ To prevent damage to USB memory players**

- Do not leave USB memory players in the vehicle. The temperature inside the vehicle may become high, resulting in damage to the player.
- Do not push down on or apply unnecessary pressure to the USB memory player while it is connected as this may damage the USB memory player or its terminal.
- Do not insert foreign objects into the port as this may damage the USB memory player or its terminal.

3-2. Using the audio system

Optimal use of the audio system

► Type A and B



► Type C



- 1 Displays the current mode
- 2 Changes the following settings:
 - Sound quality and volume balance
→P.333The sound quality and balance setting can be changed to produce the best sound.
- Automatic Sound Levelizer on/off
→P.334

Adjusting sound quality and volume balance

■ Changing sound quality modes

Press  or .

Pressing the button changes sound modes in the following order:

“BAS” → “MID” → “TRE” → “FAD” → “BAL” → “ASL”



■ Adjusting sound quality

Turning  or  adjusts the level.

Mode displayed	Sound quality mode	Level	Turn counter-clockwise	Turn clockwise
“BAS”	Bass*	-5 to 5	Low	High
“MID”	Mid-range*	-5 to 5		
“TRE”	Treble*	-5 to 5		
“FAD”	Front/rear volume balance	F7 to R7	Shifts to rear	Shifts to front
“BAL”	Left/right volume balance	L7 to R7	Shifts to left	Shifts to right

*: The sound quality level is adjusted individually in each audio mode.

Turning the Automatic Sound Levelizer (ASL) on/off

Turning  or  clockwise turns on the ASL, and turning 

or  counterclockwise turns off the ASL.

ASL automatically adjusts the volume and tone quality according to the noise level as you drive your vehicle.

3-2. Using the audio system

Using the AUX adapter

This adapter can be used to connect a portable audio device and listen to it through the vehicle's speakers.

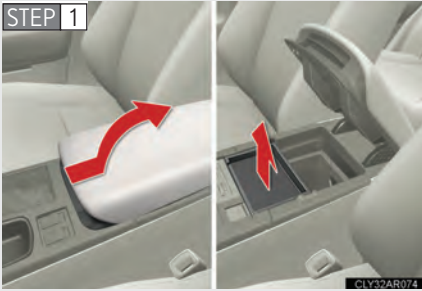

Slide the armrest while pulling up the lever, and lift the armrest. Remove the upper tray.

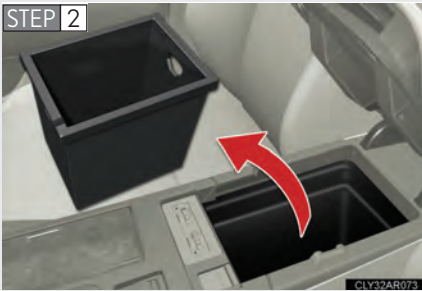

Remove the lower tray.

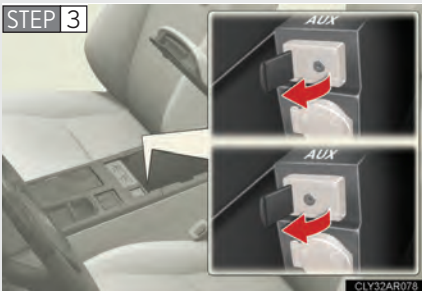

Open the cover and connect the portable audio device.

STEP 4 Press **AUX-168** or **AUX** .

■ Operating portable audio devices connected to the audio system

The volume can be adjusted using the vehicle's audio controls. All other adjustments must be made on the portable audio device itself.

■ When using a portable audio device connected to the power outlet

Noise may occur during playback. Use the power source of the portable audio device.

■ Routing portable audio device cables

→P. 321

3-2. Using the audio system

Using the steering wheel audio switches

Some audio features can be controlled using the switches on the steering wheel.



- 1** Turns the power on, selects an audio source
- 2** Increases/decreases volume
- 3** Radio mode: Selects a radio station
CD mode: Selects a track, file (MP3 and WMA) and disc
Bluetooth[®] audio mode: Selects a track and album
iPod[®] player mode: Selects a song
USB memory player mode: Selects a file and folder

Turning the power on

Press  when the audio system is turned off.

The audio system can be turned off by holding the switch down for 1 second or more.

Changing the audio source

Press  when the audio system is turned on. The audio source changes as follows each time the button is pressed. If no discs are inserted in the player, that mode will be skipped.

Type A:

FM1→FM2→SAT1→SAT2→SAT3→CD player→
Bluetooth® audio→AUX→iPod® or USB memory player→
AM→FM1

Type B:

FM1→FM2→SAT1→SAT2→SAT3→CD player→
Bluetooth® audio→AUX→AM→FM1

Type C:

FM1→FM2→CD player→AUX→AM→FM1

Adjusting the volume

Press “+” on  to increase the volume and “-” to decrease the volume.

Hold down the button to continue increasing or decreasing the volume.

Selecting a radio station

STEP 1 Press  to select radio mode.

STEP 2 Press “^” or “v” on  to select a radio station.

To scan for receivable stations, press and hold “^” or “v” on the button until you hear a beep.

Selecting a track/file or song

STEP 1 Press  to select CD, Bluetooth® audio, iPod® player or USB memory player mode.

STEP 2 Press “^” or “v” on  to select the desired track/file or song.

Selecting an album

STEP 1 Press  to select Bluetooth® audio mode.

STEP 2 Press and hold “^” or “v” on  until you hear a beep.

Selecting a folder

STEP 1 Press  to select USB memory player mode.

STEP 2 Press and hold “^” or “v” on  until you hear a beep.

Selecting a disc in the CD player

STEP 1 Press  to select CD mode.

STEP 2 Press and hold “^” or “v” on  until you hear a beep.

■ Canceling automatic selection of a radio station

Press  again.

CAUTION

■ To reduce the risk of an accident

Exercise care when operating the audio switches on the steering wheel.

3-3. Using the Bluetooth[®] audio system

Bluetooth[®] audio system*

The Bluetooth[®] audio system enables you to enjoy music played on a portable digital audio player (portable player) from the vehicle speakers via wireless communication.

This audio system supports Bluetooth[®], a wireless data system capable of playing portable audio music without cables. If your portable player does not support Bluetooth[®], the Bluetooth[®] audio system will not function.

▶ Vehicles with a navigation system

Owners of models equipped with a navigation system should refer to the "Navigation System Owner's Manual".

▶ Vehicles without a navigation system

Title	Page
Using the Bluetooth [®] audio system	P. 343
Operating a Bluetooth [®] enabled portable player	P. 348
Setting up a Bluetooth [®] enabled portable player	P. 352
Bluetooth [®] audio system setup	P. 359

■ Conditions under which the system will not operate

- If using a portable player that does not support Bluetooth[®]
- If the portable player is switched off
- If the portable player is not connected
- If the portable player's battery is low
- If the portable player is behind the seat or in the glove box or console box
- If metal is covering or touching the portable player

*: If equipped

■ When transferring ownership of the vehicle

Be sure to initialize the system to prevent personal data from being improperly accessed. (→P. 386)

■ About Bluetooth®



Bluetooth is a registered trademark of Bluetooth SIG, Inc.

■ Compatible models

- Bluetooth® specifications:
Ver. 1.2, or higher (Recommended: Ver. 2.0+EDR or higher)
- Following Profiles:
 - A2DP (Advanced Audio Distribution Profile) Ver. 1.0
 - AVRCP (Audio/Video Remote Control Profile) Ver. 1.0 or higher (Ver. 1.3 or higher recommended)

Portable players must correspond to the above specifications in order to be connected to the Bluetooth® audio system. However, please note that some functions may be limited depending on the type of portable player.

■ Certification for the Bluetooth® audio system

FCC ID: AJDK018
IC ID: 775E-K018
MADE IN JAPAN

This device complies with Part 15 of the FCC Rules and RSS-Gen of IC Rules. Operation is subject to the following two conditions: (1) This device may not cause harmful interference, and (2) This device must accept any interference received, including interference that may cause undesired operation.

CAUTION

■ FCC WARNING

Changes or modifications not expressly approved by the party responsible for compliance could void the user's authority to operate the equipment.

Radio Frequency Radiation Exposure. This equipment complies with FCC radiation exposure limits set forth for uncontrolled equipment and meets the FCC radio frequency (RF) Exposure Guidelines in Supplement C to OET65. This equipment has very low levels of RF energy that it deemed to comply without maximum permissive exposure evaluation (MPE). But it is desirable that it should be installed and operated with at least 7.9 in. (20 cm) and more between the radiator and person's body (excluding extremities: hands, wrists, feet and legs).

This transmitter must not be co-located or operated in conjunction with any other antenna or transmitter.

■ Caution while driving

Do not connect portable players or operate the controls.

NOTICE

■ To prevent damage to portable players

Do not leave portable players in the vehicle. The temperature inside the vehicle may become high, resulting in damage to the player.

Using the Bluetooth® audio system

■ Audio unit

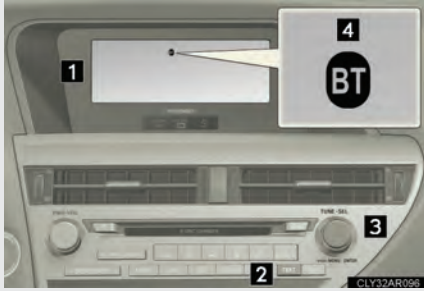

- 1 Display
A message, name, number, etc. is displayed.

Lower-case characters and special characters cannot be displayed.

- 2 Displays information that is too long to be displayed at one time on the display (press and hold)
- 3 Selects items such as menu and number
Turn: Selects an item
Press: Inputs the selected item
- 4 Bluetooth® connection condition

If "BT" is not displayed, the Bluetooth® audio system cannot be used.

Operating the system using voice commands

By following voice guidance instructions output from the speaker, voice commands enable to the operation of the Bluetooth® audio system without the need to check the display or operate



■ Operation procedure when using voice commands

Press the talk switch and follow voice guidance instructions.

■ Auxiliary commands when using voice commands

The following auxiliary commands can be used when operating the system using a voice command:

“Cancel”: Exits the Bluetooth® audio system

“Repeat”: Repeats the previous voice guidance instruction

“Go back”: Returns to the previous procedure

“Help”: Reads aloud the function summary if a help comment is registered for the selected function

Using the Bluetooth® audio system for the first time

Before using the Bluetooth® audio system, it is necessary to register a Bluetooth® enabled portable player in the system. Follow the procedure below to register (pair) a portable player:

STEP 1 Press  and select “BT•A MENU” using .

STEP 2 Press the talk switch or select “BT•A Setup” using .

The introductory guidance and portable player name registration instructions are heard.

STEP 3 Select “Pair Audio Player (Pair Audio)” using a voice command or .

STEP 4 Register a portable player name by either of the following methods:

- a. Select “Record Name” using , and say the name to be registered.
- b. Press the talk switch and say the name to be registered.

A voice guidance instruction to confirm the input is heard.

STEP 5 Select “Confirm” using a voice command or .

A passkey is displayed and heard, and a voice guidance instruction for inputting the passkey into the portable player is heard.

STEP 6 Input the passkey into the portable player.

Refer to the manual that comes with the portable player for the operation of the portable player.

Guidance for registration completion is heard.

If the portable player has a Bluetooth® phone, the phone can be registered at the same time. A voice guidance instruction to register a Bluetooth® phone is heard.

STEP 7 Select “Yes” or “No” using a voice command or (Bluetooth® phone →P. 362)



Menu list of the Bluetooth® audio system

■ Normal operation

First menu	Second menu	Third menu	Operation detail
“Setup”	“BT·A Setup”	“Pair Audio”	Registering a portable player
		“Connect”	Selecting a portable player to be used
		“Change Name”	Changing the registered name of a portable player
		“List Audios”	Listing the registered portable players
		“Set Passkey”	Changing the passkey
		“Delete Audio”	Deleting a registered portable player
	“System Setup”	“Guidance Vol”	Setting voice guidance volume
		“Device Name”	Displaying the Bluetooth® device address and name
		“Initialize”	Initializing the system

■ When using a voice command

For numbers, say a combination of single digits from zero to nine.
Say the command correctly and clearly.

■ Situations that the system may not recognize your voice

- When driving on rough roads
- When driving at high speeds
- When air is blowing out of the vents onto the microphone
- When the air conditioning fan emits a loud noise

■ Operations that cannot be performed while driving

- Operating the system with 
- Registering a portable player to the system

■ Changing the passkey

→P. 357

3-3. Using the Bluetooth® audio system Operating a Bluetooth® enabled portable player

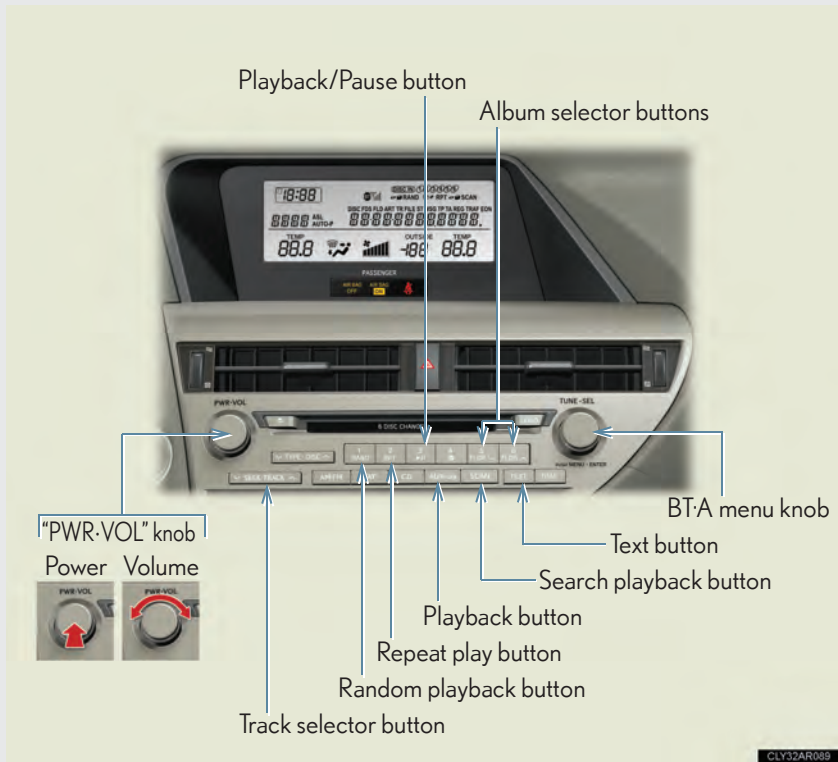

▶ Type A

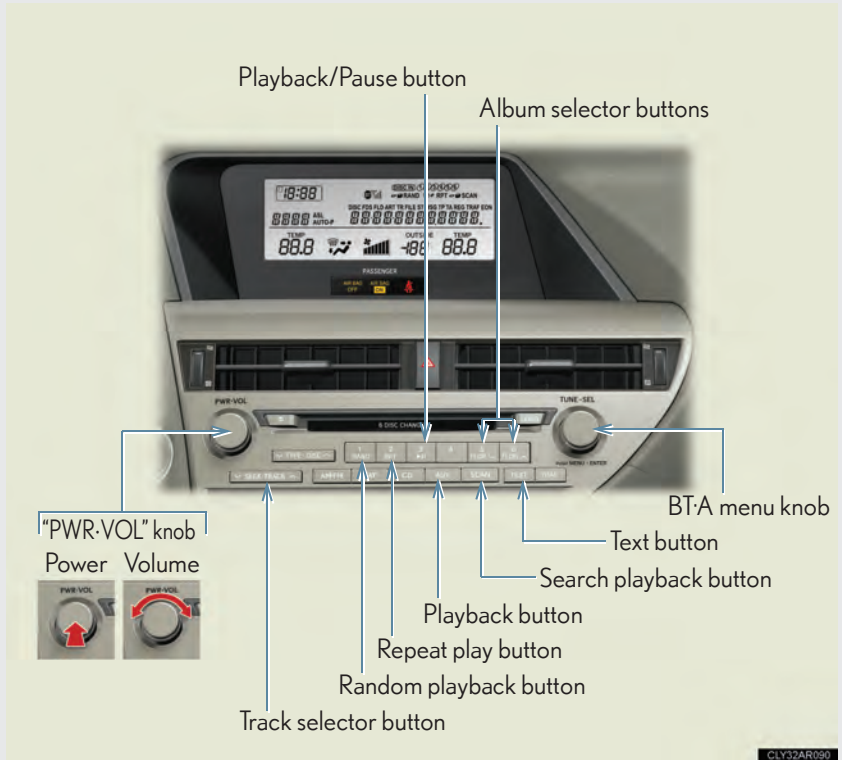

► Type B



Selecting an album

To select the desired album, press  or .

Selecting tracks

Press “^” or “v” on  to select the desired track.

Playing and pausing tracks

To play or pause a track, press .

Fast-forwarding and rewinding tracks

To fast-forward or rewind, press and hold “^” or “v” on  until you hear a beep.

Random playback

Press .

To cancel, press  again.

Repeat play

Press .

To cancel, press  again.

Scanning tracks

Press .

To cancel, press  again.

Switching the display

Press **TEXT**.

Each time the button is pressed, the display changes in the following order:
Elapsed time → Album title → Track title → Artist name

Using the steering wheel audio switches

→P. 337

■ Bluetooth® audio system functions

Depending on the portable player that is connected to the system, certain functions may not be available.

■ Display

→P. 301

■ Error messages

“Memory Error”: This indicates a problem in the system.

3-3. Using the Bluetooth® audio system

Setting up a Bluetooth® enabled portable player

Registering a portable player in the Bluetooth® audio system allows the system to function. The following functions can be used for registered portable players:

■ Functions and operation procedures

▶ Pattern A

To enter the menu for each function, follow the steps below using a

voice command or



- Registering a portable player
 1. "Setup" → 2. "Bluetooth Audio Setup (BT•A Setup)" →
 3. "Pair Audio Player (Pair Audio)"
- Selecting a portable player to be used
 1. "Setup" → 2. "Bluetooth Audio Setup (BT•A Setup)" →
 3. "Connect Audio Player (Connect)"
- Changing the registered name of a portable player
 1. "Setup" → 2. "Bluetooth Audio Setup (BT•A Setup)" →
 3. "Change Name"
- Listing the registered portable players
 1. "Setup" → 2. "Bluetooth Audio Setup (BT•A Setup)" →
 3. "List Audio Players (List Audios)"
- Changing the passkey
 1. "Setup" → 2. "Bluetooth Audio Setup (BT•A Setup)" →
 3. "Set Passkey"
- Deleting a registered portable player
 1. "Setup" → 2. "Bluetooth Audio Setup (BT•A Setup)" →
 3. "Delete Audio Player (Delete Audio)"

▶ Pattern B

STEP 1 Press  to select "BT•A MENU".

STEP 2 Press the talk switch or select "BT•A Setup" using .

STEP 3 Select one of the following functions using a voice command

or .

- Registering a portable player
"Pair Audio Player (Pair Audio)"
- Selecting a portable player to be used
"Connect Audio Player (Connect)"
- Changing the registered name
"Change Name"
- Listing the registered portable players
"List Audio Players (List Audios)"
- Changing the passkey
"Set Passkey"
- Deleting a registered portable player
"Delete Audio Player (Delete Audio)"

Registering a portable player

Select “Pair Audio Player (Pair Audio)” using a voice command or , and perform the procedure for registering a portable player. (→P. 345)

Selecting a portable player to be used

STEP 1 Select “Connect Audio Player (Connect)” using a voice com-

mand or .

► Pattern A

STEP 2 Select the portable player to be used by either of the following methods, and select “Confirm” by using a voice command or



- Press the talk switch and say the name of the desired portable player.
- Press the talk switch and say “List Audio Players”. When the name of the desired portable player is read aloud, press the talk switch.

► Pattern B

STEP 2 Select the portable player to be used using



▶ Pattern A

STEP 3 Press the talk switch and say “From Car” or “From Audio player”, and select “Confirm” by using a voice command or .

▶ Pattern B

STEP 3 Select “From Car” or “From Audio”, using .

If “From Car” is selected, the portable player will be automatically connected whenever the “ENGINE START STOP” switch is in either ACCESSORY or IGNITION ON mode.

Changing the registered name of a portable player

STEP 1 Select “Change Name” using a voice command or .

▶ Pattern A

STEP 2 Select the name of the portable player to be changed by either of the following methods, and select “Confirm” using a voice com-

mand or  :

- a. Press the talk switch and say the name of desired portable player.
- b. Press the talk switch and say “List Audio Players”. When the name of the desired portable player is read aloud, press the talk switch.

► Pattern B

STEP 2 Select the desired portable player name to be changed using



STEP 3 Press the talk switch or select “Record Name” using , and say the new name.

STEP 4 Select “Confirm” using a voice command or



Listing the registered portable players

Select “List Audio Players (List Audios)” using a voice command or



. The list of registered portable players will be read aloud.

When listing is complete, the system returns to “BT•A Setup”.

Pressing the talk switch while the name of a portable player is being read aloud selects the portable player, and the following functions will become available:

- Selecting a portable player: “Connect Audio Player (Connect)”
- Changing a registered name: “Change Name”
- Deleting a portable player: “Delete Audio Player (Delete Audio)”

Changing the passkey

STEP 1 Select “Set Passkey” using a voice command or



► Pattern A

STEP 2 Press the talk switch, say a 4 to 8-digit number, and select “Confirm” using a voice command or



► Pattern B

STEP 2 Select a 4 to 8-digit number using



The number should be input 1 digit at a time.

STEP 3 When the entire number to be registered as a passkey has been input, press



again.

If the number to be registered has 8 digits, pressing of the knob is not necessary.

Deleting a registered portable player

STEP 1 Select “Delete Audio Player (Delete Audio)” using a voice command or  .

► Pattern A

STEP 2 Select the portable player to be deleted by either of the following methods and select “Confirm” using a voice command or  :

- a. Press the talk switch and say the name of the desired portable player.
- b. Press the talk switch and say “List Audio Players”. When the name of the desired portable player is read aloud, press the talk switch.

► Pattern B

STEP 2 Select the desired portable player to be deleted using  .

If the portable player to be deleted is paired as a Bluetooth® phone, the registration of the mobile phone can be deleted at the same time. A voice guidance instruction to delete a mobile phone is heard.

STEP 3 Select “Yes” or “No” using a voice command or  .
(Bluetooth® phone →P. 362)

■ The number of portable players that can be registered

Up to 2 portable players can be registered in the system.

3-3. Using the Bluetooth[®] audio system

Bluetooth[®] audio system setup

■ System setup items and operation procedures

▶ Pattern A

To enter the menu for each function, follow the steps below using a

voice command or  :

(→P. 383)

▶ Pattern B

STEP 1 Press  to select “BT•A MENU”.

STEP 2 Select “System Setup” using .

STEP 3 Select one of the following items using  :

- Setting voice guidance volume
“Guidance Vol” (→P. 385)
- Displaying the Bluetooth[®] device address and name
“Device Name” (→P. 385)
- Initializing the system
“Initialize” (→P. 386)

3-4. Using the hands-free phone system (for mobile phones)

Hands-free system for mobile phones*

The hands-free system is a function that allows you to use your mobile phone without touching it.

This system supports Bluetooth® mobile phones. Bluetooth® is a wireless data system that allows the mobile phone to wirelessly connect to the hands-free system and make/receive calls.

► Vehicles with a navigation system

Owners of models equipped with a navigation system should refer to the “Navigation System Owner's Manual”.

► Vehicles without a navigation system

Title	Page
Using the hands-free system	P. 364
Making a phone call	P. 372
Setting a mobile phone	P. 377
Security and system setup	P. 383
Using the phone book	P. 387

*: If equipped

■ Conditions under which the system will not operate

- If using a mobile phone that does not support Bluetooth®
- If the mobile phone is switched off
- If you are outside service range
- If the mobile phone is not connected
- If the mobile phone's battery is low
- If the mobile phone is behind the seat or in the glove box or console box
- If metal is covering or touching the phone

■ When using the hands-free system

- The audio system and voice guidance are muted when making a call.
- If both parties speak at the same time, it may be difficult to hear.
- If the incoming call volume is overly loud, an echo may be heard.
- Try to face toward the microphone as much as possible when speaking.
- In the following circumstances, it may be difficult to hear the other party:
 - When driving on unpaved roads
 - When driving at high speeds
 - When a window is open
 - When the air conditioning is blowing directly on the microphone
 - When the air conditioning is set to high

■ When transferring ownership of the vehicle

Be sure to initialize the system to prevent personal data from being improperly accessed. (→P. 386)

■ About Bluetooth®

Bluetooth is a registered trademark of Bluetooth SIG, Inc.

3-4. Using the hands-free phone system (for mobile phones)

■ Compatible models

Compatible with HFP (Hands Free Profile) Ver. 1.5 and OPP (Object Push Profile) Ver. 1.1.

If your mobile phone does not support HFP, you cannot enter the Bluetooth[®] phone. If your mobile phone supports OPP alone, you cannot use the Bluetooth[®] phone.

■ Certification for the hands-free system

FCC ID: AJDK018

IC ID: 775E-K018

MADE IN JAPAN

This device complies with Part 15 of the FCC Rules and RSS-Gen of IC Rules. Operation is subject to the following two conditions: (1) This device may not cause harmful interference, and (2) This device must accept any interference received, including interference that may cause undesired operation.

CAUTION

■ FCC WARNING

Changes or modifications not expressly approved by the party responsible for compliance could void the user's authority to operate the equipment.

Radio Frequency Radiation Exposure. This equipment complies with FCC radiation exposure limits set forth for uncontrolled equipment and meets the FCC radio frequency (RF) Exposure Guidelines in Supplement C to OET65. This equipment has very low levels of RF energy that it deemed to comply without maximum permissive exposure evaluation (MPE). But it is desirable that it should be installed and operated with at least 7.9 in. (20 cm) and more between the radiator and person's body (excluding extremities: hands, wrists, feet and legs).

This transmitter must not be co-located or operated in conjunction with any other antenna or transmitter.

■ Caution while driving

Do not use a mobile phone or connect the Bluetooth[®] phone.

 NOTICE

■ **To prevent damage to mobile phones**

Do not leave mobile phones in the vehicle. The temperature inside the vehicle may become high, resulting in damage to the phone.

3-4. Using the hands-free phone system (for mobile phones)

Using the hands-free system (for mobile phones)

■ Audio unit

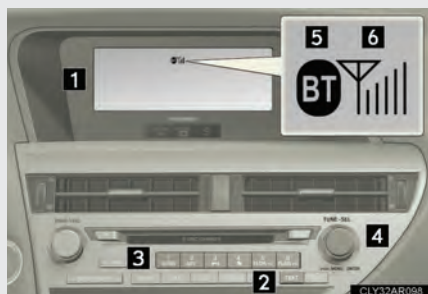

- 1** Display
A message, name, phone number, etc. is displayed.
Lower-case characters and special characters cannot be displayed.
- 2** Displays information that is too long to be displayed at one time on the display (press and hold)
- 3** Selects speed dials
- 4** Selects items such as menu and number
Turn: Selects an item
Press: Inputs the selected item
- 5** Bluetooth[®] connection condition
If "BT" is not displayed, the hands-free phone system cannot be used.
- 6** Reception level

■ Steering wheel switches

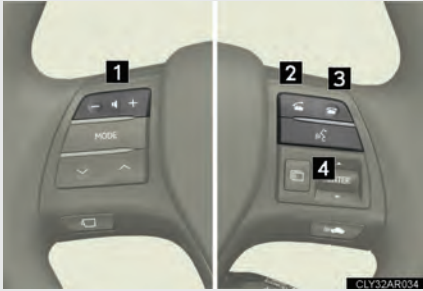

1 Volume

The voice guidance volume cannot be adjusted using this button.

2 Off-hook switch

Turns the hands-free system on/starts a call

3 On-hook switch

Turns the hands-free system off/ends a call/refuses a call

4 Talk switch

Turns the voice command system on (press)/turns the voice command system off (press and hold)

■ Microphone



Operating the system using voice commands

By following voice guidance instructions output from the speaker, voice commands enable the operation of the hands-free phone system with-

out the need to check the display or operate



■ Operation procedure when using voice commands

Press the talk switch and follow voice guidance instructions.

■ Auxiliary commands when using voice commands

The following auxiliary commands can be used when operating the system using a voice command:

“Cancel”: Exits the hands-free phone system

“Repeat”: Repeats the previous voice guidance instruction

“Go back”: Returns to the previous procedure

“Help”: Reads aloud the function summary if a help comment is registered for the selected function

Using the hands-free phone system for the first time

Before using the hands-free phone system, it is necessary to register a mobile phone in the system. The system will enter phone registration mode automatically when starting the system with no mobile phone registered. Follow the procedure below to register (pair) a mobile phone:

STEP 1 Press the off-hook switch or the talk switch.

The introductory guidance and phone name registration instructions are heard.

STEP 2 Select "Pair Phone" using a voice command or



STEP 3 Register a phone name by either of the following methods:

- a. Select "Record Name" using , and say the name to be registered.
- b. Press the talk switch and say the name to be registered.

A voice guidance instruction to confirm the input is heard.

STEP 4 Select "Confirm" using a voice command or



A passkey is displayed and heard, and a voice guidance instruction for inputting the passkey into the mobile phone is heard.

STEP 5 Input the passkey into the mobile phone.

Refer to the manual that comes with the mobile phone for the operation of the phone.

Guidance for registration completion is heard.

If the mobile phone has a Bluetooth[®] audio player, the audio player can be registered at the same time. A voice guidance instruction to register a Bluetooth[®] audio player is heard.

STEP 6 Select “Yes” or “No” using a voice command or



(Bluetooth[®] audio player →P. 341)

Menu list of the hands-free phone system

■ Normal operation

First menu	Second menu	Third menu	Operation detail
“Callback”	-	-	Dialing a number stored in the incoming call history memory
“Redial”	-	-	Dialing a number stored in the outgoing call history memory
“Phonebook”	“Add Entry”	-	Adding a new phone number
	“Change Name”	-	Changing the registered name in the phone book
	“Delete Entry”	-	Deleting the registered data
	“Del Spd Dial”	-	Deleting speed dials
	“List Names”	-	Listing the registered data
	“Speed Dial”	-	Setting speed dials

First menu	Second menu	Third menu	Operation detail
"Setup"	"Security"	"Set PIN"	Setting a PIN code
		"Phbk Lock"	Locking the phone book
		"Phbk Unlock"	Unlocking the phone book
	"Phone Setup"	"Pair Phone"	Registering the mobile phone to be used
		"Connect"	Selecting a mobile phone to be used
		"Change Name"	Changing a registered name of a mobile phone
		"List Phones"	Listing the registered mobile phones
		"Set Passkey"	Changing the passkey
		"Delete Phone"	Deleting a registered mobile phone
	"System Setup"	"Guidance Vol"	Setting voice guidance volume
		"Device Name"	Displaying the Bluetooth [®] device address and name
"Initialize"		Initializing the system	

■ Using a short cut key

First menu	Second menu	Operation detail
"Dial XXX (name)"	-	Dialing a name registered in the phone book
"Phone book add Entry"	-	Adding a new phone number
"Phone book Change name"	-	Changing a registered name in the phone book
"Phone book Delete Entry"	-	Deleting the registered data
"Phone book List names"	-	Listing the registered data
"Phone book Set Speed Dial"	-	Setting speed dials
"Phone book Delete Speed Dial"	-	Deleting speed dials
"Dial XXX (number)"	-	Dialing by inputting a number
"Phonebook"	"Phonebook Unlock"	Unlocking the phone book
	"Phonebook Lock"	Locking the phone book

■ Automatic volume adjustment

When vehicle speed reaches 50 mph (80 km/h) or more, the volume automatically increases. The volume returns to the previous volume setting when vehicle speed drops to 43 mph (70 km/h) or less.

■ When using a voice command

For numbers, say a combination of single digits from zero to nine, # (pound), * (star), and + (plus).

Say the command correctly and clearly.

■ Situations that the system may not recognize your voice

- When driving on rough roads
- When driving at high speeds
- When air is blowing out of the vents onto the microphone
- When the air conditioning fan emits a loud noise

■ Operations that cannot be performed while driving

- Operating the system with 
- Registering a mobile phone to the system

■ Changing the passkey

→P. 380

Making a phone call

■ Making a phone call

- Dialing by inputting a number
“Dial by number”
- Dialing by inputting a name
“Dial by name”
- Speed dialing
- Dialing a number stored in the outgoing history memory
“Redial”
- Dialing a number stored in the incoming history memory
“Call back”

■ Receiving a phone call

- Answering the phone
- Refusing the call

■ Transferring a call

■ Call waiting

■ Using the call history memory

- Dialing
- Storing data in the phone book
- Deleting

Dialing by inputting a number

STEP 1 Press the talk switch and say “Dial by number”.

STEP 2 Press the talk switch and say the phone number.

STEP 3 Dial by one of the following methods:

- a. Press the off-hook switch.
- b. Press the talk switch and say “Dial”.

- c. Select “Dial” using .



Dialing by inputting a name

STEP 1 Press the talk switch and say “Dial by name”.

STEP 2 Select a registered name to be input by either of the following methods:

- a. Press the talk switch and say a registered name.
- b. Press the talk switch and say “List Names”. Press the talk switch when the desired name is read aloud.

STEP 3 Dial by one of the following methods:

- a. Press the off-hook switch.
- b. Press the talk switch and say “Dial”.

- c. Select “Dial” using .



Speed dialing

STEP 1 Press the off-hook switch.

STEP 2 Press the preset button in which the desired number is registered.

STEP 3 Press the off-hook switch.

When receiving a phone call

■ Answering the phone

Press the off-hook switch.

■ Refusing the call

Press the on-hook switch.

Transferring a call

A call can be transferred between the mobile phone and system while dialing, receiving a call, or during a call. Use one of the following methods:

- a. Operate the mobile phone.

Refer to the manual that comes with the mobile phone for the operation of the phone.

- b. Press the off-hook switch ^{*1}.
- c. Press the talk switch and say "Call Transfer"^{*2}.

^{*1}: This operation can be performed only when transferring a call from the mobile phone to the system during a call.

^{*2}: While the vehicle is in motion, calls cannot be transferred from the system to the mobile phone.

Call waiting

When a call is interrupted by an incoming call from a third party, the following options will become available:

- Answer the incoming call: Press the off-hook switch. (Press the off-hook switch again as necessary to switch back and forth between calls.)
- Refuse the incoming call: Press the on-hook switch.

Using the call history memory

Follow the procedure below to use a number stored in the call history memory:

STEP 1 Press the talk switch and say “Redial” (when using a number stored in the outgoing call history memory) or “Call back” (when using a number stored in the incoming call history memory).

STEP 2 Select the number by either of the following methods:

a. Say “Previous” or “Go back” until the desired number is displayed.

b. Select the desired number using .

STEP 3 The following operations can be performed:

Dialing: Press the off-hook switch or select “Dial” using a voice com-

mand or .

Storing the number in the phone book: Select “Store” and then

“Confirm” using a voice command or .

Deleting: Select “Delete” and then “Confirm” using a voice command

or .

■ Call waiting

- If your phone does not support HFP Ver. 1.5, this function cannot be used.
- Call waiting operation may differ depending on your mobile phone and service provider.

■ Call history

Up to 5 numbers can be stored in each of the outgoing and incoming call history memories.

■ When talking on the phone

- Do not talk simultaneously with the other party.
- Keep the volume of the received voice down. Otherwise, voice echo will increase.

Setting a mobile phone

Registering a mobile phone in the hands-free phone system allows the system to function. The following functions can be used for registered mobile phones:

■ Functions and operation procedures

To enter the menu for each function, follow the steps below using a

voice command or



- Registering a mobile phone
 1. "Setup" → 2. "Phone Setup" → 3. "Pair Phone"
- Selecting a mobile phone to be used
 1. "Setup" → 2. "Phone Setup" → 3. "Connect Phone (Connect)"
- Changing the registered name of a mobile phone
 1. "Setup" → 2. "Phone Setup" → 3. "Change Name"
- Listing the registered mobile phones
 1. "Setup" → 2. "Phone Setup" → 3. "List Phones"
- Changing the passkey
 1. "Setup" → 2. "Phone Setup" → 3. "Set Passkey"
- Deleting a registered mobile phone
 1. "Setup" → 2. "Phone Setup" → 3. "Delete Phone"

Registering a mobile phone

Select “Pair Phone” using a voice command or , and perform the procedure for registering a mobile phone. (→P. 367)

Selecting a mobile phone to be used

STEP 1 Select “Connect Phone (Connect)” using a voice command or



► Pattern A

STEP 2 Select the mobile phone to be used by either of the following methods, and select “Confirm” by using a voice command or



- Press the talk switch and say the name of the desired mobile phone.
- Press the talk switch and say “List Phones”. When the name of the desired mobile phone is read aloud, press the talk switch.

► Pattern B

STEP 2 Select the mobile phone to be used using



Changing the registered name of a mobile phone

STEP 1 Select “Change Name” using a voice command or  .

► Pattern A

STEP 2 Select the name of the mobile phone to be changed by either of the following methods, and select “Confirm” using a voice com-

mand or  :

- Press the talk switch and say the name of the desired mobile phone.
- Press the talk switch and say “List Phones”. When the name of the desired mobile phone is read aloud, press the talk switch.

► Pattern B

STEP 2 Select the desired mobile phone name to be changed using



STEP 3 Press the talk switch or select “Record Name” using  , and say the new name.

STEP 4 Select “Confirm” using a voice command or  .

Listing the registered mobile phones

Select “List Phones” using a voice command or . The list of registered mobile phones will be read aloud.

When listing is complete, the system returns to “Phone Setup”.

Pressing the talk switch while the name of a mobile phone is being read aloud selects the mobile phone, and the following functions will become available:

- Selecting a mobile phone: “Connect Phone (Connect)”
- Changing a registered name: “Change Name”
- Deleting a mobile phone: “Delete Phone”

Changing the passkey

STEP 1 Select “Set Passkey” using a voice command or .

▶ Pattern A

STEP 2 Press the talk switch, say a 4 to 8-digit number, and select “Con-

firm” using a voice command or .

▶ Pattern B

STEP 2 Select a 4 to 8-digit number using  .

The number should be input 1 digit at a time.

STEP 3 When the entire number to be registered as a passkey has been

input, press  again.

If the number to be registered has 8 digits, pressing of the knob is not necessary.

Deleting a registered mobile phone

STEP 1 Select "Delete Phone" using a voice command or  .

▶ Pattern A

STEP 2 Select the mobile phone to be deleted by either of the following

methods and select "Confirm" using a voice command or  :

- a. Press the talk switch and say the name of the desired mobile phone.
- b. Press the talk switch and say "List Phones". When the name of the desired mobile phone is read aloud, press the talk switch.

► Pattern B

STEP 2 Select the desired mobile phone to be deleted using  .



If the mobile phone to be deleted is paired as a Bluetooth[®] audio player, the registration of the audio player can be deleted at the same time. A voice guidance instruction to delete a Bluetooth[®] audio player is heard.

STEP 3 Select “Yes” or “No” using a voice command or  .



(Bluetooth[®] audio player →P. 341)

■ The number of mobile phones that can be registered

Up to 6 mobile phones can be registered in the system.

Security and system setup

■ Security setting items and operation procedures

To enter the menu for each function, follow the steps below using a

voice command or



- Setting or changing the PIN (Personal Identification Number)
 1. "Setup" → 2. "Security" → 3. "Set PIN"
- Locking the phone book
 1. "Setup" → 2. "Security" → 3. "Phonebook Lock (Phbk Lock)"
- Unlocking the phone book
 1. "Setup" → 2. "Security" → 3. "Phonebook Unlock (Phbk Unlock)"

■ System setup items and operation procedures

To enter the menu for each function, follow the steps below using



- Setting voice guidance volume
 1. "Setup" → 2. "System Setup" → 3. "Guidance Vol"
- Displaying the Bluetooth[®] device address and name
 1. "Setup" → 2. "System Setup" → 3. "Device Name"
- Initializing the system
 1. "Setup" → 2. "System Setup" → 3. "Initialize"

Setting or changing the PIN

■ Setting a PIN

STEP 1 Select “Set PIN” using a voice command or



STEP 2 Enter a PIN using a voice command or



When using , input the code 1 digit at a time.

■ Changing the PIN

STEP 1 Select “Set PIN” using a voice command or



STEP 2 Enter the registered PIN using a voice command or



STEP 3 Enter a new PIN using a voice command or



When using , input the code 1 digit at a time.

Locking or unlocking the phone book

STEP 1 Select “Phonebook Lock (Phbk Lock)” or “Phonebook Unlock (Phbk Unlock)” using a voice command or



STEP 2 Input the PIN by either of the following methods and select “Con-

firm” using a voice command or  :

a. Press the talk switch and say the registered PIN.

b. Input a new PIN using  .

Setting voice guidance volume

STEP 1 Select “Guidance Vol” using  .

STEP 2 Change the voice guidance volume.

To decrease the volume: Turn  counterclockwise.

To increase the volume: Turn  clockwise.

Displaying the Bluetooth® device address and name

STEP 1 Select “Device Name” using  .

STEP 2 Turn  to display the Bluetooth® device address and name.

STEP 3 Select “Go Back” using  to return to “System Setup”.

Initializing the system

STEP 1 Select “Initialize” and then “Confirm” using



STEP 2 Select “Confirm” again using



■ Initialization

- The following data in the system can be initialized:
 - Phone book
 - Outgoing and incoming call history
 - Speed dials
 - Registered mobile phone data
 - Security code
 - Registered Bluetooth[®] enabled portable player data
 - Passkey for the mobile phones
 - Passkey for the Bluetooth[®] audio players
 - Guidance volume
 - Receiver volume
 - Ring tone volume
- Once the initialization has been completed, the data cannot be restored to its original state.

■ When the phone book is locked

The following functions cannot be used:

- Dialing by inputting a name
- Speed dialing
- Dialing a number stored in the call history memory
- Using the phone book

Using the phone book

To enter the menu for each function, follow the steps below using a

voice command or  :

- Adding a new phone number
 1. "Phonebook" → 2. "Add Entry"
- Changing the registered name in the phone book
 1. "Phonebook" → 2. "Change Name"
- Listing the registered data
 1. "Phonebook" → 2. "List Names"
- Setting speed dials
 1. "Phonebook" → 2. "Set Speed Dial (Speed Dial)"
- Deleting the registered data
 1. "Phonebook" → 2. "Delete Entry"
- Deleting speed dials
 1. "Phonebook" → 2. "Delete Speed Dial (Del Spd Dial)"

Adding a new phone number

The following methods can be used to add a new phone number:

- Inputting a phone number using a voice command
- Transferring data from the mobile phone
- Inputting a phone number using 
- Selecting a phone number from outgoing or incoming call history

■ Adding procedure

STEP 1 Select “Add Entry” using a voice command or .

STEP 2 Use one of the following methods to input a telephone number:
Inputting a telephone number using a voice command:

STEP2-1 Select “By Voice” using a voice command or .

STEP2-2 Press the talk switch, say the desired number, and select “Confirm” using a voice command.

Transferring data from the mobile phone:

STEP2-1 Select “By Phone” and then “Confirm” using a voice command or .

STEP2-2 Transfer the data from the mobile phone.

Refer to the manual that comes with the mobile phone for the details of transferring data.



STEP2-3 Select the data to be registered by either of the following methods:

a. Say “Previous” or “Next” until the desired data is displayed, and select “Confirm” using a voice command.

b. Select the desired data using .

Inputting a phone number using  :

STEP2-1 Select “Manual Input” using  .

STEP2-2 Input a phone number using  , and press  again.

Input the phone number 1 digit at a time.

Selecting a phone number from outgoing or incoming call history:

STEP2-1 Select “Call History” using a voice command or  .

STEP2-2 Select “Outgoing” or “Incoming” using a voice command or  .

STEP2-3 Select the data to be registered by either of the following methods:

- a. Say “Previous” or “Go back” until the desired data is displayed, and select “Confirm” using a voice command.
- b. Select the desired data using  .

STEP 3 Select the name to be registered by either of the following meth-

ods, and select “Confirm” using a voice command or  :

a. Press the talk switch and say the desired name.

b. Select “Record Name” using  , and say the desired name.

STEP 4 Select “Confirm” using a voice command or  .

In **STEP 4** , selecting “Set Speed Dial (Speed Dial)” instead of “Confirm” registers the newly added phone number as a speed dial.

Changing the registered name in the phone book

STEP 1 Select “Change Name” using a voice command or  .

► Pattern A

STEP 2 Select the name to be changed by either of the following meth-

ods, and select “Confirm” using a voice command or  :

a. Press the talk switch, say the desired name.

b. Press the talk switch, and say “List Names”. When the desired name is read aloud, press the talk switch.

► Pattern B

STEP 2 Select the desired name to be changed using  .

STEP 3 Press the talk switch or select “Record Name” using , and say the new name.

STEP 4 Select “Confirm” using a voice command or .

Listing the registered data

Select “List Names” using a voice command or . The list of the registered data will be read aloud.

When listing is complete, the system returns to the “Phonebook”.

Pressing the talk switch while the desired data is being read aloud selects the data, and the following function will become available:

- Dialing: “Dial”
- Changing a registered name: “Change Name”
- Deleting an entry: “Delete Entry”
- Setting a speed dial: “Set Speed Dial (Speed Dial)”

Setting speed dials

STEP 1 Select “Set Speed Dial (Speed Dial)” using a voice command or



► Pattern A

STEP 2 Select the data to be registered as a speed dial by either of the following methods, and select “Confirm” using a voice command



- Press the talk switch, say the desired name.
- Press the talk switch, and say “List Names”. When the desired name is read aloud, press the talk switch.

► Pattern B

STEP 2 Select the desired data using



STEP 3 Select the desired preset button, and register the data into speed dial by either of the following methods:

- Press the desired preset button, and select “Confirm” by using

a voice command or



- Press and hold the desired preset button.

Deleting the registered data

STEP 1 Select “Delete Entry” using a voice command or



► Pattern A

STEP 2 Select the data to be deleted by either of the following methods,

and select “Confirm” using a voice command or



a. Press the talk switch, and say the name of the desired phone number.

b. Press the talk switch, say “List Names”. When the name of the desired phone number is read aloud, press the talk switch.

► Pattern B

STEP 2 Select the desired data to be deleted using



Deleting speed dials

STEP 1 Select “Delete Speed Dial (Del Spd Dial)” using a voice com-

mand or



STEP 2 Press the preset button to which the desired speed dial is regis-

tered, and select “Confirm” using a voice command or



■ Limitation of number of digits

A phone number that exceeds 24 digits cannot be registered.

3-5. Using the interior lights

Interior lights list

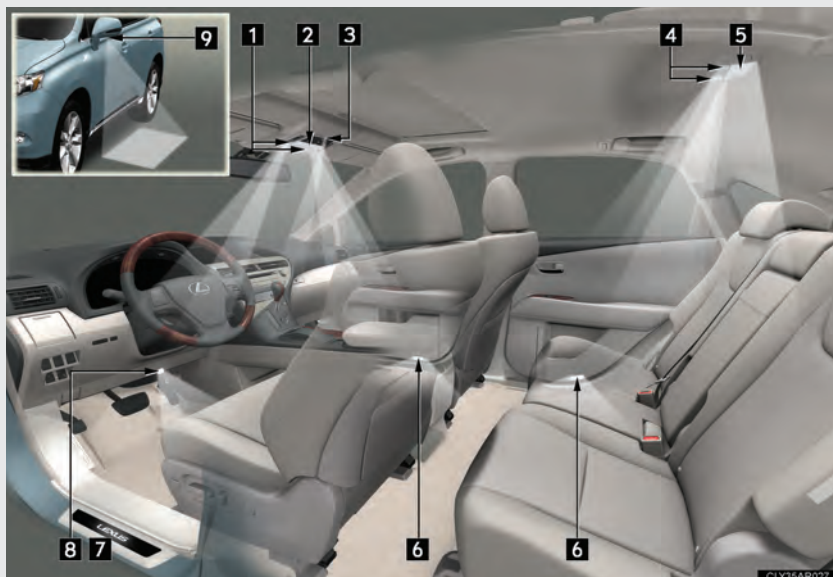

- 1 Front personal lights (→P. 395)
- 2 Front interior lights (→P. 395)
- 3 Shift lever light (when the "ENGINE START STOP" switch is in ACCESSORY or IGNITION ON mode)
- 4 Rear personal lights (→ P. 395)
- 5 Rear interior light
- 6 Door courtesy lights
- 7 Scuff lights (if equipped)
- 8 Footwell lights
- 9 Outer foot lights

Interior lights

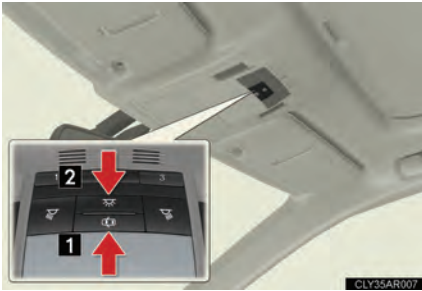

- 1 Turns the lights on/off linked to the door positions
- 2 Turns the lights on/off

Personal lights

► Front



Turns the light on/off

► Rear

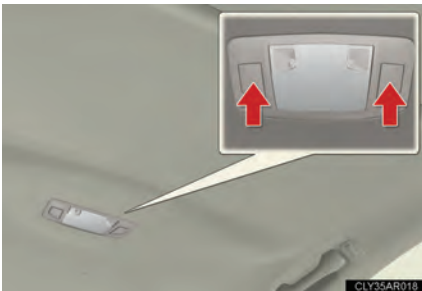

Turns the light on/off

■ Illuminated entry system

The lights automatically turn on/off according to “ENGINE START STOP” switch mode, the presence of the electronic key, whether the doors are locked/unlocked, and whether the doors are open/closed.

■ To prevent battery discharge

If the interior lights remain on when the door is not fully closed and the interior light switch (door position on/ off) is on, the lights will go off automatically after 20 minutes.

■ Customization

Settings (e.g. the time elapsed before the lights turn off) can be changed. (Customizable features →P. 610)

3-6. Using the storage features

List of storage features

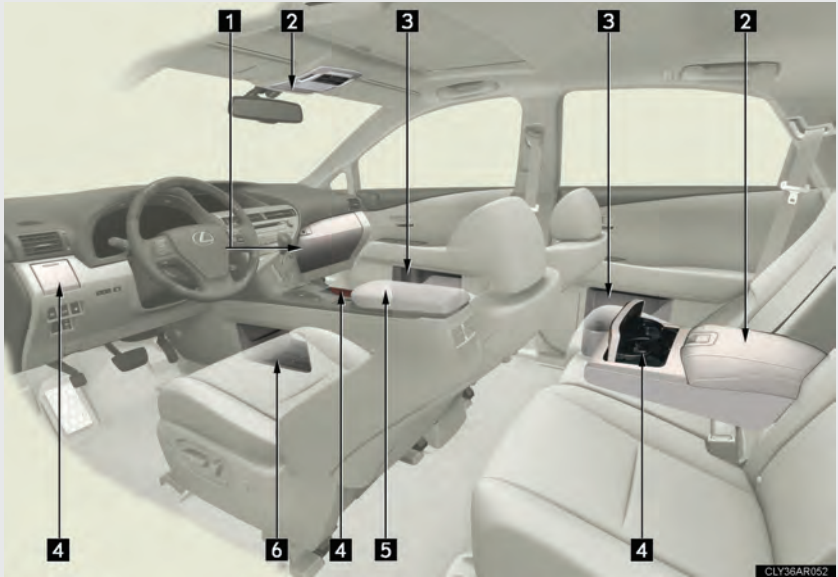

- 1 Glove box
- 2 Auxiliary boxes (if equipped)
- 3 Bottle holders/door pockets
- 4 Cup holders
- 5 Console box
- 6 Under tray

Glove box

The glove box can be opened by pressing the lock release button and locked and unlocked using the mechanical key.

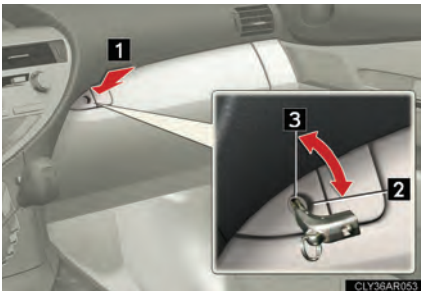

- 1 Opens
- 2 Locks
- 3 Unlocks

■ Power back door main switch (if equipped)

The power back door main switch is located in the glove box. (→P. 49)

⚠ CAUTION

■ Caution while driving

Keep the glove box closed.

Injuries may result in the event of an accident or sudden braking.

Bottle holders/door pockets

► Front



The front door pockets can be opened and closed.

► Rear



⚠ CAUTION

■ Caution while driving (front door pockets)

Keep the door pockets closed.

Injuries may result in the event of an accident or sudden braking.

■ Items unsuitable for the bottle holders

Do not place anything other than bottle in the bottle holders.

Other items may be thrown out of the holders in the event of an accident or sudden braking and cause injury.

 NOTICE

■ **When stowing a bottle**

Put the cap on before stowing the bottle. Do not place open bottles in the bottle holders. The contents may spill.

Cup holders

▶ Front (type A)



Press down and release the right side of the cup holder lid.

▶ Front (type B)



Press in and release the cup holder.

► Rear

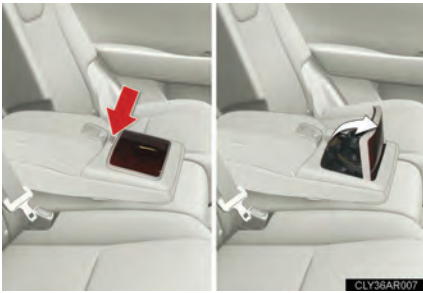

Press down the button on the armrest.

■ Cup holder insert



Cup holder insert may be removed for cleaning.

 **CAUTION**
■ Items unsuitable for the cup holder

Do not place anything other than cups or beverage cans in the cup holders. Even when the lid is closed, items must not be stored in the cup holders. Other items may be thrown out of the holders in the event of an accident or sudden braking and cause injury.

■ To prevent burns

Put a lid on containers with hot liquids inside.

■ When not in use

Keep the cup holders closed. Injuries may result in the event of an accident or sudden braking.

Console box



Slide the armrest while pulling up the lever, and lift the armrest.

Trays in the console box

► Upper tray

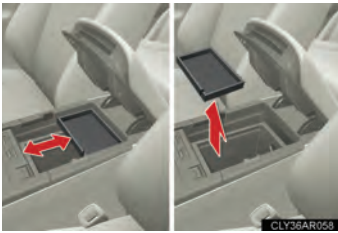

The tray slides forward/backward and can be removed.

► Lower tray



The tray can be removed.

 **CAUTION****■ Caution while driving**

Keep the console box closed.

Injuries may result in the event of an accident or sudden braking.

 **NOTICE****■ Tray**

Do not insert items exceeding the height of the tray. Doing so may prevent opening and closing of the lid.

Auxiliary boxes

► Overhead

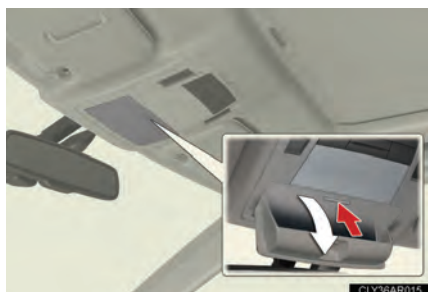

Press in the lid.

This box is useful for temporarily storing sunglasses and similar small items.

► Rear seat (if equipped)

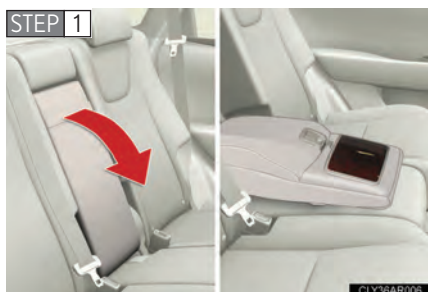

Pull down the armrest.

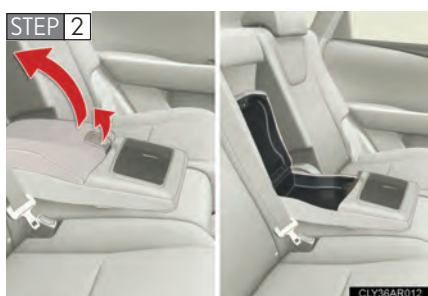

Pull up the lever to release the lock and lift the armrest.

⚠ CAUTION**■ Items that should not be left in the auxiliary box (overhead type)**

Do not leave glasses or lighters in the box.

If the interior of the vehicle becomes hot, lighters may explode and glasses may warp or crack.

■ Caution while driving

Do not leave the auxiliary box open while driving.

Items may fall out and cause death or serious injury in case of an accident or sudden stop.

Under tray**⚠ CAUTION****■ Items unsuitable for the under tray**

Observe the following precautions when putting items in the under tray. Failure to do so may cause items to be thrown out of the tray in the event of sudden braking or steering. In these cases, the items may interfere with pedal operation or cause driver distraction, resulting in an accident.

- Do not store items in the tray that can easily shift or roll out.
- Do not stack items in the tray higher than the tray's edge.
- Do not put items in the tray that may protrude over the tray's edge.

Sun visors

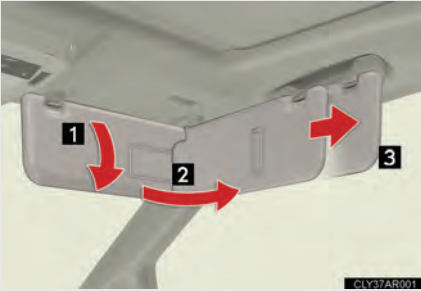

- 1 To set the visor in the forward position, flip down.
- 2 To set the visor in the side position, flip down it, unhook, and swing to the side.
- 3 To use the side extender, place the visor in the side position, then slide backward.

3-7. Other interior features

Vanity mirrors



Slide the cover to open.

The light turns on when the cover is opened.

NOTICE

To prevent battery discharge

Do not leave the vanity lights on for extended periods while the engine is stopped.

3-7. Other interior features

Clock

The clock is displayed when the “ENGINE START STOP” switch is in ACCESSORY or IGNITION ON mode. Perform the following steps to adjust the clock.

- ▶ Without navigation system



- 1 Adjusts the hours
- 2 Adjusts the minutes

- ▶ With navigation system

Refer to “Navigation System Owner’s Manual”.

■ When the battery is disconnected

The time display will automatically be set to 1:00.

3-7. Other interior features

Outside temperature display (vehicles without a navigation system)

The temperature display shows within the range of -40°F (-40°C) and 122°F (50°C).



■ If the temperature does not appear

The system may be malfunctioning. Take your vehicle to your Lexus dealer.

■ Display

In the following situations, the correct outside temperature may not be displayed, or the display may take longer than normal to change:

- When the vehicle is stopped, or moving at low speeds (less than 16 mph [25 km/h])
- When the outside temperature has changed suddenly (at the entrance/exit of a garage, tunnel, etc.)

3-7. Other interior features

Multi-display light control (vehicles without a navigation system)

The brightness of the multi-display can be adjusted to four levels.



Press and release the “DISP” button until the brightness of the display is adjusted to the desired level.

■ Instrument panel linked brightness control

When the headlight switch is turned on, the brightness of the multi-display will be reduced in accordance with the brightness of the instrument panel. (→P. 159)

3-7. Other interior features

Power outlets

The power outlets can be used for a following component:

12 V: Accessories that run on less than 10 A.

120 VAC: Accessories that use less than 100 W.

► Inside the console (12 V)

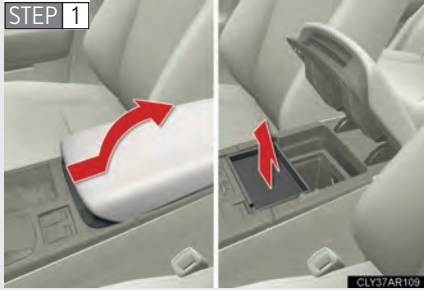

Slide the armrest while pulling up the lever, and lift the armrest. Remove the upper tray.

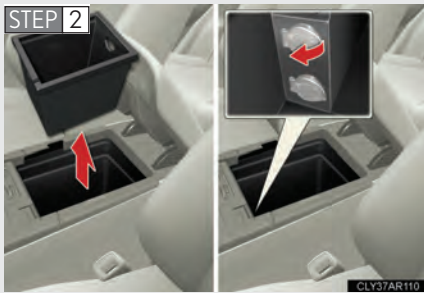

Remove the lower tray.

► Luggage compartment (12 V)



► On the back surface of the console (120 VAC*)

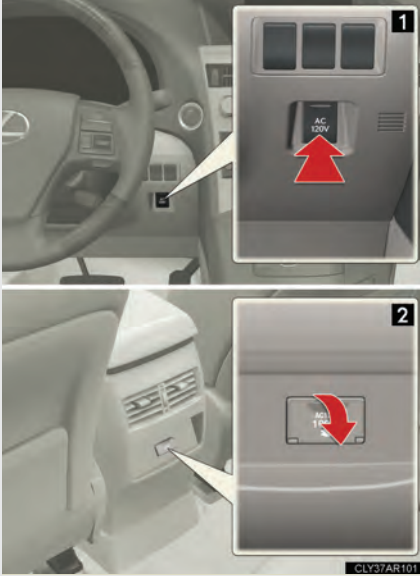

1 Main switch

To use the power outlet, turn on the main switch.

2 Power outlet socket

*: If equipped

■ Routing accessory device cables



When the cover is slide open, accessory device cables can be pulled through the opening.

■ The power outlets can be used when

12 V

The "ENGINE START STOP" switch is in ACCESSORY or IGNITION ON mode.

120 VAC

The "ENGINE START STOP" switch is in IGNITION ON mode.

 NOTICE**■ To avoid damaging the power outlets**

Close the power outlet lid when the power outlet is not in use.

Foreign objects or liquids that enter the power outlet may cause a short circuit.

■ To prevent the fuse from being blown

12 V: Do not use an accessory that uses more than 12 V 10 A.

120 VAC: Do not use a 120 VAC appliance that requires more than 100 W.

If a 120 VAC appliance that consumes more than 100 W is used, the protection circuit will cut the power supply.

■ To prevent battery discharge

Do not use the power outlets longer than necessary when the engine is not running.

■ Appliances that may not operate properly (120 VAC)

The following 120 VAC appliances may not operate properly even if their power consumption is under 100 W:

- Appliances with high initial peak wattage
- Measuring devices that process precise data
- Other appliances that require an extremely stable power supply

Seat heaters and ventilators*

The seat heaters and ventilators heat the seats and maintain good airflow by blowing air from the seats.

■ Seat heaters

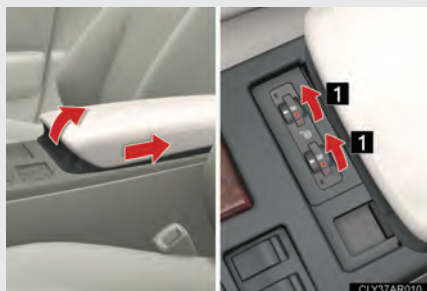

- 1 Turns the seat heater on

The indicator light comes on. The higher the number is, the warmer the seat becomes.

■ Seat heaters/ventilators

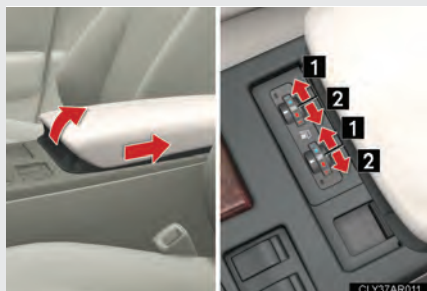

- 1 Turns the seat heater on

The indicator light comes on. The higher the number is, the warmer the seat becomes.

- 2 Blows air from the seat

The indicator light comes on. The higher the number is, the stronger the airflow becomes.

■ Operating condition

The "ENGINE START STOP" switch is in IGNITION ON mode.

■ When not in use

Set the knob at "0". The indicator light turns off.

*: If equipped

 **CAUTION****Burns**

- Use caution when seating the following persons in a seat with the seat heater on to avoid the possibility of burns:
 - Babies, small children, the elderly, the sick and the physically challenged
 - Persons with sensitive skin
 - Persons who are fatigued
 - Persons who have taken alcohol or drugs that induce sleep (sleeping drugs, cold remedies, etc.)
- Do not cover the seat with anything when using the seat heater.
Using the seat heater with a blanket or cushion increases the temperature of the seat and may lead to overheating.

 **NOTICE****To prevent damage to the seat heaters/ventilators**

Do not put heavy objects that have an uneven surface on the seat and do not stick sharp objects (needles, nails, etc.) into the seat.

To prevent battery discharge

Do not leave the system on longer than necessary when the engine is off.

3-7. Other interior features

Armrest

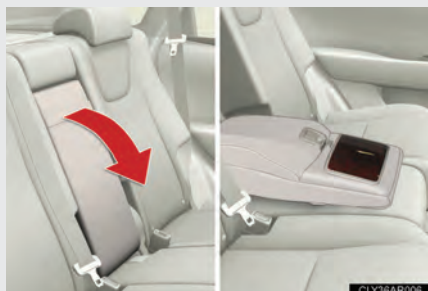

Pull the armrest down for use.

NOTICE

■ **To prevent damage to the armrest**

Do not place too much strain on the armrest.

Coat hooks

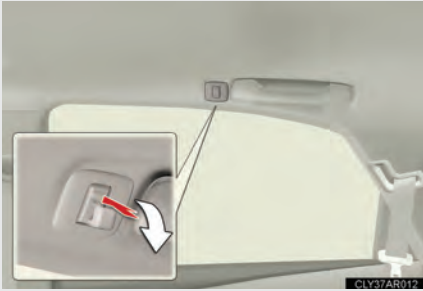

To use the coat hook, push it in.

CAUTION

Items that must not be hung on the hook

Do not hang a coat hanger or other hard or sharp object on the hook. If the SRS curtain shield airbags deploy, these items may become projectiles that cause death or serious injury.

3-7. Other interior features

Floor mat

Securely place a mat that matches the size of the space on the carpet.

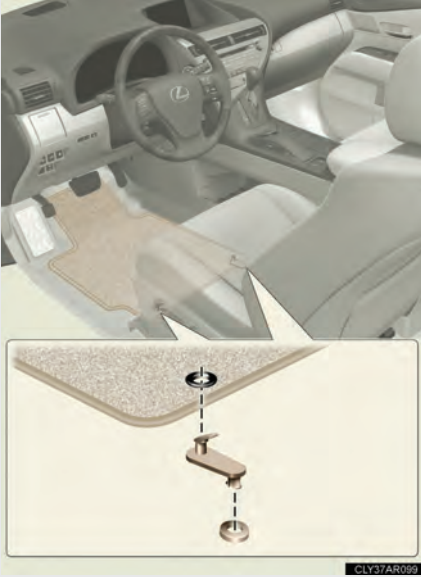

Secure the floor mat using the hooks provided.

CAUTION

■ When inserting the floor mat

Observe the following precautions.

Failure to do so may result in the floor mat slipping and interfering with the movement of the pedals during driving, resulting in an accident.

- Make sure the floor mat is properly placed on the vehicle carpet and the correct side faces upward.
- Do not place floor mats on top of existing mats.

3-7. Other interior features

Luggage compartment features

■ Cargo hooks



Raise the hook to use.

The cargo hooks are provided for securing loose items.

■ Auxiliary boxes

▶ Type A



Pull the lever upwards when lifting the deck board up.

► Type B



Pull the strap upwards when lifting the cover up.

■ Luggage covers

STEP 1

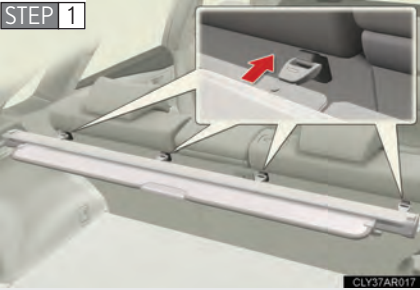

Attach the hooks to the hook brackets on the rear seat seatback.

STEP 2

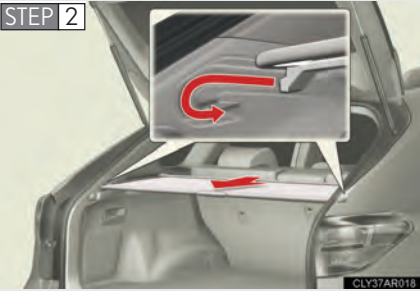

Pull out the luggage cover and hook it onto the anchors.

Removing the luggage covers

► Front luggage cover

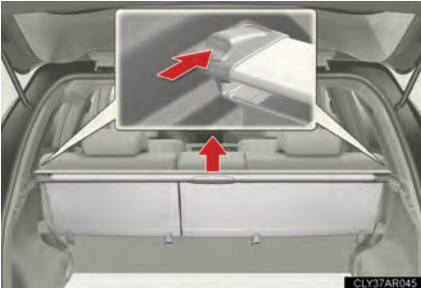

Press the buttons to remove the luggage cover.

► Rear luggage cover



Detach the outer clips of the rear luggage cover from the back door.

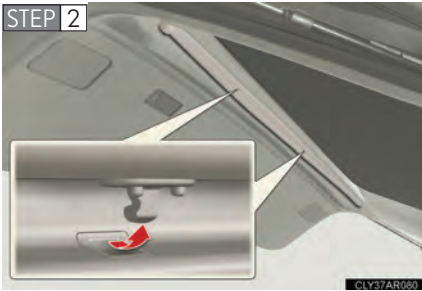

Detach the inner clips of the rear luggage cover from the back door.

■ Installing the rear luggage cover

- Ensure that the luggage cover is in the proper installation position.
Push the clips of the rear luggage cover into the indentions on the back door until they are locked into place.
- Check that the rear luggage cover is securely attached.

⚠ CAUTION

■ When the cargo hooks are not in use

To avoid injury, always return the cargo hooks to their stowed positions.

3-7. Other interior features

Garage door opener

The garage door opener can be programmed to operate garage doors, gates, entry doors, door locks, home lighting systems, security systems, and other devices.

The garage door opener (HomeLink[®] Universal Transceiver) is manufactured under license from HomeLink[®].

Programming the HomeLink[®] (for U.S.A. owners)

The HomeLink[®] compatible transceiver in your vehicle has 3 buttons which can be programmed to operate 3 different devices. Refer to the programming method below appropriate for the device.

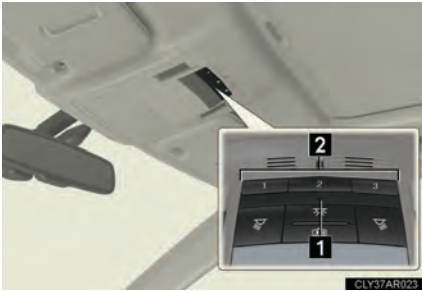

- 1 Indicator
- 2 Buttons

■ Programming the HomeLink[®]

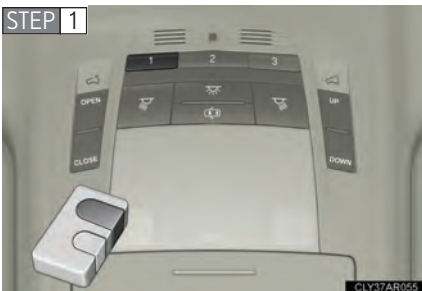

Point the remote control transmitter for the device 1 to 3 in. (25 to 75 mm) from the HomeLink[®] control buttons.

Keep the HomeLink[®] indicator light in view while programming.

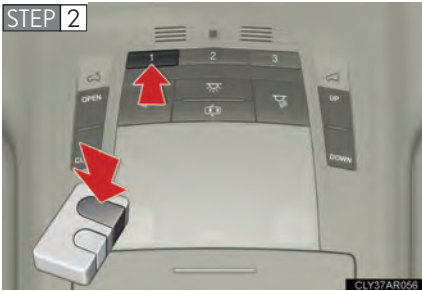

Press and hold one of the HomeLink[®] buttons and the transmitter button. When the HomeLink[®] indicator light changes from a slow to a rapid flash, you can release both buttons.

If the HomeLink[®] indicator light comes on but does not flash, or flashes rapidly for 2 seconds and remains lit, the HomeLink[®] button is already programmed. Use the other buttons or follow the "Reprogramming a HomeLink[®] button" instructions. (→P. 427)

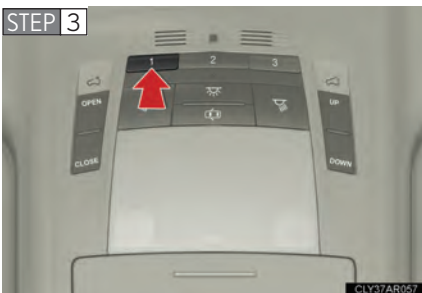

Test the HomeLink[®] operation by pressing the newly programmed button.

If a HomeLink[®] button has been programmed for a garage door, check to see if the garage door opens and closes. If the garage door does not operate, see if your remote control transmitter is of the rolling code type. Press and hold the programmed HomeLink[®] button. The remote control transmitter is of the rolling code type if the HomeLink[®] indicator light flashes rapidly for 2 seconds and then remains lit. If your transmitter is of the rolling code type, proceed to the heading "Programming a rolling code system".

STEP 4 Repeat the steps above to program another device for each of the remaining HomeLink[®] buttons.

■ Programming a Rolling Code system (for U.S.A. owners)

If your device is Rolling Code equipped, follow the steps under the heading “Programming the HomeLink[®]” before proceeding with the steps listed below.

STEP 1 Locate the training button on the ceiling mounted garage door opener motor. The exact location and color of the button may vary by brand of garage door opener motor.

Refer to the operation manual supplied with the garage door opener for the location of the training button.

STEP 2 Press the training button.

Following this step, you have 30 seconds in which to initiate step 3 below.

STEP 3 Press and hold the vehicle’s programmed HomeLink[®] button for 2 seconds and release it. Repeat this step once again. The garage door may open.

If the garage door opens, the programming process is complete. If the door does not open, press and release the button a third time. This third press and release will complete the programming process by opening the garage door.

The ceiling mounted garage door opener motor should now recognize the HomeLink[®] signal and operate the garage door.

STEP 4 Repeat the steps above to program another rolling code system for any of the remaining HomeLink[®] buttons.

■ Programming an entry gate (for U.S.A. owners)/Programming all devices in the Canadian market

STEP 1 Place your transmitter 1 to 3 in. (25 to 75 mm) away from the surface of the HomeLink[®].

Keep the HomeLink[®] indicator light in view while programming.

STEP 2 Press and hold the selected HomeLink[®] button.

STEP 3 Repeatedly press and release (cycle) the device’s remote control button for two seconds each until step 4 is completed.

STEP 4 When the indicator light on the HomeLink[®] compatible transceiver starts to flash rapidly, release the buttons.

STEP 5 Test the operation of the HomeLink[®] by pressing the newly programmed button. Check to see if the gate/device operates correctly.

STEP 6 Repeat the steps above to program another device for each of the remaining HomeLink[®] buttons.

■ Programming other devices

To program other devices such as home security systems, home door locks or lighting, contact your authorized Lexus dealer for assistance.

■ Reprogramming a button

The individual HomeLink[®] buttons cannot be erased but can be reprogrammed. To reprogram a button, follow the “Reprogramming a HomeLink[®] button” instructions.

Operating HomeLink[®]

Press the appropriate HomeLink[®] button. The HomeLink[®] indicator light should turn on.

The HomeLink[®] compatible transceiver in your vehicle continues to send a signal for up to 20 seconds as long as the button is pressed.

Reprogramming a HomeLink[®] button

Press and hold the desired HomeLink[®] button. After 20 seconds, the HomeLink[®] indicator light will start flashing slowly. Next, while still pressing and holding the HomeLink[®] button, press and hold the button on the transmitter until the HomeLink[®] indicator light changes from a slow to a rapid flash.

Erasing the entire HomeLink® memory (all three programs)



Press and hold the 2 outside buttons for 10 seconds until the indicator light flashes.

If you sell your vehicle, be sure to erase the programs stored in the HomeLink® memory.

■ Before programming

- Install a new battery in the remote control transmitter.
- The battery side of the remote control transmitter must be pointed away from the HomeLink® button.

■ Certification for the garage door opener

This device complies with Part 15 of the FCC Rules and with RSS-210 of the IC Rules.

Operation is subject to the following two conditions: (1) This device may not cause harmful interference, and (2) this device must accept any interference received, including interference that may cause undesired operation.

WARNING: This transmitter has been tested and complies with FCC and IC rules. Changes or modifications not expressly approved by the party responsible for compliance could void the user's authority to operate the device.

 **CAUTION****■ When programming a garage door or other remote control device**

The garage door or other device may operate, so ensure people and objects are out of danger to prevent potential harm.

■ Conforming to federal safety standards

Do not use the HomeLink[®] compatible transceiver with any garage door opener or device that lacks safety stop and reverse features as required by federal safety standards.

This includes any garage door that cannot detect an obstruction object. A door or device without these features increases the risk of death or serious injury.

3-7. Other interior features

Compass

The compass on the inside rear view mirror indicates the direction in which the vehicle is heading.

■ Operation

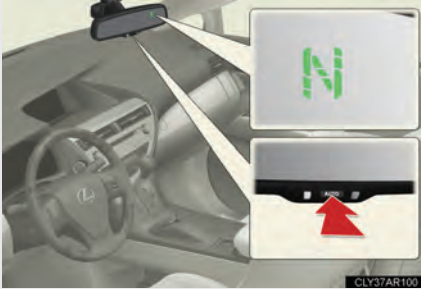

To turn the compass on or off, press “AUTO” for more than 3 seconds.

■ Displays and directions

Display	Direction
“N”	North
“NE”	Northeast
“E”	East
“SE”	Southeast
“S”	South
“SW”	Southwest
“W”	West
“NW”	Northwest

Calibrating the compass

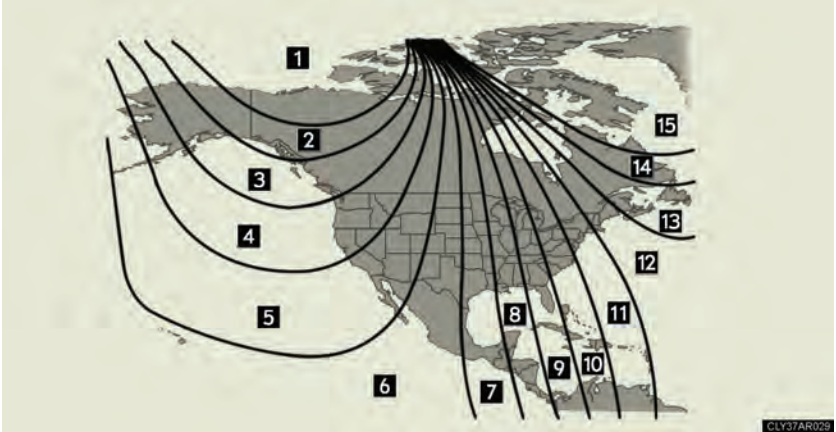

The direction display deviates from the true direction determined by the earth's magnetic field. The amount of deviation varies depending on the geographic position of the vehicle.

If you cross over one of the map boundaries shown in illustration, the compass will deviate.

To obtain higher precision or perfect calibration, refer to "Deviation calibration".

■ Deviation calibration

STEP 1 Stop the vehicle in a place where it is safe to drive in a circle.

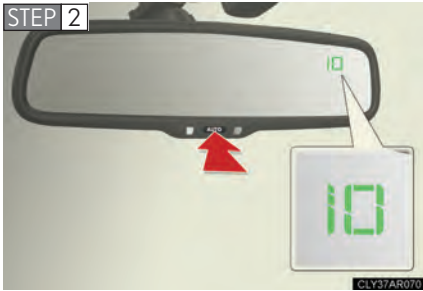

Press and hold "AUTO".

A number (1 to 15) appears on the compass display.

STEP 3 Referring to the map above, press "AUTO" to select the number of the zone where you are in.

If the direction is displayed for several seconds after adjustment, the calibration is complete.

■ Circling calibration



If "C" appears on the display, drive the vehicle at 5 mph (8 km/h) or less in a circle until a direction is displayed.

If there is not enough space to drive in a circle, drive around the block until a direction is displayed.

■ Conditions unfavorable to correct operation

The compass may not show the correct direction in the following conditions:

- The vehicle is stopped immediately after turning.
- The vehicle is on an inclined surface.
- The vehicle is in a place where the earth's magnetic field is subject to interference by artificial magnetic fields (underground car park/parking lot, under a steel tower, between buildings, roof car park/parking lot, near an intersection, near a large vehicle, etc.).
- The vehicle has become magnetized. (There is a magnet or metal object near the inside rear view mirror.)
- The battery has been disconnected.
- A door is open.

CAUTION

■ While driving the vehicle

Do not adjust the display. Adjust the display only when the vehicle is stopped.

■ When doing the circling calibration

Secure a wide space, and watch out for people and vehicles in the vicinity. Do not violate any local traffic rules while performing circling calibration.

NOTICE

■ To avoid compass malfunctions

Do not place magnets or any metal objects near the inside rear view mirror. Doing this may cause the compass sensor malfunction.

■ To ensure normal operation of the compass

- Do not perform a circling calibration of the compass in a place where the earth's magnetic field is subject to interference by artificial magnetic fields.
- During calibration, do not operate electric systems (moon roof, power windows, etc.) as they may interfere with the calibration.

4-1. Maintenance and care

- Cleaning and protecting the vehicle exterior..... 436
- Cleaning and protecting the vehicle interior 439

4-2. Maintenance

- Maintenance requirements 442
- General maintenance 444
- Emission inspection and maintenance (I/M) programs..... 448

4-3. Do-it-yourself maintenance

- Do-it-yourself service precautions..... 449
- Hood..... 452
- Positioning a floor jack 453
- Engine compartment 455
- Tires..... 471
- Tire inflation pressure..... 480
- Wheels..... 483
- Air conditioning filter 485
- Electronic key battery..... 488
- Checking and replacing fuses 490
- Headlight aim (discharge headlights)..... 501
- Light bulbs..... 503

Cleaning and protecting the vehicle exterior

Perform the following to protect the vehicle and maintain it in prime condition:

- Working from top to bottom, liberally apply water to the vehicle body, wheel wells and underside of the vehicle to remove any dirt and dust.
- Wash the vehicle body using a sponge or soft cloth, such as a chamois.
- For hard-to-remove marks, use car wash soap and rinse thoroughly with water.
- Wipe away any water.
- Wax the vehicle when the waterproof coating deteriorates.

If water does not bead on a clean surface, apply wax when the vehicle body is cool.

■ Automatic car washes

- Before washing the vehicle:
 - Fold the mirrors.
 - Turn off the power back door system (if equipped).
- Brushes used in automatic car washes may scratch the vehicle surface and harm your vehicle's paint.

■ High pressure car washes

- Do not allow the nozzles of the car wash to come within close proximity of the windows and the air suspension unit (if equipped).
- Before using the car wash, check that the fuel filler door on your vehicle is closed properly.

■ Aluminum wheels

Remove any dirt immediately by using a neutral detergent. Do not use hard brushes or abrasive cleaners. Do not use strong or harsh chemical cleaners. Use the same mild detergent and wax as used on the paint.

■ Bumpers

Do not scrub with abrasive cleaners.

■ To prevent deterioration and body corrosion

- Wash the vehicle immediately in the following cases:
 - After driving near the sea coast
 - After driving on salted roads
 - If you see coal tar or tree sap on the paint surface
 - If dead insects, insect droppings or bird droppings are present on the paint surface
 - After driving in an area contaminated with soot, oily smoke, mine dust, iron powder or chemical substances
 - If the vehicle becomes heavily soiled in dust or mud
 - If liquids such as benzene and gasoline are spilled on the paint surface
- If the paint is chipped or scratched, have it repaired immediately.

CAUTION

■ Precautions regarding the exhaust pipe

Exhaust gases cause the exhaust pipe to become quite hot.

When washing the vehicle, be careful not to touch the pipe until it has cooled sufficiently, as touching a hot exhaust pipe can cause burns.

 NOTICE

■ **To protect your vehicle's painted surfaces**

Do not use organic cleaners such as benzene or gasoline.

■ **Cleaning the exterior lights**

- Wash carefully. Do not use organic substances or scrub with a hard brush. This may damage the surfaces of the lights.
- Do not apply wax to the surfaces of the lights. Wax may cause damage to the lenses.

■ **To prevent damage to the windshield wiper arms**

When lifting the wiper arms away from the windshield, pull the driver side wiper arm upward first, and repeat for the passenger side. When returning the wipers to their original position, do so from the passenger side first.

■ **When using an automatic car wash (vehicles with rain-sensing windshield wipers)**



Set the wiper switch to the off position. If the wiper switch is in "AUTO", the wipers may operate and the wiper blades may be damaged.

Cleaning and protecting the vehicle interior

The following procedures will help protect your vehicle's interior and keep it in top condition:

■ Protecting the vehicle interior

Remove dirt and dust using a vacuum cleaner. Wipe dirty surfaces with a cloth dampened with lukewarm water.

■ Cleaning the leather areas

- Remove dirt and dust using a vacuum cleaner.
- Wipe any excess dirt and dust with a soft cloth dampened with diluted detergent.

Use a diluted water solution of approximately 5% neutral wool detergent.

- Wring out any excess water from the cloth and thoroughly wipe off all remaining traces of detergent.
- Wipe the surface with a dry, soft cloth to remove any remaining moisture. Allow the leather to dry in a shaded and ventilated area.

■ Cleaning the synthetic leather areas

- Remove loose dirt using a vacuum cleaner.
- Apply a mild soap solution to the synthetic leather using a sponge or soft cloth.
- Allow the solution to soak in for a few minutes. Remove the dirt and wipe off the solution with a clean, damp cloth.

■ Caring for leather areas

Lexus recommends cleaning the interior of the vehicle at least twice a year to maintain the quality of the vehicle's interior.

■ Shampooing the carpets

There are several commercial foaming-type cleaners available. Use a sponge or brush to apply the foam. Rub in overlapping circles. Do not apply water. Excellent results are obtained by keeping the carpet as dry as possible.

■ Seat belts

Clean with mild soap and lukewarm water using a cloth or sponge. Also check the belts periodically for excessive wear, fraying or cuts.

CAUTION

■ Water in the vehicle

- Do not splash or spill liquid in the vehicle.

Doing so may cause electrical components etc. to malfunction or catch fire.

- Do not get any of the SRS components or wiring in the vehicle interior wet. (→P.105)

An electrical malfunction may cause the airbags to deploy or not function properly, resulting in death or severe injury.

 NOTICE**■ Cleaning detergents**

Do not use the following types of detergent, as they may discolor the vehicle interior or cause streaks or damage to painted surfaces:

- Non-seat portions: Organic substances such as benzene or gasoline, alkaline or acidic solutions, dye, or bleach
- Seats: Acidic solutions, such as thinner, benzene, or alcohol

■ Preventing damage to leather surfaces

Observe the following precautions to avoid damage to and deterioration of leather surfaces:

- Remove any dust or dirt from leather surfaces immediately.
- Do not expose the vehicle to direct sunlight for extended periods of time. Park the vehicle in the shade, especially during summer.
- Do not place items made of vinyl, plastic, or that contain wax on the upholstery, as they may stick to the leather surface if the vehicle interior heats up significantly.

■ Water on the floor

Do not wash the vehicle floor with water.

Vehicle systems such as the audio system may be damaged if water comes into contact with electrical components under the floor of vehicle. Water may also cause the body to rust.

■ Cleaning the inside of the rear window

- Do not use glass cleaner to clean the rear window, as this may cause damage to the rear window defogger heater wires or antenna. Use a cloth dampened with lukewarm water to gently wipe the window clean. Wipe the window in strokes running parallel to the heater wires or antenna.
- Be careful not to scratch or damage the heater wires or antenna.

Maintenance requirements

To ensure safe and economical driving, day-to-day care and regular maintenance are essential. It is the owner's responsibility to perform regular checks. Lexus recommends performing the following maintenance:

■ General maintenance

General maintenance should be performed on a daily basis. This can be done by yourself or by a Lexus dealer.

■ Scheduled maintenance

Scheduled maintenance should be performed at specified intervals according to the maintenance schedule.

For details about maintenance items and schedules, refer to the "Warranty and Service Guide", "Owner's Manual Supplement" or "Scheduled Maintenance".

■ Do-it-yourself maintenance

You can perform some maintenance procedures yourself.

Please be aware that do-it-yourself maintenance may affect warranty coverage.

The use of Lexus Repair Manuals is recommended.

For details about warranty coverage, refer to the separate "Owner's Guide", "Warranty and Service Guide", "Owner's Manual Supplement" or "Warranty Booklet".

■ Repair and replacement

It is recommended that genuine Lexus parts be used for repair to ensure performance of each system. If non-Lexus parts are used in replacement or if a repair shop other than a Lexus dealer performs repairs, confirm the warranty coverage.

■ Allow inspection and repairs to be performed by a Lexus dealer

- Lexus technicians are well-trained specialists and are kept up to date with the latest service information. They are well informed about the operations of all systems on your vehicle.
- Keep a copy of the repair order. It proves that the maintenance that has been performed is under warranty coverage. If any problem should arise while your vehicle is under warranty, your Lexus dealer will promptly take care of it.

⚠ CAUTION**■ If your vehicle is not properly maintained**

Improper maintenance could result in serious damage to the vehicle and possible serious injury or death.

■ Handling of the battery

- Engine exhaust, some of its constituents, and a wide variety of automobile components contain or emit chemicals known to the State of California to cause cancer and birth defects and other reproductive harm. Work in a well ventilated area.
- Oils, fuels and fluids contained in vehicles as well as waste produced by component wear contain or emit chemicals known to the State of California to cause cancer and birth defects or other reproductive harm. Avoid exposure and wash any affected area immediately.
- Battery posts, terminals and related accessories contain lead and lead compounds which are known to cause brain damage. Wash your hands after handling. (→P. 467)

4-2. Maintenance

General maintenance

Listed below are the general maintenance items that should be performed at the intervals specified in the “Warranty and Service Guide” or “Owner’s Manual Supplement”. It is recommended that any problem you notice should be brought to the attention of your Lexus dealer or qualified service shop for advice.

Engine compartment

Items	Check points
Battery	Check the indicator and connections. (→P. 467)
Brake fluid	Is the brake fluid at the correct level? (→P. 465)
Engine coolant	Is the engine coolant at the correct level? (→P. 463)
Engine oil	Is the engine oil at the correct level? (→P. 458)
Exhaust system	There should not be any fumes or strange sounds.
Radiator/condenser/hoses	The radiator and condenser should be free from foreign objects. (→P. 465)
Washer fluid	Is there sufficient washer fluid? (→P. 470)

Vehicle interior

Items	Check points
Accelerator pedal	<ul style="list-style-type: none"> • The accelerator pedal should move smoothly (without uneven pedal effort or catching).
Automatic transmission “Park” mechanism	<ul style="list-style-type: none"> • When parked on a slope and the shift lever is in P, is the vehicle securely stopped?
Brake pedal	<ul style="list-style-type: none"> • Does the brake pedal move smoothly? • Does the brake pedal have appropriate clearance from the floor? • Does the brake pedal have the correct amount of free play?
Brakes	<ul style="list-style-type: none"> • The vehicle should not pull to one side when the brakes are applied. • The brakes should work effectively. • The brake pedal should not feel spongy. • The brake pedal should not get too close to the floor when the brakes are applied.
Head restraints	<ul style="list-style-type: none"> • Do the head restraints move smoothly and lock securely?
Indicators/buzzers	<ul style="list-style-type: none"> • Do the indicators and buzzers function properly?
Lights	<ul style="list-style-type: none"> • Do all the lights come on? • Are the headlights aimed correctly? (→P. 501)

Items	Check points
Parking brake	<ul style="list-style-type: none"> • Does the parking brake pedal move smoothly? • When parked on a slope and the parking brake is on, is the vehicle securely stopped?
Seat belts	<ul style="list-style-type: none"> • Do the seat belts operate smoothly? • The seat belts should not be damaged.
Seats	<ul style="list-style-type: none"> • Do the seat controls operate properly?
Steering wheel	<ul style="list-style-type: none"> • Does the steering wheel rotate smoothly? • Does the steering wheel have the correct amount of free play? • There should not be any strange sounds coming from the steering wheel.

Vehicle exterior

Items	Check points
Doors	<ul style="list-style-type: none"> • Do the doors operate smoothly?
Engine hood	<ul style="list-style-type: none"> • Does the engine hood lock system work properly?
Fluid leaks	<ul style="list-style-type: none"> • There should not be any signs of fluid leakage after the vehicle has been parked.
Tires	<ul style="list-style-type: none"> • Is the tire inflation pressure correct? • The tires should not be damaged or excessively worn. • Have the tires been rotated according to the maintenance schedule? • The wheel nuts should not be loose.

CAUTION

■ If the engine is running

Turn the engine off and ensure that there is adequate ventilation before performing maintenance checks.

Emission inspection and maintenance (I/M) programs

Some states have vehicle emission inspection programs which include OBD (On Board Diagnostics) checks. The OBD system monitors the operation of the emission control system.

■ If the malfunction indicator lamp comes on

The OBD system determines that a problem exists somewhere in the emission control system. Your vehicle may not pass the I/M test and may need to be repaired. Contact your Lexus dealer to service the vehicle.

■ Your vehicle may not pass the I/M test in the following situations:

- When the battery is disconnected or discharged

Readiness codes that are set during ordinary driving are erased. Also, depending on your driving habits, the readiness codes may not be completely set.

- When the fuel tank cap is loose

The malfunction indicator lamp comes on indicating a temporary malfunction and your vehicle may not pass the I/M test.

■ When the malfunction indicator lamp still remains on after several driving trips

The error code in the OBD system will not be cleared unless the vehicle is driven 40 or more times.

■ If your vehicle does not pass the I/M test

Contact your Lexus dealer to prepare the vehicle for re-testing.

4-3. Do-it-yourself maintenance

Do-it-yourself service precautions

If you perform maintenance by yourself, be sure to follow the correct procedures as given in these sections.

Items	Parts and tools
Battery condition (→P. 467)	<ul style="list-style-type: none">• Warm water• Baking soda• Grease• Conventional wrench (for terminal clamp bolts)
Brake fluid level (→P. 465)	<ul style="list-style-type: none">• FMVSS No.116 DOT 3 or SAE J1703 brake fluid• Rag or paper towel• Funnel (used only for adding brake fluid)
Engine coolant level (→P. 463)	<ul style="list-style-type: none">• “Toyota Super Long Life Coolant” or similar high quality ethylene glycol-based non-silicate, non-amine, non-nitrite and non-borate coolant with long-life hybrid organic acid technology. For the U.S.A.: “Toyota Super Long Life Coolant” is pre-mixed with 50% coolant and 50% deionized water. For Canada: “Toyota Super Long Life Coolant” is pre-mixed with 55% coolant and 45% deionized water.• Funnel (used only for adding engine coolant)

Items	Parts and tools
Engine oil level (→P. 458)	<ul style="list-style-type: none"> • “Toyota Genuine Motor Oil” or equivalent • Rag or paper towel • Funnel (used only for adding engine oil)
Fuses (→P. 490)	<ul style="list-style-type: none"> • Fuse with same amperage rating as original
Tire inflation pressure (→P. 480)	<ul style="list-style-type: none"> • Tire pressure gauge • Compressed air source
Headlight aim (→P. 501)	<ul style="list-style-type: none"> • Phillips-head screwdriver
Radiator and condenser (→P. 465)	—
Washer fluid (→P. 470)	<ul style="list-style-type: none"> • Water washer fluid containing anti-freeze (for winter use) • Funnel (used only for adding water or washer fluid)

 **CAUTION**

The engine compartment contains many mechanisms and fluids that may move suddenly, become hot, or become electrically energized. To avoid death or serious injury, observe the following precautions:

■ When working on the engine compartment

- Keep hands, clothing and tools away from the moving fan and engine drive belt.
- Be careful not to touch the engine, radiator, exhaust manifold, etc. right after driving as they may be hot. Oil and other fluids may also be hot.
- Do not leave anything that may burn easily, such as paper or rags, in the engine compartment.
- Do not smoke, cause sparks or expose an open flame to fuel or the battery. Fuel and battery fumes are flammable.
- Be extremely cautious when working on the battery. It contains poisonous and corrosive sulfuric acid.

■ When working near the electric cooling fan or radiator grille

Be sure the “ENGINE START STOP” switch is off.

With the “ENGINE START STOP” switch in IGNITION ON mode, the electric cooling fan may automatically start to run if the air conditioning is on and/or the coolant temperature is high. (→P. 465)

■ Safety glasses

Wear safety glasses to prevent flying or falling material, fluid spray, etc. from getting in the eyes.

 **NOTICE****■ If you remove the air cleaner filter**

Driving with the air cleaner filter removed may cause excessive engine wear due to dirt in the air. Also a backfire could cause a fire in the engine compartment.

4-3. Do-it-yourself maintenance

Hood

Release the lock from the inside of the vehicle to open the hood.

STEP 1



Pull the hood lock release lever.

The hood will pop up slightly.

STEP 2



Pull up the hood catch and lift the hood.

CAUTION

■ Pre-driving check

Check that the hood is fully closed and locked.

If the hood is not locked properly, it may open while the vehicle is in motion and cause an accident, which may result in death or serious injury.

4-3. Do-it-yourself maintenance

Positioning a floor jack

When raising your vehicle with a floor jack, position the jack correctly. Improper placement may damage your vehicle or cause injury.

■ Front



■ Rear



⚠ CAUTION

■ **When raising your vehicle**

Make sure to observe the following precautions to reduce the possibility of death or serious injury:



- Lift up the vehicle using a floor jack such as the one shown in the illustration.

- Do not use the jack that was supplied with your vehicle.
- Do not put any part of your body underneath the vehicle when it is supported only by the floor jack.
Always use automotive jack stands on a solid, level surface.
- Do not start the engine while the vehicle is supported by the floor jack.
- Stop the vehicle on level, firm ground, firmly set the parking brake and shift the shift lever to P.
- Make sure to set the floor jack properly at the jack point.
Raising the vehicle with an improperly positioned floor jack will damage the vehicle and may cause the vehicle to fall off the floor jack.
- Do not raise the vehicle while someone is in the vehicle.
- When raising the vehicle, do not place any objects on top of or underneath the floor jack.
- Vehicles with electronically modulated air suspension:
Be sure to turn off the height control and stop the engine. Otherwise, the vehicle height may change during operation of the automatic leveling function.
(→P. 218)

Engine compartment

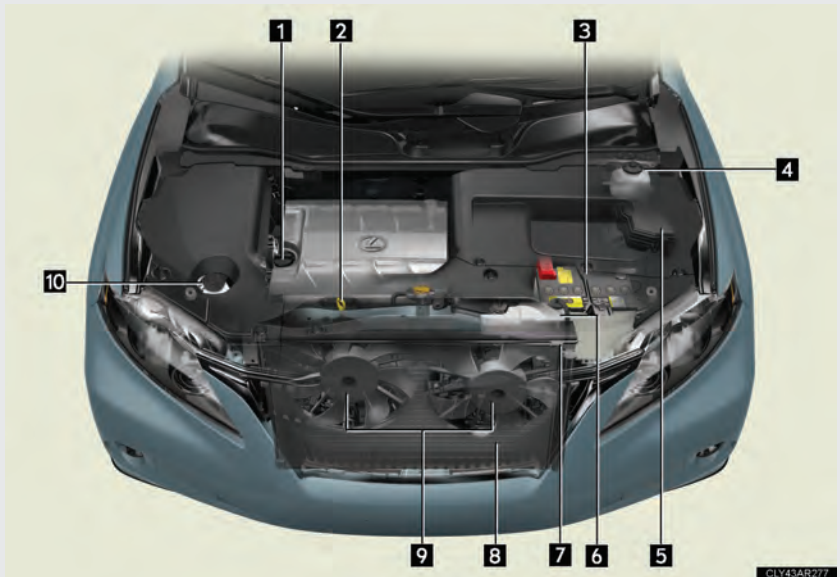

1 Engine oil filler cap
(→P. 458)

2 Engine oil level dipstick
(→P. 458)

3 Battery (→P. 467)

4 Brake fluid reservoir
(→P. 465)

5 Fuse box (→P. 490)

6 Engine coolant reservoir
(→P. 463)

7 Condenser (→P. 465)

8 Radiator (→P. 465)

9 Electric cooling fans

10 Washer fluid tank
(→P. 470)

Engine compartment covers

Removing the engine compartment covers

► Outside

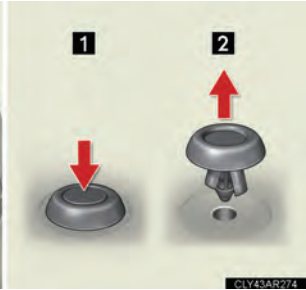
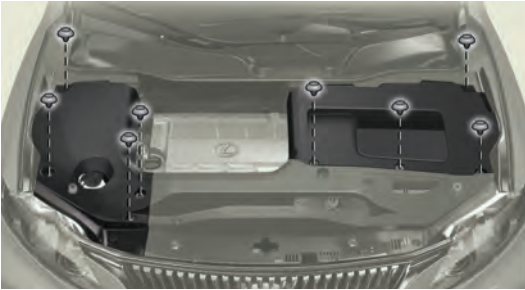

► Front

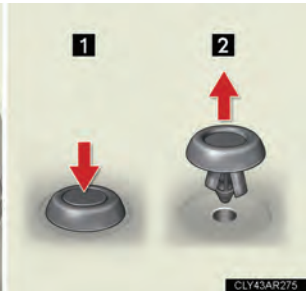

Installing the clips

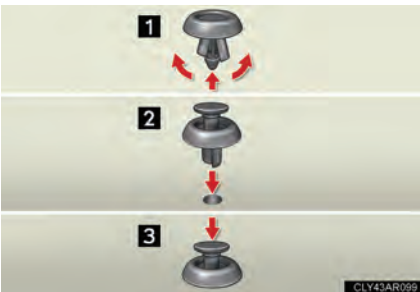

Battery cover

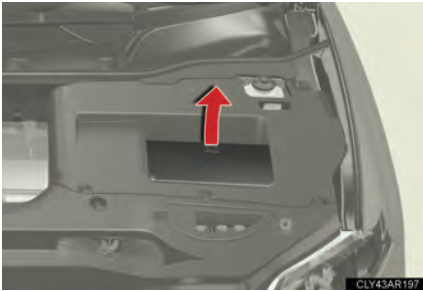

Removing the battery cover.

NOTICE

■ When installing the battery cover

Securely install the cover over the battery. Failure to do so may cause water to enter the engine compartment when it rains or the vehicle is washed, resulting in a malfunction.

Engine oil

With the engine at operating temperature and turned off, check the oil level on the dipstick.

■ Checking the engine oil

STEP 1 Park the vehicle on level ground. After turning off the engine, wait more than five minutes for the oil to drain back into the bottom of the engine.

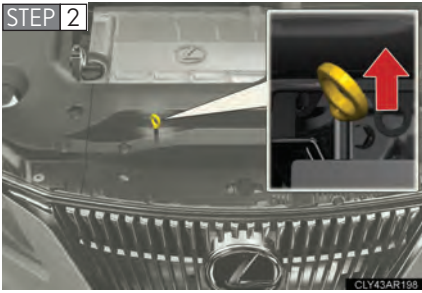

Hold a rag under the end and pull the dipstick out.

STEP 3 Wipe the dipstick clean.

STEP 4 Reinsert the dipstick fully.

STEP 5 Holding a rag under the end, pull the dipstick out and check the oil level.

STEP 6 Wipe the dipstick and reinsert it fully.

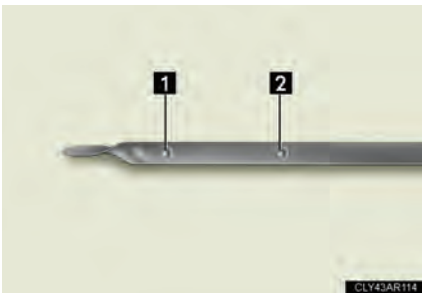

1 Low

2 Full

■ Adding engine oil



If the oil level is below or near the low level mark, add engine oil of the same type as that already in the engine.

Make sure to check the oil type and prepare the items needed before adding oil.

Oil grade	ILSAC multi-grade engine oil
Items	Clean funnel

STEP 1 Remove the oil filler cap by turning it counterclockwise.

STEP 2 Add engine oil slowly, checking the dipstick.

STEP 3 Install the oil filler cap by turning it clockwise.

About 1.6 qt. (1.5 L, 1.3 Imp. qt.) is required to raise the oil level from low to full on the dipstick.

■ Recommended viscosity

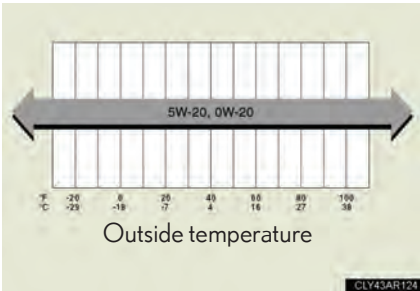

SAE 5W-20 or 0W-20

SAE 5W-20 or 0W-20 engine oil may be used. However, SAE 0W-20 oil is the best choice for good fuel economy, and good starting in cold weather.

■ How to read oil container labels

The ILSAC (International Lubricant Standardization and Approval Committee) Certification Mark is added to some oil containers to help you select the oil you should use.



■ Engine oil consumption

- The amount of engine oil consumed depends on the oil viscosity, the quality of the oil and the way the vehicle is driven.
- More oil is consumed under driving conditions such as high speeds and frequent acceleration and deceleration.
- A new engine consumes more oil.
- When judging the amount of oil consumption, keep in mind that the oil may have become diluted, making it difficult to judge the true level accurately.
- Oil consumption: Max. 1.1 qt./600 miles, 0.9 Imp. qt./600 miles (1.0 L per 1000 km)
- If your vehicle consumes more than 1.1 qt. (1.0 L, 0.9 Imp. qt.) every 600 miles (1000 km), contact your Lexus dealer.

■ After changing the engine oil (USA only)

The engine oil maintenance data should be reset. Perform the following procedures:

- STEP 1** Press the Menu switch (→P. 165) to change the multi-information display to blank.
- STEP 2** Turn the “ENGINE START STOP” switch off.
- STEP 3** While pressing the ODO/TRIP button (→P. 158), turn the “ENGINE START STOP” switch to IGNITION ON mode.
- STEP 4** Continue to press and hold the button for more than 7 seconds after the “ENGINE START STOP” switch is turned to IGNITION ON mode.



The message shown in the illustration will appear on the display. After 5 seconds, the system reset will be completed.

CAUTION

■ Used engine oil

- Used engine oil contains potentially harmful contaminants which may cause skin disorders such as inflammation or skin cancer, so care should be taken to avoid prolonged and repeated contact. To remove used engine oil from your skin, wash thoroughly with soap and water.
- Dispose of used oil and filters only in a safe and acceptable manner. Do not dispose of used oil and filters in household trash, in sewers or onto the ground. Call your Lexus dealer, service station or auto parts store for information concerning recycling or disposal.
- Do not leave used engine oil within the reach of children.

NOTICE

■ To prevent serious engine damage

Check the oil level on a regular basis.

■ When replacing the engine oil

- Be careful not to spill engine oil on the vehicle components.
- Avoid overfilling, or the engine could be damaged.
- Check the oil level on the dipstick every time you refill the vehicle.
- Be sure the engine oil filler cap is properly tightened.

Engine coolant

The coolant level is satisfactory if it is between the “FULL” and “LOW” lines on the reservoir when the engine is cold.



- 1 Reservoir cap
- 2 “FULL” line
- 3 “LOW” line

If the level is on or below the “LOW” line, add coolant up to the “FULL” line. (→P. 578)

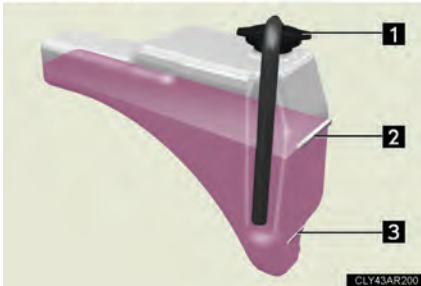

■ Coolant selection

Only use “Toyota Super Long Life Coolant” or a similar high quality ethylene glycol based non-silicate, non-amine, non-nitrite, and non-borate coolant with long-life hybrid organic acid technology.

U.S.A.: “Toyota Super Long Life Coolant” is a mixture of 50% coolant and 50% deionized water. (Minimum temperature: -31°F [-35°C])

Canada: “Toyota Super Long Life Coolant” is a mixture of 55% coolant and 45% deionized water. (Minimum temperature: -44°F [-42°C])

For more details about coolant, contact your Lexus dealer.

■ If the coolant level drops within a short time after replenishing

Visually check the radiator, hoses, radiator cap, drain cock and water pump.

If you cannot find a leak, have your Lexus dealer test the cap and check for leaks in the cooling systems.

CAUTION

■ When the engine is hot

Do not remove the radiator cap.

The cooling system may be under pressure and may spray hot coolant if the cap is removed, causing burns or other injuries.

NOTICE

■ When adding engine coolant

Coolant is neither plain water nor straight antifreeze. The correct mixture of water and antifreeze must be used to provide proper lubrication, corrosion protection and cooling. Be sure to read the antifreeze or coolant label.

■ If you spill coolant

Be sure to wash it off with water to prevent damage to parts or paint.

Radiator and condenser

Check the radiator and condenser, and clear away any foreign objects. If either of the above parts are extremely dirty or you are not sure of their condition, have your vehicle checked by your Lexus dealer.

⚠ CAUTION

■ When the engine is hot

Do not touch the radiator or condenser, as they may be hot and burn you.

Brake fluid

■ Checking fluid level



The brake fluid level should be between the “MAX” and “MIN” lines on the tank.

■ Adding fluid

Make sure to check the fluid type and prepare the necessary item.

Fluid type	FMVSS No.116 DOT 3 or SAE J1703
Items	Clean funnel

■ Brake fluid can absorb moisture from the air

Excess moisture in the brake fluid can cause a dangerous loss of braking efficiency. Use only newly opened brake fluid.

CAUTION

■ When filling the reservoir

Take care because brake fluid can harm your hands or eyes and damage painted surfaces.

If fluid gets on your hands or in your eyes, flush the affected area with clean water immediately.

If you still experience discomfort, see a doctor.

NOTICE

■ If the fluid level is low or high

It is normal for the brake fluid level to go down slightly as the brake pads wear out or when the fluid level in the accumulator is high.

If the reservoir needs frequent refilling, there may be a serious problem.

Battery

Check the battery as follows.

Battery exterior

Make sure that the battery terminals are not corroded and that there are no loose connections, cracks, or loose clamps.

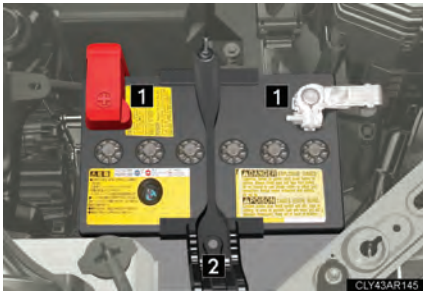

- 1 Terminals
- 2 Hold-down clamp

Checking battery condition

STEP 1 Remove the cover located over the battery. (→P. 457)

STEP 2 Check the battery condition by indicator color.

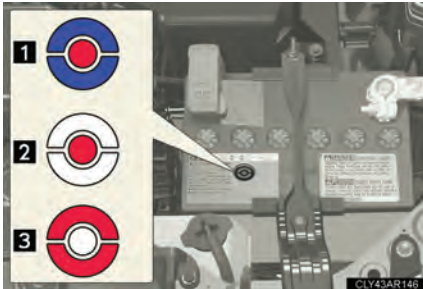

- 1 Blue: Good condition
- 2 White: Charging is necessary. Have the vehicle inspected by your Lexus dealer.
- 3 Red: Not working properly. Have the battery checked by your Lexus dealer.

STEP 3 Install the cover over the battery. (→P. 457)

■ Before recharging

When recharging, the battery produces hydrogen gas which is flammable and explosive. Therefore, observe the following before recharging:

- If recharging with the battery installed on the vehicle, be sure to disconnect the ground cable.
- Make sure the power switch on the charger is off when connecting and disconnecting the charger cables to the battery.

■ After recharging/reconnecting the battery

In some cases, the engine may not start. Follow the procedure below to initialize the system.

STEP 1 Shift the shift lever to “P”, and turn the “ENGINE START STOP” switch OFF.

STEP 2 Open and close any of the doors.

STEP 3 Start the engine. (If the engine does not start first time, repeat the procedure.)

If the engine will not start even after multiple attempts at the above method, contact your Lexus dealer.

CAUTION

■ Chemicals in the battery

Batteries contain poisonous and corrosive sulfuric acid and may produce hydrogen gas which is flammable and explosive. To reduce the risk of death or serious injury, take the following precautions while working on or near the battery:

- Do not cause sparks by touching the battery terminals with tools.
- Do not smoke or light a match near the battery.
- Avoid contact with eyes, skin and clothes.
- Never inhale or swallow electrolyte.
- Wear protective safety glasses when working near the battery.
- Keep children away from the battery.

 **CAUTION****■ Where to safely charge the battery**

Always charge the battery in an open area. Do not charge the battery in a garage or closed room where there is insufficient ventilation.

■ How to recharge the battery

Only perform a slow charge (5 A or less). The battery may explode if charged at a quicker rate.

■ Emergency measures regarding electrolyte**● If electrolyte gets in your eyes**

Flush your eyes with clean water for at least 15 minutes and get immediate medical attention. If possible, continue to apply water with a sponge or cloth while traveling to the nearest medical facility.

● If electrolyte gets on your skin

Wash the affected area thoroughly. If you feel pain or burning, get medical attention immediately.

● If electrolyte gets on your clothes

It can soak through clothing on to your skin. Immediately take off the clothing and follow the procedure above if necessary.

● If you accidentally swallow electrolyte

Drink a large quantity of water or milk. Follow with milk of magnesia, beaten raw egg or vegetable oil. Get emergency medical attention immediately.

 **NOTICE****■ When recharging the battery**

Never recharge the battery while the engine is running. Also, be sure all accessories are turned off.

Washer fluid



If any washer does not work or the warning message appears on the multi-information display, the washer tank may be empty. Add washer fluid.

CAUTION

When adding washer fluid

Do not add washer fluid when the engine is hot or running as washer fluid contains alcohol and may catch fire if spilled on the engine etc.

NOTICE

Do not use any fluid other than washer fluid

Do not use soapy water or engine antifreeze instead of washer fluid. Doing so may cause streaking on the vehicle's painted surfaces.

Diluting washer fluid

Dilute washer fluid with water as necessary. Refer to the freezing temperatures listed on the washer fluid tank.

Tires

Replace or rotate tires in accordance with maintenance schedules and treadwear.

■ Checking tires



- 1 New tread
- 2 Treadwear indicator
- 3 Worn tread

The location of treadwear indicators is shown by the “TWI” or “Δ” marks, etc., molded on the sidewall of each tire.

Check spare tire condition and pressure if not rotated.

■ Tire rotation

▶ Vehicles with a compact spare tire

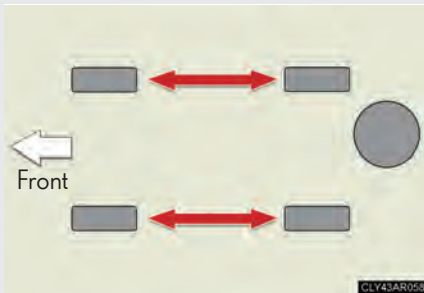

Rotate the tires in the order shown.

To equalize tire wear and extend tire life, Lexus recommends that tire rotation is carried out at the same interval as tire inspection.

▶ Vehicles with a full-size spare tire

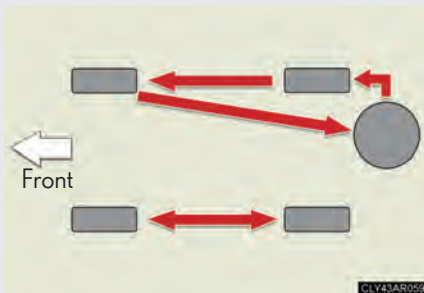

Rotate the tires in the order shown.

To equalize tire wear and extend tire life, Lexus recommends that tire rotation is carried out at the same interval as tire inspection.

■ The tire pressure warning system

Your Lexus is equipped with a tire pressure warning system that uses tire pressure warning valves and transmitters to detect low tire inflation pressure before serious problems arise. (→P. 528, 536)

Installing tire pressure warning valves and transmitters

When replacing tires or wheels, tire pressure warning valves and transmitters must also be installed.

When new tire pressure warning valves and transmitters are installed, new tire pressure warning valve and transmitter ID codes must be registered in the tire pressure warning computer and the tire pressure warning system must be initialized. Have the tire pressure warning valve and transmitter ID codes registered by your Lexus dealer. (→P. 474)

Initializing the tire pressure warning system

■ The tire pressure warning system must be initialized in the following circumstances:

- When the tire inflation pressure is changed such as when changing travelling speed or load weight
- When changing the tire size

When the tire pressure warning system is initialized, the current tire inflation pressure is set as the benchmark pressure.

■ How to initialize the tire pressure warning system

STEP 1 Park the vehicle in safe place and turn the “ENGINE START STOP” switch off.

While the vehicle is moving, initialization is not performed.

STEP 2 Adjust the tire inflation pressure to the specified cold tire inflation pressure level. (→P. 591)

Make sure to adjust the tire pressure to the specified cold tire inflation pressure level. The tire pressure warning system will operate based on this pressure level.

STEP 3 Turn the “ENGINE START STOP” switch to IGNITION ON mode.



Press and hold the tire pressure warning reset button until the tire pressure warning light flashes slowly 3 times.

STEP 5 Wait for a few minutes in “ENGINE START STOP” switch to on, and then turn the “ENGINE START STOP” switch off.

Registering ID codes

The tire pressure warning valve and transmitter is equipped with a unique ID code. When replacing a tire pressure warning valve and transmitter, it is necessary to register the ID code. Have the ID code registered by your Lexus dealer.

■ When to replace your vehicle's tires

Tires should be replaced if:

- You have tire damage such as cuts, splits, cracks deep enough to expose the fabric, and bulges indicating internal damage.
- A tire goes flat repeatedly or cannot be properly repaired due to the size or location of a cut or other damage.

If you are not sure, consult with your Lexus dealer.

■ Replacing tires and wheels

If the ID code of the tire pressure warning valve and transmitter is not registered, the tire pressure warning system will not work properly. After driving for about 20 minutes, the tire pressure warning light flashes for 1 minute and stays on to indicate a system malfunction.

■ Tire life

Any tire over 6 years old must be checked by a qualified technician even if they have seldom or never been used or damage is not obvious.

■ If the tread on snow tires wears down below 0.16 in. (4 mm)

The effectiveness of the tires as snow tires is lost.

■ Maximum load of tire

Check that the number given by dividing the maximum load by 1.10 of the replacement tire is greater than 1/2 of the Gross Axle Weight Ratings (GAWR) of either the front axle or the rear axle, whichever is greater.



For the GAWR, see the Certification Label. For the maximum load of the tire, see the load limit at maximum cold tire inflation pressure mentioned on the sidewall of the tire. (→P. 598)

■ Tire types

1 Summer tires

Summer tires are high-speed performance tires best suited to highway driving under dry conditions. Since summer tires do not have the same traction performance as snow tires, summer tires are inadequate for driving on snow-covered or icy roads. For driving on snow-covered roads or icy roads, the use of snow tires is recommended. When installing snow tires, be sure to replace all four tires.

2 All season tires

All season tires are designed to provide better traction in snow and to be adequate for driving in most winter conditions, as well as for use year round. All season tires, however, do not have adequate traction performance compared with snow tires in heavy or loose snow. Also, all season tires fall short in acceleration and handling performance compared with summer tires in highway driving.

3 Snow tires

For driving on snow-covered roads or icy roads, we recommend using snow tires. If you need snow tires, select tires of the same size, construction and load capacity as the originally installed tires. Since your vehicle has radial tires as original equipment, make sure your snow tires also have radial construction. Do not install studded tires without first checking local regulations for possible restrictions. Snow tires should be installed on all wheels. (→P. 252)

■ Initializing the tire pressure warning system

Initialize the tire pressure warning system with the tire inflation pressure adjusted to the specified level.

■ If you push the tire pressure warning reset switch accidentally

If initialization is performed, adjust the tire inflation pressure to the specified level and initialize the tire pressure warning system again.

■ When the initialization of the tire pressure warning system has failed

Initialization can be completed in a few minutes. However, in the following cases, the settings have not been recorded and the system will not operate properly. If repeated attempts to record tire inflation pressure settings are unsuccessful, have the vehicle inspected by your Lexus dealer.

- When operating the tire pressure warning reset button, the tire pressure warning light does not flash 3 times.
- After carrying out the initialization procedure, the tire pressure warning light flashes for 1 minute then stays on after driving for 20 minutes.

■ Routine tire inflation pressure checks

The tire pressure warning system does not replace routine tire inflation pressure checks. Make sure to check tire inflation pressure as part of your routine of daily vehicle checks.

■ Tire pressure warning system certification

TPMS Transmitter FCC ID: PAXPMV107J
IC ID: 3729A-PMV107J

TPMS Receiver FCC ID: HYQ13BCX
IC ID: 1551A-13BCX

► For vehicles sold in the U.S.A.

This device complies with Part 15 of the FCC Rules. Operation is subject to the following two conditions: (1) this device may not cause harmful interference, and (2) this device must accept any interference received, including interference that may cause undesired operation.

FCC WARNING:

Changes or modifications not expressly approved by the party responsible for compliance could void the user's authority to operate the equipment.

► For vehicles sold in Canada

Operation is subject to the following two conditions: (1) this device may not cause interference, and (2) this device must accept any interference, including interference that may cause undesired operation of the device.

 **CAUTION**

■ **Tire pressure warning system operation**

The tire pressure warning system may not provide warning immediately if a tire bursts or if sudden air leakage occurs.

■ **When inspecting or replacing tires**

Observe the following precautions to prevent accidents. Failure to do so may cause damage to parts of the drive train, as well as dangerous handling characteristics, which may lead to an accident resulting in death or serious injury.

- Do not mix tires of different makes, models or tread patterns. Also, do not mix tires of remarkably different treadwear.
- Do not use tire sizes other than those recommended by Lexus.
- Do not mix differently constructed tires (radial, bias-belted or bias-ply tires).
- Do not mix summer, all season and snow tires.
- Do not use tires that have been used on another vehicle.
Do not use tires if you do not know how they were used previously.

■ **When initializing the tire pressure warning system**

Do not push the tire pressure warning reset switch without first adjusting the tire inflation pressure to the specified level. Otherwise, the tire pressure warning light may not come on even if the tire inflation pressure is low, or it may come on when the tire inflation pressure is actually normal.

 NOTICE**■ Repairing or replacing tires, wheels and tire pressure warning valves and transmitters**

When removing or fitting the wheels, tires or the tire pressure warning valve and transmitter, contact your Lexus dealer as the tire pressure warning valves and transmitter may be damaged if not handled correctly.

■ To avoid damaging the tire pressure warning valves and transmitters

Do not use liquid sealants on flat tires.

■ Driving on rough roads

Take particular care when driving on roads with loose surfaces or potholes. These conditions may cause losses in tire inflation pressure, reducing the cushioning ability of the tires. In addition, driving on rough roads may cause damage to the tires themselves, as well as the vehicle's wheels and body.

■ If tire inflation pressures become low while driving

Do not continue driving, or your tires and/or wheels may be ruined.

4-3. Do-it-yourself maintenance

Tire inflation pressure

■ Tire inflation pressure

The recommended cold tire inflation pressure and tire size is displayed on the tire and loading information label. (→P. 591)



■ Inspection and adjustment procedure



- 1 Tire valve
- 2 Tire pressure gauge

- STEP 1** Remove the tire valve cap.
- STEP 2** Press the tip of the tire pressure gauge onto the tire valve.
- STEP 3** Read the pressure using the gauge graduations.

STEP 4 If the tire inflation pressure is not at the recommended level, adjust the pressure.

If you add too much air, press the center of the valve to deflate.

STEP 5 After completing the tire inflation pressure measurement and adjustment, apply soapy water to the valve and check for leakage.

STEP 6 Put the tire valve cap back on.

■ Tire inflation pressure check interval

You should check tire inflation pressure every two weeks, or at least once a month. Do not forget to check the spare.

■ Effects of incorrect tire inflation pressure

Driving with incorrect tire inflation pressure may result in the following:

- Reduced fuel efficiency
- Reduced driving comfort and tire life
- Reduced safety
- Damage to the drive train

If a tire needs frequent inflating, have it checked by your Lexus dealer.

■ Instructions for checking tire pressure

When checking tire inflation pressure, observe the following:

- Check only when the tires are cold.
If your vehicle has been parked for at least 3 hours and has not been driven for more than 1 mile or 1.5 km, you will get an accurate cold tire inflation pressure reading.
- Always use a tire pressure gauge.
The appearance of the tire can be misleading. In addition, tire inflation pressures that are even just a few pounds off can degrade ride and handling.
- Do not reduce tire inflation pressure after driving. It is normal for the tire inflation pressure to be higher after driving.

- Never exceed the vehicle capacity weight. Passengers and luggage weight should be placed so that the vehicle is balanced.

CAUTION

■ Proper inflation is critical to save tire performance

Keep your tires properly inflated. Otherwise, the following conditions may occur and result in an accident causing death or serious injury:

- Excessive wear
- Uneven wear
- Poor handling
- Possibility of blowouts resulting from overheated tires
- Poor sealing of the tire bead
- Wheel deformation and/or tire separation
- A greater possibility of tire damage from road hazards

NOTICE

■ When inspecting and adjusting tire inflation pressure

Be sure to put the tire valve caps back on.

Without the valve caps, dirt or moisture could get into the valve and cause air leakage, which could result in an accident. If the caps are lost, replace them as soon as possible.

Wheels

If a wheel is bent, cracked or heavily corroded, it should be replaced. Otherwise, the tire may separate from the wheel or cause a loss of handling control.

■ Wheel selection

When replacing wheels, care should be taken to ensure that they are equivalent to those removed in load capacity, diameter, rim width, and offset.

Replacement wheels are available at your Lexus dealer.

Lexus does not recommend using the following:

- Wheels of different sizes or types
- Used wheels
- Bent wheels that have been straightened

■ Aluminum wheel precautions

- Use only Lexus wheel nuts and wrenches designed for use with your aluminum wheels.
- When rotating, repairing or changing your tires, check that the wheel nuts are still tight after driving 1000 miles (1600 km).
- Be careful not to damage the aluminum wheels when using tire chains.
- Use only Lexus genuine balance weights or equivalent and a plastic or rubber hammer when balancing your wheels.

■ When replacing wheels

The wheels of your vehicle are equipped with tire pressure warning valves and transmitters that allow the tire pressure warning system to provide advanced warning in the event of a loss in tire inflation pressure. Whenever wheels are replaced, tire pressure warning valves and transmitters must be installed. (→P. 472)

CAUTION

■ When replacing wheels

- Do not use wheels that are a different size from those recommended in the Owner's Manual, as this may result in a loss of handling control.
- Never use an inner tube in a leaking wheel which is designed for a tubeless tire. Doing so may result in an accident, causing death or serious injury.

NOTICE

■ Replacing tire pressure warning valves and transmitters

- Because tire repair or replacement may affect the tire pressure warning valves and transmitters, make sure to have tires serviced by your Lexus dealer or other qualified service shop. In addition, make sure to purchase your tire pressure warning valves and transmitters at your Lexus dealer.
- Ensure that only genuine Lexus wheels are used on your vehicle. Tire pressure warning valves and transmitters may not work properly with non-genuine wheels.

4-3. Do-it-yourself maintenance

Air conditioning filter

The air conditioning filter must be cleaned or changed regularly to maintain air conditioning efficiency.

■ Removal method

STEP 1 Set the air conditioning system to recirculated mode.
(→P. 275)

The air conditioning filter case cannot be removed with the system in outside air mode.

STEP 2 Turn the “ENGINE START STOP” switch off.

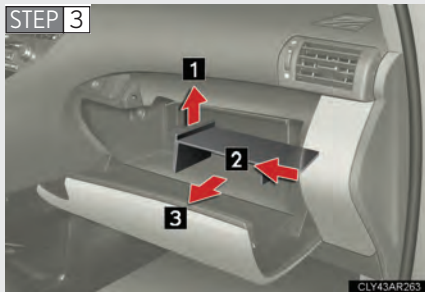

Open the glove box door. Lift and remove the partition.

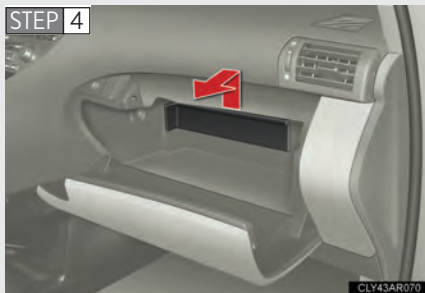

Remove the glove box cover.

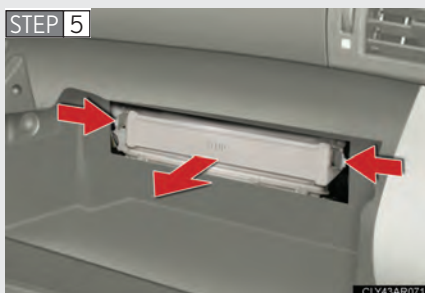

Remove the filter cover.

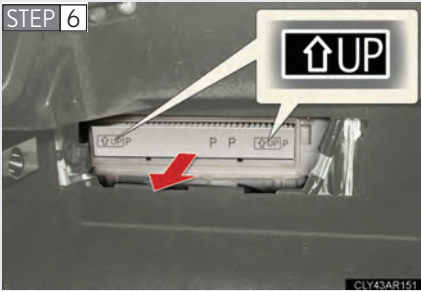

To remove the filter case, lift it up and pull it out. Replace the filter with a new one.

The “↑UP” mark shown on the filter should be pointing up.

■ Cleaning method

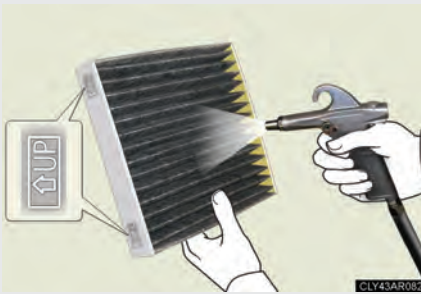

If the filter is dirty, clean by blowing compressed air through the filter from the underside.

Hold the air gun 2 in. (5 cm) from the filter and blow for approximately 2 minutes at 72 psi (500 kPa, 5.0 kgf/cm² or bar).

If an air gun is not available, have the filter cleaned by your Lexus dealer.

■ Checking interval

Inspect and replace the air conditioning filter according to the maintenance schedule. In dusty areas or areas with heavy traffic flow, early replacement may be required. (For scheduled maintenance information, please refer to the “Owner's Manual Supplement” or “Scheduled Maintenance”.)

■ If air flow from the vents decreases dramatically

The filter may be clogged. Check the filter and replace if necessary.

 NOTICE**■ To prevent damage to the system**

- When using the air conditioning system, make sure that a filter is always installed.
- When cleaning the filter, do not clean with water.

4-3. Do-it-yourself maintenance

Electronic key battery

Replace the battery with a new one if it is depleted.

■ You will need the following items:

- Flathead screwdriver
- Small Phillips-head screwdriver
- Lithium battery (CR1632)

■ Replacing the battery

STEP 1



Take out the mechanical key.

STEP 2



Remove the cover.

STEP 3

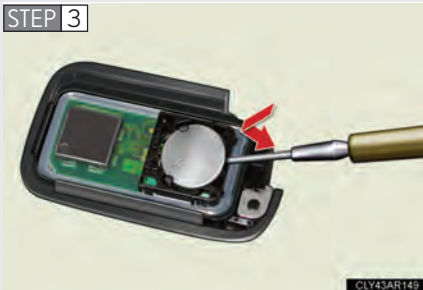

Remove the depleted battery.

Insert a new battery with the “+” terminal facing up.

■ Use a CR1632 lithium battery

- Batteries can be purchased at your Lexus dealer, local electrical appliance shops or camera stores.
- Replace only with the same or equivalent type recommended by the manufacturer.
- Dispose of used batteries according to the local laws.

■ If the electronic key battery is discharged

The following symptoms may occur:

- The smart access system with push-button start and wireless remote control will not function properly.
- The operational range is reduced.

■ When the card key battery needs to be replaced (if equipped)

The battery for the card key is available only at Lexus dealers. Your Lexus dealer can replace the battery for you.

CAUTION

■ Removed battery and other parts

Keep away from children.

These parts are small and if swallowed by a child, they can cause choking.

NOTICE

■ For normal operation after replacing the battery

Observe the following precautions to prevent accidents:

- Always work with dry hands.
Moisture may cause the battery to rust.
- Do not touch or move any other components inside the remote control.
- Do not bend either of the battery terminals.

4-3. Do-it-yourself maintenance

Checking and replacing fuses

If any of the electrical components do not operate, a fuse may have blown. If this happens, check and replace the fuses as necessary.

STEP 1 Turn the “ENGINE START STOP” switch off.

STEP 2 Remove the engine compartment cover. (→P. 456)

STEP 3 Open the fuse box cover.

▶ Engine compartment

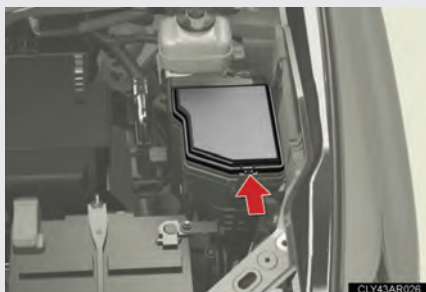

Push the tab in and lift the lid off.

▶ Driver's side instrument panel



Remove the lid.

STEP 4 After a system failure, see “Fuse layout and amperage ratings” for details about which fuse to check. (→P. 493)

STEP 5

CLY43AR053

Remove the fuse with the pull-out tool.

STEP 6 Check if the fuse has blown.

► Type A

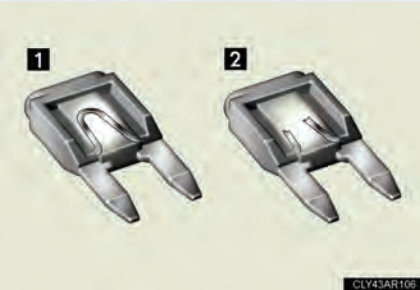

CLY43AR106

1 Normal fuse**2** Blown fuse

Replace the blown fuse with a new fuse of an appropriate amperage rating. The amperage rating can be found on the fuse box lid.

► Type B

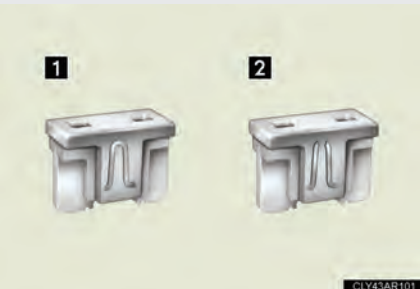

CLY43AR101

1 Normal fuse**2** Blown fuse

Replace the blown fuse with a new fuse of an appropriate amperage rating. The amperage rating can be found on the fuse box lid.

► Type C

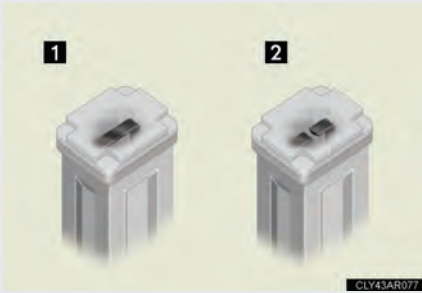

1 Normal fuse

2 Blown fuse

Replace the blown fuse with a new fuse of an appropriate amperage rating. The amperage rating can be found on the fuse box lid.

► Type D

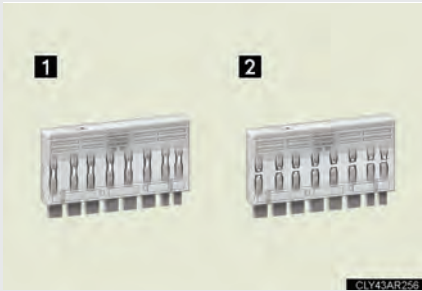

1 Normal fuse

2 Blown fuse

Replace the blown fuse with a new fuse of an appropriate amperage rating. The amperage rating can be found on the fuse box lid.

► Type E

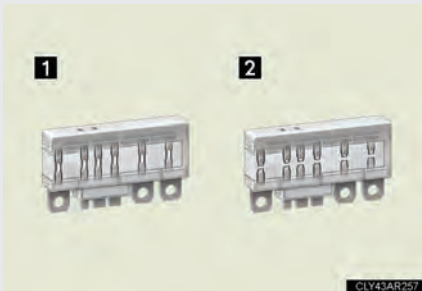

1 Normal fuse

2 Blown fuse

Replace the blown fuse with a new fuse of an appropriate amperage rating. The amperage rating can be found on the fuse box lid.

Fuse layout and amperage ratings

■ Engine compartment

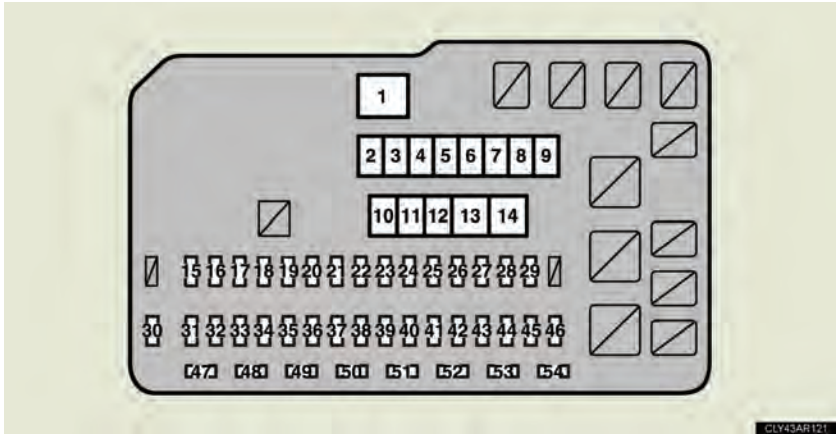

Fuse		Ampere	Circuit
1	RDI FAN NO.1	80 A	Electric cooling fans
2	RR DEF	50 A	Rear window defogger
3	AIR SUS	50 A	Electronically modulated air suspension system
4	HTR	50 A	Air conditioning system
5	SPARE	30 A	—
6	SPARE	40 A	—
7	ABS NO.2	30 A	Anti-lock brake system
8	H-LP CLN	30 A	Headlight cleaner
9	PBD	30 A	Power back door system
10	ST	30 A	Starter system

4-3. Do-it-yourself maintenance

Fuse		Ampere	Circuit
11	PD	50 A	Daytime running light system, A/F, H-LP RH HI, H-LP LH LO, H-LP RH LO, H-LP LH HI, HORN, S-HORN, multiplex communication system, multiport fuel injection system/ sequential multiport fuel injection system
12	ABS NO.1	50 A	Anti-lock brake system
13	EPS	60 A	Electric power steering system
14	ALT	140 A	FUEL OPN, DR LOCK, OBD, RR FOG, S/ROOF, 4WD, INVERTER, ECU IG1 NO. 1, ECU IG1 NO. 2, PANEL, GAUGE NO. 1
15	AMP1	30 A	Audio system
16	EFI MAIN	30 A	Multiport fuel injection system/ sequential multiport fuel injection system, EFI NO. 1, EFI NO. 2
17	AMP2	30 A	Audio system
18	IG2	30 A	Starter system, IGN, GAUGE NO. 2, ECU IG2
19	IP JB	25 A	Power door lock system
20	STR LOCK	20 A	Starter system
21	RAD NO.3	15 A	Meters and gauges lights, instrument panel lights, navigation system, audio system, rear seat entertainment system
22	HAZ	15 A	Emergency flashers

Fuse		Ampere	Circuit
23	ETCS	10 A	Multiport fuel injection system/ sequential multiport fuel injection system
24	RAD NO.1	10 A	Audio system
25	AM2	7.5 A	Starting system
26	ECU-B NO.2	7.5 A	Air conditioning system, front passenger occupant classification system, starter system
27	MAYDAY	7.5 A	_____
28	IMMOBI	7.5 A	_____
29	ALT-S	7.5 A	Charging system
30	IGN	10 A	Starter system, multiport fuel injection system/sequential multiport fuel injection system
31	DOME	10 A	Vanity mirror lights, luggage compartment lights, interior lights, personal lights
32	ECU-B NO.1	7.5 A	Interior lights, personal lights, tilt and telescopic steering, multiplex communication system, meters and gauges, power window, driving position memory system, power seats, power back door, head-up display, starter system, air conditioning system, power door lock system
33	EFI NO.1	10 A	Multiport fuel injection system/ sequential multiport fuel injection system
34	WIP-S	7.5 A	Windshield wipers and washer

4-3. Do-it-yourself maintenance

	Fuse	Ampere	Circuit
35	AFS	7.5 A	Adaptive front-lighting system
36	BK/UP LP	7.5 A	Back-up lights
37	HEATER NO. 2	7.5 A	Air conditioning system, AWD system
38	ECU IG1	10 A	Adaptive front-lighting system, headlight cleaner, cooling fan, cruise control, electronically modulated air suspension system, vehicle stability control, vehicle dynamics integrated management
39	EFI NO. 2	10 A	Multiport fuel injection system/ sequential multiport fuel injection system
40	F/PUMP	15 A	Multiport fuel injection system/ sequential multiport fuel injection system
41	DEICER	25 A	Windshield wipers and washer
42	STOP	7.5 A	Vehicle stability control, vehicle dynamics integrated management, high mounted stoplight
43	TOWING BATT	20 A	Trailer battery
44	TOWING	30 A	Trailer lights
45	FILTER	10 A	Condenser
46	IG1 MAIN	30 A	ECU IG1, BK/UP LP, HEATER NO. 2, AFS
47	H-LP RH HI	15 A	Right-hand headlight (high beam)
48	H-LP LH HI	15 A	Left-hand headlight (high beam)
49	BIXENON	10 A	Discharge headlight
50	H-LP RH LO	15 A	Right-hand headlight (low beam)

	Fuse	Ampere	Circuit
51	H-LP LH LO	15 A	Left-hand headlight (low beam)
52	HORN	10 A	Horn
53	A/F	20 A	Multiport fuel injection system/ sequential multiport fuel injection system
54	S-HORN	7.5 A	Security horn

■ Driver's side instrument panel

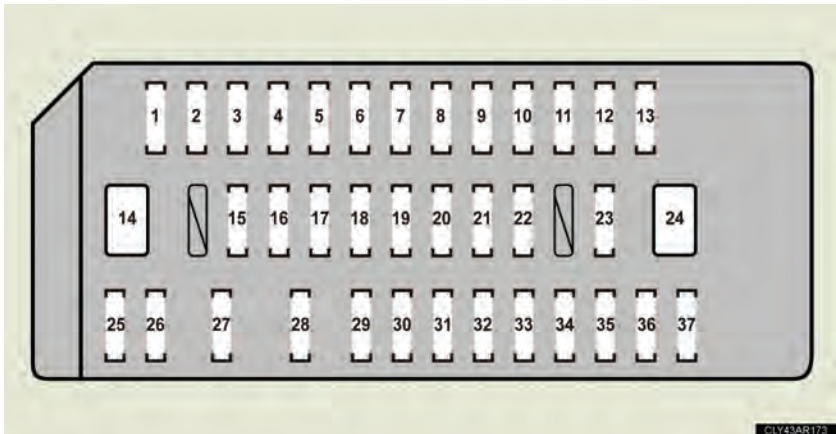

	Fuse	Ampere	Circuit
1	P/POINT	15 A	Power outlet
2	ECU-ACC	10 A	Navigation system, outside rear view mirror, multiplex communication system, multi-information display, head-up display
3	CIG	15 A	Power outlet
4	RADIO NO.2	7.5 A	Audio system, power outlet
5	GAUGE NO.1	10 A	Emergency flashers, navigation system, head-up display

4-3. Do-it-yourself maintenance

Fuse		Ampere	Circuit
6	ECU-IG1 NO.3	10 A	Outside rear view mirror, windshield wipers and washer, seat heaters, starter system, power outlet, moon roof, Automatic High Beam
7	ECU-IG1 NO.1	10 A	Multiplex communication system, electric power steering system, shift lock control system, tilt and telescopic steering, starter system, automatic transmission system, power back door, tire pressure warning system
8	S/ROOF	30 A	Moon roof
9	FUEL OPN	7.5 A	Fuel filler door opener
10	PSB	30 A	Pre-collision seat belt
11	TI & TE	30 A	Tilt and telescopic steering system
12	DR LOCK	10 A	Power door lock system
13	FR FOG	15 A	Front fog lights
14	P-SEAT LH	30 A	Power seat (left-side)
15	4WD	7.5 A	AWD system
16	INVERTER	20 A	———
17	RR FOG	7.5 A	———
18	D/L ALT B	25 A	Multiplex communication system
19	HEATER	10 A	Air conditioning system
20	ECU-IG1 NO.2	10 A	Air conditioning system, multiport fuel injection system/sequential multiport fuel injection system, SRS airbag system, multi-information display

Fuse		Ampere	Circuit
21	PANEL	10 A	Switch illumination, navigation system, height control system, headlight cleaner, windshield wiper de-icer, seat heater, power back door, audio system, multi-information display, air conditioning system
22	TAIL	10 A	Parking lights, side marker lights, tail lights, license plate lights, front fog lights, towing converter
23	AIR SUS	20 A	Electronically modulated air suspension system
24	P-SEAT RH	30 A	Power seat (right-side)
25	OBD	7.5 A	On-Board diagnosis
26	FR DOOR	25 A	Front power window (right-side)
27	RR DOOR	25 A	Rear power window (right-side)
28	FL DOOR	25 A	Front power window (left-side)
29	RL DOOR	25 A	Rear power window (left-side)
30	FR WASH	25 A	Windshield wipers and washer
31	RR WIP	15 A	Windshield wipers and washer
32	RR WASH	20 A	Windshield wipers and washer
33	FR WIP	30 A	Windshield wipers and washer
34	ECU IG2	10 A	Starter system, Intuitive parking assist, AWD system
35	GAUGE NO. 2	7.5 A	Starter system
36	RH S-HTR	15 A	Seat heater (right-side)
37	LH S-HTR	15 A	Seat heater (left-side)

■ After a fuse is replaced

- If the lights do not turn on even after the fuse has been replaced, a bulb may need replacement. (→P. 503)
- If the replaced fuse blows again, have the vehicle inspected by your Lexus dealer.

■ If there is an overload in the circuit

The fuses are designed to blow before the entire wiring harness is damaged.

CAUTION

■ To prevent system breakdowns and vehicle fire

Observe the following precautions.

Failing to do so may cause damage, and possibly a fire or injury.

- Never use a fuse of a higher amperage rating than indicated, or use any other object in place of a fuse.
- Always use a genuine Lexus fuse or equivalent.
Never replace a fuse with a wire, even as a temporary fix.
This can cause extensive damage or even fire.
- Do not modify fuse or fuse boxes.

NOTICE

■ Before replacing fuses

Have the cause of electrical overload determined and repaired by your Lexus dealer.

Headlight aim (discharge headlights)

Vertical movement adjustment bolts



1 Adjustment bolt A

2 Adjustment bolt B

Before checking the headlight aim

STEP 1 Remove the engine compartment cover. (→P. 456)

STEP 2 Make sure the vehicle has a full tank of gas and the area around the headlight is not deformed.

STEP 3 Park the vehicle on level ground.

STEP 4 Sit in the driver's seat.

STEP 5 Bounce the vehicle several times.

Adjusting the headlight aim

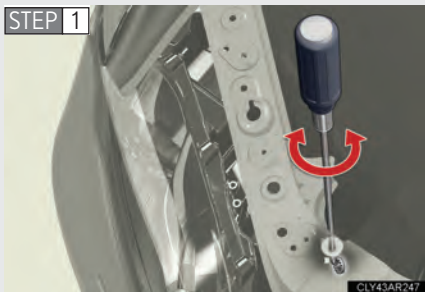

Turn bolt A in either direction using a Phillips-head screwdriver.

Remember the turning direction and the number of turns.

STEP 2

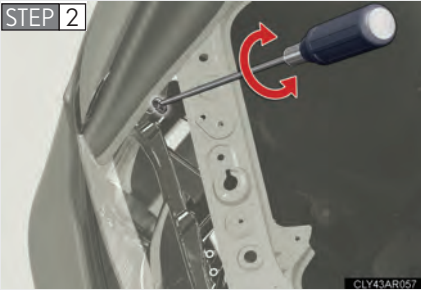

Turn bolt B the same number of turns and in the same direction as in step 1 using a Phillips-head screwdriver.

If the headlight cannot be adjusted using this procedure, take the vehicle to your Lexus dealer to adjust the headlight aim.

4-3. Do-it-yourself maintenance

Light bulbs

You may replace the following bulbs by yourself. The difficulty level of replacement varies depending on the bulb. If necessary bulb replacement seems difficult to perform, contact your Lexus dealer.

For more information about replacing other light bulbs, contact your Lexus dealer.

■ Preparing for light bulb replacement

Check the wattage of the light bulb to be replaced. (→P. 594)

■ Remove the engine compartment covers

→P. 456

■ Turning off the power back door main switch (if equipped)

→P. 49

■ Front bulb locations

▶ Discharge headlights

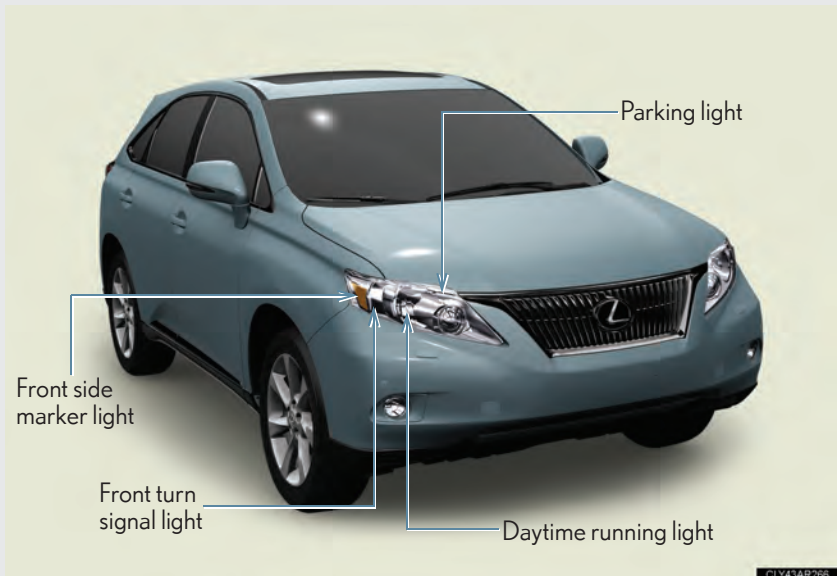

► Halogen headlights



■ Rear bulb locations

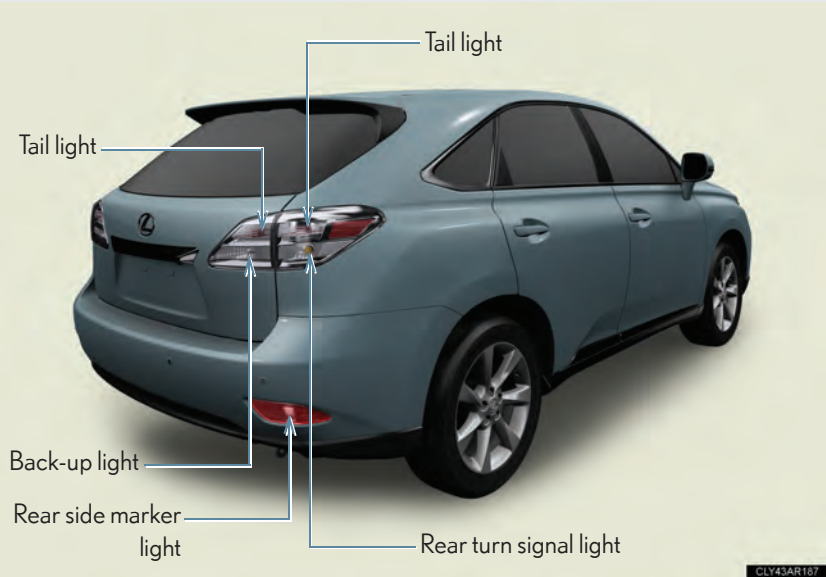

Replacing light bulbs

Daytime running lights (discharge headlights)

STEP 1



Turn the bulb base counterclockwise.

STEP 2

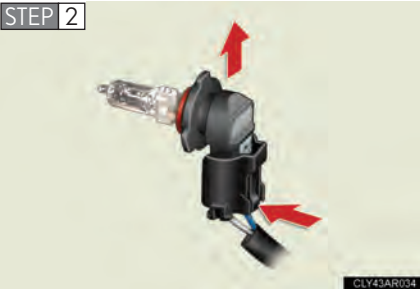

Unplug the connector while depressing the lock release.

Headlight high beams (halogen headlights)

STEP 1

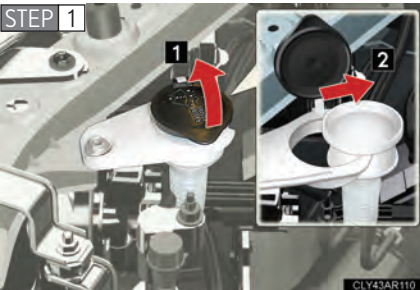

Right side only:

- 1 Open the cap.
- 2 Move the washer fluid filler opening to allow easy access to the light bulbs.

STEP 2



Turn the bulb base counterclockwise.

STEP 3



Unplug the connector while depressing the lock release.

■ Headlight low beams (halogen headlights)

STEP 1



Turn the bulb base counterclockwise.

STEP 2



Unplug the connector while pressing the lock release.

■ Parking lights

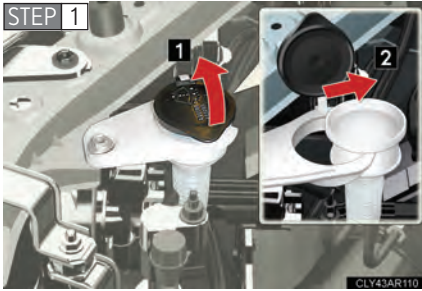

Right side only:

- 1 Open the cap.
- 2 Move the washer fluid filler opening to allow easy access to the light bulbs.

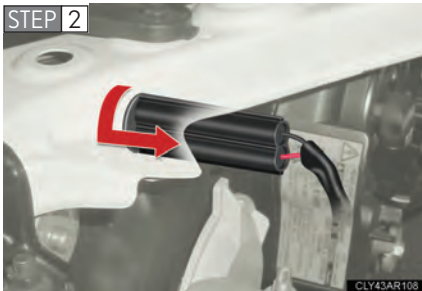

Turn the bulb base counterclockwise.

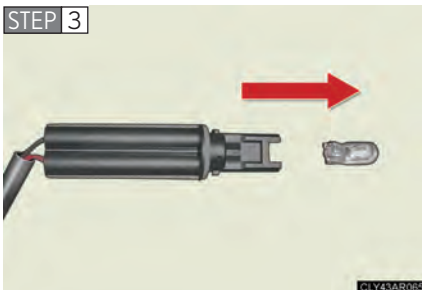

Remove the light bulb.

■ Front turn signal lights

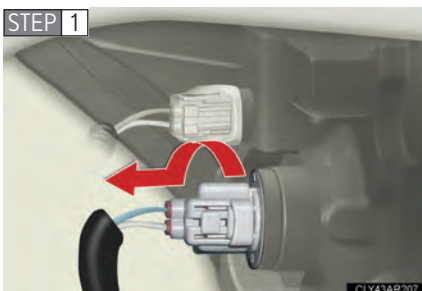

Turn the bulb base counterclockwise.

STEP 2

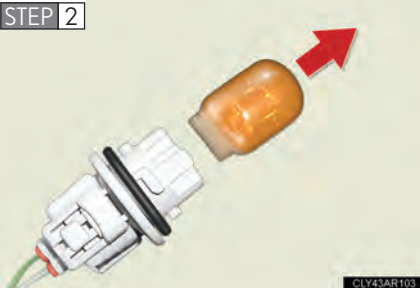

Remove the light bulb.

Front side marker lights

STEP 1

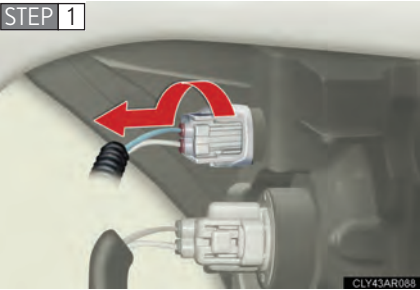

Turn the bulb base counterclockwise.

STEP 2

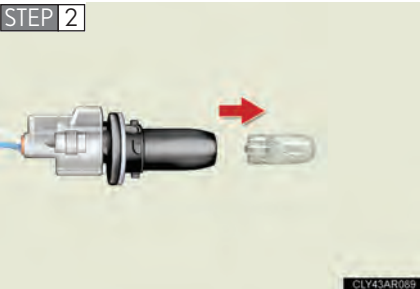

Remove the light bulb.

Rear turn signal and tail lights

STEP 1

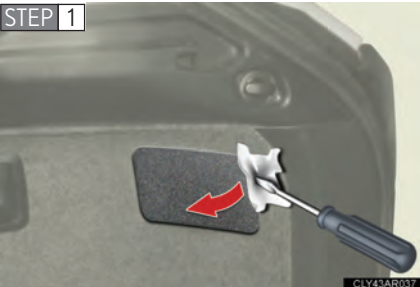

Remove the access hole cover.

Use a flathead screwdriver wrapped in a cloth.

STEP 2

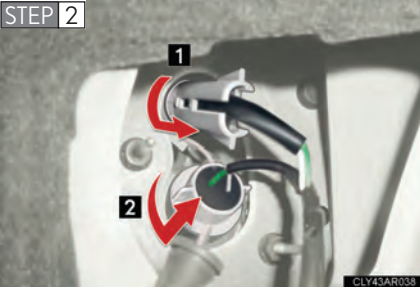

Turn the bulb base counterclockwise.

- 1** Tail light
- 2** Rear turn signal light

STEP 3

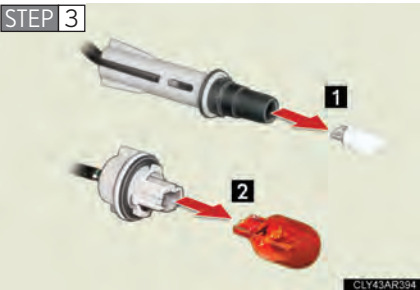

Remove the light bulb.

- 1** Tail light
- 2** Rear turn signal light

Rear side marker lights (right side)

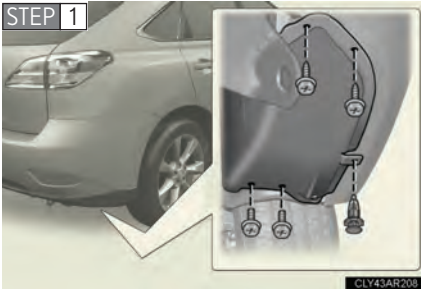

Remove the bolts using a Phillips-head screwdriver, and remove the clip.

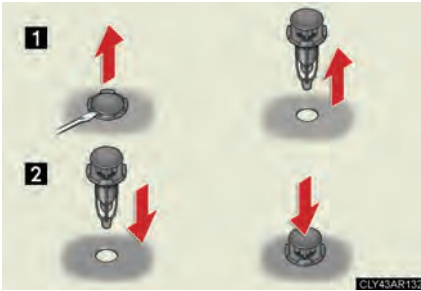

- 1 Removing the clip
- 2 Installing the clip



Turn the bulb base counterclockwise.



Remove the light bulb.

■ Rear side marker lights (left side)

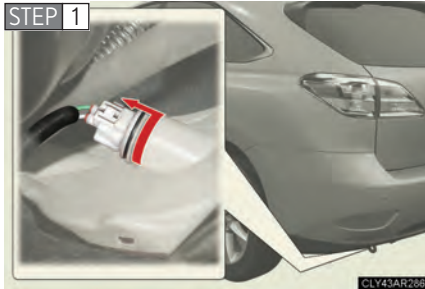

Turn the bulb base counterclockwise.



Remove the light bulb.

■ Tail and back-up lights



Remove the access hole cover.

Use a flathead screwdriver wrapped in a cloth.

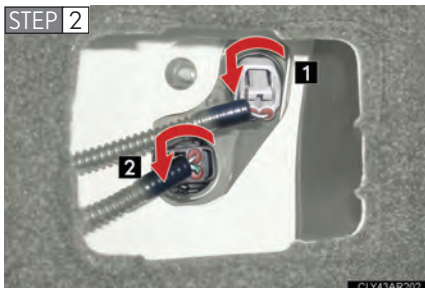

Turn the bulb base counterclockwise.

- 1 Tail light
- 2 Back-up light

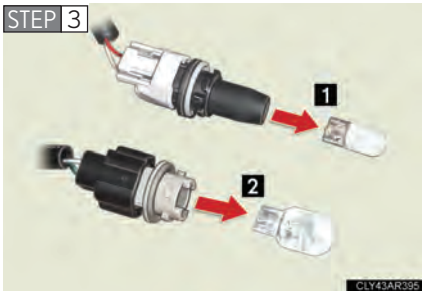

Remove the light bulb.

- 1 Tail light
- 2 Back-up light

■ Lights other than the above

If any of the lights listed below has burnt out, have it replaced by your Lexus dealer.

- Headlight low beams (discharge bulbs)
- Front fog lights
- Side turn signal lights
- Stop lights
- High mounted stoplight
- License plate lights

■ Discharge headlights

If voltage to the discharge bulbs is insufficient, the bulbs may not come on, or may go out temporarily. The discharge bulbs will come on when normal power is restored.

■ LED bulbs

The stop lights, side turn signal lights, license plate lights and high mounted stoplight consist of a number of LEDs. If any of the LEDs burn out, take your vehicle to your Lexus dealer to have the light replaced.

■ Condensation build-up on the inside of the lens

Contact your Lexus dealer for more information in the following situations. Temporary condensation build-up on the inside of the headlight lens does not indicate a malfunction.

- Large drops of water are built up on the inside of the lens.
- Water has built up inside the headlight.

 **CAUTION**

■ **Replacing light bulbs**

- Turn off the lights. Do not attempt to replace the bulb immediately after turning off the lights.
The bulbs become very hot and may cause burns.
- Do not touch the glass portion of the light bulb with bare hands. Hold the bulb by the plastic or metal portion.
If the bulb is scratched or dropped it may blow out or crack.
- Fully install light bulbs and any parts used to secure them. Failing to do so may result in heat damage, fire, or water entering the headlight unit. This may damage the headlights or cause condensation to build up on the lens.

■ **Discharge headlights (if equipped)**

- Contact your Lexus dealer before replacing discharge headlights (including light bulbs).
- Do not touch the discharge headlight's high voltage socket when the headlights are turned on.
An extremely high voltage of 20000 V will be discharged and could result in serious injury or death by electric shock.
- Do not attempt to take apart or repair the low beam discharge headlight bulbs, connectors, power supply circuits, or related components.
Doing so could result in electric shock and serious injury or death.

■ **To prevent damage or fire**

Make sure bulbs are fully seated and locked.

5-1. Essential information

Emergency flashers 516
If your vehicle needs to
be towed 517
If you think something is
wrong 522
Fuel pump shut off system ... 523
Event data recorder 524

**5-2. Steps to take in an
emergency**

If a warning light turns
on or a warning buzzer
sounds... 526
If a warning message is
displayed..... 536
If you have a flat tire..... 555
If the engine will not start 568
If the shift lever cannot
be shifted from P 570
If you lose your keys 571
If the electronic key does
not operate properly..... 572
If the battery is
discharged 575
If your vehicle overheats 578
If the vehicle becomes
stuck..... 581

5-1. Essential information

Emergency flashers

Use the emergency flashers if the vehicle malfunctions or is involved in an accident.

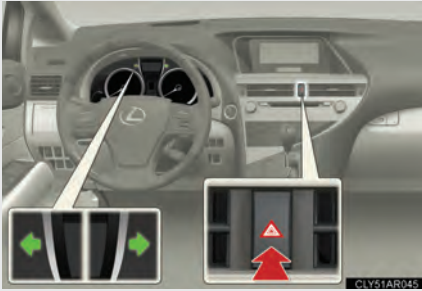

Press the switch to flash all the turn signal lights. To turn them off, press the switch once again.

NOTICE

■ To prevent battery discharge

Do not leave the emergency flashers on longer than necessary when the engine is not running.

5-1. Essential information

If your vehicle needs to be towed

If towing is necessary, we recommend having your vehicle towed by your Lexus dealer or a commercial towing service, using a lift-type truck or a flatbed truck.

Use a safety chain system for all towing, and abide by all state/provincial and local laws.

Before towing

The following may indicate a problem with your transmission. Contact your Lexus dealer before towing.

- The engine is running, but the vehicle will not move.
- The vehicle makes an abnormal sound.

Emergency towing



If a tow truck is not available in an emergency, your vehicle may be temporarily towed using a cable or chain secured to the emergency towing eyelet(s). This should only be attempted on hard, surfaced roads for short distances at low speeds.

A driver must be in the vehicle to steer and operate the brakes. The vehicle's wheels, drive train, axles, steering and brakes must be in good condition.

Installing towing eyelets

STEP 1

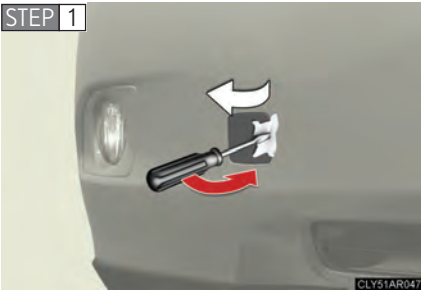

Remove the eyelet cover using a flathead screwdriver.

To protect the bodywork, place a rag between the screwdriver and the vehicle body, as shown in the illustration.

STEP 2

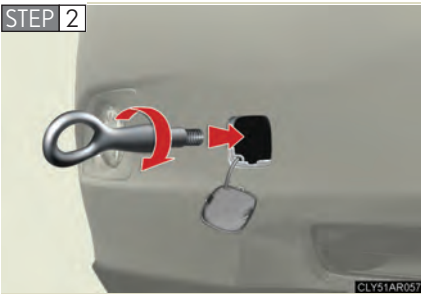

Insert the towing eyelet into the hole and tighten partially by hand.

STEP 3

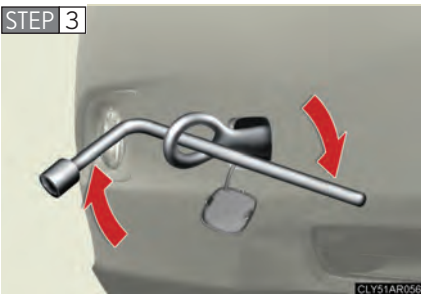

Tighten down the towing eyelet securely using a wheel nut wrench.

Towing with a sling-type truck



Do not tow with a sling-type truck to prevent body damage.

Towing with a wheel-lift type truck

- ▶ From the front (2WD models)

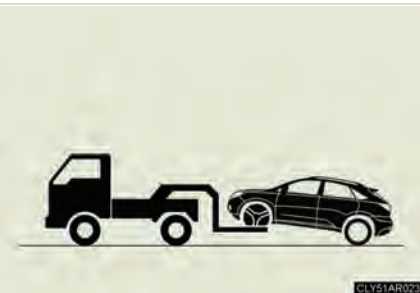

Release the parking brake.

- ▶ From the front (AWD models)

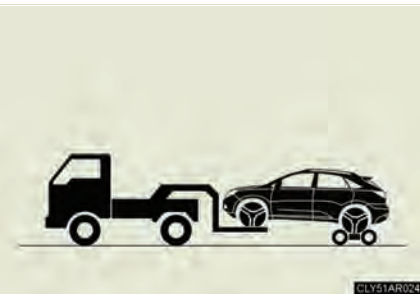

Use a towing dolly under the rear wheels.

► From the rear



Use a towing dolly under the front wheels.

Using a flatbed truck

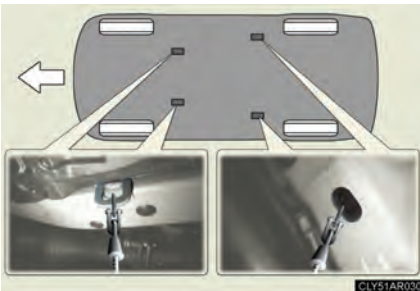

If your Lexus is transported by a flatbed truck, it should be tied down at the locations shown in the illustration.



If you use chains or cables to tie down your vehicle, the angles shaded in black must be 45° .

Do not overly tighten the tie downs or the vehicle may be damaged.

■ Before emergency towing

STEP 1 Release the parking brake.

STEP 2 Shift the shift lever to N.

STEP 3 Turn the “ENGINE START STOP” switch to ACCESSORY (engine off) or IGNITION ON (engine running) mode.

■ Location of the emergency towing eyelet

→P. 556

CAUTION

■ Caution while towing

- Use extreme caution when towing the vehicle.
Avoid sudden starts or erratic driving maneuvers which place excessive stress on the emergency towing eyelets and the cables or chains.
- If the engine is not running, the power assist for the brakes and steering will not function, making steering and braking more difficult.

■ Installing towing eyelets to the vehicle

Make sure that towing eyelets are installed securely.
If not securely installed, towing eyelets may come loose during towing. This may lead to accidents that cause serious injury or even death.

NOTICE

■ To prevent causing serious damage to the transmission and transfer (AWD models) when towing using a wheel-lift type truck

2WD models: Never tow this vehicle from the rear with the front wheels on the ground.

AWD models: Never tow this vehicle with any of the wheels in contact with the ground.

■ To prevent damaging the vehicle when towing using a wheel-lift type truck

When raising the vehicle, ensure adequate ground clearance for towing at the opposite end of the raised vehicle. Without adequate clearance, the vehicle could be damaged while being towed.

■ To prevent body damage when towing with a sling-type truck

Do not tow with a sling-type truck, either from the front or rear.

5-1. Essential information

If you think something is wrong

If you notice any of the following symptoms, your vehicle probably needs adjustment or repair. Contact your Lexus dealer as soon as possible.

■ Visible symptoms

- Fluid leaks under the vehicle.
(Water dripping from the air conditioning after use is normal.)
- Flat-looking tires or uneven tire wear
- Engine coolant temperature gauge needle continually points higher than normal.

■ Audible symptoms

- Changes in exhaust sound
- Excessive tire squeal when cornering
- Strange noises related to the suspension system
- Pinging or other noises related to the engine

■ Operational symptoms

- Engine missing, stumbling or running rough
- Appreciable loss of power
- Vehicle pulls heavily to one side when braking
- Vehicle pulls heavily to one side when driving on a level road
- Loss of brake effectiveness, spongy feeling, pedal almost touches the floor

5-1. Essential information

Fuel pump shut off system

To minimize the risk of fuel leakage when the engine stalls or when an airbag inflates upon collision, the fuel pump shut off system stops the supply of fuel to the engine.

Follow the procedure below to restart the engine after the system is activated.

STEP 1 Turn the “ENGINE START STOP” switch to ACCESSORY mode or turn it off.

STEP 2 Restart the engine.

NOTICE

Before starting the engine

Inspect the ground under the vehicle.

If you find that fuel has leaked onto the ground, the fuel system has been damaged and is in need of repair. Do not restart the engine.

5-1. Essential information

Event data recorder

Your vehicle has computers that monitor and control certain aspects of your vehicle. These computers assist in driving and maintaining optimal vehicle performance.

Besides storing data useful for troubleshooting, there is an event data recorder (EDR) that records data in a crash or near crash event.

In a crash or a near crash event

The SRS airbag sensor assembly contains the EDR. In a crash or near crash event, this device may record some or all of the following information:

- Engine speed
- Whether the brake pedal was applied or not
- Vehicle speed
- To what extent the accelerator pedal was depressed
- Position of the transmission shift lever
- Whether the driver and front passenger wore seat belts or not
- Driver's seat position
- SRS airbag deployment data
- SRS airbag system diagnostic data
- Front passenger's occupant classification

The information above is intended to be used for the purpose of improving vehicle safety performance. Unlike general data recorders, the EDR does not record sound data such as conversation between passengers.

Disclosure of the data

Lexus will not disclose the data recorded in an EDR to a third party except when:

- An agreement from the vehicle's owner (or the leasing company for a leased vehicle) is obtained
- Officially requested to by the police or other authorities
- Necessary, for use as a defense for Lexus in a law suit
- Ordered to by a court of law

However, if necessary Lexus will:

- Use the data for research on Lexus vehicle safety performance
- Disclose the data to a third party for research purposes without disclosing details of the vehicle owner, and that only when deemed necessary
- Disclose summarized data cleared of vehicle identification information to a non-Lexus organization for research purposes



5-2. Steps to take in an emergency

If a warning light turns on or a warning buzzer sounds...

Calmly perform the following actions if any of the warning lights comes on or flashes. If a light comes on or flashes, but then goes off, this does not necessarily indicate a malfunction in the system.

Stop the vehicle immediately. Continuing to drive the vehicle may be dangerous.

The following warning indicates a possible problem in the brake system. Immediately stop the vehicle in a safe place and contact your Lexus dealer.

Warning light	Warning light/Details
 (U.S.A.)	Brake system warning light (warning buzzer)* <ul style="list-style-type: none">• Low brake fluid• Malfunction in the brake system This light also comes on when the parking brake is not released. If the light turns off after the parking brake is fully released the system is operating normally.
 (Canada)	

*: Parking brake engaged warning buzzer

→P. 542







Stop the vehicle immediately.

The following warning indicates the possibility of damage to the vehicle that may lead to an accident. Immediately stop the vehicle in a safe place and contact your Lexus dealer.

Warning light	Warning light/Details
	Charging system warning light Indicates a malfunction in the vehicle's charging system





Have the vehicle inspected by your Lexus dealer immediately.

Failing to investigate the cause of the following warnings may lead to the system operating abnormally and possibly cause an accident. Have the vehicle inspected by your Lexus dealer immediately.

Warning light	Warning light/Details
 (U.S.A.)  (Canada)	Malfunction indicator lamp Indicates a malfunction in: <ul style="list-style-type: none"> • The electronic engine control system; • The electronic throttle control system; or • The electronic automatic transmission control system
	SRS warning light Indicates a malfunction in: <ul style="list-style-type: none"> • The SRS airbag system; • The front passenger occupant classification system; or • The seat belt pretensioner system
 (U.S.A.)  (Canada)	ABS warning light Indicates a malfunction in: <ul style="list-style-type: none"> • The ABS; or • The brake assist system
	Electric power steering system warning light Indicates a malfunction in the EPS (Electric Power Steering) system
	Pre-collision system warning light (if equipped) Indicates a malfunction in the pre-collision system

Follow the correction procedures.

After taking the specified steps to correct the suspected problem, check that the warning light goes off.

Warning light	Warning light/Details	Correction procedure
	<p>Open door warning light (warning buzzer)*¹ Indicates that one or more of the doors is not fully closed.</p>	<p>Check that all the doors are closed.</p>
	<p>Low fuel level warning light Indicates remaining fuel is approximately 2.8 gal. (10.7 L, 2.4 Imp. gal.) or less</p>	<p>Refuel the vehicle.</p>
 <p>(On the instrument panel)</p>	<p>Driver's seat belt reminder light (warning buzzer)*² Warns the driver to fasten his/her seat belt.</p>	<p>Fasten the seat belt.</p>
 <p>(On the center panel)</p>	<p>Front passenger's seat belt reminder light (warning buzzer)*² Warns the front passenger to fasten his/her seat belt.</p>	<p>Fasten the seat belt.</p>
	<p>Master warning light A buzzer sounds and the warning light comes on and flashes to indicate that the master warning system has detected a malfunction.</p>	<p>→P. 536</p>

Warning light	Warning light/Details	Correction procedure
	Tire pressure warning light	
	When the light comes on: Low tire inflation pressure.	Adjust the tire inflation pressure.
	When the light comes on after flashing for 1 minute: Malfunction in the tire pressure warning system.	Have the system checked by your Lexus dealer.

*1: Open door warning buzzer:

The open door warning buzzer sounds to alert one or more of the doors is not fully closed (with the vehicle having reached a speed of 3 mph [5 km/h]). (→P. 542)

*2: Driver's and front passenger's seat belt buzzer:

The driver's and front passenger's seat belt buzzer sounds to alert the driver and front passenger that his or her seat belt is not fastened. The buzzer sounds intermittently for 10 seconds after the vehicle reaches a speed of 12 mph (20 km/h). Then, if the seat belt is still unfastened, the buzzer will sound in a different tone for 20 more seconds.

■ SRS warning light

This warning light system monitors the airbag sensor assembly, front airbag sensors, side and curtain shield airbag sensors, curtain shield airbag sensors, driver's seat position sensor, driver's seat belt buckle switch, front passenger occupant classification system, "AIR BAG ON" indicator light, "AIR BAG OFF" indicator light, front passenger's seat belt buckle switch, seat belt pretensioner assemblies, inflators, interconnecting wiring and power sources. (→P. 103)

■ Front passenger detection sensor, passenger seat belt reminder and warning buzzer

- If luggage is placed on the front passenger seat, the front passenger detection sensor may cause the warning light to flash and the warning buzzer to sound even if a passenger is not sitting in the seat.
- If a cushion is placed on the seat, the sensor may not detect a passenger, and the warning light may not operate properly.

■ Electric power steering warning light

When the voltage is low or drops, the power steering warning light may come on.

■ If the malfunction indicator lamp comes on while driving

First check the following:

- Is the fuel tank empty?
If it is, fill the fuel tank immediately.
- Is the fuel tank cap loose?
If it is, tighten it securely.

The lamp will go off after several driving trips.

If the light does not go off even after several trips, contact your Lexus dealer as soon as possible.

■ When the tire pressure warning light comes on

Check the tire inflation pressure and adjust to the appropriate level. Pushing the tire pressure warning reset switch will not turn off the tire pressure warning light.

■ The tire pressure warning light may come on due to natural causes

The tire pressure warning light may come on due to natural causes such as natural air leaks and tire inflation pressure changes caused by temperature. In this case, adjusting the tire inflation pressure will turn off the warning light (after a few minutes).

■ When a tire is replaced with a spare tire**▶ Compact spare tire**

The compact spare tire is not equipped with a tire pressure warning valve and transmitter. If a tire goes flat, the tire pressure warning light will not turn off even though the flat tire has been replaced with the spare tire. Replace the spare tire with the repaired tire and adjust the tire inflation pressure. The tire pressure warning light will go off after a few minutes.

▶ Full-size spare tire

The spare tire is also equipped with the tire pressure warning valve and transmitter. The tire pressure warning light will turn on if the tire inflation pressure of the spare tire is low. If a tire goes flat, even though the flat tire is replaced with the spare tire, the tire pressure warning light does not turn off. Replace the spare tire with the repaired tire and adjust the proper tire inflation pressure. The tire pressure warning light will turn off after a few minutes.

■ If the tire pressure warning system is not functioning

The tire pressure warning system will be disabled in the following conditions:

(When the condition becomes normal, the system will work properly.)

- If tires not equipped with tire pressure warning valves and transmitters are used
- If the ID code on the tire pressure warning valves and transmitters is not registered in the tire pressure warning computer
- If the tire pressure warning select switch is set to a different tire setting.
- If the tire inflation pressure is 73 psi (500 kPa, 5.1 kgf/cm² or bar) or higher

The tire pressure warning system may be disabled in the following conditions:

(When the condition becomes normal, the system will work properly.)

- If electronic devices or facilities using similar radio wave frequencies are nearby
- If a radio set at similar frequencies is in use in the vehicle
- If a window tint that affects the radio wave signals is installed
- If there is a lot of snow or ice on the vehicle, in particular around the wheels or wheel housings
- If non-genuine Lexus wheels are used (Even if you use Lexus wheels, the tire pressure warning system may not work properly with some types of tires.)
- If tire chains are used
- If the full-size spare tire is in a location subject to poor radio wave signal reception.
- If a large metallic object which can interfere with signal reception is put in the luggage compartment (vehicles with full-size spare tire).

■ If the tire pressure warning light comes on after flashing frequently for 1 minute

If the tire pressure warning light comes on after flashing frequently for 1 minute when the "ENGINE START STOP" switch is turned to IGNITION ON mode, have it checked by your Lexus dealer.

■ Customization

The vehicle speed linked seat belt reminder buzzer can be disabled.
(Customizable features →P. 610)

 **CAUTION****■ When the power steering warning light comes on**

The steering wheel may become extremely heavy.

If the steering wheel becomes heavier than usual when operating, hold firmly and operate it using more force than usual.

■ If the tire pressure warning light comes on

Be sure to observe the following precautions. Failure to do so could cause loss of vehicle control and result in death or serious injury.

- Stop your vehicle in a safe place as soon as possible. Adjust the tire inflation pressure immediately.
- If the tire pressure warning light comes on even after tire inflation pressure adjustment, it is probable that you have a flat tire. Check the tires. If a tire is flat, change it with the spare tire and have the flat tire repaired by the nearest Lexus dealer.
- Avoid abrupt maneuvering and braking. If the vehicle tires deteriorate, you could lose control of the steering wheel or the brakes.

■ If a blowout or sudden air leakage should occur

The tire pressure warning system may not activate immediately.

CAUTION

■ Maintenance of the tires

Each tire, including the spare (if provided), should be checked monthly when cold and inflated to the inflation pressure recommended by the vehicle manufacturer on the vehicle placard or tire inflation pressure label (tire and load information label). (If your vehicle has tires of a different size than the size indicated on the vehicle placard or tire inflation pressure label [tire and load information label], you should determine the proper tire inflation pressure for those tires.)

As an added safety feature, your vehicle has been equipped with a tire pressure monitoring system (TPMS-tire pressure warning system) that illuminates a low tire pressure telltale (tire pressure warning light) when one or more of your tires is significantly under-inflated. Accordingly, when the low tire pressure telltale (tire pressure warning light) illuminates, you should stop and check your tires as soon as possible, and inflate them to the proper pressure. Driving on a significantly under-inflated tire causes the tire to overheat and can lead to tire failure. Under-inflation also reduces fuel efficiency and tire tread life, and may affect the vehicle's handling and stopping ability.

Please note that the TPMS (tire pressure warning system) is not a substitute for proper tire maintenance, and it is the driver's responsibility to maintain correct tire pressure, even if under-inflation has not reached the level to trigger illumination of the TPMS low tire pressure telltale (tire pressure warning light).

Your vehicle has also been equipped with a TPMS (tire pressure warning system) malfunction indicator to indicate when the system is not operating properly. The TPMS (tire pressure warning system) malfunction indicator is combined with the low tire pressure telltale (tire pressure warning light). When the system detects a malfunction, the telltale will flash for approximately one minute and then remain continuously illuminated. This sequence will continue upon subsequent vehicle start-ups as long as the malfunction exists. When the malfunction indicator is illuminated, the system may not be able to detect or signal low tire pressure as intended.

TPMS (tire pressure warning system) malfunctions may occur for a variety of reasons, including the installation of replacement or alternate tires or wheels on the vehicle that prevent the TPMS (tire pressure warning system) from functioning properly. Always check the TPMS (tire pressure warning system) malfunction telltale after replacing one or more tires or wheels on your vehicle to ensure that the replacement or alternate tires and wheels allow the TPMS (tire pressure warning system) to continue to function properly.

 NOTICE**■ Precaution when installing a different tire**

When a tire of a different specification or maker is installed, the tire pressure warning system may not operate properly.

5-2. Steps to take in an emergency

If a warning message is displayed

If a warning is shown on the multi-information display, stay calm and perform the following actions:



1 Master warning light

The master warning light also comes on or flashes in order to indicate that a message is currently being displayed on the multi-information display.

2 Multi-information display

If any of the warning lights comes on again after the following actions have been performed, contact your Lexus dealer.



Stop the vehicle immediately. Continuing to drive the vehicle may be dangerous.

The following warning indicates a possible problem in the brake system. Immediately stop the vehicle in a safe place and contact your Lexus dealer.

Warning message	Details
	<p>Indicates the following:</p> <ul style="list-style-type: none">• The brake fluid level is low; or,• The brake system is malfunctioning. <p>A buzzer also sounds.</p>





Stop the vehicle immediately.









A buzzer sounds and a warning message is shown on the multi-information display. The following warning indicates the possibility of damage to the vehicle that may lead to an accident. Immediately stop the vehicle in a safe place and contact your Lexus dealer.



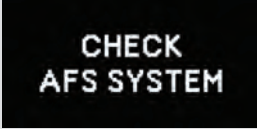

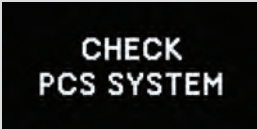
Warning message	Details
<div data-bbox="114 516 373 646" style="background-color: black; color: white; padding: 5px; text-align: center;">ENGINE OIL PRESSURE LOW</div> <div data-bbox="114 656 210 716" style="text-align: center;">  </div>	<p>Indicates abnormal engine oil pressure The warning light may come on if the engine oil pressure is too low.</p>
<div data-bbox="114 748 373 878" style="background-color: black; color: white; padding: 5px; text-align: center;">AWD OVERHEAT</div> <div data-bbox="114 888 210 948" style="text-align: center;">  </div> <p data-bbox="217 894 312 927">(Flashes)</p> <p data-bbox="171 954 312 987">(If equipped)</p>	<p>Indicates the AWD system has overheated</p>



Have the vehicle inspected by your Lexus dealer immediately.

A buzzer sounds and a warning message is shown on the multi-information display. Failure to investigate the cause of the following warnings may lead to the system operating abnormally and possibly cause an accident. Have the vehicle inspected by your Lexus dealer immediately.

Warning message	Details
<p>CHECK AWD SYSTEM</p>  <p>(If equipped)</p>	<p>Indicates a malfunction in the AWD system</p>
<p>HIGH TRANSMISSION FLUID TEMP.</p> 	<p>Indicates that the automatic transmission fluid temperature is too high</p>
<p>CHECK BRAKE LAMP SYSTEM</p> 	<p>Indicates a malfunction in the brake lights system</p>
<p>CHECK STEERING LOCK SYSTEM</p> 	<p>Indicates a malfunction in the steering lock system</p>

Warning message	Details
  (If equipped)	Indicates a malfunction in the electronically modulated air suspension system
  (Flashes)  (If equipped)	Indicates a malfunction in the adaptive front lighting system
  (If equipped)	Indicates a malfunction in the pre-collision system
  (If equipped)	Indicates a malfunction in the intuitive parking assist The malfunctioning assist-sensor is flashing.

Warning message	Details
<p>CHECK CRUISE CONTROL SYSTEM</p> <p> (Flashes) or  (Flashes)</p> <p> (If equipped)</p>	<p>Indicates a malfunction in the radar cruise control system</p> <p>Stop the vehicle in a safe place. Turn the “ENGINE START STOP” switch off and then turn it to IGNITION ON mode again to reset the cruise control system.</p>
<p>CHECK HEADLIGHT LEVELING SYSTEM</p> <p> (If equipped)</p>	<p>Indicates a malfunction in the automatic headlight leveling system</p>
<p>CHECK SRS SYSTEM AIRBAG</p> <p></p>	<p>Indicates a malfunction in:</p> <ul style="list-style-type: none"> • The SRS airbag system; • The front passenger occupant classification system; or, • The seat belt pretensioner system
<p>CHECK ABS</p>	<p>Indicates a malfunction in:</p> <ul style="list-style-type: none"> • The ABS; or, • The brake assist system

Warning message	Details
 <p>CHECK POWER STEERING SYSTEM</p> 	<p>Indicates a malfunction in the EPS (Electric Power Steering) system</p>

Follow the correction procedures.



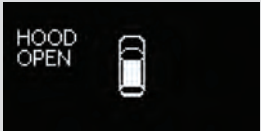





A buzzer sounds and a warning message is shown on the multi-information display. After taking the specified steps to correct the suspected problem, check that the warning message goes off.

Warning message	Details	Correction procedure
	<p>Indicates that one or more of the doors is not fully closed</p> <p>The system also indicates which doors are not fully closed.</p> <p>If the vehicle reaches a speed of 3 mph (5 km/h), a buzzer sounds to indicate that the door(s) are not yet fully closed.</p>	<p>Make sure that all the doors are closed.</p>
	<p>Indicates that the hood is not fully closed</p> <p>If the vehicle reaches a speed of 3 mph (5 km/h), a buzzer sounds to indicate that the hood is not yet fully closed.</p>	<p>Close the hood.</p>

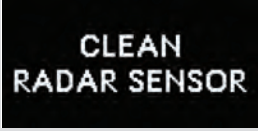

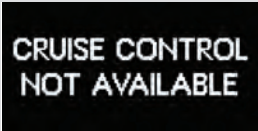
Warning message	Details	Correction procedure
	<p>Indicates that the back door is not fully closed</p> <p>If the vehicle reaches a speed of 3 mph (5 km/h), a buzzer sounds to indicate that the back door is not yet fully closed.</p>	<p>Close the back door.</p>
  (Flashes) (If equipped)	<p>Indicates that the moon roof is not fully closed (with the "ENGINE START STOP" switch off, and the driver's door open)</p>	<p>Close the moon roof.</p>
	<p>Indicates that the parking brake is still engaged</p> <p>If the vehicle reaches a speed of 3 mph (5 km/h),  flashes and a buzzer sounds to indicate that the parking brake is still engaged.</p>	<p>Release the parking brake.</p>
	<p>Indicates that the washer fluid level is low</p>	<p>Add washer fluid.</p>

5-2. Steps to take in an emergency

Warning message	Details	Correction procedure
<p>OIL MAINTENANCE REQUIRED SOON</p> <p>(U.S.A. only)</p>	<p>Indicates that the engine oil is scheduled to be changed</p> <p>Comes on approximately 4500 miles (7200 km) after the engine oil is changed. (The indicator will not work properly unless the oil maintenance data has been reset.)</p>	<p>Check the engine oil, and change if necessary.</p>
<p>OIL MAINTENANCE REQUIRED</p> <p>(U.S.A. only)</p>	<p>Indicates that the engine oil and oil filter should be changed</p>	<p>Have the engine oil and oil filter checked and changed by your Lexus dealer.</p>
<p>AWD DISABLED</p> <p> (Flashes) (If equipped)</p>	<p>Indicates that the AWD system is not currently functional</p> <p>A buzzer also sounds.</p>	<p>Reduce vehicle speed or stop the vehicle in a safe place until the warnings clear.</p> <p>In this case, do not stop the engine.</p>
<p>PCS TEMPORARILY NOT AVAILABLE</p> <p>(If equipped)</p>	<p>Indicates that the pre-collision system is not currently functional</p>	<p>Clean the grille and the sensor.</p> <p>This message appears when the pre-collision system is hot. In this case, wait until the system cools down.</p>





Warning message	Details	Correction procedure
  (If equipped)	<p>Indicates that intuitive parking assist is dirty or covered with ice</p> <p>A buzzer also sounds.</p>	<p>Clean the sensor.</p>
  (Flashes)  (If equipped)	<p>Indicates that the radar cruise control sensor is dirty or covered with ice</p> <p>A buzzer also sounds.</p>	<p>Clean the sensor.</p>
  (Flashes)  (If equipped)	<p>Indicates that the radar cruise control system is unable to judge vehicle-to-vehicle distance</p> <p>A buzzer also sounds.</p>	<p>If the windshield wipers are on, turn them off or set them to a mode other than "AUTO" or high speed wiper operation.</p>
 (Flashes) (If equipped)	<p>Indicates that your vehicle is nearing the vehicle ahead (in radar cruise mode)</p> <p>At the same time,</p>  will appear on the head-up display.	<p>Slow the vehicle by applying the brakes.</p>

5-2. Steps to take in an emergency

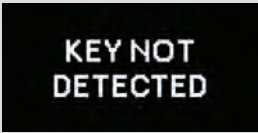

Warning message	Details	Correction procedure
 	Indicates that the engine has overheated A buzzer also sounds.	Stop and check. (→P. 578)
	Indicates that remaining fuel is approximately 2.8 gal. (10.7 L, 2.4 Imp. gal.) or less	Refuel the vehicle.

Have the malfunction repaired immediately.

After taking the specified steps to correct the suspected problem, check that the warning message and light go off.

Interior buzzer	Exterior buzzer	Warning message	Details	Correction procedure
Sounds once	—	  (Flashes)	The electronic key is not detected when an attempt is made to start the engine.	Confirm the location of the electronic key.
Sounds once	Sounds 3 times	  (Flashes)	The electronic key was carried outside the vehicle and a door other than the driver's door was opened and closed while the "ENGINE START STOP" switch was in a mode other than off.	Bring the electronic key back into the vehicle.
			The driver's door was opened and closed while the electronic key was not in the vehicle, the shift lever was in P and the "ENGINE START STOP" switch was not turned off.	Turn the "ENGINE START STOP" switch off or bring the electronic key back into the vehicle.





5-2. Steps to take in an emergency

Interior buzzer	Exterior buzzer	Warning message	Details	Correction procedure
Sounds once	Sounds once	<div style="background-color: black; color: white; padding: 5px; text-align: center; font-weight: bold;">KEY NOT DETECTED</div> <div style="background-color: black; color: white; padding: 5px; text-align: center; font-weight: bold;">TURN POWER OFF</div> (Displayed alternately)  (Flashes)	An attempt was made to exit the vehicle with the electronic key and lock the doors without first turning the “ENGINE START STOP” switch off.	Turn the “ENGINE START STOP” switch off and lock the doors again.
Sounds once	—	<div style="background-color: black; color: white; padding: 5px; text-align: center; font-weight: bold;">KEY NOT DETECTED</div>  (Flashes)	An attempt was made to start the engine without the electronic key being present, or the electronic key was not functioning normally. An attempt was made to drive when the regular key was not inside the vehicle.	Confirm that the electronic key is inside the vehicle.
Continuous	—	<div style="background-color: black; color: white; padding: 5px; text-align: center; font-weight: bold;">SHIFT TO P RANGE</div>  (Flashes)	The driver’s door was opened when the shift lever was not in P and the “ENGINE START STOP” switch was not turned off.	Shift the shift lever to P.



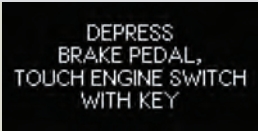

Interior buzzer	Exterior buzzer	Warning message	Details	Correction procedure
Con- tinuous	Con- tinuous	<div data-bbox="288 305 547 435" style="background-color: black; color: white; padding: 5px; text-align: center;">SHIFT TO P RANGE</div> <div data-bbox="288 440 547 570" style="background-color: black; color: white; padding: 5px; text-align: center;">KEY NOT DETECTED</div> <p data-bbox="288 574 547 607">(Displayed alternately)</p> <div data-bbox="288 618 380 678" style="background-color: black; color: yellow; padding: 5px; text-align: center;"></div> <p data-bbox="384 623 487 656">(Flashes)</p>	The driver's door was opened and closed while the electronic key was not in the vehicle, the shift lever was not in P and the "ENGINE START STOP" switch was not turned off.	<ul style="list-style-type: none"> • Shift the shift lever to P. • Bring the electronic key back into the vehicle.

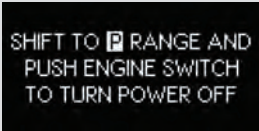

5-2. Steps to take in an emergency

Interior buzzer	Exterior buzzer	Warning message	Details	Correction procedure
Sounds once	Continuous	<div data-bbox="258 613 516 740" style="background-color: black; color: white; padding: 5px; text-align: center; font-weight: bold;">KEY DETECTED IN VEHICLE</div> <div data-bbox="258 751 352 816" style="display: inline-block; text-align: center;">  </div> <div data-bbox="355 760 458 792" style="display: inline-block; vertical-align: middle;">(Flashes)</div>	<p>An attempt was made to lock the doors using the smart access system with push-button start while the electronic key was still inside the vehicle.</p> <p>An attempt was made to lock either front door by opening a door and putting the inside lock button into the lock position, then closing the door by pulling on the outside door handle with the electronic key still inside the vehicle.</p>	Retrieve the electronic key from the vehicle and lock the doors again.

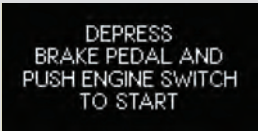

Interior buzzer	Exterior buzzer	Warning message	Details	Correction procedure
Sounds once	—	  (Flashes)	<ul style="list-style-type: none"> • When the doors were unlocked with the mechanical key and then the “ENGINE START STOP” switch was pressed, the electronic key could not be detected in the vehicle. • The electronic key could not be detected in the vehicle even after the “ENGINE START STOP” switch was pressed two consecutive times. 	Touch the electronic key to the “ENGINE START STOP” switch while depressing the brake pedal.
Sounds once	—	  (Flashes)	An attempt was made to start the engine with the shift lever in an incorrect position.	Shift the shift lever to P and start the engine.

5-2. Steps to take in an emergency

Interior buzzer	Exterior buzzer	Warning message	Details	Correction procedure
Sounds once	—	  (Flashes)	An attempt was made to turn the “ENGINE START STOP” switch off when the shift lever was not in P.	To turn off the engine, first shift the shift lever to P and then turn the “ENGINE START STOP” switch off.
—	—		Power was turned off due to the automatic power off function.	Next time when starting the engine, increase the engine speed slightly and maintain that level for approximately 5 minutes to recharge the battery.
Sounds once	—	 	The electronic key has a low battery.	Replace the electronic key battery. (→P. 488)

Interior buzzer	Exterior buzzer	Warning message	Details	Correction procedure
Sounds once	—	  (Flashes)	The driver's door was opened and closed with the "ENGINE START STOP" switch turned off and then the "ENGINE START STOP" switch was put in ACCESSORY mode twice without the engine being started.	Press the "ENGINE START STOP" switch while depressing the brake pedal.
			During an engine starting procedure in the event that the electronic key was not functioning properly (→P. 572), the "ENGINE START STOP" switch was touched with the electronic key.	Press the "ENGINE START STOP" switch within 10 seconds of the buzzer sounding.

5-2. Steps to take in an emergency

Interior buzzer	Exterior buzzer	Warning message	Details	Correction procedure
Sounds once	—	  (Flashes)	The steering lock could not be released within 3 seconds of the “ENGINE START STOP” switch being pressed.	Press the “ENGINE START STOP” switch while depressing the brake pedal and moving the steering wheel left and right.

■ Warning light display in radar cruise mode (if equipped)

In the following cases, the warning light may not be displayed even if vehicle-to-vehicle distance decreases:

- When your vehicle and the vehicle ahead are traveling at the same speed or the vehicle ahead is traveling more quickly than your vehicle
- When the vehicle ahead is traveling at a very low speed
- Immediately after cruise control speed is set
- At the instant the accelerator pedal is depressed

■ After changing the engine oil (U.S.A. only)

Make sure to reset the oil maintenance data. (→P. 458)

5-2. Steps to take in an emergency If you have a flat tire

Remove the flat tire and replace it with the spare provided.

■ Before jacking up the vehicle

- Stop the vehicle on a hard, flat surface.
- Set the parking brake.
- Shift the shift lever to P.
- Vehicles with electronically modulated air suspension: Turn off the height control. (→P. 218)
- Stop the engine.
- Turn on the emergency flashers.

■ Location of the spare tire, jack and tools

► Vehicles with a compact spare tire

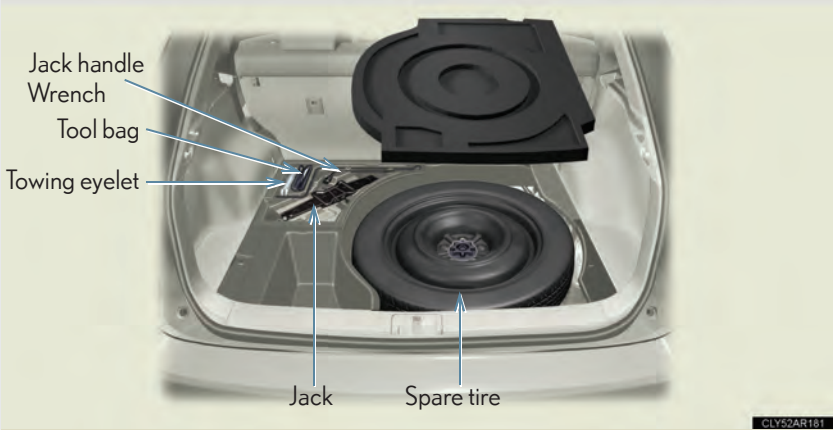

► Vehicles with a full-size spare tire

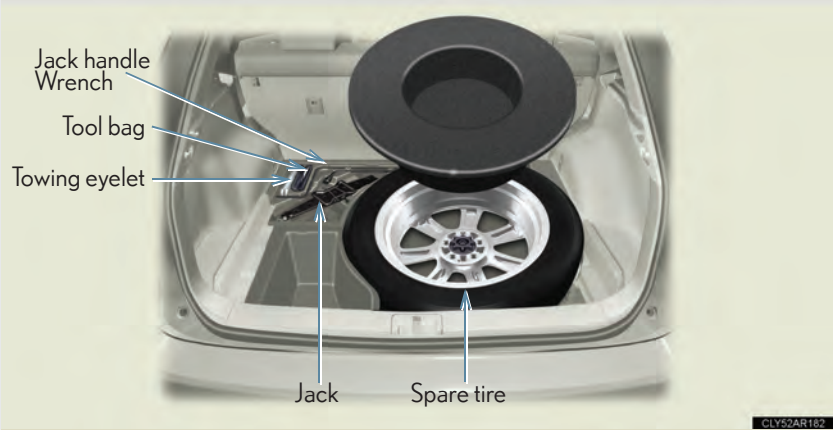

Taking out the jack

► Vehicles with a compact spare tire



Pull the lever upward to fold back the front part of the deck board.



Pull the folded deck board upright.

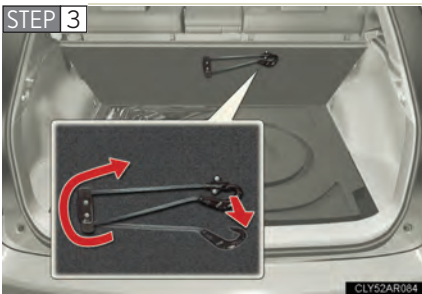

Pull on the attached hook to extend the string.

5-2. Steps to take in an emergency

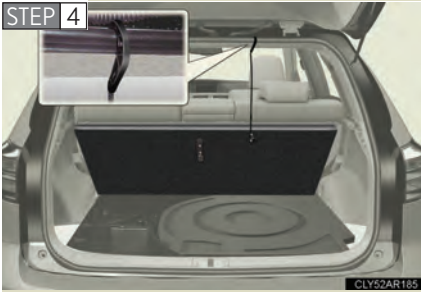

Use the hook to secure the deck board as shown in the illustration.



Remove the jack after removing the hook.

▶ Vehicles with a full-size spare tire

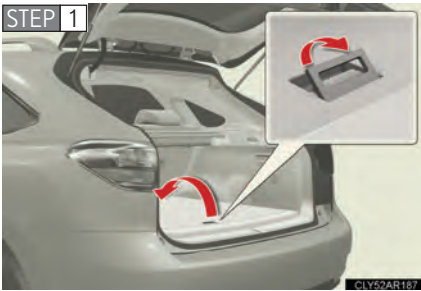

Pull the lever upward to fold back the front part of the deck board.



Pull on the attached hook to extend the string.

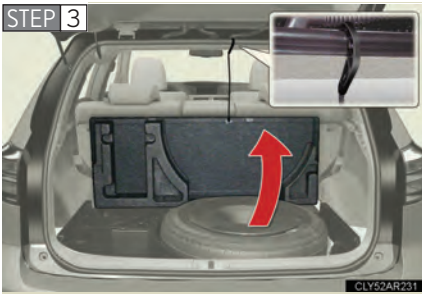

Pull the folded deck board upright, and use the hook to secure the deck board as shown in the illustration.



Remove the jack after removing the hook.

Taking out the spare tire

STEP 1 Lift up the deck board. (See “Taking out the jack” for details.)

STEP 2 Loosen the center fastener that secures the spare tire.

► Vehicles with a compact spare tire



► Vehicles with a full-size spare tire



Replacing a flat tire

STEP 1



Check the tires.

Flat tire		Wheelchock positions
Front	Left-hand side	Behind the rear right-hand side tire
	Right-hand side	Behind the rear left-hand side tire
Rear	Left-hand side	In front of the front right-hand side tire
	Right-hand side	In front of the front left-hand side tire

STEP 2



Slightly loosen the wheel nuts (one turn).

STEP 3



Turn the tire jack portion "A" by hand until the notch of the jack is in contact with the jack point.

5-2. Steps to take in an emergency

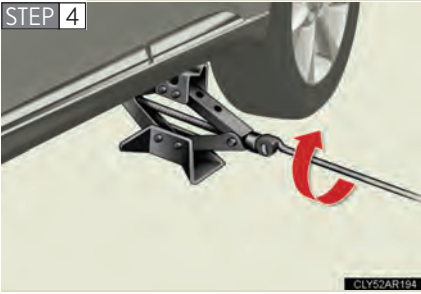

Raise the vehicle until the tire is slightly raised off the ground.

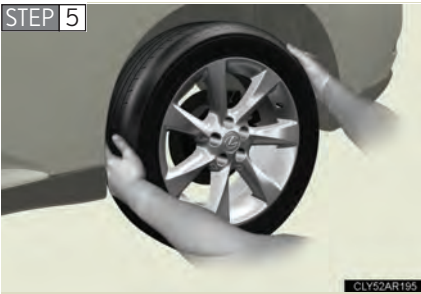

Remove all the wheel nuts and the tire.

When resting the tire on the ground, place the tire so that the wheel design faces up to avoid scratching the wheel surface.

Installing the spare tire

STEP 1

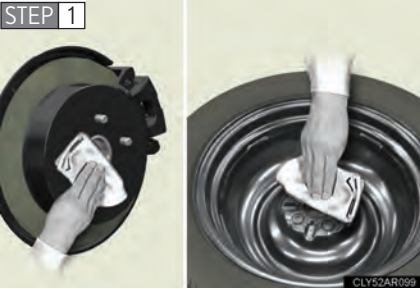

Remove any dirt or foreign matter from the wheel contact surface.

If foreign matter is on the wheel contact surface, the wheel nuts may loosen while the vehicle is in motion, causing the tire to come off.

STEP 2

Install the spare tire and loosely tighten each wheel nut by hand by approximately the same amount.

► Vehicles with a compact spare tire

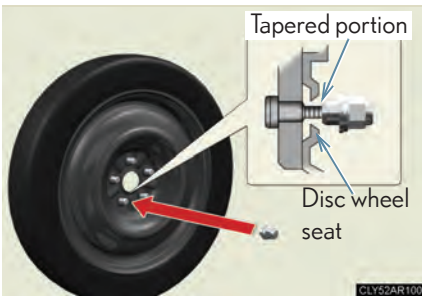

Tighten the nuts until the tapered portion comes into loose contact with the disc wheel seat.

► Vehicles with a full-size spare tire

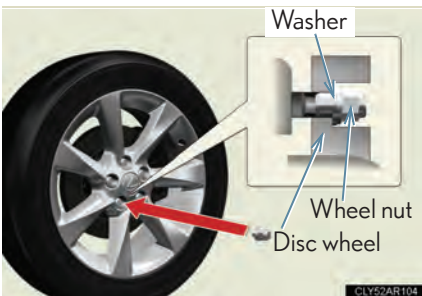

Turn the nuts until the washers come into contact with the wheel.

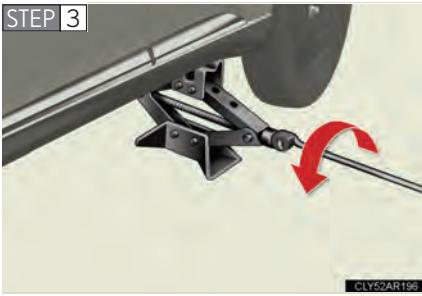

Lower the vehicle.

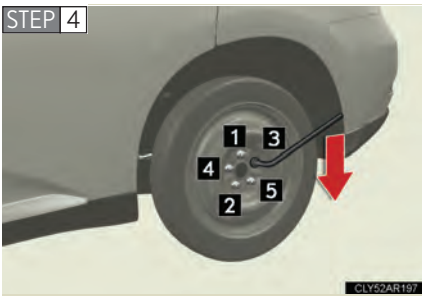

Firmly tighten each wheel nut two or three times in the order shown in the illustration.

Tightening torque:
76 ft•lbf (103 N•m, 10.5 kgf•m)

STEP 5 Stow the flat tire, tire jack and all tools.

■ The compact spare tire

- The compact spare tire is identified by the label “TEMPORARY USE ONLY” on the tire sidewall.
Use the compact spare tire temporarily, and only in an emergency.
- Make sure to check the tire inflation pressure of the compact spare tire.
(→P. 591)

■ When using the compact spare tire

As the compact spare tire is not equipped with a tire pressure warning valve and transmitter, low inflation pressure of the spare tire will not be indicated by the tire pressure warning system. Also, if you replace the compact spare tire after the tire pressure warning light comes on, the light remains on.

■ If you have a flat front tire on a road covered with snow or ice

Install the compact spare tire on one of the rear wheels of the vehicle. Perform the following steps and fit tire chains to the front tires:

STEP 1 Replace a rear tire with the compact spare tire.

STEP 2 Replace the flat front tire with the tire removed from the rear of the vehicle.

STEP 3 Fit tire chains to the front tires.

■ After completing the tire change

The tire pressure warning system must be reset. (→P. 472)

CAUTION

■ Using the tire jack

Improper use of the tire jack may cause the vehicle to suddenly fall off the jack, leading to death or serious injury.

- Do not use the tire jack for any purpose other than replacing tires or installing and removing tire chains.
- Only use the tire jack that comes with this vehicle for replacing a flat tire. Do not use it on other vehicles, and do not use other tire jacks for replacing tires on this vehicle.
- Always check that the tire jack is securely set to the jack point.
- Do not put any part of your body under the vehicle is supported by the jack.
- Do not start or run the engine while your vehicle while it is supported by the jack.
- Do not raise the vehicle while someone is in it.
- When raising the vehicle, do not put an object on or under the jack.
- Do not raise the vehicle to a height greater than that required to replace the tire.
- Use a jack stand if it is necessary to get under the vehicle.
- Vehicles with electronically modulated air suspension: Be sure to turn off the height control and stop the engine.

Take particular care when lowering the vehicle to ensure that no one working on or near the vehicle may be injured.

CAUTION

■ Replacing a flat tire

Observe the following precautions to reduce the risk of death or serious injury:

- Do not touch the disc wheels or the area around the brakes immediately after the vehicle has been driven.

After the vehicle has been driven the disc wheels and the area around the brakes will be extremely hot. Touching these areas with hands, feet or other body parts while changing a tire, etc. may result in burns.

- Never use oil or grease on the wheel bolts or wheel nuts.
Oil and grease may cause the wheel nuts to be excessively tightened, leading to bolt or disc wheel damage. In addition, the oil or grease can cause the wheel nuts to loosen and the wheel may fall off, causing a serious accident. Remove any oil or grease from the wheel bolts or wheel nuts.
- Have the wheel nuts tightened with a torque wrench to 76 ft•lbf (103 N•m, 10.5 kgf•m) as soon as possible after changing wheels.
- When installing a tire, only use wheel nuts that have been specifically designed for that wheel.
- If there are any cracks or deformations in the bolt screws, nut threads or bolt holes of the wheel, have the vehicle inspected by your Lexus dealer.

Failure to follow these precautions could cause the wheel nuts to loosen and the tire to fall off, resulting in death or serious injury.

■ When using the compact spare tire

- Remember that the compact spare tire provided is specifically designed for use with your vehicle. Do not use your compact spare tire on another vehicle.
- Do not use more than one compact spare tire simultaneously.
- Replace the compact spare tire with a standard tire as soon as possible.
- Avoid sudden acceleration, deceleration and braking, as well as sharp cornering.

■ When the compact spare tire is attached

The vehicle speed may not be correctly detected, and the following systems may not operate correctly:

- ABS & Brake assist
- VSC
- TRAC

 **CAUTION**

- Navigation system (if equipped)

Also, not only can the following system not be utilized fully, but it may even negatively affect the drive-train components:

- AWD system (if equipped)

■ Speed limit when using the compact spare tire

Do not drive at speeds in excess of 50 mph (80 km/h) when a compact spare tire is installed on the vehicle.

The compact spare tire is not designed for driving at high speeds. Failure to observe this precaution may lead to an accident causing death or serious injury.

 **NOTICE**

■ Do not drive the vehicle with a flat tire

Do not continue driving with a flat tire.

Driving even a short distance with a flat tire can damage the tire and the wheel beyond repair.

■ Be careful when driving over bumps with the compact spare tire installed on the vehicle.

The vehicle becomes lower when driving with the compact spare tire compared to when driving with standard tires. Be careful when driving over uneven road surfaces.

■ Driving with tire chains and the compact spare tire

Do not fit tire chains to the compact spare tire.

Tire chains may damage the vehicle body and adversely affect driving performance.

■ When replacing the tires

When removing or fitting the wheels, tires or the tire pressure warning valve and transmitter, contact your Lexus dealer as the tire pressure warning valve and transmitter may be damaged if not handled correctly.

■ To avoid damage to the tire pressure warning valves and transmitters

Do not use liquid sealants on flat tires.

5-2. Steps to take in an emergency

If the engine will not start

If the engine will not start, even though correct starting procedures are being followed (→P. 145), consider each of the following points.

■ **The engine will not start, even though the starter motor operates normally.**

One of the following may be the cause of the problem:

- There may not be sufficient fuel in the vehicle's tank.
Refuel the vehicle.
- The engine may be flooded.
Try to restart the engine again following correct starting procedures. (→P. 145)
- There may be a malfunction in the engine immobilizer system.
(→P. 96)

■ **The starter motor turns over slowly, the interior lights and headlights are dim, or the horn does not sound or sounds at a low volume.**

One of the following may be the cause of the problem:

- The battery may be discharged. (→P. 575)
- The battery terminal connections may be loose or corroded.

■ **The starter motor does not turn over.**

The engine starting system may be malfunctioning due to an electrical problem such as an open circuit or a blown fuse. However, an interim measure is available to start the engine. (→P. 569)

- **The starter motor does not turn over, the interior lights and headlights do not turn on, or the horn does not sound.**

One of the following may be the cause of the problem:

- One or both of the battery terminals may be disconnected.
- The battery may be discharged. (→P. 575)
- There may be a malfunction in the steering lock system.

Contact your Lexus dealer if the problem cannot be repaired, or if repair procedures are unknown.

Emergency start function

When the engine does not start, the following steps can be used as an interim measure to start the engine if the “ENGINE START STOP” switch is functioning normally:

STEP 1 Set the parking brake.

STEP 2 Shift the shift lever to P.

STEP 3 Turn the “ENGINE START STOP” switch to ACCESSORY mode.

STEP 4 Press and hold the “ENGINE START STOP” switch for about 15 seconds while depressing the brake pedal firmly.

Even if the engine can be started using the above steps, the system may be malfunctioning. Have the vehicle inspected by your Lexus dealer.

5-2. Steps to take in an emergency

If the shift lever cannot be shifted from P

If the shift lever cannot be shifted with your foot on the brake pedal, there may be a problem with the shift lock system (a system to prevent accidental operation of the shift lever). Have the vehicle inspected by your Lexus dealer immediately.

The following steps may be used as an emergency measure to ensure that the shift lever can be shifted:

STEP 1 Set the parking brake.

STEP 2 Turn the “ENGINE START STOP” switch to ACCESSORY mode.

STEP 3 Depress the brake pedal.



Pry the cover up with a flathead screwdriver or equivalent.



Press the shift lock override button.

The shift lever can be shifted while the button is pressed.

5-2. Steps to take in an emergency

If you lose your keys

New genuine Lexus keys can be made by your Lexus dealer using the other keys and the key number stamped on your key number plate.

5-2. Steps to take in an emergency

If the electronic key does not operate properly

If communication between the electronic key and vehicle is interrupted (→P. 34) or the electronic key cannot be used because the battery is depleted, the smart access system with push-button start and wireless remote control cannot be used. In such cases, the doors can be opened or the engine can be started by following the procedure below.

Locking and unlocking the doors and key linked functions

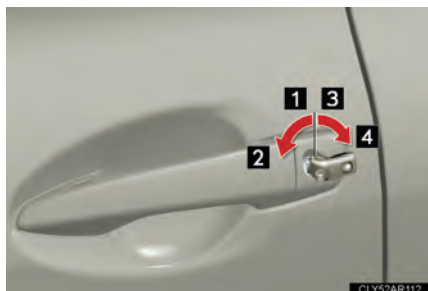

Use the mechanical key (→P. 25) in order to perform the following operations (driver's door only):

- 1 Locks all the doors
- 2 Closes the windows and moon roof (turn and hold)
- 3 Unlocks the door

Turning the key rearward unlocks the driver's door. Turning the key once again unlocks the other doors.

- 4 Opens the windows and moon roof (turn and hold)

Changing “ENGINE START STOP” switch modes and starting the engine

STEP 1 Ensure that the shift lever is in P and depress the brake pedal.



Touch the Lexus emblem side of the electronic key to the “ENGINE START STOP” switch.

If any of the doors is opened or closed while the key is being touched to the switch, an alarm will sound to indicate that the start function cannot detect the electronic key.



STEP 3 To change “ENGINE START STOP” switch modes: Within 10 seconds of the buzzer sounding, release the brake pedal and press the “ENGINE START STOP” switch. Modes can be changed each time the switch is pressed. (→P. 146)

To start the engine: Press the “ENGINE START STOP” switch within 10 seconds of the buzzer sounding, keeping the brake pedal depressed.

In the event that the “ENGINE START STOP” switch still cannot be operated, contact your Lexus dealer.

■ Stopping the engine

Shift the shift lever to P and press the “ENGINE START STOP” switch as you normally do when stopping the engine.

■ Replacing the key battery

As the above procedure is a temporary measure, it is recommended that the electronic key battery be replaced immediately when the battery is depleted.

(→P. 488)

5-2. Steps to take in an emergency If the battery is discharged

The following procedures may be used to start the engine if the vehicle's battery is discharged.

You can call your Lexus dealer or a qualified repair shop.

If you have a set of jumper (or booster) cables and a second vehicle with a 12-volt battery, you can jump start your vehicle by following the steps below.

STEP 1 Open the hood. Remove the battery cover. (→P. 457)

STEP 2

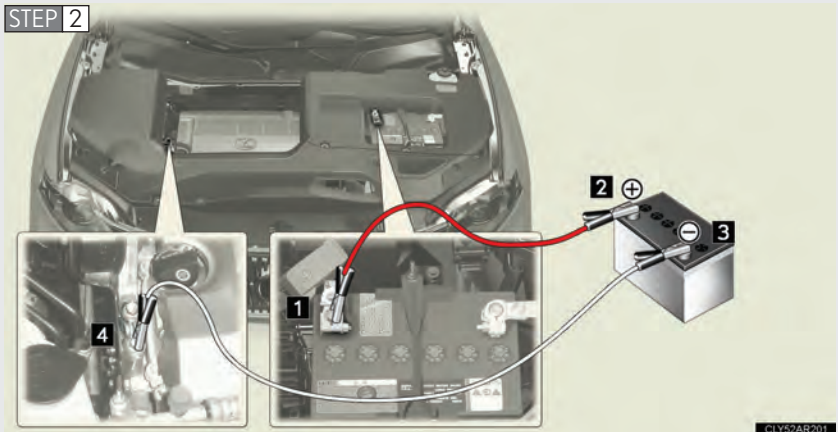

Connect the jumper cables according to the following procedure:

- 1** Connect a positive jumper cable clamp to the positive (+) battery terminal on your vehicle
- 2** Connect a positive jumper cable clamp to the positive (+) battery terminal on the second vehicle

- 3 Connect a negative cable clamp to the negative (-) battery terminal on the second vehicle
- 4 Connect the clamp at the other end of the negative cable to a solid, stationary, unpainted metallic point away from the battery and any moving parts, as shown in the illustration.
- STEP 3** Start the engine of the second vehicle. Increase the engine speed slightly and maintain that level for approximately 5 minutes to recharge the battery of your vehicle.
- STEP 4** Open and close any of the doors with the “ENGINE START STOP” switch off.
- STEP 5** Maintain the engine speed of the second vehicle and start the engine of your vehicle by turning the “ENGINE START STOP” switch to IGNITION ON mode.
- STEP 6** Once the vehicle’s engine has started, remove the jumper cables in the exact reverse order from which they were connected.

Once the engine starts, have the vehicle inspected at your Lexus dealer as soon as possible.

■ Starting the engine when the battery is discharged

The engine cannot be started by push-starting.

■ To prevent battery discharge

- Turn off the headlights and the audio system while the engine is off.
- Turn off any unnecessary electrical components when the vehicle is running at a low speed for an extended period, such as in heavy traffic.

■ When the battery is removed or discharged

The power back door must be initialized. (→P. 619)

 **CAUTION****■ Avoiding battery fires or explosions**

Observe the following precautions to prevent accidentally igniting the flammable gas that may be emitted from the battery:

- Make sure each jumper cable is connected to the correct terminal.
- Do not allow the “+” and “-” terminals of the jumper cables to come into contact with each other.
- Do not smoke, use matches, cigarette lighters or allow open flame near the battery.

■ Battery precautions

The battery contains poisonous and corrosive acidic electrolyte, while related parts contain lead and lead compounds. Observe the following precautions when handling the battery:

- When working with the battery, always wear safety glasses and take care not to allow any battery fluids (acid) to come into contact with skin, clothing or the vehicle body.
- Do not lean over the battery.
- In the event that battery fluid comes into contact with the skin or eyes, immediately wash the affected area with water and seek medical attention. Place a wet sponge or cloth over the affected area until medical attention can be received.
- Always wash your hands after handling the battery support, terminals, and other battery-related parts.
- Do not allow children near the battery.

 **NOTICE****■ When handling jumper cables**

When connecting the jumper cables, ensure that they do not become entangled in the cooling fans or belt.

5-2. Steps to take in an emergency If your vehicle overheats

If your engine overheats:

STEP 1 Stop the vehicle in a safe place and turn off the air conditioning system.

STEP 2 Check to see if steam is coming out from under the hood.

If you see steam:

Stop the engine. Carefully lift the hood after the steam subsides and then restart the engine.

If you do not see steam:

Leave the engine running and carefully lift the hood.

STEP 3 Remove the engine compartment cover. (→P. 456)

STEP 4 Check to see if the cooling fan is operating.

If the fan is operating:

Wait until the temperature of the engine (shown on the instrument panel) begins to fall and then stop the engine.

If the fan is not operating:

Stop the engine immediately and call your Lexus dealer.

STEP 5

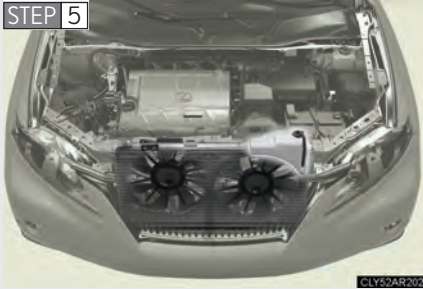

After the engine has cooled down sufficiently, check the engine coolant level and inspect the radiator core (radiator) for any leaks.

STEP 6



Add engine coolant if necessary.

Water can be used in an emergency if engine coolant is unavailable. (→P. 588)

Have the vehicle inspected at the nearest Lexus dealer as soon as possible.

■ Overheating

If you observe the following, your vehicle may be overheating:

- The engine coolant temperature gauge enters the red zone or a loss of power is experienced.
- Steam comes out from under the hood.

⚠ CAUTION

■ To prevent an accident or injury when inspecting under the hood of your vehicle

- If steam is seen coming from under the hood, do not open the hood until the steam has subsided. The engine compartment may be very hot, causing serious injuries such as burns.
- Keep hands and clothing away from the fans and drive belt while the engine is running.
- Do not loosen the radiator cap while the engine and radiator are hot. Serious injury, such as burns, may result from hot coolant and steam released under pressure.

 NOTICE

■ **When adding engine coolant**

Wait until the engine has cooled down before adding engine coolant.

When adding coolant, do so slowly. Adding cool coolant to a hot engine too quickly can cause damage to the engine.

5-2. Steps to take in an emergency If the vehicle becomes stuck

Carry out the following procedures if the tires spin or the vehicle becomes stuck in mud, dirt, or snow:

STEP 1 Stop the engine. Set the parking brake and shift the shift lever to P.

STEP 2 Remove the mud, snow, or sand from around the stuck tire.

STEP 3 Place wood, stones or some other material under the tires to help provide traction.

STEP 4 Restart the engine.

STEP 5 AWD models: Active all-wheel drive lock mode (→P. 234)

STEP 6 Shift the shift lever to the D or R position and carefully apply the accelerator to free the vehicle.

Turn off the TRAC and VSC systems if these functions are hampering your attempts to free the vehicle. (→ P. 230)

CAUTION

■ When attempting to free a stuck vehicle

If you choose to push the vehicle back and forth to free it, make sure the surrounding area is clear to avoid striking other vehicles, objects or people. The vehicle may also lunge forward or lunge back suddenly as it becomes free. Use extreme caution.

■ When shifting the shift lever

Be careful not to shift the shift lever with the accelerator pedal depressed. This may lead to unexpected rapid acceleration of the vehicle that may cause an accident and resulting in death or serious injury.

NOTICE

■ To avoid damage to the transmission and other components

- Avoid spinning the wheels.
- If the vehicle remains stuck even after these procedures are performed, the vehicle may require towing to be freed.

6-1. Specifications

Maintenance data
(fuel, oil level, etc.) 584

Fuel information 595

Tire information 598

6-2. Customization

Customizable features 610

6-3. Initialization

Items to initialize 619

6-1. Specifications

Maintenance data (fuel, oil level, etc.)

Dimensions and weights

Overall length		187.8 in. (4770 mm)
Overall width		74.2 in. (1885 mm)
Overall height *1	Vehicles without an electronically modulated air suspension	66.3 in. (1685 mm)*2 66.7 in. (1695 mm)*3 67.9 in. (1725 mm)*4
	Vehicles with an electronically modulated air suspension	66.3 in. (1685 mm)*2 66.5 in. (1690 mm)*3 67.7 in. (1720 mm)*4
Wheelbase		107.9 in. (2740 mm)
Tread	Front	64.1 in. (1630 mm)
	Rear	63.8 in. (1620 mm)
Vehicle capacity weight (Occupants + luggage)		825 lb. (370 kg)
Towing capacity (Trailer weight + cargo)	Without towing package	2000 lb. (907 kg)
	With towing package	3500 lb. (1588 kg)

*1. Unladen vehicles

*2. Vehicles without roof antenna and roof rails

*3. Vehicles with roof antenna but without roof rails

*4. Vehicles with roof rails

Vehicle identification

■ Vehicle identification number

The vehicle identification number (VIN) is the legal identifier for your vehicle. This is the primary identification number for your Lexus. It is used in registering the ownership of your vehicle.

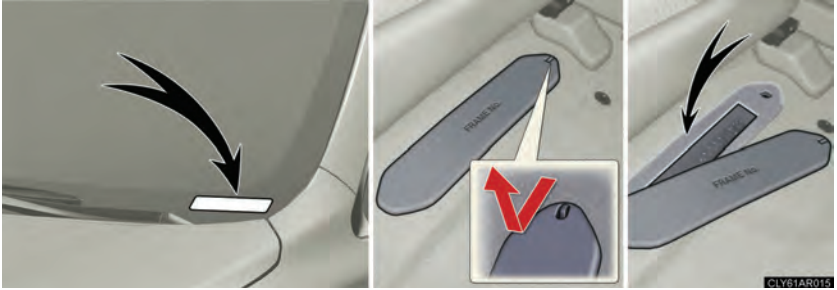

This number is stamped on the top left of the instrument. On some models, this number is also stamped under the front passenger seat.



This number is also on the Certification Label.

■ Engine number

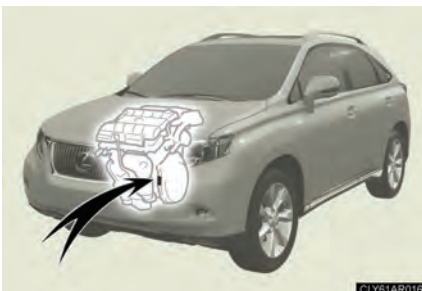

The engine number is stamped on the engine block as shown.

Engine

Model	2GR-FE
Type	6-cylinder V type, 4-cycle, gasoline
Bore and stroke	3.70 × 3.27 in. (94.0 × 83.0 mm)
Displacement	210.9 cu.in. (3456 cm ³)
Drive belt tension	Automatic adjustment

Fuel

Fuel type	Unleaded gasoline only
Octane rating	91 (Research octane number 96) or higher
Fuel tank capacity	19.2 gal. (72.5 L, 15.9 Imp. gal.)

Lubrication system

<p>Oil capacity Drain and refill (Reference)</p> <p>With filter</p> <p>Without filter</p>	<p>6.4 qt. (6.1L, 5.3 Imp. qt.)</p> <p>6.0 qt. (5.7 L, 5.0 Imp. qt.)</p>
<p>Oil grade</p>	<p>ILSAC multi-grade engine oil</p>
<p>Recommended oil viscosity</p>	<p>Use Lexus approved “Toyota Genuine Motor Oil” or equivalent to satisfy the grade and viscosity shown below.</p> <div data-bbox="484 690 909 982" style="text-align: center;"> </div> <p>0W-20 is an oil that provides optimal levels of fuel efficiency.</p>

Oil viscosity

- The 0W portion of the oil viscosity rating indicates a characteristic of the oil which allows cold startability. Oils with a lower value before the W allow for easier starting of the engine in cold weather.
- The 20 in 0W-20 indicates the oil viscosity when the oil is at its operating temperature. An oil with a higher viscosity may be better suited if the vehicle is operated at high speeds, or under extreme load conditions.

Cooling system

Capacity	Without towing package	9.0 qt. (8.5 L, 7.5 Imp. qt.)
	With towing package	10.0 qt. (9.5 L, 8.3 Imp. qt.)
Coolant type		<p>Use either of the following.</p> <ul style="list-style-type: none"> • “Toyota Super Long Life Coolant” • A similar high-quality ethylene glycol-based non-silicate, non-amine, non-nitrite, and non-borate coolant with long-life hybrid organic acid technology <p>Do not use plain water alone.</p>

Ignition system

Spark plug	
Make	DENSO FK20HR11
Gap	0.043 in. (1.1 mm)

NOTICE

Iridium-tipped spark plugs

Use only iridium-tipped spark plugs. Do not adjust spark plug gap.

Electrical system

Battery	
Open voltage* at 68°F (20°C):	12.6 — 12.8 V Fully charged 12.2 — 12.4 V Half charged 11.8 — 12.0 V Discharged (*: Voltage checked 20 minutes after the engine and all the lights are turned off)
Charging rates	5 A max.

Automatic transaxle

Fluid capacity *	2WD	6.8 qt. (6.5 L, 5.7 Imp. qt.)
	AWD	7.0 qt. (6.7 L, 5.9 Imp. qt.)
Fluid type	Toyota Genuine ATF WS	

*: The fluid capacity is a reference quantity. If replacement is necessary, contact your Lexus dealer.

NOTICE

■ Automatic transmission fluid type

Using automatic transmission fluid other than “Toyota Genuine ATF WS” may cause deterioration in shift quality, locking up of your transmission accompanied by vibration, and ultimately damage the automatic transmission of your vehicle.

Transfer (AWD models)

Oil capacity	0.8 qt. (0.8 L, 0.7 Imp. qt.)
Oil type and viscosity*	Toyota Genuine Differential gear oil LT 75W-85 GL-5 or equivalent

*: “Toyota Genuine Differential Gear Oil” is put in your Lexus vehicle at factory. Use Lexus approved “Toyota Genuine Differential Gear Oil” or an equivalent oil of matching quality that satisfies the above specifications. Please contact your Lexus dealer for further details.

Rear differential (AWD models)

Oil capacity	0.5 qt. (0.5 L, 0.4 Imp. qt.)
Oil type and viscosity*	Toyota Genuine Differential gear oil LT 75W-85 GL-5 or equivalent

*: “Toyota Genuine Differential Gear Oil” is put in your Lexus vehicle at factory. Use Lexus approved “Toyota Genuine Differential Gear Oil” or an equivalent oil of matching quality that satisfies the above specifications. Please contact your Lexus dealer for further details.

Brakes

Pedal clearance ^{*1}	3.3 in. (84 mm) Min.
Pedal free play	0.04 — 0.24 in. (1 — 6 mm)
Brake pad wear limit	0.04 in. (1.0 mm)
Parking brake lining wear limit	0.04 in. (1.0 mm)
Parking brake pedal travel ^{*2}	5 — 8 clicks
Fluid type	SAE J1703 or FMVSS No.116 DOT 3

*1: Minimum pedal clearance when depressed with a force of 112 lbf (500 N, 51 kgf) while the engine is running

*2: Parking brake pedal travel when depressed with a force of 67 lbf (300 N, 30 kgf)

Steering

Free play	Less than 1.2 in. (30 mm)
-----------	---------------------------

Tires and wheels

Type A

Tire size	P235/60R18 102V, T165/90D18 107M (spare)
Tire inflation pressure (recommended cold tire inflation pressure)	Driving under normal conditions Front: 32 psi (220 kPa, 2.2 kgf/cm ² or bar) Rear: 32 psi (220 kPa, 2.2 kgf/cm ² or bar) Spare: 60 psi (420 kPa, 4.2 kgf/cm ² or bar)
Wheel size	18 × 7 1/2J, 18 × 4T (spare)
Wheel nut torque	76 ft•lbf (103 N•m, 10.5 kgf•m)

Type B

Tire size	P235/60R18 102V
Tire inflation pressure (recommended cold tire inflation pressure)	Driving under normal conditions Front: 32 psi (220 kPa, 2.2 kgf/cm ² or bar) Rear: 32 psi (220 kPa, 2.2 kgf/cm ² or bar) Spare: 32 psi (220 kPa, 2.2 kgf/cm ² or bar)
Wheel size	18 × 7 1/2J
Wheel nut torque	76 ft•lbf (103 N•m, 10.5 kgf•m)

Type C

Tire size	P235/55R19 101V, T165/90D18 107M (spare)
Tire inflation pressure (recommended cold tire inflation pressure)	<p>Driving under normal conditions</p> <p>Front: 32 psi (220 kPa, 2.2 kgf/cm² or bar)*</p> <p>Rear: 32 psi (220 kPa, 2.2 kgf/cm² or bar)*</p> <p>Spare: 60 psi (420 kPa, 4.2 kgf/cm² or bar)</p> <p>*: When driving at high speeds above 100 mph (160 km/h), in countries where such speeds are permitted by law, add 1 psi (10 kPa, 0.1 kgf/cm² or bar) to the front tires, 3 psi (20 kPa, 0.2 kgf/cm² or bar) to the rear tires. Never exceed the maximum cold tire inflation pressure indicated on the tire sidewall.</p>
Wheel size	19 × 7 1/2J, 18 × 4T (spare)
Wheel nut torque	76 ft•lbf (103 N•m, 10.5 kgf•m)

Type D

Tire size	P235/55R19 101V
Tire inflation pressure (recommended cold tire inflation pressure)	<p>Driving under normal conditions</p> <p>Front: 32 psi (220 kPa, 2.2 kgf/cm² or bar)</p> <p>Rear: 32 psi (220 kPa, 2.2 kgf/cm² or bar)</p> <p>Spare: 32 psi (220 kPa, 2.2 kgf/cm² or bar)</p> <p>When driving at high speeds above 100 mph (160 km/h), in countries where such speeds are permitted by law, add 1 psi (10 kPa, 0.1 kgf/cm² or bar) to the front tires and rear tires. Never exceed the maximum cold tire inflation pressure indicated on the tire sidewall.</p>
Wheel size	19 × 7 1/2J
Wheel nut torque	76 ft•lbf (103 N•m, 10.5 kgf•m)

Light bulbs

	Light Bulbs	Bulb No.	W	Type
Exterior	Discharge headlights Low/High beam	D4S	35	B
	Daytime running lights	9005	60	A
	Halogen headlights High beam and daytime running lights	9005	60	A
	Low beam	H11	55	E
	Front side marker lights	W5W	5	C
	Front turn signal lights	WY21W	21	D
	Parking lights	W5W	5	C
	Front fog lights	H11	55	E
	Rear side marker lights	W5W	5	C
	Rear turn signal lights	WY21W	21	D
	Back-up lights	921	16	C
	Tail lights	W5W	5	C
	Outer foot lights	—	5	C
Interior	Vanity lights	—	3	C
	Front interior lights	—	5	C
	Rear interior light	—	8	C
	Luggage compartment lights	—	5	C
	Door courtesy lights	—	3.8	C
	Footwell lights	—	3.8	C

A: HB3 halogen bulbs

B: D4S discharge bulbs

C: Wedge base bulbs (clear)

D: Wedge base bulbs (amber)

E: H11 halogen bulbs

6-1. Specifications

Fuel information

Your vehicle must use only unleaded gasoline.

Premium unleaded gasoline with an octane rating of 91 (Research Octane Number 96) or higher required for optimum engine performance. If 91 octane cannot be obtained, you may use unleaded gasoline with an octane rating as low as 87 (Research Octane Number 91). Use of unleaded gasoline with an octane rating lower than 91 may result in engine knocking. Persistent knocking can lead to engine damage and should be corrected by refueling with higher octane unleaded gasoline.

At minimum, the gasoline you use should meet the specifications of ASTM D4814 in the U.S.A. and CGSB3.5-M93 in Canada.

■ Fuel tank opening for unleaded gasoline

To help prevent incorrect fueling, your Lexus has a fuel tank opening that only accommodates the special nozzle on unleaded fuel pumps.

■ If your engine knocks

- Consult your Lexus dealer.
- You may occasionally notice light knocking for a short time while accelerating or driving uphill. This is normal and there is no need for concern.

■ Gasoline quality

In very few cases, driveability problems may be caused by the brand of gasoline you are using. If driveability problems persist, try changing the brand of gasoline. If this does not correct the problem, consult your Lexus dealer.

■ Gasoline quality standards

- Automotive manufacturers in the US, Europe and Japan have developed a specification for fuel quality called World-Wide Fuel Charter (WWFC) that is expected to be applied worldwide.
- The WWFC consists of four categories that are based on required emission levels. In the US, category 4 has been adopted.
- The WWFC improves air quality by lowering emissions in vehicle fleets, and customer satisfaction through better performance.

■ Lexus recommends the use of gasoline containing detergent additives

- Lexus recommends the use of gasoline that contains detergent additives to avoid build-up of engine deposits.
- All gasoline sold in the US contains detergent additives to clean and/or keep clean intake systems.

■ Lexus recommends the use of cleaner burning gasoline

Cleaner burning gasoline, including reformulated gasoline that contains oxygenates such as ethanol or MTBE (Methyl Tertiary Butyl Ether) is available in many areas.

Lexus recommends the use of cleaner burning gasoline and appropriately blended reformulated gasoline. These types of gasoline provide excellent vehicle performance, reduce vehicle emissions and improve air quality.

■ Lexus does not recommend blended gasoline

- Lexus allows the use of oxygenate blended gasoline where the oxygenate content is up to 10% ethanol or 15% MTBE.
- If you use gasohol in your Lexus, be sure that it has an octane rating no lower than 87.
- Lexus DOES NOT recommend the use of gasoline containing methanol.

■ Lexus does not recommend gasoline containing MMT

Some gasoline contains octane enhancing additive called MMT (Methylcyclopentadienyl Manganese Tricarbonyl).

Lexus DOES NOT recommend the use of gasoline that contains MMT. If fuel containing MMT is used, your emission control system may be adversely affected.

The malfunction indicator lamp on the instrument cluster may come on. If this happens, contact your Lexus dealer for service.

 NOTICE**■ Notice on fuel quality**

- Do not use improper fuels. If improper fuels are used the engine will be damaged.
- Do not use leaded gasoline.
Leaded gasoline can cause damage to your vehicle's three-way catalytic converters causing the emission control system to malfunction.
- Do not use gasohol other than that stated here.
Other gasohol may cause fuel system damage or vehicle performance problems.
- Using unleaded gasoline with an octane number or rating lower than that stated here will cause persistent heavy knocking.
At worst, this will lead to engine damage.

■ Fuel-related poor driveability

If after using a different type of fuel, poor driveability is encountered (poor hot starting, vaporization, engine knocking, etc.), discontinue the use of that type of fuel.

■ When refueling with gasohol

Take care not to spill gasohol. It can damage your vehicle's paint.

6-1. Specifications

Tire information

Typical tire symbols

► Standard tire



► Compact spare tire

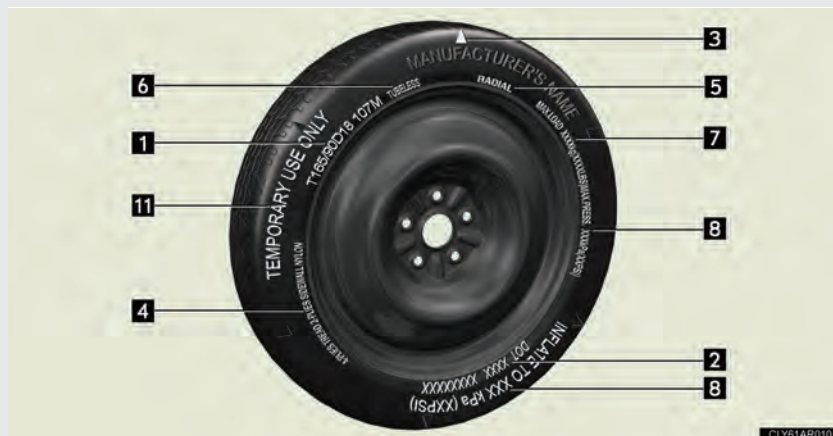

- | | | |
|---|--|-----------|
| 1 | Tire size | (→P. 601) |
| 2 | DOT and Tire Identification Number (TIN) | (→P. 600) |
| 3 | Location of treadwear indicators | (→P. 471) |

4 Tire ply composition and materials

Plies are layers of rubber-coated parallel cords. Cords are the strands which form the plies in a tire.

5 Radial tires or bias-ply tires

A radial tire has "RADIAL" on the sidewall. A tire not marked "RADIAL" is a bias-ply tire.

6 TUBELESS or TUBE TYPE

A tubeless tire does not have a tube and air is directly filled in the tire. A tube type tire has a tube inside the tire and the tube maintains the air pressure.

7 Load limit at maximum cold tire inflation pressure (→P. 475)**8** Maximum cold tire inflation pressure (→P. 591)

This means the pressure to which a tire may be inflated.

9 Uniform tire quality grading

For details, see "Uniform tire quality grading" that follows.

10 Summer tire or all season tire (→P. 475)

An all season tire has "M+S" on the sidewall. A tire not marked "M+S" is a summer tire.

11 "TEMPORARY USE ONLY" (→P. 564)

A compact spare tire is identified by the phrase "TEMPORARY USE ONLY" molded on its sidewall. This tire is designed for temporary emergency use only.

Typical DOT and tire identification number (TIN)

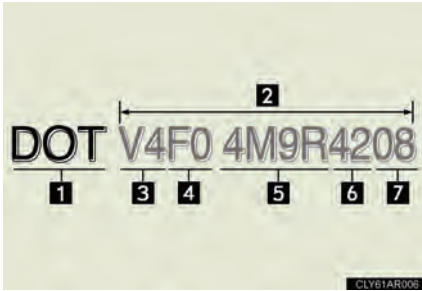

- 1 DOT symbol*
- 2 Tire Identification Number (TIN)
- 3 Tire manufacturer's identification mark
- 4 Tire size code
- 5 Manufacturer's optional tire type code (3 or 4 letters)
- 6 Manufacturing week
- 7 Manufacturing year

*:The DOT symbol certifies that the tire conforms to applicable Federal Motor Vehicle Safety Standards.

Tire size

Typical tire size information

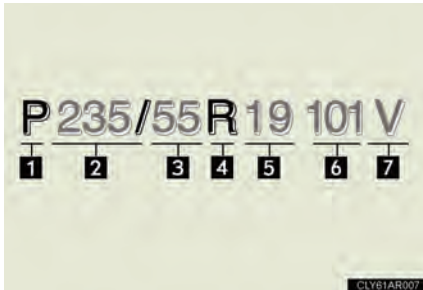

The illustration indicates typical tire size.

- 1 Tire use
(P = Passenger car,
T = Temporary use)
- 2 Section width (millimeters)
- 3 Aspect ratio
(tire height to section width)
- 4 Tire construction code
(R = Radial, D = Diagonal)
- 5 Wheel diameter (inches)
- 6 Load index (2 digits or 3 digits)
- 7 Speed symbol
(alphabet with one letter)

Tire dimensions



- 1 Section width
- 2 Tire height
- 3 Wheel diameter

Tire section names

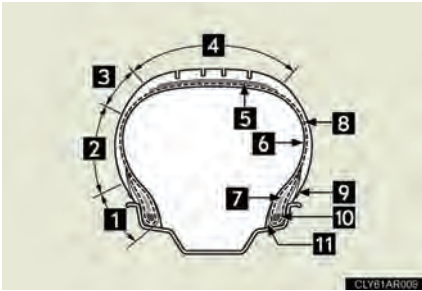

- 1 Bead
- 2 Sidewall
- 3 Shoulder
- 4 Tread
- 5 Belt
- 6 Inner liner
- 7 Reinforcing rubber
- 8 Carcass
- 9 Rim lines
- 10 Bead wires
- 11 Chafer

Uniform Tire Quality Grading

This information has been prepared in accordance with regulations issued by the National Highway Traffic Safety Administration of the U.S.A. Department of Transportation.

It provides the purchasers and/or prospective purchasers of Lexus vehicles with information on uniform tire quality grading.

Your Lexus dealer will help answer any questions you may have as you read this information.

■ DOT quality grades

All passenger vehicle tires must conform to Federal Safety Requirements in addition to these grades. Quality grades can be found where applicable on the tire sidewall between tread shoulder and maximum section width.

For example: Treadwear 200 Traction AA Temperature A

■ Treadwear

The treadwear grade is a comparative rating based on the wear rate of the tire when tested under controlled conditions on a specified government test course.

For example, a tire graded 150 would wear one and a half (1 - 1/2) times as well on the government course as a tire graded 100.

The relative performance of tires depends upon the actual conditions of their use, however, and may depart significantly from the norm due to variations in driving habits, service practices and differences in road characteristics and climate.

■ Traction AA, A, B, C

The traction grades, from highest to lowest, are AA, A, B and C, and they represent the tire's ability to stop on wet pavement as measured under controlled conditions on specified government test surfaces of asphalt and concrete.

A tire marked C may have poor traction performance.

Warning: The traction grade assigned to this tire is based on braking (straight ahead) traction tests and does not include cornering (turning) traction.

■ Temperature A, B, C

The temperature grades are A (the highest), B, and C, representing the tire's resistance to the generation of heat and its ability to dissipate heat when tested under controlled conditions on a specified indoor laboratory test wheel.

Sustained high temperature can cause the material of the tire to degenerate and reduce tire life, and excessive temperature can lead to sudden tire failure.

The grade C corresponds to a level of performance which all passenger car tires must meet under the Federal Motor Vehicle Safety Standard No. 109.

Grades B and A represent higher levels of performance on the laboratory test wheel than the minimum required by law.

Warning: The temperature grades for this tire are established for a tire that is properly inflated and not overloaded.

Excessive speed, underinflation, or excessive loading, either separately or in combination, can cause heat buildup and possible tire failure.

Glossary of tire terminology

Tire related term	Meaning
Cold tire inflation pressure	Tire pressure when the vehicle has been parked for three hours or more, or has not been driven more than 1 mile or 1.5 km under that condition
Maximum inflation pressure	The maximum cold inflated pressure to which a tire may be inflated, shown on the sidewall of the tire
Recommended inflation pressure	Cold tire inflation pressure recommended by a manufacturer
Accessory weight	The combined weight (in excess of those standard items which may be replaced) of automatic transmission, power steering, power brakes, power windows, power seats, radio and heater, to the extent that these items are available as factory-installed equipment (whether installed or not)
Curb weight	The weight of a motor vehicle with standard equipment, including the maximum capacity of fuel, oil and coolant, and if so equipped, air conditioning and additional weight optional engine
Maximum loaded vehicle weight	The sum of: (a) Curb weight (b) Accessory weight (c) Vehicle capacity weight (d) Production options weight
Normal occupant weight	150 lb. (68 kg) times the number of occupants specified in the second column of Table 1* that follows

Tire related term	Meaning
Occupant distribution	Distribution of occupants in a vehicle as specified in the third column of Table 1* below
Production options weight	The combined weight of installed regular production options weighing over 5 lb. (2.3 kg) in excess of the standard items which they replace, not previously considered in curb weight or accessory weight, including heavy duty brakes, ride levelers, roof rack, heavy duty battery, and special trim
Rim	A metal support for a tire or a tire and tube assembly upon which the tire beads are seated
Rim diameter (Wheel diameter)	Nominal diameter of the bead seat
Rim size designation	Rim diameter and width
Rim type designation	The industry manufacturer's designation for a rim by style or code
Rim width	Nominal distance between rim flanges
Vehicle capacity weight (Total load capacity)	The rated cargo and luggage load plus 150 lb. (68 kg) times the vehicle's designated seating capacity
Vehicle maximum load on the tire	The load on an individual tire that is determined by distributing to each axle its share of the maximum loaded vehicle weight, and dividing by two
Vehicle normal load on the tire	The load on an individual tire that is determined by distributing to each axle its share of curb weight, accessory weight, and normal occupant weight (distributed in accordance with Table 1* below), and dividing by two
Weather side	The surface area of the rim not covered by the inflated tire

Tire related term	Meaning
Bead	The part of the tire that is made of steel wires, wrapped or reinforced by ply cords and that is shaped to fit the rim
Bead separation	A breakdown of the bond between components in the bead
Bias ply tire	A pneumatic tire in which the ply cords that extend to the beads are laid at alternate angles substantially less than 90 degrees to the centerline of the tread
Carcass	The tire structure, except tread and sidewall rubber which, when inflated, bears the load
Chunking	The breaking away of pieces of the tread or sidewall
Cord	The strands forming the plies in the tire
Cord separation	The parting of cords from adjacent rubber compounds
Cracking	Any parting within the tread, sidewall, or innerliner of the tire extending to cord material
CT	A pneumatic tire with an inverted flange tire and rim system in which the rim is designed with rim flanges pointed radially inward and the tire is designed to fit on the underside of the rim in a manner that encloses the rim flanges inside the air cavity of the tire
Extra load tire	A tire designed to operate at higher loads and at higher inflation pressures than the corresponding standard tire
Groove	The space between two adjacent tread ribs
Innerliner	The layer(s) forming the inside surface of a tubeless tire that contains the inflating medium within the tire
Innerliner separation	The parting of the innerliner from cord material in the carcass

Tire related term	Meaning
Intended outboard sidewall	(a) The sidewall that contains a whitewall, bears white lettering, or bears manufacturer, brand, and/or model name molding that is higher or deeper than the same molding on the other sidewall of the tire, or (b) The outward facing sidewall of an asymmetrical tire that has a particular side that must always face outward when mounted on a vehicle
Light truck (LT) tire	A tire designated by its manufacturer as primarily intended for use on lightweight trucks or multipurpose passenger vehicles
Load rating	The maximum load that a tire is rated to carry for a given inflation pressure
Maximum load rating	The load rating for a tire at the maximum permissible inflation pressure for that tire
Maximum permissible inflation pressure	The maximum cold inflation pressure to which a tire may be inflated
Measuring rim	The rim on which a tire is fitted for physical dimension requirements
Open splice	Any parting at any junction of tread, sidewall, or innerliner that extends to cord material
Outer diameter	The overall diameter of an inflated new tire
Overall width	The linear distance between the exteriors of the sidewalls of an inflated tire, including elevations due to labeling, decorations, or protective bands or ribs
Passenger car tire	A tire intended for use on passenger cars, multipurpose passenger vehicles, and trucks, that have a gross vehicle weight rating (GVWR) of 10,000 lb. or less.
Ply	A layer of rubber-coated parallel cords

Tire related term	Meaning
Ply separation	A parting of rubber compound between adjacent plies
Pneumatic tire	A mechanical device made of rubber, chemicals, fabric and steel or other materials, that, when mounted on an automotive wheel, provides the traction and contains the gas or fluid that sustains the load
Radial ply tire	A pneumatic tire in which the ply cords that extend to the beads are laid at substantially 90 degrees to the centerline of the tread
Reinforced tire	A tire designed to operate at higher loads and at higher inflation pressures than the corresponding standard tire
Section width	The linear distance between the exteriors of the sidewalls of an inflated tire, excluding elevations due to labeling, decoration, or protective bands
Sidewall	That portion of a tire between the tread and bead
Sidewall separation	The parting of the rubber compound from the cord material in the sidewall
Snow tire	A tire that attains a traction index equal to or greater than 110, compared to the ASTM E-1136 Standard Reference Test Tire, when using the snow traction test as described in ASTM F-1805-00, Standard Test Method for Single Wheel Driving Traction in a Straight Line on Snow-and Ice-Covered Surfaces, and which is marked with an Alpine Symbol () on at least one sidewall
Test rim	The rim on which a tire is fitted for testing, and may be any rim listed as appropriate for use with that tire

Tire related term	Meaning
Tread	That portion of a tire that comes into contact with the road
Tread rib	A tread section running circumferentially around a tire
Tread separation	Pulling away of the tread from the tire carcass
Treadwear indicators (TWI)	The projections within the principal grooves designed to give a visual indication of the degrees of wear of the tread
Wheel-holding fixture	The fixture used to hold the wheel and tire assembly securely during testing

*: Table 1 — Occupant loading and distribution for vehicle normal load for various designated seating capacities

Designated seating capacity, Number of occupants	Vehicle normal load, Number of occupants	Occupant distribution in a normally loaded vehicle
2 through 4	2	2 in front
5 through 10	3	2 in front, 1 in second seat
11 through 15	5	2 in front, 1 in second seat, 1 in third seat, 1 in fourth seat
16 through 20	7	2 in front, 2 in second seat, 2 in third seat, 1 in fourth seat

6-2. Customization

Customizable features

Your vehicle includes a variety of electronic features that can be personalized to suit your preferences. Programming of these preferences can be performed by your Lexus dealer.

It is also possible to customize certain vehicle features yourself using the multi-information switches and the navigation screen.

Some function settings are changed simultaneously with other functions being customized. Contact your Lexus dealer for further details.

Customizing vehicle features

It is possible to customize certain vehicle features using the multi-information switches. *

When customizing vehicle features, ensure that the vehicle is parked in a safe place with the shift lever in P and the parking brake set.



Press and hold the menu switch of the multi-information switches to display customization mode.

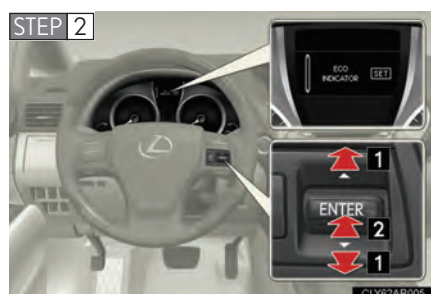

- 1 Press the “ENTER” switch upwards or downwards to select the item to be customized.
- 2 Press the “ENTER” switch to confirm.

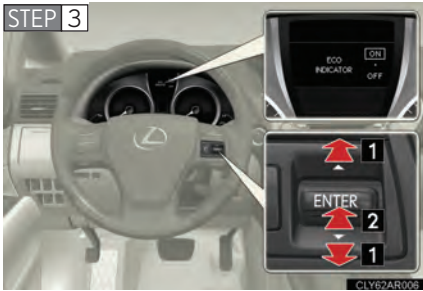

- 1 Press the “ENTER” switch upwards or downwards to select the desired setting for the item being customized.
- 2 Press the “ENTER” switch to confirm.

When customization is completed, press the menu switch to clear the customization screen.

*: For instructions on customizing vehicle features using the navigation screen, refer to the “Navigation System Owner’s Manual”.

Customizable Features

- 1 Vehicles with a navigation system: Settings that can be changed using the screen of the navigation system
- 2 Vehicles with a navigation system: Settings that can be changed using the multi-information switches
- 3 Vehicles without a navigation system: Settings that can be changed using the multi-information switches
- 4 Settings that can be changed by your Lexus dealer

Definition of symbols: ○ = Available, – = Not available

Item	Function	Default setting	Customized setting	1	2	3	4
Door lock (→P. 44, 572)	Unlocking using a key	Driver's door unlocked in one step, all doors unlocked in two steps	All doors unlocked in one step	○	–	–	○
	Speed-detecting automatic door lock function	Off	On	○	–	○	○
	Shifting gears to position other than P locks all doors	On	Off	○	–	○	○

Item	Function	Default setting	Customized setting	1	2	3	4
Door lock (→P. 44, 572)	Shifting gears to P unlocks all doors	On	Off	○	–	○	○
	Opening driver's door unlocks all doors	Off	On	○	–	○	○
Smart access system with push-button start and wireless remote control (→P. 29, 40)	Operation signal (buzzer)	7	Off	○	–	○	○
			1 to 6				
	Operation signal (Emergency flashers)	On	Off	○	–	○	○
Time elapsed before the automatic door lock function is activated if a door is not opened after being unlocked	60 seconds	Off	○	–	○	○	
		30 seconds					
		120 seconds					
Smart access system with push-button start (→P. 29)	Smart door unlocking	Driver's door	All the doors	○	–	○	○
	Smart access system with push-button start	On	Off	○	–	○	○

6-2. Customization

Item	Function	Default setting	Customized setting	1	2	3	4
Wireless remote control (→P. 40)	Unlocking operation	Driver's door unlocked in one step, all doors unlocked in two steps	All doors unlocked in one step	○	–	○	○
Automatic light control system (→P. 176)	Time elapsed before the headlights turn off	30 seconds	Off				
			60 seconds	○	–	○	○
			90 seconds				
	Light sensor sensitivity	Standard	-2 to 2	○	–	○	○
	Daytime running light system	On	Off	○	–	○	○
Automatic high beam system	On	Off	–	–	–	○	

Item	Function	Default setting	Customized setting	1	2	3	4
Illumination (→P. 394)	Time elapsed before the interior lights turn off	15 seconds	Off				
			7.5 seconds	○	–	○	○
			30 seconds				
	Time elapsed before the exterior lights turn off	15 seconds	Off				
			7.5 seconds	○	–	○	○
			30 seconds				
	Sensitivity of the ambient light sensor used for dimming the meter lights etc.	Standard	-2 to 2	○	–	–	○
	Sensitivity of the ambient light sensor used for brightening the meter lights etc.	Standard	-2 to 2	○	–	–	○
	Footwell lighting	On	Off	–	–	–	○
	Outer foot lights	On	Off	–	–	–	○

6-2. Customization

Item	Function	Default setting	Customized setting	1	2	3	4
Automatic air conditioning system	Switching between outside air and recirculated air mode linked to "AUTO" switch operation	Auto	Manual	○	–	–	○
	A/C Auto switch operation	Auto	Manual	○	–	–	○
	Exhaust gas sensor sensitivity	Standard	-3 to 3	○	–	–	○
Front seats (→P. 58)	Driver's seat movement when exiting the vehicle (on some models)	Full	Off				
			Partial	○	–	○	○
Multi-information display (→P. 165)	Eco Driving Indicator Light	On	Off	–	○	○	○
Power windows (→P. 86)	Mechanical key linked operation	On	Off	–	–	–	○
	Wireless remote control linked operation	Off	On	–	–	–	○

Item	Function	Default setting	Customized setting	1	2	3	4
Moon roof (→P. 89)	Mechanical key linked operation	On	Off	-	-	-	○
	Wireless remote control linked operation*	Off	On	-	-	-	○
Intuitive parking assist (→P. 211)	Buzzer volume	3	1 to 5	○	-	-	○
	Detection distance of the rear center sensor	Far	Near	○	-	-	○
	Display setting (when intuitive parking assist is operating)	All sensors displayed	No sensor displayed	○	-	-	○

*: This function cannot be customized unless power window operation using the wireless remote control is enabled.

Multi-information display (→P. 165)

Settings that can be changed using the multi-information switches

Available units	miles (MPG), km (km/l), km (l/100 km)
Available languages	English, French and Spanish

■ **In the following situations, customize mode will automatically be turned off.**

- A warning message appears after the customize mode screen is displayed.
- The “ENGINE START STOP” switch is turned off.
- The vehicle begins to move while the customize mode screen is displayed.

CAUTION

■ **Cautions during customization**

As the engine needs to be running during customization, ensure that the vehicle is parked in a place with adequate ventilation. In a closed area such as a garage, exhaust gases including harmful carbon monoxide (CO) may collect and enter the vehicle. This may lead to death or a serious health hazard.

NOTICE

■ **During customization**

To prevent battery discharge, ensure that the engine is running while customizing features.

6-3. Initialization

Items to initialize

The following items must be initialized for normal system operation in cases such as after the battery is reconnected, or maintenance is performed on the vehicle.

Item	When to initialize	Reference
Power back door	<ul style="list-style-type: none">• After reconnecting or changing the battery• After changing a fuse	P. 47
Engine oil maintenance data	After changing engine oil	P. 461
Tire pressure warning system	<ul style="list-style-type: none">• When changing tire pressure (such as when changing traveling speed, load weight, etc.)• When changing the tire size	P. 472

Reporting safety defects for U.S. owners

If you believe that your vehicle has a defect which could cause a crash or could cause injury or death, you should immediately inform the National Highway Traffic Safety Administration (NHTSA) in addition to notifying the Lexus Division of Toyota Motor Sales, U.S.A., Inc. (Toll-free: 1-800-25-LEXUS).

If NHTSA receives similar complaints, it may open an investigation, and if it finds that a safety defect exists in a group of vehicles, it may order a recall and remedy campaign. However, NHTSA cannot become involved in individual problems between you, your dealer, or Lexus Division of Toyota Motor Sales, U.S.A., Inc.

To contact NHTSA, you may call the Vehicle Safety Hotline toll-free at 1-888-327-4236 (TTY: 1-800-424-9153); go to <http://www.safercar.gov>; or write to: Administrator, NHTSA, 1200 New Jersey Ave, S.E., Washington, DC 20590. You can also obtain other information about motor vehicle safety from <http://www.safercar.gov>.

Seat belt instructions for Canadian owners (in French)

The following is a French explanation of seat belt instructions extracted from the seat belt section in this manual.

See the seat belt section for more detailed seat belt instructions in English.

Utilisation correcte des ceintures de sécurité



- Déroulez la sangle diagonale de telle sorte qu'elle passe bien sur l'épaule, sans pour autant être en contact avec votre cou ou glisser de votre épaule.
- Placez la sangle abdominale le plus bas possible sur les hanches.
- Réglez la position du dossier de siège. Asseyez-vous le dos le plus droit possible et calez-vous bien dans le siège.
- Ne vrillez pas la ceinture de sécurité.

Guide confort de ceinture de sécurité (sièges arrière extérieurs)

Si la sangle diagonale gêne la personne au niveau du cou, utilisez le guide confort de la ceinture de sécurité.

ÉTAPE 1

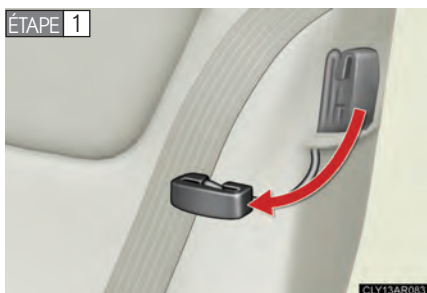

Sortez le guide confort de sa poche.

ÉTAPE 2

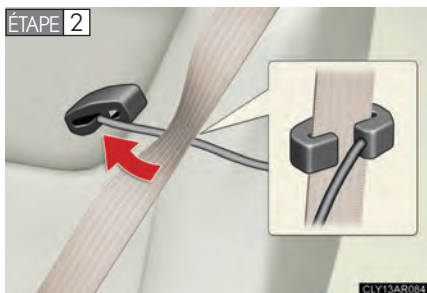

Engagez la ceinture dans le guide.

Le cordon élastique doit passer sous la ceinture de sécurité.

ÉTAPE 3



Bouclez la ceinture de sécurité, puis positionnez-la et lâchez-la.

Entretien et soin

■ Ceintures de sécurité

Nettoyez avec un chiffon ou une éponge humectée d'eau savonneuse tiède. Profitez de l'occasion pour vérifier régulièrement que les ceintures ne sont pas effilochées, entaillées, ou ne paraissent pas exagérément usées.

ATTENTION

■ Détérioration et usure des ceintures de sécurité

Inspectez les ceintures de sécurité périodiquement. Contrôlez qu'elles ne sont pas entaillées, effilochées, et que leurs ancrages ne sont pas desserrés. N'utilisez pas une ceinture de sécurité défectueuse avant qu'elle ne soit remplacée. Une ceinture de sécurité défectueuse n'apporte aucune garantie de protection de l'occupant en cas d'accident.

Index

Abbreviation list 628

Alphabetical index 630

What to do if... 641

For details of equipment related to the navigation system, such as the air conditioning and audio systems, refer to the “Navigation System Owner’s Manual”.

Abbreviation list

Abbreviation/Acronym list

ABBREVIATIONS	MEANING
2WD	Two Wheel Drive
4WD	Four Wheel Drive
A/C	Air Conditioning
ABS	Anti-lock Brake System
AFS	Adaptive Front-lighting System
AI-SHIFT	Artificial Intelligence Shift control
ALR	Automatic Locking Retractor
AWD	All Wheel Drive
CRS	Child Restraint System
DISP	Display
ECT	Electronic Controlled Transmission
ECU	Electronic Control Unit
EDR	Event Data Recorder
ELR	Emergency Locking Retractor
EPS	Electric Power Steering
GAWR	Gross Axle Weight Ratings
GCWR	Gross Combination Weight Rating
GVWR	Gross Vehicle Weight Rating
I/M	Emission Inspection and Maintenance
LATCH	Lower Anchors and Tethers for Children
LED	Light Emitting Diode
MMT	Methylcyclopentadienyl Manganese Tricarbonyl
M + S	Mud and Snow
MTBE	Methyl Tertiary Butyl Ether
PCS	Pre-Collision System

ABBREVIATIONS	MEANING
PWR	Power
SRS	Supplemental Restraint System
TIN	Tire Identification Number
TPMS	Tire Pressure Warning System
TRAC	Traction Control
VDIM	Vehicle Dynamics Integrated Management
VIN	Vehicle Identification Number
VSC	Vehicle Stability Control

A	A/C	
	Air conditioning filter	485
	Automatic air conditioning system	
	Air conditioning filter	485
	Automatic air conditioning system	272
	ABS	228
	ACCESSORY mode	145
	Active torque control	
	AWD mode.....	228
	AFS	178
	Adaptive front lighting system	178
	Air conditioning filter	485
	Air conditioning system	272
	Automatic air conditioning system	272
	Airbags	
	Airbag operating conditions.....	106
	Airbag precautions for your child.....	110
	Airbag warning light	527
	Curtain shield airbag operating conditions.....	107
	Curtain shield airbag precautions	110
	Front passenger occupant classification system.....	115
	General airbag precautions	110
	Locations of airbags.....	103
	Modification and disposal of airbags.....	114
	Proper driving posture.....	101, 110
	Side airbag operating conditions.....	107
	Side airbag precautions.....	110
	SRS airbags	103
	Alarm	98
	Anti-lock brake system	228
	Armrest	416
	Audio input	335
	Audio system	
	Audio input.....	335
	AUX adapter	335
	CD player/changer	295
	iPod® player	315
	MP3/WMA disc.....	305
	Optimal use	332
	Portable audio device.....	335
	Radio	285
	Steering wheel audio switch.....	337
	USB memory player	323
	Automatic air conditioning system	
	Air conditioning filter	485
	Air conditioning system.....	272
	Automatic headlight leveling system	180
	Automatic high beam system	181
	Automatic light control system	176
	Automatic transmission	
	Automatic transmission	151
	If the shift lever cannot be shifted from P.....	570
	S mode.....	153
	AUX adapter	335

B

Back door
 Back door47
 Wireless remote control..... 40

Back-up lights
 Wattage594

Battery
 Checking 467
 If the vehicle has a
 discharged battery 575
 Preparing and checking
 before winter 252

Bluetooth® audio..... 340

Bluetooth® phone..... 360

Brake
 Fluid590
 Parking brake.....156

Brake assist..... 228

Break-in tips 137

C

Care
 Exterior436
 Interior.....439
 Seat belts440

Cargo hooks 419

CD changer
 CD295
 MP3305
 WMA disc305

CD player..... 295

Chains.....252

Child restraint system
 Booster seats, definition 120
 Booster seats, installation127
 Convertible seats, definition.....120
 Convertible seats, installation.....127
 Front passenger occupant
 classification system115
 Infant seats, definition120
 Infant seats, installation127
 Installing CRS with LATCH
 anchors.....125
 Installing CRS with seat belts.....127
 Installing CRS with top tether
 straps131

Child safety
 Airbag precautions110
 Back door precautions..... 47
 Battery precautions 468, 577
 Child restraint system.....120
 Child-protectors45
 How your child should wear
 the seat belt76
 Installing child restraints.....124
 Moon roof precautions.....91
 Power window lock switch86
 Power window precautions 88
 Removed electronic key battery
 precautions..... 489
 Seat belt comfort guide73
 Seat belt extender precautions.....79
 Seat belt precautions77
 Seat heater precautions..... 415

Child-protectors 45

Cleaning	
Exterior	436
Interior	439
Seat belts	440
Clock	408
Coat hooks	417
Compass	430
Condenser	465
Console box	402
Cooling system	
Engine overheating	578
Cornering assist sensors	211
Cruise control	
Cruise control	196
Dynamic radar cruise control	200
Cup holders	400
Curtain shield airbags	103
Customizable features	610

D Daytime running light system	179
Defogger	
Rear window	279
Side mirrors	83
Dimensions	584
Dinghy towing	269
Display	
Multi-information display	165
Trip information	168
Warning message	536
Do-it-yourself maintenance	449
Door courtesy lights	
Door courtesy lights	394
Wattage	594

Door lock	
Back door	47
Side door	44
Wireless remote control	40
Door pockets	399
Doors	
Back door	47
Door windows	86
Door lock	29, 40, 44
Power back door	47
Side door	44
Side mirrors	83
Driver's seat belt reminder light	528
Driving	
Break-in tips	137
Correct posture	101
Utility vehicle precautions	242
Procedures	136
Winter driving tips	252
Driving position memory	67

E Electric power steering	228
Electronically modulated air suspension	218
Electronic features control	165
Electronic key	
If the electronic key does not operate properly	572
Emergency flasher switch	516
Emergency, in case of	
If the electronic key does not operate properly	572
If the engine will not start	568

- If the shift lever cannot be shifted from P570
 - If the vehicle has a discharged battery575
 - If a warning buzzer sounds526
 - If a warning light turns on526
 - If a warning message is displayed536
 - If you have a flat tire555
 - If you lose your keys571
 - If you think something is wrong522
 - If your vehicle becomes stuck581
 - If your vehicle needs to be towed517
 - If your vehicle overheats578
 - Engine**
 - Accessory mode145
 - Compartment455
 - Engine switch145
 - Hood452
 - How to start the engine145
 - Identification number585
 - If the engine will not start568
 - Ignition switch145
 - Overheating578
 - Engine compartment cover**456
 - Engine coolant**
 - Capacity588
 - Checking463
 - Preparing and checking before winter252
 - Engine coolant temperature gauge**158
 - Engine immobilizer system**96
 - Engine oil**
 - Capacity587
 - Checking458
 - Preparing and checking before winter252
 - Engine oil maintenance data**461
 - EPS**228
 - Event data recorder**524
- F**
- Floor mat**418
 - Fluid**
 - Brake590
 - Washer470
 - Fog lights**
 - Switch187
 - Wattage594
 - Footwell lights**394
 - Front fog lights**
 - Switch187
 - Wattage594
 - Front passenger occupant classification system**115
 - Front passenger's seat belt reminder light**528
 - Front seats**
 - Adjustment58
 - Driver's seat position memory67
 - Flattening seatbacks58
 - Front side marker light**
 - Replacing light bulbs503
 - Wattage594

Front turn signal lights
 Replacing light bulbs.....503
 Wattage.....594

Fuel
 Capacity.....586
 Fuel gauge158
 Fuel pump shut off system523
 Information.....595
 Refueling92
 Type.....595
 Fuel door92
 Fuel filler door92
 Fuel pump shut off system.....523
 Fuses490

G Garage door opener424
 Gauges158
 Glove box398

H Hands-free system for
 mobile phone360
 Hazard lights switch516
 Head-up display171
 Head restraints
 Adjustment70
 Headlight aim501
 Headlight cleaner195
 Headlights
 Discharge headlight
 precautions514
 Replacing light bulbs.....503
 Switch176
 Wattage.....594
 Head-up display171

Heaters
 Seat heaters414
 Side mirrors.....279

Height control
 Electronically modulated air
 suspension218
 Hill-start assist control.....235
 Hood.....452
 Hooks
 Cargo.....419
 Coat.....417
 HUD171
 Horn.....157

I I/M test448

Identification
 Engine.....585
 Vehicle.....585

Ignition switch145
 Illuminated entry system.....394
 Indicator lights160

Initialization
 Items to initialize.....619
 Inside rear view mirror82

Interior lights
 Interior lights.....394
 Switch.....395
 Wattage.....594

J Jack
 Positioning a floor jack453
 Replacing the wheel555
 Jack handle555

K	Keyless entry.....	40
	Keys	
	Electronic key.....	24
	Engine switch.....	145
	If the electronic key does not operate properly.....	572
	If you lose your keys.....	571
	Ignition switch.....	145
	Key number.....	24
	Keyless entry.....	40
	Keys.....	24
	Mechanical key.....	25
	Wireless remote control key.....	40

L	Light bulbs	
	Replacing.....	503
	Wattage.....	594
	Lights	
	Door courtesy lights.....	394
	Emergency flasher switch.....	516
	Fog light switch.....	187
	Hazard lights switch.....	516
	Headlight switch.....	176
	Interior light switch.....	395
	Luggage compartment light.....	50
	Outer foot lights.....	394
	Overhead courtesy light.....	394
	Personal light switch.....	395
	Replacing light bulbs.....	503
	Scuff lights.....	394
	Shift lever light.....	394
	Turn signal lever.....	155
	Vanity lights.....	407
	Wattage.....	594

Load capacity.....	251
Lock steering column.....	148
Luggage compartment lights	
Switch.....	50
Wattage.....	594
Luggage cover.....	421

M	Maintenance	
	Do-it-yourself maintenance.....	449
	General maintenance.....	444
	Maintenance data.....	584
	Maintenance requirements.....	442

Meter	
Instrument panel light control.....	159
Meters.....	158

Mirrors	
Inside rear view mirror.....	82
Side mirror heaters.....	279
Side mirrors.....	83
Vanity mirrors.....	407

Moon roof.....	89
MP3 disc.....	305
Multi-information display.....	165

N	Noise from under vehicle.....	20
----------	-------------------------------	----

O	Odometer.....	158
----------	---------------	-----

Oil	
Engine oil.....	458

Opener	
Back door.....	47
Fuel filler door.....	92
Hood.....	452

Outer foot lights	
Outer foot lights.....	394
Wattage.....	594
Outside rear view mirrors	
Adjusting and folding.....	83
Mirror position memory	67
Outside temperature display.....	409
Overhead console	404
Overhead courtesy lights	
Overhead courtesy lights	394
Wattage.....	594
Overheating, Engine.....	578

P Parking assist sensors	211
Parking brake.....	156
Parking lights	
Replacing light bulbs.....	503
Switch	176
Wattage.....	594
PCS	237
Personal lights	
Switch	395
Power back door	47
Power outlet.....	411
Power windows	86
Pre-collision system.....	237

R Radar cruise control.....	200
Radiator	465
Radio.....	285
Rear seat	
Folding down	63
Seat adjustment.....	63
Rear turn signal lights	
Replacing light bulbs.....	504
Wattage.....	594
Rear view mirror	
Compass.....	430
Rear view monitor system	224
Rear window defogger	279
Rear window wiper.....	194
Replacing	
Electronic key battery	488
Fuses.....	490
Light bulbs	503
Tires.....	555
Wireless remote control battery	488
Roof luggage carrier.....	247
Reporting safety defects for U.S. owners.....	622

S	Scuff lights..... 394	Shift lever	Automatic transmission.....151
	Seat belts	If the shift lever cannot be	shifted from P..... 570
	Adjusting the seat belt.....73	Shift lever light.....394	
	Automatic locking retractor.....75	Shift lock system.....570	
	Child restraint system	Side airbags.....103	
	installation.....124	Side marker lights	Switch.....176
	Cleaning and maintaining	Side mirror	Adjusting and folding.....83
	the seat belts.....440	Mirror position memory.....67	
	Emergency locking retractor.....75	Smart access system with	push-button start
	How to wear your seat belt.....72	Entry function.....29	Starting the engine.....145
	How your child should wear	Spare tire	Inflation pressure.....480
	the seat belt.....76	Spare tire.....555	
	Pregnant women,	Spark plug.....588	
	proper seat belt use.....75	Specifications.....584	
	Reminder light.....528	Speedometer.....158	
	Seat belt extenders.....76	Steering wheel	Adjustment.....80
	Seat belt pretensioners.....74	Audio switches.....337	
	Seat heaters.....414	Power easy access system.....60	
	Seats	Steering wheel position	memory.....67
	Adjustment.....58, 63	Storage feature.....397	
	Adjustment	Stuck vehicle	If your vehicle becomes stuck.....581
	precautions.....62, 65	Sun visors.....406	
	Child seats/child restraint		
	system installation.....124		
	Cleaning.....439		
	Head restraint.....70		
	Properly sitting in the seat.....101		
	Seat heaters.....414		
	Seat position memory.....67		
	Service reminder indicators.....160		

Sunshades	
Roof	90
Switch	
Display contrast adjustment switch	171
Display position adjustment switch	171
ECT SNOW switch	152
Emergency flasher switch	516
Engine switch.....	145
ENTER switch.....	165
Fog light switch.....	187
Hazard light switch.....	516
Head-up display main switch button.....	171
Ignition switch.....	145
Light switches.....	176
Menu switch.....	165
Power back door opener	47
Power door lock switch.....	44
Power window switch.....	86
Window lock switch	86
Wiper and washer switch.....	189
T Tachometer.....	158
Tail lights	
Replacing light bulbs.....	504
Switch	176
Wattage.....	594
Theft deterrent system	
Alarm	98
Engine immobilizer system	96
Tire inflation pressure	480

Tire information	
Glossary	604
Size	601
Tire identification number.....	600
Uniform tire quality grading.....	602
Tires	
Chains.....	252
Checking.....	471
If you have a flat tire	555
Inflation pressure.....	480
Inflation pressure sensor	472
Information	598
Replacing	555
Rotating tires.....	471
Size.....	591
Snow tires.....	252
Spare tire.....	556
Tire pressure warning system.....	472, 528
Tools.....	555
Total load capacity	251
Towing	
Emergency towing.....	517
Trailer towing	256
TRAC	228
Traction control.....	228
Trip information display	165
Trip meter	158
Turn signal lights	
Replacing light bulbs.....	503
Switch.....	155
Wattage.....	594

V

Vanity lights
 Vanity lights407
 Wattage594
 Vanity mirrors.....407
 VDIM 228
 Vehicle dynamics integrated
 management..... 228
 Vehicle identification number585
 Vehicle stability control..... 228
 VSC 228

W

Warning buzzers
 Brake system526
 Open door528
 Seat belt reminder528
 Warning lights
 Anti-lock brake system527
 Brake assist system527
 Brake system526
 Charging system526
 Electric power steering.....527
 Electronic engine control
 system.....527
 Low fuel level.....528
 Low tire pressure528
 Malfunction indicator lamp527
 Master warning light.....528
 Open door528
 Pre-collision system.....527
 Pretensioners527
 Seat belt reminder light528
 SRS airbags527
 Tire pressure.....528

Warning messages

Adaptive front lighting system...538
 Automatic transmission fluid.....538
 Anti-lock brake system.....538
 AWD system537, 538, 542
 Brake lamp system.....538
 Brake system.....536
 Dynamic radar cruise
 control system.....538, 542
 Electric power steering.....538
 Electronically modulated air
 suspension538
 Engine oil maintenance542
 Engine oil pressure537
 Engine overheat542
 Headlight leveling.....538
 Hood.....542
 Intuitive parking assist.....542, 538
 Low fuel542
 Moon roof542
 Open door.....542
 Parking brake542
 Pre-collision system.....538, 542
 Smart access system with
 push-button start547
 SRS airbags.....538
 Steering lock.....538
 Washer fluid542

Washer

Checking470
 Preparing and checking
 before winter252
 Switch.....189

Washing and waxing.....436

Weight

Load limits251
 Weight.....584

Wheels	483
Window glasses	86
Window lock switch	86
Windows	
Power windows.....	86
Rear window defogger	279
Washer	189
Windshield wiper de-icer.....	280
Windshield wipers.....	189
Wireless remote control key	
Replacing the battery	488
WMA disc	305

What to do if...

What to do if...



A tire punctures

P. 555 If you have a flat tire



The engine does not start

P. 568 If the engine will not start

P. 96 Engine immobilizer system

P. 575 If the battery is discharged



The shift lever cannot be moved out

P. 570 If the shift lever cannot be shifted from P



The engine coolant temperature gauge enters the red zone

P. 578 If your vehicle overheats



Steam can be seen coming from under the hood



The key is lost

P. 571 If you lose your keys



The battery runs out

P. 575 If the battery is discharged



The doors cannot be locked

P. 44 Side doors

P. 47 Back door



The horn begins to sound

P. 98 Alarm



The vehicle is stuck in mud or sand

P. 581 If the vehicle becomes stuck



A warning light or indicator light comes on

P.526

If a warning light turns on or a warning buzzer sounds...



■ Warning lights



Brake system warning light

or



P. 526



Malfunction indicator lamp

or



P. 527



ABS warning light

or



P. 527



Driver's seat belt reminder light

P. 528



Front passenger's seat belt reminder light

P. 528



Low fuel level warning light

P. 528



Master warning light with warning message

P. 528



SRS warning light

P. 527



Electric power steering warning light

P. 527



Open door warning light

P. 528



Pre-collision system warning light

P. 527



Charging system warning light

P. 526



Tire pressure warning light

P. 528

GAS STATION INFORMATION

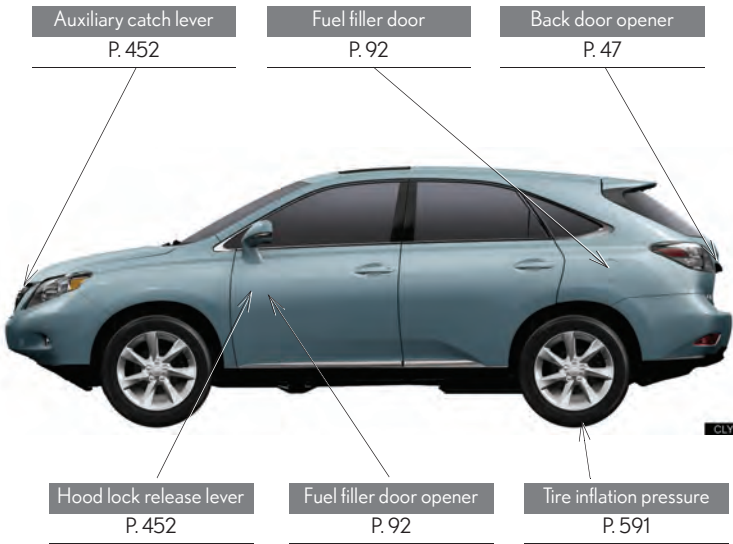

Fuel tank capacity	19.2 gal. (72.5 L, 15.9 Imp. gal.)	
Fuel type	Unleaded gasoline only	P. 586
Cold tire inflation pressure		P. 591
Engine oil capacity (Drain and refill)	With filter Without filter	qt. (L, Imp. qt.) 6.4 (6,1, 5,3) 6.0 (5,7, 5,0)
Engine oil type	Toyota Genuine Motor Oil or equivalent Oil grade: ILSAC multigrade engine oil Recommended oil viscosity: SAE-5W-20 or SAE-0W-20	P. 587



Owner's Manual:
Publication No. OM48A36U
Part No. 01999-48A36
Printed in Japan 05-0906-04 ©
RX 350 (北美U)