



2008

**RX 400h**

OWNER'S MANUAL

## TABLE OF CONTENTS

|          |                               |  |
|----------|-------------------------------|--|
| <b>1</b> | <b>Before driving</b>         | Adjusting and operating features such as door locks, mirrors, and steering column.                           |
| <b>2</b> | <b>When driving</b>           | Driving, stopping and safe-driving information.  |
| <b>3</b> | <b>Interior features</b>      | Air conditioning and audio systems, as well as other interior features for a comfortable driving experience. |
| <b>4</b> | <b>Maintenance and care</b>   | Cleaning and protecting your vehicle, performing do-it-yourself maintenance, and maintenance information.    |
| <b>5</b> | <b>When trouble arises</b>    | What to do if the vehicle needs to be towed, gets a flat tire, or is involved in an accident.                |
| <b>6</b> | <b>Vehicle specifications</b> | Detailed vehicle information.  |
| <b>7</b> | <b>For US owners</b>          | Reporting safety defects for US owners   |
|          | <b>Index</b>                  | Alphabetical listing of information contained in this manual.  |

## 1 Before driving

- 1-1. **Hybrid system**..... 24  
 Hybrid system..... 24
- 1-2. **Key information** ..... 34  
 Keys ..... 34
- 1-3. **Opening, closing and locking the doors** ..... 36  
 Wireless remote control ..... 36  
 Side doors ..... 39  
 Back door ..... 44
- 1-4. **Adjustable components (seats, mirrors, steering wheel)**..... 49  
 Front seats ..... 49  
 Rear seats ..... 52  
 Driving position memory ..... 55  
 Head restraints..... 57  
 Seat belts ..... 58  
 Steering wheel (manually adjustable type) ..... 65  
 Steering wheel (power-adjustable type)..... 66  
 Anti-glare inside rear view mirror ..... 67  
 Outside rear view mirrors ..... 68  
 Roof luggage carrier ..... 70
- 1-5. **Opening and closing the windows and moon roof** ..... 72  
 Power windows..... 72  
 Moon roof ..... 75
- 1-6. **Refueling**..... 78  
 Opening the fuel tank cap..... 78
- 1-7. **Theft deterrent system**..... 83  
 Hybrid vehicle immobilizer system ..... 83  
 Alarm..... 85  
 Theft prevention labels (U.S.A.)..... 88
- 1-8. **Safety information**..... 89  
 Correct driving posture ..... 89  
 SRS airbags ..... 91  
 Front passenger occupant classification system..... 103  
 Child restraint systems ..... 108  
 Installing child restraints..... 111

## 2 When driving

- 2-1. **Driving procedures**..... 122  
 Driving the vehicle ..... 122  
 Engine (ignition) switch ..... 131  
 Transmission ..... 135  
 Turn signal lever (type A) ..... 136  
 Turn signal lever (type B)..... 137  
 Parking brake ..... 138

|  |            |
|--|------------|
| <b>2-2. Instrument cluster</b> .....                                 | <b>139</b> |
| Gauges and meters .....  | 139        |
| Indicators and warning lights .....                                  | 141        |
| Multi-information display.....                                       | 144        |
| Trip information display<br>(without navigation<br>system).....      | 146        |
| <br>   |            |
| <b>2-3. Operating the lights and<br/>    windshield wipers</b> ..... | <b>148</b> |
| Headlight switch (type A).....                                       | 148        |
| Headlight switch (type B) .....                                      | 151        |
| Fog light switch (type A) .....                                      | 154        |
| Fog light switch (type B).....                                       | 155        |
| Windshield wipers and washer<br>(type A) .....                       | 156        |
| Windshield wipers and washer<br>(type B).....                        | 159        |
| Rear window wiper and washer<br>(type A) .....                       | 162        |
| Rear window wiper and washer<br>(type B).....                        | 163        |
| Headlight cleaner switch .....                                       | 164        |
| <br>   |            |
| <b>2-4. Using other driving systems</b> ....                         | <b>165</b> |
| Cruise control .....   | 165        |
| Dynamic laser cruise<br>control.....                                 | 168        |
| Driving assist systems.....  | 177        |
| <br>   |            |
| <b>2-5. Driving information</b> .....                                | <b>181</b> |
| Utility vehicle precautions .....                                    | 181        |
| Cargo and luggage.....   | 186        |

|                           |     |
|---------------------------|-----|
| Vehicle load limits.....  | 189 |
| Winter driving tips ..... | 190 |
| Trailer towing.....       | 195 |
| Dinghy towing .....       | 204 |

### 3 Interior features

|   |            |
|---|------------|
| <b>3-1. Using the air conditioning<br/>    system and defogger</b> .....                    | <b>206</b> |
| Automatic air conditioning<br>system .....  | 206        |
| Rear window and outside rear<br>view mirror defoggers, and<br>windshield wiper de-icer..... | 212        |
| <br>  |            |
| <b>3-2. Using the front audio<br/>    system</b> .....                                      | <b>213</b> |
| Audio system type .....   | 213        |
| Using the radio.....  | 215        |
| Using the CD player.....  | 222        |
| Playing back MP3 and<br>WMA discs.....  | 228        |
| Optimal use of the audio<br>system .....  | 236        |
| Using the steering wheel<br>audio switches .....  | 239        |
| <br>  |            |
| <b>3-3. Using the rear audio<br/>    system</b> .....                                       | <b>241</b> |
| Rear seat entertainment<br>system features .....  | 241        |
| Using the DVD player<br>(DVD video).....  | 247        |



Using the DVD player  
(video CD)..... 254

Using the DVD player  
(audio CD/ CD text)..... 256

Using the DVD player  
(MP3 discs)..... 257

Using the video mode..... 259

Changing the initial setting ..... 261

**3-4. Using the interior lights ..... 268**

Interior lights list..... 268

- Interior lights ..... 271
- Personal lights ..... 272

**3-5. Using the storage features .... 273**

List of storage features..... 273

- Glove box..... 273
- Console boxes ..... 274
- Coin holder..... 276
- Overhead console..... 277
- Cup holders..... 277
- Door pockets..... 279

**3-6. Other interior features..... 280**

Sun visors..... 280

Vanity mirror ..... 281

Clock..... 282

Outside temperature  
display ..... 283

Multi-display light control..... 284

Power outlets ..... 285

Seat heaters..... 288

Armrest ..... 290

Floor mat..... 291

Luggage compartment  
features..... 292

Garage door opener..... 295

Compass..... 300

**4 Maintenance and care**

**4-1. Maintenance and care..... 306**

Cleaning and protecting  
the vehicle exterior..... 306

Cleaning and protecting  
the vehicle interior ..... 309

**4-2. Maintenance..... 312**

Maintenance requirements ..... 312

General maintenance ..... 314

Emission inspection and  
maintenance (I/M)  
programs ..... 317

**4-3. Do-it-yourself maintenance... 318**

Do-it-yourself service  
precautions..... 318

Hood..... 321

Positioning the jack ..... 322

Engine compartment..... 324

Tires ..... 339

Tire inflation pressure..... 348

Wheels..... 352

Air conditioning filter..... 354

Wireless remote control  
battery..... 356

|   |     |
|---|-----|
| Rear seat entertainment system controller.....          | 358 |
| Checking and replacing fuses.....                       | 360 |
| Headlight aim (vehicles with discharge headlights)..... | 372 |
| Light bulbs.....  | 373 |

## 5 When trouble arises

|  |            |
|--|------------|
| <b>5-1. Essential information .....</b>                      | <b>386</b> |
| If your vehicle needs to be towed .....                      | 386        |
| If you think something is wrong.....                         | 393        |
| Event data recorder.....                                     | 394        |
| <b>5-2. Steps to take in an emergency .....</b>              | <b>396</b> |
| If a warning light turns on or a warning buzzer sounds... .. | 396        |
| If a warning message is displayed.....                       | 406        |
| If you have a flat tire.....                                 | 416        |
| If the hybrid system will not start.....                     | 426        |
| If the shift lever cannot be shifted from P.....             | 427        |
| If you lose your keys.....                                   | 428        |
| If the 12-volt battery is discharged.....                    | 429        |
| If your vehicle overheats.....                               | 432        |

|                                   |     |
|-----------------------------------|-----|
| If the vehicle becomes stuck..... | 435 |
|-----------------------------------|-----|

## 6 Vehicle specifications

|   |            |
|---|------------|
| <b>6-1. Specifications.....</b>               | <b>438</b> |
| Maintenance data (fuel, oil level, etc.)..... | 438        |
| Fuel information.....                         | 450        |
| Tire information .....                        | 453        |
| <b>6-2. Customization .....</b>               | <b>466</b> |
| Customizable features .....                   | 466        |
| <b>6-3. Initialization .....</b>              | <b>470</b> |
| Items to initialize .....                     | 470        |

## 7 For US owners

|   |     |
|---|-----|
| Reporting safety defects for U.S. owners..... | 472 |
|---|-----|

## Index

|                                |            |
|--------------------------------|------------|
| <b>Abbreviation list .....</b> | <b>474</b> |
| <b>Alphabetical index.....</b> | <b>476</b> |
| <b>What to do if... ..</b>     | <b>486</b> |

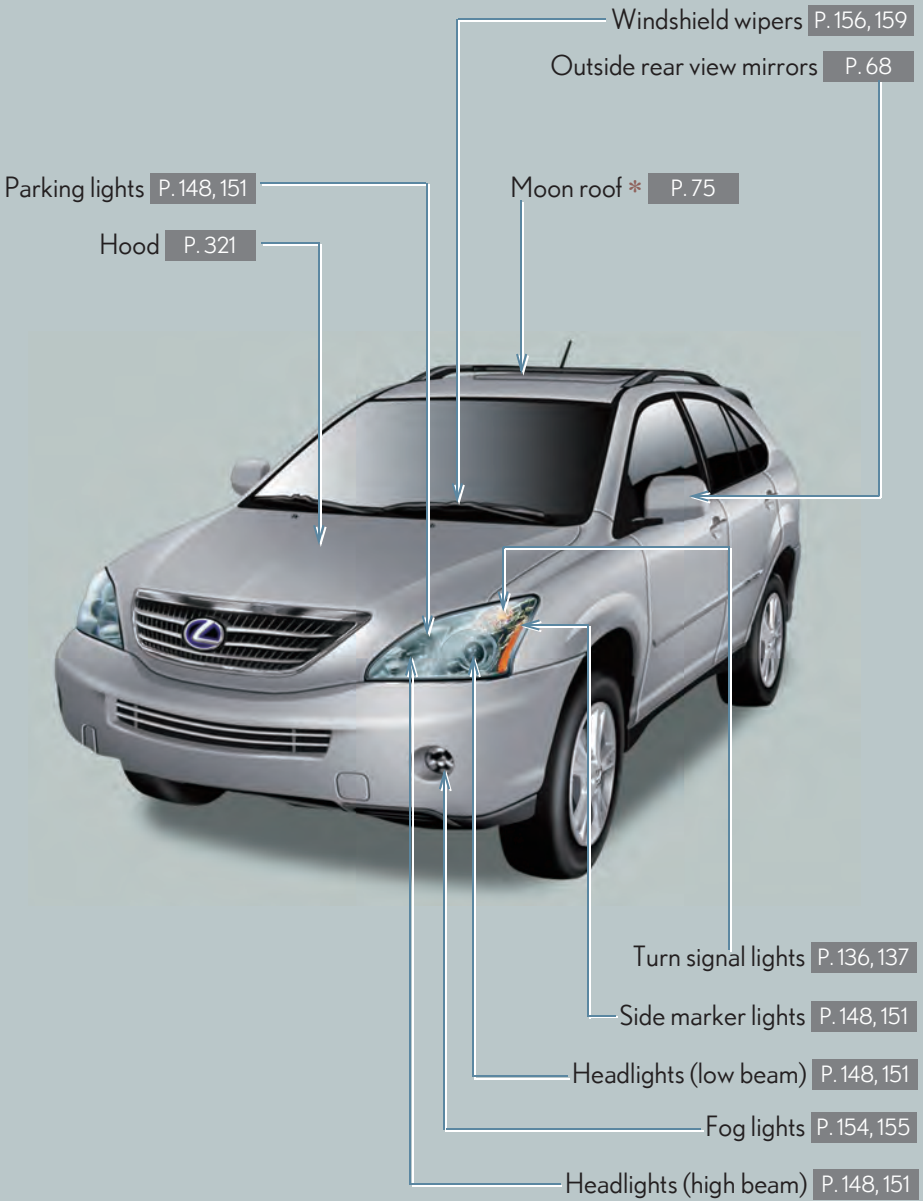

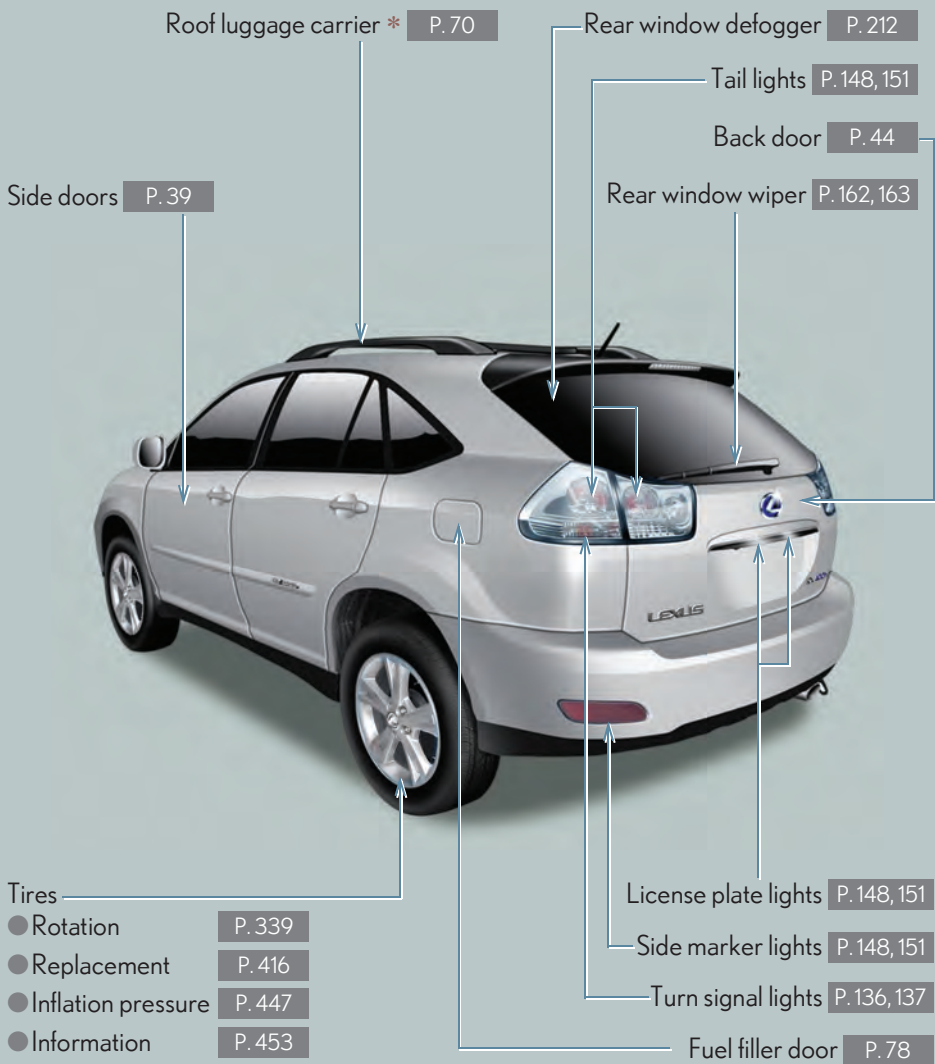

\*: If equipped

# Pictorial index

# Interior

Seat belts P. 58

Head restraints P. 57

Power window switches  
P. 72

Rear seats P. 52

A

Door pockets P. 279

Front seats P. 49

Floor mat P. 291

Driver airbag P. 91

Driver knee airbag  
P. 91

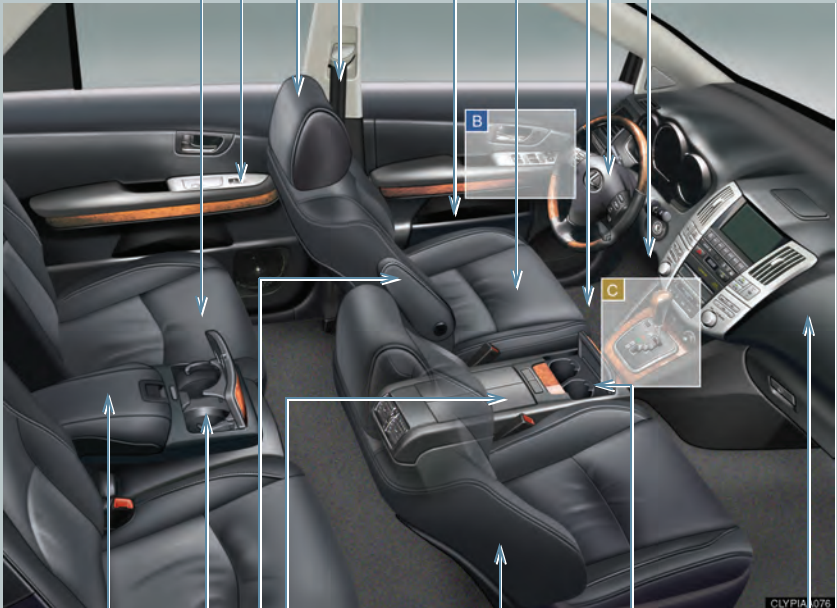

Armrest P. 290

Console box \* P. 274

Cup holders P. 277

SRS side airbags P. 91

Console box P. 274

Armrest P. 290

Front passenger airbag  
P. 91

Cup holders P. 277

A

Overhead console P. 277

Personal lights P. 272

Interior lights P. 271

Rear seat entertainment system \*

P. 241

SRS curtain shield airbags P. 91

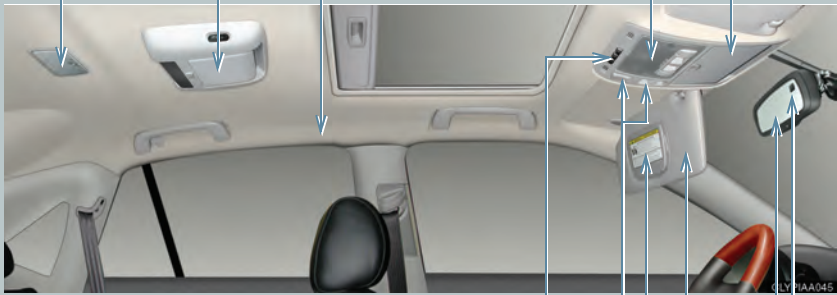

Garage door opener switches P. 295

Moon roof switches \* P. 75

Vanity mirrors P. 281

Sun visors P. 280

Anti-glare inside rear view mirror P. 67

Compass P. 300

\*: If equipped

B

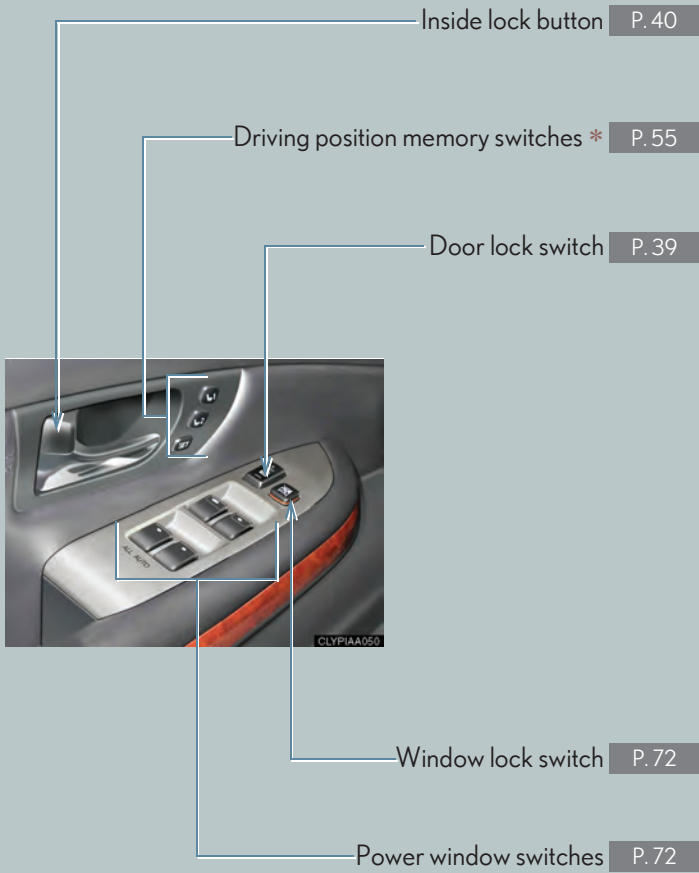

C

- Power outlet P. 285
- Headlight cleaner switch \* P. 164
- Seat heater switches \* P. 288
- Shift lever P. 135

Shift lock override button P. 427



Power outlet P. 285

\*: If equipped

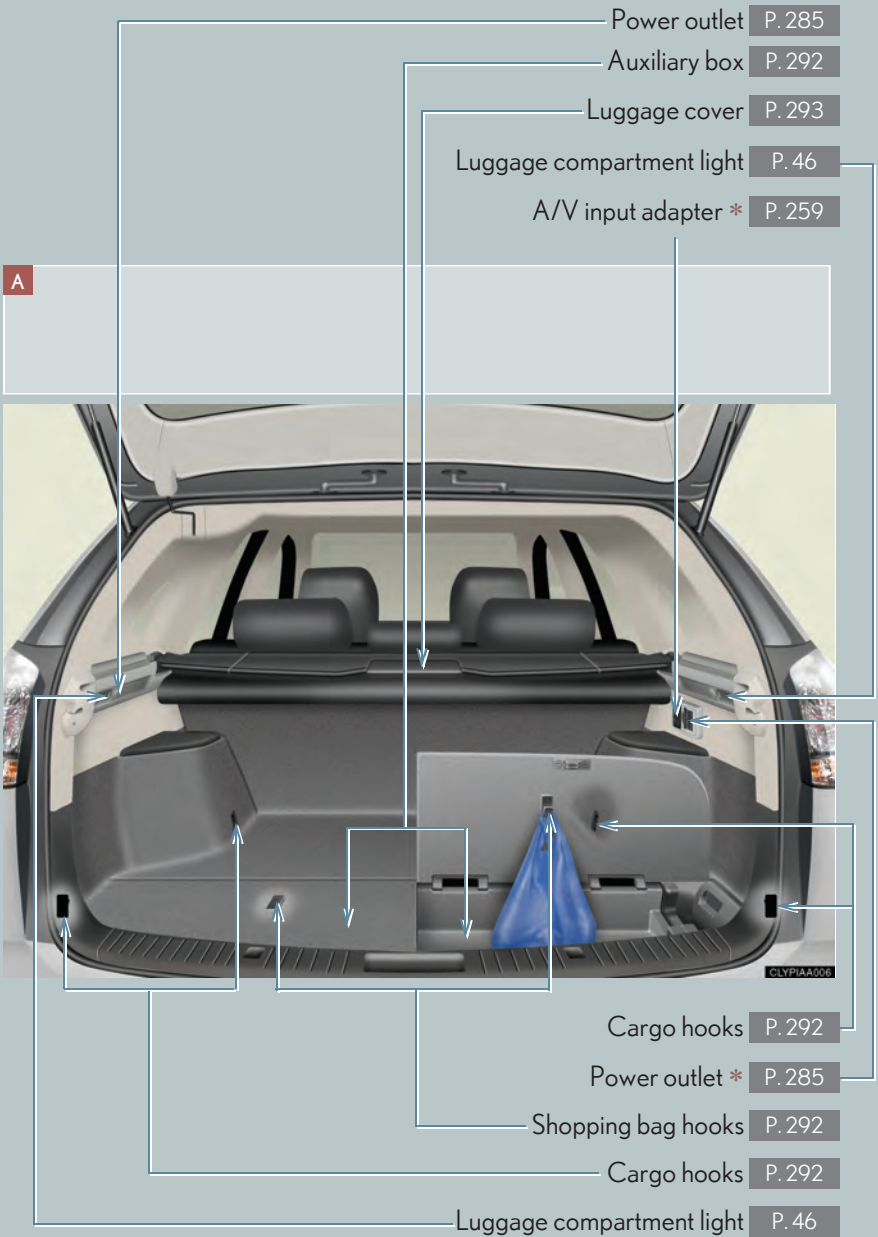

A

Power back door switch \* P. 44



Luggage compartment light P. 46

\*: If equipped

# Pictorial index

# Instrument panel

Headlight switch P. 148, 151

Turn signal lever P. 136, 137

Fog light switch P. 154, 155

Tire pressure warning select switch P. 343

Glove box P. 273

Power back door main switch \* P. 45

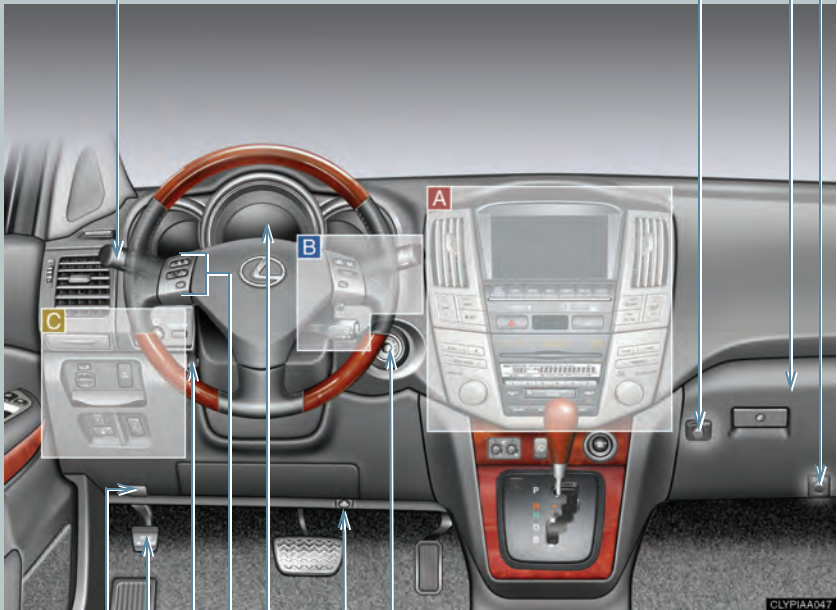

Engine switch P. 131

Tire pressure warning reset switch P. 340

Gauges and meters P. 139

Audio remote control switches P. 239

Tilt steering lock release lever \* P. 65

Tilt and telescopic steering control switch \* P. 66

Parking brake pedal P. 138

Hood release lever P. 321

**A**

► Without navigation system

Multi-display light control button  
P. 284

Security indicator  
P. 83, 85

Audio system  
P. 213

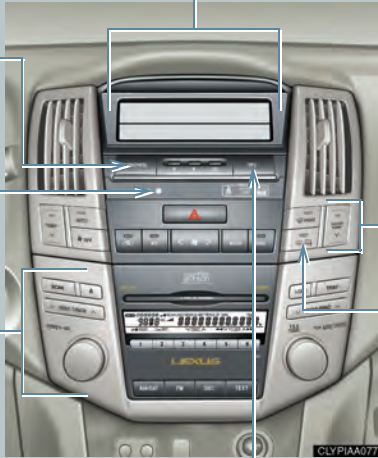

Multi-display

● Trip information display  
P.146

● Outside temperature display  
P. 283

● Clock  
P. 282

● Automatic air conditioning display  
P. 206

Air conditioning system  
P. 206

Rear window and outside rear view mirror defoggers, and windshield wiper de-icer \*  
P. 212

Trip information display control button  
P.146

► With navigation system

Security indicator  
P. 83, 85

Audio system \*



Rear view monitor/  
navigation system \*

Air conditioning system \*

Rear window and outside rear view mirror defoggers, and windshield wiper de-icer \*  
P. 212

\*: If equipped

\*: Refer to "Navigation System Owner's Manual".

B

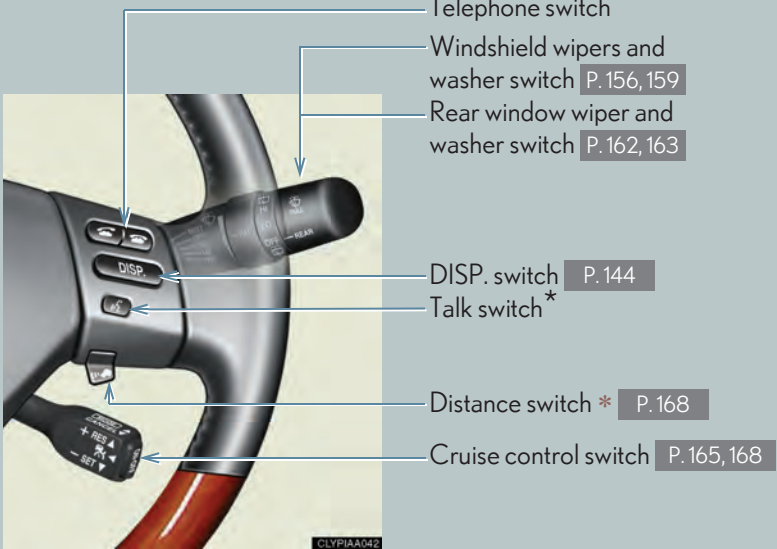

C

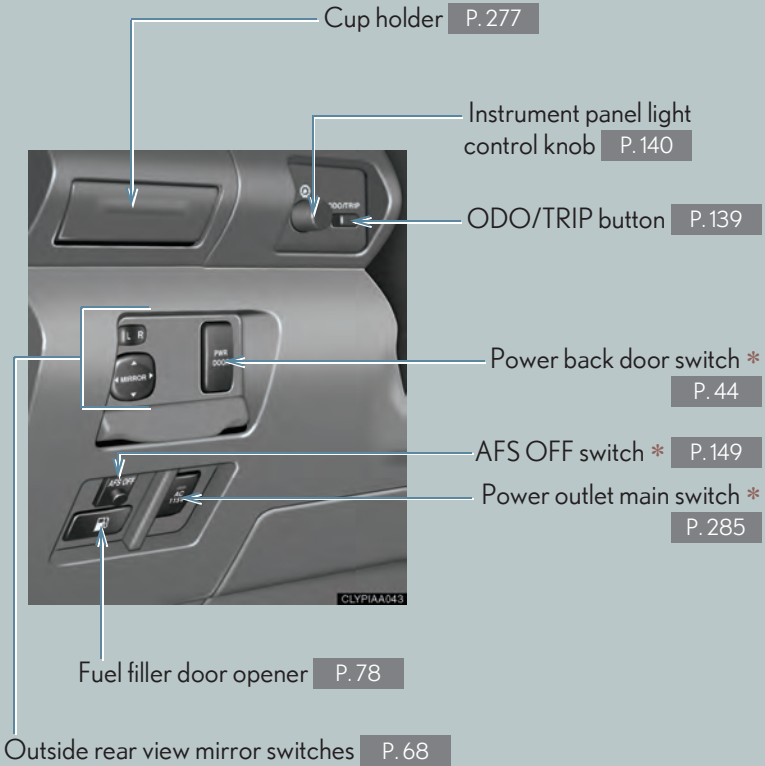

\*: If equipped

\*: Refer to "Navigation System Owner's Manual".

## For your information

### Main Owner's Manual

Please note that this manual applies to all models and explains all equipment, including options. Therefore, you may find some explanations for equipment not installed on your vehicle.

All specifications provided in this manual are current at the time of printing. However, because of the Lexus policy of continual product improvement, we reserve the right to make changes at any time without notice.

Depending on specifications, the vehicle shown in the illustration may differ from your vehicle in terms of color and equipment.

### Accessories, spare parts and modification of your Lexus

A wide variety of non-genuine spare parts and accessories for Lexus vehicles are currently available in the market. You should know that Toyota does not warrant these products and is not responsible for their performance, repair, or replacement, or for any damage they may cause to, or adverse effect they may have on, your Lexus vehicle.

This vehicle should not be modified with non-genuine Lexus products. Modification with non-genuine Lexus products could affect its performance, safety or durability, and may even violate governmental regulations. In addition, damage or performance problems resulting from the modification may not be covered under warranty.

### Installation of a mobile two-way radio system

As the installation of a mobile two-way radio system in your vehicle may affect electronic systems such as the hybrid system, multiport fuel injection system/sequential multiport fuel injection system, cruise control system, vehicle dynamics integrated management, anti-lock brake system, SRS airbag system and seat belt pretensioner system, be sure to check with your Lexus dealer for precautionary measures or special instructions regarding installation.

High voltage parts and cables on the hybrid vehicles emit approximately the same amount of electromagnetic waves as the conventional gasoline powered vehicles or home electronic appliances despite of their electromagnetic shielding.

## **Scrapping of your Lexus**

The SRS airbag and seat belt pretensioner devices in your Lexus contain explosive chemicals. If the vehicle is scrapped with the airbags and seat belt pretensioners left as they are, this may cause an accident such as fire. Be sure to have the systems of the SRS airbag and seat belt pretensioner removed and disposed of by a qualified service shop or by your Lexus dealer before you scrap your vehicle.

## **Perchlorate Material**

Special handling may apply, See [www.dtsc.ca.gov/hazardouswaste/perchlorate](http://www.dtsc.ca.gov/hazardouswaste/perchlorate).

Your vehicle has components that may contain perchlorate. These components may include airbag, seat belt pretensioners, and wireless remote control batteries.

 **CAUTION**

■ **General precautions while driving**

**Driving under the influence:** Never drive your vehicle when under the influence of alcohol or drugs that have impaired your ability to operate your vehicle. Alcohol and certain drugs delay reaction time, impair judgment and reduce coordination, which could lead to an accident that will hurt or kill you, your occupants or others.

**Defensive driving:** Always drive defensively. Anticipate mistakes that other drivers or pedestrians might make and be ready to avoid accidents.

**Driver distraction:** Always give your full attention to driving. Anything that distracts the driver, such as adjusting controls, talking on a cellular phone or reading can result in a collision with resulting death or serious injury to you, your occupants or others.

■ **General precaution regarding children's safety**

Never leave children unattended in the vehicle, and never allow children to have or use the key.

Children may be able to start the vehicle or shift the vehicle into neutral. There is also a danger that children may injure themselves by playing with the cigarette lighter, the windows, the moon roof, or other features of the vehicle. In addition, heat build-up or extremely cold temperatures inside the vehicle can be fatal to children.

■ **Dispose of the hybrid battery (traction battery)**

If your vehicle is disposed of without the hybrid battery having been removed, there is a danger of serious electric shock if high voltage parts, cables and their connectors are touched. In the event of that your vehicle must be disposed of, the hybrid battery must be disposed of your Lexus dealer or a qualified service shop. If the hybrid battery is not disposed of properly, they may cause electric shock that can result in death or serious injury.

## Symbols used throughout this manual

### Cautions & Notices

#### CAUTION

This is a warning against anything which may cause injury to people if the warning is ignored. You are informed about what you must or must not do in order to reduce the risk of injury to yourself and others.

#### NOTICE

This is a warning against anything which may cause damage to the vehicle or its equipment if the warning is ignored. You are informed about what you must or must not do in order to avoid or reduce the risk of damage to your Lexus and its equipment.

### Safety symbol



Throughout this manual, you will also see the symbol of a circle with a slash through it. This means "Do not", "Do not do this", or "Do not let this happen".



|  |           |   |           |
|--|-----------|---|-----------|
| <b>1-1. Hybrid system</b> .....  | <b>24</b> | <b>1-5. Opening and closing the windows and moon roof</b> ..... | <b>72</b> |
| Hybrid system .....  | 24        | Power windows .....   | 72        |
| <b>1-2. Key information</b> .....  | <b>34</b> | Moon roof .....   | 75        |
| Keys .....   | 34        | <b>1-6. Refueling</b> .....                                     | <b>78</b> |
| <b>1-3. Opening, closing and locking the doors</b> .....                 | <b>36</b> | Opening the fuel tank cap .....                                 | 78        |
| Wireless remote control .....  | 36        | <b>1-7. Theft deterrent system</b> ..                           | <b>83</b> |
| Side doors .....   | 39        | Hybrid vehicle immobilizer system .....                         | 83        |
| Back door .....  | 44        | Alarm .....   | 85        |
| <b>1-4. Adjustable components (seats, mirrors, steering wheel)</b> ..... | <b>49</b> | Theft prevention labels (U.S.A.) .....                          | 88        |
| Front seats .....  | 49        | <b>1-8. Safety information</b> .....                            | <b>89</b> |
| Rear seats .....   | 52        | Correct driving posture .....                                   | 89        |
| Driving position memory .....  | 55        | SRS airbags .....   | 91        |
| Head restraints .....  | 57        | Front passenger occupant classification system .....            | 103       |
| Seat belts .....   | 58        | Child restraint systems .....                                   | 108       |
| Steering wheel (manually adjustable type) .....                          | 65        | Installing child restraints .....                               | 111       |
| Steering wheel (power-adjustable type) .....                             | 66        |   |           |
| Anti-glare inside rear view mirror .....                                 | 67        |   |           |
| Outside rear view mirrors .....  | 68        |   |           |
| Roof luggage carrier .....   | 70        |   |           |

## 1-1. Hybrid system

# Hybrid system

Your vehicle is a hybrid vehicle. It has characteristics different from conventional vehicles. Be sure you are closely familiar with the characteristics of your vehicle, and operate with care.

The hybrid system combines a gasoline engine and an electric motor (traction motor) according to driving conditions, improving fuel efficiency and reducing exhaust emissions.

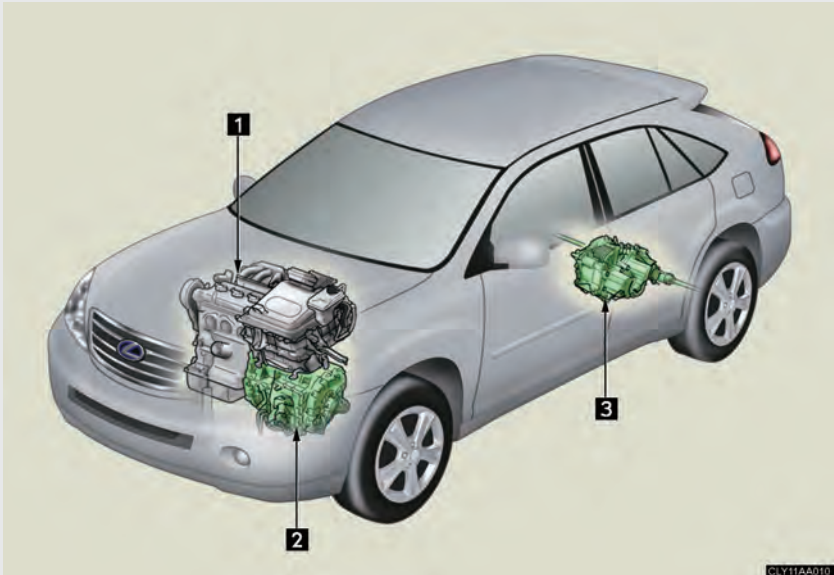

- 1 Gasoline engine
- 2 Front electric motor (traction motor)
- 3 Rear electric motor (traction motor)\*

\*: With AWD models only

### ■ When stopped/during take-off

The gasoline engine stops when the vehicle is stopped. During take-off, the electric motor (traction motor) drives the vehicle. At slow speeds or when traveling down a gentle slope, the engine is stopped and the motor is used.

### ■ During normal driving

The gasoline engine is predominantly used. The electric motor (traction motor) charges the hybrid battery as necessary.

### ■ When accelerating sharply

The power of the hybrid battery (traction battery) is added via electric motor (traction motor) to that of the gasoline engine.

### ■ When braking (regenerative brake)

The electric motor (traction motor) charges the hybrid battery (traction battery).

---

### ■ Regenerative braking

The motor generator converts kinetic energy to electric energy when:

- The accelerator pedal is released.
- The brake pedal is depressed with the shift lever in D.

### ■ Conditions in which the gasoline engine may not stop

The gasoline engine starts and stops automatically. However, it may not stop automatically in the following conditions:

- During gasoline engine warm-up
- During hybrid battery (traction battery) charging
- During low or high hybrid battery (traction battery) temperature

### ■ Charging the battery

- As the gasoline engine charges the hybrid battery (traction battery), the battery does not need to be charged from an outside source. However, if the vehicle is left parked for a long time the hybrid battery will slowly discharge. For this reason, be sure to drive the vehicle at least once every several months for at least 30 minutes or 10 miles (16 km). If the hybrid battery becomes fully discharged and you are unable to jump-start the vehicle with the battery, contact your Lexus dealer.
- If the shift lever is in N, the hybrid battery (traction battery) will not be charged. When driving in heavy traffic, operate the vehicle with the shift lever in D to avoid discharging the battery.

### ■ After the 12-volt battery has discharged or has been changed or removed

The gasoline engine may not stop even if the vehicle is running on the hybrid battery (traction battery). If this continues for a few days, contact your Lexus dealer.

### ■ Sounds and vibrations specific to a hybrid vehicle

There may be no engine sounds or vibration even though the vehicle is able to move. Always put the shift lever in P when parked.

The following sounds or vibrations may occur when the hybrid system is operating, and are not a malfunction.

- Motor sounds may be heard from the engine compartment.
- Sounds may be heard from the hybrid battery (traction battery) behind the rear seat when the hybrid system starts or stops.
- Sounds may be heard from the transmission when the hybrid system starts or stops, or while the vehicle is idling.
- Engine sounds may be heard when accelerating sharply.
- Sounds may be heard from the regenerative brake when you press the brake pedal.
- Vibration may be felt when the gasoline engine starts or stops.
- You may hear cooling fan sounds coming from the air intake vents under the rear seat.

### ■ Maintenance, repair, recycling, and disposal

Contact your Lexus dealer regarding maintenance, repair, recycling and disposal. Do not dispose of the vehicle yourself.

## High voltage components

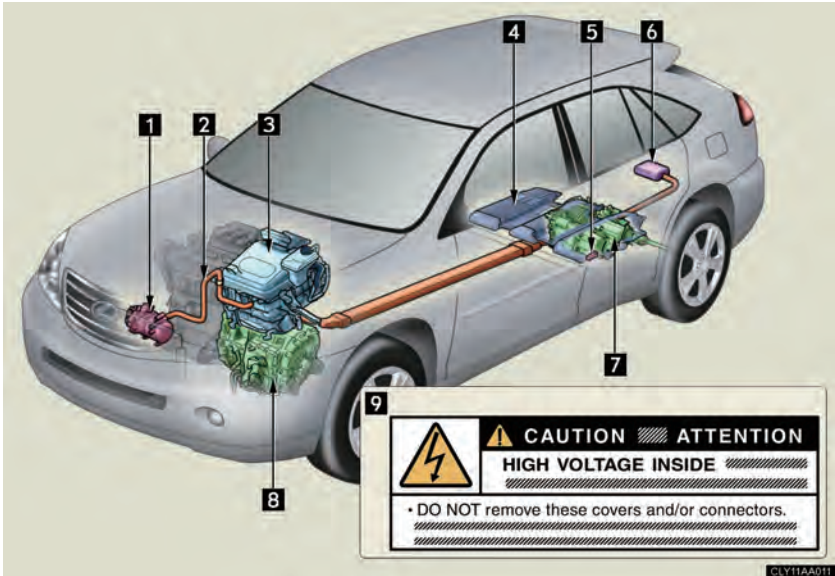

- |                                      |   |
|--------------------------------------|---|
| 1 Air conditioning compressor        | 6 DC/DC converter                       |
| 2 High voltage cables (orange color) | 7 Rear electric motor (traction motor)* |
| 3 Power control unit                 | 8 Front electric motor (traction motor) |
| 4 Hybrid battery (traction battery)  | 9 Caution label                         |
| 5 Service plug                       |   |

\*: With AWD models only

Take care when handling the hybrid system, as it contains a high voltage system (about 650V at maximum) as well as parts that become extremely hot when the hybrid system is operating. Obey the caution labels attached to the vehicle.

### ■ Hybrid battery air vent



There is an air intake vent under the rear seats to cooling the hybrid battery (traction battery). If the vent becomes blocked, the hybrid battery may overheat, leading to a reduction in hybrid battery output.

### Emergency shut off system

The emergency shut off system blocks off the high voltage current and stops the fuel pump to minimize the risk of electrocution and fuel leakage when a certain level of impact is detected by the impact sensor. If the emergency shut off system activates, your vehicle will not restart. To restart the hybrid system, contact your Lexus dealer.

### Energy monitor/consumption screen

You can view the status of your hybrid system on the multi-information display (→P. 144) and the navigation system screen. The following images are examples only, and may vary slightly from actual conditions.

#### ■ Energy monitor

- How to display on the navigation system screen:

**STEP 1** Press INFO.

**STEP 2** Touch  on the Information screen.

If the Consumption screen is displayed, touch .

- How to display on the multi-information display:

**STEP 1** Push the  button several times to select the energy monitor display.

|   | Navigation system screen  | Multi-information display   |
|---|---|---|
| When the vehicle is powered by the electric motor (traction motor)                              |   |   |
| When the vehicle is powered by both the gasoline engine and the electric motor (traction motor) |   |   |
| When the vehicle is powered by the gasoline engine  |   |   |
| When the vehicle is charging the hybrid battery (traction battery)                              |   |   |
|   |   |   |
| When there is no energy flow  |   |   |
| Hybrid battery (traction battery) status  | <div style="display: flex; justify-content: space-around;"> <span>Low</span> <span>Full</span> </div> | <div style="display: flex; justify-content: space-around;"> <span>Low</span> <span>Full</span> </div> |

### Consumption

**STEP 1** Press .

**STEP 2** Touch  on the Information screen.

If the "Energy Monitor" screen is displayed, touch .

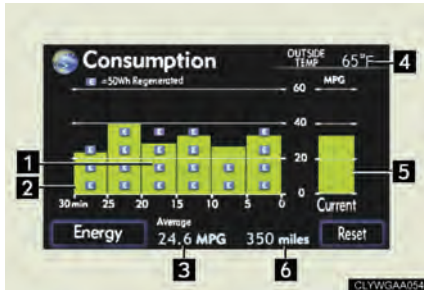

- 1 Regenerated energy in the past 30 minutes  
One symbol indicates 50 Wh. Up to 4 symbols are shown.
- 2 Fuel consumption in the past 30 minutes
- 3 Average fuel consumption
- 4 Outside temperature
- 5 Instantaneous fuel consumption
- 6 Cruising range

### Resetting the consumption data

Touching  will reset the average fuel consumption.

### Hybrid warning message

A message is automatically displayed when a malfunction occurs in the hybrid system or an improper operation is attempted.



If a warning message is shown on the multi-information display and the navigation system screen (if equipped), read the message and follow the instructions. (→P. 406)

■ **If a warning light comes on or a warning message is displayed, or the 12-volt battery is disconnected**

The hybrid system may not start. In that case, try to start the system again. If the READY light does not come on, contact your Lexus dealer.

■ **Emergency shut off system**

The emergency shut off system blocks off the high voltage current and stops the fuel pump to minimize the risk of the electric leakage and the fuel leakage when a certain level of impact is detected by the impact sensor. If the system activates, your vehicle will not restart. To restart the hybrid system, contact a Lexus dealer.

 **CAUTION**

■ **High voltage precautions**

The vehicle has high voltage DC and AC systems as well as a system. DC and AC high voltage is very dangerous and can cause severe burns and electric shock that may result in death or serious injury.

- Never touch, disassemble, remove or replace the high voltage parts, cables and their connectors.
- The hybrid system will become hot after starting as the system uses high voltage. Be careful of both the high voltage and the high temperature, and always obey the caution labels attached to the vehicle.
- Never try to open the service plug access hole located in the luggage compartment. The service plug is used only when the vehicle is serviced and is subject to high voltage.

### CAUTION

#### ■ Road accident cautions

Observe the following precautions to reduce the risk of injury.

- Pull your vehicle off the road, put the shift lever in P, apply the parking brake, turn the hybrid system off and remove the key.
- Do not touch the high voltage parts, cables and connectors.
- If electric wires are exposed inside or outside your vehicle, an electric shock may occur. Never touch exposed electric wires.
- If a fluid leak occurs, do not touch it as it may be strong alkaline electrolyte from the hybrid battery (traction battery). If it comes into contact with your skin or eyes, wash it off immediately with a large amount of water or if possible, boric acid solution. Seek immediate medical attention.
- If a fire occurs in the hybrid vehicle, leave the vehicle as soon as possible. Never use a fire extinguisher that is not meant for electric fires. Using even a small amount of water may be dangerous.
- If your vehicle needs to be towed, do so with the front wheels (for 2WD models) or four wheels (for AWD models) raised. If the wheels with the electric motor (traction motor) are on the ground when towing, the motor may continue to generate electricity. This may cause an electricity leakage leading to a fire.(→P. 386)

#### ■ Nickel-metal hydride battery

Your vehicle contains a sealed nickel-metal hydride battery. If disposed of improperly, it is hazardous to the environment and there is a risk of severe burns and electrical shock that may result in death or serious injury.

#### ■ If the system activates

- Carefully check to see if there are exposed high voltage parts or cables. Never touch the parts or cables. (→P. 27)
- Carefully inspect the ground under the vehicle. If you find that liquid has leaked onto the ground, the fuel system may have been damaged. Leave the vehicle as soon as possible.

 NOTICE**■ Hybrid battery air vent**

- Do not put foreign objects over the air vent. The hybrid battery (traction battery) may overheat and be damaged.
- Clean the air vent regularly to prevent the hybrid battery (traction battery) from overheating.
- Do not wet the air vent. It may cause a short circuit and damage the hybrid battery (traction battery).
- Do not load a large amount of water such as an aquarium into the vehicle. If water spills over the hybrid battery (traction battery), the battery may be damaged.

## 1-2. Key information

# Keys

The following keys are provided with the vehicle.

- ▶ Vehicles without power back door system



- ▶ Vehicles with power back door system



- 1 Master keys
- 2 Valet key
- 3 Key number plate
- 4 Flat key

**■ When required to leave a key to the vehicle with a parking attendant**

Lock the glove box as circumstances demand. (→ P. 273)

Carry the master key for your own use and leave the valet key only with the attendant.

**■ Key number plate**

Keep the plate in a safe place such as your wallet, not in the vehicle. In the event that a key is lost, a new key can be made at your Lexus dealer using the key number plate. (→P. 428)

**NOTICE****■ To prevent key damage**

- Do not subject the keys to strong shocks, expose them to high temperatures by placing them in direct sunlight, or get them wet.
- Do not expose the keys to electromagnetic materials or attach any material that blocks electromagnetic waves to the key surface.

## 1-3. Opening, closing and locking the doors

### Wireless remote control

The wireless remote control can be used to lock/unlock the vehicle and open/close the back door from outside the vehicle.

#### ► Vehicles without power back door

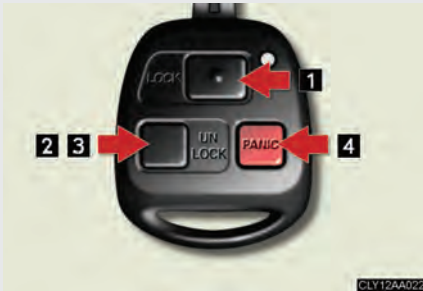

- 1 Locks all doors
- 2 Unlocks all doors
- 3 Opens the windows and moon roof  
Push and hold.
- 4 Sounds alarm (→P. 85)  
Push and hold.

#### ► Vehicles with power back door



- 1 Locks all doors
- 2 Sounds alarm (→P. 85)  
Push and hold.
- 3 Unlocks all doors
- 4 Opens the windows and moon roof  
Push and hold.
- 5 Opens and closes the back door  
Push and hold.

### ■ 2-step unlocking function

When you push the UNLOCK button, the driver's door is unlocked. Pushing the button again within 3 seconds unlocks the other doors.

### ■ Back door operation

The back door can be opened even if it is locked. Lock the back door again when you leave the vehicle. The back door will not lock automatically after it has been opened and then closed.

### ■ Operation signals

Side doors: A buzzer sounds and the emergency flashers flash to indicate that the doors have been locked/unlocked. (Locked: Once; Unlocked: Twice)

Back door: A buzzer sounds twice and the emergency flashers flash twice to indicate that the back door has been opened/closed.

Windows and moon roof: A buzzer sounds to indicate that the windows and moon roof are operating.

### ■ Door lock buzzer

If a door is not fully closed, a buzzer sounds continuously if an attempt to lock the door is made. Fully close the door to stop the buzzer, and lock the vehicle once more.

### ■ Security feature

If a door is not opened within approximately 60 seconds after the vehicle is unlocked, the anti-theft system automatically locks the vehicle again.

### ■ Battery depletion

→P. 356

### ■ Customization that can be configured at Lexus dealer

Settings (e.g. door unlocking function) can be changed. (Customizable features →P. 466)

### ■ Reversing the operation of the power back door

Pressing the wireless remote control switch again while the power back door is operating will cause the operation to reverse. However, the reverse operation cannot be performed for the first second after automatic operation starts, even if the wireless remote control switch is pressed again.

### ■ Certification for wireless remote control

► For vehicles sold in the U.S.A.

#### NOTE:

This device complies with Part 15 of the FCC Rules. Operation is subject to the following two conditions: (1) This device may not cause harmful interference, and (2) this device must accept any interference received, including interference that may cause undesired operation.

#### NOTICE:

This equipment has been tested and found to comply with the limits for a Class B digital device, pursuant to Part 15 of the FCC Rules. These limits are designed to provide reasonable protection against harmful interference in a residential installation. This equipment generates, uses and can radiate radio frequency energy and, if not installed and used in accordance with the instructions, may cause harmful interference to radio communications. However, there is no guarantee that interference will not occur in a particular installation. If this equipment does cause harmful interference to radio or television reception, which can be determined by turning the equipment off and on, the user is encouraged to try to correct the interference by one or more of the following measures:

- Reorient or relocate the receiving antenna.
- Increase the separation between the equipment and receiver.
- Connect the equipment into an outlet on a circuit different from that to which the receiver is connected.
- Consult the dealer or an experienced radio-TV technician for help.

#### FCC WARNING:

Changes or modifications not expressly approved by the party responsible for compliance could void the user's authority to operate the equipment.

► For vehicles sold in Canada

#### NOTE:

Operation is subject to the following two conditions: (1) this device may not cause interference, and (2) this device must accept any interference, including interference that may cause undesired operation of the device.

## 1-3. Opening, closing and locking the doors

### Side doors

The vehicle can be locked and unlocked using a key, wireless remote control or door lock switch.

#### ■ Key

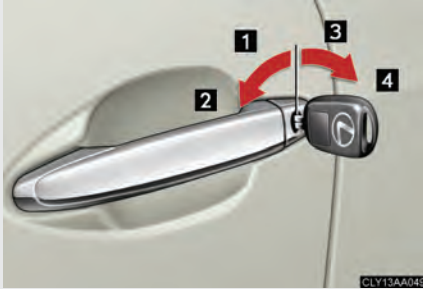

- 1 Locks all doors
- 2 Closes the windows and moon roof (turn and hold)
- 3 Unlocks all doors  
Turning the key unlocks the driver's door. Turning the key again unlocks the other doors.
- 4 Opens the windows and moon roof (turn and hold)

#### ■ Wireless remote control

→P. 36

#### ■ Door lock switch



- 1 Locks all doors
- 2 Unlocks all doors

### ■ Inside lock button

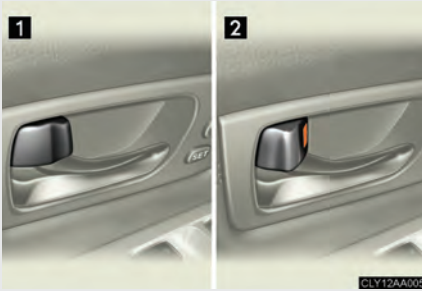

- 1 Locks the door
- 2 Unlocks the door

The front doors can be opened by pulling the inside handle even if the lock buttons are in the lock position.

### ■ Locking the front doors from the outside without a key

The door cannot be locked if either of the front doors is open and the key is in the engine switch.

### ■ Rear door child-protector lock



- 1 The rear door cannot be opened from inside the vehicle when the locks are set.

These locks can be set to prevent children from opening the rear doors. Push down on each rear door switch to lock both rear doors.

## Automatic door locking and unlocking systems

The following functions can be set or cancelled:

| Function                                      | Operation   |
|---|---|
| Shift position linked door locking function   | Shifting the shift lever out of P locks all doors.  |
| Shift position linked door unlocking function | Shifting the shift lever to P unlocks all doors.  |
| Speed linked door locking function            | All doors are locked when the vehicle speed is approximately 12 mph (20 km/h) or higher.  |
| Driver's door linked door unlocking function  | All doors are unlocked when the driver's door is opened within 10 seconds after turning the engine switch to the LOCK position. |

To switch between setting and canceling, follow the procedure below:

- STEP 1** Close all the doors and turn the engine switch to the ON position.  
(Perform the step 2 within 10 seconds.)
- STEP 2** Shift the shift lever to P or N, and press and hold the driver's door lock switch (1 or 2) for approximately 5 seconds and then release.

The shift lever and switch positions corresponding to the desired function to be set or canceled are shown as follows.



| Function                                      | Shift lever position | Switch position |
|---|----------------------|-----------------|
| Shift position linked door locking function   | P                    | 1               |
| Shift position linked door unlocking function |                      | 2               |
| Speed linked door locking function            | N                    | 1               |
| Driver's door linked door unlocking function  |                      | 2               |

When the setting or canceling operation is complete, all doors are locked and then unlocked.

### ■ Impact detection door lock release system

In the event that the vehicle is subject to a strong impact, all the doors are unlocked. Depending on the force of the impact or the type of accident, however, the system may not operate.

### ■ If a wrong key is used

The key cylinder rotates freely to isolate inside mechanism.

### ■ Customization that can be configured at Lexus dealer

Settings (e.g. unlocking function using a key) can be changed. (Customizable features →P. 466)

 **CAUTION****■ To prevent an accident**

Observe the following precautions while driving the vehicle.

Failing to do so may result in a door opening and an occupant falling out, resulting in death or serious injury.

- Always use a seat belt.
- Always lock all doors.
- Ensure that all doors are properly closed.
- Do not pull the inside handle of the front door while driving.
- Set the rear door child protector locks when children are seated in the rear seat.

## 1-3. Opening, closing and locking the doors

### Back door

The back door can be opened using the back door opener.

In addition, the power back door can be opened/closed using the power back door switch or wireless remote control.

#### ■ Back door opener

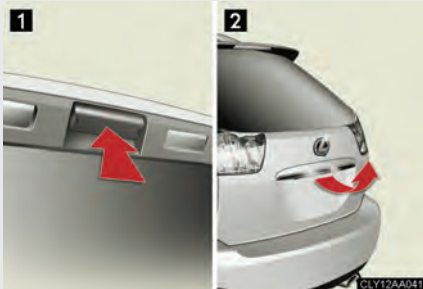

1 Push up

2 Raise

#### ■ Power back door switches (vehicles with power back door)

##### ► Instrument panel



Push the switch for 1 second to open/close.

Pressing the switch again while the power back door is operating will cause the operation to reverse.

However, the reverse operation cannot be performed for the first second after pressing the switch to operate the door.

### ▶ Back door



Push the switch to close.

Pressing the switch again while the power back door is closing will cause it to open again.

However, the reverse operation cannot be performed for the first second after pressing the switch to close the door.

The back door can be opened even if it is locked. Lock the back door again when you leave the vehicle. The back door will not lock automatically after it has been opened and then closed.

A buzzer sounds twice and the emergency flashers flash twice to indicate that the back door has been opened/closed.

### ■ Wireless remote control (vehicles with power back door)

→P. 36

### Canceling the power back door system (vehicles with power back door)

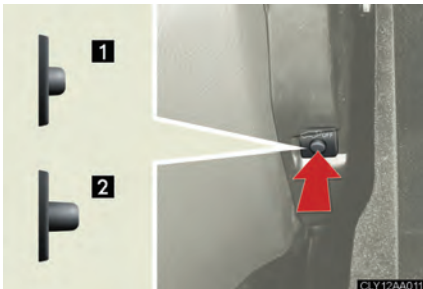

Turn off the main switch in the glove box to disable the power back door system.

1 ON

2 OFF

The back door cannot be opened even with the wireless remote control or power back door switch.

### ■ Luggage compartment light



The luggage compartment light turns on when the back door is opened and the light switch is ON.

### ■ Back door handle



Use the back door handle when closing.

If the vehicle is equipped with a power back door, the back door automatically pulls closed in the event that the door is not properly latched when closed.

### ■ If the back door opener is inoperative

The back door can be opened from the inside.

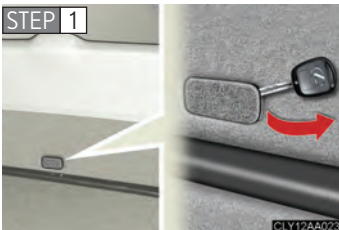

Remove the cover.

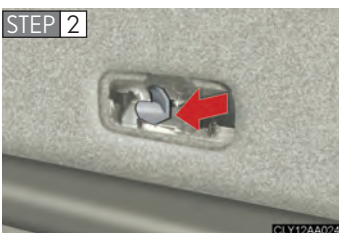

Push the lever.

■ **The power back door can be opened when**

The engine switch is in the ON position, and the shift lever is in P.

■ **Jam protection function**

If anything obstructs the power back door while it is closing/opening, the back door will automatically operate in the opposite direction.

■ **If the power back door does not work**

The back door must be initialized. To initialize, close the back door completely by hand.

■ **Customization that can be configured at Lexus dealer**

Settings (e.g. beep sound) can be changed. (Customizable features →P. 466)

 **CAUTION**

Observe the following precautions.

Falling to do so may result in death or serious injury.

■ **Keep the back door closed while driving**

If the back door is opening, the luggage will be thrown out and exhaust gases will be entered in the vehicle.

■ **When the back door is opened while parking**

The open back door hides the rear lights. Other road users must be warned of the presence of your vehicle by a warning triangle or other device.

■ **Operating the power back door**

- Check to make sure that passengers do not have any part of their body in a position where it could be caught or hit when the back door is being operated.
- Careful attention is needed so as not to get your fingers trapped as the back door automatically closes when it has not been fully closed.
- Do not allow children to operate the back door.  
Closing the back door on someone can cause serious injury, and in some instances, even death.

### CAUTION

#### ■ Jam protection function

- Never try jamming any part of your body to activate the jam protection function intentionally.
- The jam protection function may not work if something gets caught just before the back door is fully closed.

### NOTICE

#### ■ To prevent damage to the back door components

- Do not apply any force, paint or let any other foreign matter on the damper.
- Do not apply excessive force when the back door closer is operating.
- Make sure there is nothing in the doorway before closing.

## 1-4. Adjustable components (seats, mirrors, steering wheel)

### Front seats

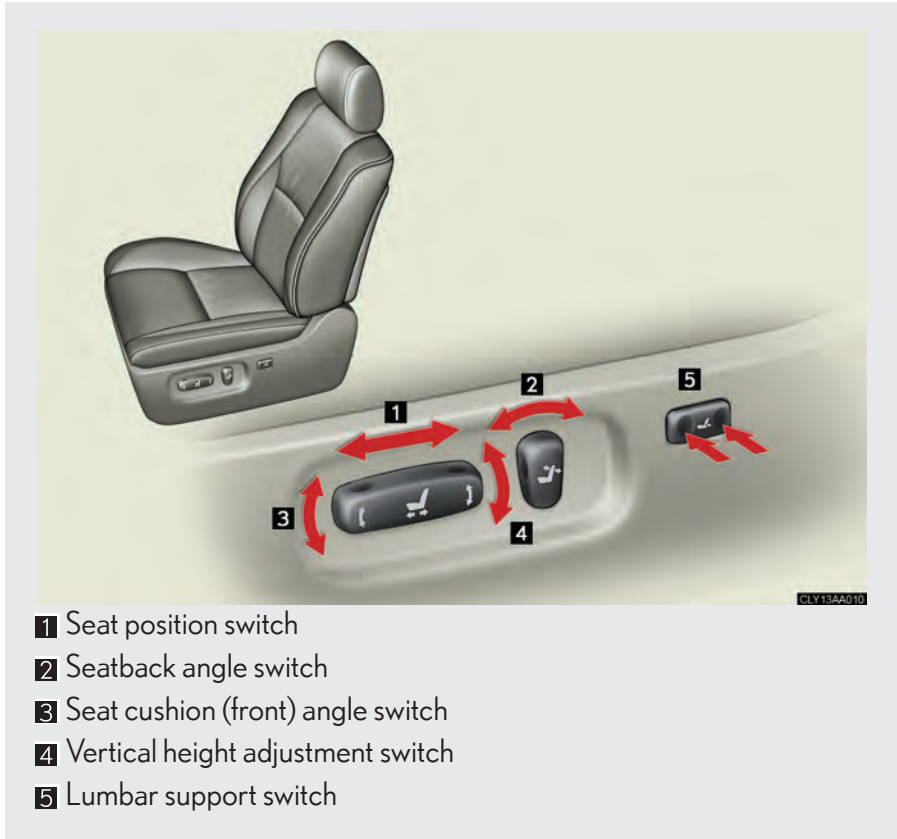

1

Before driving

### Flattening seatback

#### ■ Before flattening seatbacks

Slide the rear seats as far back as possible. (→P. 52)

### ■ Flattening seatbacks

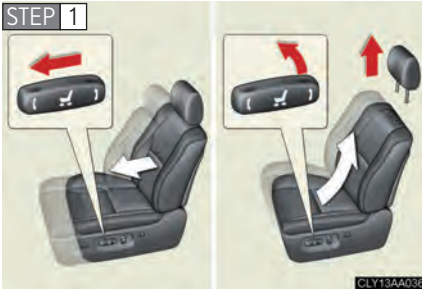

Move the seat forward, raise the seat, and remove the head-restraint.

After returning the seat to its original position, be certain to replace the head restraint.

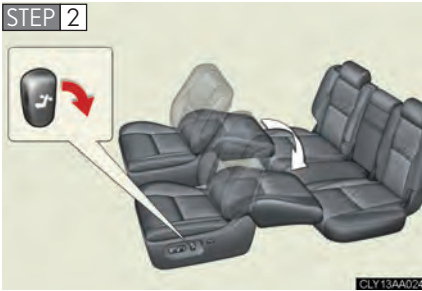

Move the seatback angle control switch backward to flatten the seatback.



Push the vertical height adjustment switch downward.

 CAUTION

■ **Seat adjustment**

Do not recline the seat more than necessary when the vehicle is in motion to reduce the risk of sliding under the lap belt.

If the seat is too reclined, the lap belt may slide past the hips and apply restraint forces directly to the abdomen or your neck may contact the shoulder belt, increasing the risk of death or serious injury in the event of an accident.

■ **While driving**

- Do not allow passengers to ride on the flattened seat.
- Do not drive with the head restraints removed.

## 1-4. Adjustable components (seats, mirrors, steering wheel)

### Rear seats



### Folding down rear seatbacks

#### ■ Before folding down rear seatbacks

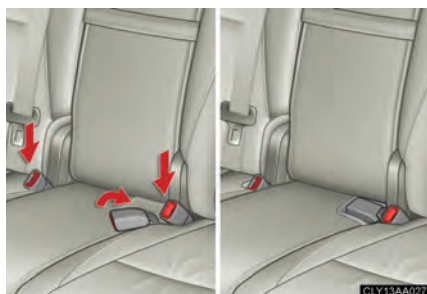

Stow the rear seat belt buckles.

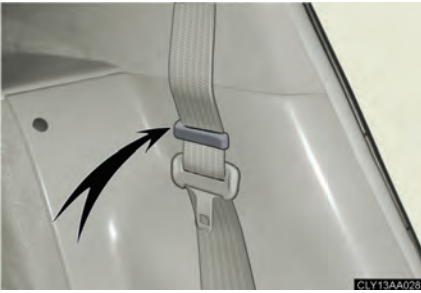

Use the seat belt hangers to prevent the belts from being tangled.

**Folding down rear seatbacks**

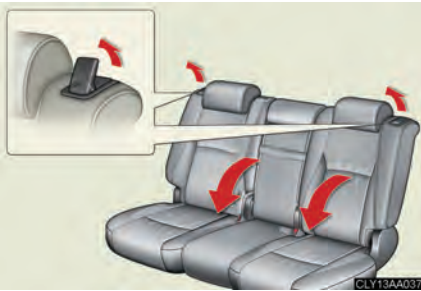

Pulling the seatback angle lever and fold them down until they lock.

When return the rear seatbacks to their original positions, unlock the seatbacks by pulling the seatback angle lever and lift them up until they lock.

**Folding down rear center seatback**



Pulling the center seatback angle lever behind the seatback and fold it down.

When return the rear center seatback to its original position, lift it up until it locks.

 CAUTION

■ **Seat adjustment**

- Do not recline the seat more than necessary when the vehicle is in motion to reduce the risk of sliding under the lap belt. If the seat is too reclined, the lap belt may slide past the hips and apply restraint forces directly to the abdomen or your neck may contact the shoulder belt, increasing the risk of death or serious injury in the event of an accident.
- Be careful not to get hands or feet pinched between the rear console box and the rear seat when folding down the rear seatback.

■ **When returning the seatback to the upright position**

Observe the following precautions. Failure to do so may result in death or serious injury.

- Press forward and rearward on the top of the seatback.
- Check that the seat belts are not twisted or caught under the seat.
- Arrange the seat belts in the proper positions for ready use.

 NOTICE

■ **Stowing the seatbelts**

The seat belts and the buckles must be stowed before you fold down the rear seatbacks.

## 1-4. Adjustable components (seats, mirrors, steering wheel)

### Driving position memory (if equipped)

1

Before driving

Your preferred driving position (the position of the driver's seat, steering wheel and outside rear view mirrors) can be memorized and recalled with the touch of a button.

Two different driving positions can be entered into memory.

#### ■ Entering a position to memory

Check that the shift lever is set in P.

**STEP 1** Turn the engine switch to the ON position.

**STEP 2** Adjust the driver's seat, steering wheel, and outside rear view mirrors to the desired positions.

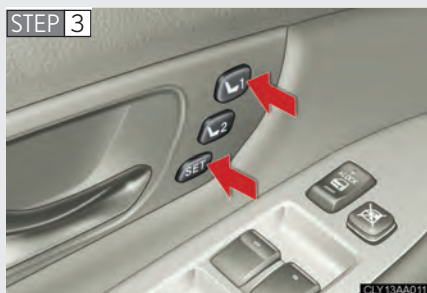

While pushing the SET button, push button 1 or 2 until the signal beeps.

If the selected button has already been preset, the previously recorded position will be overwritten.

#### ■ Recalling the memorized position

Check that the shift lever is set in P.

**STEP 1** Turn the engine switch to the ON position.



Push button 1 or 2 to recall the memorized position.

### ■ Retained accessory power

Memorized positions (except for the steering wheel positions) can be activated up to 30 seconds after the driver's door is opened, even if the key is removed from the engine switch.

### ■ If any position memory button is pushed while the adjustments are being made

The operation will stop. To reactivate the system, push the desired button (1 or 2) again.

### ■ If the battery is disconnected

The memorized are erased when the battery is disconnected.

### CAUTION

#### ■ Seat adjustment caution

Take care during seat adjustment that the seat does not strike the rear passenger or squeeze your body against the steering wheel.

## 1-4. Adjustable components (seats, mirrors, steering wheel)

### Head restraints

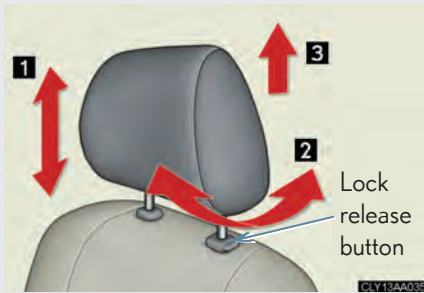

#### 1 Vertical adjustment

Push and hold the lock release button when lowering the head restraint.

#### 2 Angle adjustment \*

#### 3 Removal

Pull the head restraint up while pushing the lock release button.

\*: Front seats only

1

Before driving

#### ■ Adjusting the height of the head restraints

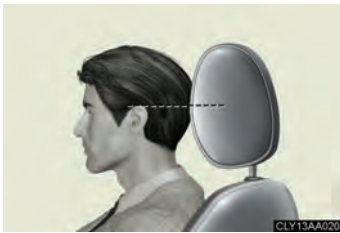

Make sure that the head restraints are adjusted so that the center of the head restraint is closest to the top of your ears.

#### ■ Adjusting the rear center seat head restraints

Always raise the head restraint to the lock position when using.

#### ■ Head restraints of different seats

The head restraints are specially designed for the seats on which they are installed.

### ⚠ CAUTION

#### ■ Head restraint precautions

Observe the following precautions regarding the head restraints. Failure to do so may result in death or serious injury.

- Adjust the head restraints to the correct position at all times.
- Do not drive with the head restraints removed.

## 1-4. Adjustable components (seats, mirrors, steering wheel)

### Seat belts

Make sure that all occupants are wearing their seat belts before driving the vehicle.

#### ■ Correct use of the seat belts



- Extend the shoulder belt so that it comes fully over the shoulder, but does not come into contact with the neck or slide off the shoulder.
- Position the lap belt as low as possible over the hips.
- Adjust the position of the seatback. Sit up straight and well back in the seat.
- Do not twist the seat belt.

#### ■ Fastening and releasing the seat belt



##### 1 Fastening the belt

Push the tab into the buckle until a clicking sound is heard.

##### 2 Releasing the belt

Press the release button.

### ■ Adjusting the height of the belt (front seats)

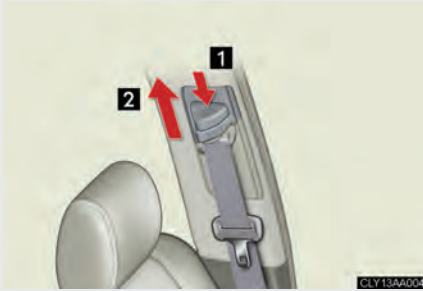

1 Down

2 Up

Move the height adjuster up and down as needed until you hear a click.

1

Before driving

### ■ Seat belt comfort guide (outside rear seats)

If the shoulder belt sits close to a person's neck, use the seat belt comfort guide.

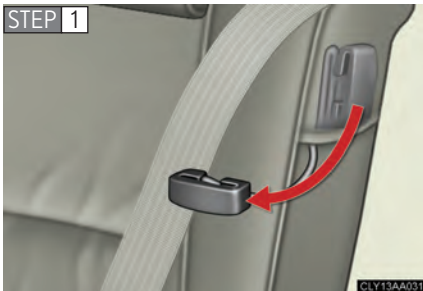

Pull the comfort guide from the pocket.

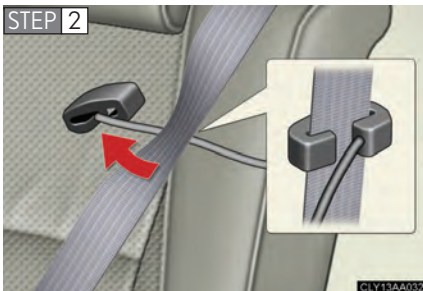

Slide the belt past the slot of the guide.

The elastic cord must be behind the seat belt.

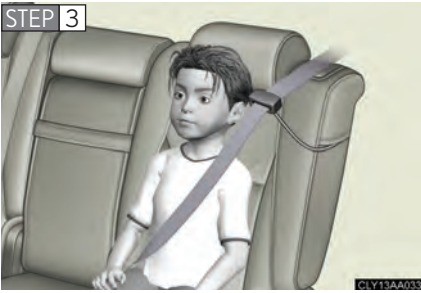

Buckle, position and release the seat belt.

### Seat belt pretensioners (front seats)



The pretensioner helps the seat belt to quickly restrain the occupant by retracting the seat belt when the vehicle is subjected to certain types of severe frontal collision or a vehicle rollover.

The pretensioner may not activate in the event of a minor frontal impact, a side impact or a rear impact.

### ■ Emergency locking retractor (ELR)

The retractor will lock the belt during a sudden stop or on impact. It may also lock if you lean forward too quickly. A slow, easy motion will allow the belt to extend so that you can move around fully.

### ■ Automatic locking retractor (ALR)

When a passenger's shoulder belt is completely extended and then retracted even slightly, the belt is locked in that position and cannot be extended. This feature is used to hold the child restraint system (CRS) firmly. To free the belt again, fully retract the belt and then pull the belt out once more. (→P. 111)

### ■ Pregnant women



Obtain medical advice and wear the seat belt in the proper way. (→P. 58)

Women who are pregnant should position the lap belt as low as possible over the hips in the same manner as other occupants. Extend the shoulder belt completely over the shoulder and position the belt across the chest. Avoid belt contact over the rounding of the abdominal area.

If the seat belt is not worn properly, not only a pregnant woman, but also the fetus could suffer death or serious injury as a result of sudden braking or a collision.

### ■ People suffering illness

Obtain medical advice and wear the seat belt in the proper way. (→P. 58)

### ■ Child seat belt usage

The seat belts of your vehicle were principally designed for persons of adult size.

- Use a child restraint system appropriate for the child, until the child become large enough to properly wear the vehicle's seat belt. (→P. 108)
- When the child becomes large enough to properly wear the vehicle's seat belt, follow the instructions on P. 58 regarding seat belt usage.

### ■ Replacing the belt after the pretensioner has been activated

The seat belts cannot be used after a pretensioner has been activated. After an accident, have your Lexus dealer inspect the pretensioners. Make sure the pretensioners are replaced if they have been activated.

### ■ Seat belt extender



If your seat belts cannot be fastened securely because they are not long enough, a personalized seat belt extender is available from your Lexus dealer free of charge.

 **CAUTION****■ Wearing a seat belt**

Observe the following precautions to reduce the risk of injury in the event of sudden braking or an accident.

Failing to do so may cause death or severe injury.

- Ensure that all passengers wear a seat belt.
- Always wear a seat belt properly.
- Each seat belt should be used by one person only. Do not use a seat belt for more than one person at once, including children.
- Lexus recommends that children be seated in the rear seat and always use a seat belt and/or an appropriate child restraint system.
- Do not recline the seat any more than necessary to achieve a proper seating position. The seat belt is most effective when the occupants are sitting up straight and well back in the seats.
- Do not wear the shoulder belt under your arm.
- Always wear your seat belt low and snug across your hips.

**■ Seat belt damage and wear**

- Do not damage the seat belts by allowing the belt, plate, or buckle to be jammed in the door.
- Inspect the seat belt system periodically. Check for cuts, fraying, and loose parts. Do not use a damaged seat belt until it is replaced. Damaged seat belts cannot protect an occupant from death or serious injury.
- Ensure that the belt and tab are locked and the belt is not twisted. If the seat belt does not function correctly, immediately contact your Lexus dealer.
- Replace the seat assembly, including the belts, if your vehicle has been involved in a serious accident, even if there's no obvious damage.
- Do not attempt to install, remove, modify, disassemble or dispose of the seat belts. Have any necessary repairs carried out by your Lexus dealer. Inappropriate handling of the pretensioner may prevent it from operating properly resulting in death or serious injury.

 **CAUTION**

■ **Using a seat belt comfort guide**

- Make sure the belt is not twisted and that it lies flat. The elastic cord must be behind the belt and the guide must be on the front.
- To reduce the chance of injury in case of an accident or a sudden stop while driving, remove and store the comfort guide in its pocket when it is not in use.
- Always make sure the shoulder belt is positioned across the center of the shoulder. The belt should be kept away from the neck, and should not fall off the shoulder.  
Failure to observe these precautions could reduce the effectiveness of the seat belt in an accident, causing death or serious injury.

■ **Using a seat belt extender**

- Do not wear the seat belt extender if you can fasten the seat belt without the extender.
- Do not use the seat belt extender when installing a child restraint system because the belt will not securely hold the child restraint system, increasing the risk of death or injury in the event of a collision.
- The personalized extender may not be safe on another vehicle, when used by another person, or at a different seating position other than the one originally intended.

 **NOTICE**

■ **When using a seat belt extender**

When releasing the seat belt, press on the buckle release button on the extender, not on the seat belt.  
This helps prevent damage to the vehicle interior and the extender itself.

## 1-4. Adjustable components (seats, mirrors, steering wheel)

### Steering wheel (manually adjustable type)

The steering wheel can be adjusted to a comfortable position.



**STEP 1** Hold the steering wheel and pull up the lever.

**STEP 2** Adjust to the ideal position by moving the steering wheel.

**STEP 3** Release the lever.

1

Before driving

#### CAUTION

##### ■ Caution while driving

Do not adjust the steering wheel while driving.

Doing so may cause the driver to mishandle the vehicle and an accident, resulting in death or serious injury.

##### ■ After adjusting the steering wheel

Make sure that the steering wheel is securely locked.

Otherwise, the steering wheel may move suddenly, possibly causing an accident.

## 1-4. Adjustable components (seats, mirrors, steering wheel)

### Steering wheel (power-adjustable type)

The steering wheel can be adjusted to a comfortable position.



- 1 Up
- 2 Down
- 3 Away from the driver
- 4 Toward the driver

#### Auto tilt away

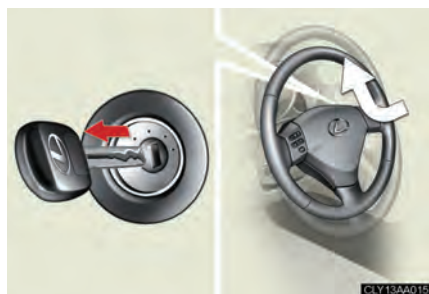

When the key is removed from the engine switch, the steering wheel returns to its stowed position by moving up and away to enable easier driver entry and exit.

Inserting the key into the engine switch returns the steering wheel to its original position.

#### ■ Customization that can be configured at Lexus dealer

Setting of the auto tilt-away function can be disabled. (Customizable features →P. 466)

#### ⚠ CAUTION

##### ■ Caution while driving

Do not adjust the steering wheel while driving.

Doing so may cause the driver to mishandle the vehicle and an accident, resulting in death or serious injury.

## 1-4. Adjustable components (seats, mirrors, steering wheel)

### Anti-glare inside rear view mirror

In automatic mode, sensors are used to detect the headlights of vehicles behind and automatically reduces the reflected light.



- 1 To turn automatic mode on/off, press and hold the switch for 3 seconds.

The indicator comes on when automatic mode is turned on.

The anti-glare mirror default mode is automatic mode. The anti-glare mirror is automatically set to automatic mode whenever the engine switch is in the ON position.

1

Before driving

#### ■ To prevent sensor error



To ensure that the sensors operate properly, do not touch or cover them.

#### ⚠ CAUTION

##### ■ Caution while driving

Do not adjust the position of the mirror while driving.

Doing so may lead to mishandling of the vehicle and an accident, resulting in death or serious injury.

## 1-4. Adjustable components (seats, mirrors, steering wheel)

### Outside rear view mirrors

Mirror angle can be adjusted using the switch when the engine switch is in the ACC or ON position.



- 1 Pull down the cover
- 2 Select a mirror to adjust (L: left or R: right)
- 3 Adjust the mirror up, down, in, or out using the switch

#### ■ When the mirrors are fogged up

Turn on the outside rear view mirror defoggers to defog the mirrors. (→P. 212)

#### ■ Folding back the mirrors



Push back in the direction of the vehicle's rear.

#### ■ One-touch adjustment of the mirror angle (vehicles with driving position memory)

A desired mirror face angle can be entered to memory and adjusted with the touch of a button. (→P. 55)

**■ Linked mirror function when reversing (vehicles with driving position memory)**

The outside rear view mirrors will automatically angle downwards when the vehicle is reversing in order to give a better view of the ground. However, this function will not operate when the mirror select switch is in the neutral position (between L and R).

**■ Auto anti-glare function**

When the anti-glare inside rear view mirror is set to automatic mode, the outside rear view mirrors will activate in conjunction with the anti-glare inside rear view mirror to reduce reflected light. (→P. 67)

**⚠ CAUTION****■ When driving the vehicle**

Observe the following precautions while driving.

Failing to do so may result in loss of control of the vehicle and cause an accident, resulting in death or serious injury.

- Do not adjust the mirrors while driving.
- Do not drive with the mirrors folded back.
- Both the driver and passenger side mirrors must be extended and properly adjusted before driving.

**■ When the mirror defoggers are operating**

Do not touch the surface of the mirror, as it may be hot.

## 1-4. Adjustable components (seats, mirrors, steering wheel)

### Roof luggage carrier (if equipped)

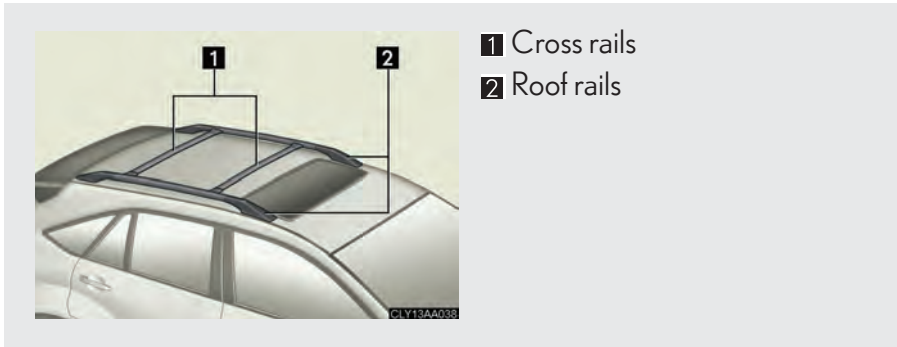

#### Adjusting the position of cross rails

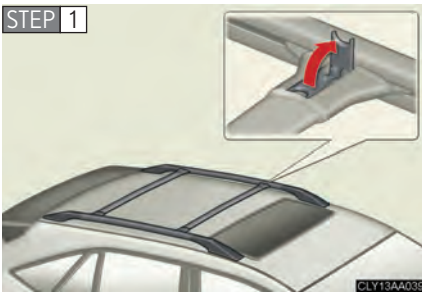

Pull the lock release lever up to release the cross rails.

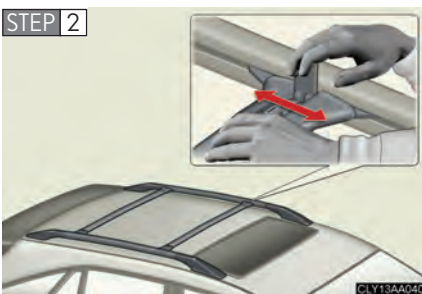

Slide the cross rails to the appropriate position for loading luggage and release the lever.

 **CAUTION****■ Cross rail adjustment**

Make sure the cross rails are locked securely by pushing forward and rearward them.

Failure to do so may cause an unexpected accident or severe injury in the event of emergency braking or a collision.

**■ When loading cargo**

Observe the following precautions.

- Place the cargo so that its weight is distributed evenly between the front and rear axles.
- If loading long or wide cargo, never exceed the vehicle overall length or width. (→P. 438)
- Before driving, make sure the cargo is securely fastened on the roof luggage carrier.
- Loading cargo on the roof luggage carrier will make the center of the vehicle gravity higher. Avoid high speeds, sudden starts, sharp turns, sudden braking or abrupt maneuvers, otherwise it may result in loss of control or vehicle rollover due to failure to operate this vehicle correctly.
- If driving for a long distance, on rough roads, or at high speeds, stop the vehicle now and then during the trip to make sure the cargo remains in its place.
- Do not exceed 165 lb. (75 kg) cargo weight on the roof luggage carrier.

 **NOTICE****■ When loading the luggage**

Be careful not to scratch the surface of the moon roof.

## 1-5. Opening and closing the windows and moon roof

### Power windows

The power windows can be opened and closed using the following switches.

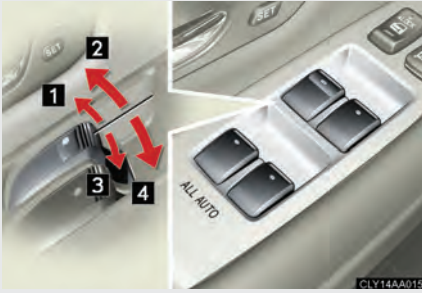

- 1 Closing
- 2 One-touch closing\*
- 3 Opening
- 4 One-touch opening\*

\*: Pushing the switch in the opposite direction will stop window travel partway.

### Lock switch



Press the switch down to lock passenger window switches.

Use this switch to prevent children from accidentally opening or closing a passenger window.

**■ The power windows can be operated when**

The engine switch must be in the ON position.

**■ Door lock linked window operation**

- The power windows can be opened and closed using the key. (→P. 39)
- The power windows can be opened using the wireless remote control. (→P. 36)

**■ Retained accessory power**

The power windows can be operated for approximately 45 seconds even after the engine switch is turned to the ACC or LOCK position. They cannot, however, be operated once either front door is opened.

**■ Jam protection function**

If an object becomes caught between the window and the window frame, window travel is stopped and the window is opened slightly.

**■ If the power window does not work correctly**

The power windows must be initialized in order to ensure proper operation. (Perform for each window with the switch for each seat.)

**STEP 1** Open the window halfway.

**STEP 2** Fully close the window by pulling the switch up and continue holding the switch for one second.

The indicator on the switch changes from a flashing pattern to being on when initial settings are complete.

**■ Customization that can be configured at Lexus dealer**

Settings (e.g. linked door lock operation) can be changed. (Customizable features →P. 466)

### CAUTION

#### ■ Closing the windows

Observe the following precautions.

Failing to do so may result in death or serious injury.

- Check to make sure that all passengers do not have any part of their body in a position where it could be caught when a window is being operated.
- Do not allow children to operate the power windows.  
Closing a power window on someone can cause serious injury, and in some instances, even death.

#### ■ Jam protection function

- Never try jamming any part of your body to activate the jam protection function intentionally.
- The jam protection function may not work if something gets caught just before the window fully closes.

## 1-5. Opening and closing the windows and moon roof

### Moon roof (if equipped)

Use the overhead switches to open, close and tilt the moon roof up and down.

#### ■ Opening and closing

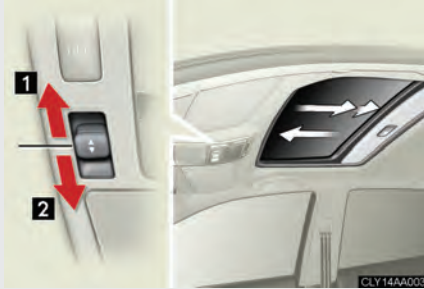

#### 1 Open

The moon roof stops slightly before the fully opened position.

Push the switch again to fully open.

#### 2 Close

Push the switch in the either direction to stop the moon roof partway.

#### ■ Tilting up and down

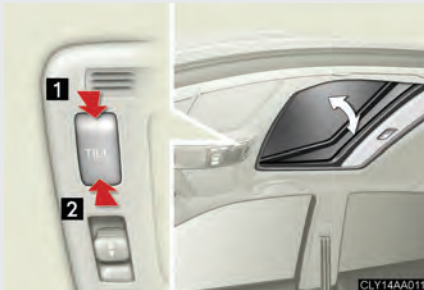

#### 1 Tilt up

#### 2 Tilt down

Push the switch in the either side to stop the moon roof partway.

### ■ The moon roof can be operated when

The engine switch must be in the ON position.

### ■ Door lock linked moon roof operation

- The moon roof can be opened and closed using the key. (→P. 39)
- The moon roof can be opened using the wireless remote control. (→P. 36)

### ■ Operating the moon roof after turning the engine switch to the ACC or LOCK position

The moon roof can be operated for approximately 45 seconds even after the engine switch is turned to the ACC or LOCK position. It cannot, however, be operated once either front door is opened.

### ■ Jam protection function

If an object is detected between the moon roof and the frame while closing or tilting down, travel is stopped and the moon roof opens slightly.

### ■ To reduce moon roof wind noise

Drive with the moon roof where it has stopped when opening automatically.

### ■ Sunshade

The sunshade can be opened and closed manually. However, the sunshade will open automatically when the moon roof is opened.

### ■ Customization that can be configured at Lexus dealer

Settings (e.g. linked door lock operation) can be changed. (Customizable features →P. 466)

 **CAUTION****■ Opening the moon roof**

Observe the following precautions.

Failing to do so may cause death or serious injury.

- Do not allow any passengers to put their hands or heads outside the vehicle while it is moving.
- Do not sit on top of the moon roof.

**■ Closing the moon roof**

Observe the following precautions.

Failing to do so may result in death or serious injury.

- Check to make sure that all passengers do not have any part of their bodies in a position where they could be caught when the moon roof is being operated.
- Do not allow children to operate the moon roof.  
Closing the moon roof on someone can cause death or serious injury.

**■ Jam protection function**

- Never try jamming any part of your body to activate the jam protection function intentionally.
- The jam protection function may not work if something gets caught just before the moon roof fully closes.

## 1-6. Refueling

### Opening the fuel tank cap

Perform the following steps to open the fuel tank cap.

#### ■ Before refueling the vehicle

Stop the hybrid system and ensure that all the doors and windows are closed.

#### ■ Opening the fuel tank cap

STEP 1

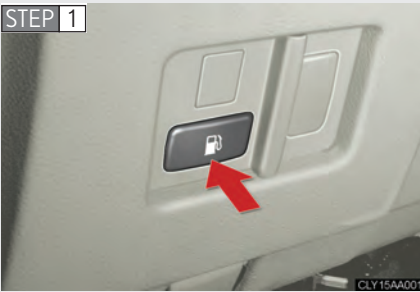

Push the fuel filler door opener switch.

STEP 2



When the message REFUEL READY appears, the fuel filler door will open.



If the pressure in the fuel tank is high, the message PLEASE WAIT NOW OPENING will appear on the multi-information display. It may take up to 10 seconds.

## STEP 3



Turn the fuel tank cap slowly to open.

## STEP 4



Hang the fuel tank cap on the back of the fuel filler door.

## Closing the fuel tank cap

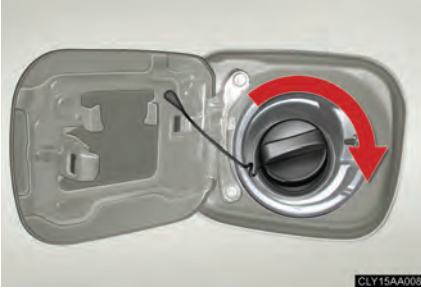

When replacing the fuel tank cap, turn it until one clicking sound is heard.

After releasing your hand, the cap will turn slightly to the opposite direction.

### ■ Fuel types

Use unleaded gasoline. (91 Octane rating [Research Octane Number 96] or higher)

### ■ Fuel tank capacity

Approximately 17.2 gal. (65 L, 14.3 Imp. gal.)

### ■ Open fuel filler door warning

→P. 415

### ■ When the fuel filler door opener is inoperable

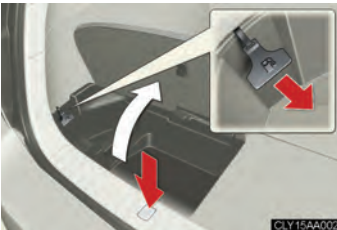

The handle can be used to open the fuel filler door if the fuel filler door cannot be opened using the inside switch because the battery is discharged or for any other reason.

 **CAUTION****■ Refueling the vehicle**

Observe the following precautions while refueling the vehicle. Failure to do so, may result in death or serious injury.

- Touch the vehicle or some other metal surface to discharge any static electricity. Sparks resulting from discharging static electricity may cause the fuel vapors to ignite.
- Always hold the grips on the fuel tank cap and turn it slowly to remove it. A whooshing sound may be heard when the fuel tank cap is loosened. Wait until the sound cannot be heard before fully removing the cap. In hot weather, pressurized fuel may spray out the filler neck and cause injury.
- Do not allow anyone that has not discharged static electricity from their bodies to come close to an open fuel tank.
- Do not inhale vaporized fuel. Fuel contains substances that are harmful if inhaled.
- Do not smoke while refueling the vehicle. Doing so may cause the fuel to ignite and cause a fire.
- Do not return to the vehicle or touch any person or object that is statically charged. This may cause static electricity to build up, resulting in a possible ignition hazard.

**■ When replacing the fuel cap**

Do not use anything but a genuine Lexus fuel tank cap designed for your vehicle. Doing so may cause a fire or other incident which may result in death or serious injury.

**■ When opening the fuel cap**

Do not remove the cap quickly. In hot weather, fuel under pressure could cause injury by spraying out of the filler neck if the cap is suddenly removed.

### NOTICE

#### ■ Refueling the vehicle

- Finish refueling within 30 minutes. If more than 30 minutes passes, the internal valve closes. In this condition, fuel may spill out if you continue to refuel the vehicle. About 5 minutes after the valve is closed, a message CLOSE FUEL LID will appear on the multi-information display. To refuel the vehicle again, tighten the fuel tank cap and close the fuel filler door, and then push the fuel filler door opener switch again.
- Do not spill fuel during refueling.  
Doing so may damage the vehicle, such as causing the exhaust systems to operate abnormally or damaging fuel system components or the vehicle's painted surface.

## 1-7. Theft deterrent system

# Hybrid vehicle immobilizer system

The vehicle's keys have built-in transponder chips that prevent the hybrid system from starting if the key has not been previously registered in the vehicle's on-board computer.

Never leave the keys inside the vehicle when you leave the vehicle.



The indicator light flashes after the key has been removed from the engine switch to indicate that the system is operating.

1

Before driving

### ■ System maintenance

The vehicle has a maintenance-free type of immobilizer system.

### ■ Conditions that may cause the system to malfunction

- If the grip portion of the key is in contact with a metallic object
- If the key is in close proximity to or touching a key to the security system (key with a built-in transponder chip) of another vehicle

### ■ Certifications for the hybrid vehicle immobilizer system

- ▶ For vehicles sold in the U.S.A.

FCC ID: MOZRI-20BTY (Made in Japan)

This device complies with Part 15 of the FCC Rules. Operation is subject to the following two conditions: (1) this device may not cause harmful interference, and (2) this device must accept any interference received, including interference that may cause undesired operation.

- ▶ For vehicles sold in Canada

This device complied with RSS-210 of Industry Canada.

Operation is subject to the following two conditions: (1) this device may not cause interference, and (2) this device must accept any interference, including interference that may cause undesired operation of the device.

### CAUTION

Changes or modifications not expressly approved by the party responsible for compliance could void the user's authority to operate the equipment.

### NOTICE

#### ■ To prevent damage to the key

Do not modify, remove or disable the hybrid vehicle immobilizer system. If any unauthorized changes or modifications are made, the proper operation of the system cannot be guaranteed.

# Alarm

The system sounds the alarm and flashes lights when forcible entry is detected.

### ■ Triggered of the alarm

The alarm is triggered in the following situations.

- A locked door is unlocked or opened in any way other than using the key or wireless remote control with the alarm being set.
- The hood is opened with the alarm being set.

### ■ Setting the alarm system



Close the doors, hood, and lock all doors using the key or wireless remote door lock function. The system will be set automatically after 30 seconds.

The indicator light changes from being on to flashing when the system is set.

### ■ Deactivating or stopping the alarm

Do one of the following to deactivate or stop the alarm.

- Unlock the doors using the key or wireless remote control.
- Turn the engine switch to the ON position. (The alarm will be deactivated or stopped after a few seconds.)

### ■ Items to check before locking the vehicle

To prevent unexpected triggering of the alarm and vehicle theft, make sure of the following.

- Nobody is in the vehicle.
- The windows and moon roof are closed before the alarm is set.
- No valuables or other personal items are left in the vehicle.

### ■ Triggering of the alarm

The alarm may be triggered in the following situations.

Stopping the alarm deactivates the alarm system.

- The doors is unlocked using the key.
- A person inside the vehicle opens a door or hood.
- The battery is recharged or replaced when the vehicle is locked.

### ■ Panic mode

- ▶ Vehicles with power back door



When PANIC is pushed for longer than about one second, an alarm will sound for about 30 seconds and the vehicle lights will flash to deter any person from trying to break into or damage your vehicle.

To stop the alarm, push any button on the wireless remote control.

- ▶ Vehicles without power back door



**■ When the 12-volt battery is disconnected**

Be sure to cancel the alarm system.

If the battery is discharged before canceling the alarm, the system may be triggered when the battery is reconnected.

**■ When using the key to unlock the doors**

Deactivate the alarm.

If the doors are unlocked using the key with the alarm operational, the alarm will be triggered.

## 1-7. Theft deterrent system

### Theft prevention labels (U.S.A.)



These labels are attached to the vehicle to reduce vehicle theft by facilitating the tracing and recovery of parts from stolen vehicles. Do not remove under penalty of law.

## Correct driving posture

Drive in a good posture as follows:



- 1 Sit upright and well back in the seat. (→P. 49)
- 2 Adjust the position of the seat forward or backward to ensure the pedals can be reached and easily depressed to the extent required. (→P. 49)
- 3 Adjust the seatback so that the controls are easily operable.
- 4 Adjust the tilt and telescopic positions of the steering wheel downward so the airbag is facing your chest. (→P. 65, 66)
- 5 Lock the head restraint in place with the center of the head restraint closest to the top of your ears. (→P. 57)
- 6 Wear the seat belt correctly. (→P. 58)

 **CAUTION**

■ **While driving**

- Do not adjust the position of the driver's seat while driving.  
Doing so could cause the driver to lose control of the vehicle.
- Do not place a cushion between the driver or passenger and the seatback.  
A cushion may prevent correct posture from being achieved, and reduce the effectiveness of the seat belt and head restraint, increasing the risk of death or serious injury to the driver or passenger.
- Do not place anything under the front seats.  
Objects placed under the front seats may become jammed in the seat tracks and stop the seat from locking in place. This may lead to an accident. The adjustment mechanism may also be damaged.

■ **Adjusting the seat position:**

- Take care when adjusting the seat position to ensure that other passengers are not injured by the moving seat.
- Do not put your hands under the seat or near the moving parts to avoid injury.  
Fingers or hands may become jammed in the seat mechanism.

## 1-8. Safety information

# SRS airbags

The SRS airbags inflate when the vehicle is subjected to certain types of severe impacts that may cause significant injury to the occupants. They work together with the seat belts to help reduce the risk of death or serious injury.

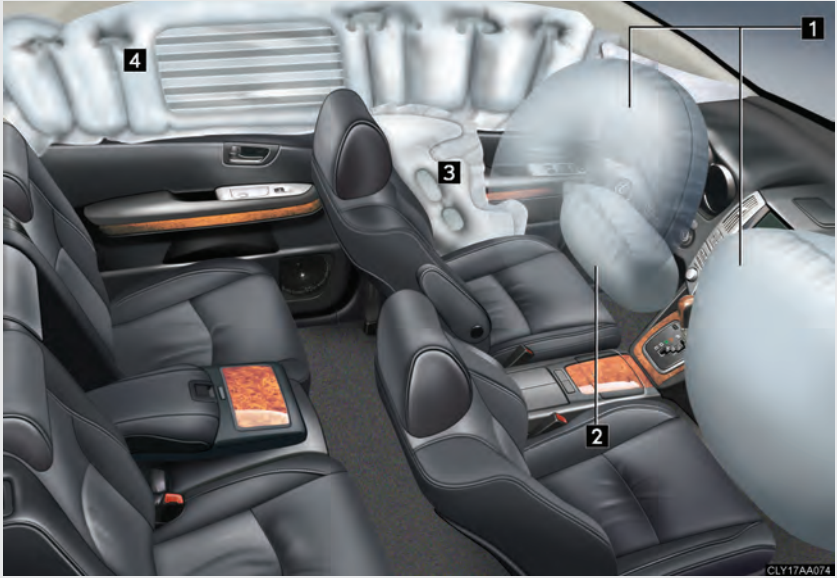

### ► Front airbags

#### 1 Driver airbag/front passenger airbag

Can help protect the head and chest of the driver and front passenger from impact with interior components.

#### 2 Driver knee airbag

Can help provide driver protection.

### ► Side and curtain shield airbags

#### 3 Side airbags

Can help protect the torso of the front seat occupants.

#### 4 Curtain shield airbags

Can help protect primarily the head of outside occupants.

1

Before driving

## Airbag system components

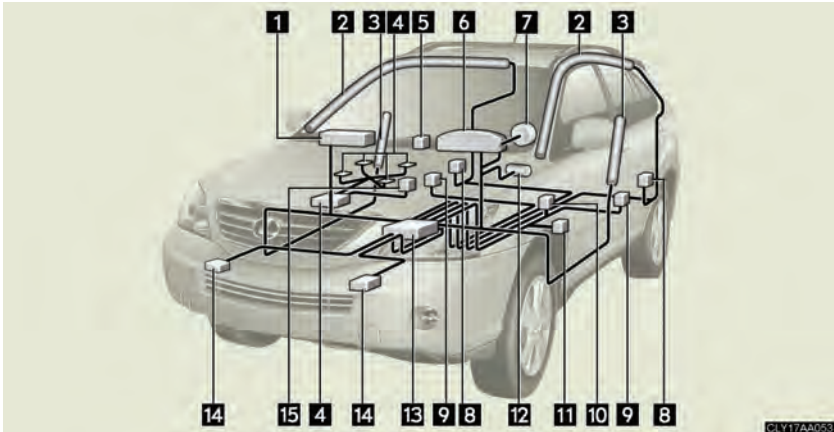

- |  |   |
|--|---|
| <b>1</b> Front passenger airbag                      | <b>9</b> Side and curtain shield airbag sensors     |
| <b>2</b> Curtain shield airbags                      | <b>10</b> Driver's seat belt buckle switch          |
| <b>3</b> Side airbags                                | <b>11</b> Driver's seat position sensor             |
| <b>4</b> Occupant detection system (ECU and sensors) | <b>12</b> Driver knee airbag                        |
| <b>5</b> AIR BAG ON and AIR BAG OFF indicator lights | <b>13</b> Airbag sensor assembly                    |
| <b>6</b> SRS warning light                           | <b>14</b> Front airbag sensors                      |
| <b>7</b> Driver airbag                               | <b>15</b> Front passenger's seat belt buckle switch |
| <b>8</b> Curtain shield airbag sensors               |   |

Your vehicle is equipped with ADVANCED AIRBAGS designed based on US motor vehicle safety standards (FMVSS208). The airbag system controls airbag deployment power for the driver and front passenger. The driver airbag system consists of the driver seat's position sensor etc. The front passenger's airbag system consists of the front passenger occupant classification sensor etc.

The main SRS airbag system components are shown above. The SRS airbag system is controlled by the airbag sensor assembly. The airbag sensor assembly consists of a safing sensor and an airbag sensor.

In certain types of severe frontal or side impacts, the SRS airbag system triggers the airbag inflators. A chemical reaction in the inflators quickly fills the airbags with non-toxic gas to help restrain the motion of the occupants.

### ■ SRS warning light

This warning light system monitors the airbag sensor assembly, front airbag sensors, side and curtain shield airbag sensor assemblies, curtain shield airbag sensor assemblies, driver's seat position sensor, driver's seat belt buckle switch, front passenger occupant classification system, AIR BAG ON indicator light, AIR BAG OFF indicator light, front passenger's seat belt buckle switch, front seat belt pretensioner assemblies, inflators, interconnecting wiring and power sources. (→P. 397)

### ■ If the SRS airbags deploy (inflate)

- Bruising and slight abrasions may result from contact with a deploying (inflating) SRS airbag.
- A loud noise and white powder will be emitted.
- Parts of the airbag module (steering wheel hub, airbag cover and inflator) as well as the front seats, and parts of the front pillar and roof side rail, may be hot for several minutes. The airbag itself may also be hot.
- The front windshield may crack.

### ■ Operating conditions (front airbags)

- The SRS front airbags will deploy if the severity of the frontal impact is above the designed threshold level, comparable to an approximate 15 mph (25 km/h) collision when the vehicle impacts straight into a fixed barrier that does not move or deform.

However, this threshold velocity will be considerably higher if the vehicle strikes an object, such as a parked vehicle or sign pole, which can move or deform on impact, or if the vehicle is involved in an underride collision (e.g. a collision in which the front of the vehicle "underrides", or goes under, the bed of a truck, etc.).

- It is possible that in some collisions where the forward deceleration of the vehicle is very close to the designed threshold level, the SRS front airbags and the seat belt pretensioners may not activate together.

- The SRS front passenger airbag will not activate if there is no passenger sitting in the front passenger seat. However, the front passenger airbag may deploy if luggage is put in the seat, or the seat belt is fastened, even if the seat is unoccupied. (→P.103)

### ■ Operating conditions (side airbags)

- The SRS side airbags are designed to inflate when the passenger compartment is subjected to a severe impact from the side.
- The SRS side airbag on the passenger seat will not activate if there is no passenger sitting in the front passenger seat. However, the side airbag on the passenger seat may deploy if luggage is put in the seat, or the seat belt is fastened, even if the seat is unoccupied. (→P.103)

### ■ Operating conditions (curtain shield airbags)

The SRS curtain shield airbags are designed to inflate when the passenger compartment is subjected to a severe impact from the side or vehicle rollover.

### ■ Conditions under which the SRS airbags may deploy (inflate), other than a collision

The SRS front airbags may also deploy if a serious impact occurs to the underside of your vehicle. Some examples are shown in the illustration.

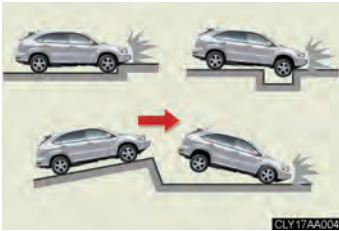

- Hitting a curb, edge of pavement or hard surface
- Falling into or jumping over a deep hole
- Landing hard or vehicle falling

The SRS curtain shield airbags may also deploy under the situations shown in the illustration.



- The angle of vehicle tip-up is marginal.
- The vehicle skids and hits a curb stone.

### ■ Types of collisions that may not deploy the SRS airbag (front airbags)

The SRS front airbags are generally not designed to inflate if the vehicle is involved in a side or rear collision, if it rolls over, or if it is involved in a low-speed frontal collision. But, whenever a collision of any type causes sufficient forward deceleration of the vehicle, deployment of the SRS front airbags may occur.



- Collision from the side
- Collision from the rear
- Vehicle rollover

### ■ Types of collisions that may not deploy the SRS airbag (side and curtain shield airbags)

The SRS side airbag and curtain shield airbag system may not activate if the vehicle is subjected to a collision from the side at certain angles, or a collision to the side of the vehicle body other than the passenger compartment.



- Collision from the side to the vehicle body other than the passenger compartment
- Collision from the side at an angle

## 1-8. Safety information

The SRS side airbags are not generally designed to inflate if the vehicle is involved in a frontal or rear collision, if it rolls over, or if it is involved in a low-speed side collision.



- Collision from the front
- Collision from the rear
- Vehicle rollover

The SRS curtain shield airbags are not generally designed to inflate if the vehicle is involved in a frontal or rear collision, if it pitches end over end, or if it is involved in a low-speed side collision.

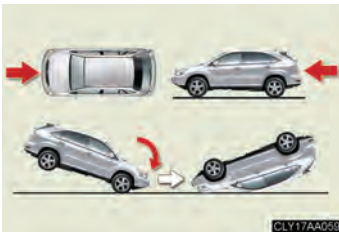

- Collision from the front
- Collision from the rear
- Pitching end over end

## ■ When to contact your Lexus dealer

In the following cases, contact your Lexus dealer as soon as possible. Do not disconnect the battery cables before contacting your Lexus dealer.

- Any of the SRS airbags have been inflated.

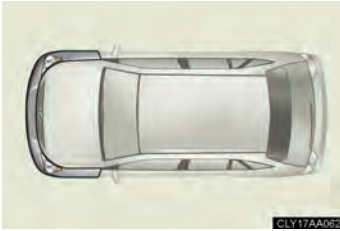

CLY17AA062

- The front of the vehicle is damaged or deformed, or was involved in an accident that was not severe enough to cause the SRS airbags to inflate.

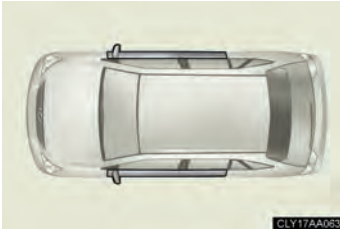

CLY17AA063

- A portion of the doors is damaged or deformed, or the vehicle was involved in an accident that was not severe enough to cause the SRS side airbags and curtain shield airbags to inflate.



CLY17AA064

- The pad section of the steering wheel, front passenger airbag cover or lower portion of the instrument panel is scratched, cracked, or otherwise damaged.



CLY17AA065

- The surface of the seats with the side airbag is scratched, cracked, or otherwise damaged.
- The portion of the front pillars, rear pillars or roof side rail garnishes (padding) containing the curtain shield airbags inside is scratched, cracked, or otherwise damaged.

 **CAUTION**

■ **SRS airbag precautions**

Observe the following precautions regarding the airbags.  
Failure to do so may cause death or serious injury.

- The driver and all passengers in the vehicle must wear their seat belts properly. The SRS airbags are supplemental devices to be used with the seat belts.
- The SRS driver airbag deploys with considerable force, and can cause death or serious injury especially if the driver is very close to the airbag. The National Highway Traffic Safety Administration (“NHTSA”) advises:

Since the risk zone for driver airbag is the first 2 - 3 in. (50 - 75 mm) of inflation, placing yourself 10 in. (250 mm) from your driver airbag provides you with a clear margin of safety. This distance is measured from the center of the steering wheel to your breastbone. If you sit less than 10 in. (250 mm) away now, you can change your driving position in several ways:

- Move your seat to the rear as far as you can while still reaching the pedals comfortably.
- Slightly recline the back of the seat.  
Although vehicle designs vary, many drivers can achieve the 10 in. (250 mm) distance, even with the driver seat all the way forward, simply by reclining the back of the seat somewhat. If reclining the back of your seat makes it hard to see the road, raise yourself by using a firm, non-slippery cushion, or raise the seat if your vehicle has that feature.
- If your steering wheel is adjustable, tilt it downward. This points the airbag toward your chest instead of your head and neck.

The seat should be adjusted as recommended by NHTSA above, while still maintaining control of the foot pedals, steering wheel, and your view of the instrument panel controls.

**CAUTION****SRS airbag precautions**

- If the seat belt extender has been connected to the driver's seat belt buckle but the seat belt extender has not also been fastened to the latch plate of the driver's seat belt, the SRS driver's airbag system will judge that the driver is wearing the seat belt even though the seat belt has not been connected. In this case, the driver's airbag may not activate correctly in a collision, resulting in death or serious injury in the event of collision. Be sure to wear the seat belt with the seat belt extender.
- The SRS front passenger airbag also deploys with considerable force, and can cause death or serious injury especially if the front passenger is very close to the airbag. The front passenger seat should be as far from the airbag as possible with the seatback adjusted, so the front passenger sits upright.
- Improperly seated and/or restrained infants and children can be killed or seriously injured by a deploying airbag. An infant or child who is too small to use a seat belt should be properly secured using a child restraint system. Lexus strongly recommends that all infants and children be placed in the rear seats of the vehicle and properly restrained. The rear seats are the safest for infants and children. (→P.108)

**CAUTION**

**SRS airbag precautions**



● Do not sit on the edge of the seat or lean against the dashboard.

● Do not allow a child to sit on the knees of a front passenger while the vehicle is moving.

● Do not drive the vehicle while the driver or passenger have items resting on their knees.

● Do not lean against the door, the roof side rail or the front, side and rear pillars.

● Do not allow anyone to kneel on the passenger seat toward the door or put their head or hands outside the vehicle.

## CAUTION

### ■ SRS airbag precautions

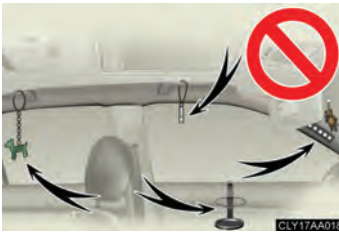

- If the vinyl cover is put on the area where the SRS knee airbag will deploy, be sure to remove it.
- Do not use seat accessories which cover the parts where the SRS side airbags inflate as they may interfere with inflation of the airbags.
- Do not strike or apply significant levels of force to the area of the SRS airbag components shown on P. 92.  
Doing so can cause the SRS airbags to malfunction.
- Do not touch any of the component parts immediately after the SRS airbags have deployed (inflated) as they may be hot.

- Do not attach anything to or lean anything against areas such as the dashboard, steering wheel pad or lower portion of the instrument panel.

These items can become projectiles when SRS driver, front passenger and knee airbags deploy.

- Do not attach anything to areas such as the door, windshield glass, side door glass, front and rear pillars, roof side rail or assist grip.

- Do not hang coat hangers or other hard objects on the coat hooks. All of these items could become projectiles and seriously injure or kill you, should the SRS curtain shield airbag deploy.

- Do not attach any heavy, sharp or hard objects such as other keys or accessories to the keychain. The objects may restrict the SRS knee airbag inflation or be thrust into the driver's seat area by the force of the deploying airbag, thus causing a danger.

### CAUTION

#### ■ SRS airbag precautions

- If breathing becomes difficult after the SRS airbag has deployed, open a door or window to allow fresh air in, or leave the vehicle if it is safe to do so. Wash off any residue as soon as possible to prevent skin irritation.
- If the areas where the SRS airbags are stored, such as the steering wheel pad and front pillar garnish, are damaged or cracked, have them replaced by your Lexus dealer.
- Do not place anything, such as a cushion, on the front passenger's seat. Doing so will disperse the passenger's weight, which prevents the sensor from detecting the passenger's weight properly. As a result, the SRS front passenger airbag may not deploy in the event of a collision.

#### ■ Modification and disposal of SRS airbag system components

Do not dispose of your vehicle or perform any of the following modifications without consulting your Lexus dealer.

The SRS airbag may malfunction or deploy (inflate) accidentally, causing death or serious injury.

- Installation, removal, disassembly and repair of the SRS airbags
- Repairs, modifications, removal or replacement of the steering wheel, instrument panel, dashboard, seats or seat upholstery, front, side and rear pillars or roof side rails
- Repairs or modifications of the front fender, front bumper, or side of the occupant compartment
- Installation of snow plows, winches, etc. to the front grille (bull bars, kangaroo bar etc.)
- Modifications to the vehicle's suspension system
- Installation of electronic devices such as mobile two-way radios or CD players
- Modifications to your vehicle for a person with a physical disability.

## 1-8. Safety information

# Front passenger occupant classification system

Your vehicle is equipped with a front passenger occupant classification system. This system detects the conditions of the front passenger seat and activates or deactivates the devices for front passenger.

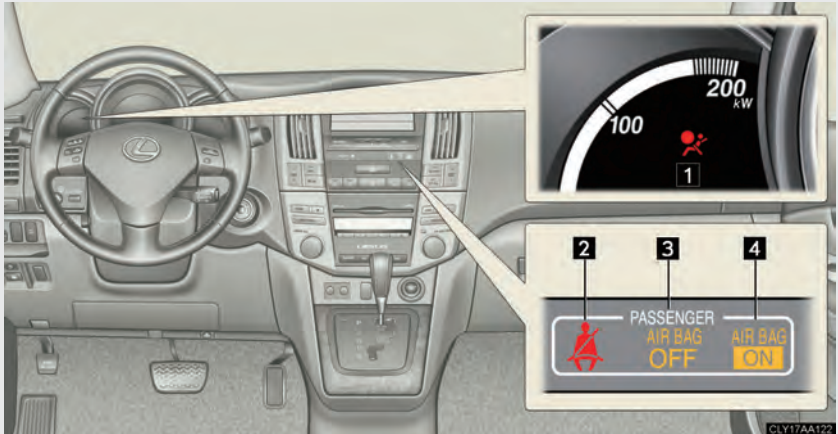

- 1 SRS warning light
- 2 Front passenger's seat belt reminder light
- 3 AIR BAG OFF indicator light
- 4 AIR BAG ON indicator light

1

Before driving

## Condition and operation in the front passenger occupant classification system

### ■ Adult\*<sup>1</sup>

|                             |  |                        |
|-----------------------------|--|------------------------|
| Indicator/<br>warning light | AIR BAG ON and AIR BAG OFF<br>indicator lights       | AIR BAG ON             |
|                             | SRS warning light                                    | Off                    |
|                             | Front passenger's seat belt reminder light           | Flashing* <sup>2</sup> |
| Devices                     | Front passenger airbag                               | Activated              |
|                             | Side airbag on the front passenger seat              |                        |
|                             | Curtain shield airbag<br>in the front passenger side |                        |
|                             | Front passenger's seat belt pretensioner             |                        |

### ■ Child<sup>\*3</sup> or child restraint system<sup>\*4</sup>

|                             |  |                              |
|-----------------------------|--|------------------------------|
| Indicator/<br>warning light | AIR BAG ON and AIR BAG OFF<br>indicator lights       | AIR BAG<br>OFF <sup>*5</sup> |
|                             | SRS warning light                                    | Off                          |
|                             | Front passenger's seat belt reminder light           | Flashing <sup>*2</sup>       |
| Devices                     | Front passenger airbag                               | Deactivated                  |
|                             | Side airbag on the front passenger seat              |                              |
|                             | Curtain shield airbag<br>in the front passenger side | Activated                    |
|                             | Front passenger's seat belt pretensioner             |                              |

### ■ Unoccupied

|                             |  |                      |
|-----------------------------|--|----------------------|
| Indicator/<br>warning light | AIR BAG ON and AIR BAG OFF<br>indicator lights       | Not illumi-<br>nated |
|                             | SRS warning light                                    | Off                  |
|                             | Front passenger's seat belt reminder light           |                      |
| Devices                     | Front passenger airbag                               | Deactivated          |
|                             | Side airbag on the front passenger seat              |                      |
|                             | Curtain shield airbag<br>in the front passenger side | Activated            |
|                             | Front passenger's seat belt pretensioner             | Deactivated          |

### ■ There is a malfunction in the system

|                             |  |             |
|-----------------------------|--|-------------|
| Indicator/<br>warning light | AIR BAG ON and AIR BAG OFF<br>indicator lights       | AIR BAG OFF |
|                             | SRS warning light                                    | On          |
|                             | Front passenger's seat belt reminder light           | Off         |
| Devices                     | Front passenger airbag                               | Deactivated |
|                             | Side airbag on the front passenger seat              |             |
|                             | Curtain shield airbag<br>in the front passenger side | Activated   |
|                             | Front passenger's seat belt pretensioner             |             |

1

Before driving

- \*1: The system judges a person of adult size as an adult. When a smaller adult sits in the front passenger seat, the system may recognize him/her as a child depending on his/her physique and posture.
- \*2: In the event the front passenger does not wear a seat belt.
- \*3: When a larger child who has outgrown a child restraint system sits in the front passenger seat, the system may recognize him/her as an adult depending on his/her physique or posture.
- \*4: Never install a rear-facing child restraint system on the front passenger seat. A forward-facing child restraint system should only be installed on the front passenger seat when it is unavoidable. (→P.108)
- \*5: In case the indicator is not illuminated, consult this manual as for installing the child restraint system properly. (→P.111)

### CAUTION

#### ■ Front passenger occupant classification system precautions

Observe the following precautions regarding front passenger occupant classification system.

Failure to do so may cause death or serious injury.

- Wear the seat belt properly.
- Make sure the front passenger's seat belt plate has not been left inserted into the buckle before someone sits in the front passenger seat.
- Make sure the AIR BAG OFF indicator light is not illuminated when using the seat belt extender for the front passenger seat. If the AIR BAG OFF indicator light is illuminated, disconnect the extender tongue from the seat belt buckle, then reconnect the seat belt. Reconnect the seat belt extender after making sure the AIR BAG ON indicator light is illuminated. If you use the seat belt extender while the AIR BAG OFF indicator light is illuminated, the front passenger airbag and side airbag on the front passenger side may not activate correctly, which could cause death or serious injury in the event of collision.
- Do not apply a heavy load to the front passenger seat or equipment (e.g. seat-back pocket or armrest).
- Do not put weight on the front passenger seat by putting your hands or feet on the front passenger seat seatback from the rear passenger seat.
- Do not let a rear passenger lift the front passenger seat with their feet or press on the seatback with their legs.
- Do not put objects under the front passenger seat.
- Do not recline the front passenger seatback so far that it touches a rear seat. This may cause the AIR BAG OFF indicator light to be illuminated, which indicates that the passenger's airbags will not deploy in the event of a severe accident. If the seatback touches the rear seat, return the seatback to a position where it does not touch the rear seat. Keep the front passenger seatback as upright as possible when the vehicle is moving. Reclining the seatback excessively may lessen the effectiveness of the seat belt system.

 **CAUTION****■ Front passenger occupant classification system precautions**

- If an adult sits in the front passenger seat, the AIR BAG ON indicator light is illuminated. If the AIR BAG OFF indicator is illuminated, ask the passenger to sit up straight, well back in the seat, feet on the floor, and with the seat belt worn correctly. If the AIR BAG OFF indicator still remain illuminated, either ask the passenger to move to the rear seat, or if that is not possible, move the front passenger seat fully rearward.
- When it is unavoidable to install the forward-facing child restraint system on the front passenger seat, install the child restraint system on the front passenger seat in the proper order. (→P. 111)
- Do not modify or remove the seat.
- Do not kick the front passenger seat or subject it to severe impact. Otherwise, the SRS warning light may come on to indicate a malfunction of the detection system. In this case, contact your Lexus dealer immediately.
- Child restraint systems installed on the rear seat should not contact the front seatbacks.

## 1-8. Safety information

# Child restraint systems

A child restraint system for a small child or baby must itself be properly restrained on the seat with the lap portion of the lap/shoulder belt.

The laws of all 50 states of the U.S.A. and Canada now require the use of child restraint systems.

### Points to remember

Studies have shown that installing a child restraint on a rear seat is much safer than installing one to the front passenger seat.

- Choose a child restraint system appropriate to the age and size of the child.
- For installation details, follow the instructions provided with the child restraint system.  
General installation instructions are provided in this manual. (→P. 111)

### Types of child restraints

Child restraint systems are classified into the following 3 types according to the age and size of the child.



► Infant seat



▶ Convertible seat



▶ Booster seat

---

**■ When the child restraint system is not in use**

Leave the child restraint system properly secured on the seat. Do not store the restraint loosely on a passenger seat or in the luggage compartment.

**■ Selecting an appropriate child restraint system**

Get an appropriate child restraint system for the child. If a child is too large for a child restraint system, sit the child on a rear seat and use the vehicle's seat belt. (→P. 58)

### CAUTION

#### ■ Child restraint precautions

- For effective protection in automobile accidents and sudden stops, a child must be properly restrained, using a seat belt or child restraint system depending on the age and size of the child. Holding a child in your arms is not a substitute for a child restraint system. In an accident, the child can be crushed against the windshield, or between you and the vehicle's interior.
- Lexus strongly urges the use of a proper child restraint system that conforms to the size of the child, installed on the rear seat. According to accident statistics, the child is safer when properly restrained in the rear seat than in the front seat.
- Never install a rear-facing child restraint system on the front passenger seat even if AIR BAG OFF indicator light is illuminated. In the event of an accident, the force of the rapid inflation of the front passenger airbag can cause death or serious injury to the child if the rear-facing child restraint system is installed on the front passenger seat.
- A forward-facing child restraint system should allowed to be installed on the front passenger seat only when it is unavoidable. Always move the seat as far back as possible even if AIR BAG OFF indicator light is illuminated, because the front passenger airbag could inflate with considerable speed and force. Otherwise, the child may be killed or seriously injured.
- Do not use the seat belt extender when installing a child restraint system on the front or rear passenger seat. If installing a child restraint system with the seat belt extender connected to the seat belt, the seat belt will not securely hold the child restraint system, which could cause death or serious injury to the child or other passengers in the event of collision.
- Do not allow the child to lean his/her head or any part of his/her body against the door or the area of the seat, front pillar or roof side rail from which the side airbags or curtain shield airbags deploy even if the child is seated in the child restraint system. It is dangerous if the side airbags and curtain shield airbags inflate, and the impact could cause death or serious injury to the child.
- Make sure you have complied with all installation instructions provided by the child restraint manufacturer and that the system is properly secured. If it is not secured properly, it may cause death or serious injury to the child in the event of a sudden stop or accident.

## Installing child restraints

Follow the child restraint system manufacturer's instructions. Firmly secure child restraints to the rear seats using a seat belt or a child restraint lower anchorage. Attach the top strap when installing a child restraint.



**1** Seat belts equipped with a child restraint locking mechanism (ALR/ELR belts except driver's seat belt) (→P. 58)



**2** Child restraint lower anchorages

Lower anchorages are provided for the outside rear seats. (Buttons displaying the location of the anchorages are attached to the seats.)

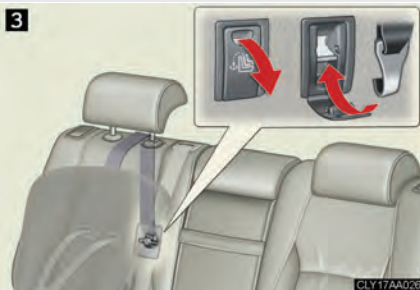

**3** Anchor bracket (for top strap)

Anchor brackets are provided for all rear seats.

## Installing child restraints using a seat belt (child restraint lock function belt)

### ■ Rear facing — Infant seat/convertible seat

STEP 1



Place the child restraint system on the rear seat facing the rear of the vehicle.

STEP 2

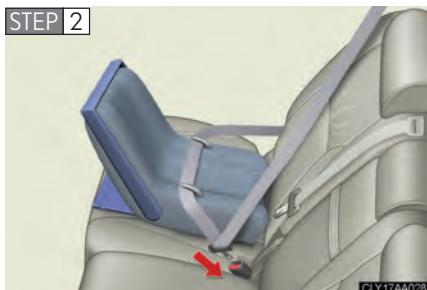

Run the seat belt through the child restraint system and insert the plate into the buckle. Make sure that the belt is not twisted.

STEP 3

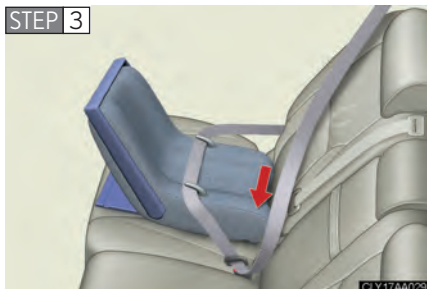

Fully extend the shoulder belt and then allow it to retract slightly in order to activate the ALR lock mode.

Lock mode allows the seat belt to retract only.

STEP 4

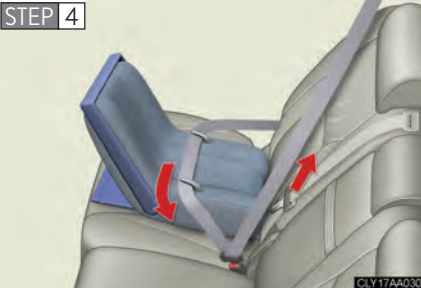

While pushing the child restraint system down into the rear seat, allow the shoulder belt to retract until the child restraint system is securely in place.

After the shoulder belt has retracted to a point where there is no slack in the belt, pull the belt to check that it cannot be extended.

### ■ Forward facing — Convertible seat

STEP 1



Place the child restraint system on the seat facing the front of the vehicle.

STEP 2



Run the seat belt through the child restraint system and insert the plate into the buckle. Make sure that the belt is not twisted.

STEP 3



Fully extend the shoulder belt and then allow it to retract slightly into the ALR lock mode.

Lock mode allows the seat belt to retract only.



While pushing the child restraint system into the rear seat, allow the shoulder belt to retract until the child restraint system is securely in place.

After the shoulder belt has retracted to a point where there is no slack in the belt, pull the belt to check that it cannot be extended.

### ■ Booster seat



Place the child restraint system on the seat facing the front of the vehicle.



Sit the child in the child restraint system. Fit the seat belt to the child restraint system according to the manufacturer's instructions and insert the plate into the buckle. Make sure that the belt is not twisted.

Check that the shoulder belt is correctly positioned over the child's shoulder, and that the lap belt is as low as possible. (→P. 58)

## Removing a child restraint installed with a seat belt



Push the buckle release button and fully retract the seat belt.

1

Before driving

## Installation with child restraint lower anchorages

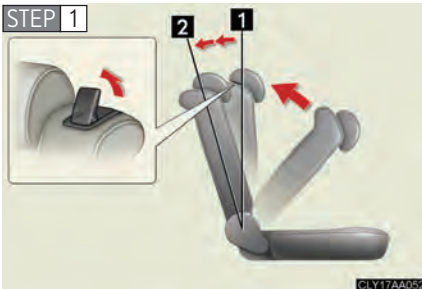

Fold the seatback forward and then back to the 1st lock position (most upright position) until it locks into place. Adjust the seatback to the 3rd lock position.

- 1 1st lock position
- 2 3rd lock position

STEP 2 Widen the gap between the seat cushion and seatback slightly.

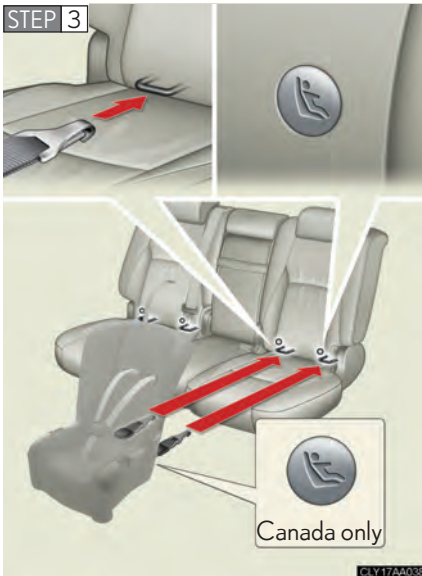

► Type A

Latch the hooks of lower straps onto the anchorages.

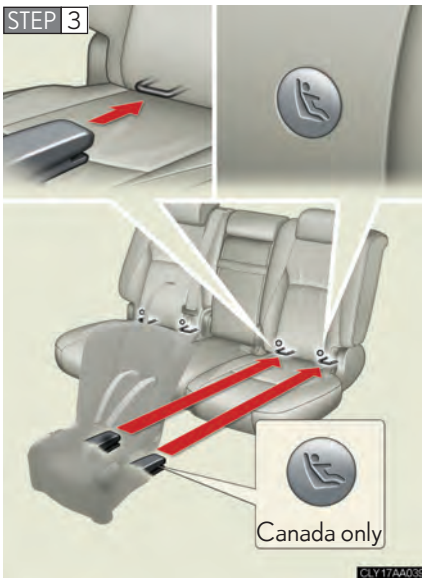

► Type B

Latch the buckles onto the anchorages.

If the child restraint has a top strap, the top strap should be latched onto the anchorages. (→P. 117)

For owners in Canada:

The symbol on a child restraint system indicates the presence of a lower connector system.

### Child restraint systems with a top strap

STEP 1



Secure the child restraint using a seat belt or a lower anchorage, and remove the head restraint.

STEP 2

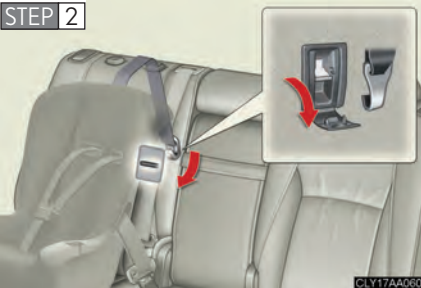

Open the anchor bracket cover, latch the hook onto the anchor bracket and tighten the top strap.

STEP 3



Replace the head restraint and lift it up to the uppermost lock position.

1

Before driving

### ■ Laws and regulations pertaining to anchorages

Anchorage conforming to FMVSS225 or CMVSS210.2.

Child restraint systems conforming to FMVSS213 or CMVSS213 specifications can be used.

This vehicle is designed to conform to the SAE J1819.

**⚠ CAUTION****■ When installing a booster seat**

Do not fully extend the shoulder belt to prevent the belt from going to ALR lock mode: (→P. 61)

- ALR mode causes the belt to tighten only which could cause injury or discomfort to the child.
- Do not allow the child to play with the seat belt or the child could be killed or seriously injured.

**■ When installing a child restraint system**

Follow the directions given in the child restraint system installation manual and fix the child restraint system securely in place.

If the child restraint system is not correctly fixed in place, the child may be injured or even killed in the event of sudden braking or an accident.



- If the driver's seat interferes with the child restraint system and prevents it from being attached correctly, attach the child restraint system to the right-hand rear seat.



- Only put a forward facing or booster child seat on the front seat when unavoidable. When installing a forward facing or booster seat on the front passenger seat, move the seat as far back as possible even if AIR BAG OFF indicator light is illuminated. Failing to do so may result in death or serious injury if the airbags deploy (inflate).

### CAUTION

#### ■ When installing a child restraint system

- When installing a child restraint system in the rear center position, adjust both seat cushions to the same position and align both seatbacks at the same angle. Otherwise, the child restraint system cannot be securely restrained and this may cause death or serious injuries in a collision.
- When using the lower anchorages for a child restraint system, ensure that the seat is moved to the rear-most position, with the seatback close to the child restraint system.
- When a booster seat is installed, always ensure that the shoulder belt is positioned across the center of the child's shoulder. The belt should be kept away from the child's neck, but not so that it could fall off the child's shoulder. Failing to do so may result in death or serious injury in the event of an accident or sudden braking.
- Ensure that the belt and tab are securely locked and the seat belt is not twisted.
- Push and pull the child seat in different directions to be sure it is secure.
- Follow all installation instructions provided by the child restraint system manufacturer.

#### ■ Do not use a seat belt extender

If a seat belt extender is used when installing a child restraint system, the seat belt will not securely hold the child restraint system, which could cause death or serious injury to the child or other passengers in the event of a collision.

#### ■ To correctly attach a child restraint system to the anchorages

When using the lower anchorages, be sure that there are no foreign objects around the anchorages and that the seat belt is not caught behind the child seat. Make sure the child restraint system is securely attached, or it may cause death or serious injury to the child in the event of a sudden stop or accident.

|   |            |   |            |
|---|------------|---|------------|
| <b>2-1. Driving procedures .....</b>                        | <b>122</b> | Rear window wiper and washer (type A) .....   | 162        |
| Driving the vehicle.....                                    | 122        | Rear window wiper and washer (type B) .....   | 163        |
| Engine (ignition) switch.....                               | 131        | Headlight cleaner switch .....                | 164        |
| Transmission.....   | 135        |   |            |
| Turn signal lever (type A) .....                            | 136        |   |            |
| Turn signal lever (type B).....                             | 137        |   |            |
| Parking brake .....   | 138        |   |            |
| <br>  |            |   |            |
| <b>2-2. Instrument cluster .....</b>                        | <b>139</b> | <b>2-4. Using other driving systems .....</b> | <b>165</b> |
| Gauges and meters .....                                     | 139        | Cruise control.....                           | 165        |
| Indicators and warning lights .....                         | 141        | Dynamic laser cruise control .....            | 168        |
| Multi-information display .....                             | 144        | Driving assist systems .....                  | 177        |
| Trip information display (without navigation system).....   | 146        |   |            |
| <br>  |            | <b>2-5. Driving information.....</b>          | <b>181</b> |
| <b>2-3. Operating the lights and windshield wipers.....</b> | <b>148</b> | Utility vehicle precautions.....              | 181        |
| Headlight switch (type A).....                              | 148        | Cargo and luggage .....                       | 186        |
| Headlight switch (type B).....                              | 151        | Vehicle load limits .....                     | 189        |
| Fog light switch (type A).....                              | 154        | Winter driving tips .....                     | 190        |
| Fog light switch (type B) .....                             | 155        | Trailer towing .....                          | 195        |
| Windshield wipers and washer (type A).....                  | 156        | Dinghy towing.....                            | 204        |
| Windshield wipers and washer (type B) .....                 | 159        |   |            |

## 2-1. Driving procedures

# Driving the vehicle

The following procedures should be observed to ensure safe driving.

### ■ Starting the hybrid system

→P.131

### ■ Driving

**STEP 1** With the brake pedal depressed, shift the shift lever to D. (→P.135)

**STEP 2** Release the parking brake. (→P.138)

**STEP 3** Gradually release the brake pedal and gently push the accelerator pedal to accelerate the vehicle.

### ■ Stopping

**STEP 1** With the shift lever in D, push the brake pedal.

**STEP 2** If necessary, set the parking brake.

When the vehicle is stopped for an extended period of time, shift the shift lever to P. (→P.135)

### ■ Parking the vehicle

**STEP 1** With the shift lever in D, push the brake pedal.

**STEP 2** Set the parking brake. (→P.138)

**STEP 3** Shift the shift lever to P. (→P.135)

**STEP 4** Turn the engine switch to stop the hybrid system.

**STEP 5** Lock the door, making sure that you have the key on your person.

### Starting on a steep uphill

**STEP 1** Firmly set the parking brake and shift the shift lever to D.

**STEP 2** Gently depress the accelerator pedal.

**STEP 3** Release the parking brake.

### ■ Driving in the rain

- Drive carefully when it is raining, because visibility will be reduced, the windows may become fogged-up, and the road will be slippery.
- Drive carefully when it starts to rain, because the road surface will be especially slippery.
- Refrain from high speeds when driving on an expressway in the rain, because there may be a layer of water between the tires and the road surface, preventing the steering and brakes from operating properly.

### ■ Breaking in your new Lexus

To extend the life of the vehicle, the following precautions are recommended to observe:

- For the first 200 miles (300 km):  
Avoid sudden stops.
- For the first 500 miles (800 km):  
Do not tow a trailer.
- For the first 1000 miles (1600 km):
  - Do not drive at extremely high speeds.
  - Avoid sudden acceleration.
  - Do not drive continuously in the low gears.
  - Do not drive at a constant speed for extended periods.

### ■ Drum-in-disc type parking brake system

Your vehicle has a drum-in-disc type parking brake system. This type of brake system needs bedding-down of the brake shoes periodically or whenever the parking brake shoes and/or drum are replaced. Have your Lexus dealer perform the bedding down.

### ■ Operating your vehicle in a foreign country

Comply with the relevant vehicle registration laws and confirm the availability of the correct fuel. (→P. 441)

### ■ For efficient use of the hybrid battery

#### ● Put the shift lever into D when driving

In the N position, the gasoline engine operates but electricity cannot be generated. The hybrid battery (traction battery) will be discharged requiring unnecessary engine power to recharge.

#### ● Drive your vehicle smoothly

Avoid abrupt acceleration and deceleration. Gradual acceleration and deceleration will make more effective use of the traction motor without having to use gasoline engine power.

#### ● Avoid repeated acceleration

Repeated acceleration consumes hybrid battery (traction battery) power, resulting in poor acceleration. Battery power can be restored by driving with the accelerator pedal slightly released.

#### ● Put the shift lever into P when parking

In the N position, the hybrid battery (traction battery) does not recharge. Leaving the shift lever in the N position for an extended period of the time may discharge the hybrid battery. The vehicle cannot run if the hybrid battery is discharged.

### ■ Normal characteristics after turning off the hybrid system

Approximately five hours after the hybrid system is turned off, you may hear sound coming from under the vehicle for several minutes. This is the sound of a fuel evaporation leakage check and, it does not indicate a malfunction.

### CAUTION

#### ■ When starting the vehicle

Always keep your foot on the brake pedal while stopped with the hybrid system running. This prevents the vehicle from creeping.

 **CAUTION**
**■ When driving the vehicle**

- Do not drive if you are unfamiliar with the location of the brake and accelerator pedals to avoid depressing the wrong pedal.
  - Accidentally depressing the accelerator pedal instead of the brake pedal will result in sudden acceleration that may lead to an accident that could result in death or serious injury.
  - When backing up, you may twist your body around, leading to a difficulty in operating the pedals. Make sure to operate the pedals properly.
  - Make sure to keep a correct driving posture even when moving the vehicle only slightly, allowing you to depress the brake and accelerator pedals properly.
  - Depress the brake pedal using your right foot. Depressing the brake pedal using your left foot may delay response in an emergency, resulting in an accident.
- The driver should pay attention to pedestrians when the vehicle is powered only by the electric motor (traction motor). Because there is no engine noise, the pedestrians may misjudge the vehicle's movement.
- Do not drive the vehicle over or stop the vehicle near flammable materials.
- Do not let the vehicle roll backwards while the shift lever is in a driving position, or roll forward while the shift lever is in R.  
Doing so may cause the hybrid system to stall or lead to poor brake and steering performance, resulting in an accident or damage to the vehicle.
- If the smell of exhaust is noticed inside the vehicle, open the windows and check that the back door is closed. Large amounts of exhaust in the vehicle can cause driver drowsiness and an accident, resulting in death or a serious health hazard. Have the vehicle inspected by your Lexus dealer immediately.
- Do not under any circumstances shift the shift lever to P, R or N while the vehicle is moving.  
Doing so can cause significant damage to the transmission system and may result in a loss of vehicle control.
- Do not shift the shift lever to N while the vehicle is moving.  
Doing so may cause the engine brake to not operate properly and lead to an accident.

### CAUTION

#### ■ When driving the vehicle

- Use engine braking to maintain a safe speed when driving down a steep hill. Using the brakes continuously may cause the brakes to overheat and lose effectiveness. (→P.135)
- When stopped on an inclined surface, use the brake pedal and parking brake to prevent the vehicle from rolling backward or forward and causing an accident.
- Do not adjust the position of the steering wheel, the seat, or the inside or outside rear view mirrors while driving. Doing so may result in a loss of vehicle control that can cause accidents that may result in death or serious injury.
- Always check that all passengers' arms, heads or other parts of their bodies are not outside the vehicle, as this may result in death or serious injury.
- Do not drive in excess of the speed limit. Even if the legal speed limit permits it, do not drive over 85 mph (140 km/h) unless your vehicle has high-speed capability tires. Driving over 85 mph (140 km/h) may result in tire failure, loss of control and possible injury. Be sure to consult a tire dealer to determine whether the tires on your vehicle are high-speed capability tires or not before driving at such speeds.

#### ■ When driving on slippery road surfaces

- Sudden braking, acceleration and steering may cause tire slippage and reduce your ability to control the vehicle, resulting in an accident.
- Sudden changes in engine speed, such as engine braking caused by up-shifting or down-shifting, may cause the vehicle to skid, resulting in an accident.
- After driving through a puddle, lightly depress the brake pedal to make sure that the brakes are functioning properly. Wet brake pads may prevent the brakes from functioning properly. If the brakes on only one side are wet and not functioning properly, steering control may be affected, resulting in an accident.

#### ■ When shifting the shift lever

Be careful not to shift the shift lever with the accelerator pedal depressed. This may lead to unexpected rapid acceleration of the vehicle that may cause an accident and result in death or serious injury.

 **CAUTION**
**■ When the vehicle is stopped**

- Do not race the hybrid system.  
If the vehicle is in any gear other than P or N the vehicle may accelerate suddenly and unexpectedly, and may cause an accident.
- Do not leave the vehicle with the hybrid system on for a long time.  
If such a situation cannot be avoided, park the vehicle in an open space and check that exhaust fumes do not enter the vehicle interior.
- Always keep a foot on the brake pedal while the hybrid system is operating to prevent an accident caused by the vehicle moving.

**■ When the vehicle is parked**

- Do not leave glasses, cigarette lighters, spray cans, or soft drink cans in the vehicle when it is in the sun.  
Doing so may result in the following.
  - Gas may leak from a cigarette lighter or spray can, and may lead to a fire.
  - The temperature inside the vehicle may cause the plastic lenses and plastic material of eye glasses to deform or crack.
  - Soft drink cans may fracture, causing the contents to spray over the interior of the vehicle, and may also cause a short circuit in the vehicle's electrical components.
- Always apply the parking brake, shift the shift lever to P, stop the hybrid system and lock the vehicle.  
Do not leave the vehicle unattended while the hybrid system operating.
- Do not touch the exhaust pipe while the hybrid system or immediately after turning the hybrid system off.  
Doing so may cause burns.
- Do not leave the hybrid system operating in an area with snow build-up, or where it is snowing. If snowbanks build up around the vehicle while the hybrid system is operating, exhaust gases may collect and enter the vehicle. This may lead to death or a serious health hazard.

### CAUTION

#### ■ Exhaust gases

- Exhaust gases include harmful carbon monoxide (CO) that is colorless and odorless. Inhaling exhaust gases may lead to death or a serious health hazard.
- If the vehicle is in a poorly ventilated area, stop the hybrid system. In a closed area, such as a garage, exhaust gases may collect and enter the vehicle. This may lead to death or a serious health hazard.
- The exhaust should be checked occasionally. If there is a hole or crack caused by corrosion, damage to a joint or abnormal exhaust noise, be sure to have the vehicle inspected and repaired by your Lexus dealer. Failure to do so may allow exhaust gases to enter the vehicle, resulting in death or a serious health hazard.

#### ■ When taking a nap in the vehicle

Always turn the hybrid system off. Otherwise, you may accidentally move the shift lever or depress the accelerator pedal, which could cause an accident or fire due to hybrid system overheating. Additionally, if the vehicle is parked in a poorly ventilated area, exhaust gases may collect and enter the vehicle, leading to death or a serious health hazard.

#### ■ When braking the vehicle

- When the brakes are wet, drive more cautiously.  
Braking distance increases when the brakes are wet, and may cause one side of the vehicle to brake differently than the other side. Also the parking brake may not securely hold the vehicle.
- If the power brake assist function does not operate, do not follow other vehicles closely and avoid downhills or sharp turns that require braking.  
In this case, braking is still possible, but it will require more force on the pedal than usual. Braking distance may also increase.
- The brake system consists of 3 individual hydraulic systems: if one of the systems fails, the other will still operate. In this case, the brake pedal should be depressed more firmly than usual and braking distance becomes longer.  
Do not drive your vehicle with only a single brake system. Have your brakes fixed immediately.

#### ■ If the vehicle becomes stuck or bogged (AWD models)

Do not spin the wheels recklessly when any of the tires is up in the air, or stuck in sand or mud, etc. This may damage the drive system components or propel the vehicle forward (or in another direction) and cause an accident.

 NOTICE**■ While driving the vehicle**

Do not use the accelerator pedal or depress accelerator and brake pedals together to hold the vehicle on a hill.

**■ When parking the vehicle**

Always put the shift lever in P.

Failure to do so may cause the vehicle to move or the vehicle may accelerate suddenly if the accelerator pedal is accidentally depressed.

**■ Avoiding damage to vehicle parts**

- Do not turn the steering wheel fully in either direction and hold it there for a long time.

Doing so may damage the power steering pump.

- When driving over bumps in the road, drive as slowly as possible to avoid damaging the wheels, underside of the vehicle, etc.

**■ If you hear a squealing or scraping noise (brake pad wear limit indicators)**

Have your Lexus dealer check and replace the brake pads as soon as possible.

The rotor damage can result if the pads are not replaced when needed.

It is dangerous to drive the vehicle when the wear limits of the brake pads and/or that of the brake discs are exceeded.

**■ If you get a flat tire while driving**

A flat or damaged tire may cause the following situations. Hold the steering wheel firmly and gradually press the brake pedal to slow down the vehicle.

- It may be difficult to control your vehicle.

- The vehicle will make abnormal sounds.

- The vehicle will behave abnormally.

Replace a flat tire with a new one. (→P. 420)

### NOTICE

#### ■ When encountering flooded roads

Do not drive on a road that has flooded after heavy rain etc. Doing so may cause the following serious damage to the vehicle.

- Engine stalling
- Short in electrical components
- Engine damage caused by water immersion

In the event that you drive on a flooded road and the vehicle is flooded, be sure to have your Lexus dealer check the following.

- Brake function
- Changes in quantity and quality of oil and fluid used for the engine, transaxle, differential, etc.
- Lubricant condition for the bearings and suspension joints (where possible) and the function of all joints, bearings, etc.

## Engine (ignition) switch

### ■ Engine switch

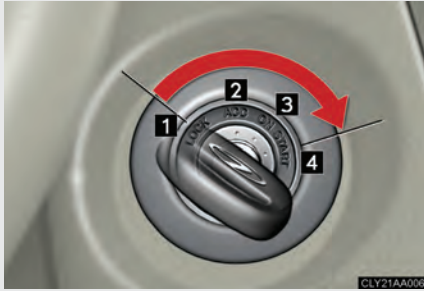

#### 1 LOCK

The hybrid system is off and the steering wheel is locked and the key can be removed from the engine switch.

#### 2 ACC

The hybrid system is off and some electrical components such as the audio system can be used.

#### 3 ON

The hybrid system is on and all electrical components can be used.

#### 4 START

### ■ Starting the hybrid system

**STEP 1** Check that the parking brake is set.

**STEP 2** Turn off unnecessary lights and accessories.

**STEP 3** Check that the shift lever is set in P.

**STEP 4** Sit in the driver's seat and firmly depress the brake pedal.

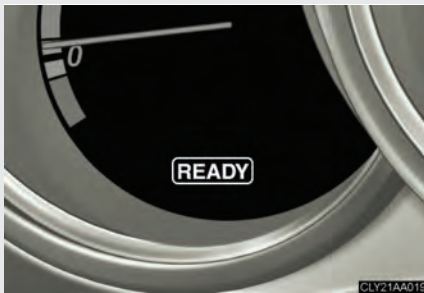

Turn the engine switch to the START position.

After a few seconds, the READY light will flash and come on with a beep sound.

The vehicle can move when the READY light is on, even if the hybrid system is stopped.

As the hybrid system starts only with the transmission in the P position, put the selector lever in P whenever starting the system.

### ■ Turning the key from ACC to LOCK

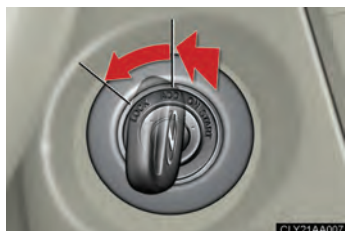

**STEP 1** Shift the shift lever to P.

**STEP 2** Push in the key and turn to the LOCK position.

### ■ Steering lock release



When starting the hybrid system, the engine switch may seem stuck in the LOCK position. To free it, turn the key while turning the steering wheel slightly in either direction.

### ■ If the hybrid system does not start

The hybrid vehicle immobilizer system may not have been deactivated. (→P. 83)

### ■ If the 12-volt battery is disconnected or run down...

→P. 336

### ■ If the READY light does not come on

If the READY light does not come on when you turn the engine switch with the shift lever in P and the brake pedal pressed, contact your Lexus dealer immediately.

### ■ Starting the hybrid system using the flat key

STEP 1



Remove the flat key from its case. Insert the key into the engine switch.

STEP 2



Bring the key case close to the engine switch within 10 seconds as indicated by an arrow.

STEP 3

Put the key case away when the indicator light goes out. This means the hybrid vehicle immobilizer system has turned off.

STEP 4

Start the hybrid system within 60 seconds after the indicator light goes off.

### ■ When the ambient temperature is low

Such as during winter driving conditions, it may take time until the READY light comes on.

### ■ Sounds and vibrations specific to a hybrid vehicle

→P. 26

### ■ When the hybrid system is malfunctioning

→P. 406

### CAUTION

#### ■ When starting the hybrid system

Always start the hybrid system while sitting in the driver's seat. Do not press the accelerator pedal while starting the hybrid system under any circumstances. Doing so may cause an accident resulting in death or serious injury.

#### ■ Caution when driving

Do not turn the engine switch to the LOCK position while driving. If, in an emergency, you must turn the hybrid system off while the vehicle is moving, turn the engine switch only to the ACC position.

### NOTICE

#### ■ To prevent 12-volt battery discharge

Do not leave the engine switch in the ACC or ON position for long periods without the hybrid system on.

#### ■ When starting the hybrid system

- If any service reminder indicator light comes on or warning message appears on the multi-information display or the 12-volt battery is disconnected, the hybrid system may not start. In that case, turn the ignition on again. If the READY light does not come on, contact your Lexus dealer.
- Do not race the hybrid system.
- If the hybrid system becomes difficult to start or stalls frequently, have the hybrid system checked immediately.

Select a shift position appropriate for the driving conditions.

■ Shifting the shift lever



➔ While the engine switch is in the ON position, depress the brake pedal and move the shift lever.

■ Shift position uses

| Shift position | Function  |
|----------------|---|
| P              | Parking the vehicle or starting the hybrid system |
| R              | Reversing   |
| N              | Neutral   |
| D              | Normal driving                                    |
| B              | Engine braking                                    |

■ If the shift lever cannot be shifted from P

→P. 427

## 2-1. Driving procedures

### Turn signal lever (type A)



- 1 Left turn
- 2 Right turn
- 3 Move and hold the lever part-way to signal a lane change  
The left hand signal will flash until you release the lever.
- 4 Move and hold the lever part-way to signal a lane change  
The right hand signal will flash until you release the lever.

#### ■ Turn signals can be operated when

The engine switch is in the ON position.

#### ■ If the indicators flash faster than usual

Check that a light bulb in the front or rear turn signal lights has not burned out.

## 2-1. Driving procedures

### Turn signal lever (type B)

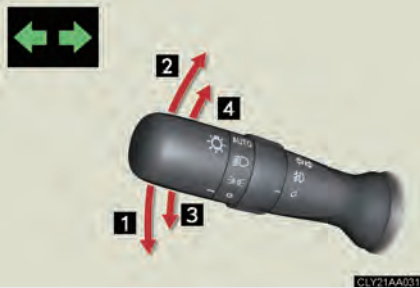

- 1 Left turn
- 2 Right turn
- 3 Move and hold the lever part-way to signal a lane change  
The left hand signal will flash until you release the lever.
- 4 Move and hold the lever part-way to signal a lane change  
The right hand signal will flash until you release the lever.

2

When driving

#### ■ Turn signals can be operated when

The engine switch is in the ON position.

#### ■ If the indicators flash faster than usual

Check that a light bulb in the front or rear turn signal lights has not burned out.

## 2-1. Driving procedures

# Parking brake



Sets the parking brake\*  
(Depressing the pedal again releases the parking brake.)

\*: Fully depress the parking brake pedal with your left foot while depressing the brake pedal with your right foot.

### NOTICE

#### Before driving

Fully release the parking brake.

Driving the vehicle with the parking brake set will lead to brake components overheating, which may affect braking performance and increase brake wear.

## 2-2. Instrument cluster

# Gauges and meters

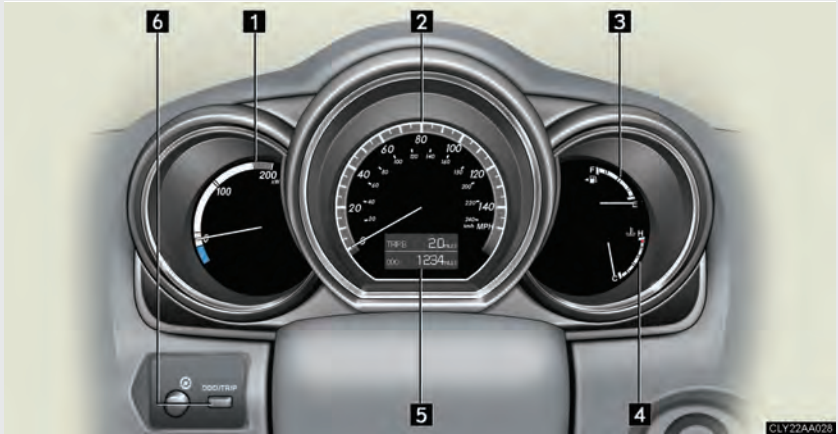

The units used on the speedometer and the power meter gauge display may differ depending on the model/type.

The following gauges and meters illuminate when the engine switch is in the ON position.

- 1** Power meter  
Displays the instantaneous output from the hybrid system in approximate kilowatts.
- 2** Speedometer  
Displays the vehicle speed.
- 3** Fuel gauge  
Displays the quantity of fuel remaining in the tank.
- 4** Engine coolant temperature gauge  
Displays the engine coolant temperature.
- 5** Multi-information display (→P. 144)
- 6** Odometer/trip meter and trip meter reset button  
Switches between odometer and trip meter displays. Pushing and holding the button will reset the trip meter when the trip meter is being displayed.

### Instrument panel light control

The brightness of the instrument panel lights can be adjusted.

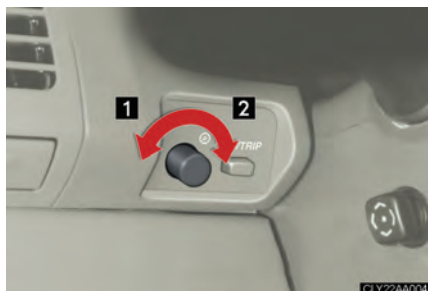

- 1 Darker
- 2 Brighter

#### NOTICE

##### To prevent damage to the engine and its components

The engine may be overheating if the engine coolant temperature gauge is in the red zone (H). In this case, immediately stop the vehicle in a safe place. Check the engine after it has cooled completely. (→P. 432)

## 2-2. Instrument cluster

# Indicators and warning lights

The indicator and warning lights on the instrument cluster and center panel inform the driver of the status of the vehicle's various systems.

### ► Instrument cluster



The units used on the speedometer and the power meter gauge display may differ depending on the model/type.

### ► Center panel



## ■ Indicators

The indicators inform the driver of the operating state of the vehicle's various systems.



Turn signal indicator  
(→P.136, 137)



Headlight high beam indicator (→P.148, 151)



(U.S.A.)

Headlight indicator  
(→P.148, 151)



(Canada)

Tail light indicator  
(→P.148, 151)



Cruise control indicator  
(→P.165, 168)



Slip indicator  
(→P.178)



(vehicles with discharge headlights)

AFS OFF indicator  
(→P.149, 152)



Driving ready indicator  
(→P.131)



\*

AIR BAG ON indicator  
(→P.103)



\*

AIR BAG OFF indicator  
(→P.103)



Shift position indicator (→P.135)

## ■ Warning lights

Warning lights inform the driver of malfunctions in any of the vehicle's systems.

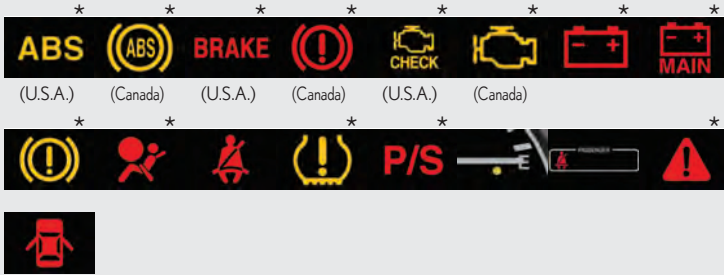

\*: These lights turn on when the engine switch is turned to the ON position to indicate that a system check is being performed. They will turn off after the hybrid system is started, or after a few seconds. There may be a malfunction in a system if a light does not come on, or if the lights do not turn off. Have the vehicle inspected by your Lexus dealer.

### ⚠ CAUTION

#### ■ If a safety system warning light does not come on

Should a safety system light such as ABS and the SRS airbag warning light not come on when you start the hybrid system, this could mean that these systems are not available to help protect you in an accident, which could result in death or serious injury. Have the vehicle inspected by your Lexus dealer immediately if this occurs.

# Multi-information display

The multi-information display presents the driver with a variety of driving related data, including the status of the hybrid system.



- Odometer and trip meter display

Odometer displays the total distance the vehicle has been driven.

Trip meter displays the distance the vehicle has been driven since the meter was last reset. Trip meters A and B can be used to record and display different distances independently.

- Energy monitor (→P. 28)  
Displays the status of the hybrid system.
- Dynamic laser cruise control display (if equipped) (→P. 168)  
Automatically displayed when using dynamic laser cruise control.
- Warning messages (→P. 406)  
Automatically displayed when a malfunction occurs in one of the vehicle's systems.



Display items can be switched by pushing the DISP. switch.

2

When driving

## Trip information

### ■ Outside temperature

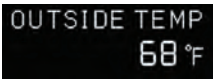

Displays the outside air temperature.

The temperature range that can be displayed is from -22°F (-30°C) to 122°F (50°C).

### ■ Average fuel consumption after refueling



Displays the average fuel consumption since the vehicle was last refueled.

### ■ Current fuel consumption

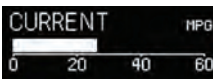

Displays the current rate of fuel consumption.

## ⚠ CAUTION

### ■ The multi-information display at low temperatures

Allow the interior of the vehicle to warm up before using the liquid crystal information display. At extremely low temperatures, the information display monitor may respond slowly, and display changes may be delayed.

## 2-2. Instrument cluster

# Trip information display (without navigation system)

The trip information display presents the driver with a variety of driving-related data.



### 1 Trip information display

- Driving time
- Average fuel consumption
- Current fuel consumption
- Driving distance

## Display and operation



Display items can be switched by pushing the INFO switch.

### ■ Driving time



Displays the elapsed time after the hybrid system starts.

When the hybrid system is started, driving time is counted from 0:00. Up to 11:59 (11 hours, 59 minutes) can be displayed.

### ■ Average fuel consumption



Displays the average fuel consumption since the vehicle was last refueled.

### ■ Current fuel consumption



Displays the current rate of fuel consumption.

### ■ Driving distance



Displays the driving distance since the hybrid system was started.

The function can be reset by pushing the INFO switch for longer than one second when the driving distance is displayed.

## ⚠ CAUTION

### ■ Caution while driving

Do not adjust the display while driving.

Doing so may cause the driver to mishandle the vehicle and an accident, resulting in death or serious injury.

## 2-3. Operating the lights and windshield wipers

### Headlight switch (type A)

The headlights can be operated manually or automatically.

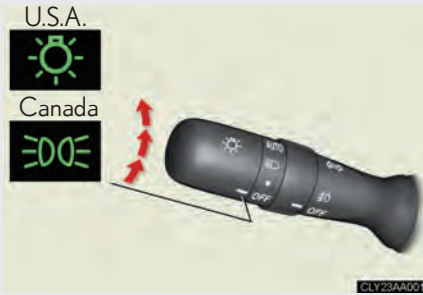

 The side marker, parking, tail, license plate and instrument panel lights turn on.

 The headlights and all lights listed above turn on.

**AUTO** The headlights and parking lights turn on and off automatically.  
(When the engine switch is in the ON position)

### Turning on the high beam headlights



**1** With the headlights on, push the lever forward to turn on the high beams.

Pull the lever back to the center position to turn the high beams off.

**2** Pull the lever toward you to turn on the high beams.

Release to turn them off. You can flash the high beams with the headlights on or off.

## AFS (vehicles with discharge headlights)

AFS (Adaptive Front Lighting System) improves visibility at intersections and on curves by automatically adjusting the direction light axis of the headlights according to vehicle speed and the degree of the tire angle that are controlled by steering input.

Operates at speeds of 18 mph (30 km/h) or higher.

### ■ Deactivating AFS

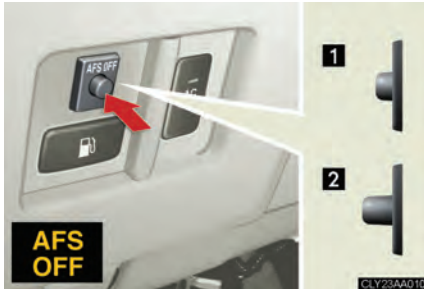

Turn the switch OFF to deactivate AFS.

- 1 OFF
- 2 ON

2

When driving

### ■ Daytime running light system

To make your vehicle more visible to other drivers, the headlights turn on automatically (at a reduced intensity) whenever the hybrid system is started and the parking brake is released. Daytime running lights are not designed for use at night.

### ■ Headlight control sensor

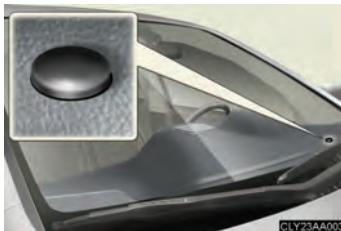



The sensor may not function properly if an object is placed on the sensor, or anything that blocks the sensor is affixed to the windshield.

Doing so interferes with the sensor detecting the level of ambient light and may cause the automatic headlight control system to malfunction.

### ■ Automatic light off system

- When the headlights come on: The headlights and tail lights turn off 30 seconds after all doors are closed with the engine switch turned to the ACC or LOCK position. (The light turns off immediately if the LOCK button on the key is pressed after all doors are locked.)
- When only the tail lights come on: The tail lights turn off automatically with the engine switch turned to the ACC or LOCK position and the driver's door is opened.

To turn the lights on again, turn the engine switch to the ON position, or turn the light switch OFF once and then back to the  or  position.

### ■ Automatic headlight leveling system (vehicles with discharge headlights)

The level of the headlights is automatically adjusted according to the number of passengers and the loading condition of the vehicle to ensure that the headlights do not interfere with other road users.

### ■ If the indicator flashes... (vehicles with discharge headlights)

It may indicate a malfunction in the system. Contact your Lexus dealer.

### ■ Customization that can be configured at Lexus dealer

Setting (e.g. light sensor sensitivity) can be changed. (Customizable features →P. 466)

#### NOTICE

#### ■ To prevent 12-volt battery discharge

Do not leave the lights on longer than necessary when the hybrid system is off.

## 2-3. Operating the lights and windshield wipers

### Headlight switch (type B)

The headlights can be operated manually or automatically.

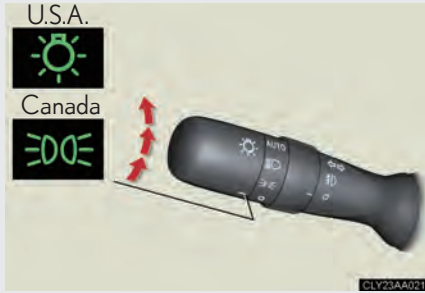

 The side marker, parking, tail, license plate and instrument panel lights turn on.

 The headlights and all lights listed above turn on.

**AUTO** The headlights and parking lights turn on and off automatically. (When the engine switch is in the ON position)

### Turning on the high beam headlights



**1** With the headlights on, push the lever forward to turn on the high beams.

Pull the lever back to the center position to turn the high beams off.

**2** Pull the lever toward you to turn on the high beams.

Release to turn them off. You can flash the high beams with the headlights on or off.

### AFS (vehicles with discharge headlights)

AFS (Adaptive Front Lighting System) improves visibility at intersections and on curves by automatically adjusting the direction light axis of the headlights according to vehicle speed and the degree of the tire angle that are controlled by steering input.

Operates at speeds of 18 mph (30 km/h) or higher.

#### ■ Deactivating AFS

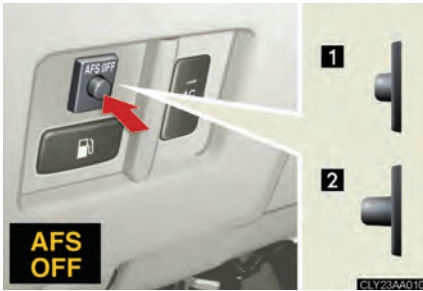

Turn the switch OFF to deactivate AFS.

- 1 OFF
- 2 ON

#### ■ Daytime running light system

To make your vehicle more visible to other drivers, the headlights turn on automatically (at a reduced intensity) whenever the hybrid system is started and the parking brake is released. Daytime running lights are not designed for use at night.

#### ■ Headlight control sensor

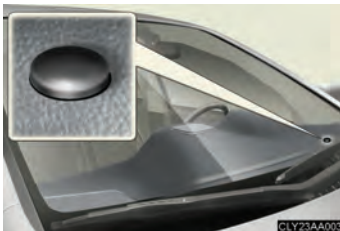



The sensor may not function properly if an object is placed on the sensor, or anything that blocks the sensor is affixed to the windshield.

Doing so interferes with the sensor detecting the level of ambient light and may cause the automatic headlight control system to malfunction.

### ■ Automatic light off system

- When the headlights come on: The headlights and tail lights turn off 30 seconds after all doors are closed with the engine switch turned to the ACC or LOCK position. (The light turns off immediately if the LOCK button on the key is pressed after all doors are locked.)
- When only the tail lights come on: The tail lights turn off automatically with the engine switch turned to the ACC or LOCK position and the driver's door is opened.

To turn the lights on again, turn the engine switch to the ON position, or turn the light switch OFF once and then back to the  or  position.

### ■ Automatic headlight leveling system (vehicles with discharge headlights)

The level of the headlights is automatically adjusted according to the number of passengers and the loading condition of the vehicle to ensure that the headlights do not interfere with other road users.

### ■ If the indicator flashes... (vehicles with discharge headlights)

It may indicate a malfunction in the system. Contact your Lexus dealer.

### ■ Customization that can be configured at Lexus dealer

Setting (e.g. light sensor sensitivity) can be changed. (Customizable features →P. 466)

#### NOTICE

### ■ To prevent 12-volt battery discharge

Do not leave the lights on longer than necessary when the hybrid system is off.

## 2-3. Operating the lights and windshield wipers

### Fog light switch (type A)

The fog lights improve visibility in difficult driving conditions, such as in rain or fog. They can be turned on only when the headlights are on low beam.



- 1 To turn the front fog lights off
- 2 To turn the front fog lights on

## 2-3. Operating the lights and windshield wipers

### Fog light switch (type B)

The fog lights improve visibility in difficult driving conditions, such as in rain or fog. They can be turned on only when the headlights are on low beam.



- 1 To turn the front fog lights off
- 2 To turn the front fog lights on

## 2-3. Operating the lights and windshield wipers

### Windshield wipers and washer (type A)

#### ■ Intermittent wiper with interval adjuster (if equipped)

When intermittent wiper operation is selected, wiper intervals can be adjusted.



- 1 Intermittent windshield wiper interval adjustment (increase)
- 2 Intermittent windshield wiper interval adjustment (decrease)
- 3 Intermittent windshield wiper operation
- 4 Low speed windshield wiper operation
- 5 High speed windshield wiper operation
- 6 Temporary operation
- 7 Washer/wiper dual operation

Wipers will automatically operate a couple of times after the washer squirts.

### ■ Rain-sensing windshield wipers (if equipped)

With AUTO selected, the wipers will operate automatically when the sensor detects falling rain. The system automatically adjusts wiper timing in accordance with rain volume.



- 1 Sensor sensitivity (low)
- 2 Sensor sensitivity (high)
- 3 Rain-sensing wiper operation
- 4 Low speed wiper operation
- 5 High speed wiper operation
- 6 Temporary operation
- 7 Washer/wiper dual operation

Wipers will automatically operate a couple of times after the washer squirts.

### ■ The windshield wiper and washer can be operated when

The engine switch must be in the ON position.

### ■ Effects of vehicle speed on wiper operation (vehicles with the rain-sensing windshield wipers)

With LO selected, wiper operation will be switched from low speed to intermittent wiper operation only when the vehicle is stationary.

(However, the mode cannot be switched when the adjustment dial for the automatic wiper control sensitivity is set to +.)

## 2-3. Operating the lights and windshield wipers

### ■ Rain drop sensor (vehicles with the rain-sensing windshield wipers)



The sensor judges the amount of raindrops.

### ■ If no windshield washer fluid sprays

Check that the washer nozzles are not blocked if there is washer fluid in the windshield washer fluid reservoir.

#### CAUTION

##### ■ Caution regarding the use of windshield wipers in AUTO mode

The windshield wipers may operate unexpectedly if the sensor is touched or the windshield is subject to vibration in AUTO mode. Take care that your fingers or anything else do not become caught in the windshield wipers.

#### NOTICE

##### ■ When the windshield is dry

Do not use the wipers, as they may damage the windshield.

##### ■ When there is no washer fluid spray from the nozzle

Damage to the washer fluid pump may be caused if the lever is pulled toward you and held continually.

## Windshield wipers and washer (type B)

### ■ Intermittent wiper with interval adjuster (if equipped)

When intermittent wiper operation is selected, wiper intervals can be adjusted.



- 1 Intermittent windshield wiper interval adjustment (decrease)
- 2 Intermittent windshield wiper interval adjustment (increase)
- 3 Intermittent windshield wiper operation
- 4 Low speed windshield wiper operation
- 5 High speed windshield wiper operation
- 6 Temporary operation
- 7 Washer/wiper dual operation

Wipers will automatically operate a couple of times after the washer squirts.

### ■ Rain-sensing windshield wipers (if equipped)

With AUTO selected, the wipers will operate automatically when the sensor detects falling rain. The system automatically adjusts wiper timing in accordance with rain volume.



- 1 Sensor sensitivity (high)
- 2 Sensor sensitivity (low)
- 3 Rain-sensing wiper operation
- 4 Low speed wiper operation
- 5 High speed wiper operation
- 6 Temporary operation
- 7 Washer/wiper dual operation

Wipers will automatically operate a couple of times after the washer squirts.

### ■ The windshield wiper and washer can be operated when

The engine switch must be in the ON position.

### ■ Effects of vehicle speed on wiper operation (vehicles with the rain-sensing windshield wipers)

When low speed wiper operation is selected, wiper operation will be switched from low speed to intermittent wiper operation when the vehicle is stationary. (However, the mode will not be switched when the adjustment dial for the automatic wiper control sensitivity is set to high.)

■ Rain drop sensor (vehicles with the rain-sensing windshield wipers)



The sensor judges the amount of raindrops.

■ If no windshield washer fluid sprays

Check that the washer nozzles are not blocked if there is washer fluid in the windshield washer fluid reservoir.

**⚠ CAUTION**

■ **Caution regarding the use of windshield wipers in AUTO mode**

The windshield wipers may operate unexpectedly if the sensor is touched or the windshield is subject to vibration in AUTO mode. Take care that your fingers or anything else do not become caught in the windshield wipers.

**⚠ NOTICE**

■ **When the windshield is dry**

Do not use the wipers, as they may damage the windshield.

■ **When there is no washer fluid spray from the nozzle**

Damage to the washer fluid pump may be caused if the lever is pulled toward you and held continually.

## 2-3. Operating the lights and windshield wipers

### Rear window wiper and washer (type A)



- 1 Intermittent window wiper operation
- 2 Normal window wiper operation
- 3 Washer operation
- 4 Washer/wiper dual operation

#### ■ The rear window wiper and washer can be operated when

The engine switch must be in the ON position.

#### ⚠ NOTICE

#### ■ When the rear window is dry

Do not use the wipers, as they may damage the rear window.

## 2-3. Operating the lights and windshield wipers

### Rear window wiper and washer (type B)



- 1 Intermittent window wiper operation
- 2 Normal window wiper operation
- 3 Washer operation
- 4 Washer/wiper dual operation

2

When driving

- **The rear window wiper and washer can be operated when**  
The engine switch must be in the ON position.

#### NOTICE

- **When the rear window is dry**  
Do not use the wipers, as they may damage the rear window.

## 2-3. Operating the lights and windshield wipers

### Headlight cleaner switch (if equipped)

Washer fluid can be sprayed on the headlights.



Press the switch to clean the headlights.

#### ■ The headlight cleaner can be operated when

When the engine switch must be in the ON position and the headlight switch is turned ON.

#### NOTICE

#### ■ When the washer fluid tank is empty

Do not use this function when the washer fluid tank is empty. This may cause the washer fluid pump to overheat.

## 2-4. Using other driving systems

### Cruise control (if equipped)

Use the cruise control to maintain a set speed without using the accelerator.

#### ■ Set the vehicle speed



Turn the ON-OFF button ON.

Push the button once more to deactivate the cruise control.



Accelerate or decelerate to the desired speed and press the lever down to set the cruise control speed.

#### ■ Adjusting the speed setting



**1** Increase speed

**2** Decrease speed

Hold the lever until the desired speed setting is obtained.

### ■ Canceling and resuming regular acceleration



#### 1 Cancel

Push the lever towards you to cancel cruise control.

The speed setting is also canceled when the brakes are applied.

#### 2 Resume

To resume cruise control and return to the set speed, push the lever up.

### ■ Fine adjustment of the set speed

Adjustment of the set speed by approximately 1.0 mph (1.6 km/h) can be made by lightly pressing the lever up or down and releasing it.

### ■ Cruise control can be set when

- The shift lever is in the D.
- Vehicle speed is between approximately 25 mph (40 km/h) and 125 mph (200 km/h).

### ■ Accelerating

The vehicle can be accelerated normally.

### ■ Automatic cruise control cancellation

The set speed is automatically cancelled in any of the following situations.

- Actual vehicle speed falls more than 10 mph (16 km/h) below the preset vehicle speed.  
At this time, the memorized set speed is not retained.
- Actual vehicle speed is below 25 mph (40 km/h).
- VSC is activated.

**■ If the cruise control indicator light flashes**

Turn the ON-OFF button off once, and then reactivate the system.

If the cruise control speed cannot be set or if the cruise control cancels immediately after being activated, there may be a malfunction in the cruise control system. Have the vehicle inspected by your Lexus dealer.

**⚠ CAUTION****■ To avoid operating the cruise control by mistake**

Keep the ON-OFF button off when not in use.

**■ Situations unsuitable for cruise control**

Do not use cruise control in any of the following situations.

Doing so may result in control of the vehicle being lost and could cause serious or fatal accident.

- In heavy traffic
- On roads with sharp bends
- On slippery roads, such as those covered with rain, ice or snow
- On steep hills
- On winding roads

## 2-4. Using other driving systems

### Dynamic laser cruise control (if equipped)

Dynamic laser cruise control supplements conventional cruise control with a vehicle-to-vehicle distance control. In the vehicle-to-vehicle distance control mode, the vehicle automatically accelerates or decelerates in order to maintain a set following distance from vehicles ahead.

#### ■ Select cruise mode



Selecting vehicle-to-vehicle distance control mode

- 1 Turn the ON-OFF button ON.

Push the button once more to deactivate.



Selecting conventional constant speed control mode

- 1 Turn the ON-OFF button ON.

Push the button once more to deactivate.

Vehicle-to-vehicle distance control mode is always reset when the engine switch is turned to the ON position.

- 2 Switch to constant speed control mode.

(push and hold for approximately one second)

### ■ Driving in the selected cruise control mode



Accelerate or decelerate to the desired speed and press the lever down to set.

### ■ Adjusting the speed setting



- 1 Increase speed
- 2 Decrease speed

Hold the lever until the desired speed setting is displayed.

### ■ Canceling and resuming the speed setting



- 1 Cancel

Push the lever towards you to cancel cruise control.

The setting is also canceled when the brakes are applied.

- 2 Resume

To resume cruise control and return to the set speed, push the lever up.

### ■ Changing the vehicle-to-vehicle distance

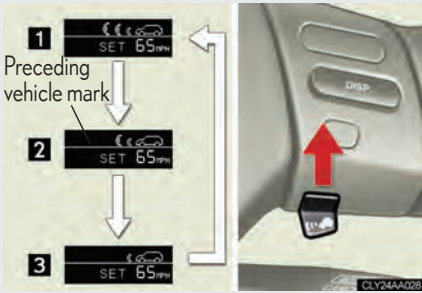

Each push of the switch toward you changes the vehicle-to-vehicle distance

- 1 Long
- 2 Medium
- 3 Short

The vehicle-to-vehicle distance is automatically set to the long mode when the engine switch is turned to the ON position.

A mark will be displayed to indicate the presence of the vehicle if a vehicle is running ahead of you.

## Driving in vehicle-to-vehicle distance control mode

This mode employs a laser radar sensor to detect the presence of vehicles within 400 ft. (120 m) ahead and to judge the distance between your vehicle and those vehicles.

Note that vehicle-to-vehicle distance will close when traveling on long downhill slopes.

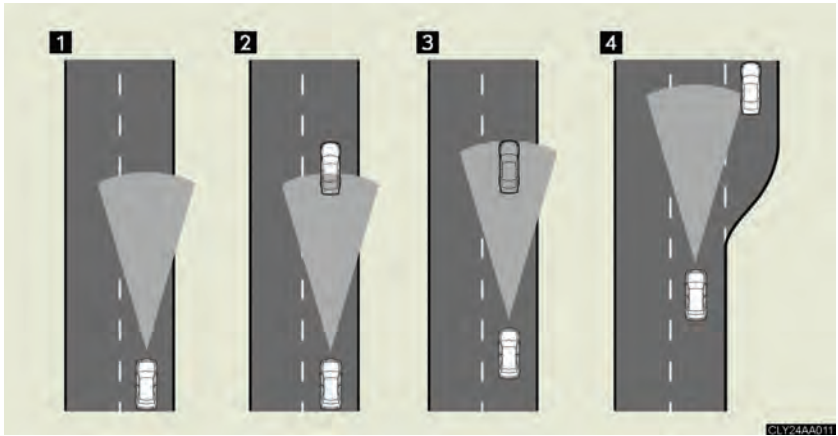

- 1** Example of constant speed cruising (when there are no vehicles ahead):

When set to 62 mph (100 km/h)

The vehicle travels at the speed set by the driver. The desired vehicle-to-vehicle distance can also be set by operating the vehicle-to-vehicle distance switch.

- 2** Example of deceleration cruising (when the vehicle ahead is driving slower than the set speed):

When fixed speed cruising is set at 62 mph (100 km/h) and the vehicle ahead is driving at 50 mph (80 km/h)

When a vehicle is detected running ahead of you, in the same lane, the system automatically decelerates your vehicle. When a greater reduction in vehicle speed is necessary, the system applies the brakes. A warning tone warns you when the system cannot decelerate sufficiently to prevent your vehicle from closing on the vehicle ahead.

- 3 Example of follow-up cruising (when following a vehicle driving slower than the set speed):

When the speed is set to 62 mph (100 km/h) and the vehicle ahead is driving at 50 mph (80 km/h)

The system continues follow-up cruising while adjusting for changes in the speed of the vehicle ahead in order to maintain the vehicle-to-vehicle distance set by the driver.

- 4 Example of acceleration (when there are no longer vehicles driving slower than the set speed in the lane ahead):

When the speed is set to 62 mph (100 km/h) and the vehicle ahead driving at 50 mph (80 km/h) is out of the lane

When the vehicle ahead of you executes a lane change, the system slowly accelerates until the set vehicle speed is reached. The system then returns to fixed speed cruising.

---

### ■ Fine adjustment of the set speed

Adjustment of the set speed by the following speed can be made by lightly pressing the lever up or down and releasing it.

In the constant speed control mode: Approximately 1.0 mph (1.6 km/h)

In the vehicle-to-vehicle distance control mode:

U.S.A.: Approximately 5 mph (8 km/h)

Canada: Approximately 3 mph (5 km/h)

### ■ Dynamic laser cruise control warning lights, display and buzzers

Warning lights, display and buzzers are used to indicate a system malfunction or to alert you to the need for caution while driving. (→P. 406)

### ■ The dynamic laser cruise can be set when

- The shift lever is in D.
- Vehicle speed is between approximately 27 mph (45 km/h) and 85 mph (135 km/h).

### ■ Accelerating

The vehicle can be accelerated normally.

**■ Automatically canceling vehicle-to-vehicle distance control**

Vehicle-to-vehicle distance control driving is automatically canceled in the following situations.

- Vehicle speed falls below 25 mph (40 km/h)
- VSC is activated
- The sensor cannot operate correctly because it is covered in some way.\*
- The windshield wipers are operating at high or low speed.\*

\*: Vehicle-to-vehicle distance control driving must be reset by turning the ON-OFF button on again.

If vehicle-to-vehicle distance control driving is automatically canceled for any other reason, there may be a malfunction in the system. Contact your Lexus dealer.

**■ Automatically cancelling constant speed control**

The set speed is automatically canceled in the following situations.

- Actual vehicle speed is more than 10 mph (16 km/h) below the preset vehicle speed  
At this time, the memorized set speed is not retained.
- Vehicle speed falls below 25 mph (40 km/h)
- VSC is activated

### ■ Vehicle-to-vehicle distance settings

Select a distance from the table below. Note that the distances shown correspond to a vehicle speed of 55 mph (88 km/h). Vehicle-to-vehicle distance increases/decreases in accordance with vehicle speed.

| Distance options | Vehicle-to-vehicle distance  |
|------------------|------------------------------|
| Long             | Approximately 245 ft. (75 m) |
| Medium           | Approximately 165 ft. (50 m) |
| Short            | Approximately 100 ft. (30 m) |

### ■ Laser radar sensor



Always keep the sensor clean to ensure that the vehicle-to-vehicle distance control operates properly. (Some obstructions, such as snow, ice or plastic objects, cannot be detected by the obstruction sensor.)

Dynamic laser cruise control is canceled if an obstruction is detected.

### ■ Certification

This product is a class I laser product complied with 21 C. F. R part 1040.10. and 1040.11.

 **CAUTION****■ Before using dynamic laser cruise control**

Do not overly rely on vehicle-to-vehicle distance control.

Be aware of the set vehicle speed. If automatic deceleration/acceleration is not appropriate, adjust the vehicle speed, as well as the distance between your vehicle and vehicles ahead by applying the brakes, etc.

**■ To avoid inadvertent cruise control activation**

Keep the ON-OFF button off when not in use.

**■ Situations unsuitable for dynamic laser cruise control**

Do not use dynamic laser cruise control in any of the following situations.

Doing so may result in inappropriate control of speed and could cause serious or fatal accident.

- In heavy traffic
- On roads with sharp bends
- On winding roads
- On slippery roads, such as those covered with rain, ice or snow
- Where there are sudden changes between sharp up and down gradients
- At entrances to expressways
- When weather conditions are bad enough that they may prevent the sensors from functioning correctly (fog, snow, sandstorm, etc.)
- When buzzer can be heard often

### CAUTION

#### ■ When the laser radar sensor may not be correctly detecting the vehicle ahead

Apply the brakes as necessary when any of the following types of vehicles are in front of you.

As the sensor may not be able to correctly detect these types of vehicles, the proximity alarm (→P. 172) will not be activated, and an accident may result.

- Vehicles that cut in suddenly
- Vehicles traveling at low speeds
- Vehicles that are not moving
- Vehicles with small rear ends (trailers with no load on board etc.)
- Motorcycles traveling in the same lane

#### ■ Conditions under which the vehicle-to-vehicle distance control may not function correctly

Apply the brakes as necessary in the following conditions as the laser radar sensor may not be able to correctly detect vehicles ahead, and an accident may result.

- When water or snow thrown up by the surrounding vehicles hinders the functioning of the sensor
- When your vehicle is pointing upwards (caused by a heavy load in the luggage compartment, etc.)
- When the road curves or when the lanes are narrow
- When steering wheel operation or your position in the lane is unstable

#### ■ To ensure the laser radar sensor functions correctly

Do not do the following to the sensor as doing so may cause the sensor not to function correctly and could result in an accident.

- Stick or attach anything to them
- Leave them dirty
- Disassemble, subject them to strong shocks
- Modify or paint them
- Replace them with non-genuine parts

# Driving assist systems

To help enhance driving safety and performance, the following systems operate automatically in response to various driving situations. Be aware, however, that these systems are supplementary and should not be relied upon too heavily when operating the vehicle.

### ■ ABS (Anti-lock Brake System)

Restrains the vehicle from slipping when driving on slick road surfaces or in the event of sudden braking.

### ■ Brake Assist

Generates an increased level of braking force after the brake pedal is depressed, when the system detects a panic stop situation.

### ■ VSC (Vehicle Stability Control)

Helps the driver to control skidding when swerving suddenly or turning on slippery road surfaces.

### ■ Traction Control

Maintains drive power and prevents the front wheels (2WD models) or all wheels (AWD models) from spinning when starting the vehicle or accelerating on slippery roads.

### ■ EPS (Electric Power Steering)

Employs an electric motor to reduce the amount of effort needed to turn the steering wheel.

### ■ VDIM (Vehicle Dynamics Integrated Management)

Provides integrated control of the ABS, VSC, traction control and EPS systems.

Maintains vehicle stability when swerving on slippery road surfaces by controlling the brakes, engine output, and the movement of the front wheels.

### When the VSC/traction control are operating



If the vehicle is in danger of slipping, or if the front wheels (2WD models) or all wheels (AWD models) spin, the slip indicator light flashes to indicate that the VSC/traction control have been engaged.

A buzzer (intermittent) sounds to indicate that VSC is operating.

#### ■ Sounds and vibrations caused by the ABS, brake assist, VSC and traction control

- A sound may be heard from the engine compartment when the hybrid system is started or just after the vehicle begins to move. This sound does not indicate that a malfunction has occurred in any of these systems.
- Any of the following conditions may occur when the above systems are operating. None of these indicates that a malfunction has occurred.
  - Vibrations may be felt through the vehicle body and steering.
  - A motor sound may be heard after the vehicle comes to a stop.
  - The brake pedal may pulsate slightly after the ABS is activated.
  - The brake pedal may move down slightly after the ABS is activated.

#### ■ Reduced effectiveness of EPS

The effectiveness of EPS is reduced to prevent the system from overheating when there is frequent steering input over an extended period of time. The steering wheel may feel heavy as a result. Should this occur, refrain from excessive steering input or stop the vehicle and turn the hybrid system OFF. The system should return to normal within 10 minutes.

 **CAUTION**

Any of the following conditions may result in an accident which could cause death or serious injury:

■ **The ABS does not operate effectively when**

- The limits of tire gripping performance have been exceeded.
- The vehicle hydroplanes while driving at high speed on the wet or slick road.

■ **Stopping distance when the ABS is operating will exceed that of normal conditions**

The ABS is not designed to shorten the vehicle's stopping distance. Always maintain a safe distance from the vehicle in front of you in the following situations.

- When driving on dirt, gravel or snow-covered roads
- When driving with tire chains
- When driving over bumps in the road
- When driving over roads with potholes or roads with uneven roads

■ **Traction control may not operate effectively when**

Directional control and power may not be achievable while driving on slippery road surfaces, even if the traction control system is operating.

Do not drive the vehicle in conditions where stability and power may be lost.

### CAUTION

#### ■ **When the slip indicator flashes and a warning buzzer sounds**

This situation occurs immediately while VSC is activated. Always drive carefully. Reckless driving may cause an accident. Exercise particular care when the indicator light flashes and a buzzer sounds.

#### ■ **Replacing tires**

Make sure that all tires are of the same size, brand, tread pattern and total load capacity. In addition, make sure that the tires are inflated to the recommended tire pressure level.

The ABS and VSC systems will not function correctly if different tires are fitted on the vehicle.

Contact your Lexus dealer for further information when replacing tires or wheels.

#### ■ **Handling of tires and suspension**

Using tires with any kind of problem or modifying the suspension will affect the VDIM, and may cause the system to malfunction.

# Utility vehicle precautions

This vehicle belongs to the utility vehicle class, which has higher ground clearance and narrower tread in relation to the height of its center of gravity.

### Utility vehicle feature

- Specific design characteristics give it a higher center of gravity than ordinary passenger cars. This vehicle design feature causes this type of vehicle to be more likely to rollover. And, utility vehicles have a significantly higher rollover rate than other types of vehicles.
- It is not designed for cornering at the same speeds as ordinary passenger cars any more than low-slung sports cars designed to perform satisfactorily under off-road conditions. Therefore, sharp turns at excessive speeds may cause rollover.

### CAUTION

#### ■ Utility vehicle precautions

Always observe the following precautions to minimize the risk of serious personal injury or damage to your vehicle:

- In a rollover crash, an unbelted person is significantly more likely to die than a person wearing a seat belt. Therefore, the driver and all passengers should fasten their seat belts whenever the vehicle is moving.
- Avoid sharp turns or abrupt maneuvers, if at all possible.  
Failure to operate this vehicle correctly may result in loss of control or vehicle roll-over causing death or serious injury.
- Loading cargo on the roof luggage carrier will make the center of the vehicle gravity higher. Avoid high speeds, sudden starts, sharp turns, sudden braking or abrupt maneuvers, otherwise it may result in loss of control or vehicle rollover due to failure to operate this vehicle correctly.
- Always slow down in gusty crosswinds. Because of its profile and higher center of gravity, your vehicle is more sensitive to side winds than an ordinary passenger car. Slowing down will allow you to have better control.
- Do not drive horizontally across steep slopes. Driving straight up or straight down is preferred. Your vehicle (or any similar off-road vehicle) can tip over sideways much more easily than forward or backward.

## Off-road driving

Your vehicle is not designed to be driven off-road. However, in the event that off-road driving cannot be avoided, please observe the following precautions to help avoid the areas prohibited to vehicles.

- Drive your vehicle only in areas where off-road vehicles are permitted to travel.
- Respect private property. Get owner's permission before entering private property.
- Do not enter areas that are closed. Honor gates, barriers and signs that restrict travel.
- Stay on established roads. When conditions are wet, driving techniques should be changed or travel delayed to prevent damage to roads.
- Avoid driving on very steep, slippery roads and other surfaces, such as sand, where the tires are liable to lose traction. Your vehicle may not perform as well as conventional AWD on-road vehicles on these surfaces.

---

### ■ Additional information for off-road driving

► For owners in U.S. mainland, Hawaii and Puerto Rico:

To obtain additional information pertaining to driving your vehicle off-road, consult the following organizations.

- State and Local Parks and Recreation Departments
- State Motor Vehicle Bureau
- Recreational Vehicle Clubs
- U.S. Forest Service and Bureau of Land Management

### CAUTION

#### ■ Off-road driving precautions

Always observe the following precautions to minimize the risk of serious personal injury or damage to your vehicle:

- Drive carefully when off the road. Do not take unnecessary risks by driving in dangerous places.
- Do not grip the steering wheel spokes when driving off-road. A bad bump could jerk the wheel and injure your hands. Keep both hands and especially your thumbs on the outside of the rim.
- Always check your brakes for effectiveness immediately after driving in sand, mud, water or snow.
- After driving through tall grass, mud, rock, sand, rivers, etc., check that there is no grass, bush, paper, rags, stone, sand, etc. adhering or trapped on the underbody. Clear off any such matter from the underbody. If the vehicle is used with these materials trapped or adhering to the underbody, a breakdown or fire could occur.
- When driving off-road or in rugged terrain, do not drive at excessive speeds, jump, make sharp turns, strike objects, etc. This may cause loss of control or vehicle rollover causing death or serious injury. You are also risking expensive damage to your vehicle's suspension and chassis.

### NOTICE

#### ■ To prevent the water damage

Take all necessary safety measures to ensure that water damage to the hybrid battery, hybrid system or other components does not occur.

- Water entering the engine compartment may cause severe damage to the hybrid system. Water entering the interior may cause the hybrid battery stowed under the rear seats to short circuit.
- Water entering the hybrid transaxle will cause deterioration in transmission quality. The malfunction indicator may come on, and the vehicle may not be drivable.
- Water can wash the grease from wheel bearings, causing rusting and premature failure, and may also enter the transaxle case, reducing the gear oil's lubricating qualities.

 NOTICE**■ When you drive through water**

If driving through water, such as when crossing shallow streams, first check the depth of the water and the bottom of the river bed for firmness. Drive slowly and avoid deep water.

**■ Inspection after off-road driving**

- Sand and mud that has accumulated in brake drums and around brake discs may affect braking efficiency and may damage brake system components.
- Always perform a maintenance inspection after each day of off-road driving that has taken you through rough terrain, sand, mud, or water. For scheduled maintenance information, refer to the “Warranty and Services Guide/Owner’s Manual Supplement/Scheduled Maintenance”.

# Cargo and luggage

Take notice of the following information about storage precautions, cargo capacity and load.

- Stow cargo and luggage in the luggage compartment whenever possible. Be sure all items are secured in place.
- Be careful to keep the vehicle level. Placing the weight as far forward as possible helps maintain vehicle balance.
- For better fuel economy, do not carry unnecessary weight.

### Capacity and distribution

Cargo capacity depends on the total weight of the occupants.

(Cargo capacity) = (Total load capacity) – (Total weight of occupants)

#### Steps for Determining Correct Load Limit—

- (1) Locate the statement “The combined weight of occupants and cargo should never exceed XXX kg or XXX lbs.” on your vehicle’s placard.
- (2) Determine the combined weight of the driver and passengers that will be riding in your vehicle.
- (3) Subtract the combined weight of the driver and passengers from XXX kg or XXX lbs.
- (4) The resulting figure equals the available amount of cargo and luggage load capacity.  
For example, if the “XXX” amount equals 1400 lbs. and there will be five 150 lb passengers in your vehicle, the amount of available cargo and luggage load capacity is 650 lbs.  $(1400 - 750 (5 \times 150)) = 650$  lbs.)
- (5) Determine the combined weight of luggage and cargo being loaded on the vehicle. That weight may not safely exceed the available cargo and luggage load capacity calculated in Step 4.

- (6) If your vehicle will be towing a trailer, load from your trailer will be transferred to your vehicle. Consult this manual to determine how this reduces the available cargo and luggage load capacity of your vehicle.

### Example on your vehicle

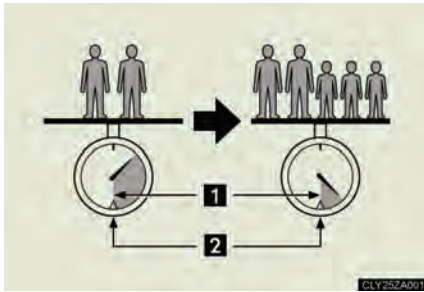

- 1 Cargo capacity
- 2 Total load capacity

When 2 people with the combined weight of 366 lb. (166 kg) are riding in your vehicle, which has a total load capacity of 925 lb. (420 kg), the available amount of cargo and luggage load capacity will be as follows:

$$925 \text{ lb.} - 366 \text{ lb.} = 559 \text{ lb.} \quad (420 \text{ kg} - 166 \text{ kg} = 254 \text{ kg})$$

In this condition, if 3 more passengers with the combined weight of 388 lb. (176 kg) get on, the available cargo and luggage load will be reduced as follows:

$$559 \text{ lb.} - 388 \text{ lb.} = 171 \text{ lb.} \quad (254 \text{ kg} - 176 \text{ kg} = 78 \text{ kg})$$

As shown in the above example, if the number of occupants increases, the cargo and luggage load equaling the combined weight of the occupants who got on later, by an amount. In other words, if an increase in the number of occupants causes an excess of the total load capacity (combined weight of occupants plus cargo and luggage load), you must reduce the cargo and luggage on your vehicle.

### CAUTION

#### ■ Storage precautions

- Do not place anything on the luggage cover, and do not stack anything in the luggage compartment higher than the seatbacks. Such items may be thrown about and possibly injure people in the vehicle during sudden braking or in an accident.
- Do not drive with objects on top of the instrument panel. They may interfere with the driver's field of view or move during sharp acceleration or turning, thus impairing the driver's control of the vehicle. In an accident they may injure the vehicle occupants.
- Secure all items in the occupant compartment, as they may shift and injure someone during an accident or sudden braking.
- Never allow anyone to ride in the luggage compartment. It is not designed for passengers. They should ride in their seats with their seat belts properly fastened. Otherwise, they are much more likely to suffer serious bodily injury, in the event of sudden braking or a collision.

#### ■ Capacity and distribution

- Improper loading may cause deterioration of steering or braking control resulting in an accident which may cause death or serious injury.
- Do not exceed the maximum axle weight rating or the total vehicle weight rating.
- Even if the total load of occupant's weight and the cargo load is less than the total load capacity, do not apply the load unevenly.

## 2-5. Driving information

# Vehicle load limits

Vehicle load limits include total load capacity, seating capacity, towing capacity and cargo capacity.

### ■ Total load capacity: 925 lb. (420 kg)

Total load capacity means the combined weight of occupants, cargo and luggage.

### ■ Seating capacity: 5 occupants (Front 2, Rear 3)

Seating capacity means the maximum number of occupants whose estimated average weight is 150 lb. (68 kg) per person.

Even if the number of occupants are within the seating capacity, do not exceed the total load capacity.

### ■ Towing capacity

**Without towing package: 2000 lb. (907 kg)**

**With towing package: 3500 lb. (1588 kg)**

Towing capacity means the maximum gross trailer weight (trailer weight plus its cargo weight) that your vehicle is able to tow.

### ■ Cargo capacity

Cargo capacity may increase or decrease depending on the weight and the number of occupants.

### ■ Total load capacity and seating capacity

These details are also described on the tire and loading information label. (→P. 348)

### CAUTION

#### ■ Overloading the vehicle

Do not overload the vehicle.

It may not only cause damage to the tires, but also degrade steering and braking ability, resulting in an accident.

# Winter driving tips

Carry out the necessary preparations and inspections before driving the vehicle in winter. Always drive the vehicle in a manner appropriate to the prevailing weather conditions.

### ■ Pre-winter preparations

- Use fluids that are appropriate to the prevailing outside temperatures.
  - Engine oil
  - Engine/power control unit coolant
  - Washer fluid
  - Have a service technician inspect the level and specific gravity of battery electrolyte.
- Have the vehicle fitted with four snow tires or purchase a set of tire chains for the front tires.

Ensure that all tires are the same size and brand, and that chains match the size of the tires.

- Tire pressure falls in winter as the outside temperature falls. Add 2.9 to 4.3 psi (20 to 30 kPa, 0.2 to 0.3 kgf/cm<sup>2</sup> or bar) to the standard tire inflation pressure.

### ■ Before driving the vehicle

Perform the following according to the driving conditions.

- Do not try to forcibly open a window or move a wiper that is frozen. Pour warm water over the frozen area to melt the ice. Wipe away the water immediately to prevent it from freezing.
- To ensure proper operation of the climate control system fan, remove any snow that has accumulated on the air inlet vents in front of the windshield.
- Remove any ice that has accumulated on the vehicle chassis.
- Periodically check for and remove any excess ice or snow that may have accumulated in the wheel well or on the brakes.

### ■ When driving the vehicle

Accelerate the vehicle slowly and drive at a reduced speed suitable to road conditions.

### ■ When parking the vehicle

Park the vehicle and move the shift lever to P without setting the parking brake. The parking brake may freeze up, preventing it from being released.

### Selecting snow chains

Use the correct snow chain size when mounting the snow chains. Chain size is regulated for each tire sizes.

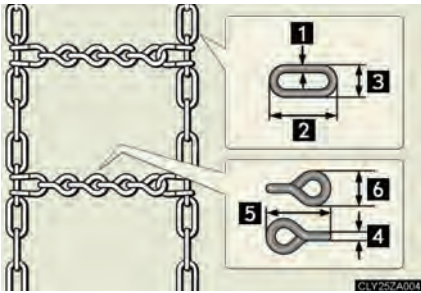

#### Side chain

- 1 0.12 in. (3 mm) in diameter
- 2 1.18 in. (30 mm) in length
- 3 0.39 in. (10 mm) in width

#### Cross chain

- 4 0.16 in. (4 mm) in diameter
- 5 0.98 in. (25 mm) in length
- 6 0.55 in. (14 mm) in width

### Regulations on the use of snow chains

- Regulations regarding the use of tire chains vary according to location and type of road. Always check local regulations before installing chains.
- Install the chains on the front tires.
- Retighten the chains after driving 1/4 - 1/2 mile (0.5 - 1.0 km).

### ■ Snow chain installation

Observe the following precautions when installing and removing chains.

- Install and remove tire chains in a safe location.
- Install tire chains on the front tires only. Do not install tire chains on rear tires.
- Install tire chains following the instructions provided in the accompanying instructions.

### CAUTION

#### ■ Driving with snow tires

Observe the following precautions to reduce the risk of accidents.

Failing to do so may result in a loss of vehicle control and cause death or serious injury.

- Use tires of the size specified for your vehicle.
- Maintain the recommended level of air pressure.
- Do not drive in excess of 75 mph (120 km/h), regardless of the type of snow tires being used.
- Use snow tires on all, not just some wheels.

#### ■ Driving with snow chains

Observe the following precautions to reduce the risk of accidents.

Failing to do so may result in the vehicle being unable to be driven safely, and may cause death or serious injury.

- Do not drive in excess of the speed limit specified for the tire chains being used, or 30 mph (50 km/h), whichever is lower.
- Avoid driving on bumpy road surfaces or over potholes.
- Avoid sudden turns and braking, as use of chains may adversely affect vehicle handling.
- Slow down sufficiently before entering a curve to ensure that vehicle control is maintained.

### NOTICE

#### ■ **Repairing or replacing snow tires**

Request repairs of and obtain replacement snow tires from Lexus dealers or legitimate tire retailers.

This is because the removal and attachment of snow tires affects the operation of the tire air pressure sensor.

#### ■ **Fitting tire chains**

The tire air pressure sensor may not function correctly when tire chains are fitted.

# Trailer towing (if equipped)

Your vehicle is designed primarily as a passenger-and-load carrying vehicle. Towing a trailer will have an adverse effect on handling, performance, braking, durability, and fuel consumption. For your safety and the safety of others, do not overload the vehicle or trailer.

Lexus warranties do not apply to damage or malfunction caused by towing a trailer for commercial purposes.

### ■ Weight limits

Confirm that the total trailer weight, gross vehicle weight, gross axle weight and trailer tongue load are all within the limits.

### ■ Gross vehicle weight

The gross vehicle weight must not exceed the Gross Vehicle Weight Rating (GVWR) indicated on the Certification Label. The gross vehicle weight is the sum weight of the unloaded vehicle, driver, passengers, luggage, hitch and trailer tongue load. Also included is the weight of any special equipment installed on your vehicle.

### ■ Gross axle weight

The load on either the front or rear axle resulting from distribution of the gross vehicle weight on both axles must not exceed the Gross Axle Weight Rating (GAWR) listed on the Certification Label.



Certification Label

### ■ Trailer tongue load

The trailer cargo load should be distributed so that the tongue load is 9 to 11% of the total trailer weight, not exceeding the following.

Without towing package: 200 lb. (90 kg)

With towing package: 350 lb. (158 kg)

(Tongue load / Total trailer weight x 100 = 9 to 11%)

The total trailer weight and tongue load can be measured with platform scales found at a highway weighing stations, building supply companies, trucking companies, junk yards, etc.

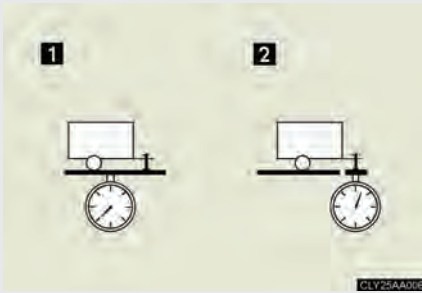

1 Total trailer weight

2 Tongue load

### Towing a trailer

Contact your Lexus dealer for further information about additional requirements such as a towing kits, etc.

### Hitch and tow hitch receiver

#### ■ Hitch

Trailer hitch assemblies have different weight capacities established by the hitch manufacturer. Even though the vehicle may be rated for towing a higher weight, the operator must never exceed the maximum weight rating specified for the trailer hitch.

## ■ Tow hitch receiver



A tow hitch receiver installed under the rear bumper is rated for weight that does not exceed the vehicle's total towing weight.

## Selecting trailer ball

Use the correct trailer ball for your application.

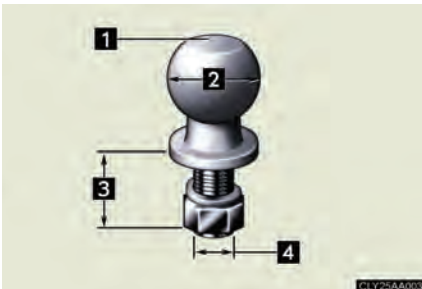

### 1 Trailer ball load rating

Matches or exceeds the gross trailer weight rating of the trailer.

### 2 Ball diameter

Matches the size of the trailer coupler. Most couplers are stamped with the required trailer ball size.

### 3 Shank length

Protrudes beyond the bottom of the lock washer and nut at least 2 threads.

### 4 Shank diameter

Matches the ball mount hole diameter size.

## Connecting trailer lights

- ▶ With tow hitch receiver  
Use the socket located under the rear bumper.
- ▶ Without tow hitch receiver  
Use the wire harness stored in the rear end under body.

## ■ Front Emblem



- 1** With towing package
- 2** Without towing package

On vehicles with a towing package, the front emblem has openings, which are designed to improve the cooling performance.

## ■ Before towing

Check that the following conditions are met:

- The vehicle's tires are properly inflated. (→P. 348)
- Trailer tires are inflated according to the trailer manufacturer's recommendation.
- All trailer lights work
- All lights work each time you connect them.
- The trailer ball is set up at the proper height for the coupler on the trailer.
- The vehicle remains level when a loaded or unloaded trailer is hitched. Do not drive if the vehicle is not level, and check for improper tongue load, overloading, worn suspension, or other possible causes.
- The trailer cargo is securely loaded.
- The rear view mirrors conform to all applicable federal, state/provincial or local regulations. If they do not, install rear view mirrors appropriate for towing purposes.

### ■ Break-in schedule

Lexus recommends that you do not use a new vehicle or a vehicle with any new power train components (engine, transmission, differential, wheel bearings, etc.) to tow a trailer for the first 500 miles (800 km) of driving.

### ■ Maintenance

- If you tow a trailer, your vehicle will require more frequent maintenance due to the additional load. (See “Warranty and Services Guide/ Owner’s Manual Supplement/ Scheduled Maintenance”.)
- Retighten the fixing bolts of the towing ball and bracket after approximately 600 miles (1000 km) of trailer towing.

### CAUTION

#### ■ To avoid accident or injury

- The total trailer weight (trailer weight plus the weight of cargo) must not exceed the following.
  - Without towing package: 2000 lb. (907 kg)
  - With towing package: 3500 lb. (1588 kg)
- If a trailer and cargo weigh over 2000 lb. (907 kg), use a sway control device with sufficient capacity.
- The gross combined weight (sum of your vehicle weight plus its load and the total trailer weight) must not exceed the following.
  - Without towing package: 7265 lb. (3295 kg)
  - With towing package: 8765 lb. (3976 kg)
- Do not exceed the trailer hitch assembly weight, gross vehicle weight, gross axle weight and trailer tongue load capacities.
- Never load more weight in the back than in the front of the trailer. About 60% of the load should be in the front half of the trailer, and the remaining 40% in the rear.
- The tow hitch receiver installed on your vehicle must never be used on another vehicle.

### CAUTION

#### ■ Hitches

- If you wish to install a trailer hitch, contact your Lexus dealer.
- Use only a hitch that conforms to the total trailer weight requirement.
- Follow the directions supplied by the hitch manufacturer.
- Lubricate the hitch ball with a light coat of grease.
- Remove the trailer hitch whenever you are not towing a trailer. After removing the hitch, seal any mounting hole in the vehicle body to prevent entry of any substances into the vehicle.

#### ■ When towing a trailer

- If the total trailer weight exceeds 1000 lb. (450 kg), trailer brakes are required.
- Never tap into your vehicle's hydraulic system, as this will lower the vehicle's braking effectiveness.
- Never tow a trailer without using a safety chain securely attached to both the trailer and the vehicle. If damage occurs to the coupling unit or hitch ball, there is danger of the trailer wandering into another lane.

### NOTICE

#### ■ When installing a trailer hitch

- Use only the position recommended by your Lexus dealer. Do not install the trailer hitch on the bumper; this may cause body damage.
- Do not use axle-mounted hitches, as they can cause damage to the axle housing, wheel bearings, wheels or tires.

#### ■ Brakes

Lexus recommends trailers with brakes that conform to all applicable federal and state/provincial regulations.

 NOTICE**■ Safety chain**

A safety chain must always be used between the towing vehicle and the trailer. Leave sufficient slack in the chain for turns. The chain should cross under the trailer tongue to prevent the tongue from dropping to the ground in the case that it becomes damaged or separated. For the correct safety chain installation procedure, ask your Lexus dealer.

**■ Do not directly splice trailer lights**

Directly splicing trailer lights may damage your vehicle's electrical system and cause a malfunction.

**Trailer towing tips**

Your vehicle will handle differently when towing a trailer. The 3 main causes of vehicle-trailer accidents are driver error, excessive speed and improper trailer loading. Keep the following in mind when towing.

- Before starting out, check the trailer lights and the vehicle-trailer connections. Recheck after driving a short distance.
- Practice turning, stopping and reversing with the trailer attached in an area away from traffic until you become accustomed to the feel of the vehicle.
- Reversing with a trailer attached is difficult and requires practice. Grip the bottom of the steering wheel and move your hand to the left to move the trailer to the left. Move your hand to the right to move the trailer to right. (This is generally opposite to reversing without a trailer attached.) Avoid sharp or prolonged turning. Have someone guide you when reversing to reduce the risk of an accident.
- As stopping distance is increased when towing a trailer, vehicle-to-vehicle distance should be increased. For each 10 mph (16 km/h) of speed, allow at least one vehicle and trailer length.

- Avoid sudden braking as you may skid, resulting in jackknifing and loss of control. This is especially true on wet or slippery surfaces.
- Avoid jerky starts or sudden acceleration.
- Avoid jerky steering and sharp turns, and slow down before making turns.
- Note that when making a turn, the trailer wheels will be closer than the vehicle wheels to the inside of the turn. Compensate by making a larger than normal turning radius.
- Crosswinds and rough roads will adversely affect handling of your vehicle and trailer, causing sway. Periodically check the rear to prepare for being passed by large trucks or buses, which may cause your vehicle and trailer to sway. If swaying occurs, firmly grip the steering wheel, reduce speed immediately but gradually, and steer straight ahead. Never increase speed. If you make no extreme correction with the steering or brakes, your vehicle and trailer will stabilize.
- Take care when passing other vehicles. Passing requires considerable distance. After passing a vehicle, do not forget the length of your trailer, and be sure you have plenty of room before changing lanes.
- Due to the added load of the trailer, your vehicle's hybrid system may overheat on hot days (at temperatures over 85°F [30°C]) when driving up a long or steep grade. If the coolant temperature gauge indicates overheating, immediately turn off the air conditioning (if in use), pull your vehicle off the road and stop in a safe spot. (→P. 432)

- Always place wheel blocks under both the vehicle and the trailer wheels when parking. Apply the parking brake firmly, and put the transmission in P. Avoid parking on a slope, but if unavoidable, do so only after performing the following:

**STEP 1** Apply the brakes and keep them applied.

**STEP 2** Have someone place wheel blocks under both the vehicle and trailer wheels.

**STEP 3** When the wheel blocks are in place, release the brakes slowly until the blocks absorb the load.

**STEP 4** Apply the parking brake firmly.

**STEP 5** Shift into P and turn off the hybrid system.

- When restarting after parking on a slope:

**STEP 1** With the transmission in the P position, start the hybrid system. Be sure to keep the brake pedal pressed.

**STEP 2** Shift into D or the R position (if reversing).

**STEP 3** Release the parking brake and brake pedal, and slowly pull or back away from the wheel blocks. Stop and apply the brakes.

**STEP 4** Have someone retrieve the blocks.

### CAUTION

#### ■ To avoid an accident

- Do not exceed 45 mph (72 km/h) or the posted towing speed limit, whichever is lower. As instability (swaying) of the towing vehicle-trailer combination increases as speed increases, exceeding 45 mph (72 km/h) may cause loss of control.
- Slow down and downshift before descending steep or long downhill grades. Do not make sudden downshifts.
- Avoid holding the brake pedal down too long or applying the brakes too frequently. This could cause the brakes to overheat and result in reduced braking efficiency.

## 2-5. Driving information

### Dinghy towing

Your vehicle is not designed to be dinghy towed (with four wheels on the ground) behind a motor home.

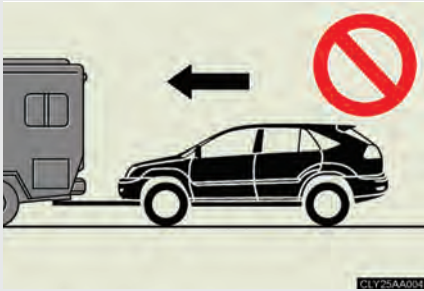

#### NOTICE

**■ To avoid serious damage to your vehicle**

Do not tow your vehicle with four wheels on the ground.

- 3-1. Using the air conditioning system and defogger** ..... 206
- Automatic air conditioning system ..... 206
  - Rear window and outside rear view mirror defoggers, and windshield wiper de-icer ..... 212
- 3-2. Using the front audio system** ..... 213
- Audio system type ..... 213
  - Using the radio ..... 215
  - Using the CD player ..... 222
  - Playing back MP3 and WMA discs ..... 228
  - Optimal use of the audio system ..... 236
  - Using the steering wheel audio switches ..... 239
- 3-3. Using the rear audio system** ..... 241
- Rear seat entertainment system features ..... 241
  - Using the DVD player (DVD video) ..... 247
  - Using the DVD player (video CD) ..... 254
  - Using the DVD player (audio CD/ CD text) ..... 256
  - Using the DVD player (MP3 discs) ..... 257
  - Using the video mode ..... 259
- Changing the initial setting ..... 261
- 3-4. Using the interior lights** ..... 268
- Interior lights list ..... 268
  - Interior lights ..... 271
  - Personal lights ..... 272
- 3-5. Using the storage features** ..... 273
- List of storage features ..... 273
  - Glove box ..... 273
  - Console boxes ..... 274
  - Coin holder ..... 276
  - Overhead console ..... 277
  - Cup holders ..... 277
  - Door pockets ..... 279
- 3-6. Other interior features** ..... 280
- Sun visors ..... 280
  - Vanity mirror ..... 281
  - Clock ..... 282
  - Outside temperature display ..... 283
  - Multi-display light control ..... 284
  - Power outlets ..... 285
  - Seat heaters ..... 288
  - Armrest ..... 290
  - Floor mat ..... 291
  - Luggage compartment features ..... 292
  - Garage door opener ..... 295
  - Compass ..... 300

### 3-1. Using the air conditioning system and defogger

## Automatic air conditioning system

Airflow and outlets are automatically adjusted according to the temperature setting.

► With navigation system

Owners of models equipped with a navigation system should refer to the "Navigation System Owner's Manual".

► Without navigation system

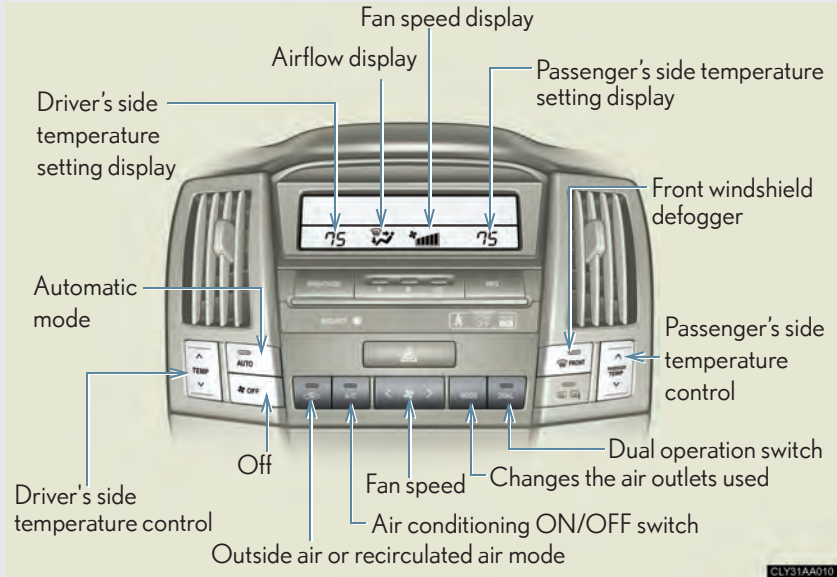

## Using the automatic mode

**STEP 1** Press .

➔ The air conditioning system will begin to operate. According to the temperature setting, air outlets and fan speed are automatically adjusted, and the mode automatically switches between outside air and recirculated air modes.



**STEP 2** Press  $\wedge$  to increase the temperature and  $\vee$  to decrease the temperature on the .

The temperature for the driver and passenger seats can be set separately.

## Adjusting the settings

### ■ Adjusting the temperature setting

Press  $\wedge$  to increase the temperature and  $\vee$  to decrease the temperature on the .

Press  $\wedge$  (increase) or  $\vee$  (decrease) on the  to separately adjust the temperature for the passenger and driver sides (dual mode). Press  to return the driver and passenger side temperatures to the same setting (simultaneous mode).

The air conditioning system switches between individual and simultaneous modes each time  is pressed.

### ■ Adjusting the fan speed

Press  $>$  (increase) or  $<$  (decrease) on the .

Press  to turn the fan off.

### ■ Changing the air outlets



Press  .

The air outlets switch each time the button is pressed.

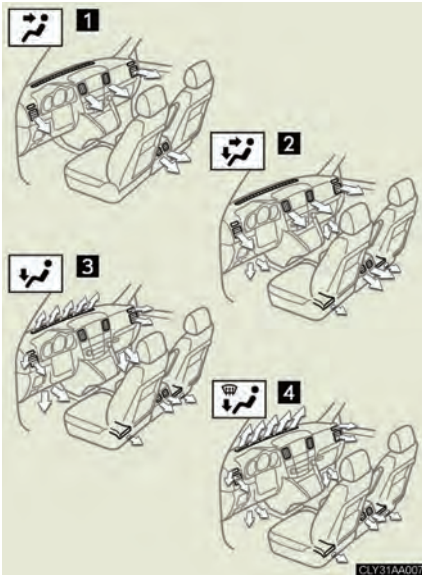

- 1 Air flows to the upper body.
- 2 Air flows to the upper body and feet.
- 3 Air flows to the feet.
- 4 Air flows to the feet and the front windshield defogger operates.

If recirculated air mode is selected, press  to switch to outside air mode.

### ■ Switching between outside air and recirculated air modes

Press  .

The mode switches between outside air mode (indicator OFF) and recirculated air mode (indicator ON) modes each time the button is pressed.

## Defogging the front windshield

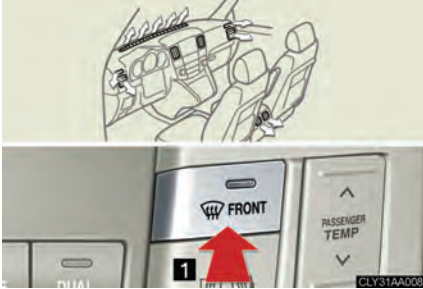

### 1 Defogging

The air conditioning system control operates automatically.

Recirculated air mode will automatically switch to outside air mode. It is not possible to return to recirculated air mode when the switch is on.

## Adjusting the position of and opening and closing the air outlets

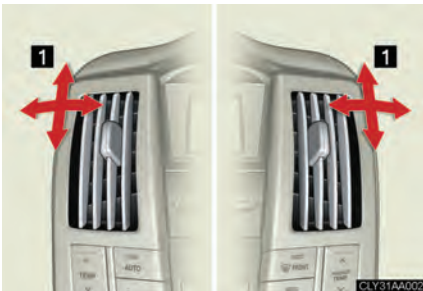

### ► Front outlets (center)

- 1 Direct air flow to the left or right, up or down

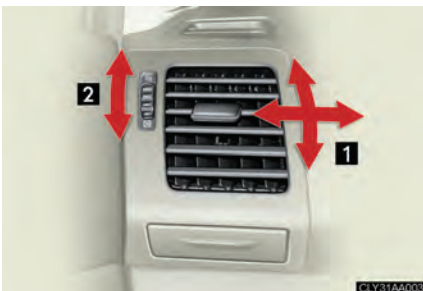

### ► Front outlets (right and left side)

- 1 Direct air flow to the left or right, up or down
- 2 Turn the knob up to open the vent and down to close the vent

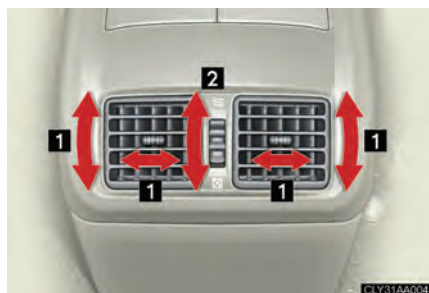

### ► Rear outlets

- 1 Direct air flow to the left or right, up or down
- 2 Turn the knob up to open the vent and down to close the vent

### ■ Using the automatic mode

Fan speed is adjusted automatically in accordance with the temperature setting and ambient conditions. As a result, the following may occur.

- The system may switch automatically to recirculated air mode when the coolest temperature setting is selected in summer.
- Immediately after the switch is pressed, the fan may stop for a while until warm or cool air is ready to flow.
- Cool air may flow to the area around the upper body when the heater is on.

### ■ Using the system in recirculated air mode

The windows will fog up more easily if the recirculated air mode is used for an extended period.

### ■ Window defogger feature

Recirculated air mode may automatically switch to outside air mode in situations where the windows need to be defogged.

### ■ Outside air temperature approaches 32°F (0°C).

The air conditioning system may not operate even when  is pressed.

### ■ When the indicator light on flashes

Press  and turn off the air conditioning system before turning it on once more. There may be a problem in the air conditioning system if the indicator light continues to flash. Turn the air conditioning system off and have it inspected by your Lexus dealer.

 CAUTION

■ To prevent the windshield from fogging up

Do not use  during cool air operation in extremely humid weather. The difference between the temperature of the outside air and that of the windshield can cause the outer surface of the windshield to fog up, blocking your vision.

 NOTICE

■ To prevent 12-volt battery discharge

Do not leave the automatic air conditioning system on longer than necessary when the hybrid system is off.

### 3-1. Using the air conditioning system and defogger

#### Rear window and outside rear view mirror defoggers, and windshield wiper de-icer

Defoggers are used to defog the rear window, and to remove raindrops, dew and frost from the outside rear view mirrors. De-icer\* is used to prevent ice from building up on the windshield and wiper blades.

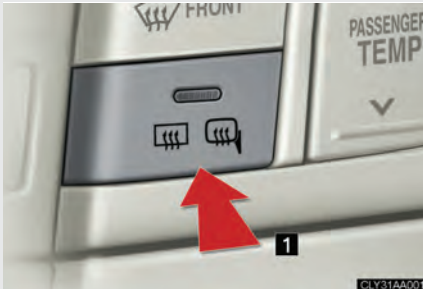

#### 1 ON/OFF

The defoggers and de-icer will automatically turn off after approximately 15 minutes.

\*: Vehicles for Canada only

#### ■ The defogger and de-icer can be operated when

The engine switch must be in the ON position.

#### ⚠ CAUTION

#### ■ When the outside rear view mirror defoggers are on

Do not touch the outside surface of the rear view mirror, as it can become very hot and burn you.

#### ■ When the windshield wiper de-icer is on

Do not touch the glass at the lower part of the windshield or to the side of the front pillars as the surfaces can become very hot and burn you.

## 3-2. Using the front audio system

### Audio system type

▶ With navigation system

Owners of models equipped with a navigation system should refer to the “Navigation System Owner’s Manual”.

▶ Without navigation system

CD player with changer and AM/FM radio



C1Y32AA013

| Title                                   | Page   |
|---|--------|
| Using the radio                         | P. 215 |
| Using the CD player                     | P. 222 |
| Playing back MP3 and WMA discs          | P. 228 |
| Optimal use of the audio system         | P. 236 |
| Using the steering wheel audio switches | P. 239 |

### ■ Using cellular phones

Interference may be heard through the audio system's speakers if a cellular phone is being used inside or close to the vehicle while the audio system is operating.

### CAUTION

#### ■ For vehicles sold in U.S.A. and Canada

##### ● Part 15 of the FCC Rules

FCC Warning:

Any unauthorized changes or modifications to this equipment will void the user's authority to operate this device.

##### ● Laser products

- Do not take this unit apart or attempt to make any changes yourself.

This is an intricate unit that uses a laser pickup to retrieve information from the surface of compact discs. The laser is carefully shielded so that its rays remain inside the cabinet. Therefore, never try to disassemble the player or alter any of its parts since you may be exposed to laser rays and dangerous voltages.

- This product utilizes a laser.

Use of controls or adjustments or performance of procedures other than those specified herein may result in hazardous radiation exposure.

### NOTICE

#### ■ To prevent 12-volt battery discharge

Do not leave the audio system on longer than necessary with the hybrid system off.

#### ■ To avoid damaging the audio system



Take care not to spill drinks or other fluids over the audio system.

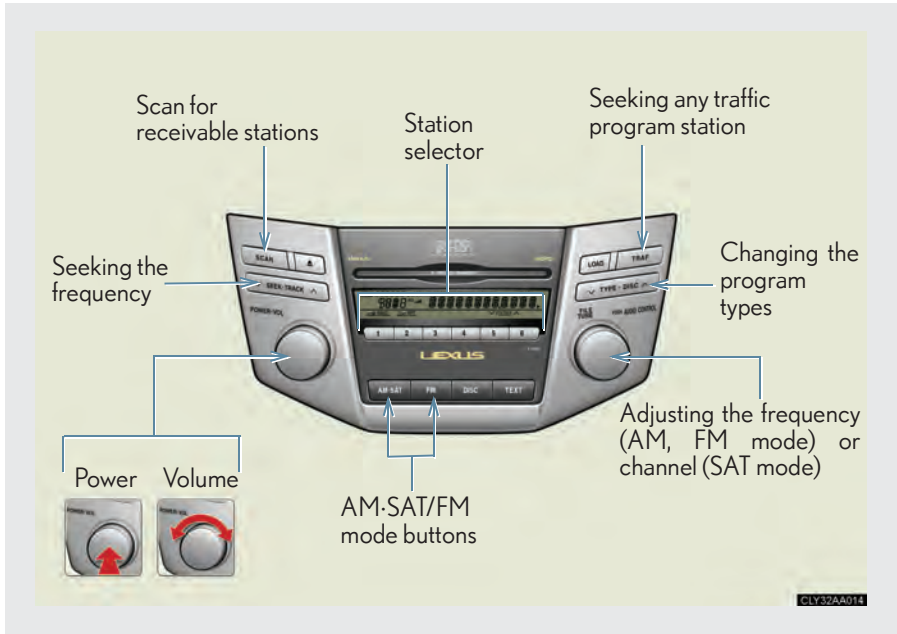

## 3-2. Using the front audio system

# Using the radio



### Setting station presets (excluding XM<sup>®</sup> Satellite Radio)

**STEP 1** Search for desired stations by turning  or pressing  $\wedge$  or  $\vee$  on .

**STEP 2** Press and hold the button (from  to ) the station is to be set to, and you hear a beep.

### Scanning radio stations (excluding XM<sup>®</sup> Satellite Radio)

#### ■ Scanning the preset radio stations

**STEP 1** Press and hold  until you hear a beep.  
Preset stations will be played for 5 seconds each.

**STEP 2** When the desired station is reached, press the button once again.

### ■ Scanning all radio stations within range

**STEP 1** Press .

All stations with reception will be played for 5 seconds each.

**STEP 2** When the desired station is reached, press the button once again.

### RDS (Radio Data System)

This feature allows your radio to receive station identification information and program information (classical, jazz, etc.) from radio stations which broadcast this information.



### ■ Receiving RDS broadcasts

**STEP 1** Press  $\wedge$  or  $\vee$  on  during FM reception.

The type of program changes each time the button is pressed.

- ROCK
- EASYLIS (Easy listening)
- CLS/JAZZ (Classical music and Jazz)
- R & B (Rhythm and Blues)
- INFORM (Information)
- RELIGION
- MISC (Miscellaneous)
- ALERT (Emergency messages)

If the system receives no RDS stations, NO PTY appears on the display.

**STEP 2** Press , or  $\wedge$  or  $\vee$  on .

The radio seeks or scans the station by the relevant program type.



### ■ Displaying radio station names

Press .

### ■ Displaying radio text messages

Press  twice.

If MSG is shown on the display, a text message will be displayed.

If the text continues past the end of the display,  is displayed. Press and hold  until you hear a beep.





## XM<sup>®</sup> Satellite Radio (if equipped)

### ■ Receiving XM<sup>®</sup> Satellite Radio



**STEP 1** Press  until SAT is shown on the display.

The display changes as follows each time the button is pressed.

AM → SAT1 → SAT2 → SAT3

**STEP 2** Turn  to select the desired channel in the all categories or press  or  on  to select the desired channel in the current category.

### ■ Setting XM<sup>®</sup> Satellite Radio channel presets

Select the desired channel. Press and hold the button (from  to ) the channel is to be set to, and you hear a beep.

### ■ Changing the channel category

Press  or  on .

### ■ Scanning XM<sup>®</sup> Satellite Radio channels

● Scanning channels in the current category

**STEP 1** Press .

**STEP 2** When the desired channel is reached, press the button again.

### ● Scanning preset channels

**STEP 1** Press and hold  until you hear a beep.

**STEP 2** When the desired channel is reached, press the button again.

### ■ Displaying text information

Press .

The display will show up to 10 characters.

The display changes as follows each time the button is pressed.

- CH NAME
- TITLE (SONG/PROGRAM TITLE)
- NAME (ARTIST NAME/FEATURE)
- CH NUMBER

### ■ When the 12-volt battery is disconnected

Station presets are erased.

### ■ Radio antenna type

- Detachable antenna

To remove a detachable antenna, carefully turn it counterclockwise.

- Wire antenna

The radio antenna is mounted inside the rear window.

### ■ Reception sensitivity

- Maintaining perfect radio reception at all times is difficult due to the continually changing position of the antenna, differences in signal strength and surrounding objects, such as trains, transmitters, etc.

- To maintain clear radio reception, do not attach metallic window tinting or other metallic objects to the antenna wire mounted inside the rear window.

### ■ Receiving XM<sup>®</sup> Satellite Radio

An XM<sup>®</sup> Satellite Radio is a tuner designed exclusively to receive broadcasts provided under a separate subscription. Availability is limited to the 48 contiguous states and 10 Canadian provinces.

- XM<sup>®</sup> subscriptions

For detailed information about XM<sup>®</sup> Satellite Radio or to subscribe:  
U.S.A. —

Visit on the web at [www.xmradio.com](http://www.xmradio.com) or call 1-877-515-3987.

Canada —

Visit on the web at [www.xmradio.ca](http://www.xmradio.ca) or call 1-877-438-9677.

- Radio ID

You will need the radio ID when activating XM<sup>®</sup> service or reporting a problem.

Select “CH000” using , and the receiver's 8-character ID number will

appear.

- Satellite tuner

The tuner supports only Audio Services (Music and Talk) and the accompanying Text Information of XM<sup>®</sup> Satellite Radio.

\*: Terms and services provided by XM<sup>®</sup> Satellite Radio are subject to change without notice.

### ■ If the satellite radio does not operate normally

If a problem occurs with the XM<sup>®</sup> tuner, a message will appear on the display. Refer to the table below to identify the problem, and take the suggested corrective action.

|           |  |
|-----------|--|
| ANTENNA   | The XM <sup>®</sup> antenna is not connected. Check whether the XM <sup>®</sup> antenna cable is attached securely.  |
|           | There is a short-circuit in the antenna or the surrounding antenna cable. See a Lexus certified dealer.  |
| UPDATING  | You have not subscribed to the XM <sup>®</sup> Satellite Radio. The radio is being updated with the latest encryption code. Contact the XM <sup>®</sup> Satellite Radio for subscription information. When a contract is canceled, you can choose the "CH000" and all free-to-air channels.      |
|           | The premium channel you selected is not authorized. Wait for about 2 seconds until the radio returns to the previous channel or "CH001". If it does not change automatically, select another channel. If you want to listen to the premium channel, contact the XM <sup>®</sup> Satellite Radio. |
| NO SIGNAL | The XM <sup>®</sup> signal is too weak at the current location. Wait until your vehicle reaches a location with a stronger signal.   |
| LOADING   | The unit is acquiring audio or program information. Wait until the unit has received the information.  |
| OFF AIR   | The channel you selected is not broadcasting any programming. Select another channel.  |
| -----     | There is no song/program title or artist name/feature associated with the channel at that time. No action needed.  |

---

The channel you selected is no longer available. Wait for about 2 seconds until the radio returns to the previous channel or “CH001”. If it does not change automatically, select another channel.

Contact the XM<sup>®</sup> Listener Care Center at 1-877-515-3987 (U.S.A.) or 1-877-438-9677 (Canada).

### ■ Certifications for the radio tuner

This equipment has been tested and found to comply with the limits for a class B digital device, pursuant to Part 15 of the FCC Rules. These limits are designed to provide reasonable protection against harmful interference in a residential installation. This equipment generates, uses and can radiate radio frequency energy and, if not installed and used in accordance with the instructions, may cause harmful interference to radio communications. However, there is no guarantee that interference will not occur in a particular installation.

If this equipment does cause harmful interference to radio or television reception, which can be determined by turning the equipment off and on, the user is encouraged to try to correct the interference by trying one or more of the following:

- Reorienting or relocate the receiving antenna.
- Increasing the separation between the equipment and receiver.
- Connecting the equipment into an outlet on a circuit different from that to which the receiver is connected.
- Consulting the dealer or an experienced radio/TV technician for help.

## 3-2. Using the front audio system

### Using the CD player

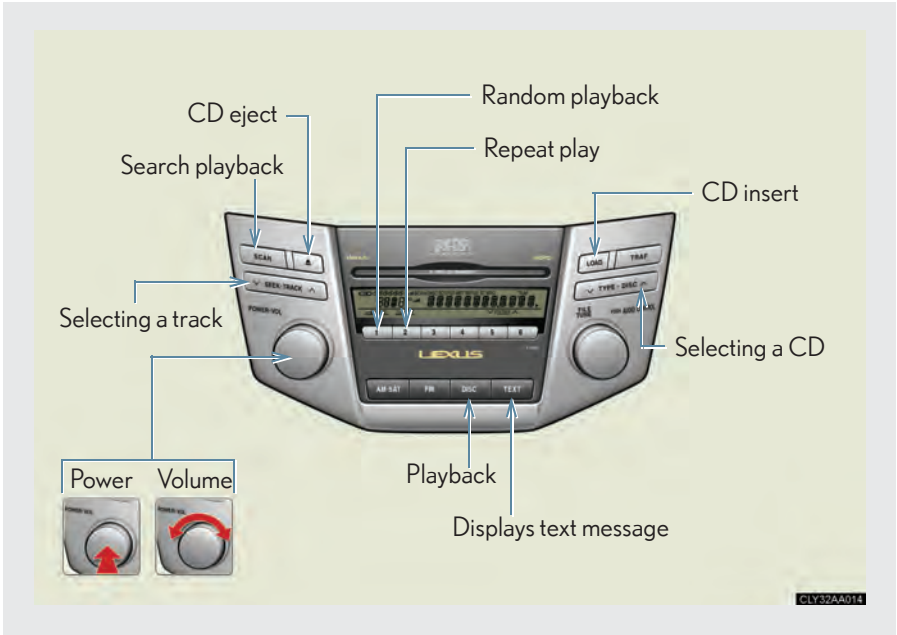

## Loading CDs

### ■ Loading a CD

**STEP 1** Press  .

WAIT is shown on the display.

**STEP 2** Insert a CD when the indicator on the slot turns from amber to green.

The display changes from WAIT to LOAD.

### ■ Loading multiple CDs

**STEP 1** Press and hold  until you hear a beep.

WAIT is shown on the display.

**STEP 2** Insert a CD when the indicator on the slot turns from amber to green.

The display changes from WAIT to LOAD.

The indicator on the slot turns to amber when the CD is inserted.

**STEP 3** Insert the next CD when the indicator on the slot turns from amber to green again.

Repeat the procedure for the remaining CDs.

To stop the operation, press .

## Ejecting CDs

### ■ Ejecting a CD

**STEP 1** To select the CD to be ejected, press  $\wedge$  or  $\vee$  on .

The number of the CD selected is shown on the display.

**STEP 2** Press  and remove the CD.

### ■ Ejecting all the CDs

Press and hold  until you hear a beep, and then remove the CDs.

## Selecting, fast-forwarding, rewind, and scanning tracks

### ■ Selecting a track

Press  $\wedge$  to move up and  $\vee$  to move down using  until the desired track number is displayed.

To fast-forward or rewind, press and hold  $\wedge$  or  $\vee$  on .

### ■ Scanning a CD

**STEP 1** Press .

The first ten seconds of each track will be played.

**STEP 2** Press the switch again when the desired track is reached.

### Selecting a CD

#### ■ To select a CD to play

To select the desired CD, press  $\wedge$  or  $\vee$  on .

#### ■ To scan loaded CDs

**STEP 1** Press and hold  until you hear a beep.

The first ten seconds of the first track on each CD will be played.

**STEP 2** Press the button again when the desired CD is reached.

### Repeat play

#### ■ To repeat a track

Press  (RPT).

#### ■ To repeat all of the tracks on a CD

Press and hold  (RPT) until you hear a beep.

### Random playback

#### ■ Current CD

Press  (RAND).

Tracks are played in random order until random playback is canceled.

#### ■ All CDs

Press and hold  (RAND) until you hear a beep.

Tracks on all loaded CDs are played in a random order until the button is pressed once more.

### Switching the display

Press .

Each time the button is pressed, the display changes in the order of Track no./ Elapsed time → CD title → Track name.

### ■ Canceling random, repeat and scan playback

Press **1** (RAND), **2** (RPT), or **SCAN** again.

### ■ When LOAD, ERROR or WAIT is shown on the display

**LOAD:** This indicates that the CD player has completed loading the CD.

**ERROR:** This indicates is a trouble either in the CD or inside the player. The CD may be dirty, damaged, or inserted up-side down.

**WAIT:** Operation is stopped due to a high temperature inside the player. Wait for a while and then press **DISC**. Contact your Lexus dealer if the CD still cannot be played back.

### ■ Discs that can be used

Discs with the marks shown below can be used.

Playback may not be possible depending on recording format or disc features, or due to scratches, dirt or deterioration.



CDs with copy-protect features may not be used.

### ■ CD player protection feature

To protect the internal components, playback is automatically stopped when a problem is detected.

### ■ If CDs are left inside the CD player or in the ejected position for extended periods

CDs may be damaged and may not play properly.

### ■ Lens cleaners

Do not use lens cleaners. Doing so may damage the CD player.

 NOTICE

■ **CDs and adapters that cannot be used**

Do not use the following types of CDs, 3 in. (8 cm) CD adapters or Dual Disc. Doing so may damage the CD player and/or the CD insert/eject function.



- CDs that have a diameter that is not 4.7 in. (12 cm).

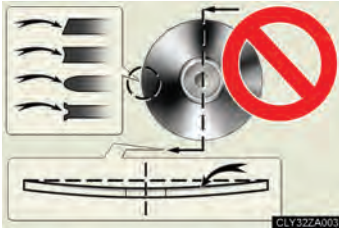

- Low-quality and deformed CDs.



- CDs with a transparent or translucent recording area.



- CDs that have had tape, stickers or CD-R labels attached to them, or that have had the label peeled off.

 NOTICE**■ CD player precautions**

Failure to follow the precautions below may result in serious damage to the CDs or the player itself.

- Do not insert anything other than CDs into the CD slot.
- Do not apply oil to the CD player.
- Store CDs away from direct sunlight.
- Never try to disassemble any part of the CD player.



- Do not insert more than one CD at a time.

## 3-2. Using the front audio system

# Playing back MP3 and WMA discs

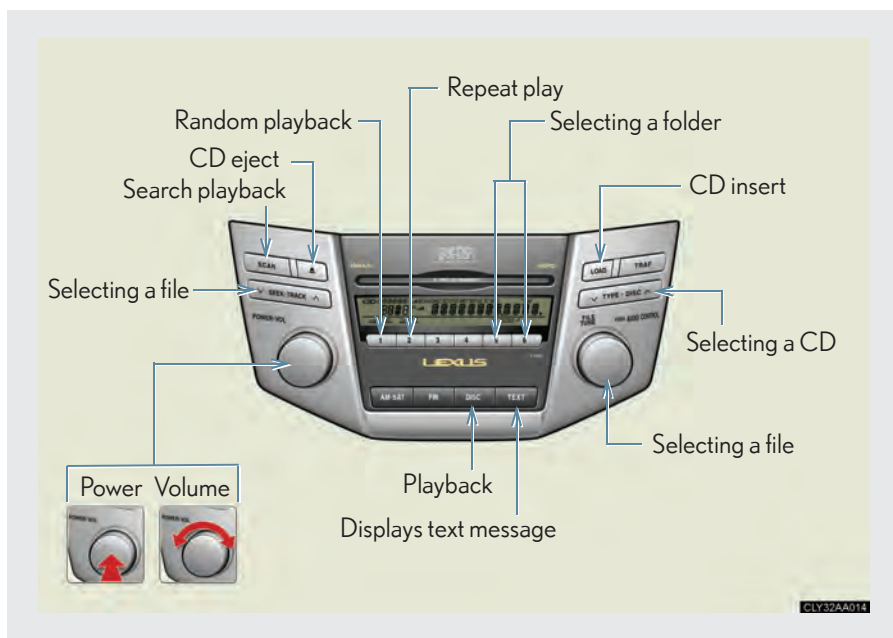

## Loading and ejecting MP3 and WMA discs

→P. 222

## Selecting a folder

### ■ Selecting folders one at a time

Press **6** (∧) or **5** (∨) to select the desired folder.

### ■ Selecting the desired folder by cueing the first file of each folder

Press and hold **SCAN** until you hear a beep. The first ten seconds of the first file in each folder will be played. When the desired folder is reached, press the button once again.

### ■ Returning to the first folder

Press and hold **5** (∨) until you hear a beep.

## Selecting and scanning files

### ■ Selecting one file at a time

Turn  or press  $\wedge$  or  $\vee$  on  to select the desired file.

### ■ Selecting the desired file by cueing the files in the folder

Press . The first ten seconds of each file will be played.

When the desired file is reached, press the button once again.

## Repeat play

### ■ To repeat a file

Press  (RPT).

### ■ To repeat all of the files on a folder

Press and hold  (RPT) until you hear a beep.

## Random playback

### ■ To play files from a particular folder in random order

Press  (RAND).

### ■ To play all of the files on a disc in random order

Press and hold  (RAND) until you hear a beep.

## Switching the display

Press .

Each time the button is pressed, the display changes in the order of Folder no./File no./Elapsed time → Folder name → File name → Album title (MP3 only) → Track title → Artist name.

### ■ Canceling random, repeat and scan playback

Press  (RAND),  (RPT), or  again.

### ■ When LOAD, ERROR or WAIT is shown on the display.

**LOAD:** This indicates that the CD player has completed loading the CD.

**ERROR:** This indicates is a trouble either in the CD or inside the player. The CD may be dirty, damaged, or inserted up-side down.

**WAIT:** Operation is stopped due to a high temperature inside the player. Wait for a while and then press . Contact your Lexus dealer if the CD still cannot be played back.

**NO MUSIC:** This indicates that the MP3/WMA file is not included in the CD.

### ■ Discs that can be used

Discs with the marks shown below can be used.

Playback may not be possible depending on recording format or disc features, or due to scratches, dirt or deterioration.



### ■ CD player protection feature

To protect the internal components, playback is automatically stopped when a problem is detected while the CD player is being used.

### ■ If CDs are left inside the CD player or in the ejected position for extended periods

CDs may be damaged and may not play properly.

### ■ Lens cleaners

Do not use lens cleaners. Doing so may damage the CD player.

### ■ MP3 and WMA files

MP3 (MPEG Audio LAYER 3) is a standard audio compression format.

Files can be compressed to approximately 1/10 of their original size by using MP3 compression.

WMA (Windows Media <sup>TM</sup>Audio) is a Microsoft audio compression format.

This format compresses audio data to a size smaller than that of the MP3 format.

There is a limit to the MP3 and WMA file standards and to the media/formats recorded by them that can be used.

#### ● MP3 file compatibility

- Compatible standards  
MP3 (MPEG1 LAYER3, MPEG2 LSF LAYER3)
- Compatible sampling frequencies  
MPEG1 LAYER3: 32, 44.1, 48 (kHz)  
MPEG2 LSF LAYER3: 16, 22.05, 24 (kHz)
- Compatible bit rates  
MPEG1 LAYER3: 64, 80, 96, 112, 128, 160, 192, 224, 256, 320 (kbps)
- MPEG2 LSF LAYER3: 64, 80, 96, 112, 128, 144, 160 (kbps)  
\* Compatible with VBR
- Compatible channel modes: stereo, joint stereo, dual channel and monaural

#### ● WMA file compatibility

- Compatible standards  
WMA Ver. 7, 8, 9
- Compatible sampling frequencies  
32, 44.1, 48 (kHz)
- Compatible bit rates  
Ver. 7, 8: CBR 48, 64, 80, 96, 128, 160, 192 (kbps)  
Ver. 9: CBR 48, 64, 80, 96, 128, 160, 192, 256, 320 (kbps)  
\*Only compatible with 2-channel playback

#### ● Compatible media

Media that can be used for MP3 and WMA playback are CD-Rs and CD-RWs.

Playback in some instances may not be possible, depending on the status of the CD-R or CD-RW. Playback may not be possible or the audio may jump if the disc is scratched or marked with fingerprints.

### ● Compatible disc formats

The following disc formats can be used.

- Disc formats: CD-ROM Mode 1 and Mode 2  
CD-ROM XA Mode 2, Form 1 and Form 2
- File formats: ISO9660 Level 1, Level 2, (Romeo, Joliet)  
MP3 and WMA files written in any format other than those listed above may not play correctly, and their file names and folder names may not be displayed correctly.

Items related to standards and limitations are as follows.

- Maximum directory hierarchy: 8 levels
- Maximum length of folder names/file names: 32 characters
- Maximum number of folders: 192 (including the root)
- Maximum number of files per disc: 255

### ● File names

The only files that can be recognized as MP3/WMA and played are those with the extension .mp3 or .wma.

### ● Multi-sessions

As the audio system is compatible with multi-sessions, it is possible to play discs that contain MP3 and WMA files. However, only the first session can be played.

### ● ID3 and WMA tags

ID3 tags can be added to MP3 files, making it possible to record the track title and artist name, etc.

The system is compatible with ID3 Ver. 1.0, 1.1, and Ver. 2.2, 2.3 ID3 tags. (The number of characters is based on ID3 Ver. 1.0 and 1.1.)

WMA tags can be added to WMA files, making it possible to record the track title and artist name in the same way as with ID3 tags.

### ● MP3 and WMA playback

When a disc containing MP3 or WMA files is inserted, all files on the disc are first checked. Once the file check is finished, the first MP3 or WMA file is played. To make the file check finish more quickly, we recommend you do not write in any files other than MP3 or WMA files or create any unnecessary folders.

Discs that contain a mixture of music data and MP3 or WMA format data cannot be played.

### ● Extensions

If the file extensions .mp3 and .wma are used for files other than MP3 and WMA files, they will be mistakenly recognized and played as MP3 and WMA files. This may result in large amounts of interference and damage to the speakers.

### ● Playback

- To play MP3 file with steady sound quality, we recommend a fixed bit rate of 128 kbps and a sampling frequency of 44.1 kHz.
- CD-R or CD-RW playback may not be possible in some instances, depending on the characteristics of the disc.
- There is a wide variety of freeware and other encoding software for MP3 and WMA files on the market, and depending on the status of the encoding and the file format, poor sound quality or noise at the start of playback may result. In some cases, playback may not be possible at all.
- When files other than MP3 or WMA files are recorded on a disc, it may take more time to recognize the disc and in some cases, playback may not be possible at all.
- Microsoft, Windows, and Windows Media are the registered trademarks of Microsoft Corporation in the U.S.A. and other countries.

 NOTICE

■ **CDs and adapters that cannot be used**

Do not use the following types of CDs, 3 in. (8 cm) CD adapters or Dual Disc. Doing so may damage the CD player and render the CD insert/eject function unusable.



- CDs that have a diameter that is not 4.7 in. (12 cm).



- Low-quality and deformed CDs.



- CDs with a transparent or translucent recording area.



- CDs that have had tape, stickers or CD-R labels attached to them, or that have had the label peeled off.

 NOTICE**■ CD player precautions**

Failure to follow the precautions below may result in damage to the CDs or the player itself.

- Do not insert anything other than CDs into the CD slot.
- Do not apply oil to the CD player.
- Store CDs away from direct sunlight.
- Never try to disassemble any part of the CD player.



- Do not insert more than one CD at a time.

## 3-2. Using the front audio system

### Optimal use of the audio system

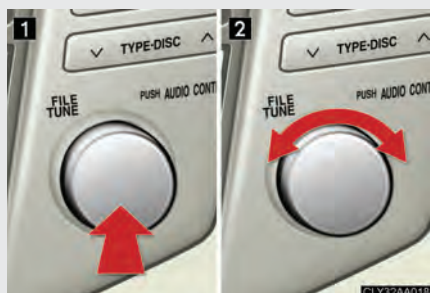

- 1 Displays the current mode.
- 2 Changes the following settings.
  - Sound quality and volume balance (→P. 237)  
The sound quality and balance setting can be changed to produce the best sound.
  - Automatic Sound Levelizer ON/OFF (→P. 237)
  - Listening position (→P. 238)  
The sound feel setting can be changed to produce the best sound for each listening position.
  - Rear system lock ON/OFF of rear seat entertainment system (→P. 238)

#### Using the AUDIO CONTROL function

##### ■ Changing modes

Pressing  selects the mode to be change in the following order.

BAS→MID→TRE→FAD→BAL→ASL→RSE→POS



## ■ Adjusting sound quality

Turning  adjusts the level.

| Sound quality mode        | Mode displayed | Level    | Turn to the left | Turn to the right |
|---------------------------|----------------|----------|------------------|-------------------|
| Bass*                     | BAS            | -5 to 5  | Low              | High              |
| Mid-range*                | MID            | -5 to 5  |                  |                   |
| Treble*                   | TRE            | -5 to 5  |                  |                   |
| Front/rear volume balance | FAD            | F7 to R7 | Shifts to rear   | Shifts to front   |
| Left/right volume balance | BAL            | L7 to R7 | Shifts to left   | Shifts to right   |

\*: The sound quality level is adjusted individually in each AM·SAT·FM or CD mode.

## ■ Adjusting the Automatic Sound Levelizer (ASL)

Turning  to the right turns ON the ASL, and turning  to the left turns OFF the ASL.

ASL automatically adjusts the volume and tone quality according to the noise level as you drive your vehicle.

### ■ Changing the listening position

Turning  changes the position in the following order.

| Display | Listening position   |
|---------|--|
| DRIVER  | Position best suited to the driver's seat                      |
| FRONT   | Position best suited to the driver's and front passenger seats |
| REAR    | Position best suited to the rear seats                         |
| ALL     | Position best suited to all seats                              |

### ■ Rear system lock ON/OFF

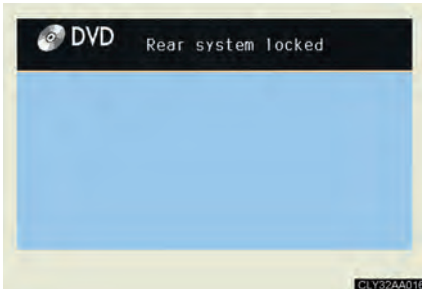

Turn  until ON/OFF is displayed, and press.

The rear system lock remains on, even when the engine switch is turned off.

## 3-2. Using the front audio system

# Using the steering wheel audio switches

Some audio features can be controlled using the switches on the steering wheel.



- 1 Power on, select audio source
- 2 Volume
- 3 Radio: Select radio stations  
CD: Select tracks, files (MP3 and WMA) and discs

### Turning on the power

Press  when the audio system is turned OFF.

The audio system can be turned off by holding the switch down for a few seconds.

### Changing the audio source

Press  when the audio system is turned ON. The audio source changes as follows each time the switch is pressed.

FM1→FM2→CD changer→AM→SAT1→SAT2→SAT3

### Adjusting the volume

Press + on  to increase the volume and - to decrease the volume.

Hold down the switch to continue increasing or decreasing the volume.

### Selecting a radio station

**STEP 1** Press  to select the radio mode.

**STEP 2** Press  $\wedge$  or  $\vee$  on the  to select a radio station.

To scan for receivable stations, press and hold the switch until you hear a beep.

### Selecting a track/file

**STEP 1** Press  to select the CD mode.

**STEP 2** Press  $\wedge$  or  $\vee$  on  to select the desired track/file.

### Selecting a disc in the CD player

**STEP 1** Press  to select the CD mode.

**STEP 2** Press and hold  $\wedge$  or  $\vee$  on  until a beep is heard.

### CAUTION

#### To reduce the risk of an accident

Exercise care when operating the audio switches on the steering wheel.

### 3-3. Using the rear audio system

## Rear seat entertainment system features (if equipped)

The rear seat entertainment system is designed for the rear passengers to enjoy audio and DVD video separately from the front audio system.

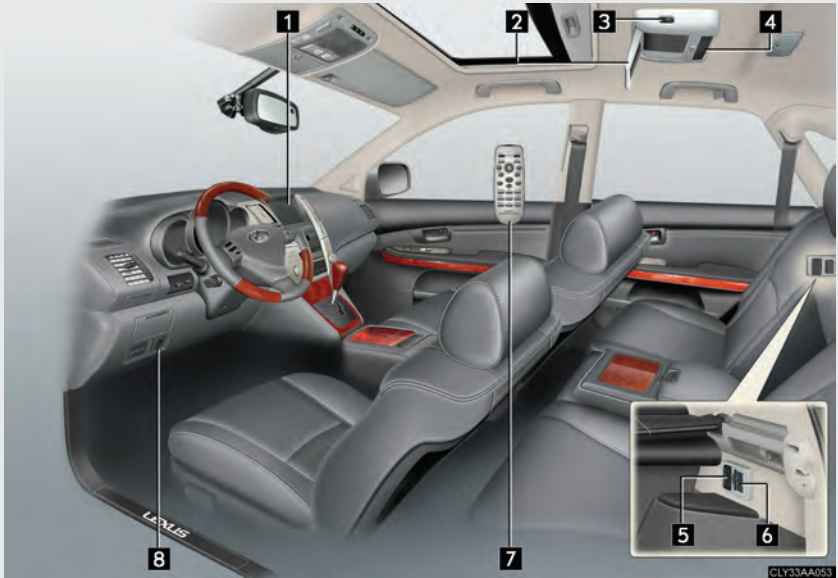

- 1 Front audio system
- 2 Display
- 3 Headphone volume control dials and headphone jacks
- 4 DVD player
- 5 A/V input adapter
- 6 Power outlet
- 7 Rear seat entertainment system controller
- 8 Power outlet main switch

### Opening and closing the display

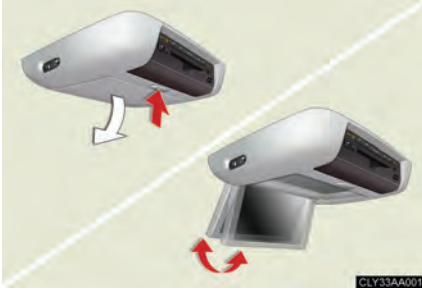

Press the lock release button to open the display.

Pull the display down to an easily viewable angle (between 90° and 125°).



To close the display, press the display up until a click is heard to close the display.

The illumination of the screen is automatically turned off when the display is closed. However, the rear seat entertainment system is not turned off.

### Loading a disc



Insert the disc into the slot with the label side up.

The DISC indicator light turns on while the disc is loaded.

The player will play the track or chapter, and will repeat it after it reaches the end.

## Ejecting a disc



Press  and remove the disc.

## Headphone jacks

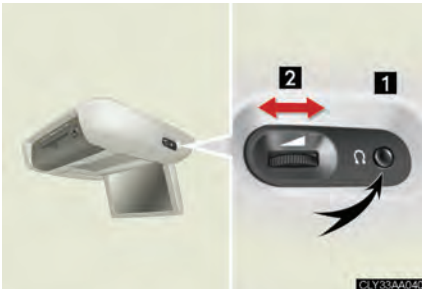

**1** To use the headphones, connect them to the jack.

**2** To adjust the volume

Right side dial: Turn it toward the front of the vehicle to increase the volume. Turn it toward the rear of the vehicle to decrease the volume.

Left side dial: Turn it toward the rear of the vehicle to increase the volume. Turn it toward the front of the vehicle to decrease the volume.

#### ■ The rear seat entertainment system can be used when

The engine switch is in the ACC or ON position.

#### ■ Discs that can be used

Discs with the marks shown below can be used.

Playback may not be possible depending on recording format or disc features, or due to scratches, dirt or deterioration.



#### ■ When appears on the screen

It indicates that the selected switch cannot work.

#### ■ Rear system lock

→P. 238

### ■ Error messages

**DISC CHECK:** Indicates that the disc is dirty, damaged or was inserted upside down. Clean the disc or insert it correctly.

**REGION ERROR:** Indicates that the DVD region code is not set properly.

**DVD ERROR:** Indicates that there is a problem inside the player. Eject the disc. Set the disc again.  
If the malfunction still exists, take the vehicle to your Lexus dealer.

### ■ Before using the remote control (for new vehicle owners)



An insulating sheet is set to prevent the batteries from being discharged. Remove the insulating sheet before using the remote control.

### ■ Headphones

With some headphones generally available in the market, it may be difficult to catch signals properly. Lexus recommends the use of Lexus genuine wireless headphones.

Please contact your Lexus dealer for further details.

### ■ Volume

- Adjust the volume when you connect the headphones to the jack. Loud sounds may have a significant impact on the human body.
- Conversational speech on some DVDs is recorded at a low volume to emphasize the impact of sound effects. If you adjust the volume assuming that the conversations represent the maximum volume level that the DVD will play, you may be startled by louder sound effects or when you change to a different audio source. Be sure to adjust the volume with this in mind.

#### CAUTION

##### ■ While driving

Do not use headphones.

Doing so may cause an accident, resulting in death or serious injury.

##### ■ When the rear seat entertainment system is not used

Keep the display closed.

In the event of an accident or sudden braking, the opened display may hit an occupant's body, resulting in injury.

##### ■ To prevent accidents and electric shock

Do not disassemble or modify the remote control.

##### ■ When the remote control is not used

Stow the remote control.

Injuries may result in the event of an accident or sudden braking.

### 3-3. Using the rear audio system

## Using the DVD player (DVD video)

#### ■ Remote control

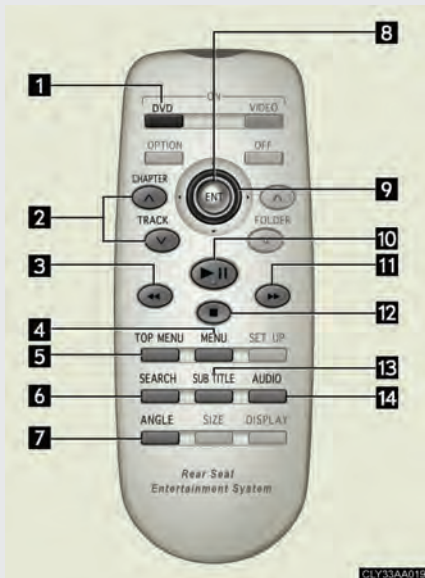

- 1 Turning on the DVD mode
- 2 Selecting a chapter
- 3 Reversing a screen
- 4 Turning on the menu screen
- 5 Turning on the title selection screen
- 6 Searching the title
- 7 Changing the screen angle
- 8 Inputting the selected switch
- 9 Selecting a switch
- 10 Playing/pausing a screen
- 11 Fast forwarding a screen
- 12 Stopping a screen
- 13 Changing the subtitle language
- 14 Changing the audio language

#### ■ Unit

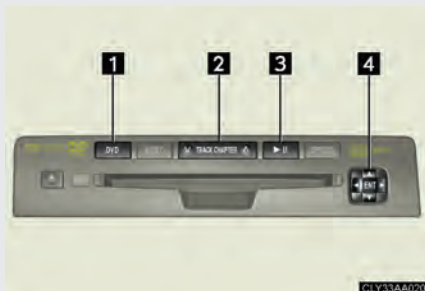

- 1 Turning on the DVD mode
- 2 Skipping to the desired chapter
- 3 Playing/pausing a screen
- 4 Selecting a switch/inputting the selected switch

#### ■ Display (Page 1)

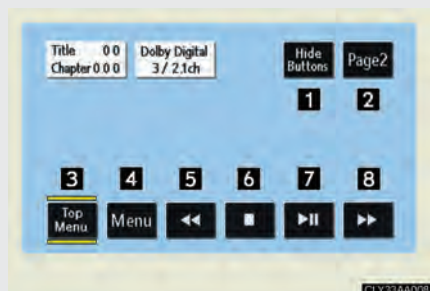

- 1 Turning off the operation switches on the display
- 2 Displaying to Page 2
- 3 Turning on or off the title selection screen for the disc
- 4 Turning on or off the menu screen for the disc
- 5 Reversing a screen
- 6 Stopping a screen
- 7 Pausing the disc/canceling the pause
- 8 Fast forwarding a screen

#### ■ Display (Page 2)



- 9 Displaying to the initial setting screen
- 10 Displaying to Page 1
- 11 Search for a title
- 12 Returning to the previous screen
- 13 Changing the audio language
- 14 Changing the subtitle language
- 15 Changing the angle

 NOTICE

### ■ Cleaning the display

Wipe the display with a dry soft cloth.

If the screen is wiped with a rough cloth, the surface of the screen may be scratched.

### ■ To prevent damage to the remote control



- Keep the remote control away from direct sunlight, temperature heat and high humidity.
- Do not drop or knock the remote control against hard objects.
- Do not sit on or place heavy objects on the remote control.

### ■ DVD player



Never try to disassemble or oil any part of the DVD player. Do not insert anything other than a disc into the slot.

## Turning on or off the operation switches



Press  or  to turn on the operation switches.

Press  or  once again or select  to turn off the operation switches.

## Turning on the title selection screen

Press  or select  to turn on the title selection screen. For the operation of the title selection screen, see the separate manual for the DVD disc.

## Turning on the menu screen

Press  or select  to turn on the menu screen. For the operation of the menu screen, see the separate manual for the DVD disc.

#### Returning to the previous screen

Press **Return** to return to the previous screen. For the operation of the menu screen, see the separate manual for the DVD disc.

#### Searching for a title

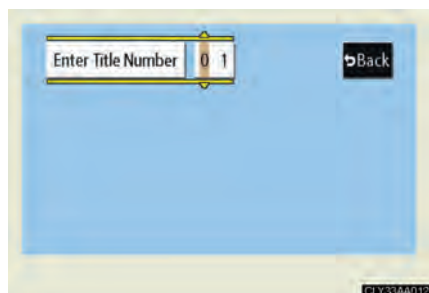

Press **SEARCH** or select **Search** to display the screen to search for a title.

Select the title number, and press ENT to input it.

Select **Back** to return to the previous screen.

#### Changing the subtitle language



Press **SUB TITLE** or select **Sub Title** to display the subtitle language screen.

Each time **SUB TITLE** is pressed or **Sub Title** is selected, another language stored on the disc is selected.

Select **Back** to return to the previous screen.

## Changing the audio language





Press  or select **Audio** to display the audio language screen.

Each time  is pressed or **Audio** is selected, another language stored on the disc is selected.

Select  to return to the previous screen.

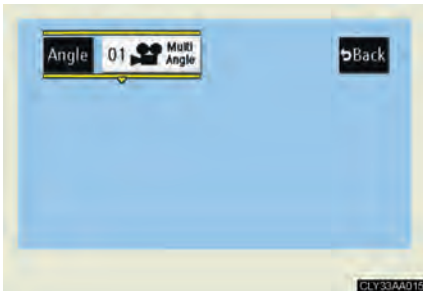
## Changing the angle



Press  or select **Angle** to display the screen to change the angle.

Each time  is pressed or **Angle** is selected, the angle changes.

Select  to return to the previous screen.





### ■ DVD player and DVD video discs

This DVD player is compatible NTSC color TV formats. DVD video discs conforming to other formats such as PAL or SECAM cannot be used.

### ■ Region codes

Some DVD video discs have a region code indicating where you can use them. If the DVD video disc is not labeled ALL or 1, you cannot use it in this DVD player. If you attempt to play an inappropriate DVD video disc in this player, REGION CODE ERROR appears on the screen. Even if the DVD video disc does not have a region code, in some cases you cannot use it.

#### ■ Marks shown on DVD video discs

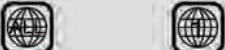
|   |  |
|---|--|
|  | Indicates NTSC format of color TV.   |
|  | Indicates the number of audio tracks.  |
|  | Indicates the number of language subtitles.  |
|  | Indicates the number of angles.  |
|  | Indicates the screen to be selected.<br>Wide screen: 16:9<br>Standard: 4:3                             |
|  | Indicates regions in which this video disc can be played.<br>ALL: all countries<br>Number: region code |

#### ■ DVD video disc glossary

- DVD video discs: Digital Versatile Discs that holds world's standard video. DVD video discs have adopted "MPEG2", one of the world standards of digital compression technologies. The picture data is compressed by 1/40 on average and stored. Variable rate encoded technology has been adopted in which the volume of data assigned to the picture is changed depending on the picture format. Audio data is stored using PCM and Dolby digital, which enables higher sound. Furthermore, multi-angle and multi-language features will also help you enjoy the more advanced technology of DVD video.
- Viewer restrictions: This feature limits what can be viewed in conformity with the level of restrictions of the country. The level of restrictions varies depending on the DVD video disc. Some DVD video discs cannot be played at all, or violent scenes are skipped or replaced with other scenes.
  - Level 1: DVD video discs for children can be played.
  - Level 2 - 7: DVD video discs for children and G-rated movies can be played.
  - Level 8: All types of DVD video discs can be played.

- Multi-angle feature: Allows you to enjoy the same scene at different angles.
- Multi-language feature: Allows you to select the language of the subtitles and audio.
- Region codes: Region codes are provided on DVD players and DVD discs. If the DVD video disc does not have the same region code as the DVD player, you cannot play the disc on the DVD player.
- Audio: This DVD player can play liner PCM, Dolby digital, dts and MPEG audio format DVD. Other decoded type cannot be played.
- Title and chapter: Video and audio programs stored on DVD video discs are divided into sections by title and chapter.
- Title: The largest unit of the video and audio programs stored on DVD video discs. Usually, one piece of a movie, one album, or one audio program is assigned as a title.
- Chapter: A unit smaller than a title. A title comprises multiple chapters.

#### ■ Audio

Manufactured under license from Dolby Laboratories. "Dolby", "Pro Logic", and **DD** are trademarks of Dolby<sup>®</sup> Laboratories. Confidential unpublished works. 1992-1997 Dolby<sup>®</sup> Laboratories. All rights reserved.

"dts" is a trademark of Digital Theater Systems, Inc.

### 3-3. Using the rear audio system

## Using the DVD player (video CD)

#### ■ Remote control



- 1 Selecting a switch
- 2 Selecting a chapter
- 3 Playing/pausing a screen
- 4 Reversing a screen
- 5 Displaying operation switches
- 6 Inputting the selected switch
- 7 Fast forwarding a screen
- 8 Stopping a screen
- 9 Changing the initial setting

#### ■ Unit

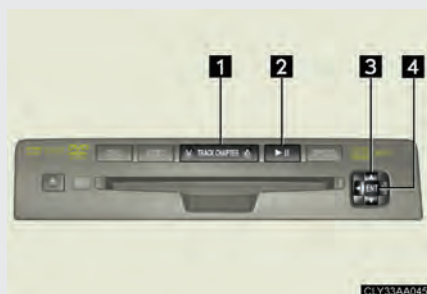

- 1 Skipping to the desired chapter
- 2 Playing/pausing a screen
- 3 Selecting a switch
- 4 Inputting the selected switch

### ■ Display (page 1)

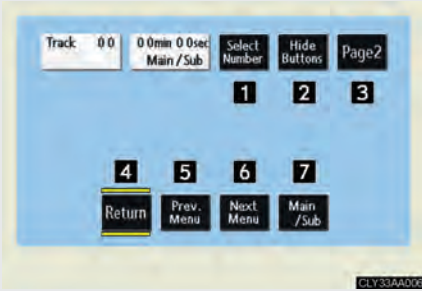

- 1 Selecting a disc menu number
- 2 Turning off the menu screen
- 3 Displaying to page 2
- 4 Turning on the disc menu
- 5 Returning to the previous page screen (with the disc menu displayed)
- 6 Proceeding to the next page screen (with the disc menu displayed)
- 7 Changing to a multiplex transmission

### ■ Display (page 2)



- 8 Displaying to page 1
- 9 Reversing a screen
- 10 Pausing the disc/canceling the pause
- 11 Fast forwarding a screen

### Selecting a disc menu number

Select **Select Number** to display the disc menu number search screen.



Select the disc menu number, and press ENT to input it.

Select **Back** to return to the previous screen.

### 3-3. Using the rear audio system

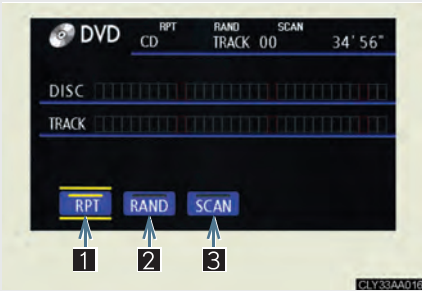
## Using the DVD player (audio CD/ CD text)



Using the control screen, press  or  to display the control screen.

- 1 Repeat play
- 2 Random playback
- 3 Search playback

#### ■ Canceling random, repeat and scan play

Select ,  or  again.

### 3-3. Using the rear audio system

## Using the DVD player (MP3 discs)

#### ■ Using the control screen

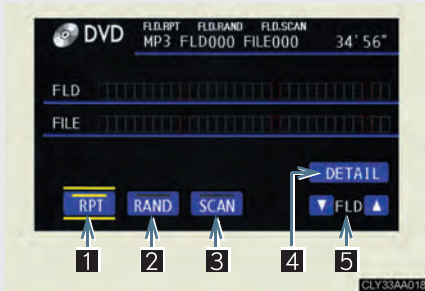

Press **DVD** or **DVD** to display the control screen.

- 1 Repeat play
- 2 Random playback
- 3 Search playback
- 4 Displaying file information
- 5 Selecting folder

#### Repeat play

##### ■ Repeat a file

Select **RPT**.

##### ■ Repeat all of files in a folder

Select **RPT**, and press and hold ENT on the remote control.

#### Random playback

##### ■ Playing files from a particular folder in random order

Select **RAND**.

##### ■ Playing all of the files on a disc in random order

Select **RAND**, and press and hold ENT on the remote control.

#### Search playback

##### ■ Selecting the desired file by cueing the files in the folder

Select **SCAN**.

The player will scan all the files in the folder. Each file will be played for 10 seconds.

#### ■ Selecting the desired file by cueing the folders on the disc

Select **SCAN**, and press and hold ENT the remote control.

The player will scan all the folders on the disc. The first file in each folder will be played for 10 seconds.

---

#### ■ Canceling random, repeat and play back

Select **RPT**, **RAND** or **SCAN** again.

### 3-3. Using the rear audio system

## Using the video mode



Press **VIDEO** or **VIDEO** to select the video mode.

Before switching to the video mode, connect the audio machine to the input terminal adapter.

### Using the adapter

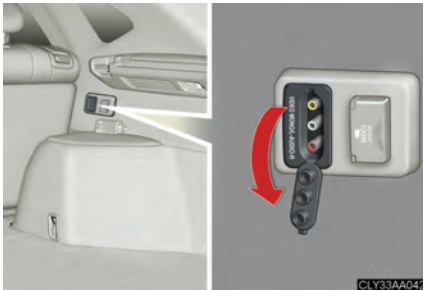

Open the cover.

The A/V input adapter is composed of 3 input adapters.

Yellow: Image input adapter

White: Audio input adapter

Red: Audio input adapter

#### ■ A/V input adapter

The rear seat entertainment system plays videos and sound when audio-video equipment is connected to the A/V input adapter. For details, refer to the manufacturer's instructions.

#### ■ Power outlet

The power outlet is used to connect the audio device. (→P. 285)

 NOTICE

■ **When the A/V input adapter is not in use**

Keep the A/V input adapter cover closed.

Inserting anything other than an appropriate plug may cause electrical failure or short circuit.

### 3-3. Using the rear audio system

## Changing the initial setting

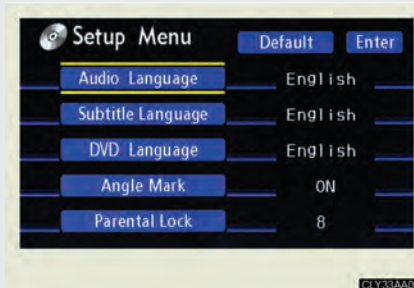

Press **SET UP** or select **Set Up** to display the initial setting screen.

The following initialization can be changed here.

- Audio language
- Subtitle language
- DVD language
- Angle mark
- Parental lock

### Changing the audio language



Select "Audio Language".  
Select the language you want to hear, and press ENT to input it.

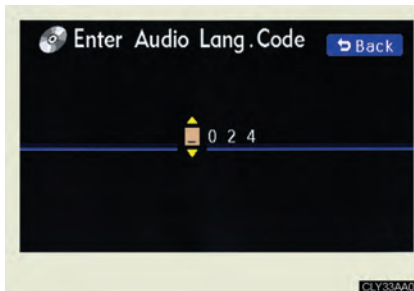

Select "Others" if you cannot find the language you want to hear.  
Enter the appropriate 4-digit language code. Select a number, and press ENT to input it.

Language code list (→P. 265)  
If a code that is not in the list is entered, Incorrect Code will appear on the screen.

## Changing the subtitle language



Select "Subtitle Language".  
Select the language you want to read, and press ENT to input it.

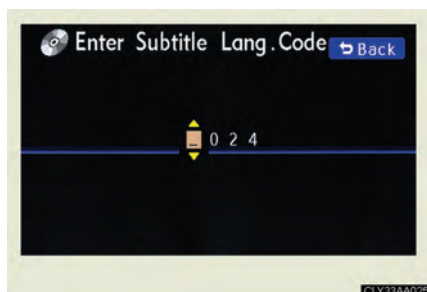

Select "Others" if you cannot find the language you want to read.  
Enter the appropriate 4-digit language code. Select a number, and press ENT to input it.

Language code list (→P. 265)

If a code that is not in the list is entered, Incorrect Code will appear on the screen.

## Changing the DVD language



Select "DVD Language".  
Select the language you want to read and press ENT to input it.



Select "Others" if you cannot find the language you want to read.  
Enter the appropriate 4-digit language code. Select a number, and press ENT to input it.

Language code list (→P. 265)

If a code that is not in the list is entered, Incorrect Code will appear on the screen.

## Turning on or off the angle mark

The angle mark can be turned on for discs that are multi-angle compatible.

Each time you press ENT when "Angle Mark" is selected, the angle mark turns on or off alternately.

#### Setting viewer restriction levels

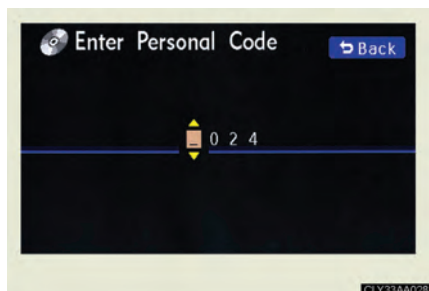

Setting a password allows the viewer restriction to be effective.

Select "Parental Lock".

Enter the password and press ENT. The setting cannot be changed unless the password is entered.

When you forget the password, initialize the password. (→P. 265)

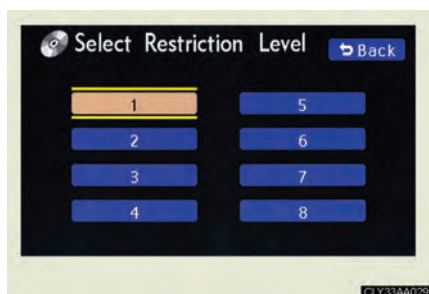

Select a restriction level (1-8), and press ENT. The smaller the level number, the stricter the age limit.

#### Setting the display mode



Pressing **SIZE** changes the display modes sequentially as follows:

Normal → Wide 1 → Wide 2

### ■ Returning to the previous screen

Select **Back**, and press ENT.

### ■ To initialize the password

Press ◀ on the remote control or unit ten times when the screen to enter the personal code is displayed.

### ■ Language code list

| Code | Language     |
|------|--------------|
| 1001 | Japanese     |
| 0514 | English      |
| 0618 | French       |
| 0405 | German       |
| 0920 | Italian      |
| 0519 | Spanish      |
| 2608 | Chinese      |
| 1412 | Dutch        |
| 1620 | Portuguese   |
| 1922 | Swedish      |
| 1821 | Russian      |
| 1115 | Korean       |
| 0512 | Greek        |
| 0101 | Afar         |
| 0102 | Abkhazian    |
| 0106 | Afrikaans    |
| 0113 | Amharic      |
| 0118 | Arabic       |
| 0119 | Assamese     |
| 0125 | Aymara       |
| 0126 | Azerbaijani  |
| 0201 | Bashkir      |
| 0205 | Byelorussian |

| Code | Language     |
|------|--------------|
| 0207 | Bulgarian    |
| 0208 | Bihari       |
| 0209 | Bislama      |
| 0214 | Bengali      |
| 0215 | Tibetan      |
| 0218 | Breton       |
| 0301 | Catalan      |
| 0315 | Corsican     |
| 0319 | Czech        |
| 0325 | Welsh        |
| 0401 | Danish       |
| 0426 | Bhutani      |
| 0515 | Esperanto    |
| 0520 | Estonian     |
| 0521 | Basque       |
| 0601 | Persian      |
| 0609 | Finnish      |
| 0610 | Fiji         |
| 0615 | Faroese      |
| 0625 | Frisian      |
| 0701 | Irish        |
| 0704 | Scots-Gaelic |
| 0712 | Galician     |

### 3-3. Using the rear audio system

| Code | Language    |
|------|-------------|
| 0714 | Guarani     |
| 0721 | Gujarati    |
| 0801 | Hausa       |
| 0809 | Hindi       |
| 0818 | Croatian    |
| 1821 | Hungarian   |
| 1825 | Armenian    |
| 0901 | Interlingua |
| 0905 | Interlingue |
| 0911 | Inupiak     |
| 0914 | Indonesian  |
| 0919 | Icelandic   |
| 0923 | Hebrew      |
| 1009 | Yiddish     |
| 1023 | Javanese    |
| 1101 | Georgian    |
| 1111 | Kazakh      |
| 1112 | Greenlandic |
| 1113 | Cambodian   |
| 1114 | Kannada     |
| 1119 | Kashmiri    |
| 1121 | Kurdish     |
| 1125 | Kirghiz     |
| 1201 | Latin       |
| 1214 | Lingala     |
| 1215 | Laothian    |
| 1220 | Lithuanian  |
| 1222 | Latvian     |
| 1307 | Malagasy    |
| 1309 | Maori       |

| Code | Language       |
|------|----------------|
| 1311 | Macedonian     |
| 1312 | Malayalam      |
| 1314 | Mongolian      |
| 1315 | Moldavian      |
| 1318 | Marathi        |
| 1319 | Malay          |
| 1320 | Maltese        |
| 1325 | Burmese        |
| 1401 | Nauru          |
| 1405 | Nepali         |
| 1415 | Norwegian      |
| 1503 | Occitan        |
| 1513 | (Afan) Oromo   |
| 1518 | Oriya          |
| 1601 | Punjabi        |
| 1612 | Polish         |
| 1619 | Pashto, Pushto |
| 1721 | Quechua        |
| 1813 | Rhaeto-Romance |
| 1814 | Kirundi        |
| 1815 | Romanian       |
| 1823 | Kinyarwanda    |
| 1901 | Sanskrit       |
| 1904 | Sindhi         |
| 1907 | Sangho         |
| 1908 | Serbo-Croatian |
| 1909 | Sinhalese      |
| 1911 | Slovak         |
| 1912 | Slovenian      |
| 1913 | Samoan         |

| Code | Language  |
|------|-----------|
| 1914 | Shona     |
| 1915 | Somali    |
| 1917 | Albanian  |
| 1918 | Serbian   |
| 1919 | Siswati   |
| 1920 | Sesotho   |
| 1921 | Sundanese |
| 1923 | Swahili   |
| 2001 | Tamil     |
| 2005 | Telugu    |
| 2007 | Tajik     |
| 2008 | Thai      |
| 2009 | Tigrinya  |
| 2011 | Turkmen   |
| 2012 | Tagalog   |

| Code | Language   |
|------|------------|
| 2014 | Setswana   |
| 2015 | Tonga      |
| 2018 | Turkish    |
| 2019 | Tsonga     |
| 2020 | Tatar      |
| 2023 | Twi        |
| 2111 | Ukrainian  |
| 2118 | Urdu       |
| 2126 | Uzbek      |
| 2209 | Vietnamese |
| 2215 | Volapük    |
| 2315 | Wolof      |
| 2408 | Xhosa      |
| 2515 | Yoruba     |
| 2621 | Zulu       |

### ■ Adjusting the screen



Press .

Select the brightness, contrast, tone or color, and make adjustments. Press  or ENT to input it.

|            | - or Red                  | + or Green                  |
|------------|---------------------------|-----------------------------|
| Brightness | Darkens                   | Brightens                   |
| Contrast   | Weakens the contrast      | Strengthens the contrast    |
| Tone       | Weakens the tone          | Strengthens the tone        |
| Color      | Strengthens the red color | Strengthens the green color |

### 3-4. Using the interior lights

## Interior lights list

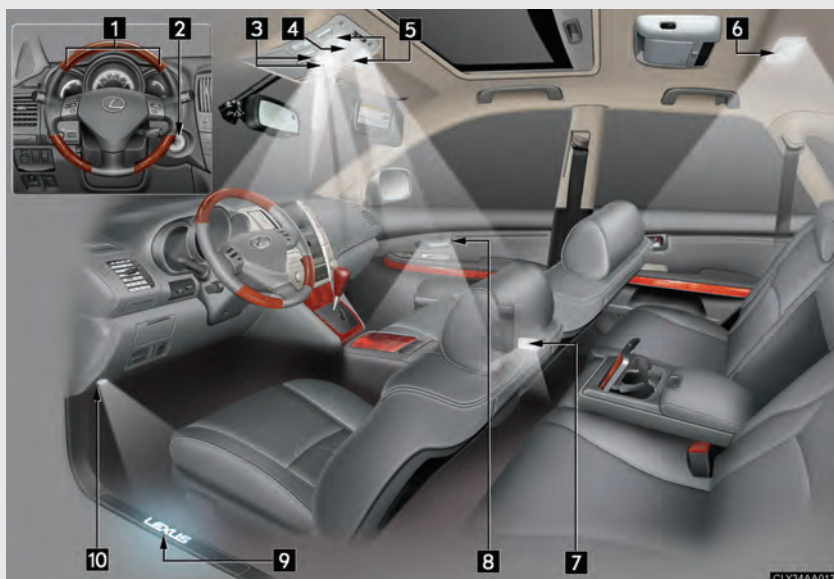

- 1 Meter ring light
- 2 Engine switch light
- 3 Front overhead courtesy lights
- 4 Front interior light (→P. 271)
- 5 Front personal lights (→P. 272)
- 6 Rear interior light
- 7 Front door courtesy lighting
- 8 Inside door handle lights (if equipped)
- 9 Scuff lighting (if equipped)
- 10 Footwell lighting (if equipped)

Turning the instrument panel light control knob fully to the left disables the foot well lighting.

### ■ Illuminated entry system

The following lights turn on when any of the doors are unlocked or opened. (The lights remain on for approximately 15 seconds when the doors are unlocked, but the lights turn off immediately if the doors are locked.)

- Footwell lightings
- Engine switch light
- Front interior light (interior light switch is in the DOOR position)
- Rear interior light (interior light switch is in the DOOR position)
- Inside door handle lights
- Scuff lightings

The following lights turn on for approximately 15 seconds when the engine switch is turned to the LOCK position from the ON or ACC position. (The lights turn off immediately if the engine switch is turned to the ACC or ON position.)

- Engine switch light
- Front interior light (interior light switch is in the DOOR position)
- Rear interior light (interior light switch is in the DOOR position)
- Scuff lightings

The following lights turn on when the engine switch is in the ON position. (The lights dim when the shift lever is moved out of the P position. The lights remain on for approximately 15 seconds after turning the engine switch to the LOCK position from the ON or ACC position.)

- Inside door handle lights
- Footwell lightings

The front overhead courtesy light turns on when the engine switch is in the ACC or ON position.

### ■ To prevent the 12-volt battery from being discharged

If the following lights remain ON when the door is not fully closed and the interior light switch is in the DOOR position, the lights will go off automatically after 20 minutes.

- Engine switch light
- Front interior light
- Rear interior light
- Inside door handle lights
- Scuff lightings
- Footwell lightings

### ■ Customization that can be configured at Lexus dealer

Setting (e.g. The time elapsed before lights turn off) can be changed.  
(Customizable features →P. 466)

## Interior lights



- 1 Door position ON
- 2 ON
- 3 OFF

► Front (models without an electric moon roof)



► Front (models with an electric moon roof)



► Rear

Personal lights

**1** ON/OFF



► Models without an electric moon roof



► Models with an electric moon roof

## 3-5. Using the storage features

# List of storage features

Glove box

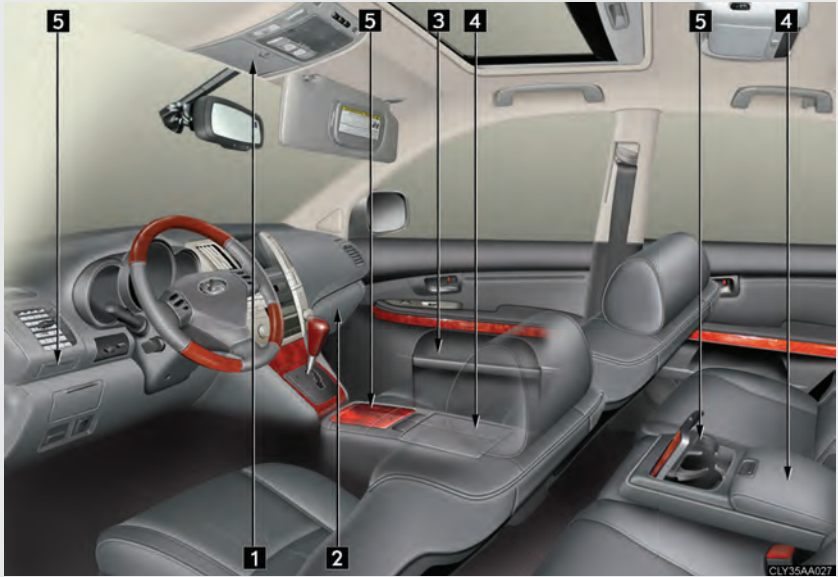

- 1 Overhead console
- 2 Glove box
- 3 Door pocket
- 4 Console boxes
- 5 Cup holders

3

Interior features

## Glove box

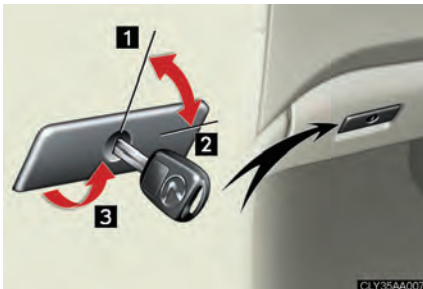

- 1 Unlock with the key
- 2 Lock with the key
- 3 Open (pull lever)

### ■ Glove box light

The glove box light turns on when the tail lights are turned on.

### ■ Power back door main switch

The power back door main switch is located in the glove box. (→P. 45)

## ⚠ CAUTION

### ■ Caution while driving

Keep the glove box closed.

Injuries may result in the event of an accident or sudden braking.

## Console boxes

### ■ Using the console box

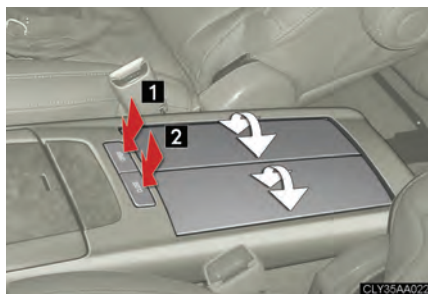

#### ► Front

1 Open

2 Close

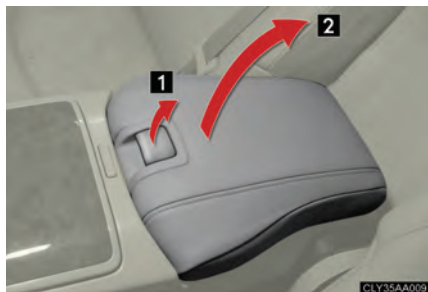

#### ► Rear (if equipped)

1 Pull up the knob to release the lock.

2 Lift the armrest to open.

### ■ Adjusting the position of the console box (front)

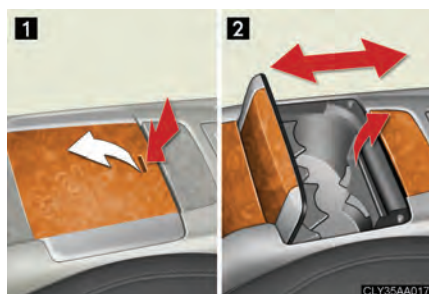

- 1 Open the cup holder lid on the console box.
- 2 Adjust the position of the box while lifting the lock release lever.

### ⚠ CAUTION

#### ■ Console box adjustment precaution

- Do not adjust the position of the console box while the vehicle is moving. This may cause the driver to mishandle the vehicle and may lead to an accident that results in death or serious injury.
- Be careful not to get hands or feet pinched between the front console box and the center panel or rear seat.
- Be careful not to allow the front console box to hit any passengers while adjusting its position.
- After adjusting the console box, make sure it is securely locked in position.

### ■ Removing the adapter tray



Pull up.

### ■ Console box light (front)

The console box light turn on when the tail lights are turned on.

**⚠ CAUTION****■ Caution while driving**

Keep the console box closed.

Injuries may result in the event of an accident or sudden braking.

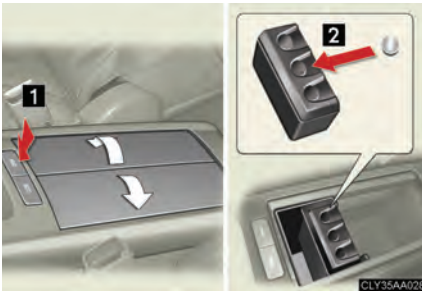
**Coin holder (if equipped)**

**1** Open the console box lid.

**2** Push coins down into the holder.

**■ Removing the coin holder**

Pull up.

## Overhead console

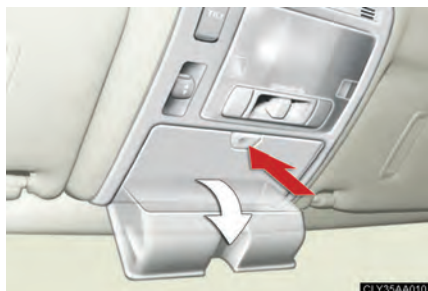

The overhead console is useful for temporarily storing sunglasses and similar small items.

### **⚠ CAUTION**

#### ■ Items that should not be left in the overhead console

Do not leave glasses or lighters in the console.

If the interior of the vehicle becomes hot, lighters may explode and glasses may warp or become cracked.

#### ■ Caution while driving

Do not leave the overhead console open while driving.

Items may fall out and cause injury.

#### ■ Maximum storage weight

Do not place any object heavier than 0.22 lb. (100 g) in it.

The console may be opened and cause injury.

## Cup holders



### ► Front (type A)

To open, press in and release the front cup holder.

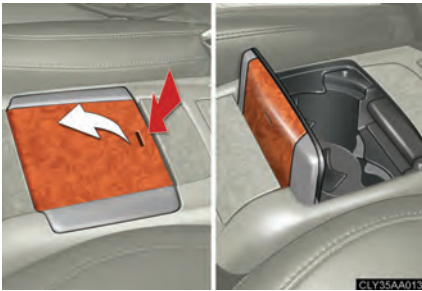

► Front (type B-1)

To open, press down and release the rear of the cup holder lid.

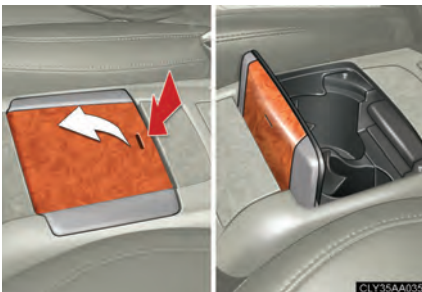

► Front (type B-2)

To open, press down and release the rear of the cup holder lid.



► Rear

To open, press down the button on the armrest.

---

■ Cup holder light (front-type B)

The cup holder light turn on when the tail lights are turned on.

### ■ Removing the separate tray (front-type B-2)



Pull up.

### ⚠ CAUTION

#### ■ Items unsuitable for the cup holder

Do not place anything other than cups or aluminum cans in the cup holders. Other items may be thrown out of the holders in the event of an accident or sudden braking and cause injury. If possible, cover hot drinks to prevent burns.

#### ■ When not in use

Keep the cup holders closed. Injuries may result in the event of an accident or sudden braking.

### Door pockets



The door pocket can be opened and closed.

### ⚠ CAUTION

#### ■ Caution while driving

Keep the door pockets closed. Injuries may result in the event of an accident or sudden braking.

### 3-6. Other interior features

## Sun visors

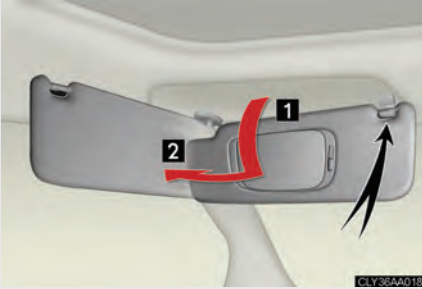

**1** Forward position:  
Flip down.

**2** Side position:  
Flip down, unhook, and swing  
to the side.

At this position, the visors can be  
slid backward.

### 3-6. Other interior features

## Vanity mirror

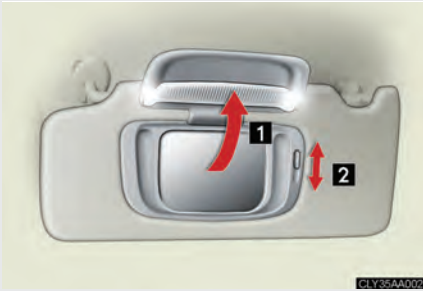

#### 1 Open

The light turns on when the cover is opened.

#### 2 Adjust the brightness of the light

## 3-6. Other interior features

### Clock

▶ With navigation system

Owners of models equipped with a navigation system should refer to the "Navigation System Owner's Manual".

▶ Without navigation system



- 1 Adjusts the hour.
- 2 Adjusts the minutes.
- 3 Rounds to the nearest hour.\*

\*: e.g. 1:00 to 1:29 → 1:00

1:30 to 1:59 → 2:00

■ The clock is displayed when

The engine switch is in the ACC or ON position.

### 3-6. Other interior features

## Outside temperature display

▶ With navigation system

Owners of models equipped with a navigation system should refer to the "Navigation System Owner's Manual".

▶ Without navigation system



1 Displays the outside air temperature

The temperature range that can be displayed is from -22°F (-30°C) to 122°F (50°C).

■ If the temperature does not appear or it shows

Have the vehicle inspected by your Lexus dealer.

### 3-6. Other interior features

## Multi-display light control

▶ With navigation system

Owners of models equipped with a navigation system should refer to the "Navigation System Owner's Manual".

▶ Without navigation system



Adjusts the brightness of the light

Push and release the button until the desired brightness is obtained.

## 3-6. Other interior features

### Power outlets

The power outlet can be used for a following component.

12 V: Accessories that run on less than 10 A.

115 VAC: Audio device that use less than 100 W.



► On center cluster (12 V)



► Tray under the front console box (12 V)



► Luggage compartment (12 V)

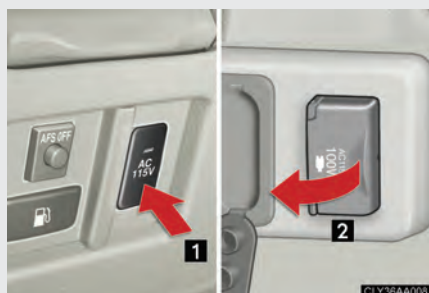

\*: If equipped

► Luggage compartment (115 VAC\*)

1 Main switch

To use the power outlet, turn on the main switch.

2 Power outlet socket

#### ■ The power outlet can be used when

► 12 V

The engine switch is in the ACC or ON position.

► 115 VAC

The engine switch is in the ON position.

#### ⚠ NOTICE

##### ■ To avoid damaging the power outlet

Close the power outlet lid when the power outlet is not in use.

Foreign objects or liquids that enter the power outlet may cause a short circuit.

##### ■ To prevent the fuse from being blown

► 12 V

Do not use an accessory that uses more than 12 V 10 A.

► 115 VAC

Do not use a 115 VAC appliance that requires more than 100 W.

If a 115 VAC appliance that consumes more than 100 W is used, the protection circuit will cut the power supply.

 NOTICE**■ To prevent the 12-volt battery from being discharged**

Do not use the power outlet longer than necessary when the hybrid system is off.

**■ Appliances that may not operate properly (115 VAC)**

The following 115 VAC appliances may not operate properly even if their power consumption is under 100 W.

- Appliances with high initial peak wattage
- Measuring devices that process precise data
- Other appliances that require an extremely stable power supply

### 3-6. Other interior features

## Seat heaters (if equipped)

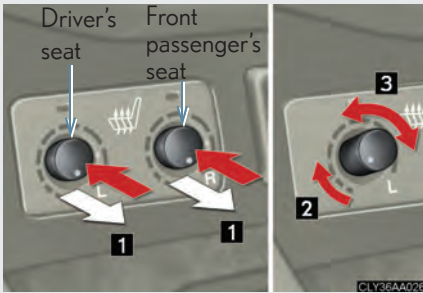

**1** Pops the switch out

**2** ON

The indicator light comes on.

**3** Adjusts the seat temperature

The further you turn the knob clockwise, the warmer the seat becomes.

#### ■ The seat heaters can be used when

The engine switch is in the ON position.

#### ■ When not in use

Turn the knob counterclockwise. The indicator light turns off.

Press the knob into the recessed position.

### **!** CAUTION

#### ■ Burns

- Use caution when seating the following persons in a seat with the seat heater on to avoid the possibility of burns:
  - Babies, small children, the elderly, the sick and the disabled
  - Persons with sensitive skin
  - Persons who are fatigued
  - Persons who have taken alcohol or drugs that induce sleep (sleeping drugs, cold remedies, etc.)
- Do not cover the seat with anything when using the seat heater. Using the seat heater with a blanket or cushion increases the temperature of the seat and may lead to overheating.

 NOTICE**■ To prevent seat heater damage**

Do not put unevenly weighted objects on the seat and do not stick sharp objects (needles, nails, etc.) into the seat.

**■ To prevent 12-volt battery discharge**

Turn the switches off when the hybrid system is off.

## 3-6. Other interior features

### Armrest

#### ■ Front



Pull the armrest down for use.

#### ■ Rear



Pull the armrest down for use.

#### NOTICE

##### ■ To prevent damage to the armrest

Do not place too much strain on the armrest.

## Floor mat

Securely place a mat that matches the size of the space on the carpet.

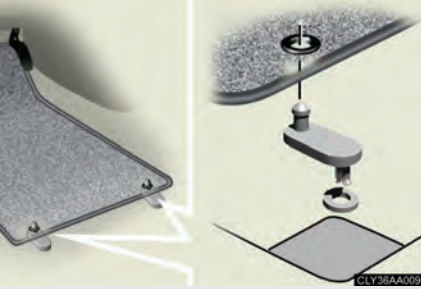

Secure the driver's floor mat using the hooks provided.

### CAUTION

#### ■ When inserting the floor mat

Observe the following precautions.

Failure to do so may result in the floor mat slipping and interfering with the movement of the pedals during driving, resulting in an accident.

- Make sure the floor mat is properly placed on the vehicle carpet and the correct side faces upward.
- Do not place floor mats on top of existing mats.

### 3-6. Other interior features

## Luggage compartment features

#### ■ Cargo hooks



Cargo hooks are provided for securing loose items.

#### ■ Auxiliary box

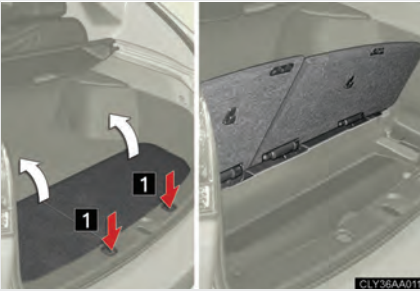

**1** To lift the luggage mat up, press down the button.

An auxiliary box is under the luggage mat.

#### ■ Shopping bag hooks



### ■ Luggage cover

STEP 1

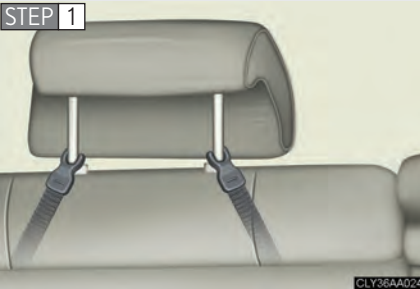

Attach the hooks to the head restraints.

STEP 2



Pull out the luggage cover and hook it onto the anchors.

### Removing luggage cover

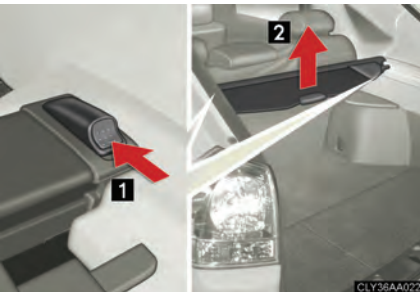

- 1 Push
- 2 Lift up

After removing the luggage cover, stow it in the auxiliary box or place it somewhere other than the passenger compartment.

### Automatic retract function of luggage cover

The knob is in the active position, the luggage cover is retracted automatically when the back door is opened.

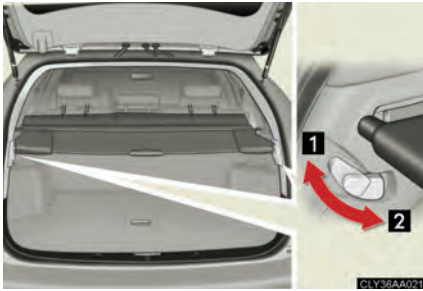

- 1 Active position
- 2 Inactive position

#### CAUTION

##### When the cargo hooks are not in use

To avoid injury, always return the cargo hooks to their positions when they are not in use.

#### NOTICE

##### Shopping bag hook weight capacity

Do not hang any object heavier than 4 lb. (2 kg) on shopping bag hooks.

### 3-6. Other interior features

## Garage door opener

The garage door opener can be programmed to operate garage doors, gates, entry doors, door locks, home lighting systems, and security systems, and other devices.

The garage door opener (HomeLink<sup>®</sup> Universal Transceiver) is manufactured under license from HomeLink<sup>®</sup>.

### Programming the HomeLink<sup>®</sup> (for U.S.A. owners)

The HomeLink<sup>®</sup> compatible transceiver in your vehicle has 3 buttons which can be programmed to operate 3 different devices. Refer to the programming method below appropriate for the device.



- 1 Buttons
- 2 Indicator

### Programming the HomeLink<sup>®</sup>

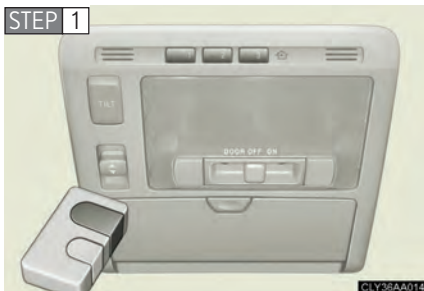

Point the remote control for the device 1 to 3 in. (25 to 75 mm) from the HomeLink<sup>®</sup> control buttons.

Keep the indicator light on the HomeLink<sup>®</sup> in view while programming.

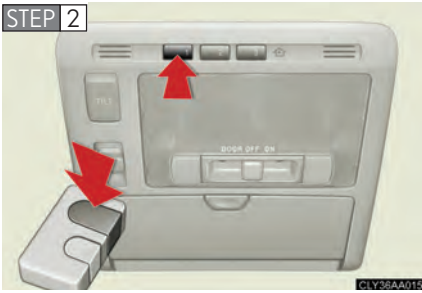

Press and hold down one of the buttons on the HomeLink<sup>®</sup> and the button on the transmitter. When the indicator light on the HomeLink<sup>®</sup> changes from a slow to a rapid flash after 20 seconds, you can release both buttons.



Test the operation of the HomeLink<sup>®</sup> by pressing the newly programmed button.

If programming a garage door opener, check to see if the garage door opens and closes. If the garage door does not operate, see if your garage transmitter is of the Rolling Code type. Press and hold the programmed HomeLink<sup>®</sup> button. The garage door has the rolling code feature if the indicator light (on the HomeLink<sup>®</sup>) flashes rapidly for 2 seconds and then remains lit. If your transmitter is the Rolling Code type, proceed to the heading "Programming a rolling code system".

**STEP 4** Repeat the steps above to program another device for each of the remaining HomeLink<sup>®</sup> buttons.

### ■ Programming a Rolling Code system (for U.S.A. owners)

If your device is Rolling Code equipped, follow the steps under the heading “Programming the HomeLink®” before proceeding with the steps listed below.

**STEP 1** Locate the training button on the ceiling mounted garage door opener motor. The exact location and color of the button may vary by brand of garage door opener.

Refer to the operation manual supplied with the garage door opener for the location of the training button.

**STEP 2** Press the training button.

**STEP 3** Press and release the vehicle’s programmed HomeLink® button twice. The garage door may open.

If the garage door opens, the programming process is complete. If the door does not open, press and release the button a third time. This third press and release will complete the programming process by opening the garage door.

The ceiling mounted garage door opener motor should now recognize the HomeLink® transceiver and operate the garage door.

**STEP 4** Repeat the steps above to program another rolling code system for any of the remaining HomeLink® buttons.

### ■ Programming an entry gate (for U.S.A. owners)/Programming all devices in the Canadian market

**STEP 1** Place your transmitter 1 to 3 in. (25 to 75 mm) away from the surface of the HomeLink®.

Keep the indicator light on the HomeLink® in view while programming.

**STEP 2** Press and hold the selected HomeLink® button.

**STEP 3** Repeatedly press and release (cycle) the device’s remote control button for two seconds each until step 4 is complete.

**STEP 4** When the indicator light on the HomeLink® compatible transceiver start to flashing rapidly, release the buttons.

**STEP 5** Test the operation of the HomeLink<sup>®</sup> by pressing the newly programmed button. Check to see if the gate/device operates correctly.

**STEP 6** Repeat the steps above to program another device for each of the remaining HomeLink<sup>®</sup> buttons.

### ■ Programming other devices

To program other devices such as home security systems, home door locks or lighting, contact your authorized Lexus dealer for assistance.

### ■ Reprogramming a button

The individual HomeLink<sup>®</sup> buttons cannot be erased but can be reprogrammed. To reprogram a button, follow the “Programming the HomeLink<sup>®</sup>” instructions.

## Operating the HomeLink<sup>®</sup>

Press the appropriate HomeLink<sup>®</sup> button. The HomeLink<sup>®</sup> indicator light on the HomeLink<sup>®</sup> transceiver should turn on.

The HomeLink<sup>®</sup> continues to send a signal for up to 20 seconds as long as the button is pressed.

## Erasing the entire HomeLink<sup>®</sup> memory (all three programs)



Press and hold down the 2 outside buttons for 20 seconds until the indicator light flashes.

If you sell your vehicle, be sure to erase the programs stored in the HomeLink<sup>®</sup> memory.

### ■ Before programming

- Install a new battery in the transmitter.
- The battery side of the transmitter must be pointed away from the HomeLink®.

### ■ Certification for the garage door opener

This device complies with Part 15 of the FCC Rules and with RSS-210 of the IC Rules.

Operation is subject to the following two conditions: (1) This device may not cause harmful interference, and (2) this device must accept any interference received, including interference that may cause undesired operation.

**WARNING:** This transmitter has been tested and complies with FCC and IC rules. Changes or modifications not expressly approved by the party responsible for compliance could void the user's authority to operate the device.

### CAUTION

#### ■ When programming a garage door or other remote control device

The garage door may operate, so ensure people and objects are out of danger to prevent potential harm.

#### ■ Conforming to federal safety standards

Do not use the HomeLink® Compatible Transceiver with any garage door opener or device that lacks safety stop and reverse features as required by federal safety standards.

This includes any garage door that cannot detect an obstruction object. A door or device without these features increases the risk of death or serious injury.

### 3-6. Other interior features

## Compass

The compass on the inside rear view mirror indicates the direction in which the vehicle is heading.

#### ■ Operation

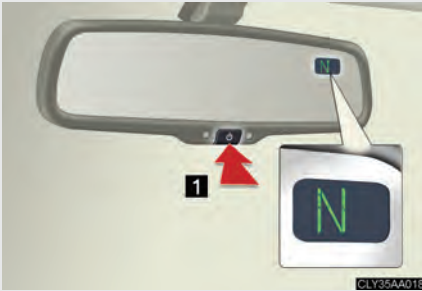

- 1 To turn the compass on or off, press the switch.

#### ■ Displays and directions

| Display | Direction |
|---------|-----------|
| N       | North     |
| NE      | Northeast |
| E       | East      |
| SE      | Southeast |
| S       | South     |
| SW      | Southwest |
| W       | West      |
| NW      | Northwest |

## Calibrating the compass

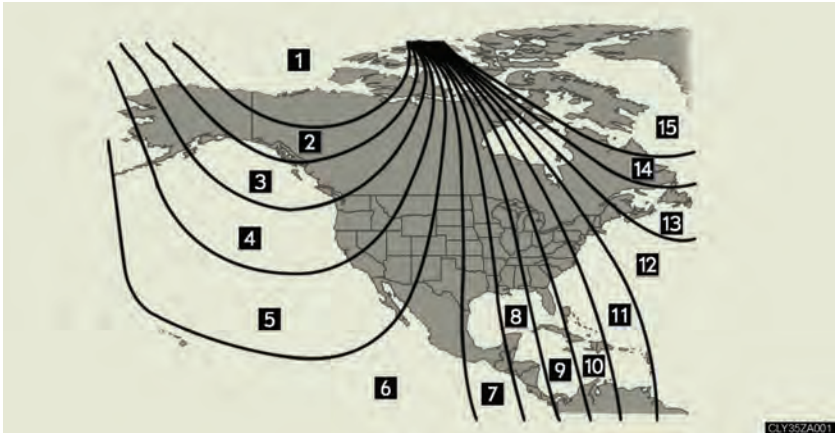

The direction display deviates from the true direction determined by the earth's magnetic field. The amount of deviation varies according to the geographic position of the vehicle.

If you cross over a map boundary shown in illustration, the compass will deviate.

To obtain higher precision or perfect calibration, refer to the following.

### ■ Deviation calibration

**STEP 1** Stop the vehicle where it is safe to drive in a circle.

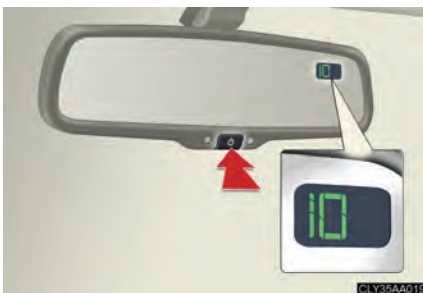

Press and hold the switch for 6 seconds.

A number (1 to 15) appears on the compass display.

**STEP 3** Press the switch, and referring to the map above, select the number of the zone where you are.

If the direction is displayed several seconds after adjustment, the calibration is complete.

### ■ Circling calibration

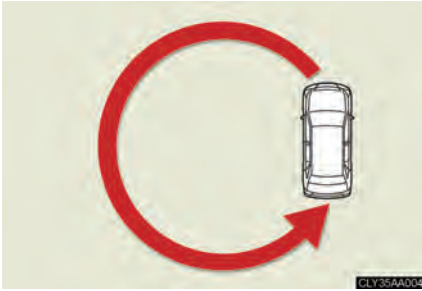

If C appears on the display, drive the vehicle at 5 mph (8 km/h) or less in a circle until a direction is displayed.

If there is not enough space to drive in a circle, drive around the block until the direction is displayed.

---

### ■ Conditions unfavorable to correct operation

The compass may not show the correct direction in the following conditions:

- The vehicle is stopped immediately after turning.
- The vehicle is on an inclined surface.
- The vehicle is in a place where the earth's magnetic field is subject to interference by artificial magnetic fields (underground car park/parking lot, under a steel tower, between buildings, roof car park/parking lot, near an intersection, near a large vehicle, etc.).
- The vehicle has become magnetized.  
(There is a magnet or metal object near the inside rear view mirror.)
- The battery has been disconnected.
- A door is open.

 **CAUTION****■ While driving the vehicle**

Do not adjust the display. Be sure to adjust the display only when the vehicle is stopped.

**■ When doing the circling calibration**

Be sure to secure a wide space, and watch out for people and vehicles in the neighborhood. Do not violate any local traffic rules while performing circling calibration.

 **NOTICE****■ To avoid the compass malfunctions**

Do not place magnets or any metal objects near the inside rear view mirror. Doing this may cause a malfunction of the compass sensor.

**■ To ensure normal operation of the compass**

- Do not perform circling calibration of the compass in a place where the earth's magnetic field is subject to interference by artificial magnetic fields.
- During calibration, do not operate electric systems (moon roof, power windows, etc.) as they may interfere with the calibration.



|  |            |  |            |
|--|------------|--|------------|
| <b>4-1. Maintenance and care</b> .....                   | <b>306</b> | <b>4-3. Do-it-yourself maintenance</b> .....             | <b>318</b> |
| Cleaning and protecting the vehicle exterior .....       | 306        | Do-it-yourself service precautions .....                 | 318        |
| Cleaning and protecting the vehicle interior .....       | 309        | Hood .....   | 321        |
| <b>4-2. Maintenance</b> .....                            | <b>312</b> | Positioning a floor jack .....                           | 322        |
| Maintenance requirements .....                           | 312        | Engine compartment .....                                 | 324        |
| General maintenance .....                                | 314        | Tires .....  | 339        |
| Emission inspection and maintenance (I/M) programs ..... | 317        | Tire inflation pressure .....                            | 348        |
|  |            | Wheels .....   | 352        |
|  |            | Air conditioning filter .....                            | 354        |
|  |            | Wireless remote control battery .....                    | 356        |
|  |            | Rear seat entertainment system controller .....          | 358        |
|  |            | Checking and replacing fuses .....                       | 360        |
|  |            | Headlight aim (vehicles with discharge headlights) ..... | 372        |
|  |            | Light bulbs .....  | 373        |

# Cleaning and protecting the vehicle exterior

Perform the following to protect the vehicle and maintain it in prime condition.

- Working from top to bottom, liberally apply water to the vehicle body, wheel wells and underside of the vehicle to remove any dirt and dust.  
Wash the vehicle body using a sponge or soft cloth, such as a chamois.
- For hard-to-remove marks, use car wash soap and rinse thoroughly with water.
- Wipe away any water.
- Wax the vehicle when the waterproof coating deteriorates.

If water does not bead on a clean surface, apply wax when the vehicle body is cool.

---

### ■ Automatic car washes

- Before washing the vehicle:
  - Fold the mirrors back.
  - Remove the antenna.
  - Turn the power back door system off.
- Brushes used in automatic car washes may scratch the vehicle surface and harm your vehicle's paint.
- Turn the wipers off before washing the vehicle.

### ■ High pressure car washes

- Do not allow the nozzles of the car wash to come within close proximity of the windows.
- Before car wash, check that the fuel filler door on your vehicle is closed properly.

### ■ Aluminum wheels

Remove any dirt immediately by using a neutral detergent. Do not use hard brushes or abrasive cleaners. Do not use strong or harsh chemical cleaners. Use the same mild detergent and wax as used on the paint.

### ■ Bumpers and side moldings

Do not scrub with abrasive cleaners.

### ■ To prevent deterioration and corrosion

- Wash the vehicle immediately in the following cases:
  - After driving near the sea coast
  - After driving on salted roads
  - If you see coal tar or tree sap on the paint surface
  - If you see dead insects or insect droppings on the paint
  - After driving in an area contaminated with soot, oily smoke, mine dust, iron powder or chemical substances
  - If the vehicle becomes heavily soiled in dust or mud
  - If liquids such as benzene and gasoline are spilled on the paint surface
- If the paint is chipped or scratched, have it repaired immediately.

### CAUTION

#### ■ Caution about the exhaust pipe

Exhaust gasses cause the exhaust pipe to become quite hot. When washing the vehicle, be careful not to touch the pipe until it has cooled sufficiently, as touching a hot exhaust pipe can cause burns.

 NOTICE

■ **To protect your vehicle's painted surfaces**

Do not use organic cleaners such as benzene or gasoline.

■ **To protect your vehicle's**

Do not splash water on the electric components in the engine compartment. This may cause malfunction of the electric components.

■ **If the windshield washer nozzle become blocked**

Contact your Lexus dealer. Do not try to clear it with a pin or other object. This may damage the nozzle.

■ **Cleaning the exterior lights**

● Wash carefully. Do not use organic substances or scrub with a hard brush. This may damage the surfaces of the lights.

● Do not apply wax on the surfaces of the lights. Wax may cause damage to the lenses.

■ **When using an automatic car wash (vehicles with the rain-sensing windshield wipers)**

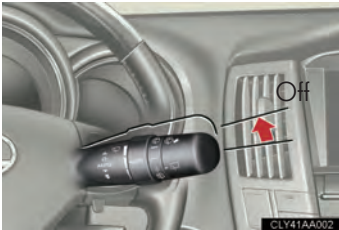

Set the wiper switch to the off position. If the wiper switch is in AUTO, the wipers may operate and the wiper blades may be damaged.

■ **To prevent damage to the windshield wiper arms**

When lifting the wiper arms away from the windshield, pull the driver side wiper arm upward first, and repeat for the passenger side. When returning the wipers to their original position, do so from the passenger side first.

# Cleaning and protecting the vehicle interior

The following procedures will help protect your vehicle's interior and keep it in top condition:

### ■ Protecting the vehicle interior

Remove dirt and dust using a vacuum cleaner. Wipe dirty surfaces with a cloth dampened with lukewarm water.

### ■ Cleaning the leather areas

- Remove dirt and dust using a vacuum cleaner.
- Wipe any excess dirt and dust with a soft cloth dampened with diluted detergent.

Use a diluted water solution of approximately 5% neutral wool detergent.

- Wring out any excess water from the cloth and thoroughly wipe off all remaining traces of detergent.
- Wipe the surface with a dry, soft cloth to remove any remaining moisture. Allow the leather to dry in shaded and ventilated area.

### ■ Synthetic leather areas

- Remove loose dirt using a vacuum cleaner.
- Apply a mild soap solution to the synthetic leather using a sponge or soft cloth.
- Allow the solution to soak in for a few minutes. Remove the dirt and wipe off the solution with a clean, damp cloth.

### ■ Cleaning the inside of the rear window

Do not use glass cleaner to clean the rear window, as this may cause damage to the rear window defogger heater wires or antenna. Use a cloth dampened with lukewarm water to gently wipe the window clean. Wipe the window in strokes running parallel to the heater wires or antenna.

### ■ Caring for leather areas

Lexus recommends cleaning the interior of the vehicle at least twice a year to maintain the quality of the vehicle's interior.

### ■ Shampooing the carpets

There are several commercial foaming-type cleaners available. Use a sponge or brush to apply the foam. Rub in overlapping circles. Do not apply water. The excellent results are obtained by keeping the carpet as dry as possible.

### ■ Seat belts

Clean with mild soap and lukewarm water using a cloth or sponge. Also check the belts periodically for excessive wear, fraying or cuts.

### CAUTION

#### ■ Water in the vehicle

- Be careful not to splash or spill liquid on the floor.
- Do not get any of the SRS components or wiring in the vehicle interior wet.  
(→P. 91)  
Electrical malfunction may cause the airbags to deploy or not function properly, resulting in death or severe injury.

 NOTICE**■ Cleaning detergents**

Do not use organic substances such as benzene or gasoline, acidic or alkaline solutions, dye, bleach or other detergent. Doing so may discolor the vehicle interior or cause streaks or damage to painted surfaces.

**■ Preventing damage to leather surfaces**

Observe the following precautions to avoid damage to and deterioration of leather surfaces.

- Remove any dust or dirt on leather surfaces immediately.
- Do not expose the vehicle to direct sunlight for extended periods of time. Park the vehicle in the shade, especially during summer.
- Do not place items made of vinyl, plastic, or that contain wax on the upholstery, as they may stick to the leather surface if the vehicle interior heats up significantly.

**■ Water on the floor**

Do not wash the vehicle floor with water.

Vehicle systems such as the audio system may be damaged if water comes into contact with electrical components under the floor of the vehicle, and may also cause the body to rust.

**■ Cleaning the inside of the rear window**

Be careful not to scratch or damage the heater wires or antenna.

# Maintenance requirements

To ensure safe and economical driving, day-to-day care and regular maintenance is essential. It is the owner's responsibility to perform regular checks. Lexus recommends the following maintenance.

### ■ General maintenance

Should be performed on a daily basis. This can be done by yourself or by a Lexus dealer.

### ■ Scheduled maintenance

Should be performed at specified intervals according to the maintenance schedule.

For details about maintenance items and schedules, refer to the "Warranty and Services Guide/Owner's Manual Supplement/Scheduled Maintenance".

### ■ Do-it-yourself maintenance

You can perform some maintenance procedures yourself.

Please be aware that do-it-yourself maintenance may affect warranty coverage.

The use of Lexus Repair Manuals is recommended.

For details about warranty coverage, see the separate "Owner's Guide", "Warranty and Services Guide", "Owner's Manual Supplement" or "Warranty Booklet".

---

### ■ Repair and replacement

It is recommended that genuine Lexus parts be used for repair to ensure performance of each system. If non-Lexus parts are used in replacement or if a repair shop other than a Lexus dealer performs repairs, confirm the warranty coverage.

**■ Allow inspection and repairs to be performed by a Lexus dealer**

- Lexus technicians are well-trained specialists and are kept up to date with the latest service information. They are well informed about the operations of all systems on your vehicle.
- Keep a copy of the repair order. It proves that the maintenance that has been performed is under warranty coverage. If any problem should arise while your vehicle is under warranty, your Lexus dealer will promptly take care of it.

**⚠ CAUTION****■ Warning in handling of battery**

- Engine exhaust, some of its constituents, and a wide variety of automobile components contain or emit chemicals known to the State of California to cause cancer and birth defects and other reproductive harm. Work in a well ventilated area.
- Oils, fuels and fluids contained in vehicles as well as waste produced by component wear contain or emit chemicals known to the State of California to cause cancer and birth defects or other reproductive harm. Avoid exposure and wash any affected area immediately.
- Battery posts, terminals and related accessories contain lead and lead compounds which are known to cause brain damage. Wash your hands after handling. (→P. 335)

## 4-2. Maintenance

### General maintenance

Listed below are the general maintenance items that should be performed at the intervals specified in the “Warranty and Services Guide” or “Owner’s Manual Supplement”. It is recommended that any problem you notice should be brought to the attention of your Lexus dealer or qualified service shop for advice.

#### Engine compartment

| Items                             | Check points                                  |
|-----------------------------------|---|
| 12-volt battery                   | Maintenance-free. (→P. 335)                   |
| Brake fluid                       | At the correct level? (→P. 333)               |
| Engine/power control unit coolant | At the correct level? (→P. 331)               |
| Engine oil                        | At the correct level? (→P. 326)               |
| Exhaust system                    | No fumes or strange sounds?                   |
| Radiator/condenser/hoses          | Not blocked with foreign matter?<br>(→P. 333) |
| Washer fluid                      | At the correct level? (→P. 337)               |

## Vehicle interior

| Items                         | Check points   |
|-------------------------------|--|
| Accelerator pedal             | <ul style="list-style-type: none"> <li>• Moves smoothly (without uneven pedal effort or catching)?</li> </ul>  |
| Transmission "Park" mechanism | <ul style="list-style-type: none"> <li>• Can the vehicle be hold securely on an incline with the shift lever in P?</li> </ul>  |
| Brake pedal                   | <ul style="list-style-type: none"> <li>• Moves smoothly?</li> <li>• Does it have appropriate clearance and correct amount of free play?</li> </ul>   |
| Brakes                        | <ul style="list-style-type: none"> <li>• Not pull to one side when applied?</li> <li>• Loss of brake effectiveness?</li> <li>• Spongy feeling brake pedal?</li> <li>• Pedal almost touches floor?</li> </ul> |
| Head restraints               | <ul style="list-style-type: none"> <li>• Move smoothly and lock securely?</li> </ul>   |
| Indicators/buzzers            | <ul style="list-style-type: none"> <li>• Function properly?</li> </ul>   |
| Lights                        | <ul style="list-style-type: none"> <li>• Do all the lights come on?</li> <li>• Headlights aimed correctly? (→P. 372)</li> </ul>  |
| Parking brake                 | <ul style="list-style-type: none"> <li>• Moves smoothly?</li> <li>• Can hold the vehicle securely on an incline?</li> </ul>  |
| Seat belts                    | <ul style="list-style-type: none"> <li>• Does the seat belt system operate smoothly?</li> <li>• Are the belts undamaged?</li> </ul>  |
| Seats                         | <ul style="list-style-type: none"> <li>• Do the seat controls operate properly?</li> </ul>   |

| Items          | Check points  |
|----------------|---|
| Steering wheel | <ul style="list-style-type: none"> <li>• Moves smoothly?</li> <li>• Has correct free play?</li> <li>• No strange noises?</li> </ul> |

### Vehicle exterior

| Items       | Check points  |
|-------------|---|
| Door        | <ul style="list-style-type: none"> <li>• Operate smoothly?</li> </ul>   |
| Engine hood | <ul style="list-style-type: none"> <li>• The lock system works properly?</li> </ul>   |
| Fluid leaks | <ul style="list-style-type: none"> <li>• Is there any leakage after parking?</li> </ul>   |
| Tire        | <ul style="list-style-type: none"> <li>• Inflation pressure is correct?</li> <li>• Tire surfaces not worn or damaged?</li> <li>• Tires rotated according to the maintenance schedule?</li> <li>• Wheel nuts are not loose?</li> </ul> |

### CAUTION

**■ If the hybrid system is running**

Turn the hybrid system off and ensure that there is adequate ventilation before performing maintenance checks.

# Emission inspection and maintenance (I/M) programs

Some states have vehicle emission inspection programs which include OBD (On Board Diagnostics) checks. The OBD system monitors the operation of the emission control system.

### ■ If the malfunction indicator light comes on

The OBD system determines that a problem exists somewhere in the emission control system. Your vehicle may not pass the I/M test and may need to be repaired. Contact your Lexus dealer to service the vehicle.

### ■ Your vehicle may not pass the I/M test:

- When the 12-volt battery is disconnected or discharged

Readiness codes that are set during ordinary driving are erased. Also, depending on your driving habits, the readiness codes may not be completely set.

- When the fuel tank cap is loose

The malfunction indicator light comes on as a temporary malfunction and your vehicle may not pass the I/M test.

### ■ When the malfunction indicator light goes off after several driving trips

The error code in the OBD system will not be cleared unless the vehicle is driven 40 or more times.

### ■ If your vehicle does not pass the I/M test

Contact your Lexus dealer to prepare the vehicle for re-testing.

## 4-3. Do-it-yourself maintenance

### Do-it-yourself service precautions

If you perform maintenance yourself, be sure to follow the correct procedure given in these sections.

| Items   | Parts and tools   |
|---|---|
| 12-volt battery condition (→P. 335)               | <ul style="list-style-type: none"><li>• Grease</li><li>• Conventional wrench (for terminal clamp bolts)</li></ul>   |
| Brake fluid level (→P. 333)                       | —   |
| Engine/power control unit coolant level (→P. 331) | <ul style="list-style-type: none"><li>• “Toyota Super Long Life Coolant” or similar high quality ethylene glycol based non-silicate, non-amine, non-nitrite and non-borate coolant with long-life hybrid organic acid technology.<br/>For the U.S.A.:<br/>“Toyota Super Long Life Coolant” is pre-mixed with 50% coolant and 50% deionized water.<br/>For Canada:<br/>“Toyota Super Long Life Coolant” is pre-mixed with 55% coolant and 45% deionized water.</li><li>• Funnel (used only for adding coolant)</li></ul> |

| Items                             | Parts and tools  |
|-----------------------------------|--|
| Engine oil level (→P. 326)        | <ul style="list-style-type: none"> <li>• “Toyota Genuine Motor Oil” or equivalent</li> <li>• Rag or paper towel, funnel (used only for adding engine oil)</li> </ul> |
| Fuses (→P. 360)                   | <ul style="list-style-type: none"> <li>• Fuse with same amperage rating as original</li> </ul>   |
| Headlight aim (→P. 372)           | <ul style="list-style-type: none"> <li>• Phillips-head screwdriver</li> </ul>  |
| Radiator and condenser (→P. 333)  | —  |
| Tire inflation pressure (→P. 348) | <ul style="list-style-type: none"> <li>• Tire pressure gauge</li> <li>• Compressed air source</li> </ul>   |
| Washer fluid (→P. 337)            | <ul style="list-style-type: none"> <li>• Water washer fluid containing anti-freeze (for winter use)</li> <li>• Funnel</li> </ul>                                     |

### CAUTION

The engine compartment contains many mechanisms and fluids that may move suddenly, become hot, or become electrically energized. To avoid death or serious injury:

#### ■ When working on the engine compartment

- Keep hands, clothing, and tools away from the moving fan and engine drive belt.
- Be careful not to touch the engine, inverter, radiator, exhaust manifold, etc. right after driving as they may be hot. Oil and other fluids may also be hot.
- Do not leave anything that may burn easily, such as paper or rags, in the engine compartment.
- Do not smoke, cause sparks or expose an open flame to fuel or the battery. Fuel and battery fumes are flammable.
- Be extremely cautious when working on the battery. It contains poisonous and corrosive sulfuric acid.
- Never touch, disassemble, remove or replace the high voltage parts, cables and their connectors. It can cause severe burns or electric shock that may result in death or serious injury.
- When the hybrid system is operating with the READY light on, the engine may suddenly start in some cases. When you inspect the engine compartment, be sure to turn off the hybrid system.

#### ■ When working near the electric cooling fan or radiator grille

Be sure the engine switch is off.

With the engine switch on, the electric cooling fan may automatically start to run if the air conditioning is on and/or the coolant temperature is high. (→P. 333)

#### ■ Safety glasses

Wear safety glasses to prevent flying or falling material, fluid spray, etc. from getting in the eyes.

### NOTICE

#### ■ If you remove the air cleaner:

Driving with the air filter removed may cause excessive engine wear due to dirt in the air. Also a backfire could cause a fire in the engine compartment.

## 4-3. Do-it-yourself maintenance

### Hood

Release the lock from the inside of the vehicle to open the hood.

#### STEP 1



Pull the hood release lever.

The hood will pop up slightly.

#### STEP 2

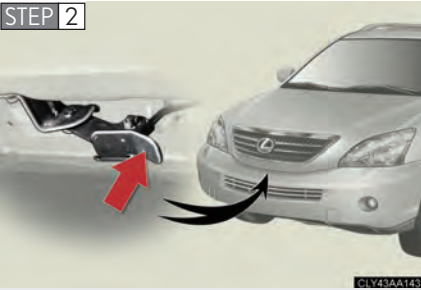

Lift the hood catch and lift the hood.

#### CAUTION

##### ■ Pre-driving check

Check that the hood is fully closed and locked.

If the hood is not locked properly it may open while the vehicle is in motion and cause an accident, which may result in death or serious injury.

## 4-3. Do-it-yourself maintenance

### Positioning a floor jack

When raising your vehicle with a floor jack, position the jack correctly. Improper placement may damage your vehicle or cause injury.

#### ► Front



#### ► Rear (2WD models)



#### ► Rear (AWD models)



## CAUTION

### ■ When raising your vehicle:

Make sure to observe the following to reduce the possibility of death or serious injury.



- Lift up the vehicle using a floor jack such as the one shown in the illustration.

- Do not use the jack that was supplied with your vehicle.
- Do not put any part of your body or get underneath the vehicle supported only by the floor jack.  
Always use automotive jack stands on a solid, level, surface.
- Do not start the hybrid system while the vehicle is supported by the floor jack.
- Stop the vehicle on level firm ground, firmly set the parking brake and put the shift lever in P.
- Make sure to set the floor jack properly at the jack point.  
Raising the vehicle with an improperly positioned floor jack will damage the vehicle and may cause the vehicle to fall off the floor jack.
- Do not raise the vehicle while someone is in the vehicle.
- When raising the vehicle, do not place any objects on top of or underneath the floor jack.

### Engine compartment

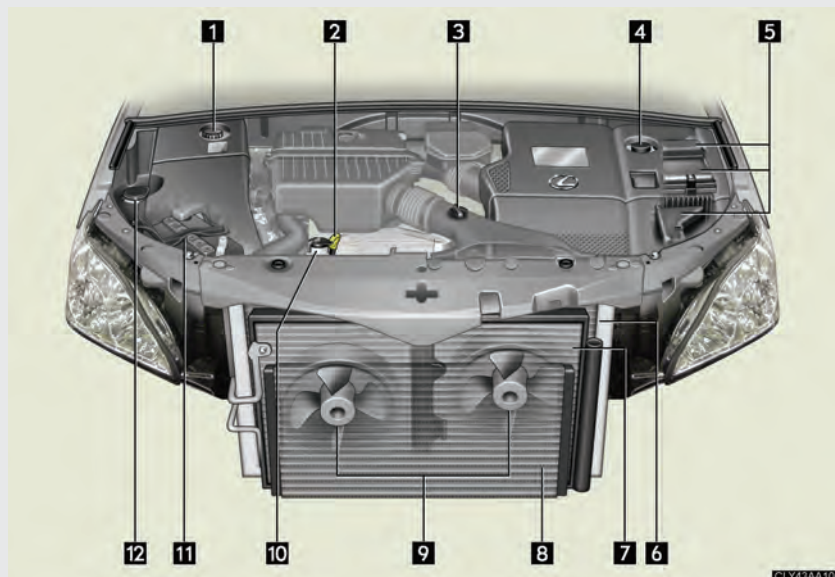

CLY43AA105

- |   |  |
|---|--|
| <b>1</b> Brake fluid reservoir<br>(→P. 333)                   | <b>6</b> Engine coolant radiator<br>(→P. 333)                |
| <b>2</b> Engine oil level dipstick<br>(→P. 326)               | <b>7</b> Condenser<br>(→P. 333)                              |
| <b>3</b> Engine oil filler cap<br>(→P. 326)                   | <b>8</b> Power control unit coolant<br>radiator<br>(→P. 333) |
| <b>4</b> Power control unit coolant<br>reservoir<br>(→P. 331) | <b>9</b> Electric cooling fans                               |
| <b>5</b> Fuse boxes<br>(→P. 360)                              | <b>10</b> Engine coolant reservoir<br>(→P. 331)              |
|   | <b>11</b> 12-volt battery<br>(→P. 335)                       |
|   | <b>12</b> Washer fluid tank<br>(→P. 337)                     |

## Engine compartment cover

### ■ Removing the engine compartment left cover

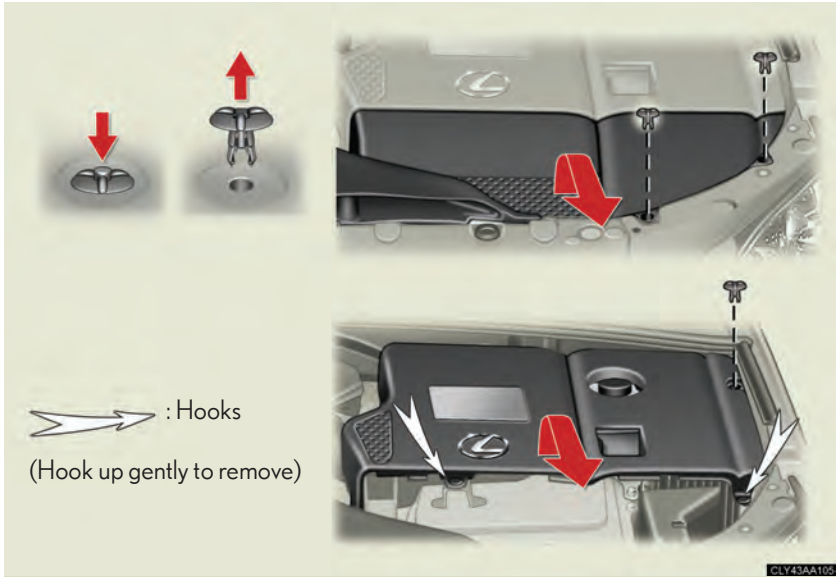

### ■ Removing the engine compartment right cover



### ■ Installing the clips

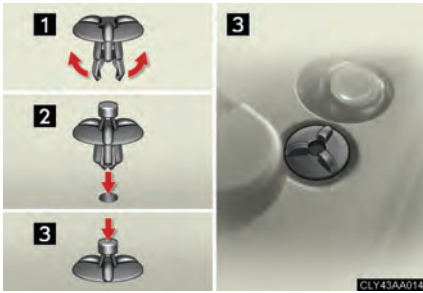

- 1 Open
- 2 Insert
- 3 Press

### Engine oil

With the engine at operating temperature and turned off, check the oil level on the dipstick.

### ■ Checking the engine oil

**STEP 1** Park the vehicle on level ground. After turning off the hybrid system, wait a few minutes for the oil to drain back into the bottom of the engine.

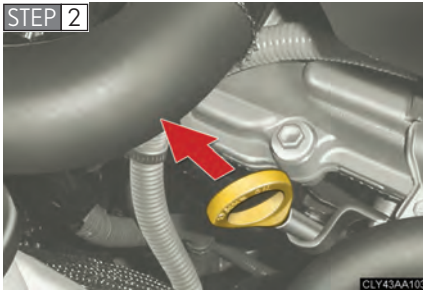

Hold a rag under the end and pull the dipstick out.

**STEP 3** Wipe the dipstick clean.

**STEP 4** Reinsert the dipstick fully.

**STEP 5** Holding a rag under the end, pull the dipstick out and check the oil level.

**STEP 6** Wipe the dipstick and reinsert it fully.

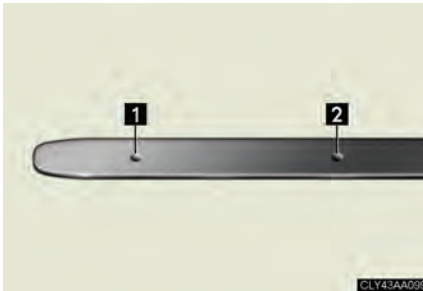

- 1** Low
- 2** Full

### ■ Adding engine oil



If the oil level is below or near the low level mark, add engine oil of the same type as already in the engine.

Make sure to check the oil type and prepare the items needed before adding oil.

|           |                              |
|-----------|------------------------------|
| Oil grade | ILSAC multi-grade engine oil |
| Items     | Clean funnel                 |

**STEP 1** Remove the oil filler cap.

**STEP 2** Add engine oil slowly, checking the dipstick.

**STEP 3** Install the filler cap, turning it clockwise.

It takes about 1.6 qt. (1.5 L, 1.3 Imp. qt.) to raise the oil level from low to full on the dipstick.

### ■ Recommended viscosity

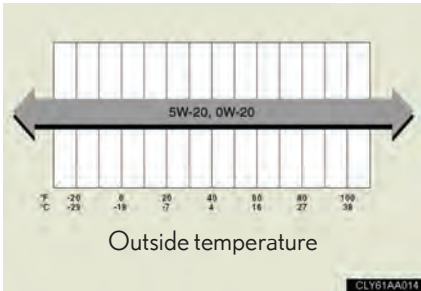

SAE 5W-20 or 0W-20

SAE 5W-20 or 0W-20 engine oil may be used. However, SAE 0W-20 is the best choice for good fuel economy and good starting in cold weather.

### ■ How to read oil container labels

The ILSAC (International Lubricant Standardization and Approval Committee) Certification Mark is added to some oil containers to help you select the oil you should use.



### ■ Engine oil consumption

- The amount of engine oil consumed depends on the oil viscosity, the quality of the oil and the way the vehicle is driven.
- More oil is consumed under driving conditions such as high speeds and frequent acceleration and deceleration.
- A new engine consumes more oil.
- When judging the amount of oil consumption, keep in mind that the oil may have become diluted, making it difficult to judge the true level accurately.
- Oil consumption: Max. 1.1 qt./600 miles, 0.9 Imp.qt./600 miles (1.0 L per 1000 km)
- If you consume more than 1.1 qt. (1.0 L, 0.9 Imp.qt.) every 600 miles (1000 km), contact your Lexus dealer.

### ■ After changing the engine oil (U.S.A. only)

The oil change system should be reset. Perform the following procedures:

**STEP 1** Switch the display to the odometer. (→P. 144)

**STEP 2** Turn the engine switch to the LOCK position.



While pressing the ODO/TRIP button, turn the engine switch to the ON position. A message MAINT REQD RESET MODE will appear on the display. To select the system, hold the button for at least 5 seconds. A message COMPLETE will appear and a beep will sound.

### CAUTION

#### ■ Used engine oil

- Used engine oil contains potentially harmful contaminants which may cause skin disorders such as inflammation or skin cancer, so care should be taken to avoid prolonged and repeated contact. To remove used engine oil from your skin, wash thoroughly with soap and water.
- Dispose of used oil and filters only in a safe and acceptable manner. Do not dispose of used oil and filters in household trash, in sewers or onto the ground. Call your Lexus dealer, service station or auto parts store for information concerning recycling or disposal.
- Do not leave used engine oil within the reach of children.

### NOTICE

#### ■ To prevent serious engine damage:

Check the oil level on regular basis.

#### ■ When replacing the engine oil

- Be careful not to spill engine oil on the vehicle components.
- Avoid overfilling, or the engine could be damaged.
- Check the oil level on the dipstick every time you refill the vehicle.
- Be sure the engine oil filler cap is properly tightened.

## Coolant

The coolant level is satisfactory if it is between the FULL and LOW lines on the reservoir when the hybrid system is cold.

### ► Engine coolant reservoir

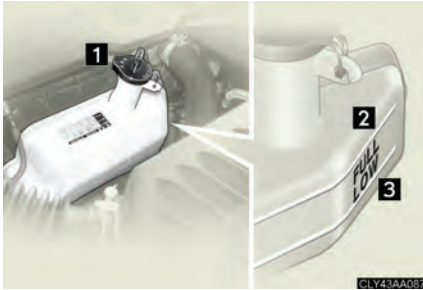

- 1 Reservoir cap
- 2 Full (upper line)
- 3 Low (lower line)

If the level is on or below the LOW line, add coolant up to the FULL line.

### ► Power control unit coolant reservoir

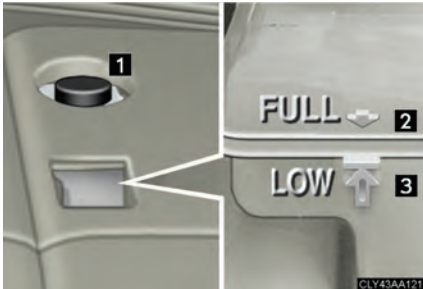

### ■ If the coolant level drops within a short time after replenishing

Visually check the radiator, hoses, reservoir cap, radiator cap, drain cock and water pump.

If you cannot find a leak, have your Lexus dealer pressure test the cap and check for leaks in the cooling system.

### ■ Coolant selection

Only use Toyota Super Long Life Coolant or similar high quality ethylene glycol based non-silicate, non-amine, non-nitrite, and non-borate coolant with long-life hybrid organic acid technology.

U.S.A.: Toyota Super Long Life Coolant is a mixture of 50% coolant and 50% deionized water. (Enabled: -31°F [-35°C])

Canada: Toyota Super Long Life Coolant is a mixture of 55% coolant and 45% deionized water. (Enabled: -44°F [-42°C])

For more details about coolant, contact your Lexus dealer.

### CAUTION

#### ■ When the coolant may be hot

Do not remove the radiator cap.

The cooling system may be under pressure and may spray hot coolant if the cap is removed, causing burns or other injuries.

### NOTICE

#### ■ When adding the coolant

Coolant is neither plain water nor straight antifreeze. The correct mixture of water and antifreeze must be used to provide proper lubrication, corrosion protection and cooling. Be sure to read the antifreeze or coolant label.

#### ■ If you spill coolant

Be sure to wash it off with water to prevent it damaging parts or paint.

## Radiator and condenser

Check the radiator and condenser and clear any foreign objects. If either of the above parts are extremely dirty or you are not sure of their condition, have your vehicle checked by your Lexus dealer.

### ⚠ CAUTION

#### ■ When the engine is hot

Do not touch the radiator or condenser, as they may be hot and you may be burned.

## Brake fluid

### ■ Checking fluid level

The brake fluid level should be between the MAX and MIN lines on the tank.



1 MAX

2 MIN

If the level is low, take your vehicle to a Lexus dealer as soon as possible. Do not drive your vehicle if the red brake system warning light is on. Call a Lexus dealer for assistance.

Make sure to check the fluid type.

### ■ Brake fluid can absorb moisture from the air

Excess moisture in the fluid can cause a dangerous loss of braking efficiency. Use only newly opened brake fluid.

### CAUTION

#### ■ When filling the reservoir

Take care because brake fluid can harm your hands or eyes and damage painted surfaces.

If fluid gets in your eyes, flush your eyes with clean water immediately.

If you still experience discomfort, see a doctor.

### NOTICE

#### ■ If the fluid level is low or high

It is normal for the brake fluid level to go down slightly as the brake pads wear or when the fluid level in the accumulator is high.

If the reservoir needs frequent refilling, it may indicate a serious problem.

## 12-volt battery

Check the 12-volt battery as follows.

### 12-volt battery exterior

Make sure that the 12-volt battery terminals are not corroded and that there are no loose connections, cracks, or loose clamps.

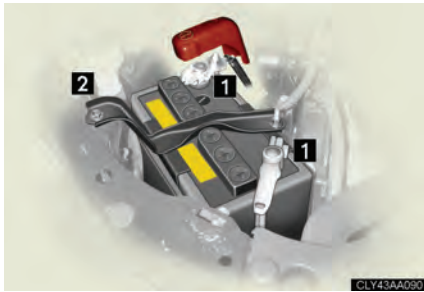

- 1 Terminals
- 2 Hold-down clamp

### Checking the 12-volt battery condition

Check the 12-volt battery condition using the indicator color.

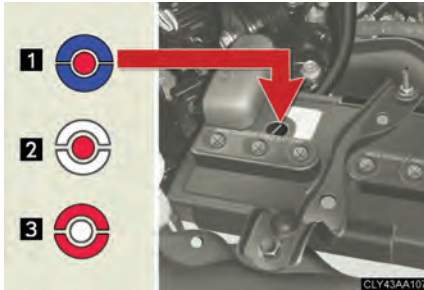

- 1 Blue: Good condition
- 2 White: Charging is necessary. Have the vehicle inspected by your Lexus dealer.
- 3 Red: Not working properly, have the 12-volt battery checked by your Lexus dealer.

### Before recharging

When recharging, the 12-volt battery produces hydrogen gas which is flammable and explosive. Therefore, before recharging:

- If recharging with the 12-volt battery installed on the vehicle, be sure to disconnect the ground cable.
- Make sure the power switch on the charger is off when connecting and disconnecting the charger cables to the 12-volt battery.

### ■ After recharging/reconnecting the 12-volt battery

In some cases, the hybrid system may not start. If this happens, follow the procedure below. (If the system does not start first time, repeat the procedure.)

Turn the hybrid system off. Open and close the driver's door, and turn the hybrid system on.

If the system will not start even after repeating the procedure, contact your Lexus dealer.

### CAUTION

#### ■ Chemicals in the 12-volt battery:

The 12-volt battery contains poisonous and corrosive sulfuric acid and may produce hydrogen gas which is flammable and explosive. To reduce the risk of death or serious injury, take the following precautions while working on or near the 12-volt battery:

- Do not cause sparks by touching the 12-volt battery terminals with tools.
- Do not smoke or light a match near the 12-volt battery.
- Avoid contact with eyes, skin and clothes.
- Never inhale or swallow electrolyte.
- Wear protective safety glasses when working near the 12-volt battery.
- Keep children away from the 12-volt battery.

#### ■ Where to safely charge the 12-volt battery

Always charge the 12-volt battery in an open area. Do not charge the 12-volt battery in a garage or closed room where there is not sufficient ventilation.

#### ■ How to recharge the 12-volt battery

Only perform a slow charge (5 A or less). The 12-volt battery may explode if charged at a quicker rate.

#### ■ Emergency measures regarding electrolyte

- If electrolyte gets in your eyes  
Flush your eyes with clean water for at least 15 minutes and get immediate medical attention. If possible, continue to apply water with a sponge or cloth while traveling to the nearest medical facility.

**⚠ CAUTION****■ Emergency measures regarding electrolyte**

- If electrolyte gets on your skin  
Wash the affected area thoroughly. If you feel pain or burning, get medical attention immediately.
- If electrolyte gets on your clothes  
It can soak through clothing on to your skin. Immediately take off the clothing and follow the procedure above if necessary.
- If you accidentally swallow electrolyte  
Drink a large quantity of water or milk. Follow with milk of magnesia, beaten raw egg or vegetable oil. Get emergency medical attention immediately.

**■ When replacing the 12-volt battery**

Use a 12-volt battery designed for the RX400h. Failure to do so may cause gas (hydrogen) to enter the passenger compartment, causing a fire or explosion.

For replacement of the 12-volt battery, contact your Lexus dealer.

**⚠ NOTICE****■ When recharging the 12-volt battery**

Never recharge the 12-volt battery while the hybrid system is running. Also, be sure all accessories are turned off.

**Washer fluid**

If any washer does not work or the low washer fluid warning light comes on, the washer tank may be empty. Add washer fluid.

 NOTICE

■ **Do not use any fluid other than washer fluid**

Do not use soapy water or engine antifreeze instead of washer fluid.  
Doing so may cause streaking on the vehicle's painted surfaces.

■ **Diluting washer fluid**

Dilute washer fluid with water as necessary.  
Refer to the freezing temperatures listed on the washer fluid tank.

## 4-3. Do-it-yourself maintenance

# Tires

Replace or rotate tires in accordance with maintenance schedules and treadwear.

### ■ Checking tires



- 1 New tread
- 2 Treadwear indicator
- 3 Worn tread

The location of treadwear indicators is shown by the “TWI” or “Δ” marks, etc., molded on the sidewall of each tire.

Check spare tire condition and inflation pressure if not rotated.

### ■ Tire rotation

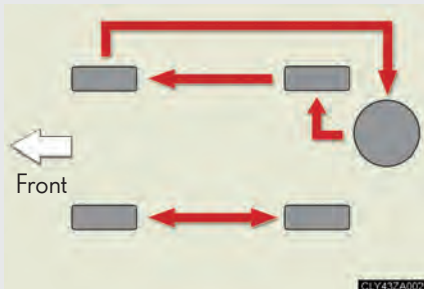

Rotate the tires in the order shown.

To equalize tire wear and extend tire life, Lexus recommends that tire rotation is carried out at the same interval as tire inspection.

### ■ The tire pressure warning system

Your Lexus is equipped with a tire pressure warning system that uses tire pressure warning valves and transmitters to detect low tire inflation pressure before serious problems arise. (→P. 399, 406)

### Installing tire pressure warning valves and transmitters

When replacing tires or wheels, tire pressure warning valves and transmitters must also be installed.

When new tire pressure warning valves and transmitters are installed, new tire pressure warning valve and transmitter ID codes must be registered in the tire pressure warning computer and tire pressure warning system must be initialized. Have tire pressure warning valve and transmitter ID codes registered by your Lexus dealer.

### Initializing the tire pressure warning system

■ **The tire pressure warning system must be initialized in the following circumstances:**

- When changing the tire inflation pressure by changing traveling speed or load weight, etc.
- When changing the tire size.

When the tire pressure warning system is initialized, the current tire inflation pressure is set as the pressure benchmark.

## ■ How to initialize the tire pressure warning system

**STEP 1** Park the vehicle in safe place and turn off the hybrid system.

While the vehicle is moving, initialization is not performed.

**STEP 2** Adjust the tire pressure to the specified cold tire inflation pressure level. (→P. 447)

Make sure to adjust the tire pressure to the specified cold tire inflation pressure level. The tire pressure warning system will operate based on this pressure level.

**STEP 3** Turn the engine switch to the ON position.

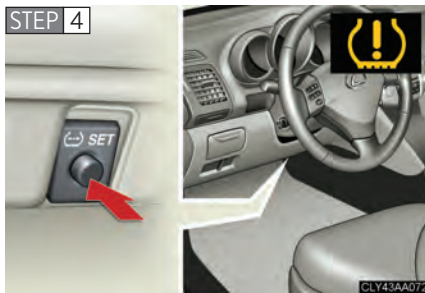

Push and hold the tire pressure warning reset switch until the tire pressure warning light blinks slowly three times.

**STEP 5** Wait for a few minutes with the engine switch is in the ON position, and turn the engine switch to the OFF position.

## Registering and selecting ID codes

### ■ Registering ID codes

2 sets of tire pressure warning valve and transmitter ID codes can be registered. Once a second set of tires is registered at “2nd”, you can switch between tire set settings simply by pressing the tire pressure warning select switch.

There are 2 settings:

“MAIN” position: The ID code of the tire pressure warning valve and transmitter on the tires originally installed on the vehicle is registered.

“2nd” position: The ID code is not registered. When you replace a new set of tires, purchase tire pressure warning valves and transmitters from your Lexus dealer and have the new ID code registered by your Lexus dealer.

## ■ Selecting ID codes

When replacing tires, make sure to select the ID code set that matches the new tire set. If the tire pressure select switch is set to the wrong tire setting, the tire pressure warning system will not operate properly. After about 20 minutes, the tire pressure warning light comes on after blinking for 1 minute to indicate a system malfunction.



1 "MAIN"

2 "2nd"

## ■ When to replace your vehicle's tires

Tires should be replaced if:

- You have tire damage such as cuts, splits, cracks deep enough to expose the fabric or bulges indicating internal damage.
- A tire goes flat repeatedly or cannot be properly repaired due to the size or location of a cut or other damage.

If you are not sure, consult with your Lexus dealer.

## ■ Replacing tires and wheels

If the ID code of the tire pressure warning valve and transmitter is not registered, the tire pressure warning system will not work properly. After about 20 minutes, the tire pressure warning light comes on after blinking for 1 minute to indicate a system malfunction.

## ■ Tire life

Any tire over 6 years old must be checked by a qualified technician even if they have seldom or never been used or damage is not obvious.

## ■ If the tread wears down below 0.16 in. (4 mm) on snow tires

The effectiveness of snow tires is lost.

### ■ Maximum load of tire

Check that the maximum load of the replaced tire is greater than 1/2 of the Gross Axle Weight Ratings (GAWR) of either the front axle or the rear axle, whichever is greater.

As for the maximum load of the tire, see the load limit at maximum cold tire inflation pressure mentioned on the sidewall of the tire, and as for the Gross Axle Weight Ratings (GAWR), see the Certification Label. (→P. 348, 453).

### ■ Tire types

#### 1 Summer tires

Summer tires are high-speed performance tires best suited to highway driving under dry conditions. Since summer tires do not have the same traction performance as snow tires, summer tires are inadequate for driving on snow-covered or icy roads. For driving on snow-covered roads or icy roads, the use of snow tires is recommended. When installing snow tires, be sure to replace all four tires.

#### 2 All season tires

All season tires are designed to provide better traction in snow and to be adequate for driving in most winter conditions, as well as for use year round. All season tires, however, do not have adequate traction performance compared with snow tires in heavy or loose snow. Also, all season tires fall short in acceleration and handling performance compared with summer tires in highway driving.

#### 3 Snow tires

For driving on snow-covered roads or icy roads, we recommend using snow tires. If you need snow tires, select tires of the same size, construction and load capacity as the originally installed tires. Since your vehicle has radial tires as original equipment, make sure your snow tires also have radial construction. Do not install studded tires without first checking local regulations for possible restriction. Snow tires should be installed on all wheels. (→P. 190)

### ■ Initializing the tire pressure warning system

Initialize the tires with the tire inflation pressure adjusted to the specified level.

**■ If you push the tire pressure warning reset switch accidentally**

If initialization is performed, adjust the tire inflation pressure to the specified level and initialize the tire pressure warning system again.

**■ When the initialization of the tire pressure warning system has failed**

Initialization can be completed in a few minutes. However, in the following cases, the settings have not been recorded and the system will not operate properly. If repeated attempts to record tire inflation pressure settings are unsuccessful, have the vehicle inspected by your Lexus dealer.

- When operating the tire pressure warning reset switch, the tire pressure warning light does not flash 3 times.
- After driving for a certain period of time since the initialization has been completed, the tire pressure warning light comes on after flashing for 1 minute.

**■ Routine tire inflation pressure checks**

The tire pressure warning system does not replace routine tire inflation pressure checks. Make sure to check tire inflation pressure as part of your routine of daily vehicle checks.

**■ Tire pressure warning system certification**

- ▶ For vehicles sold in the U.S.A.

**NOTE:**

This device complies with Part 15 of the FCC Rules. Operation is subject to the following two conditions: (1) this device may not cause harmful interference, and (2) this device must accept any interference received, including interference that may cause undesired operation.

**NOTICE:**

This equipment has been tested and found to comply with the limits for a Class B digital device, pursuant to Part 15 of the FCC Rules. These limits are designed to provide reasonable protection against harmful interference in a residential installation. This equipment generates, uses and can radiate radio frequency energy and, if not installed and used in accordance with the instructions, may cause harmful interference to radio communications. However, there is no guarantee that interference will not occur in a particular installation. If this equipment does cause harmful interference to radio or television reception, which can be determined by turning the equipment off and on, the user is encouraged to try to correct the interference by one or more of the following measures:

- Reorient or relocate the receiving antenna.
- Increase the separation between the equipment and receiver.

- Connect the equipment into an outlet on a circuit different from that to which the receiver is connected.
- Consult the dealer or an experienced radio/TV technician for help.

### FCC WARNING:

Changes or modifications not expressly approved by the party responsible for compliance could void the user's authority to operate the equipment.

► For vehicles sold in Canada

### NOTE:

Operation is subject to the following two conditions: (1) this device may not cause interference, and (2) this device must accept any interference, including interference that may cause undesired operation of the device.

## CAUTION

### ■ When inspecting or replacing tires

Observe the following precautions to prevent accidents.

Failure to do so may cause damage to parts of the drive train, as well as dangerous handling characteristics, which may lead to fatal or injury accidents.

- Do not mix tires of different makes, models, tread patterns or treadwear.
- Do not use tire sizes other than those recommended by Lexus.
- Do not mix radial, bias-belted, or bias-ply tires.
- Do not mix summer, all season and winter tires.
- Do not use tires that have been used on another vehicle.  
Do not use tires if you do not know how they were used previously.

### ■ When initializing the tire pressure warning system

Do not push the tire pressure warning reset switch without first adjusting the tire inflation pressure to the specified level. Otherwise, the tire pressure warning light may not come on even if the tire inflation pressure is low, or it may come on when the tire inflation pressure is actually normal.

 NOTICE**■ Repairing or replacing tires, wheels and tire pressure warning valves and transmitter**

When removing or fitting the wheels, tires or the tire pressure warning valve and transmitter, contact your Lexus dealer as the tire pressure warning valve and transmitter may be damaged if not handled correctly.

**■ To avoid damaging the tire pressure warning valves and transmitters**

Do not use liquid sealants on flat tires.

**■ Driving on rough roads**

Take particular care when driving on roads with loose surfaces or potholes.

These conditions may cause losses in tire inflation pressure, reducing the cushioning ability of the tires. In addition driving on rough roads may cause damage to the tires themselves, as well as the vehicle's wheels and body.

**■ If tire inflation pressures become low while driving**

Do not continue driving, or your tires and/or wheels may be ruined.

## 4-3. Do-it-yourself maintenance

### Tire inflation pressure

#### ■ Tire inflation pressure

The recommended cold tire inflation pressure and tire size is displayed on the tire and loading information label. (→P. 447)



| TIRE AND LOADING INFORMATION  |           | INFORMATION SUR LES PNEUS ET LE CHARGEMENT  |                                |
|---|-----------|---|--------------------------------|
| SEATING CAPACITY: TOTAL X<br>FRONT X, REAR X                                      |           | NOMBRE DE PLACES ASSISES: TOTAL X<br>AVANT X, ARRIERE X   |                                |
| The combined weight of occupants and cargo should never exceed XXX kg or XXX lbs. |           | Le poids total des occupants et du chargement ne doit jamais être supérieur à XXX kg ou XXX lb. |                                |
| TIRE  | SIZE      | COLD TIRE PRESSURE  | PNEUS                          |
|   |           |   | DIMENSION                      |
|   |           |   | PRESSION DE SOUS-PNEUS À FROID |
| FRONT   | XXXXXXRXX | XXX Pa,XXPSI  | AVANT                          |
| REAR  | XXXXXXRXX | XXX Pa,XXPSI  | ARRIERE                        |
| SPARE   | XXXXXXRXX | XXX Pa,XXPSI  | SECOURS                        |

CLY43AA120

### ■ Inspection and adjustment procedure



- 1 Tire valve
- 2 Tire pressure gauge

**STEP 1** Remove the tire valve cap.

**STEP 2** Press the tip of the tire pressure gauge onto the tire valve.

**STEP 3** Read the pressure using the graduations of the gauge.

**STEP 4** If the tire inflation pressure is not within the recommended levels, adjust inflate the tire.

If you add too much air, press the center of the valve to lower.

**STEP 5** After completing the tire inflation pressure measurement and adjustment, apply soapy water to the valve and check for leakage.

**STEP 6** Reinstall the tire valve cap.

### ■ Tire inflation pressure check interval

You should check tire inflation pressure every two weeks, or at least once a month. Do not forget to check the spare.

### ■ Effects of incorrect tire inflation pressure

Driving with incorrect tire inflation pressure may result in the following:

- Reduced fuel efficiency
- Reduced driving comfort and tire life
- Reduced safety
- Damage to the drive train

If a tire needs frequent refilling, have it checked by your Lexus dealer.

### ■ Instructions for checking tire inflation pressure

When checking tire inflation pressure, observe the following:

- Check only when the tires are cold.

If your vehicle has been parked for at least 3 hours and has not been driven for more than 1 mile or 1.5 km, you will get an accurate cold tire inflation pressure reading.

- Always use a tire pressure gauge.

The appearance of the tire can be misleading. In addition, tire inflation pressures that are even just a few pounds off can degrade ride and handling.

- Do not bleed or reduce tire inflation pressure after driving. It is normal for the tire inflation pressure to be higher after driving.
- Never exceed the vehicle capacity weight.  
Passengers and luggage weight should be placed so that the vehicle is balanced.

 **CAUTION****■ Proper inflation is critical to save tire performance**

Keep your tires properly inflated.

Otherwise, the following conditions may occur and result in an accident causing death or serious injury.

- Excessive wear
- Uneven wear
- Poor handling
- Possibility of blowouts resulting from overheated tires
- Poor sealing of the tire bead
- Wheel deformation and/or tire separation
- A greater possibility of tire damage from road hazards

 **NOTICE****■ When inspecting and adjusting tire inflation pressure**

Be sure to reinstall the tire valve caps.

Without the valve caps, dirt or moisture could get into the valve and cause air leakage, which could result in an accident. If the caps have been lost, replace them as soon as possible.

# Wheels

If a wheel is bent, cracked or heavily corroded, it should be replaced. Otherwise, the tire may separate from the wheel or cause loss of handling control.

### ■ Wheel selection

When replacing wheels, care should be taken to ensure that they are equivalent to those removed in load capacity, diameter, rim width, and offset.

Replacement wheels are available at your Lexus dealer.

Lexus does not recommend using:

- Wheels of different sizes or types
- Used wheels
- Bent wheels that have been straightened

### ■ Aluminum wheel precautions

- Use only Lexus wheel nuts and wrenches designed for use with your aluminum wheels.
- When rotating, repairing or changing your tires, check that the wheel nuts are still tight after driving 1000 miles (1600 km).
- Be careful not to damage the aluminum wheels when using tire chains.
- Use only Lexus genuine balance weights or equivalent and a plastic or rubber hammer when balancing your wheels.

---

### ■ When replacing wheels

The wheels of your Lexus are equipped with tire pressure warning valves and transmitters that allow the tire pressure warning system to provide advanced warning in the event of a loss in tire inflation pressure. Whenever wheels are replaced, the tire pressure warning valves and transmitters must be switched over from the old wheels. (→P. 340)

 **CAUTION****■ When replacing wheels**

- Do not use wheels that are a different size from those recommended in the Owner's Manual, as this may result in loss of handling control.
- Never use an inner tube in a leaking wheel which is designed for a tubeless tire. Doing so may result in an accident, causing serious injury or death.

 **NOTICE****■ Replacing tire pressure warning valves and transmitters**

- Because tire repair or replacement may affect the tire pressure warning valves and transmitters, make sure to have tires serviced by your Lexus dealer or other qualified service shop. In addition, make sure to purchase your tire pressure warning valves and transmitters at your Lexus dealer.
- Ensure that only genuine Lexus wheels are used on your vehicle. Tire pressure warning valves and transmitters may not work properly with non-genuine wheels.

## 4-3. Do-it-yourself maintenance

### Air conditioning filter

The air conditioning filter must be changed regularly to maintain air conditioning efficiency.

**STEP 1** Turn the engine switch to the LOCK position.

**STEP 2**

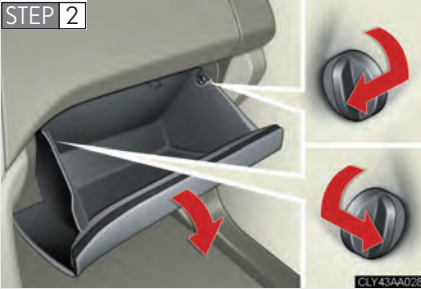

Open the glove box.

Remove the 2 pins installed on the upper part of the glove box and lower the glove box.

**STEP 3**

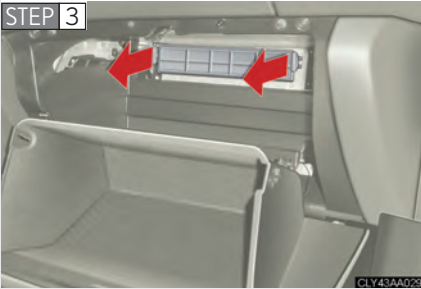

Remove the filter case.

**STEP 4**

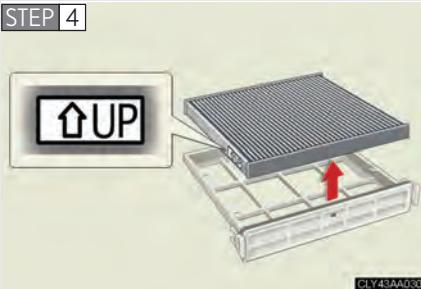

Remove the air conditioning filter from the filter case and replace it with a new one.

The ↑UP marks shown on the filter and the filter case should be pointing up.

---

### ■ Changing interval

Inspect and replace the air conditioning filter according to the maintenance schedule. In dusty areas or areas with heavy traffic flow, early replacement may be required. (For scheduled maintenance information, please refer to the “Warranty and Service Guide”, “Owner’s Manual Supplement” or “Scheduled Maintenance”.)

### ■ If air flow from the vents decreases dramatically

The filter may be clogged. Check the filter and replace if necessary.

#### NOTICE

#### ■ When using the air conditioning system

Make sure that a filter is always installed.

Using the air conditioning system without a filter may cause damage to the system.

## 4-3. Do-it-yourself maintenance

# Wireless remote control battery

Replace the battery with a new one if it is discharged.

■ You will need the following items:

- Small Phillips-head screwdriver
- Lithium battery (CR2016)

■ Replacing the battery

STEP 1



Remove the screw and cover.

Push the cover in the arrow direction.

STEP 2



Remove the module.

STEP 3



Open the case cover and remove the depleted battery.

Insert a new battery with the + terminal facing up.

### ■ If the battery is discharged

The following symptoms may occur.

- The wireless remote control will not function properly.
- The operational range is reduced.

### ■ Use a CR2016 lithium battery

- Batteries can be purchased at your Lexus dealer, jewelers, or camera stores.
- Replace only with the same or equivalent type recommended by a Lexus dealer.
- Dispose of used batteries according to the local laws.

## CAUTION

### ■ Removed battery and other parts

Keep away from children.

These parts are small and if swallowed by a child they can cause choking.

## NOTICE

### ■ For normal operation after replacing the battery

Observe the following precautions to prevent accidents.

- Always work with dry hands.  
Moisture may cause the battery to rust.
- Do not touch or move any other components inside the remote control.
- Do not bend either of the battery terminals.

# Rear seat entertainment system controller

Replace the batteries with new them if they are discharged.

### ■ Necessary item for replacing:

3 AA batteries

### ■ Replacing the batteries

#### STEP 1

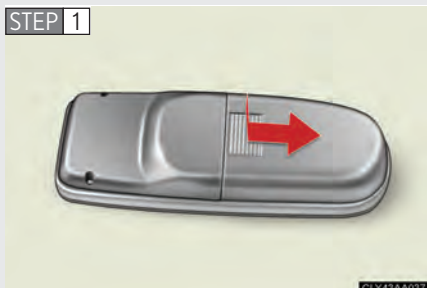

Remove the cover.

#### STEP 2

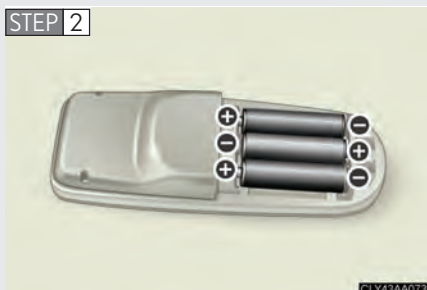

Remove the depleted batteries and install the new them.

### ■ If the batteries are discharged

The following symptoms may occur.

- The rear seat entertainment system control will not function properly.
- The operational range is reduced.

### ■ When using 3 AA batteries

- Batteries can be purchased at your Lexus dealer, electric appliance shop, or camera stores.
- Replace only with the same or equivalent type recommended by a Lexus dealer.
- Dispose of used batteries according to the local laws.

 **CAUTION****■ Removed battery and other parts**

Keep away from children.

These parts are small and if swallowed by a child they can cause choking.

 **NOTICE****■ For normal operation after replacing the battery**

Observe the following precautions to prevent accidents.

- Always work with dry hands.  
Moisture may cause the battery to rust.
- Do not touch or move any other components inside the remote control.
- Do not bend either of the battery terminals.

## 4-3. Do-it-yourself maintenance

# Checking and replacing fuses

If any of the electrical components do not operate, a fuse may have blown. If this happens, check and replace the fuses as necessary.

**STEP 1** Turn the engine switch to the LOCK position.

**STEP 2** Open the fuse box cover.

► Engine compartment



Push the tabs in and lift the lid off.



► Driver's side instrument panel

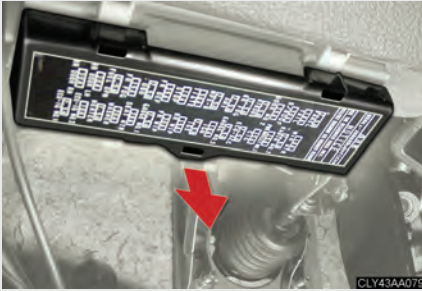

Remove the lid.

**STEP 3** After a system failure, see “Fuse layout and amperage ratings” (→P. 363) for details about which fuse to check.

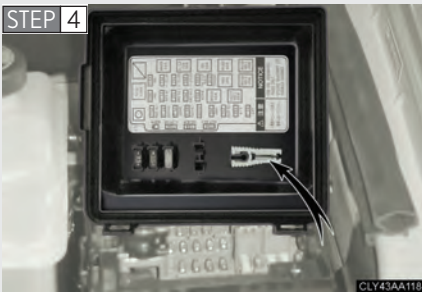

Remove the fuse with the pull-out tool.

**STEP 5** Check if the fuse has blown.

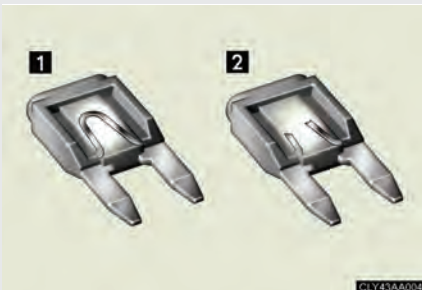

► Type A

**1** Normal fuse

**2** Blown fuse

Replace it with one of an appropriate amperage rating. The amperage rating can be found on the fuse box lid.

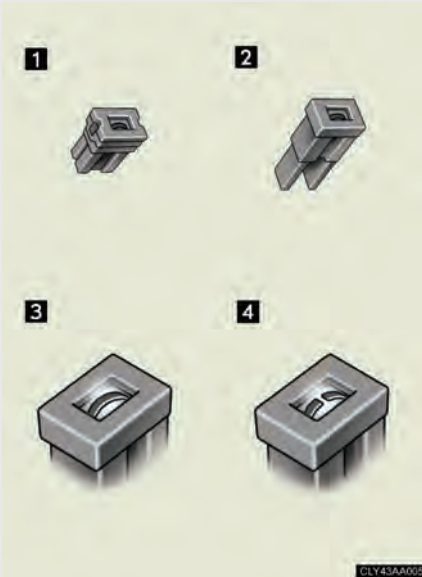

► Type B and C

- 1** Type B
- 2** Type C
- 3** Normal fuse
- 4** Blown fuse

Replace it with one of an appropriate amperage rating. The amperage rating can be found on the fuse box lid.

## Fuse layout and amperage ratings

### ■ Engine compartment (type A)

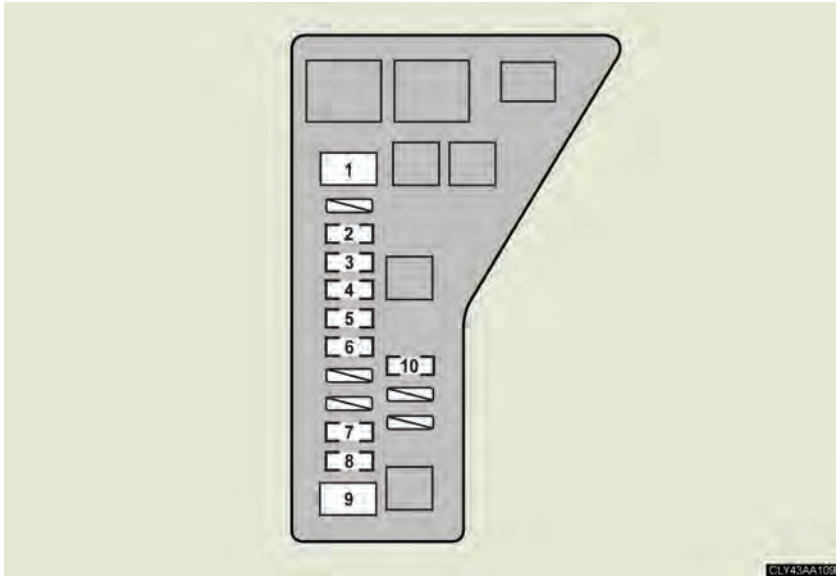

|    | Fuse     | Ampere | Circuit                                |
|----|----------|--------|--|
| 1  | ABS MTR2 | 30     | Electronically controlled brake system |
| 2  | ETCS     | 10     | Hybrid system                          |
| 3  | DC/DC-S  | 10     | Hybrid system                          |
| 4  | ABS NO.2 | 10     | Electronically controlled brake system |
| 5  | ABS NO.1 | 10     | Electronically controlled brake system |
| 6  | BATT FAN | 15     | Hybrid system                          |
| 7  | ABS NO.3 | 15     | Electronically controlled brake system |
| 8  | OIL PUMP | 10     | Transaxle fluid cooling system         |
| 9  | ABS MTR1 | 30     | Electronically controlled brake system |
| 10 | ST       | 7.5    | Hybrid system                          |

■ Engine compartment (type B)

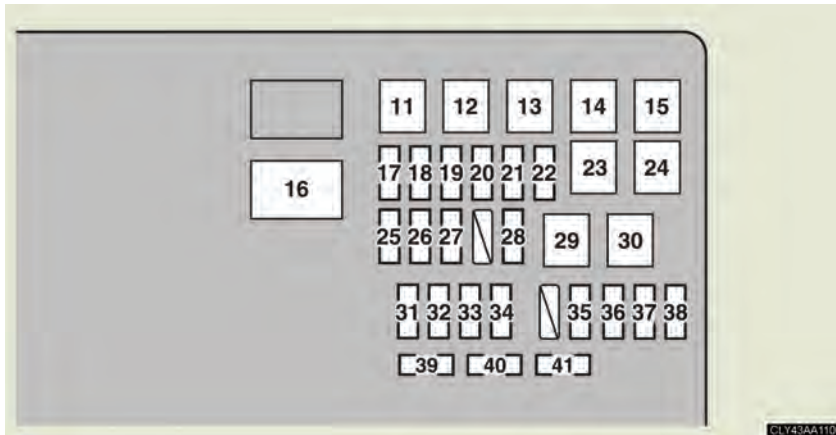

| Fuse |                 | Ampere | Circuit                                    |
|------|-----------------|--------|--|
| 11   | HEATER          | 50     | Air conditioning system, "WATER PUMP" fuse |
| 12   | IG1             | 30     | "SEAT HTR" fuse                            |
| 13   | H-LP CLN        | 30     | Headlight cleaner                          |
| 14   | RR DEF          | 40     | Rear window defogger                       |
| 15   | RDI FAN No.1    | 40     | Electric cooling fan                       |
| 16   | DC/DC           | 120    | Hybrid system                              |
| 17   | DRL             | 7.5    | Daytime running light system               |
| 18   | H-LP L LWR      | 15     | Left-hand headlight (low beam)             |
| 19   | H-LP L UPR      | 15     | Left-hand headlight                        |
| 20   | H-LP R UPR      | 15     | Right-hand headlight (high beam)           |
| 21   | PER OUTLET NO.2 | 20     | Power outlet (115 VAC)                     |
| 22   | TOWING          | 30     | Trailer lights                             |
| 23   | PBD             | 30     | Power back door                            |

|    | Fuse         | Ampere | Circuit   |
|----|--------------|--------|---|
| 24 | RDI FAN NO.2 | 40     | Electric cooling fan  |
| 25 | HAZ          | 15     | Turn signal lights, emergency flashers  |
| 26 | MPX-B1       | 7.5    | Electric power steering system  |
| 27 | AM2 NO.1     | 30     | “GAUGE NO.2”, “IGN”, “INJ” and “ST” fuses   |
| 28 | HORN         | 10     | Horns   |
| 29 | MAIN         | 40     | “H-LP L LWR”, “H-LP L UPR”, “H-LP R LWR”, “H-LP R UPR” and “DRL” fuses  |
| 30 | IGCT NO.1    | 50     | “INV W/P”, “IGCT NO.2”, “IGCT NO.3”, “IGCT NO.4” and “IGCT NO.5” fuses  |
| 31 | RADIO NO.1   | 15     | Audio system  |
| 32 | ECU-B NO.1   | 7.5    | Theft deterrent system, air conditioning system, gauges and meters, moon roof, multiplex communication system |
| 33 | DOME         | 7.5    | Personal lights, interior lights, vanity lights, engine switch light, gauges and meters, navigation system    |
| 34 | ECU-B NO.2   | 7.5    | Wireless remote control   |
| 35 | AMP          | 30     | Audio system  |
| 36 | DOOR NO.1    | 25     | Power door lock system  |
| 37 | A/F          | 25     | Air/fuel control system   |
| 38 | CRT          | 7.5    | Navigation system screen, rear seat entertainment system  |
| 39 | H-LP R LWR   | 15     | Right-hand headlight (low beam)   |
| 40 | INV W/P      | 15     | Hybrid system   |

|    | Fuse      | Ampere | Circuit       |
|----|-----------|--------|---------------|
| 41 | IGCT NO.5 | 10     | Hybrid system |

■ Engine compartment (type C)

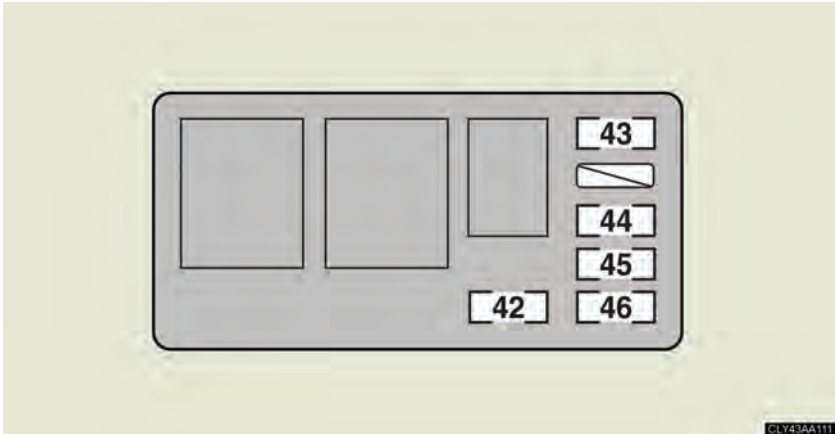

|    | Fuse       | Ampere | Circuit  |
|----|------------|--------|--|
| 42 | WATER PUMP | 10     | Air conditioning system  |
| 43 | SEAT HTR   | 20     | Seat heaters   |
| 44 | IGCT NO.2  | 10     | Hybrid system  |
| 45 | IGCT NO.3  | 10     | Hybrid system, Fuel pump   |
| 46 | IGCT NO.4  | 10     | Emission control system, transaxle control system, air/fuel control system |

## Driver's side instrument panel

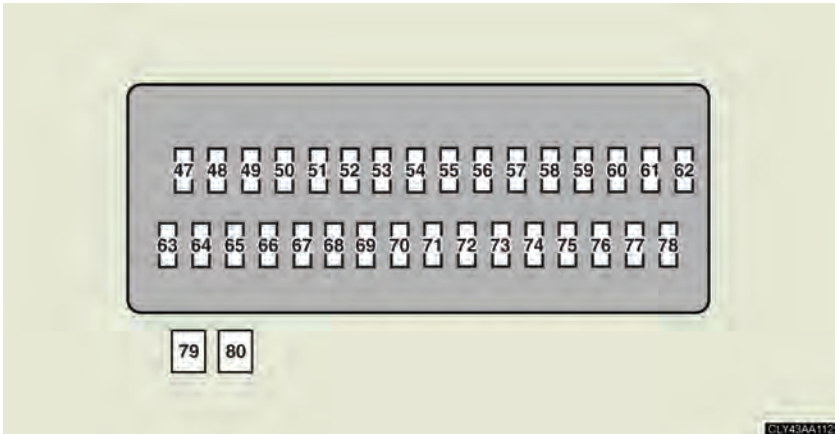

| Fuse |            | Ampere | Circuit  |
|------|------------|--------|--|
| 47   | RR DOOR RH | 20     | Rear right side power window   |
| 48   | RR DOOR LH | 20     | Rear left side power window  |
| 49   | FUEL OPN   | 7.5    | Fuel filler door opener  |
| 50   | FR FOG     | 15     | Front fog lights   |
| 51   | OBD        | 7.5    | On-board diagnosis system  |
| 52   | FR DEF     | 25     | Windshield wiper de-icer and all components in "MIR HTR" fuses   |
| 53   | STOP       | 10     | Tail lights, high mounted stoplight, vehicle dynamics integrated management, shift lock control system, multiport fuel injection system/sequential multiport fuel injection system |
| 54   | TI&TE      | 30     | Tilt and telescopic steering   |
| 55   | MPX-B      | 7.5    | Engine immobilizer system  |
| 56   | AM1        | 7.5    | Starter system   |
| 57   | RR FOG     | 7.5    | No circuit   |

### 4-3. Do-it-yourself maintenance

|    | Fuse        | Ampere | Circuit  |
|----|-------------|--------|--|
| 58 | AIR SUS     | 7.5    | No circuit   |
| 59 | DOOR NO.2   | 25     | Multiplex communication system   |
| 60 | S/ROOF      | 30     | Moon roof  |
| 61 | TAIL        | 10     | Front fog lights, instrument cluster lights, instrument panel lights, front side marker lights, tail lights, license plate lights, towing converter  |
| 62 | PANEL       | 7.5    | Glove box light, instrument cluster lights, instrument panel lights, console box light, audio system, power outlet, garage door opener switch, transmission system, headlight cleaner, seat heaters, steering switches, power back door  |
| 63 | ECU-IG NO.1 | 7.5    | Power rear view mirror control, moon roof, multiplex communication system, shift lock control system, multiplex communication system (power door lock system, wireless remote control system), driving position memory system, vehicle dynamics integrated management, windshield wipers, transmission, seat heaters, power seats, tilt and telescopic steering, power back door |
| 64 | ECU-IG NO.2 | 10     | Automatic headlight leveling system, vehicle dynamics integrated management, dynamic laser cruise control, headlight cleaner, adaptive front-lighting system   |

| Fuse |                 | Ampere | Circuit   |
|------|-----------------|--------|---|
| 65   | HEATER          | 7.5    | Electric cooling fan, air conditioning system, rear window defogger, engine switch, windshield wiper de-icer  |
| 66   | WASHER          | 20     | Windshield washer   |
| 67   | SEAT HTR        | 20     | No circuit  |
| 68   | GAUGE NO.1      | 7.5    | Instrument cluster lights, instrument panel lights, emergency flashers, seat belt, power outlet, multiport fuel injection system/sequential multiport fuel injection system, back-up lights   |
| 69   | FR WIP          | 30     | Windshield wipers   |
| 70   | RR WIP          | 15     | Rear window wiper   |
| 71   | INJ             | 20     | Multiport fuel injection system/ sequential multiport fuel injection system   |
| 72   | IGN             | 10     | SRS airbag system, multiport fuel injection system/sequential multiport fuel injection system, front passenger occupant classification system, stop lights, hybrid vehicle immobilizer system |
| 73   | GAUGE NO.2      | 7.5    | Gauge and meters  |
| 74   | ECU-ACC         | 7.5    | Navigation system display, power rear view mirror control, shift lock control system, multiplex communication system  |
| 75   | CIG             | 15     | Power outlet  |
| 76   | PWR OUTLET NO.1 | 15     | Power outlet  |

| Fuse |            | Ampere | Circuit   |
|------|------------|--------|---|
| 77   | RADIO NO.2 | 7.5    | Instrument cluster lights, instrument panel lights, navigation system, audio system   |
| 78   | MIR HTR    | 10     | Outside rear view mirror defogger   |
| 79   | PWR        | 30     | Power window, multiplex communication system (power door lock system, wireless remote control system), outside rear view mirror |
| 80   | P/SEAT     | 30     | Power seats   |

#### ■ After a fuse is replaced

- If the lights do not turn on even after the fuse has been replaced, a bulb may need replacement. (→P. 373)
- If the replaced fuse blows again, have the vehicle inspected by your Lexus dealer.

#### ■ If there is an overload in the circuits

The fuses are designed to blow before the entire wiring harness is damaged.

### CAUTION

#### ■ To prevent system breakdowns and vehicle fire

Observe the following precautions.

Failing to do so may cause damage, and possibly a fire or injury.

- Never use a fuse of a higher amperage rating than indicated, or use any other object in place of a fuse.
- Always use a genuine Lexus fuse or equivalent.  
Never replace a fuse with a wire, even as a temporary fix.  
This can cause extensive damage or even fire.
- Do not modify fuses or the fuse box.

 NOTICE**■ Before replacing fuses**

Have the cause of electrical overload determined and repaired by your Lexus dealer.

## Headlight aim (vehicles with discharge headlights)

### Vertical movement adjusting screw and bolt

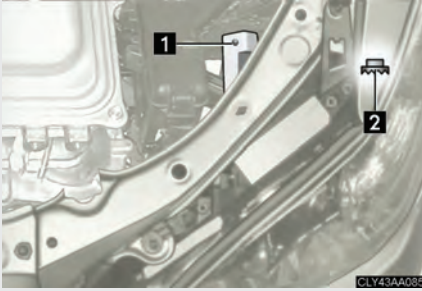

1 Adjustment screw

2 Adjustment bolt

### Before checking the headlight aim

**STEP 1** Make sure the vehicle has a full tank of gas and the area around the headlight is not deformed.

**STEP 2** Park the vehicle on level ground.

**STEP 3** Sit in the driver's seat.

**STEP 4** Bounce the vehicle several times.

### Adjusting the headlight aim

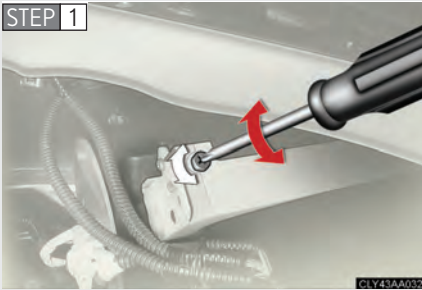

Turn the screw in either direction using a Phillips-head screwdriver.

Remember the turning direction and the number of turns in mind.

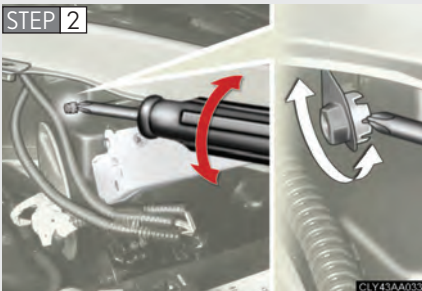

Turn the bolt the same number of turns and in the same direction as step 1 using a Phillips-head screwdriver.

If the error is over the value specified above, take the vehicle to your Lexus dealer to adjust the headlight aim.

## 4-3. Do-it-yourself maintenance

# Light bulbs

You may replace the following bulbs yourself. For more information about replacing other light bulbs, contact your Lexus dealer.

### ■ Prepare a replacement light bulb.

Check the wattage of the light bulb being replaced. (→P. 449)

### ■ Remove the engine compartment cover.

→P. 325

### ■ Turn the power back door main switch OFF.

→P. 45

### ■ Front bulb locations

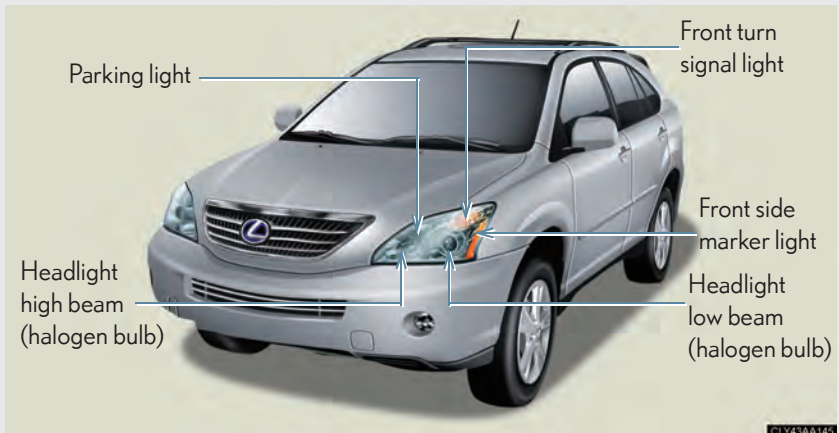

### Rear bulb locations

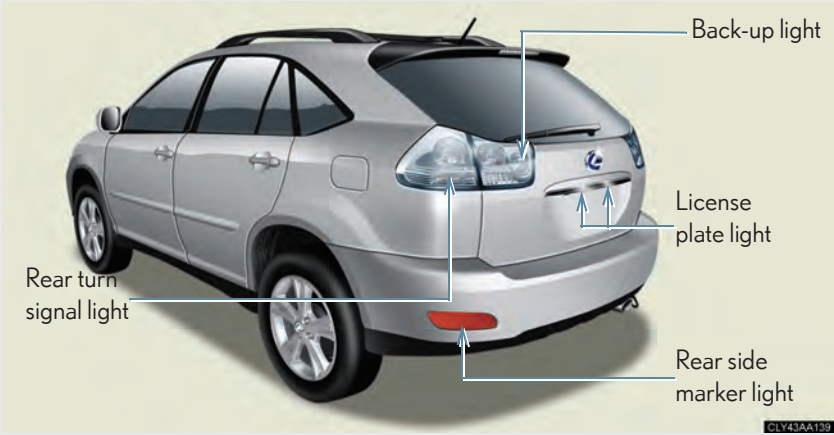

### Replacing light bulbs

#### Headlight high beam (halogen bulb)

STEP 1

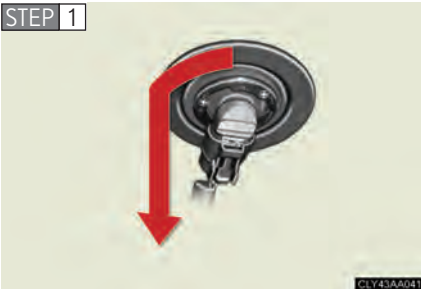

Turn the bulb base counterclockwise.

STEP 2

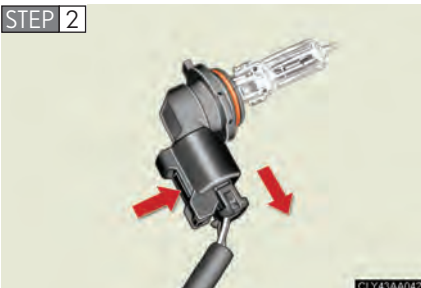

Unplug the connector while depressing the lock release.

### ■ Headlight low beam (halogen bulb)

STEP 1

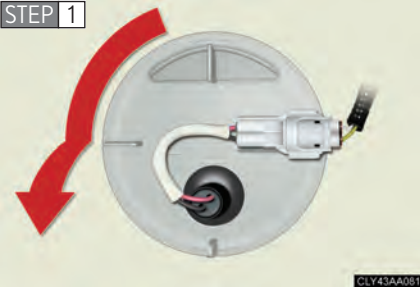

Turn the cover counterclockwise.

STEP 2



Turn the bulb base counterclockwise.

STEP 3



Unplug the connector while depressing the lock release.

### ■ Front turn signal lights

STEP 1

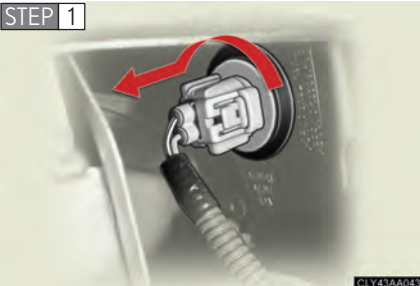

Turn the bulb base counterclockwise.

STEP 2

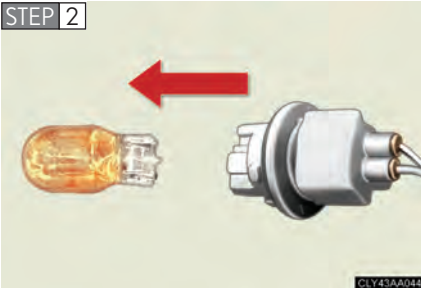

Remove the light bulb.

### ■ Front side marker lights

STEP 1

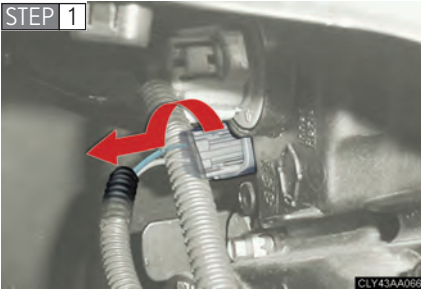

Turn the bulb base counterclockwise.

STEP 2

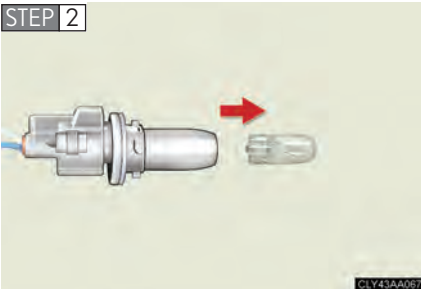

Remove the light bulb.

### ■ Parking lights

STEP 1

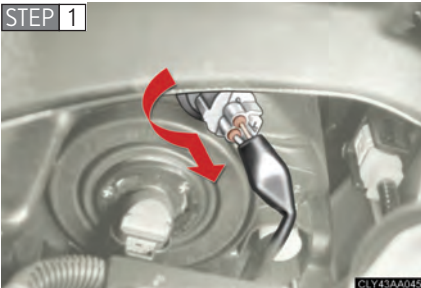

Turn the bulb base counterclockwise.

STEP 2



Remove the light bulb.

### Rear side marker lights

STEP 1

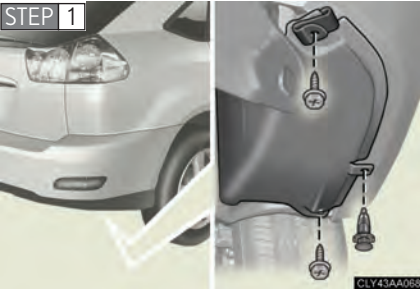

Right-hand side only:

Remove the bolts using a Phillips-head screwdriver and remove the clips.

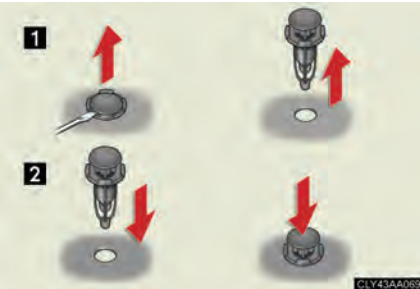

- 1 Removing clip
- 2 Installing clip

STEP 2

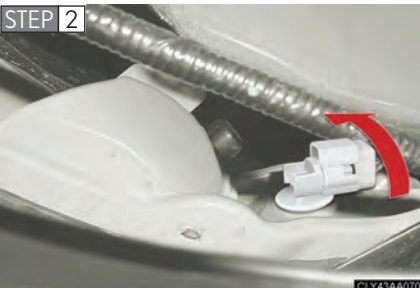

Turn the bulb base counterclockwise.

STEP 3

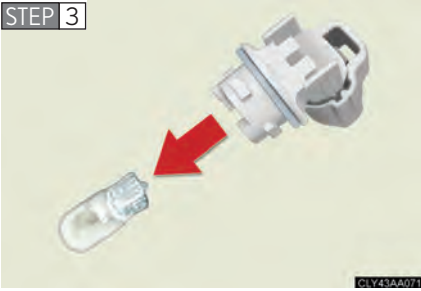

Remove the light bulb.

### Rear turn signal lights

STEP 1



Remove the access hole cover.

Use a flathead screwdriver which is wrapped with a cloth.

STEP 2



Turn the bulb base counterclockwise.

STEP 3



Remove the light bulb.

## ■ Back-up lights

STEP 1

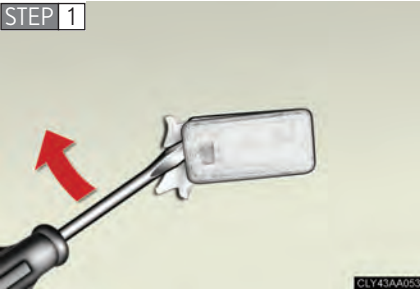

Open the back door and remove the luggage compartment light unit.

STEP 2

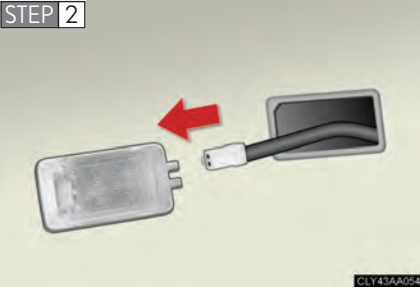

Pull out the connector.

STEP 3

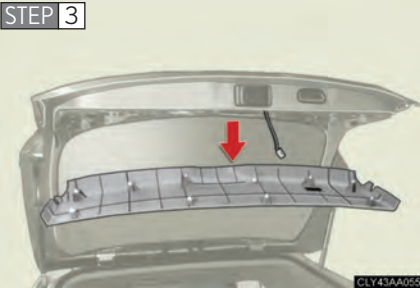

Remove the upper trim board.

STEP 4

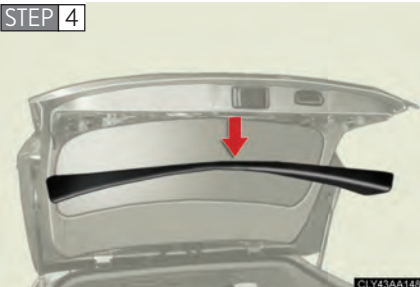

Remove the lower trim board.



Turn the bulb base counterclockwise.

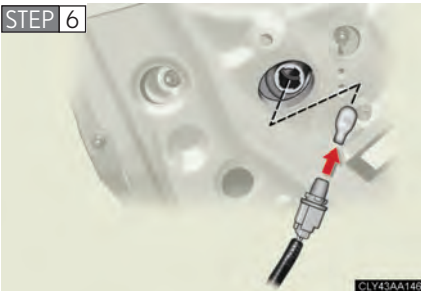

Remove the light bulb.

### ■ License plate lights

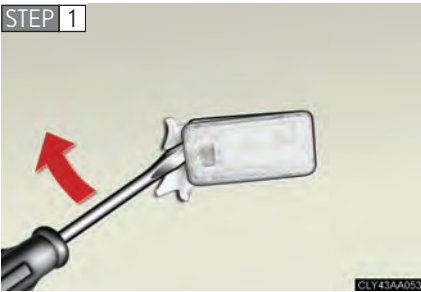

Open the back door and remove the luggage compartment light unit.

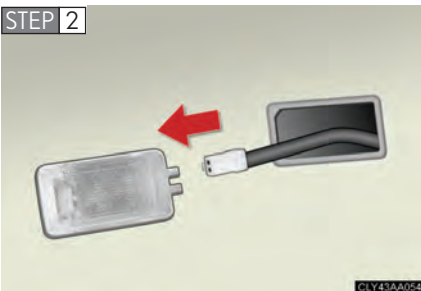

Pull out the connector.

## STEP 3

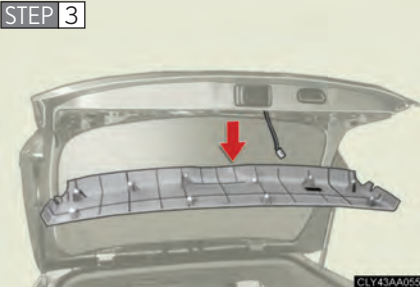

Remove the upper trim board.

## STEP 4

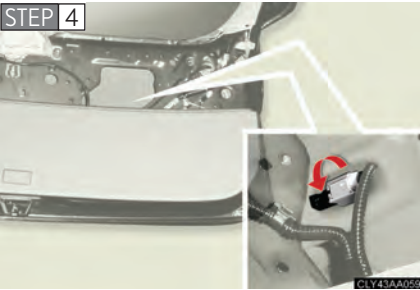

Turn the bulb base counterclockwise.

## STEP 5

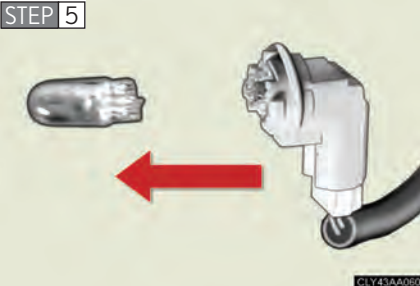

Remove the light bulb.

### ■ Bulbs other than the above

If any of the bulbs listed below has burnt out, have your Lexus dealer replace it.

- Headlight low beams (discharge bulbs)
- Fog lights
- Stop lights
- Tail lights
- High mounted stoplight

### ■ Condensation build-up on the inside of the lens

Contact your Lexus dealer for more information in the following situations. Temporary condensation build-up on the inside of the headlight lens does not indicate a malfunction.

- Large drops of water are built up on the inside of the lens.
- Water has built up inside the headlight.

### ■ Discharge headlights

If voltage to the discharge bulbs is insufficient, the bulbs may not come on, or may go out temporarily. The discharge bulbs will come on when normal power is restored.

### ■ LED stop lights

The stop lights, tail lights and high mounted stoplight consist of a number of LEDs. If any of the LEDs burn out, take your vehicle to your Lexus dealer to have the light replaced.

If two or more LEDs in a stop light burn out, your vehicle may not conform to local laws (SAE).

 **CAUTION****■ Replacing light bulbs**

- Turn off the headlights. Do not attempt to replace the bulb immediately after turning off the headlights.  
The bulbs become very hot and may cause burns.
- Do not touch the glass portion of the light bulb with bare hands. Hold the bulb by the plastic or metal portion.  
If the bulb is scratched or dropped it may blow out or crack.
- Fully install light bulbs and any parts used to secure them.  
Failing to do so may result in heat damage, fire, or water entering the headlight unit. This may damage the headlights or cause condensation to build up on the lens.
- Do not attempt to take apart or repair the low beam discharge headlight bulbs, connectors, power supply circuits, or related components.  
Doing so could result in electric shock and serious injury or death.

**■ Discharge headlights**

- Contact your Lexus dealer before replacing discharge headlights (including light bulbs).
- Do not touch the high-intensity discharge headlight's high voltage socket when the headlights are turned on.  
An extremely high voltage of 20000 V will be discharged and could result in serious injury or death by electric shock.

**■ To prevent damage or fire**

Make sure bulbs are fully seated and locked.



**5-1. Essential information .... 386**

If your vehicle needs to be  
towed ..... 386

If you think something is  
wrong ..... 393

Event data recorder ..... 394

**5-2. Steps to take in an  
emergency ..... 396**

If a warning light turns on  
or a warning buzzer  
sounds... ..... 396

If a warning message is  
displayed..... 406

If you have a flat tire..... 416

If the hybrid system will  
not start ..... 426

If the shift lever cannot be  
shifted from P ..... 427

If you lose your keys ..... 428

If the 12-volt battery is  
discharged ..... 429

If your vehicle overheats .... 432

If the vehicle becomes  
stuck..... 435

## 5-1. Essential information

# If your vehicle needs to be towed

If towing is necessary, we recommend having your vehicle towed by your Lexus dealer or a commercial towing service, using a lift-type truck or a flat bed truck.

Use a safety chain system for all towing, and abide by all state/provincial and local laws.

If towing from the front, the vehicle's rear wheels and axles must be in good condition. (→P. 390)

If they are damaged, use a towing dolly or flat bed truck.

### Before towing

The following may indicate a problem with your transmission. Contact your Lexus dealer before towing.

- The hybrid system is running, but the vehicle will not move.
- The vehicle makes an abnormal sound.

### Emergency towing

If a tow truck is not available, in an emergency your vehicle may be temporarily towed using a cable or chain secured to the emergency towing eyelet(s). This should only be attempted on hard, surfaced roads for short distances at low speeds.

A driver must be in the vehicle to steer and operate the brakes. The vehicle's wheels, drive train, axles, steering and brakes must be in good condition.



1 Towing eyelets

### ■ Emergency towing procedure

**STEP 1** Release the parking brake.

**STEP 2** Shift the shift lever to N.

**STEP 3** Turn the engine switch to the ACC (hybrid system off) or ON (hybrid system on) position.

### CAUTION

#### ■ Caution while towing

- Use extreme caution when towing the vehicle.  
Avoid sudden starts or erratic driving maneuvers which place excessive stress on the emergency towing eyelets and the cables or chains.
- If the hybrid system is not running, the power assist for the brakes and steering will not function, making steering and braking more difficult.

### NOTICE

#### ■ To prevent causing serious damage to the transmission

Never tow this vehicle from the rear with four wheels on the ground.  
This may cause serious damage to the transmission.

## Installing towing eyelets

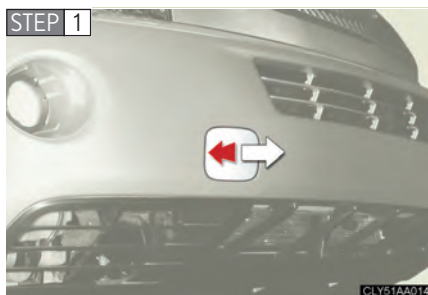

Remove the eyelet cover.

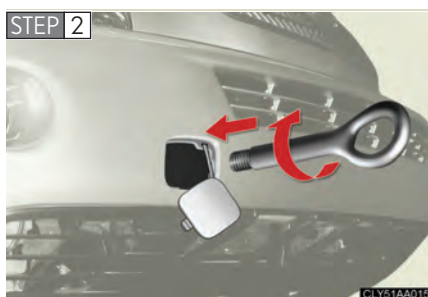

Insert the towing eyelet into the hole and tighten partially by hand.

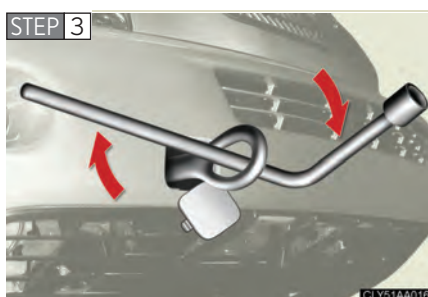

Tighten down the towing eyelet securely using a wheel nut wrench.

■ Location of the emergency towing eyelet

→P. 416

**⚠ CAUTION****■ Installing towing eyelets to the vehicle**

Make sure that towing eyelets are installed securely.

If not securely installed, towing eyelets may come loose during towing. This may lead to accidents that cause serious injury or even death.

**Towing with a sling-type truck****⚠ NOTICE****■ To prevent body damage**

Do not tow with a sling type truck, either from the front or rear.

### Towing with a wheel lift-type truck

- ▶ From the front (2WD models)



Release the parking brake.

- ▶ From the front (AWD models)

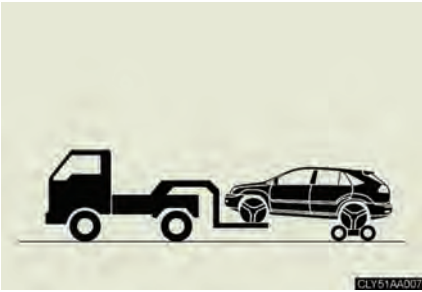

Use a towing dolly under the rear wheel.

#### NOTICE

- **To prevent damaging the vehicle**

When raising the vehicle, ensure adequate ground clearance for towing at the opposite end of the raised vehicle.

Without adequate clearance, the vehicle could be damaged while being towed.

- **To prevent causing serious damage to the transmission (AWD models)**

Never tow this vehicle from the front with the rear wheels on the ground.

► From rear



Use a towing dolly under the front wheels.

 NOTICE

■ To prevent causing serious damage to the transmission

Never tow this vehicle from the rear with the front wheels on the ground.

Using a flat bed truck

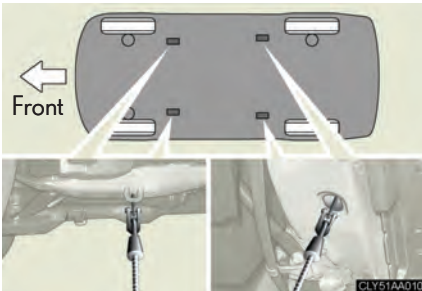

If your Lexus is transported by a flat bed truck, it should be tied down at the locations shown in the illustration.

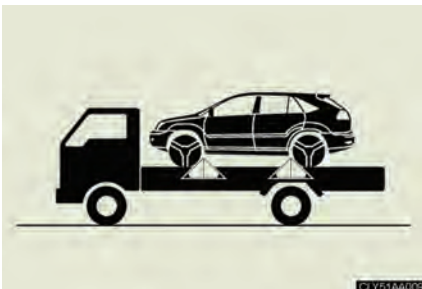

If you use chains or cables to tie down your vehicle, the angles shaded in black must be 45°.

Do not overly tighten the tie downs or the vehicle may be damaged.

 NOTICE

■ To avoid serious damage to your vehicle



Do not use the rear emergency towing eyelets.

# If you think something is wrong

If you notice any of the following symptoms, your vehicle probably needs adjustment or repair. Contact your Lexus dealer as soon as possible.

### ■ Visible symptoms

- Fluid leaks under the vehicle  
(Water dripping from the air conditioning after use is normal.)
- Flat-looking tires or uneven tire wear
- Engine coolant temperature gauge needle continually points higher than normal

### ■ Audible symptoms

- Changes in exhaust sound
- Excessive tire squeal when cornering
- Strange noises related to the suspension system
- Pinging or other noises related to the hybrid system

### ■ Operational symptoms

- Engine missing, stumbling or running rough
- Appreciable loss of power
- Vehicle pulls heavily to one side when braking
- Vehicle pulls heavily to one side when driving on a level road
- Loss of brake effectiveness, spongy feeling, pedal almost touches the floor

## 5-1. Essential information

# Event data recorder

Your vehicle has computers that monitor and control certain aspects of your vehicle. These computers assist in driving and maintaining optimal vehicle performance.

Besides storing data useful for troubleshooting, there is an event data recorder (EDR) that records data in a crash or a near car crash event.

### In a crash or a near car crash event

The SRS airbag sensor assembly contains the EDR. In a crash or a near car crash event, this device may record some or all of the following information:

- Gasoline engine speed
- Whether the brake pedal was applied or not
- Vehicle speed
- To what extent the accelerator pedal was depressed
- Position of the transmission shift lever
- Whether the driver and front passenger wore seat belts or not
- Driver's seat position
- Front passenger's occupant classification
- SRS airbag deployment data
- SRS airbag system diagnostic data

### If your vehicles is equipped with a vehicle stability control (VSC) system

The VSC Electronic Control Unit (ECU) may contain another EDR. In case the VSC or Brake Assist system is activated, or the lateral acceleration is beyond a certain value, this device may record some or all of the following information:

- Behavior of the vehicle

- Steering wheel angle
- Vehicle speed
- To what extent the accelerator pedal was depressed
- To what extent the brake pedal was applied
- To what extent the ECU controlled the condition of the 4 wheels
- Vehicle stability control system diagnostic data

The information above is intended to be used for the purpose of improving vehicle safety performance. Unlike general data recorders, the EDR does not record sound data such as conversation between passengers.

### Disclosure of the data

Lexus will not disclose the data recorded in an EDR to a third party except when:

- An agreement from the vehicle's owner (or the leasing company for a leased vehicle) is obtained
- Officially requested by the police or other authorities
- Used as a defense for Lexus in a law suit
- Ordered by a court law

However, if necessary Lexus will:

- Use the data for research on Lexus vehicle safety performance
- Disclose the data to a third party for research purposes without disclosing details of the vehicle owner, and only when it is deemed necessary
- Disclose summarized data cleared of vehicle identification information to a non-Lexus organization for research purposes





## 5-2. Steps to take in an emergency

### If a warning light turns on or a warning buzzer sounds...

Calmly perform the following actions if any of the warning lights turn on or flash. If a light turns on or flashes, but then turns off, this does not necessarily indicate a malfunction in the system.

**Stop the vehicle immediately. Continuing to drive the vehicle may be dangerous.**

The following warning indicates a possible problem in the brake system. Immediately stop the vehicle in a safe place and contact your Lexus dealer.

| Warning light  | Warning light/Details   |
|--|---|
|  (U.S.A.)<br> (Canada)   | <b>Brake system warning light (warning buzzer)*</b> <ul style="list-style-type: none"><li>• Low brake fluid</li><li>• Malfunction in the electronically controlled brake system</li></ul> This light also comes on when the parking brake is not released. If the light turns off after the parking brake is fully released the system is operating normally. |
|  (U.S.A.)<br> (Canada)<br> | <b>Brake system warning light</b><br>Indicates a malfunction in the vehicle's brake system.   |

\*: Parking brake engaged warning buzzer:

→P. 410





**Stop the vehicle immediately.**





The following warnings indicate the possibility of damage to the vehicle that may lead to an accident. Immediately stop the vehicle in a safe place and contact your Lexus dealer.

| Warning light   | Warning light/Details   |
|---|---|
|  | <b>Charging system warning light</b><br>Indicates a malfunction in the vehicle's charging system. |

**Have the vehicle inspected by your Lexus dealer immediately.**





Failing to investigate the cause of the following warnings may lead to the system operating abnormally and possibly cause an accident. Have the vehicle inspected by your Lexus dealer immediately.



| Warning light  | Warning light/Details   |
|--|---|
|  (U.S.A.) | <b>Malfunction indicator lamp</b><br>Indicates a malfunction in:<br><ul style="list-style-type: none"> <li>• The electronic engine control system or</li> <li>• The electronic throttle control system.</li> </ul>                                    |
|  (Canada) |   |
|         | <b>Hybrid battery warning light</b><br>Indicates a malfunction in the vehicle's hybrid battery.   |
|         | <b>SRS warning light</b><br>Indicates a malfunction in:<br><ul style="list-style-type: none"> <li>• The SRS airbag system;</li> <li>• The front passenger occupant classification system; or</li> <li>• The seat belt pretensioner system.</li> </ul> |

| Warning light  | Warning light/Details  |
|--|--|
|  (U.S.A.)<br> (Canada) | <p><b>ABS warning light</b></p> <p>Indicates a malfunction in:</p> <ul style="list-style-type: none"> <li>• The ABS;</li> <li>• The brake assist system.</li> </ul>  |
|   | <p><b>Brake system warning light</b></p> <p>Indicates a malfunction in:</p> <ul style="list-style-type: none"> <li>• Electronically controlled brake system; or</li> <li>• Regenerative brake system.</li> </ul> |
|   | <p><b>Electric power steering warning light</b></p> <p>Malfunction in the EPS.</p>   |

**Follow the correction procedures.**

After taking the specified steps to correct the suspected problem, check that the warning light turns off.

| Warning light  | Warning light/Details   | Correction procedure       |
|--|---|----------------------------|
|   | <p><b>Open door warning light (warning buzzer)</b><br/>Indicates that one or more of the doors is not fully closed.</p>                           | Close the indicated doors. |
|   | <p><b>Low fuel level warning light</b><br/>Remaining fuel (Approximately 2.6 gal. [9.8L, 2.2 Imp.gal.] or less)</p>                               | Refuel the vehicle.        |
|   | <p><b>Driver's seat belt reminder light (warning buzzer)*<sup>1</sup></b><br/>Warns the driver to fasten his/her seat belt.</p>                   | Fasten the seat belt.      |
|  | <p><b>Front passenger's seat belt reminder light (warning buzzer)*<sup>2</sup></b><br/>Warns the front passenger to fasten his/her seat belt.</p> | Fasten the seat belt.      |

| Warning light   | Warning light/Details  | Correction procedure   |
|---|--|--|
|  | <b>Tire pressure warning light</b>   |  |
|   | When the light comes on:<br>Low tire inflation pressure.   | Adjust the tire inflation pressure.  |
|   | When the light comes on after blinking for 1 minute:<br>Malfunction in the tire pressure warning system  | Have the system inspected by your Lexus dealer.  |
|  | <b>Master warning light</b><br>A buzzer sounds and the warning light comes on and flashes to indicate that the master warning system has detected a malfunction. | Take appropriate action in accordance with the message displayed on the multi-information display. |

**\*1: Driver's seat belt reminder:**

The driver's seat belt reminder sounds to alert the driver that his or her seat belt is not fastened. Once the engine switch is turned to the ON or START position, the buzzer sounds for 4 to 8 seconds. If the vehicle has reached a speed of at least 12 mph (20 km/h), the buzzer sounds intermittently for 10 seconds. Then, if the seat belt is still unfastened, the buzzer will sound in a different tone for 20 more seconds.

**\*2: Front passenger's seat belt reminder:**

The front passenger's seat belt reminder sounds to alert the front passenger that his or her seat belt is not fastened. The buzzer sounds intermittently for 10 seconds after the vehicle has reached a speed of at least 12 mph (20 km/h). Then, if the seat belt is still unfastened, the buzzer will sound in a different tone for 20 more seconds.

---

**■ Key reminder buzzer**

The buzzer indicates that the key has not been removed from the engine switch (with the engine switch in the ACC or LOCK position and the driver's door opened).

**■ If the malfunction indicator lamp comes on while driving**

First check the following:

- Is your vehicle low on gas?  
If it is, refuel the vehicle immediately.
- Is the fuel tank cap loose?  
If it is, tighten it securely.

The lamp will go off after taking several driving trips.

If the light does not go off even after several trips, contact your Lexus dealer as soon as possible.

**■ Front passenger detection sensor and passenger seat belt reminder**

- If luggage is placed on the front passenger seat, the front passenger detection sensor may cause the warning light to flash, even if a passenger is not sitting in the seat.
- If a cushion is placed on the seat, the sensor may not detect a passenger, and the warning light may not operate properly.

**■ Changing the engine oil (U.S.A. only)**

Make sure to reset the oil change system. (→P. 329)

**■ When the tire pressure warning light comes on**

Check the tire inflation pressure and adjust to the appropriate level. Pushing the tire pressure warning reset switch does not turn off the tire pressure warning light.

**■ The tire pressure warning light may turn on due to natural causes**

The tire pressure warning light may turn on due to natural causes such as natural air leaks or tire inflation pressure changes caused by temperature. In this case, adjusting the tire inflation pressure will turn off the warning light (after a few minutes).

### ■ When a tire is replaced with a spare tire

The spare tire is also equipped with the tire pressure warning valve and transmitter. The tire pressure warning light will turn on if the tire inflation pressure of the spare tire is low. If a tire goes flat, even though the flat tire is replaced with the spare tire, the tire pressure warning light does not turn off. Replace the spare tire with the repaired tire and adjust the proper tire inflation pressure. The tire pressure warning light will turn off after a few minutes.

### ■ If the tire pressure warning system is inoperative

The tire pressure warning system may become inoperative in the following conditions:

(When the condition becomes normal, the system will work properly.)

- If tires not equipped with tire pressure warning valves and transmitters are used.
- If the ID code on the tire pressure warning valves and transmitters is not registered in the tire pressure warning computer.
- If the tire pressure warning select switch is set to a different tire setting.
- If the tire inflation pressure is 73 psi (500 kPa, 5.1 kgf/cm<sup>2</sup> or bar) or higher.
- If electronic devices or facilities using similar radio wave frequencies are nearby.
- If a large metallic object which can interfere with signal reception is put in the trunk.
- If a radio set at similar frequencies is in use in the vehicle.
- If a window tint that affects the radio wave signals is installed.
- If there is a lot of snow or ice on the vehicle, in particular around the wheels or wheel housings.
- If non-genuine Lexus wheels are used. (Even if you use Lexus wheels, the tire pressure warning system may not work properly with some types of tires.)
- If tire chains are used.
- If the spare tire is in a location subject to poor radio wave signal reception.
- If the tire pressure warning select switch is set to a different tire setting.

### ■ If the tire pressure warning light comes on after blinking for 1 minute frequently

If the tire pressure warning light comes on after blinking for 1 minute frequently when the engine switch is turned to ON position, have it checked by your Lexus dealer.

 **CAUTION****■ If the tire pressure warning light comes on**

Be sure to observe the following precautions. Failure to do so could cause loss of vehicle control and result in death or serious injury.

- Stop your vehicle in a safe place as soon as possible. Adjust the tire inflation pressure immediately.
- If the tire pressure warning light comes on even after tire inflation pressure adjustment, it is probable that you have a flat tire. Check the tires. If the tire is flat, change to the spare tire and have the flat tire repaired by the nearest Lexus dealer.
- Avoid abrupt maneuvering and braking. If the vehicle tires deteriorate, you could lose control of the steering wheel or the brakes.

**■ If a blowout or sudden air leakage should occur**

The tire pressure warning system may not activate immediately.

### CAUTION

#### ■ Maintenance of the tires

Each tire, including the spare (if provided), should be checked monthly when cold and inflated to the inflation pressure recommended by the vehicle manufacturer on the vehicle placard or tire inflation pressure label (tire and load information label). (If your vehicle has tires of a different size than the size indicated on the vehicle placard or tire inflation pressure label [tire and load information label], you should determine the proper tire inflation pressure for those tires.)

As an added safety feature, your vehicle has been equipped with a tire pressure monitoring system (TPMS-tire pressure warning system) that illuminates a low tire pressure telltale (tire pressure warning light) when one or more of your tires is significantly under-inflated. Accordingly, when the low tire pressure telltale (tire pressure warning light) illuminates, you should stop and check your tires as soon as possible, and inflate them to the proper pressure. Driving on a significantly under-inflated tire causes the tire to overheat and can lead to tire failure. Under-inflation also reduces fuel efficiency and tire tread life, and may affect the vehicle's handling and stopping ability.

Please note that the TPMS (tire pressure warning system) is not a substitute for proper tire maintenance, and it is the driver's responsibility to maintain correct tire pressure, even if under-inflation has not reached the level to trigger illumination of the TPMS low tire pressure telltale (tire pressure warning light).

Your vehicle has also been equipped with a TPMS (tire pressure warning system) malfunction indicator to indicate when the system is not operating properly. The TPMS (tire pressure warning system) malfunction indicator is combined with the low tire pressure telltale (tire pressure warning light). When the system detects a malfunction, the telltale will flash for approximately one minute and then remain continuously illuminated. This sequence will continue upon subsequent vehicle start-ups as long as the malfunction exists. When the malfunction indicator is illuminated, the system may not be able to detect or signal low tire pressure as intended.

TPMS (tire pressure warning system) malfunctions may occur for a variety of reasons, including the installation of replacement or alternate tires or wheels on the vehicle that prevent the TPMS (tire pressure warning system) from functioning properly. Always check the TPMS (tire pressure warning system) malfunction telltale after replacing one or more tires or wheels on your vehicle to ensure that the replacement or alternate tires and wheels allow the TPMS (tire pressure warning system) to continue to function properly.

 NOTICE**■ Precaution when installing a different tire**

When a tire of a different specification or maker is installed, the tire pressure warning system may not operate properly.

## 5-2. Steps to take in an emergency

### If a warning message is displayed

If a warning is shown on the multi-information display, stay calm and perform the following actions:



#### 1 Master warning light



The master warning light also comes on or flashes in order to indicate that a message is currently being displayed on the multi-information display.



#### 2 Multi-information display

If any of the warning light turns on again after performing the following actions, contact your Lexus dealer.

### Stop the vehicle immediately.

A buzzer sounds and a warning message is shown on the multi-information display. The following warnings indicate the possibility of damage to the vehicle that may lead to an accident. Immediately stop the vehicle in a safe place and contact your Lexus dealer.





| Warning message  | Details   |
|--|---|
| <p>LOW ENGINE<br/>OIL PRESSURE</p>  (Flashing) | <p>Indicates an abnormal engine oil pressure.</p> <p>The warning light may turn on if the engine oil pressure is too low.</p> |
| <p>CHECK<br/>HYBRID SYSTEM</p>                 | <p>Malfunction in the hybrid system.</p>  |

| Warning message   | Details                                    |
|---|--|
| <div data-bbox="114 266 373 394" style="background-color: black; color: white; padding: 10px; text-align: center;">CHECK<br/>AWD SYSTEM</div> <div data-bbox="114 407 210 469" style="text-align: center;">  </div>  | Indicates a malfunction in the AWD system. |
| <div data-bbox="114 500 373 628" style="background-color: black; color: white; padding: 10px; text-align: center;">WATER TEMP</div> <div data-bbox="114 641 210 703" style="text-align: center;">  </div> <div data-bbox="213 646 323 683" style="margin-left: 10px;">(Flashing)</div> | Indicates a hybrid system is over heating. |

**Have the vehicle inspected by your Lexus dealer immediately.**



A buzzer sounds and a warning message is shown on the multi-information display. Failing to investigate the cause of the following warnings may lead to the system operating abnormally and possibly cause an accident. Have the vehicle inspected by your Lexus dealer immediately.

| Warning message   | Details   |
|---|---|
| <div data-bbox="114 1057 373 1185" style="background-color: black; color: white; padding: 10px; text-align: center;">HEAD LIGHT<br/>LEVELING</div> <div data-bbox="114 1198 210 1260" style="text-align: center;">  </div> | Malfunction in the automatic headlight leveling system. |

| Warning message   | Details   |
|---|---|
| <p data-bbox="86 272 340 394">  <b>CHECK SYSTEM</b> </p> <p data-bbox="86 407 340 548">  (Flashing and then continuously on)<br/>  </p> | <p data-bbox="368 370 939 440">Indicates a malfunction in the tire pressure warning system. (→P. 340)</p> |
| <p data-bbox="86 581 340 711"> <b>CHECK VSC SYSTEM</b> </p> <p data-bbox="86 724 340 784">  (Flashing)                 </p>   | <p data-bbox="368 643 926 712">Malfunction in the traction control system or VSC system.</p>              |
| <p data-bbox="86 813 340 943"> <b>CHECK CRUISE SYSTEM</b> </p> <p data-bbox="86 956 340 1016"> <b>CRUISE</b> (Flashing)                 </p> <p data-bbox="86 1029 340 1089">  </p>   | <p data-bbox="368 911 932 980">Indicates a malfunction in the dynamic laser cruise control system.</p>    |



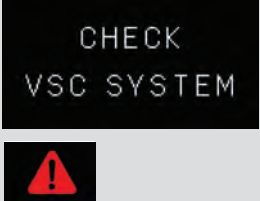



**Have the vehicle inspected by your Lexus dealer immediately.**



Failing to investigate the cause of the following warning may lead to the system operating abnormally and possibly cause an accident. Have the vehicle inspected by your Lexus dealer immediately.

| Warning message  | Details  |
|--|--|
|  <p>CHECK<br/>VSC SYSTEM</p> <p></p> | <p>Indicates a malfunction in the traction control, VSC systems.</p> |



**Have the malfunction repaired immediately.**







A buzzer sounds and a warning message is shown on the multi-information display. After taking the specified steps to correct the suspected problem, check that the warning message turns off.

| Warning message   | Details   | Correction procedure                               |
|---|---|--|
| <p>PASSENGER<br/>DOOR OPEN</p>   | <p>Indicates that one or more of the doors is not fully closed.</p>   | <p>Make sure that all of the doors are closed.</p> |
| <p>DRIVER<br/>DOOR OPEN</p>      | <p>The system also indicates which doors are not fully closed.</p>  |  |
| <p>RIGHT REAR<br/>DOOR OPEN</p>  | <p> flashes and a buzzer sounds to indicate that one or more of the doors is not fully closed (with the vehicle having reached a speed of 3 mph [5 km/h]).</p> |  |
| <p>LEFT REAR<br/>DOOR OPEN</p>  |   |  |
| <p>BACK DOOR<br/>OPEN</p>      |   |  |



| Warning message   | Details   | Correction procedure  |
|---|---|---|
| <p data-bbox="114 272 370 402">MOONROOF<br/>OPEN</p>  (Flashing) | <p data-bbox="397 277 663 456">Indicates that the moon roof is not fully closed (with the engine switch LOCK and the driver's door opened).</p>             | <p data-bbox="704 354 937 378">Close the moon roof.</p>       |
| <p data-bbox="114 505 370 630">PARK BRAKE</p>  (Flashing)        | <p data-bbox="397 509 678 688">Indicates that the parking brake is still engaged (with the vehicle having reached a speed of more than 3 mph [5 km/h]).</p> | <p data-bbox="704 570 921 630">Release the parking brake.</p> |
| <p data-bbox="114 737 370 862">LOW<br/>WASHER FLUID</p>          | <p data-bbox="397 802 678 862">Indicates that the washer fluid level is low.</p>  | <p data-bbox="704 818 894 842">Add washer fluid.</p>          |

## 5-2. Steps to take in an emergency

| Warning message  | Details   | Correction procedure  |
|--|---|---|
| <div data-bbox="82 358 341 488" style="background-color: black; color: white; padding: 10px; text-align: center;"> <p>MAINT REQD<br/>SOON</p> </div> <div data-bbox="86 500 178 561" style="display: inline-block; text-align: center;">  </div> <p data-bbox="139 561 279 594">(U.S.A. only)</p> | <p data-bbox="368 261 646 367">Indicates that the engine oil is scheduled to be changed.</p> <p data-bbox="368 386 653 675">Comes on approximately 4500 miles (7200 km) after the engine oil is changed. (The indicator will not work properly unless the oil maintenance data has been reset.)</p> | <p data-bbox="674 435 953 505">Check the engine oil, and change if necessary.</p> |
| <div data-bbox="82 740 341 870" style="background-color: black; color: white; padding: 10px; text-align: center;"> <p>MAINT REQD</p> </div> <div data-bbox="86 881 178 943" style="display: inline-block; text-align: center;">  </div> <p data-bbox="139 943 279 976">(U.S.A. only)</p>          | <p data-bbox="368 699 646 769">Indicates that the engine oil should be changed.</p> <p data-bbox="368 789 653 1003">Comes on approximately 5000 miles (8000 km) after the engine oil is changed (and the oil maintenance data has been reset).</p>  | <p data-bbox="674 821 923 891">Check and change the engine oil.</p>               |

| Warning message  | Details   | Correction procedure   |
|--|---|--|
|  <p>⚠ LOW TIRE</p>    | <p>Indicates low tire pressure.</p>   | <p>Check the tire inflation pressure, and adjust to the appropriate level.</p> |
|  <p>CLEAN<br/>RADAR SENSER</p> <p>(If equipped, flashing and then continuously on)</p>  (Flashing)  | <p>Indicates that the radar cruise control sensor is dirty or covered with ice.</p> | <p>Clean the sensor.</p>   |

## 5-2. Steps to take in an emergency

| Warning message   | Details  | Correction procedure   |
|---|--|--|
| <p><b>CRUISE<br/>NOT AVAILABLE</b></p> <p>(If equipped, flashing and then continuously on)</p> <p><b>CRUISE</b> (Flashing)</p>  | <p>Indicates that the radar cruise control system is unable to judge vehicle-to-vehicle distance.</p>    | <p>If the windshield wipers are on, turn them off or set them to either the intermittent or the slow mode.</p> |
|  <p><b>SET 65 MPH</b></p> <p><b>ODO 1234 MILES</b></p> <p>(If equipped, flashing)</p>   | <p>Indicates that your vehicle is nearing the vehicle ahead (in laser cruise mode).</p>                  | <p>Slow the vehicle by applying the brakes.</p>  |
| <p><b>SHIFT TO<br/>P RANGE</b></p>  (Flashing)  | <p>Indicates that the driver's door has been opened (with the shift lever out of in P, ignition on).</p> | <p>Shift the lever to P.</p>   |
| <p><b>SHIFT TO P<br/>WHEN STARTING</b></p>  (Flashing)  | <p>Indicates that the starting the hybrid system (with the shift lever out of in P).</p>                 | <p>Shift the lever to P and turn the ignition to START again.</p>  |

### ■ Changing the engine oil (U.S.A. only)

Make sure to reset the oil change system. (→P. 329)

### ■ Warning light display in radar cruise mode

In the following cases, the warning light may not be displayed even if vehicle-to-vehicle distance closes.

- When your vehicle and the vehicle ahead are traveling at the same speed or the vehicle ahead is traveling more quickly than your vehicle
- When the vehicle ahead is traveling at a very low speed
- Immediately after cruise control speed is set
- At the instant the accelerator pedal is depressed

### Have the malfunction repaired immediately.

After taking the specified steps to correct the suspected problem, check that the warning light turns off.

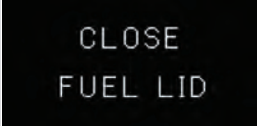
| Warning message   | Details   | Correction procedure       |
|---|---|----------------------------|
|  <p>CLOSE<br/>FUEL LID</p> <p>(Comes on for 8 seconds.)</p> | <p>Indicates that the fuel door left open after refueling when start the vehicle/ leave the fuel door open for more than 30 minutes during refueling.</p> | <p>Close the fuel lid.</p> |

## 5-2. Steps to take in an emergency If you have a flat tire

Remove the flat tire and replace it with the spare provided.

### ■ Before jacking up the vehicle

- Stop the vehicle on a hard, flat surface.
- Set the parking brake.
- Shift the shift lever to P.
- Stop the hybrid system.
- Turn on the emergency flashers.

### ■ Location of the spare tire, jack and tools

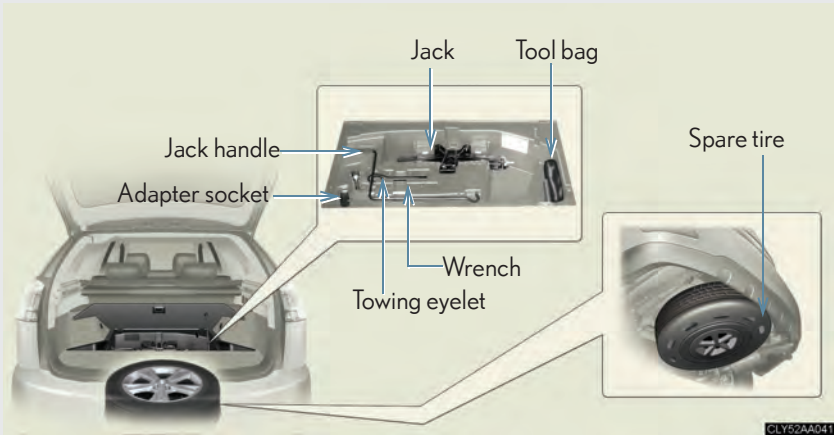

## Taking out the jack and tools

STEP 1

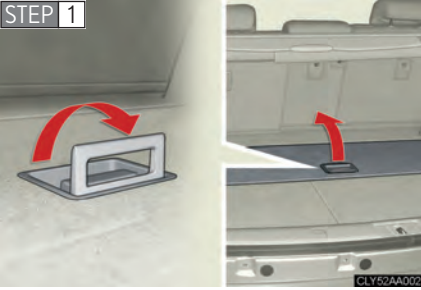

Pull up the front deck board.

STEP 2

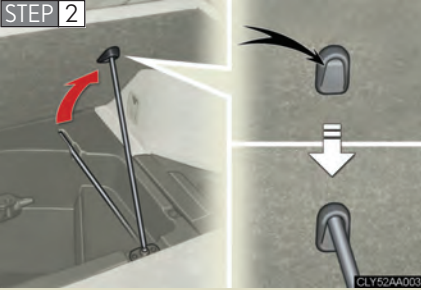

Hold the front deck board with the supporting rod.

When closing the board, return the supporting rod to its stored position.

STEP 3



- 1 Unhook
- 2 Loosen
- 3 Tighten

## Taking out the spare tire

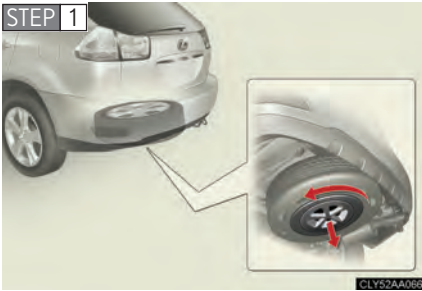

Remove the inside spare tire cover.

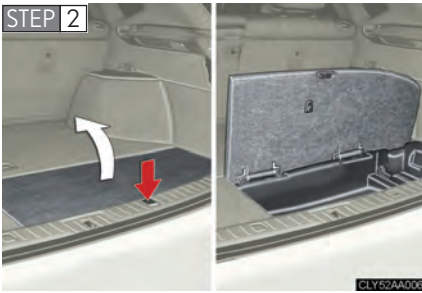

Open the right side auxiliary box.

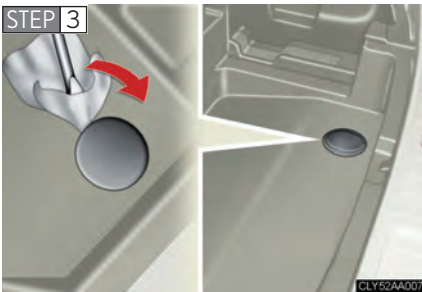

Remove the cover.

To protect the auxiliary box, place a rag between the screwdriver and the auxiliary box, as shown in the illustration.

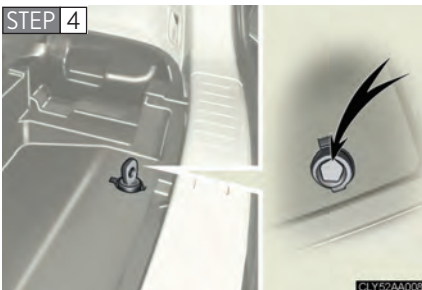

Attach the adapter socket (for removing a spare tire).

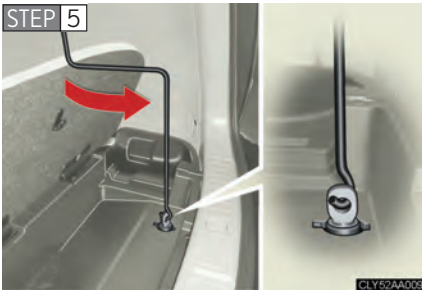

Connect the jack handle and the adapter socket. Turn the jack handle.

The tire will lower completely to the ground.

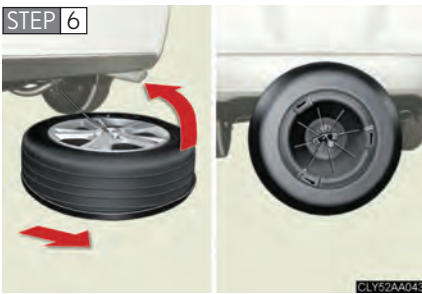

Pull out the spare tire and stand it up against the bumper.

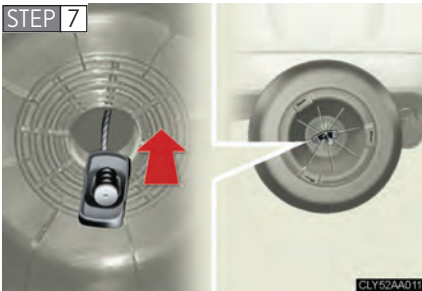

Remove the holding bracket.

## Replacing a flat tire

STEP 1



CLY52AA069

Check the tires.

| Flat tire |                 | Wheel chock positions                      |
|-----------|-----------------|--|
| Front     | Left-hand side  | Behind the rear right-hand side tire       |
|           | Right-hand side | Behind the rear left-hand side tire        |
| Rear      | Left-hand side  | In front of the front right-hand side tire |
|           | Right-hand side | In front of the front left-hand side tire  |

STEP 2

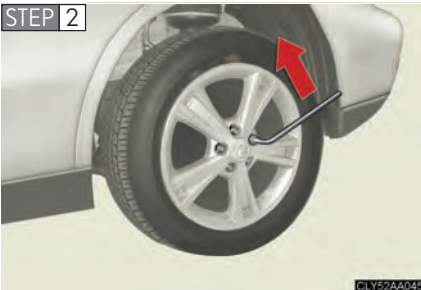

CLY52AA045

Slightly loosen the wheel nuts (one turn).

STEP 3



CLY52AA048

Turn the tire jack portion "A" by hand until the notch of the jack is in contact with the jack point.

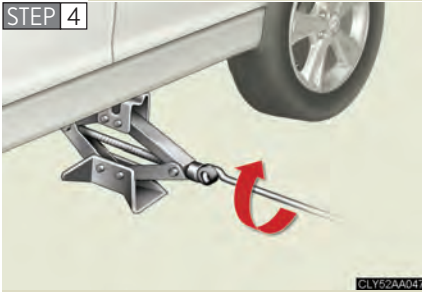

Raise the vehicle until the tire is slightly raised off the ground.



Remove all the wheel nuts and the tire.

When resting the tire on the ground, place the tire so that the wheel design faces up to avoid scratching the wheel surface.

## Installing the spare tire

STEP 1

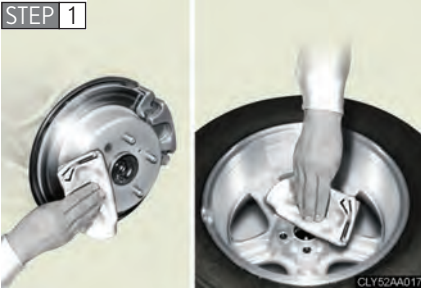

Remove any dirt or foreign matter from the wheel contact surface.

If foreign matter is on the wheel contact surface, the wheel nuts may loosen while the vehicle is in motion, and the tire may come off the vehicle.

STEP 2

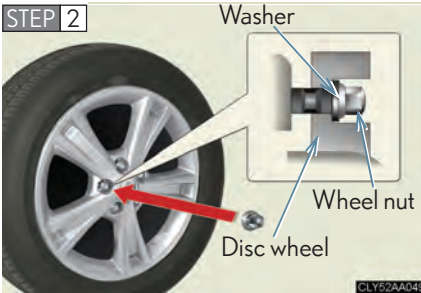

Install the spare tire and loosely tighten each nut by hand to approximately the same amount.

Tighten the wheel nuts until the tapered portion comes into loose contact with the disc wheel sheet.

STEP 3

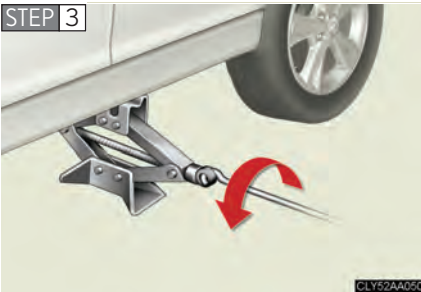

Lower the vehicle.

STEP 4

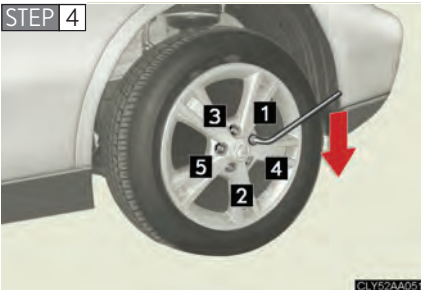

Firmly tighten each nut two or three times in the order shown in the illustration.

**Tightening torque:**  
76 ft•lbf (103 N•m, 10.5 kg•m)

## Stowing the flat tire, jack and all tools

**STEP 1** Install the inside spare tire cover on the outer side of the spare tire cover.

**STEP 2**

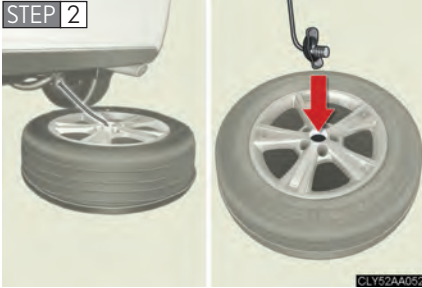

Put the flat tire in the spare tire cover with the outer side facing up and install the holding bracket.

**STEP 3** Turn the spare tire clamp bolt clockwise with a jack handle and adapter socket until you hear a click.

**STEP 4** Stow all the tools and jack securely.

### ■ After completing the tire change

The tire pressure warning system must be reset. (→P. 340)

### CAUTION

#### ■ Using the tire jack

Improper use of the tire jack may lead to death or injuries due to the vehicle suddenly falling off the jack.

- Do not use the tire jack for any purpose other than replacing tires or installing and removing tire chains.
- Only use the tire jack that comes with this vehicle for replacing a flat tire. Do not use it on other vehicles, and do not use other tire jacks for replacing tires on this vehicle.
- Always check that the tire jack is securely set to the jack point.
- Do not put any part of your body under the vehicle supported by a jack.
- Do not start or run the engine while your vehicle is supported by the jack.
- Do not raise the vehicle while someone is in it.
- When raising the vehicle, do not put an object on or under the jack.
- Do not raise the vehicle to a height greater than that required to replace the tire.
- Use a jack stand if it is necessary to get under the vehicle.

Take particular care when lowering the vehicle to ensure that no one working on or near the vehicle may be injured.

#### ■ Replacing a flat tire

Observe the following precautions to reduce the risk of death or serious injury:

- Never use oil or grease on the wheel bolts or wheel nuts.  
The oil or grease can cause the wheel nuts to loosen, causing a serious accident. Remove any oil or grease on the wheel bolts or wheel nuts.
- Have the wheel nuts tightened with a torque wrench to 76 ft•lbf (103 N•m, 10.5 kgf•m) as soon as possible after changing wheels.  
Failure to follow these precautions could cause the nuts to loosen and the wheels may fall off, which could lead to an accident causing death or serious injury.

 NOTICE**■ Do not drive the vehicle with a flat tire.**

Do not continue driving with a flat tire.

Driving even a short distance with a flat tire can damage the tire and the wheel beyond repair.

**■ When replacing the tires**

When removing or fitting the wheels, tires or the tire pressure warning valve and transmitter, contact your Lexus dealer as the tire pressure warning valve and transmitter may be damaged if not handled correctly.

**■ To avoid damaging the tire pressure warning valves and transmitters**

Do not use liquid sealants on flat tires.

**■ When stowing the flat tire**

- Ensure that there is no object caught between the tire and the vehicle underbody.
- Tighten the spare tire clamp bolt to hold the spare wheel carrier by the hook securely.

## 5-2. Steps to take in an emergency

### If the hybrid system will not start

If the hybrid system will not start, even though correct starting procedures are being followed (→P. 131), consider each of the following points.

■ **The hybrid system will not start even when the starter motor operates normally.**

One of the following may be the cause of the problem.

- There may not be sufficient fuel in the vehicle's tank.

Refuel your vehicle.

- The hybrid system may be flooded.

Try to restart the hybrid system once more following correct starting procedures. (→P. 131)

- There may be a malfunction in the hybrid vehicle immobilizer system. (→P. 83)

■ **The interior lights and headlights are dim, or the horn does not sound or sounds at a low volume.**

One of the following may be the cause of the problem.

- The 12-volt battery may be discharged. (→P. 429)

- The 12-volt battery terminal connections may be loose or corroded.

■ **The interior lights and headlights do not turn on, or the horn does not sound.**

One of the following may be the cause of the problem.

- One or both of the 12-volt battery terminals may be disconnected.

- The 12-volt battery may be discharged. (→P. 429)

Contact your Lexus dealer if the problem cannot be repaired, or if repair procedures are unknown.

## 5-2. Steps to take in an emergency

# If the shift lever cannot be shifted from P

If the shift lever cannot be shifted with your foot on the brake, there may be a problem with the shift lock system (a system to prevent accidental operation of the shift lever). Have the vehicle inspected by your Lexus dealer immediately.

The following steps may be used as an emergency measure to ensure that the shift lever can be shifted.

**STEP 1** Set the parking brake.

**STEP 2** Turn the engine switch to the ON position.

**STEP 3** Depress the brake pedal.

**STEP 4**

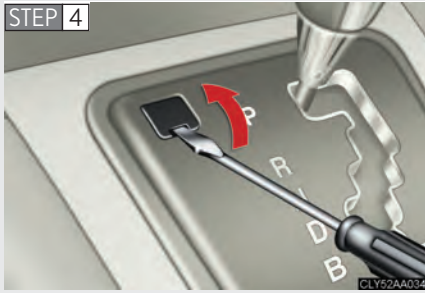

Pry the cover up with a flathead screwdriver or equivalent.

**STEP 5**



Press the shift lock override button.

The shift lever can be shifted while the button is pressed.

## 5-2. Steps to take in an emergency

### If you lose your keys

New genuine Lexus keys can be made by your Lexus dealer using one of the other master keys and the key number stamped on your key number plate.

## 5-2. Steps to take in an emergency If the 12-volt battery is discharged

The following procedures may be used to start the hybrid system if the vehicle's battery is discharged.

You can call your Lexus dealer, or qualified repair shop.

If you have a set of jumper (or booster) cables and a second vehicle with a 12-volt battery, you can jump start your Lexus following the steps below.

**STEP 1** Remove the engine compartment cover. (→P. 325)

**STEP 2**

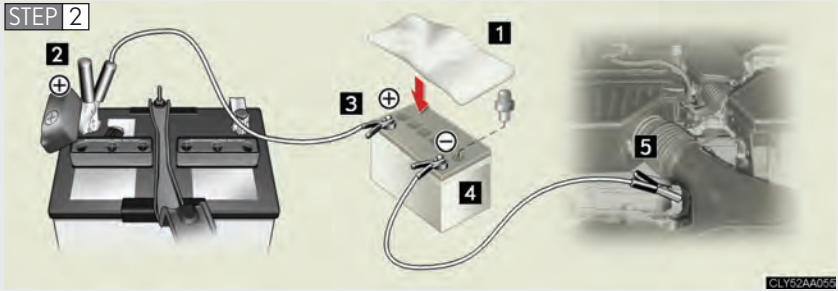

Connecting the jumper cables.

- 1** If required, remove all vent plugs from the booster battery. Lay a cloth over the open vents on the booster battery. (This helps reduce the explosion hazard, personal injuries and burns.)
- 2** Positive (+) battery terminal on your vehicle
- 3** Positive (+) battery terminal on the second vehicle
- 4** Negative (-) battery terminal on the second vehicle
- 5** Connect the jumper cable to ground on your vehicle as shown in the illustration.

**STEP 3** Start the hybrid system of the second vehicle. Increase the gasoline engine speed slightly and maintain at that level for approximately 5 minutes to recharge the battery of your vehicle.

**STEP 4** Maintain the gasoline engine speed on the second vehicle and start the vehicle's hybrid system.

**STEP 5** Once the vehicle's hybrid system has started, remove the jumper cables in the exact reverse order in which they were connected.

Once the hybrid system starts, have the vehicle checked at your Lexus dealer as soon as possible.

### ■ Avoiding a discharged battery

- Turn off the headlights and the audio system while the hybrid system is turned off.
- Turn off any unnecessary electrical components when the vehicle is running at a low speed for an extended period, such as in heavy traffic, etc.

### ■ After recharging the 12-volt battery

(→P. 336)

### ■ When the battery is removed or discharged

The power windows, power back door and moon roof must be initialized.

(→P. 470)

## CAUTION

### ■ Avoiding battery fires or explosions

Observe the following precautions to prevent accidentally igniting the flammable gas that may be emitted from the battery.

- Make sure the jumper cable is connected to the correct terminal and that it is not unintentionally in contact with any part other than the intended terminal.
- Do not allow the jumper cables to come into contact with the “+” and “-” terminals.
- Do not allow open flame or use matches, cigarette lighters or smoke near the battery.

 **CAUTION****■ Battery precautions**

The battery contains poisonous and corrosive acidic electrolyte, while related parts contain lead and lead compounds. Observe the following precautions when handling the battery.

- When working with the battery, always wear safety glasses and take care not to allow any battery fluids (acid) to come into contact with skin, clothing or the vehicle body.
- Do not lean over the battery.
- In the event that battery fluid comes into contact with the skin or eyes, immediately wash the affected area with water and seek medical attention.  
Place a wet sponge or cloth over the affected area until medical attention can be received.
- Always wash your hands after handling the battery support, terminals, and other battery-related parts.
- Do not allow children near the battery.

 **NOTICE****■ To prevent damaging the vehicle**

Hybrid vehicles cannot be push-started.

**■ When handling jumper cables**

Be careful that the jumper cables do not become tangled in the cooling fan or any of the belts when connecting or disconnecting them.

## 5-2. Steps to take in an emergency

### If your vehicle overheats

#### ■ Electric motor (traction motor) and inverter

If the message WATER TEMP is displayed on the multi-information display.

#### ■ Gasoline engine

If the needle of the engine coolant temperature gauge enters the red zone, the gasoline engine has probably overheated.

Observe the following steps:

**STEP 1** Stop the vehicle in a safe place and turn off the automatic air conditioning system.

**STEP 2** Check to see if steam is coming out from under the hood.

If you see steam:

Stop the hybrid system and carefully lift the hood.

If you do not see steam:

Leave the hybrid system running and carefully lift the hood.

**STEP 3** Check to see if the cooling fan is operating.

If the fan is operating:

Wait until the temperature of the engine (shown on the instrument cluster) begins to fall and then stop the hybrid system.

If the fan is not operating:

Stop the hybrid system immediately and call your local Lexus dealer.

**STEP 4**



After the hybrid system has cooled down sufficiently, check the engine coolant level and inspect the radiator core (radiator) for any leaks.

STEP 5



Add engine coolant if required.

Water can be used in an emergency measure if engine coolant is unavailable. (→P. 443)

Have the vehicle checked at your nearest Lexus dealer as soon as possible.

### ■ Overheating

If you observe the following, your vehicle may be overheating.

- The message WATER TEMP is displayed on the multi-information display.
- The engine coolant temperature gauge enters the red zone or a loss of power is experienced.
- Steam is coming from under the hood.

### ⚠ CAUTION

- **To prevent an accident or injury when inspecting under the hood of your vehicle**
  - Keep hands and clothing away from the fan and other belts while the hybrid system is running.
  - Do not loosen the radiator cap while the hybrid system and radiator are hot. Serious injury, such as burns, may result from hot coolant and steam released under pressure.

 NOTICE

■ **When adding engine coolant**

Wait until the engine has cooled down before adding engine coolant.

When adding coolant, do so slowly. Adding cool coolant to a hot engine too quickly can cause damage to the hybrid system.

## 5-2. Steps to take in an emergency If the vehicle becomes stuck

Carry out the following procedures if the tires spin or the vehicle becomes stuck in mud, dirt, or snow.

- Stop the hybrid system. Set the parking brake and put the selector lever in P.
- Remove the mud, snow, or sand from around the stuck tire.
- Place wood, stones or some other material to help provide traction under the tires.
- Restart the hybrid system.
- Carefully apply the accelerator to free the vehicle.

### CAUTION

#### ■ When attempting to free a stuck vehicle

If you choose to rock the vehicle back and forth to free it, make sure the surrounding area is clear, to avoid striking other vehicles, objects or persons. The vehicle may also lunge forward or lunge back suddenly as it becomes free. Use extreme caution.

#### ■ When shifting the shift lever

Be careful not to shift the shift lever with the accelerator pedal depressed. This may lead to unexpected rapid acceleration of the vehicle that may cause an accident and result in death or serious injury.

### NOTICE

#### ■ To avoid damaging the transmission and other components

- Avoid spinning the wheels and do not rev the hybrid system.
- If the vehicle remains stuck after trying these procedures, the vehicle may require towing to be freed.



**6-1. Specifications..... 438**  
Maintenance data  
(fuel, oil level, etc.) ..... 438  
Fuel information ..... 450  
Tire information..... 453

**6-2. Customization..... 466**  
Customizable features ..... 466

**6-3. Initialization ..... 470**  
Items to initialize ..... 470

## 6-1. Specifications

### Maintenance data (fuel, oil level, etc.)

#### Dimensions and weight

|  |                             |   |
|--|-----------------------------|---|
| Overall length                                   |                             | 187.2 in. (4755 mm)   |
| Overall width                                    |                             | 72.6 in. (1845 mm)  |
| Overall height *1                                | 2WD models                  | 66.1 in. (1680 mm) *2<br>67.7 in. (1720 mm) *3<br>68.3 in. (1735 mm) *4 |
|  | AWD models                  | 66.3 in. (1685 mm) *2<br>67.9 in. (1725 mm) *3<br>68.5 in. (1740 mm) *4 |
| Wheelbase  |                             | 106.9 in. (2715 mm)   |
| Tread  | 2WD models -Front           | 62.2 in. (1580 mm)  |
|  | -Rear                       | 61.6 in. (1565 mm)  |
|  | AWD models -Front           | 62.0 in. (1575 mm)  |
|  | -Rear                       | 61.2 in. (1555 mm)  |
| Vehicle capacity weight<br>(Occupants + luggage) |                             | 925 lb. (420 kg)  |
| Towing capacity<br>(Trailer weight + cargo)      | Without towing pack-<br>age | 2000 lb. (907 kg)   |
|  | With towing package         | 3500 lb. (1588 kg)  |

\*1: Unladen vehicle

\*2: Vehicle without roof rails

\*3: Vehicle with roof rails

\*4: Vehicle with roof rails and cross rails

## Vehicle identification

### ■ Vehicle identification number

The vehicle identification number (VIN) is the legal identifier for your vehicle. This is the primary identification number for your Lexus. It is used in registering the ownership of your vehicle.

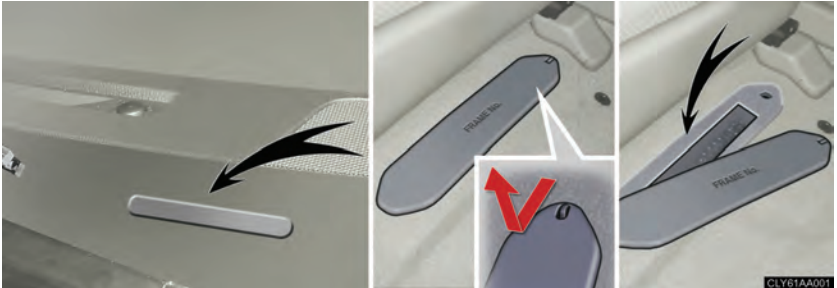

This number is stamped on the top left of the instrument panel and under the front passenger's seat (on some models).

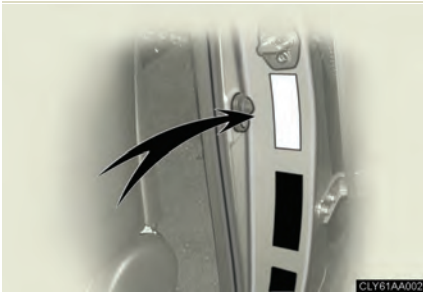

This number is also on the Certification Label.

### ■ Gasoline engine number and electric motor (traction motor) number

The gasoline engine number and traction motor number are stamped as shown.

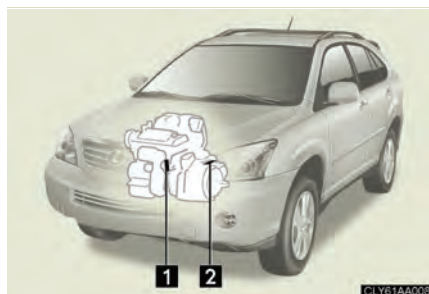

- 1 Gasoline engine number
- 2 Electric motor (traction motor) number

### Engine

|                               |   |
|-------------------------------|---|
| Model                         | 3MZ-FE  |
| Type                          | 6-cylinder V type,<br>4-cycle, gasoline   |
| Bore and stroke               | 3.62 × 3.27 in.<br>(92 × 83 mm)   |
| Displacement                  | 202.1 cu.in.<br>(3311 cm <sup>3</sup> )   |
| Drive belt tension            | Automatic adjustment  |
| Valve clearance (engine cold) | Intake:<br>0.006 — 0.010 in. (0.15 — 0.25 mm)<br>Exhaust:<br>0.010 — 0.014 in. (0.25 — 0.35 mm) |

**Fuel**

|                    |  |
|--------------------|--|
| Fuel type          | Unleaded gasoline only                   |
| Octane rating      | 91 (Research octane number 96) or higher |
| Fuel tank capacity | 17.2 gal. (65 L, 14.3 Imp.gal)           |

**Front electric motor (traction motor)**

|                |                                    |
|----------------|------------------------------------|
| Type           | Permanent magnet synchronous motor |
| Maximum output | 123 kW                             |
| Maximum torque | 33.9 kgf•m (333 N•m, 245 ft•lbf)   |

**Rear electric motor (traction motor with all wheel drive models)**

|                |                                    |
|----------------|------------------------------------|
| Type           | Permanent magnet synchronous motor |
| Maximum output | 50 kW                              |
| Maximum torque | 13.2 kgf•m (130 N•m, 95 ft•lbf)    |

**Hybrid battery (traction battery)**

|                 |                             |
|-----------------|-----------------------------|
| Type            | Nickel-Metal hybrid battery |
| Voltage         | 9.6 V/module                |
| Capacity        | 6.5 Ah (3HR)                |
| Quantity        | 30 modules                  |
| Overall voltage | 288 V                       |

**Lubrication system**

|   |   |
|---|---|
| <p>Oil capacity<br/>drain and refill<br/>(reference)</p> <p>With filter</p> <p>Without filter</p> | <p>5.0 qt. (4.7 L, 4.1 Imp.qt.)</p> <p>4.8 qt. (4.5 L, 4.0 Imp.qt.)</p>   |
| <p>Oil grade</p>  | <p>ILSAC multi-grade engine oil</p>   |
| <p>Recommended oil<br/>viscosity</p>  | <p>Use Lexus approved “Toyota Genuine Motor Oil” or equivalent to satisfy the grade and viscosity shown below.</p> <div data-bbox="452 690 877 982" style="text-align: center;"> <p>CLY6TAA014</p> </div> <p>0W-20 is an oil that provides optimal levels of fuel efficiency.</p> |

Oil viscosity

- The 0W portion of the oil viscosity rating indicates the characteristic of the oil which allows cold startability. Oils with a lower value before the W allow for easier starting of the engine in cold weather.
- The 20 in 0W-20 indicates the oil viscosity when the oil is at its operating temperature. An oil with a higher viscosity may be better suited if the vehicle is operated at high speeds, or under extreme load condition.

## Cooling system

|                    |   |
|--------------------|---|
| Capacity           |   |
| Gasoline engine    | 10.9 qt. (10.3 L, 9.0 Imp.qt.)  |
| power control unit | 3.6 qt. (3.4 L, 3.0 Imp.qt.)  |
| Coolant type       | <p>Use either of the following.</p> <ul style="list-style-type: none"> <li>• “Toyota Super Long Life Coolant”</li> <li>• Similar high-quality ethylene glycol-based non-silicate, non-amine, non-nitrite, and non-borate coolant with long-life organic acid technology</li> </ul> <p>Do not use plain water alone.</p> |

## Ignition system

|            |                    |
|------------|--------------------|
| Spark plug |                    |
| Make       |                    |
|            | DENSO SK20R11      |
|            | NGK IFR6A11        |
| Gap        | 0.043 in. (1.1 mm) |

### NOTICE

#### Iridium-tipped spark plugs

Use only iridium-tipped spark plugs. Do not adjust gap when tuning the gasoline engine.

## Electrical system

|                              |  |
|------------------------------|--|
| 12-volt battery              |  |
| Open voltage at 68°F (20°C): | 12.6 — 12.8 V Fully charged<br>12.2 — 12.4 V Half charged<br>11.8 — 12.0 V Discharged<br>(Voltage checked 20 minutes after the key is removed from the engine switch with all the lights turned off) |
| Charging rates               | 5 A max.   |

## Transaxle

|                                    |   |
|------------------------------------|---|
| Fluid capacity<br>Drain and refill |   |
| Front                              |   |
| Without towing package             | 3.9 qt. (3.7L, 3.2 Imp. qt.)  |
| With towing package                | 4.1 qt. (3.9 L, 3.4 Imp. qt.)   |
| Rear (AWD models only)             | 1.8 qt. (1.7 L, 1.5 Imp. qt.)   |
|                                    | The fluid capacity is a reference quantity. If replacement is necessary, contact your Lexus dealer. |
| Fluid type                         | Toyota Genuine ATF WS   |

### NOTICE

#### ■ Transaxle fluid type

Using transmission fluid other than “Toyota Genuine ATF WS” may cause deterioration in shift quality, locking up of your transmission accompanied by vibration, and ultimately damage the transmission of your vehicle.

## Brakes

|  |                                  |
|--|----------------------------------|
| Pedal clearance <sup>*1</sup>            | 3.5 in. (90 mm) Min.             |
| Pedal free play                          | 0.039 — 0.079 in. (1 — 2 mm)     |
| Brake pad wear limit                     | 0.04 in. (1.0 mm)                |
| Parking brake lining wear limit          | 0.04 in. (1.0 mm)                |
| Parking brake pedal travel <sup>*2</sup> | 5 — 7 clicks                     |
| Fluid type                               | SAE J1703 or FMVSS No. 116 DOT 3 |

<sup>\*1</sup>: Minimum pedal clearance when depressed with a force of 112 lbf (500 N, 51 kgf) while the hybrid system is running.

<sup>\*2</sup>: Parking brake pedal travel when depressed with a force of 67 lbf (300 N, 31 kgf).

## Steering

|           |                           |
|-----------|---------------------------|
| Free play | Less than 1.2 in. (30 mm) |
|-----------|---------------------------|

## Tires and wheels

### ► Type A

|   |   |
|---|---|
| Tire size   | 225/65R17 101S  |
| Tire inflation pressure<br>(Recommended cold tire inflation pressure) | <p>Driving under normal conditions</p> <p>Front:<br/>32 psi (220 kPa, 2.2 kgf/cm<sup>2</sup> or bar)</p> <p>Rear:<br/>32 psi (220 kPa, 2.2 kgf/cm<sup>2</sup> or bar)</p> <p>Spare:<br/>32 psi (220 kPa, 2.2 kgf/cm<sup>2</sup> or bar)</p> <p>Driving at high speeds above 100 mph (160 km/h) (in countries where such speeds are permitted by law)<br/>Add 1.5 psi (10 kPa, 0.1 kgf/cm<sup>2</sup> or bar) to the front tires and rear tires. Never exceed the maximum cold tire inflation pressure indicated on the tire sidewall.</p> |
| Wheel size  | 17 × 6 1/2 J  |
| Wheel nut torque  | 10.5 kgf•m (103 N•m, 76 ft•lbf)   |

## ► Type B

|   |  |
|---|--|
| Tire size   | P235/55R18 99V   |
| Tire inflation pressure<br>(Recommended cold tire inflation pressure) | Driving under normal conditions<br>Front:<br>30 psi (210 kPa, 2.1 kgf/cm <sup>2</sup> or bar)<br>Rear:<br>30 psi (210 kPa, 2.1 kgf/cm <sup>2</sup> or bar)<br>Spare:<br>30 psi (210 kPa, 2.1 kgf/cm <sup>2</sup> or bar) |
| Wheel size  | 18 × 7 J   |
| Wheel nut torque  | 10.5 kgf•m (103 N•m, 76 ft•lbf)  |

## Light bulbs

|          | Light Bulbs                              | Bulb No. | W   | Type |
|----------|--|----------|-----|------|
| Exterior | Headlights (low beam)<br>Discharge bulbs | —        | 35  | A    |
|          | Headlights (low beam)<br>Halogen bulbs   | —        | 55  | B    |
|          | Front turn signal lights                 | —        | 21  | C    |
|          | Headlights (high beam)                   | 9005     | 60  | D    |
|          | Parking lights                           | 168      | 5   | E    |
|          | Fog lights                               | 9006     | 55  | B    |
|          | Front side marker lights                 | 168      | 5   | E    |
|          | Rear turn signal lights                  | —        | 21  | C    |
|          | Licence plate lights                     | 168      | 5   | E    |
|          | Back-up lights                           | 921      | 16  | E    |
|          | Rear side marker lights                  | 194      | 3.8 | E    |
| Interior | Vanity lights                            | —        | 2.8 | G    |
|          | Personal lights                          | —        | 8   | G    |
|          | Interior lights                          | —        | 8   | F    |
|          | Luggage compartment lights               | —        | 5   | F    |
|          | Door courtesy lights                     | —        | 5   | G    |

- A: D2S discharge bulbs  
 B: H11 halogen bulbs  
 C: Wedge base bulbs (amber)  
 D: HB3 halogen bulbs  
 E: Wedge base bulbs (clear)  
 F: Double end bulbs  
 G: Single end bulbs

## 6-1. Specifications

### Fuel information

Your vehicle must use only unleaded gasoline.

Premium unleaded gasoline with an octane rating of 91 (Research Octane Number 96) or higher required for optimum engine performance.

At minimum, the gasoline you use should meet the specifications of ASTM D4814 in the U.S.A. and CGSB3.5-M93 in Canada.

---

#### ■ Fuel tank opening for unleaded gasoline

To help prevent incorrect fueling, your Lexus has a fuel tank opening that only accommodates the special nozzle on unleaded fuel pumps.

#### ■ If premium gasoline is not available

If 91 rating gasoline cannot be obtained, you may use unleaded gasoline with an octane rating as low as 87 (Research Octane Rating 91).

#### ■ If your engine knocks

- Consult your Lexus dealer.
- You may occasionally notice light knocking for a short time while accelerating or driving uphill. This is normal and there is no need for concern.

#### ■ Gasoline quality

In very few cases, driveability problems may be caused by the brand of gasoline you are using. If driveability problems persist, try changing the brand of gasoline. If this does not correct the problem, consult your Lexus dealer.

### ■ Gasoline quality standards

- Automotive manufacturers in the US, Europe and Japan have developed a specification for fuel quality called World-Wide Fuel Charter (WWFC) that is expected to be applied worldwide.
- The WWFC consists of four categories that are based on required emission levels. In the US, category 4 has been adopted.
- The WWFC improves air quality by lowering emissions in vehicle fleets, and customer satisfaction through better performance.

### ■ Lexus recommends the use of gasoline containing detergent additives

- Lexus recommends the use of gasoline that contains detergent additives to avoid build-up of engine deposits.
- All gasoline sold in the US contains detergent additives to clean and/or keep clean intake systems.

### ■ Lexus recommends the use of cleaner burning gasoline

Cleaner burning gasoline, including reformulated gasoline that contains oxygenates such as ethanol or MTBE (Methyl Tertiary Butyl Ether) is available in many areas.

Lexus recommends the use of cleaner burning gasoline and appropriately blended reformulated gasoline. These types of gasoline provide excellent vehicle performance, reduce vehicle emissions and improve air quality.

### ■ Lexus does not recommend blended gasoline

- Lexus allows the use of oxygenate blended gasoline where the oxygenate content is up to 10% ethanol or 15% MTBE.
- If you use gasohol in your Lexus, be sure that it has an octane rating no lower than 87.
- Lexus does not recommend the use of gasoline containing methanol.

### ■ Lexus does not recommend gasoline containing MMT

Some gasoline contains octane enhancing additive called MMT (Methylcyclopentadienyl Manganese Tricarbonyl).

Lexus does not recommend the use of gasoline that contains MMT. If fuel containing MMT is used, your emission control system may be adversely affected.

The malfunction indicator lamp on the instrument cluster may come on. If this happens, contact your Lexus dealer for service.

 NOTICE

■ **Notice on gasoline quality**

- Do not use leaded gasoline.

Leaded gasoline can cause damage to your vehicle's three-way catalytic converters causing the emission control system to malfunction.

- Do not use gasohol other than that stated here.

Other gasohol may cause fuel system damage or vehicle performance problems.

- Use of unleaded gasoline with an octane rating lower than 91 may result in gasoline engine knocking. Persistent knocking can lead to gasoline engine damage and should be corrected by refueling with higher octane unleaded gasoline.

At worst, this will lead to engine damage.

■ **Fuel-related poor driveability**

If after using a different type of fuel, poor driveability is encountered (poor hot starting, vaporization, engine knocking, etc.), discontinue the use of that type of fuel.

■ **When refueling with gasohol**

Take care not to spill gasohol.

It can damage your vehicle's paint.

## 6-1. Specifications

# Tire information

### Typical tire symbols



- 1** Tire size (→P. 455)
- 2** DOT and Tire Identification Number (TIN) (→P. 454)
- 3** Location of treadwear indicators (→P. 457)
- 4** Tire ply composition and materials

Ply is layers of rubber-coated parallel cords. Cords are the strands which form the plies in a tire.

- 5** Radial tires or bias-ply tires  
A radial tire has RADIAL on the sidewall. A tire not marked RADIAL is a bias-ply tire.

#### **6** TUBELESS or TUBE TYPE

A tubeless tire does not have a tube and air is directly filled in the tire. A tube type tire has a tube inside the tire and the tube maintains the air pressure.

- 7** Load limit at maximum cold tire inflation pressure (→P. 459)
- 8** Maximum cold tire inflation pressure (→P. 459)

This means the pressure to which a tire may be inflated.

#### **9** Uniform tire quality grading

For details, see “Uniform tire quality grading” that follows.

10 Summer tire or all season tire (→P. 457)

An all season tire has “M+S” on the sidewall. A tire not marked “M+S” is a summer tire.

Typical DOT and tire identification number (TIN)

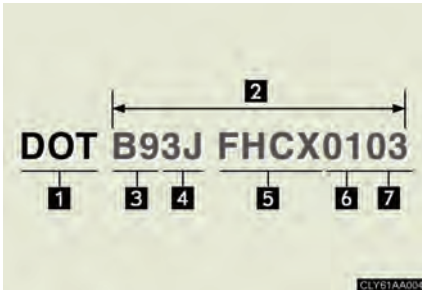

- 1 DOT symbol\*
- 2 Tire Identification Number (TIN)
- 3 Tire manufacturer's identification mark
- 4 Tire size code
- 5 Manufacturer's optional tire type code (3 or 4 letters)
- 6 Manufacturing week
- 7 Manufacturing year

\*: The DOT symbol certifies that the tire conforms to applicable Federal Motor Vehicle Safety Standards.

## Tire size

### ■ Typical tire size information

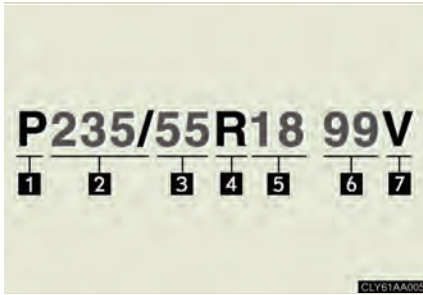

The illustration indicates typical tire size.

- 1 Tire use  
(P = Passenger car,  
T = Temporary use)
- 2 Section width (millimeters)
- 3 Aspect ratio  
(tire height to section width)
- 4 Tire construction code  
(R = Radial, D = Diagonal)
- 5 Wheel diameter (inches)
- 6 Load index (2 or 3 digits)
- 7 Speed symbol  
(alphabet with one letter)

### Tire dimensions

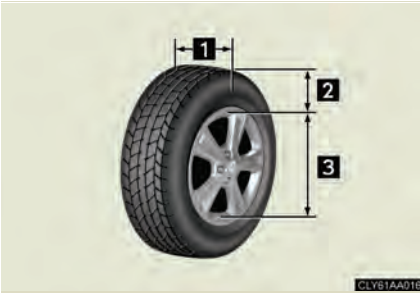

- 1 Section width
- 2 Tire height
- 3 Wheel diameter

### Tire section names

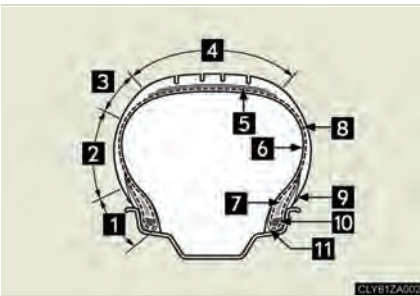

- 1 Bead
- 2 Sidewall
- 3 Shoulder
- 4 Tread
- 5 Belt
- 6 Inner liner
- 7 Reinforcing rubber
- 8 Carcass
- 9 Rim lines
- 10 Bead wires
- 11 Chafer

## Uniform tire quality grading

This information has been prepared in accordance with regulations issued by the National Highway Traffic Safety Administration of the U.S.A. Department of Transportation.

It provides the purchasers and/or prospective purchasers of Lexus vehicles with information on uniform tire quality grading.

Your Lexus dealer will help answer any questions you may have as you read this information.

### ■ DOT quality grades

All passenger vehicle tires must conform to Federal Safety Requirements in addition to these grades. Quality grades can be found where applicable on the tire sidewall between tread shoulder and maximum section width.

For example: Treadwear 200 Traction AA Temperature A

### ■ Treadwear

The treadwear grade is a comparative rating based on the wear rate of the tire when tested under controlled conditions on a specified government test course.

For example, a tire graded 150 would wear one and a half (1 - 1/2) times as well on the government course as a tire graded 100.

The relative performance of tires depends upon the actual conditions of their use, however, and may depart significantly from the norm due to variations in driving habits, service practices and differences in road characteristics and climate.

### ■ Traction AA, A, B, C

The traction grades, from highest to lowest, are AA, A, B and C, and they represent the tire's ability to stop on wet pavement as measured under controlled conditions on specified government test surfaces of asphalt and concrete.

A tire marked C may have poor traction performance.

Warning: The traction grade assigned to this tire is based on braking (straight ahead) traction tests and does not include cornering (turning) traction.

### ■ Temperature A, B, C

The temperature grades are A (the highest), B, and C, representing the tire's resistance to the generation of heat and its ability to dissipate heat when tested under controlled conditions on a specified indoor laboratory test wheel.

Sustained high temperature can cause the material of the tire to degenerate and reduce tire life, and excessive temperature can lead to sudden tire failure.

The grade C corresponds to a level of performance which all passenger car tires must meet under the Federal Motor Vehicle Safety Standard No. 109.

Grades B and A represent higher levels of performance on the laboratory test wheel than the minimum required by law.

Warning: The temperature grades for this tire are established for a tire that is properly inflated and not overloaded.

Excessive speed, underinflation, or excessive loading, either separately or in combination, can cause heat buildup and possible tire failure.

## Glossary of tire terminology

| Tire related term              | Meaning   |
|--------------------------------|---|
| Cold tire inflation pressure   | Tire pressure when the vehicle has been parked for three hours or more, or has not been driven more than 1 mile or 1.5 km under that condition  |
| Maximum inflation pressure     | The maximum cold inflated pressure to which a tire may be inflated, shown on the sidewall of the tire   |
| Recommended inflation pressure | Cold tire inflation pressure recommended by a manufacturer  |
| Accessory weight               | The combined weight (in excess of those standard items which may be replaced) of automatic transmission, power steering, power brakes, power windows, power seats, radio and heater, to the extent that these items are available as factory-installed equipment (whether installed or not) |
| Curb weight                    | The weight of a motor vehicle with standard equipment, including the maximum capacity of fuel, oil and coolant, and if so equipped, air conditioning and additional weight optional engine  |
| Maximum loaded vehicle weight  | The sum of:<br>(a) Curb weight<br>(b) Accessory weight<br>(c) Vehicle capacity weight<br>(d) Production options weight  |
| Normal occupant weight         | 150 lb. (68 kg) times the number of occupants specified in the second column of Table 1* that follows   |

## 6-1. Specifications

| Tire related term                             | Meaning  |
|---|--|
| Occupant distribution                         | Distribution of occupants in a vehicle as specified in the third column of Table 1* below  |
| Production options weight                     | The combined weight of installed regular production options weighing over 5 lb. (2.3 kg) in excess of the standard items which they replace, not previously considered in curb weight or accessory weight, including heavy duty brakes, ride levelers, roof rack, heavy duty 12-volt battery, and special trim |
| Rim   | A metal support for a tire or a tire and tube assembly upon which the tire beads are seated  |
| Rim diameter (Wheel diameter)                 | Nominal diameter of the bead seat  |
| Rim size designation                          | Rim diameter and width   |
| Rim type designation                          | The industry manufacturer's designation for a rim by style or code   |
| Rim width                                     | Nominal distance between rim flanges   |
| Vehicle capacity weight (Total load capacity) | The rated cargo and luggage load plus 150 lb. (68 kg) times the vehicle's designated seating capacity  |
| Vehicle maximum load on the tire              | The load on an individual tire that is determined by distributing to each axle its share of the maximum loaded vehicle weight, and dividing by two   |
| Vehicle normal load on the tire               | The load on an individual tire that is determined by distributing to each axle its share of curb weight, accessory weight, and normal occupant weight (distributed in accordance with Table 1* below), and dividing by two   |
| Weather side                                  | The surface area of the rim not covered by the inflated tire   |

| Tire related term     | Meaning  |
|-----------------------|--|
| Bead                  | The part of the tire that is made of steel wires, wrapped or reinforced by ply cords and that is shaped to fit the rim   |
| Bead separation       | A breakdown of the bond between components in the bead   |
| Bias ply tire         | A pneumatic tire in which the ply cords that extend to the beads are laid at alternate angles substantially less than 90 degrees to the centerline of the tread  |
| Carcass               | The tire structure, except tread and sidewall rubber which, when inflated, bears the load  |
| Chunking              | The breaking away of pieces of the tread or sidewall   |
| Cord                  | The strands forming the plies in the tire  |
| Cord separation       | The parting of cords from adjacent rubber compounds  |
| Cracking              | Any parting within the tread, sidewall, or innerliner of the tire extending to cord material   |
| CT                    | A pneumatic tire with an inverted flange tire and rim system in which the rim is designed with rim flanges pointed radially inward and the tire is designed to fit on the underside of the rim in a manner that encloses the rim flanges inside the air cavity of the tire |
| Extra load tire       | A tire designed to operate at higher loads and at higher inflation pressures than the corresponding standard tire  |
| Groove                | The space between two adjacent tread ribs  |
| Innerliner            | The layer(s) forming the inside surface of a tubeless tire that contains the inflating medium within the tire  |
| Innerliner separation | The parting of the innerliner from cord material in the carcass  |

| Tire related term                      | Meaning   |
|--|---|
| Intended outboard sidewall             | (a) The sidewall that contains a whitewall, bears white lettering, or bears manufacturer, brand, and/or model name molding that is higher or deeper than the same molding on the other sidewall of the tire, or<br>(b) The outward facing sidewall of an asymmetrical tire that has a particular side that must always face outward when mounted on a vehicle |
| Light truck (LT) tire                  | A tire designated by its manufacturer as primarily intended for use on lightweight trucks or multipurpose passenger vehicles  |
| Load rating                            | The maximum load that a tire is rated to carry for a given inflation pressure   |
| Maximum load rating                    | The load rating for a tire at the maximum permissible inflation pressure for that tire  |
| Maximum permissible inflation pressure | The maximum cold inflation pressure to which a tire may be inflated   |
| Measuring rim                          | The rim on which a tire is fitted for physical dimension requirements   |
| Open splice                            | Any parting at any junction of tread, sidewall, or innerliner that extends to cord material   |
| Outer diameter                         | The overall diameter of an inflated new tire  |
| Overall width                          | The linear distance between the exteriors of the sidewalls of an inflated tire, including elevations due to labeling, decorations, or protective bands or ribs  |
| Passenger car tire                     | A tire intended for use on passenger cars, multipurpose passenger vehicles, and trucks, that have a gross vehicle weight rating (GVWR) of 10,000 lb. or less.   |
| Ply                                    | A layer of rubber-coated parallel cords   |

| Tire related term   | Meaning   |
|---------------------|---|
| Ply separation      | A parting of rubber compound between adjacent plies   |
| Pneumatic tire      | A mechanical device made of rubber, chemicals, fabric and steel or other materials, that, when mounted on an automotive wheel, provides the traction and contains the gas or fluid that sustains the load   |
| Radial ply tire     | A pneumatic tire in which the ply cords that extend to the beads are laid at substantially 90 degrees to the centerline of the tread  |
| Reinforced tire     | A tire designed to operate at higher loads and at higher inflation pressures than the corresponding standard tire   |
| Section width       | The linear distance between the exteriors of the sidewalls of an inflated tire, excluding elevations due to labeling, decoration, or protective bands   |
| Sidewall            | That portion of a tire between the tread and bead   |
| Sidewall separation | The parting of the rubber compound from the cord material in the sidewall   |
| Snow tire           | A tire that attains a traction index equal to or greater than 110, compared to the ASTM-E 1136 Standard Reference Test Tire, when using the snow traction test as described in ASTM F-1805-00, Standard Test Method for Signal Wheel Driving Traction in a Straight Line on Snow-and Ice-Covered Surfaces, and which is marked with an Alpine Symbol (  ) on at least one sidewall |
| Test rim            | The rim on which a tire is fitted for testing, and may be any rim listed as appropriate for use with that tire  |

| Tire related term          | Meaning   |
|----------------------------|---|
| Tread                      | That portion of a tire that comes into contact with the road  |
| Tread rib                  | A tread section running circumferentially around a tire   |
| Tread separation           | Pulling away of the tread from the tire carcass   |
| Treadwear indicators (TWI) | The projections within the principal grooves designed to give a visual indication of the degrees of wear of the tread |
| Wheel-holding fixture      | The fixture used to hold the wheel and tire assembly securely during testing  |

\*: Table 1 — Occupant loading and distribution for vehicle normal load for various designated seating capacities

| Designated seating capacity, Number of occupants | Vehicle normal load, Number of occupants | Occupant distribution in a normally loaded vehicle              |
|--|--|---|
| 2 through 4                                      | 2  | 2 in front  |
| 5 through 10                                     | 3  | 2 in front, 1 in second seat                                    |
| 11 through 15                                    | 5  | 2 in front, 1 in second seat, 1 in third seat, 1 in fourth seat |
| 16 through 20                                    | 7  | 2 in front, 2 in second seat, 2 in third seat, 1 in fourth seat |

## 6-2. Customization

### Customizable features

Your vehicle includes a variety of electronic features that can be personalized to your preferences. Programming these preferences requires specialized equipment and may be performed by an authorized Lexus dealership.

Some function settings are changed simultaneously with other functions being customized. Contact your Lexus dealer for further details.

| Item                                | Function   | Default setting   | Customized setting             |
|-------------------------------------|--|---|--------------------------------|
| Wireless remote control<br>(→P. 36) | Wireless remote control  | ON  | OFF                            |
|                                     | Unlocking operation  | Driver's door unlocked in one step, all doors unlocked in two steps | All doors unlocked in one step |
|                                     | Automatic door lock function to be activated if door is not opened after being unlocked                  | ON  | OFF                            |
|                                     | Time elapsed before automatic door lock function is activated if door is not opened after being unlocked | 60 seconds  | 30 seconds                     |
|                                     |  |   | 120 seconds                    |
|                                     | Operation signal (Emergency flashers)  | ON  | OFF                            |
|                                     | Operation signal (Buzzer)  | ON  | OFF                            |

| Item                                   | Function   | Default setting | Customized setting |
|--|--|-----------------|--------------------|
| Wireless remote control<br>(→P. 36)    | Buzzer sounds when pushing LOCK with any door not closed | ON              | OFF                |
|  | Power back door operation                                | Push and hold   | Push twice*        |
|  |  |                 | One short push*    |
| Panic function                         | ON   | OFF             |                    |
| Power back door<br>(→P. 44)            | Switch operation   | Push and hold   | One short push     |
|  | Wireless remote control linked operation                 | ON              | OFF                |
|  | Operation signal volume                                  | OFF             | High               |
|  |  |                 | Low                |
|  | Operation when door locks                                | Possible        | Impossible         |
|  | Assistance of opening with door opener                   | OFF             | ON                 |
| Sensitivity of jam protection function | Level 1  | Level 2 to 4    |                    |

\*: It is possible to select them only when the power back door operation with the open/close switch is made impossible when the door is locked.

## 6-2. Customization

| Item   | Function   | Default setting   | Customized setting             |
|--|--|---|--------------------------------|
| Door lock<br>(→P. 39)                            | Unlocking using a key  | Driver's door unlocked in one step, all doors unlocked in two steps | All doors unlocked in one step |
|  | Speed-detecting automatic door lock function                                 | OFF   | ON                             |
|  | Opening driver's door unlocks all doors                                      | OFF   | ON                             |
|  | Shifting gears to P unlocks all doors  | ON  | OFF                            |
|  | Shifting gears to position other than P locks all doors                      | ON  | OFF                            |
| Power windows<br>(→P. 72)                        | Linked door lock/unlock operation  | ON  | OFF                            |
|  | Wireless remote control linked operation                                     | ON<br>(open only)   | OFF                            |
| Moon roof<br>(→P. 75)                            | Linked door lock/unlock operation  | ON  | OFF                            |
|  | Wireless remote control linked operation                                     | ON<br>(open only)   | OFF                            |
| Automatic light control system<br>(→P. 148, 151) | Light sensor sensitivity   | Level 3   | Level 1 to 5                   |
|  | Time elapsed before headlights automatically turn off after doors are closed | 30 seconds  | 0 second                       |
|  |  |   | 60 seconds                     |
| 90 seconds                                       |  |   |                                |

| Item   | Function   | Default setting | Customized setting |
|--|--|-----------------|--------------------|
| Windshield wipers and washer<br>(→P. 156, 159) | Switching operation when the vehicle is stationary | ON              | OFF                |
| Illumination<br>(→P. 268)                      | Time elapsed before lights turn off                | 15 seconds      | 7.5 seconds        |
|  |  |                 | 30 seconds         |
|  | Front footwell lighting                            | ON              | OFF                |
|  | Inside door handle well lighting                   | ON              | OFF                |
|  | Operation when the doors are unlocked              | ON              | OFF                |
|  | Operation after the hybrid system is off           | ON              | OFF                |
| Steering wheel<br>(→P. 66)                     | Automatic tilt-away steering column                | ON              | OFF                |

## 6-3. Initialization

### Items to initialize

After reconnecting or performing maintenance on the 12-volt battery, the hybrid system may not start. (→P. 336) Also, the following items must be initialized for normal system operation.

| Item                         | When to initialize  | Reference |
|------------------------------|---|-----------|
| Power window                 | <ul style="list-style-type: none"><li>• After reconnecting or changing the battery</li><li>• After changing a fuse</li></ul>  | P. 72     |
| Power back door              | <ul style="list-style-type: none"><li>• After reconnecting or changing the battery</li><li>• After changing a fuse</li></ul>  | P. 44     |
| Engine oil maintenance data  | After changing engine oil   | P. 326    |
| Tire pressure warning system | <ul style="list-style-type: none"><li>• When changing the tire inflation pressure by changing traveling speed or load weight, etc.</li><li>• When changing the tire size.</li></ul> | P. 339    |



## Reporting safety defects for U.S. owners

If you believe that your vehicle has a defect which could cause a crash or could cause injury or death, you should immediately inform the National Highway Traffic Safety Administration (NHTSA) in addition to notifying the Lexus Division of Toyota Motor Sales, U.S.A., Inc. (Toll-free: 1-800-25-LEXUS).

If NHTSA receives similar complaints, it may open an investigation, and if it finds that a safety defect exists in a group of vehicles, it may order a recall and remedy campaign. However, NHTSA cannot become involved in individual problems between you, your dealer, or Lexus Division of Toyota Motor Sales, U.S.A., Inc.

To contact NHTSA, you may call the Vehicle Safety Hotline toll-free at 1-888-327-4236 (TTY: 1-800-424-9153); go to <http://www.safercar.gov>; or write to: Administrator, NHTSA, 1200 New Jersey Ave, S.E., Washington, DC 20590. You can also obtain other information about motor vehicle safety from <http://www.safercar.gov>.

## Index

**Abbreviation list ..... 474**

**Alphabetical index ..... 476**

**What to do if... ..... 486**

For details of equipment related to the navigation system, such as the audio system and the air conditioning systems, refer to the “Navigation System Owner's Manual”.

## Abbreviation list

# Abbreviation/Acronym list

| ABBREVIATIONS | MEANING                                       |
|---------------|---|
| A/C           | Air Conditioning                              |
| ABS           | Anti-Lock Brake System                        |
| ACC           | Accessory                                     |
| AFS           | Adaptive Front-lighting System                |
| ALR           | Automatic Locking Retractor                   |
| AWD           | All-Wheel Drive                               |
| CRS           | Child Restraint System                        |
| DISP          | Display                                       |
| ECU           | Electronic Control Unit                       |
| EDR           | Event Data Recorder                           |
| ELR           | Emergency Locking Retractor                   |
| EPS           | Electric Power Steering                       |
| GAWR          | Gross Axle Weight Ratings                     |
| GVWR          | Gross Vehicle Weight Ratings                  |
| I/M           | Emission inspection and Maintenance           |
| INFO          | Information                                   |
| INT           | Intermittent                                  |
| LED           | Light Emitting Diode                          |
| LT            | Light Truck                                   |
| MMT           | Methylcy clopentadienyl Manganese Tricarbonyl |
| M + S         | Mud and Snow                                  |
| MTBE          | Methyl Tertiary Butyl Ether                   |
| OBD           | On Board Diagnostics                          |
| PWR           | Power   |
| SRS           | Supplemental Restraint System                 |

| ABBREVIATIONS | MEANING                                |
|---------------|--|
| TIN           | Tire Identification Number             |
| TWI           | Treadwear Indicators                   |
| TPMS          | Tire Pressure Warning System           |
| VDIM          | Vehicle Dynamics Integrated Management |
| VIN           | Vehicle Identification Number          |
| VSC           | Vehicle Stability Control              |
| 2WD           | 2-Wheel Drive                          |

|          |   |        |
|----------|---|--------|
| <b>A</b> | A/C .....   | 206    |
|          | ABS.....  | 177    |
|          | Adaptive front lighting system .....                | 149    |
|          | AFS.....  | 149    |
|          | Air conditioning filter .....                       | 354    |
|          | Air conditioning system                             |        |
|          | Air conditioning filter .....                       | 354    |
|          | Automatic air conditioning system.....              | 206    |
|          | Air bags  |        |
|          | Air bag operating conditions .....                  | 93     |
|          | Air bag precautions for your child.....             | 98     |
|          | Air bag warning light .....                         | 397    |
|          | Curtain shield airbag operating conditions.....     | 94     |
|          | Curtain shield airbag precautions .....             | 98     |
|          | Front passenger occupant classification system..... | 103    |
|          | General airbag precautions .....                    | 98     |
|          | Locations of airbags.....                           | 91     |
|          | Modification and disposal of airbags.....           | 102    |
|          | Proper driving posture.....                         | 89, 98 |
|          | Side airbag operating conditions.....               | 94     |
|          | Side airbag precautions .....                       | 98     |
|          | SRS airbags .....                                   | 91     |
|          | Alarm .....   | 85     |
|          | Antenna .....                                       | 219    |
|          | Anti-lock brake system .....                        | 177    |
|          | Armrest.....  | 290    |
|          | Audio system  |        |
|          | Antenna.....  | 219    |

|  |   |          |
|--|---|----------|
|  | Audio visual input.....                   | 259      |
|  | A/V input adapter .....                   | 259      |
|  | CD player/changer.....                    | 222      |
|  | MP3/WMA disc.....                         | 228      |
|  | Optimal use .....                         | 236      |
|  | Radio .....                               | 215      |
|  | Steering wheel audio switch.....          | 239      |
|  | Audio visual input.....                   | 259      |
|  | Automatic air conditioning system .....   | 206      |
|  | Automatic headlight leveling system ..... | 150, 151 |
|  | Automatic light control system.....       | 148      |
|  | A/V input adapter.....                    | 259      |

|          |  |     |
|----------|--|-----|
| <b>B</b> | Back door                                  |     |
|          | Back door .....                            | 44  |
|          | Wireless remote control .....              | 36  |
|          | Back-up lights                             |     |
|          | Replacing light bulbs.....                 | 373 |
|          | Wattage.....                               | 449 |
|          | Battery                                    |     |
|          | Checking.....                              | 335 |
|          | If the 12-volt battery is discharged ..... | 429 |
|          | Preparing and checking before winter.....  | 190 |
|          | Brake                                      |     |
|          | Fluid.....                                 | 333 |
|          | Parking brake.....                         | 138 |
|          | Brake assist .....                         | 177 |
|          | Break-in tips.....                         | 123 |
|          | Brightness control                         |     |
|          | Multi-display light control.....           | 284 |

|          |   |          |
|----------|---|----------|
| <b>C</b> | <b>Care</b>   |          |
|          | Exterior .....  | 306      |
|          | Interior.....   | 309      |
|          | Seat belts .....  | 310      |
|          | <b>Cargo capacity</b> .....                                       | 186      |
|          | <b>Cargo hooks</b> .....  | 292      |
|          | <b>CD changer</b>   |          |
|          | CD.....   | 222      |
|          | MP3 disc .....  | 228      |
|          | WMA disc .....  | 228      |
|          | <b>CD player</b> .....  | 222      |
|          | <b>Chains</b> .....   | 192      |
|          | <b>Child restraint system</b>                                     |          |
|          | Booster seats, definition.....                                    | 108      |
|          | Booster seats, installation.....                                  | 112      |
|          | Convertible seats, definition .....                               | 108      |
|          | Convertible seats, installation .....                             | 112      |
|          | Front passenger occupant<br>classification system .....           | 103      |
|          | Infant seats, definition .....                                    | 108      |
|          | Infant seats, installation.....                                   | 112      |
|          | Installing CRS with lower<br>anchorage.....                       | 115      |
|          | Installing CRS with seatbelts .....                               | 112      |
|          | Installing CRS with top straps.....                               | 117      |
|          | <b>Child safety</b>   |          |
|          | Air bag precautions .....   | 98       |
|          | Battery precautions.....  | 336, 431 |
|          | Child restraint system .....                                      | 108      |
|          | Child-protectors.....   | 40       |
|          | How your child should wear<br>the seatbelt.....                   | 62       |
|          | Installing child restraints .....                                 | 111      |
|          | Moon roof precautions.....  | 77       |
|          | Power window lock switch .....                                    | 72       |
|          | Power window precautions.....                                     | 74       |
|          | Removed rear seat entertainment<br>system controller battery..... | 359      |
|          | Removed wireless remote control<br>battery precautions .....      | 357      |
|          | Seat belt comfort guide .....                                     | 59       |
|          | Seat belt extender precautions.....                               | 64       |
|          | Seat belt precautions .....                                       | 63       |
|          | Seat heater precautions.....                                      | 288      |
|          | <b>Child-protectors</b> .....                                     | 40       |
|          | <b>Cleaning</b>   |          |
|          | Exterior.....   | 306      |
|          | Interior .....  | 309      |
|          | Seat belts.....   | 310      |
|          | <b>Clock</b> .....  | 282      |
|          | <b>Coin holder</b> .....  | 276      |
|          | <b>Compass</b> .....  | 300      |
|          | <b>Condenser</b> .....  | 333      |
|          | <b>Console box</b> .....  | 274      |
|          | <b>Cooling system</b>   |          |
|          | Engine overheating.....   | 432      |
|          | <b>Cruise control</b>   |          |
|          | Cruise control.....   | 165      |
|          | Dynamic laser cruise control .....                                | 168      |
|          | <b>Cup holder</b> .....   | 277      |
|          | <b>Curtain shield airbags</b> .....                               | 91       |
|          | <b>Customizable features</b> .....                                | 466      |
| <b>D</b> | <b>Daytime running light system</b> .....                         | 149      |
|          | <b>Defogger</b>   |          |
|          | Rear window .....   | 212      |
|          | Side mirror.....  | 212      |
|          | <b>Dimension</b> .....  | 438      |
|          | <b>Dinghy towing</b> .....  | 204      |
|          | <b>Display</b>  |          |
|          | Dynamic laser cruise control .....                                | 168      |
|          | Trip information .....  | 146      |

Do-it-yourself maintenance ..... 318

Door courtesy lights  
 Door courtesy lights ..... 268  
 Wattage ..... 449

Door lock  
 Back door ..... 44  
 Side door ..... 39  
 Wireless remote control ..... 36

Door pockets ..... 279

Doors  
 Back door ..... 44  
 Door glasses ..... 72  
 Door lock ..... 36, 39  
 Power back door ..... 44  
 Side door ..... 39  
 Side mirrors ..... 68

Driver's seat belt reminder light ..... 399

Driving  
 Break-in tips ..... 123  
 Correct posture ..... 89  
 Procedures ..... 122  
 Winter driving tips ..... 190

Driving position memory ..... 55

DVD player  
 Audio CD/CD text ..... 256  
 DVD video ..... 247  
 Initial setting ..... 261  
 MP3 discs ..... 257  
 Video CD ..... 254

**E** Electric power steering ..... 177

Emergency, in case of  
 If the back door opener is in  
 operative ..... 46  
 If the hybrid system will  
 not start ..... 426

If the shift lever cannot be  
 shifted from P ..... 427

If the 12-volt battery is  
 discharged ..... 429

If the warning buzzer sounds ..... 396

If the warning light turns on ..... 396

If you have a flat tire ..... 416

If you lose your keys ..... 428

If you think something is  
 wrong ..... 393

If your vehicle becomes stuck ..... 435

If your vehicle needs to be  
 towed ..... 386

If your vehicle overheats ..... 432

Energy monitor ..... 28

**Engine**  
 Compartment ..... 324  
 Engine switch ..... 131  
 Hood ..... 321  
 How to start the hybrid system ..... 131  
 Identification number ..... 439  
 If the hybrid system will  
 not start ..... 426  
 Ignition switch ..... 131  
 Overheating ..... 432

**Engine compartment cover** ..... 325

**Engine coolant**  
 Capacity ..... 443  
 Checking ..... 331  
 Preparing and checking  
 before winter ..... 190

**Engine coolant temperature  
 gauge** ..... 139

**Engine oil**  
 Capacity ..... 442  
 Checking ..... 326

|                                  |          |
|----------------------------------|----------|
| Preparing and checking           |          |
| before winter.....               | 190      |
| Engine oil maintenance data..... | 329      |
| Engine switch.....               | 131      |
| Engine switch light.....         | 268      |
| EPS.....                         | 177      |
| Event data recorder.....         | 394      |
| <b>F</b> Floor mat.....          | 291      |
| Fluid                            |          |
| Brake.....                       | 333      |
| Washer.....                      | 337      |
| Fog lights                       |          |
| Replacing light bulbs.....       | 373      |
| Switch.....                      | 154      |
| Wattage.....                     | 449      |
| Foot well lighting.....          | 268      |
| Front fog lights                 |          |
| Replacing light bulbs.....       | 373      |
| Switch.....                      | 154, 155 |
| Wattage.....                     | 449      |
| Front passenger's seat belt      |          |
| reminder light.....              | 399      |
| Front seats                      |          |
| Adjustment.....                  | 49       |
| Driving position memory.....     | 55       |
| Flattening seatbacks.....        | 50       |
| Front side marker light          |          |
| Replacing light bulbs.....       | 373      |
| Wattage.....                     | 449      |
| Front turn signal lights         |          |
| Replacing light bulbs.....       | 373      |
| Wattage.....                     | 449      |

|                                  |          |
|----------------------------------|----------|
| Fuel                             |          |
| Capacity.....                    | 441      |
| Fuel gauge.....                  | 139      |
| Gas station information.....     | 488      |
| Information.....                 | 450      |
| Refueling.....                   | 78       |
| Type.....                        | 450      |
| Fuel door.....                   | 78       |
| Fuel filler door.....            | 78       |
| Fuses.....                       | 360      |
| <b>G</b> Garage door opener..... | 295      |
| Gas station information.....     | 488      |
| Gauges.....                      | 139      |
| Glove box.....                   | 273      |
| Glove box light.....             | 274      |
| <b>H</b> Head restraints         |          |
| Adjusting.....                   | 57       |
| Headlight aim.....               | 372      |
| Headlight cleaner.....           | 164      |
| Headlights                       |          |
| Discharge headlights             |          |
| precautions.....                 | 383      |
| Replacing light bulbs.....       | 373      |
| Switch.....                      | 148, 151 |
| Wattage.....                     | 449      |
| Heaters                          |          |
| Seat heaters.....                | 288      |
| Side mirror.....                 | 212      |
| Hood.....                        | 321      |
| Hooks                            |          |
| Cargo hook.....                  | 292      |
| Shopping bag hook.....           | 292      |

|   |     |
|---|-----|
| Hybrid system                             |     |
| Energy monitor.....                       | 28  |
| High voltage cautions.....                | 27  |
| High voltage components.....              | 27  |
| Hybrid vehicle characteristics.....       | 2   |
| Operating condition.....                  | 28  |
| Road accident cautions.....               | 32  |
| Starting procedure.....                   | 131 |
| Hybrid vehicle immobilizer<br>system..... | 83  |

**I** I/M test..... 317

|                |     |
|----------------|-----|
| Identification |     |
| Engine.....    | 439 |
| Vehicle.....   | 439 |

|           |    |
|-----------|----|
| Ignition  |    |
| Keys..... | 34 |

|                      |     |
|----------------------|-----|
| Ignition switch..... | 131 |
|----------------------|-----|

|                               |     |
|-------------------------------|-----|
| Illuminated entry system..... | 269 |
|-------------------------------|-----|

|                       |     |
|-----------------------|-----|
| Indicator lights..... | 141 |
|-----------------------|-----|

|                          |     |
|--------------------------|-----|
| Initialization           |     |
| Items to initialize..... | 470 |

|                                |     |
|--------------------------------|-----|
| Inside door handle lights..... | 268 |
|--------------------------------|-----|

|                              |    |
|------------------------------|----|
| Inside rear view mirror..... | 67 |
|------------------------------|----|

|                      |     |
|----------------------|-----|
| Interior lights      |     |
| Interior lights..... | 268 |
| Switch.....          | 271 |
| Wattage.....         | 449 |

**J** Jack

|                               |     |
|-------------------------------|-----|
| Positioning a floor jack..... | 322 |
| Replacing the wheel.....      | 416 |
| Jack handle.....              | 416 |

**K** Keyless entry..... 36

|                                  |         |
|----------------------------------|---------|
| Keys                             |         |
| Engine switch.....               | 131     |
| Flat key.....                    | 34, 133 |
| If you lose your keys.....       | 428     |
| Ignition switch.....             | 131     |
| Key number.....                  | 34      |
| Keyless entry.....               | 36      |
| Keys.....                        | 34      |
| Wireless remote control key..... | 36      |

**L** Laser cruise control..... 168

|                            |     |
|----------------------------|-----|
| Licence plate lights       |     |
| Replacing light bulbs..... | 373 |
| Wattage.....               | 449 |

|                |     |
|----------------|-----|
| Light bulbs    |     |
| Replacing..... | 373 |
| Wattage.....   | 449 |

|                                |          |
|--------------------------------|----------|
| Lights                         |          |
| Door courtesy lights.....      | 268      |
| Engine switch light.....       | 268      |
| Fog light switch.....          | 154, 155 |
| Headlights switch.....         | 148, 151 |
| Inside door handle lights..... | 268      |
| Interior light switch.....     | 271      |
| Luggage compartment light..... | 46       |
| Meter ring light.....          | 268      |
| Overhead courtesy light.....   | 268      |
| Personal light switch.....     | 272      |
| Replacing light bulbs.....     | 373      |
| Scuff lighting.....            | 268      |
| Turn signal lever.....         | 136, 137 |
| Vanity lights.....             | 281      |
| Wattage.....                   | 449      |

|                    |     |
|--------------------|-----|
| Load capacity..... | 189 |
|--------------------|-----|

|                           |     |
|---------------------------|-----|
| Lock steering column..... | 132 |
|---------------------------|-----|

|                            |     |
|----------------------------|-----|
| Luggage compartment lights |     |
| Switch .....               | 46  |
| Wattage .....              | 449 |
| Luggage cover .....        | 292 |

**M** Maintenance

|                                  |     |
|----------------------------------|-----|
| Do-it-yourself maintenance ..... | 318 |
| General maintenance .....        | 314 |
| Maintenance data .....           | 438 |
| Maintenance requirements .....   | 312 |

Meter

|                                      |     |
|--------------------------------------|-----|
| Instrument panel light control ..... | 140 |
| Meters .....                         | 139 |

Meter ring light ..... 268

Mirrors

|                               |     |
|-------------------------------|-----|
| Inside rear view mirror ..... | 67  |
| Side mirror heater .....      | 212 |
| Side mirrors .....            | 68  |
| Vanity mirrors .....          | 281 |

Moon roof ..... 75

MP3 disc ..... 228

Multi-display

|                          |     |
|--------------------------|-----|
| Brightness control ..... | 284 |
|--------------------------|-----|

Multi-information display

|                      |    |
|----------------------|----|
| Energy monitor ..... | 28 |
|----------------------|----|

**O** Odometer ..... 139

Oil

|                  |     |
|------------------|-----|
| Engine oil ..... | 326 |
|------------------|-----|

Opener

|                        |     |
|------------------------|-----|
| Back door .....        | 44  |
| Fuel filler door ..... | 78  |
| Hood .....             | 321 |

Outside rear view mirrors

|                               |    |
|-------------------------------|----|
| Adjusting and folding .....   | 68 |
| Driving position memory ..... | 55 |

|                                   |     |
|-----------------------------------|-----|
| Outside temperature display ..... | 283 |
| Overhead console .....            | 277 |
| Overhead courtesy lights .....    | 268 |
| Overheating, Engine .....         | 432 |

**P** Parking brake ..... 138

Parking lights

|                             |          |
|-----------------------------|----------|
| Replacing light bulbs ..... | 373      |
| Switch .....                | 148, 151 |
| Wattage .....               | 449      |

Personal lights

|                       |     |
|-----------------------|-----|
| Personal lights ..... | 268 |
| Switch .....          | 272 |
| Wattage .....         | 449 |

Power meter ..... 139

Power outlet ..... 285

Power windows ..... 72

**R** Radiator ..... 333

Radio ..... 215

RDS ..... 216

Rear audio system ..... 241

Rear seat entertainment system

|                                      |     |
|--------------------------------------|-----|
| Audio CD/CD text .....               | 256 |
| DVD video .....                      | 247 |
| Initial setting .....                | 261 |
| MP3 discs .....                      | 257 |
| Rear seat entertainment system ..... | 241 |
| Replacing controller battery .....   | 358 |
| Video .....                          | 259 |
| Video CD .....                       | 254 |

Rear seats

|                    |    |
|--------------------|----|
| Adjustment .....   | 52 |
| Folding down ..... | 52 |

|                                   |          |
|-----------------------------------|----------|
| Rear side marker lights           |          |
| Wattage.....                      | 449      |
| Rear turn signal lights           |          |
| Replacing light bulbs.....        | 373      |
| Wattage.....                      | 449      |
| Rear window defogger.....         | 212      |
| Rear window wiper.....            | 162, 163 |
| Replacing                         |          |
| Fuses.....                        | 360      |
| Light bulbs.....                  | 373      |
| Rear seat entertainment system    |          |
| controller battery.....           | 358      |
| Tires.....                        | 416      |
| Wireless remote control           |          |
| battery.....                      | 356      |
| Reporting safety defects for      |          |
| U.S.A. owners.....                | 472      |
| RSE                               |          |
| Replacing controller battery..... | 358      |
| RSE.....                          | 241      |
| Road accident cautions.....       | 32       |
| Roof luggage carrier.....         | 70       |
| <b>S</b> Scuff lighting.....      | 268      |
| Seat belts                        |          |
| Adjusting the seat belt.....      | 59       |
| Automatic Locking Retractor.....  | 61       |
| Child restraint system            |          |
| installation.....                 | 111      |
| Cleaning and maintaining          |          |
| the seat belts.....               | 310      |
| Emergency Locking Retractor.....  | 61       |
| How to wear your seat belt.....   | 58       |
| How your child should wear        |          |
| the seat belt.....                | 62       |

|                                    |          |
|------------------------------------|----------|
| Pregnant women,                    |          |
| proper seat belt use.....          | 61       |
| Reminder light.....                | 399      |
| Seat belt extenders.....           | 62       |
| Seat belt pretensioners.....       | 60       |
| Seat heaters.....                  | 288      |
| Seating capacity.....              | 189      |
| Seats                              |          |
| Adjustment.....                    | 49, 52   |
| Adjustment precautions.....        | 51, 54   |
| Child seats/child restraint        |          |
| system installation.....           | 111      |
| Cleaning.....                      | 309      |
| Driver's seat position memory..... | 55       |
| Flattening seatbacks.....          | 50       |
| Head restraint.....                | 57       |
| Properly sitting in the seat.....  | 89       |
| Seat heaters.....                  | 288      |
| Service reminder indicators.....   | 141      |
| Shift lever                        |          |
| Transmission.....                  | 135      |
| If the shift lever cannot be       |          |
| shifted from P.....                | 427      |
| Shopping bag hooks.....            | 292      |
| Side airbags.....                  | 91       |
| Side marker lights                 |          |
| Replacing light bulbs.....         | 373      |
| Switch.....                        | 148, 151 |
| Wattage.....                       | 449      |
| Side mirror                        |          |
| Adjusting and folding.....         | 68       |
| Mirror position memory.....        | 55       |

|                                   |          |
|-----------------------------------|----------|
| Spare tire                        |          |
| Inflation pressure .....          | 348      |
| Spare tire .....                  | 416      |
| Spark plug .....                  | 443      |
| Specifications .....              | 438      |
| Speech command switch*            |          |
| Speedometer                       |          |
| Speedometer .....                 | 139      |
| Steering                          |          |
| Column lock release .....         | 133      |
| Steering wheel                    |          |
| Audio switches .....              | 239      |
| Manual adjustment .....           | 65       |
| Power adjustment .....            | 66       |
| Steering wheel position           |          |
| memory .....                      | 55       |
| Storage feature .....             | 273      |
| Stuck                             |          |
| If your vehicle becomes stuck ... | 435      |
| Sun visors .....                  | 280      |
| Sunshade                          |          |
| Roof .....                        | 76       |
| Switch                            |          |
| Engine switch .....               | 131      |
| Fog light switch .....            | 154, 155 |
| Ignition switch .....             | 131      |
| Light switches .....              | 148, 151 |
| Power back door switch .....      | 44       |
| Power door lock switch .....      | 39       |
| Power window switch .....         | 72       |
| Rear window wiper and washer      |          |
| switch .....                      | 162      |
| Window lock switch .....          | 72       |
| Wipers and washer switch .....    | 156      |

|                                    |          |
|------------------------------------|----------|
| <b>T</b> Tail lights               |          |
| Replacing light bulbs .....        | 373      |
| Switch .....                       | 148, 151 |
| Wattage .....                      | 449      |
| Talk switch*                       |          |
| Telephone switch*                  |          |
| Theft deterrent system             |          |
| Alarm .....                        | 85       |
| Hybrid vehicle immobilizer         |          |
| system .....                       | 83       |
| Theft prevention labels .....      | 88       |
| Tire inflation pressure .....      | 348      |
| Tire information                   |          |
| Glossary .....                     | 459      |
| Size .....                         | 455      |
| Tire identification number .....   | 454      |
| Uniform tire quality grading ..... | 457      |
| Tires                              |          |
| Chains .....                       | 190      |
| Checking .....                     | 339      |
| If you have a flat tire .....      | 416      |
| Inflation pressure .....           | 348      |
| Inflation pressure sensor .....    | 340      |
| Information .....                  | 453      |
| Replacing .....                    | 416      |
| Rotating tires .....               | 339      |
| Size .....                         | 447      |
| Snow tires .....                   | 190      |
| Spare tire .....                   | 416      |
| Tools .....                        | 416      |
| Total load capacity .....          | 189      |
| Towing                             |          |
| Dinghy towing .....                | 204      |
| Emergency towing .....             | 386      |
| Trailer towing .....               | 195      |

\*: Refer to the "Navigation System Owner's Manual".

|                               |          |
|-------------------------------|----------|
| Traction control.....         | 177      |
| Trailer towing.....           | 195      |
| Transmission                  |          |
| Transmission.....             | 135      |
| Trip information display..... | 146      |
| Trip meter .....              | 139      |
| Turn signal lights            |          |
| Replacing light bulbs.....    | 373      |
| Switch.....                   | 136, 137 |
| Wattage.....                  | 449      |

|                                     |     |
|-------------------------------------|-----|
| <b>V</b> Valet key.....             | 34  |
| Vanity lights                       |     |
| Vanity lights.....                  | 281 |
| Wattage.....                        | 449 |
| Vanity mirrors .....                | 281 |
| Vehicle identification number ..... | 439 |
| Vehicle stability control.....      | 177 |
| Video mode .....                    | 259 |
| VDIM.....                           | 177 |
| VSC.....                            | 177 |

|                              |     |
|------------------------------|-----|
| <b>W</b> Warning buzzers     |     |
| Brake system .....           | 396 |
| Key reminder .....           | 401 |
| Open door .....              | 399 |
| Open moon roof reminder..... | 399 |
| Seat belt reminder.....      | 399 |
| Warning lights               |     |
| Anti-lock brake system.....  | 397 |
| Automatic headlight leveling |     |
| system.....                  | 397 |
| Brake assist system.....     | 397 |
| Brake system .....           | 396 |
| Charging system .....        | 397 |

|                               |     |
|-------------------------------|-----|
| Electric power steering       |     |
| control system.....           | 397 |
| Hybrid battery system .....   | 397 |
| Low fuel level.....           | 399 |
| Low tire pressure warning     |     |
| light.....                    | 399 |
| Master warning light.....     | 399 |
| Open door.....                | 399 |
| Pretensioners .....           | 397 |
| Seat belt reminder light..... | 399 |
| SRS airbags.....              | 397 |

|                                   |          |
|-----------------------------------|----------|
| <b>Warning messages</b>           |          |
| AWD system.....                   | 406      |
| Dynamic laser cruise              |          |
| control.....                      | 407, 410 |
| Engine oil maintenance.....       | 410      |
| Engine oil pressure.....          | 406      |
| Fuel lid.....                     | 415      |
| Head light level.....             | 407      |
| Hybrid system.....                | 406      |
| Moon roof.....                    | 410      |
| Open door.....                    | 410      |
| Parking brake.....                | 410      |
| Vehicle stability control.....    | 407, 409 |
| Washer fluid .....                | 410      |
| Water temp.....                   | 406      |
| Transmission selector lever ..... | 410      |

|                        |          |
|------------------------|----------|
| <b>Washer</b>          |          |
| Checking.....          | 337      |
| Preparing and checking |          |
| before winter.....     | 190      |
| Switch.....            | 156, 159 |

|                                |            |
|--------------------------------|------------|
| <b>Washing and waxing.....</b> | <b>306</b> |
|--------------------------------|------------|

|                      |     |
|----------------------|-----|
| <b>Weight</b>        |     |
| Cargo capacity ..... | 186 |
| Load limits.....     | 189 |
| Weight.....          | 438 |

|                                  |          |
|----------------------------------|----------|
| Wheels .....                     | 352      |
| Window glasses .....             | 72       |
| Window lock switch.....          | 72       |
| Windows                          |          |
| Power windows .....              | 72       |
| Rear window defogger .....       | 212      |
| Washer.....                      | 156, 159 |
| Windshield wipers.....           | 156, 159 |
| Wireless remote control key      |          |
| Replacing the battery .....      | 356      |
| Wireless remote control key..... | 36       |
| WMA disc.....                    | 228      |

## What to do if...

# What to do if...



A tire punctures

P. 416 If you have a flat tire



The hybrid system does not start

P. 426 If the hybrid system will not start

P. 83 Hybrid vehicle immobilizer system

P. 429 If the 12-volt battery is discharged



The shift lever cannot be moved out

P. 427 If the shift lever cannot be shifted from P



The engine coolant temperature gauge enters the red zone

P. 432 If your vehicle overheats



Steam can be seen coming from under the hood



The key is lost

P. 428 If you lose your keys



The 12-volt battery runs out

P. 429 If the 12-volt battery is discharged



The doors cannot be locked

P. 39 Side doors

P. 44 Back door



The horn begins to sound

P. 85 Alarm



The vehicle is stuck in mud or sand

P. 435 If the vehicle becomes stuck



The warning light or indicator light comes on

P. 396 If the warning light turns on



### Warning lights



Brake system warning light

or



or



P. 396



ABS warning light

or



P. 397



Low fuel level warning light

P. 399



SRS warning light

P. 397



Charging system warning light

P. 397



Hybrid battery warning light

P. 397



Malfunction indicator lamp

or



P. 397



Driver's seat belt reminder light

P. 399



Front passenger's seat belt reminder light

P. 399



Electric power steering warning light

P. 397



Master warning light

P. 399



Open door warning light

P. 399



Tire pressure warning light

P. 399

## GAS STATION INFORMATION

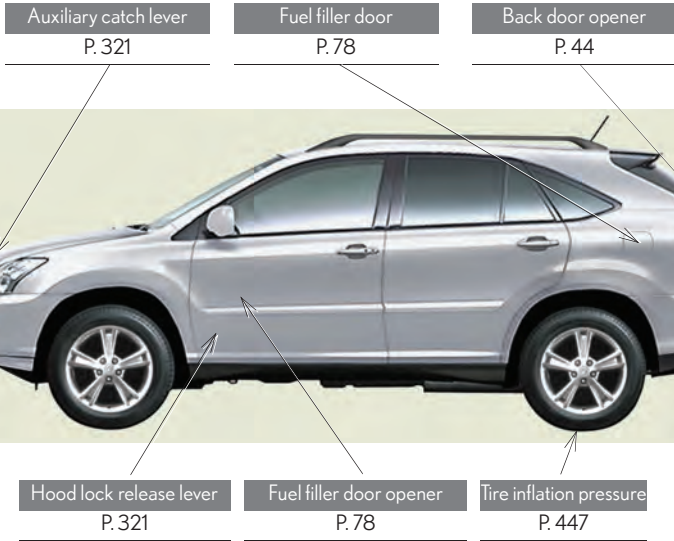

|   |  |  |
|---|--|--|
| Fuel tank capacity                        | 17.2 gal. (65 L, 14.3 Imp.gal.)  |  |
| Fuel type                                 | Unleaded gasoline only   | P. 80, 441   |
| Cold tire inflation pressure              |  | P. 447   |
| Engine oil capacity<br>(Drain and refill) | With filter<br>Without filter  | qt. (L, Imp.qt.)<br>5.0 (4.7, 4.1)<br>4.8 (4.5, 4.0) |
| Engine oil type                           | Toyota Genuine Motor Oil or equivalent<br>Oil grade: ILSAC multigrade engine oil<br>Recommended oil viscosity: SAE-OW-20 | P. 442   |



Owner's Manual:  
Publication No. OM48742U  
Part No. 01999-48742  
Printed in Japan 02-0710-01   
RX 400h (北米U)