



2023

**RX500h / RX350h**

**OWNER'S MANUAL**



**WARNING:** Operating, servicing and maintaining a passenger vehicle or off-highway motor vehicle can expose you to chemicals including engine exhaust, carbon monoxide, phthalates, and lead, which are known to the State of California to cause cancer and birth defects or other reproductive harm. To minimize exposure, avoid breathing exhaust, do not idle the engine except as necessary, service your vehicle in a well-ventilated area and wear gloves or wash your hands frequently when servicing your vehicle. For more information go to [www.P65Warnings.ca.gov/passenger-vehicle](http://www.P65Warnings.ca.gov/passenger-vehicle).

## Your Lexus dealer

Your Lexus dealer will provide quality maintenance and any other assistance you may require.

If there is not a Lexus dealer near you, please call the following number:

### ■ U.S. OWNERS

- In the U.S. mainland or Canada:  
Lexus Roadside Assistance  
**1-800-25-LEXUS** or **1-800-255-3987** (Toll-Free)
- In Hawaii:  
Servco Automotive Roadside Assistance/Customer Services  
**1-800-25-LEXUS** or **1-800-255-3987** (Toll-Free)

### ■ CANADIAN OWNERS

- In Canada or the U.S. mainland:  
Lexus Roadside Assistance/Customer Service  
**1-800-26-LEXUS** or **1-800-265-3987** (Toll-Free)

Please access our **websites** for further information.

- The U.S. mainland: [www.lexus.com](http://www.lexus.com)
- Hawaii: [www.servcolexus.com](http://www.servcolexus.com)
- Canada : [www.lexus.ca](http://www.lexus.ca)

©2022 TOYOTA MOTOR CORPORATION

All rights reserved. This material may not be reproduced or copied, in whole or in part, without the written permission of Toyota Motor Corporation.

<b>Pictorial index</b>	Search by illustration	
<b>For safety and security</b>	Make sure to read through them (Main topics: Child seat, theft deterrent system)	1
<b>Vehicle status information and indicators</b>	Reading driving-related information (Main topics: Meters, multi-information display)	2
<b>Before driving</b>	Opening and closing the doors and windows, adjustment before driving (Main topics: Keys, doors, seats)	3
<b>Driving</b>	Operations and advice which are necessary for driving (Main topics: Starting hybrid system, refueling)	4
<b>Interior features</b>	Usage of the interior features (Main topics: Air conditioner, storage features)	5
<b>Maintenance and care</b>	Caring for your vehicle and maintenance procedures (Main topics: Interior and exterior, light bulbs)	6
<b>When trouble arises</b>	What to do in case of malfunction and emergency (Main topics: Battery discharge, flat tire)	7
<b>Vehicle specifications</b>	Vehicle specifications, customizable features (Main topics: Fuel, oil, tire inflation pressure)	8
<b>For owners</b>	Reporting safety defects for U.S. owners, seat belt, SRS airbag and headlight aim instructions for Canadian owners	9
<b>Index</b>	Search by symptom	
	Search alphabetically	

For your information .....	6
Reading this manual .....	12
How to search .....	13
Pictorial index .....	14

## 1 For safety and security

<b>1-1. For safe use</b>	
Before driving .....	26
For safe driving .....	27
Seat belts .....	28
SRS airbags .....	32
Front passenger occupant classification system .....	39
Exhaust gas precautions .....	44
<b>1-2. Child safety</b>	
Riding with children.....	45
Child restraint systems .....	45
<b>1-3. Connected Services</b>	
Safety Connect .....	67
Remote Connect.....	70
Service Connect .....	71
<b>1-4. Hybrid system</b>	
Hybrid system features.....	72
Hybrid system precautions .....	77
<b>1-5. Theft deterrent system</b>	
Immobilizer system .....	82
Alarm.....	83

## 2 Vehicle status information and indicators

<b>2-1. Instrument cluster</b>	
Warning lights and indicators....	86
Gauges and meters .....	90
Multi-information display.....	98
Head-up display .....	101

Displayed content.....	104
------------------------	-----

## 3 Before driving

<b>3-1. Key information</b>	
Keys .....	114
Digital Key .....	117
<b>3-2. Opening, closing and locking the doors</b>	
Side doors .....	119
Power back door .....	124
Smart access system with push-button start .....	139
<b>3-3. Adjusting the seats</b>	
Front seats.....	144
Rear seats.....	145
Head restraints .....	152
<b>3-4. Adjusting the steering wheel and mirrors</b>	
Steering wheel .....	155
Inside rear view mirror .....	156
Digital Rear-view Mirror .....	157
Outside rear view mirrors.....	166
<b>3-5. Opening, closing the windows and moon roof</b>	
Power windows .....	169
Moon roof .....	171
Panoramic moon roof.....	174
<b>3-6. Favorite settings</b>	
Driving position memory .....	178
My Settings.....	182

## 4 Driving

<b>4-1. Before driving</b>	
Driving the vehicle.....	187

Cargo and luggage.....	193	LTA (Lane Tracing Assist).....	271
Vehicle load limits.....	196	LCA (Lane Change Assist).....	276
Trailer towing (vehicles without towing package).....	197	LDA (Lane Departure Alert)..	279
Trailer towing (vehicles with towing package).....	197	PDA (Proactive driving assist) .....	285
Dinghy towing .....	207	FCTA (Front Cross Traffic Alert) .....	290
<b>4-2. Driving procedures</b>		RSA (Road Sign Assist).....	293
Power (ignition) switch.....	208	Dynamic radar cruise control .....	295
EV drive mode.....	212	Cruise control .....	306
Automatic transmission.....	214	Emergency Driving Stop System .....	311
Hybrid transmission .....	220	Traffic Jam Assist .....	313
Turn signal lever.....	226	BSM (Blind Spot Monitor).....	319
Parking brake .....	226	Safe Exit Assist.....	323
Brake Hold.....	229	Intuitive parking assist.....	328
ASC (Active Sound Control)..	231	RCTA (Rear cross traffic alert) function.....	337
<b>4-3. Operating the lights and wipers</b>		RCD (Rear Camera Detection) function.....	342
Headlight switch.....	232	PKSB (Parking Support Brake) .....	345
AHS (Adaptive High-beam Sys- tem).....	234	Lexus Teammate Advanced Park .....	356
AHB (Automatic High Beam) .....	237	Driving mode select switch .....	390
Fog light switch .....	240	Trail Mode.....	392
Windshield wipers and washer .....	241	Driving assist systems .....	393
Rear window wiper and washer .....	245	<b>4-6. Driving tips</b>	
<b>4-4. Refueling</b>		Hybrid electric vehicle driving tips .....	400
Opening the fuel tank cap.....	247	Winter driving tips.....	402
<b>4-5. Using the driving support systems</b>		Utility vehicle precautions.....	405
Lexus Safety System + 3/Traffic Jam Assist software update .....	250		
Lexus Safety System + 3 .....	252		
Driver monitor.....	259		
PCS (Pre-Collision System).....	261		

## 5 Interior features

- 5-1. **Lexus Climate Concierge**  
Lexus Climate Concierge..... **410**
- 5-2. **Using the air conditioning system and defogger**  
Front automatic air conditioning system ..... **411**  
Rear air conditioning system... **420**  
Heated steering wheel/seat heaters/seat ventilators..... **422**
- 5-3. **Using the interior lights**  
Interior lights list..... **424**
- 5-4. **Using the storage features**  
List of storage features..... **427**  
Luggage compartment features ..... **431**
- 5-5. **Using the other interior features**  
Other interior features ..... **434**  
Using the power outlets (1500 W) ..... **444**  
If the power outlets (1500 W) cannot be used ..... **449**  
Garage door opener..... **450**

## 6 Maintenance and care

- 6-1. **Maintenance and care**  
Cleaning and protecting the vehicle exterior ..... **458**  
Cleaning and protecting the vehicle interior ..... **461**
- 6-2. **Maintenance**  
Maintenance requirements ..... **464**  
General maintenance ..... **465**

Emission inspection and maintenance (I/M) programs..... **468**

## 6-3. Do-it-yourself maintenance

- Do-it-yourself service precautions ..... **469**
- Hood ..... **471**
- Positioning a floor jack ..... **471**
- Engine compartment ..... **473**
- 12-volt battery ..... **481**
- Tires ..... **483**
- Tire inflation pressure..... **493**
- Wheels ..... **495**
- Air conditioning filter ..... **496**
- Cleaning the hybrid battery (traction battery) air intake vents ..... **498**
- Electronic key battery..... **501**
- Checking and replacing fuses ..... **503**
- Headlight aim ..... **505**
- Light bulbs..... **506**

## 7 When trouble arises

- 7-1. **Essential information**  
Emergency flashers ..... **510**  
If your vehicle has to be stopped in an emergency ..... **510**  
If the vehicle is submerged or water on the road is rising..... **511**
- 7-2. **Steps to take in an emergency**  
If your vehicle needs to be towed ..... **513**  
If you think something is wrong ..... **514**  
If a warning light turns on or a warning buzzer sounds..... **516**

If a warning message is displayed ..... **526**

If you have a flat tire..... **539**

If the hybrid system will not start ..... **547**

If you lose your keys ..... **548**

If the electronic key does not operate properly ..... **549**

If a door cannot be opened using the door opener switch..... **551**

If the 12-volt battery is discharged ..... **553**

If your vehicle overheats ..... **560**

If the vehicle becomes stuck ... **565**

**8 Vehicle specifications**

**8-1. Specifications**

Maintenance data (fuel, oil level, etc.) ..... **568**

Fuel information..... **579**

Tire information..... **581**

**8-2. Customization**

Customizable features..... **590**

**8-3. Initialization**

Items to initialize ..... **606**

**9 For owners**

**9-1. For owners**

Reporting safety defects for U.S. owners ..... **608**

Reporting safety defects for Canadian owners ..... **608**

Seat belt instructions for Canadian owners (in French)..... **609**

SRS airbag instructions for Canadian owners (in French) ..... **610**

Headlight aim instructions for Canadian owners (in French) ..... **615**

**Index**

What to do if... (Troubleshooting) ..... **618**

Alphabetical Index ..... **620**

## For your information

### Main Owner's Manual

Please note that this manual applies to all models and explains all equipment, including options. Therefore, you may find explanations for equipment not installed on your vehicle and the illustrations used may differ from your vehicle.

All specifications provided in this manual are current at the time of printing. Over time, your vehicle may receive updates that modify the vehicle and make material in this manual incomplete and/or inaccurate. Because of Lexus' interest in continual product improvement, Lexus reserves the right to make changes to this manual at any time without notice.

If Lexus chooses to update the manual, updated versions can be viewed by selecting your vehicle by model and year at the following URL or on your mobile device if you have access to the Lexus app.

<https://drivers.lexus.com>

### Noise from under vehicle after turning off the hybrid system

Approximately five hours after the hybrid system is turned off, you may hear sound coming from under the vehicle for several minutes. This is the sound of a fuel evaporation leakage check and, it does not indicate a malfunction.

## Accessories, spare parts and modification of your Lexus

A wide variety of non-genuine spare parts and accessories for Lexus vehicles are currently available in the market. You should know that Toyota does not warrant these products and is not responsible for their performance, repair, or replacement, or for any damage they may cause to, or adverse effect they may have on, your Lexus vehicle.

This vehicle should not be modified with non-genuine Lexus products. Modification with non-genuine Lexus products could affect its performance, safety or durability, and may even violate governmental regulations. In addition, damage or performance problems resulting from the modification may not be covered under warranty.

Also, remodeling like this will have an effect on advanced safety equipment such as Lexus Safety System + 3 and there is a danger that it will not work properly or the danger that it may work in situations where it should not be working.

### Cyber Attack Risk

Installing electronic devices and radios increases the risk of cyber attacks through the installed parts, which may lead to unexpected accidents and leakage of personal information.

Lexus does not make any guarantees

for problems caused by installing non-genuine Lexus products.

## Installation of a mobile two-way radio system

The installation of a mobile two-way radio system in your vehicle could affect electronic systems such as:

- Hybrid system
- Multiport fuel injection system/sequential multiport fuel injection system
- Lexus Safety System + 3
- Anti-lock brake system
- Vehicle dynamics integrated management (if equipped)
- SRS airbag system
- Seat belt pretensioner system

Be sure to check with your Lexus dealer for precautionary measures or special instructions regarding installation of a mobile two-way radio system.

High voltage parts and cables on the hybrid electric vehicles emit approximately the same amount of electromagnetic waves as the conventional gasoline powered vehicles or home electronic appliances despite of their electromagnetic shielding.

Unwanted noise may occur in the reception of the mobile two-way radio.

## Vehicle data recording

This vehicle is equipped with sophisticated computers that record certain

data regarding vehicle controls and operations.

### ■ Data recorded by the computers<sup>\*1</sup>

<sup>\*1</sup>: The recorded data varies according to the vehicle grade level and options with which it is equipped.

Certain data, such as the following, is recorded depending on the operation timing and status of each function.

- Basic vehicle behavior related data (engine speed/electric motor speed, accelerator/brake pedal operation, vehicle speed, etc.)
- Operating state of the driving support systems (recorded during system operation, includes basic vehicle behavior related data)
- Driving support system sensor data
- Image data (images from the front, rear, vehicle periphery, and driver monitor cameras)<sup>\*2</sup>

<sup>\*2</sup>: The vehicle has multiple cameras. For details on from which cameras images are recorded, contact your Lexus dealer.

### ● Location information

These computers do not record conversations, sounds, or images of the inside of the vehicle.

Also, personal information which may be used to identify the owner of the vehicle (name, gender, age, etc.) is not recorded.

### ■ Usage of recorded data and personal information by the Lexus Safety System + 3

The operating state of each system, data from each sensor, image data

(images from the front/rear cameras), and position information is recorded by the Lexus Safety System + 3 in the following situations. Toyota obtains this information when the vehicle is brought to the dealership or when sent to the Toyota servers.

- In certain collisions or collision-like situations
- When driving on roads with certain traffic situations, such as congestion, poor road surfaces, poor weather, etc.
- When driving on certain roads, such as roads which were recently opened or extended
- After the hybrid system is started, for a certain amount of time

To learn more about the vehicle data collected, used and shared by Lexus, please visit <http://www.lexus.com/privacyvts/>.

#### ■ Data provision and use purpose by third parties

Data recorded by the computers may be used for collision analysis, malfunction diagnosis, automated driving, advanced safety and map related technologies (technology, product development, product improvement, etc.) and products and services which use data (maps used for automated driving and advanced safety technologies, driving condition analysis, analysis of the driving environment, such as road infrastructure, traffic condition communication, etc. Herein referred to as "individual services".) Also, this data

may be used for customer support related to a collision, collision analysis or resolution.

In situations such as the following, Toyota may disclose the recorded data to a third party:

- When the consent of the vehicle owner (or the lessee if the vehicle is leased) has been given
- When officially requested by the police, a court of law or a government agency
- When it is to be used by Toyota in a lawsuit
- When data is to be used research purposes after processing so that the data is not tied to a specific vehicle or vehicle owner

In addition to the above, Toyota may disclose the data recorded by the Lexus Safety System + 3 to a third party in the following situations:

- When separate consent of the vehicle owner (or the lessee if the vehicle is leased) has been given. This includes situations when the user subscribes to an individual service which is provided by a second party and uses vehicle recorded data, where the provider has obtained the user's consent for providing data to a third-party
- When providing data to a company involved in autonomous driving software, etc. for the purpose of research and development (technology, product development, product improvement, etc.) of automated driving, advanced safety and map

related technologies

- When providing image data and position information to a company involved in map creation, etc. for the purpose of research and development map related technologies
- When providing image data and position information to a local government for the purpose of road maintenance, etc.
- When providing processed image data and position information to traffic condition communication individual services
- When providing image data from near a fire, or other area that emergency services are dispatched, to the fire department of a local government which has entered a separate contract with Lexus

---

Image information recorded by the vehicle can be erased by your Lexus dealer.

The image recording function can be disabled. However, if the function is disabled, data from when systems operate will not be available.

If you wish to stop the collection of Lexus Safety System + 3 data by the Toyota servers for the purpose of research and development and provision to individual services, contact your Lexus dealer.

### Event data recorder

This vehicle is equipped with an event data recorder (EDR). The main purpose of an EDR is to record, in certain crash or near crash-like situations, such as an air bag deployment or hitting a road obstacle, data that will assist in

understanding how a vehicle's systems performed. The EDR is designed to record data related to vehicle dynamics and safety systems for a short period of time, typically 30 seconds or less.

The EDR in this vehicle is designed to record such data as:

- How various systems in your vehicle were operating;
- Whether or not the driver and passenger safety belts were buckled/fastened;
- How far (if at all) the driver was depressing the accelerator and/or brake pedal; and,
- How fast the vehicle was traveling.

These data can help provide a better understanding of the circumstances in which crashes and injuries occur.

NOTE: EDR data are recorded by your vehicle only if a non-trivial crash situation occurs; no data are recorded by the EDR under normal driving conditions and no personal data (e.g., name, gender, age, and crash location) are recorded. However, other parties, such as law enforcement, could combine the EDR data with the type of personally identifying data routinely acquired during a crash investigation.

To read data recorded by an EDR, special equipment is required, and access to the vehicle or the EDR is needed. In addition to the vehicle manufacturer, other parties, such as law enforcement, that have the special equipment, can read the information if they have access to the vehicle or the EDR.

## ● Disclosure of the EDR data

Lexus will not disclose the data recorded in an EDR to a third party except when:

- An agreement from the vehicle's owner (or the lessee for a leased vehicle) is obtained
- In response to an official request by the police, a court of law or a government agency
- For use by Lexus in a lawsuit

However, if necessary, Lexus may:

- Use the data for research on vehicle safety performance
- Disclose the data to a third party for research purposes without disclosing information about the specific vehicle or vehicle owner

## Scraping of your Lexus

The SRS airbag and seat belt pretensioner devices in your Lexus contain explosive chemicals. If the vehicle is scrapped with the airbags and seat belt pretensioners left as they are, this may cause an accident such as fire. Be sure to have the systems of the SRS airbag and seat belt pretensioner removed and disposed of by a qualified service shop or by your Lexus dealer before you scrap your vehicle.

## Perchlorate Material

Special handling may apply, See [www.dtsc.ca.gov/hazardouswaste/perchlorate](http://www.dtsc.ca.gov/hazardouswaste/perchlorate).

Your vehicle has components that may contain perchlorate. These components may include the airbags, seat belt

pretensioners, wireless remote control batteries, and the batteries in the tire pressure warning valve and transmitters.

## "QR Code"

The word "QR Code" is registered trademark of DENSO WAVE INCORPORATED in Japan and other countries.



## WARNING

### ■ General precautions while driving

**Driving under the influence:** Never drive your vehicle when under the influence of alcohol or drugs that have impaired your ability to operate your vehicle. Alcohol and certain drugs delay reaction time, impair judgment and reduce coordination, which could lead to an accident that could result in death or serious injury.

**Defensive driving:** Always drive defensively. Anticipate mistakes that other drivers or pedestrians might make and be ready to avoid accidents.

**Driver distraction:** Always give your full attention to driving. Anything that distracts the driver, such as adjusting controls, talking on a cellular phone or reading can result in a collision with resulting death or serious injury to you, your occupants or others.

### ■ General precaution regarding children's safety

Never leave children unattended in the vehicle, and never allow children to have or use the key.



**WARNING**

Children may be able to start the vehicle or shift the vehicle into neutral. There is also a danger that children may injure themselves by playing with the windows, the moon roof or panoramic moon roof, or other features of the vehicle. In addition, heat build-up or extremely cold temperatures inside the vehicle can be fatal to children.

## Reading this manual



Explains symbols used in this manual.

## Symbols in this manual

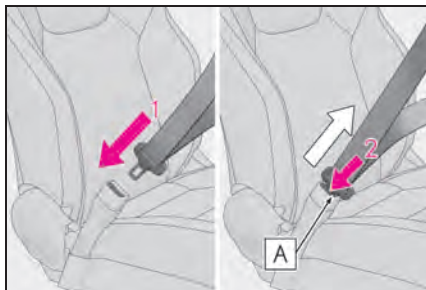

Symbols	Meanings
	<b>WARNING:</b> Explains something that, if not obeyed, could cause death or serious injury to people.
	<b>NOTICE:</b> Explains something that, if not obeyed, could cause damage to or a malfunction in the vehicle or its equipment.
	Indicates operating or working procedures. Follow the steps in numerical order.

## Symbols in illustrations

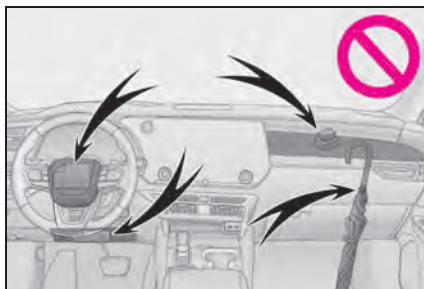

Symbols	Meanings
	Indicates the action (pushing, turning, etc.) used to operate switches and other devices.
	Indicates the outcome of an operation (e.g. a lid opens).



Symbols	Meanings
	Indicates the component or position being explained.
	Means <b>Do not</b> , <b>Do not do this</b> , or <b>Do not let this happen</b> .

## How to search

### ■ Searching by name

- Alphabetical index: →P.620

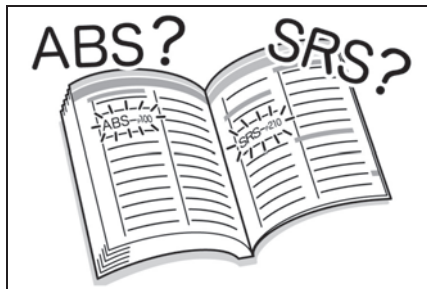

### ■ Searching by installation position

- Pictorial index: →P.14

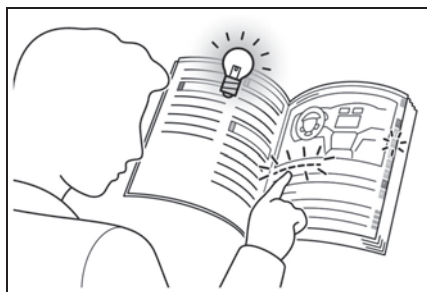

### ■ Searching by symptom or sound

- What to do if... (Troubleshooting):  
→P.618



### ■ Searching by title

- Table of contents: →P.2

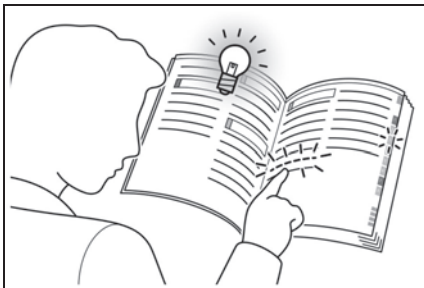

# Pictorial index

## ■ Exterior

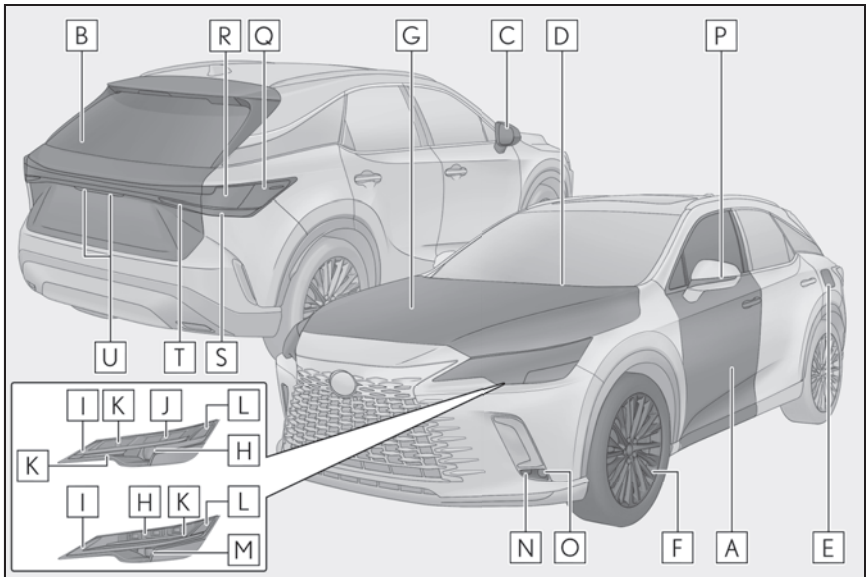

The shape of the lights may differ depending on the grade, etc.

- A** Side doors ..... P.119
  - Locking/unlocking ..... P.119
  - Opening/closing the side doors ..... P.122
  - Opening/closing the side windows ..... P.169
  - Locking/unlocking by using the mechanical key ..... P.549
  - Warning messages ..... P.526
- B** Back door ..... P.124
  - Opening from inside the cabin ..... P.126
  - Opening from outside ..... P.126
  - Warning messages ..... P.526
- C** Outside rear view mirrors ..... P.166
  - Adjusting the mirror angle ..... P.166
  - Folding the mirrors ..... P.167
  - Driving position memory \* ..... P.178
  - Defogging the mirrors ..... P.416

<b>D</b>	<b>Windshield wipers</b> .....	P.241
	Precautions for winter season.....	P.402
	To prevent freezing (windshield wiper de-icer)* .....	P.416
	Precautions for car wash .....	P.459
<b>E</b>	<b>Fuel filler door</b> .....	P.247
	Refueling method .....	P.247
	Fuel type/fuel tank capacity .....	P.570
<b>F</b>	<b>Tires</b> .....	P.483
	Tire size/inflation pressure .....	P.483, 576
	Winter tires/tire chains .....	P.402
	Checking/rotation/tire pressure warning system.....	P.483
	Coping with flat tires.....	P.539
<b>G</b>	<b>Hood</b> .....	P.471
	Opening .....	P.471
	Engine oil.....	P.571
	Coping with overheating.....	P.560
	Warning messages .....	P.526

### Light bulbs of the exterior lights for driving

(Replacing method: P.506, Watts: P.578)

<b>H</b>	<b>Headlights</b> .....	P.232
<b>I</b>	<b>Parking lights/daytime running lights</b> .....	P.232
<b>J</b>	<b>Daytime running lights</b> .....	P.232
<b>K</b>	<b>Front turn signal lights</b> .....	P.226
<b>L</b>	<b>Front side marker lights</b> .....	P.232
<b>M</b>	<b>Headlight high beams (for Canada)</b> .....	P.232
<b>N</b>	<b>Cornering lights</b> * .....	P.234
<b>O</b>	<b>Front fog lights</b> .....	P.240
<b>P</b>	<b>Side turn signal lights</b> .....	P.226
<b>Q</b>	<b>Rear side marker lights</b> .....	P.232
<b>R</b>	<b>Stop/tail lights</b> .....	P.232

- S** Stop lights/rear turn signal lights ..... P.226, 232
- T** Back-up lights
  - Shifting the shift position to R.....P.215, 221
- U** License plate lights ..... P.232

\*: If equipped

## Instrument panel

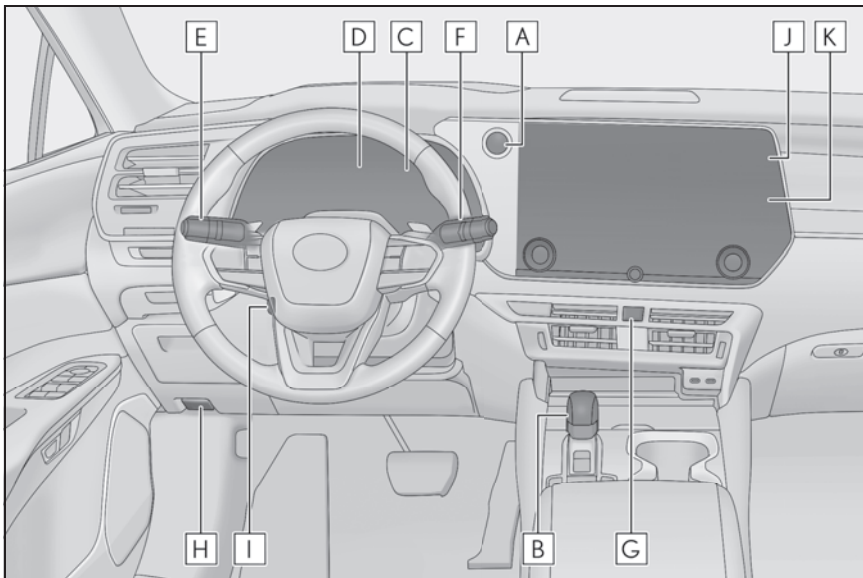

- A Power switch** ..... P.208
  - Starting the hybrid system/changing the modes..... P.208
  - Emergency stop of the hybrid system ..... P.510
  - When the hybrid system will not start ..... P.547
  - Warning messages ..... P.526
- B Shift lever**..... P.214, 220
  - Shifting the shift position ..... P.215, 221
  - Precautions for towing ..... P.513
- C Meters**..... P.90
  - Reading the meters/adjusting the instrument panel light..... P.90, 97
  - Warning lights/indicator lights ..... P.86
  - When a warning light turns on ..... P.516
- D Multi-information display**..... P.98
  - Display ..... P.98
  - Energy monitor ..... P.106
  - When the warning messages are displayed..... P.526

<b>E</b>	Turn signal lever .....	P.226
	Headlight switch.....	P.232
	Headlights/parking lights/tail lights/side marker lights/license plate lights/daytime running lights .....	P.232
	Front fog lights .....	P.240
<b>F</b>	Windshield wiper and washer switch.....	P.241, 245
	Usage.....	P.241, 245
	Adding washer fluid.....	P.480
	Warning messages .....	P.526
<b>G</b>	Emergency flasher switch .....	P.510
<b>H</b>	Hood lock release lever.....	P.471
<b>I</b>	Tilt and telescopic steering control switch.....	P.155
	Adjustment .....	P.155
	Driving position memory <sup>*1</sup> .....	P.178
<b>J</b>	Air conditioning system .....	P.411
	Usage.....	P.411
	Rear window defogger.....	P.416
<b>K</b>	Audio system <sup>*2</sup>	

<sup>\*1</sup>: If equipped

<sup>\*2</sup>: Refer to the "MULTIMEDIA OWNER'S MANUAL".

■ Switches

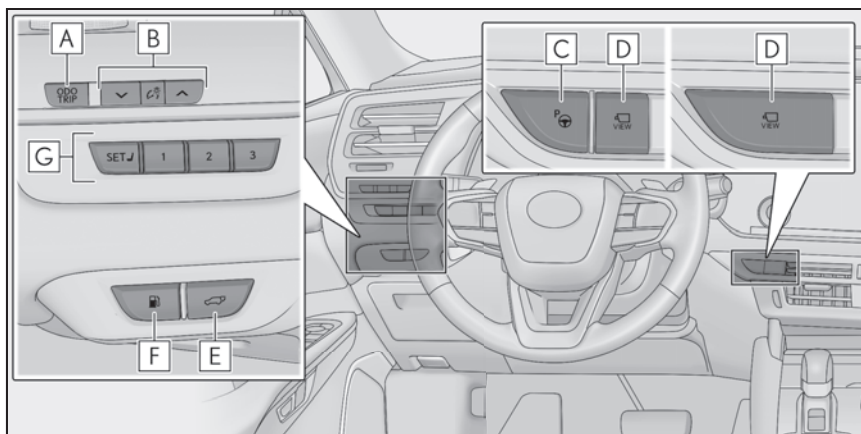

- A** “ODO TRIP” switch ..... P.96
- B** Instrument panel light control switches ..... P.97
- C** Advanced Park (parking assist system) main switch <sup>\*1</sup> ..... P.356
- D** Camera switch <sup>\*1,2</sup>
- E** Power back door switch..... P.126
- F** Fuel filler door opener switch..... P.248
- G** Driving position memory switches <sup>\*1</sup> ..... P.178

<sup>\*1</sup>: If equipped

<sup>\*2</sup>: Refer to the “MULTIMEDIA OWNER’S MANUAL”.

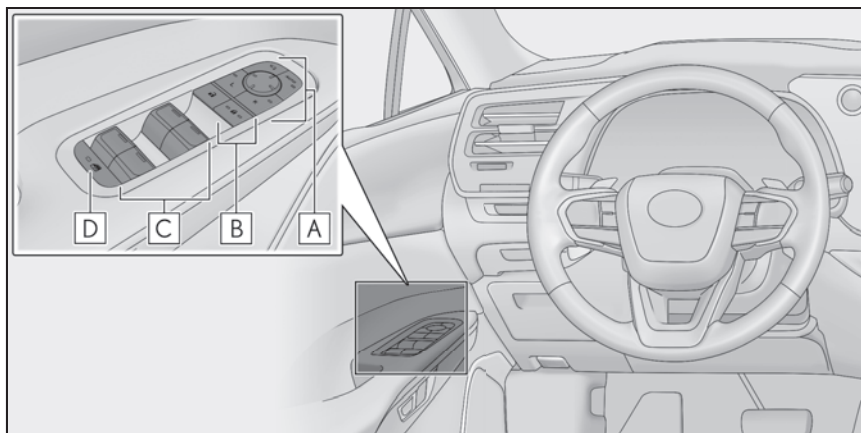

<b>A</b>	Outside rear view mirror switches.....	P.166
<b>B</b>	Door lock switches.....	P.121
<b>C</b>	Power window switches.....	P.169
<b>D</b>	Window lock switch.....	P.171

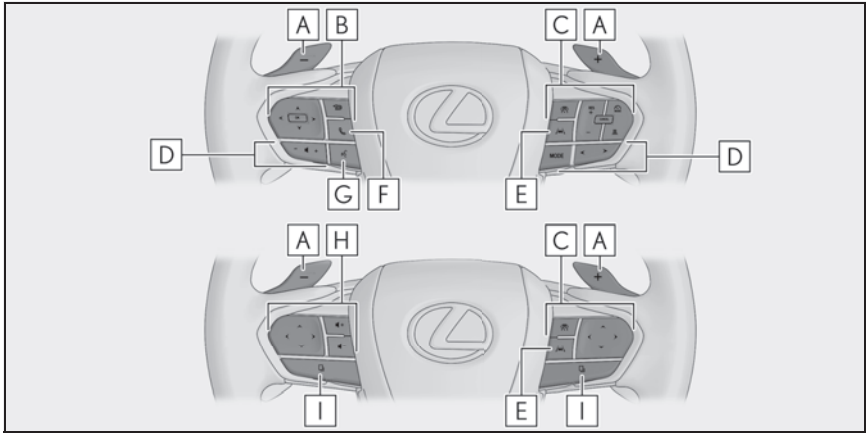

<b>A</b>	Paddle shift switches.....	P.217, 223
<b>B</b>	Meter control switches.....	P.104
<b>C</b>	Cruise control switch	
	Dynamic radar cruise control.....	P.295
	Cruise control.....	P.306
<b>D</b>	Audio remote control switches*	
<b>E</b>	LTA (Lane Tracing Assist) switch.....	P.271
<b>F</b>	Telephone switch*	
<b>G</b>	Talk switch*	
<b>H</b>	Audio remote control switches/telephone switch/talk switch*	
<b>I</b>	Switch function change switch*	

\*: Refer to the "MULTIMEDIA OWNER'S MANUAL".

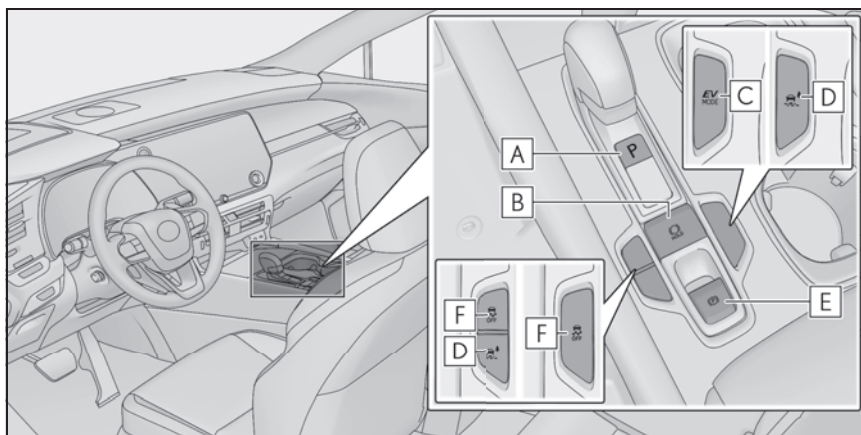

<b>A</b>	P position switch .....	P.215, 221
<b>B</b>	Brake hold switch .....	P.229
<b>C</b>	EV drive mode switch* .....	P.212
<b>D</b>	Trail Mode switch.....	P.392
<b>E</b>	Parking brake switch .....	P.226
	Applying/releasing .....	P.226
	Precautions for winter season.....	P.403
	Warning buzzer/messages.....	P.526
<b>F</b>	VSC OFF switch.....	P.395

\* : If equipped

## Interior

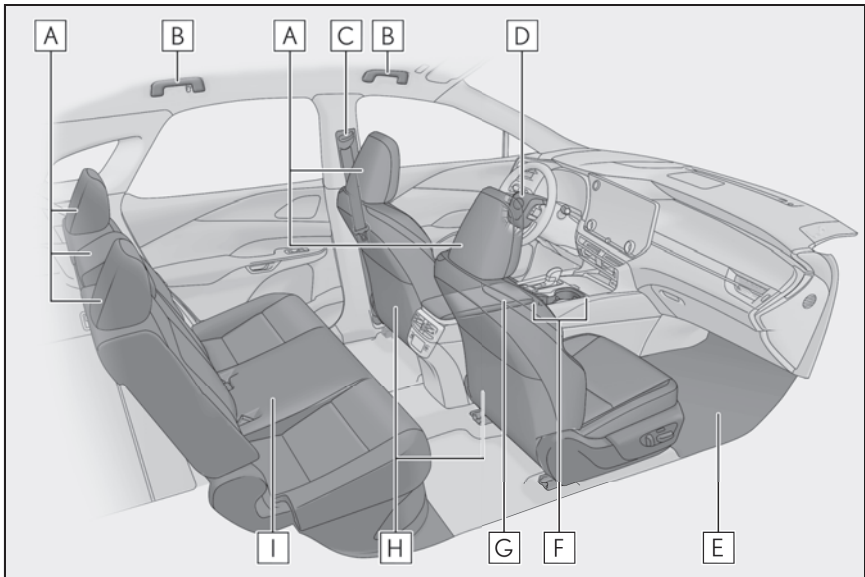

<b>A</b>	Head restraints .....	P.152
<b>B</b>	Assist grips .....	P.441
<b>C</b>	Seat belts .....	P.28
<b>D</b>	SRS airbags .....	P.32
<b>E</b>	Floor mats .....	P.26
<b>F</b>	Cup holders .....	P.428
<b>G</b>	Console box .....	P.428
<b>H</b>	Front seats .....	P.144
<b>I</b>	Rear seats .....	P.145

■ Ceiling

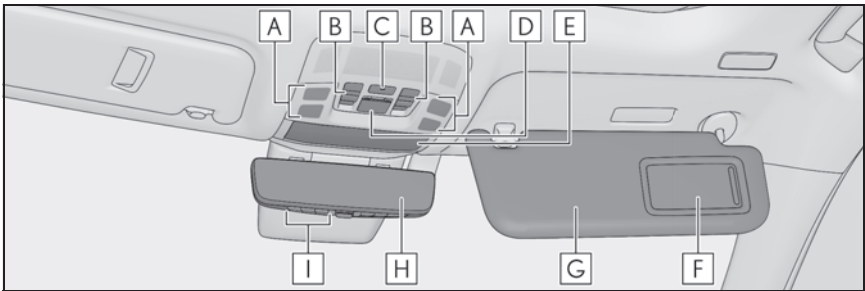

<b>A</b>	Interior light .....	P.425
	Personal lights <sup>*1</sup> .....	P.425
<b>B</b>	Moon roof switches <sup>*2</sup> .....	P.171
	Panoramic moon roof switches <sup>*2</sup> .....	P.174
<b>C</b>	Door-linked interior light switch .....	P.425
<b>D</b>	“SOS” button <sup>*2</sup> .....	P.67
<b>E</b>	Auxiliary box .....	P.430
<b>F</b>	Vanity mirrors .....	P.443
<b>G</b>	Sun visors .....	P.443
<b>H</b>	Inside rear view mirror <sup>*2</sup> .....	P.156
	Digital Rearview Mirror <sup>*2</sup> .....	P.157
<b>I</b>	Garage door opener switches .....	P.450

<sup>\*1</sup>: The illustration shows the front, but they are also equipped in the rear.

<sup>\*2</sup>: If equipped



## For safety and security

### 1

- 1-1. For safe use**
  - Before driving ..... **26**
  - For safe driving ..... **27**
  - Seat belts ..... **28**
  - SRS airbags ..... **32**
  - Front passenger occupant classification system ..... **39**
  - Exhaust gas precautions ..... **44**
- 1-2. Child safety**
  - Riding with children ..... **45**
  - Child restraint systems ..... **45**
- 1-3. Connected Services**
  - Safety Connect ..... **67**
  - Remote Connect ..... **70**
  - Service Connect ..... **71**
- 1-4. Hybrid system**
  - Hybrid system features ..... **72**
  - Hybrid system precautions ..... **77**
- 1-5. Theft deterrent system**
  - Immobilizer system ..... **82**
  - Alarm ..... **83**

## Before driving

Observe the following before starting off in the vehicle to ensure safety of driving.

### Installing floor mats

Use only floor mats designed specifically for vehicles of the same model and model year as your vehicle. Fix them securely in place onto the carpet.

- 1 Insert the retaining hooks (clips) into the floor mat eyelets.

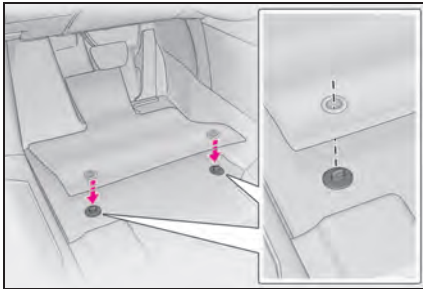

- 2 Turn the upper knob of each retaining hook (clip) to secure the floor mats in place.

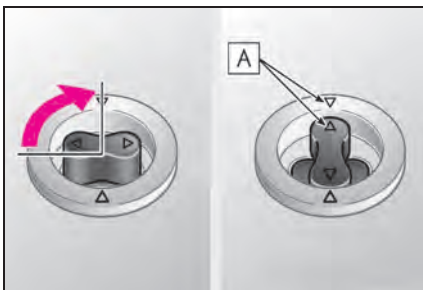

Always align the  $\triangle$  marks **A**.

The shape of the retaining hooks (clips) may differ from that shown in the illustration.

## ⚠ WARNING

Observe the following precautions. Failure to do so may cause the driver's floor mat to slip, possibly interfering with the pedals while driving. An unexpectedly high speed may result or it may become difficult to stop the vehicle. This could lead to an accident, resulting in death or serious injury.

### ■ When installing the driver's floor mat

- Do not use floor mats designed for other models or different model year vehicles, even if they are Lexus Genuine floor mats.
- Only use floor mats designed for the driver's seat.
- Always install the floor mat securely using the retaining hooks (clips) provided.
- Do not use two or more floor mats on top of each other.
- Do not place the floor mat bottom-side up or upside-down.

### ■ Before driving

- Check that the floor mat is securely fixed in the correct place with all the provided retaining hooks (clips). Be especially careful to perform this check after cleaning the floor.



- With the hybrid system stopped and the shift position in P, fully depress each pedal to the floor to make sure it does not interfere with the floor mat.

## For safe driving

For safe driving, adjust the seat and mirror to an appropriate position before driving.

## Correct driving posture

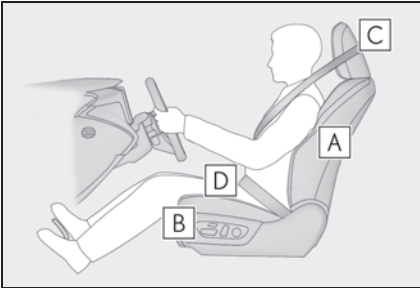

- A** Adjust the angle of the seatback so that you are sitting straight up and so that you do not have to lean forward to steer. (→P.144)
- B** Adjust the seat so that you can depress the pedals fully and so that your arms bend slightly at the elbow when gripping the steering wheel. (→P.144)
- C** Lock the head restraint in place with the center of the head restraint closest to the top of your ears. (→P.152)
- D** Wear the seat belt correctly. (→P.28)

## ⚠ WARNING

### ■ For safe driving

Observe the following precautions. Failure to do so may result in death or serious injury.

- Do not adjust the position of the driver's seat while driving. Doing so could cause the driver to lose control of the vehicle.
- Do not place a cushion between the driver or passenger and the seatback. A cushion may prevent correct posture from being achieved, and reduce the effectiveness of the seat belt and head restraint.
- Do not place anything under the front seats. Objects placed under the front seats may become jammed in the seat tracks and stop the seat from locking in place. This may lead to an accident and the adjustment mechanism may also be damaged.
- Always observe the legal speed limit when driving on public roads.
- When driving over long distances, take regular breaks before you start to feel tired. Also, if you feel tired or sleepy while driving, do not force yourself to continue driving and take a break immediately.

## Correct use of the seat belts

Make sure that all occupants are wearing their seat belts before driving the vehicle. (→P.28)

Use a child restraint system appropriate for the child until the child becomes large enough to properly wear the vehicle's seat belt. (→P.45)

## Adjusting the mirrors

Make sure that you can see backward clearly by adjusting the inside and outside rear view mirrors properly. (→P.156, 157, 166)

## Seat belts

**Make sure that all occupants are wearing their seat belts before driving the vehicle.**

### WARNING

Observe the following precautions to reduce the risk of injury in the event of sudden braking, sudden swerving or an accident. Failure to do so may cause death or serious injury.

#### ■ Wearing a seat belt

- Ensure that all passengers wear a seat belt.
- Always wear a seat belt properly.
- Each seat belt should be used by one person only. Do not use a seat belt for more than one person at once, including children.
- Lexus recommends that children be seated in the rear seat and always use a seat belt and/or an appropriate child restraint system.
- To achieve a proper seating position, do not recline the seat more than necessary. The seat belt is most effective when the occupants are sitting up straight and well back in the seats.
- Do not wear the shoulder belt under your arm.
- Always wear your seat belt low and snug across your hips.

- When using the rear center seat seat belt, check that the portion **A** in the illustration is buckled. If not buckled, make sure to buckle it before using the seat belt.

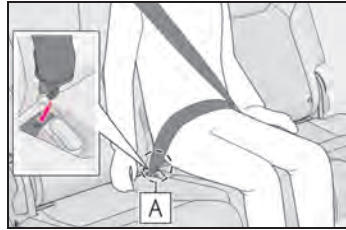

#### ■ Pregnant women

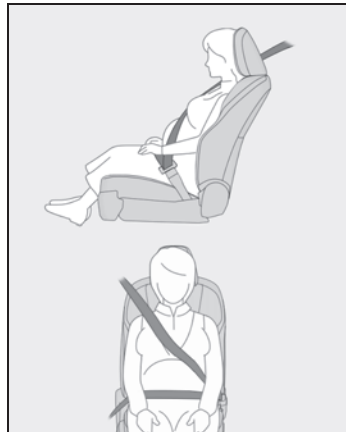

Obtain medical advice and wear the seat belt in the proper way. (→P.29)

Women who are pregnant should position the lap belt as low as possible over the hips in the same manner as other occupants, extending the shoulder belt completely over the shoulder and avoiding belt contact with the rounding of the abdominal area.

If the seat belt is not worn properly, not only the pregnant woman, but also the fetus could suffer death or serious injury as a result of sudden braking or a collision.

**⚠ WARNING****■ People suffering illness**

Obtain medical advice and wear the seat belt in the proper way. (→P.29)

**■ When children are in the vehicle**

→P.57

**■ Seat belt damage and wear**

- Do not damage the seat belts by allowing the belt, plate, or buckle to be jammed in the door.
- Inspect the seat belt system periodically. Check for cuts, fraying, and loose parts. Do not use a damaged seat belt until it is replaced. Damaged seat belts cannot protect an occupant from death or serious injury.
- Ensure that the belt and plate are locked and the belt is not twisted. If the seat belt does not function correctly, immediately contact your Lexus dealer.
- Replace the seat assembly, including the belts, if your vehicle has been involved in a serious accident, even if there is no obvious damage.
- Do not attempt to install, remove, modify, disassemble or dispose of the seat belts. Have any necessary repairs carried out by your Lexus dealer. Inappropriate handling may lead to incorrect operation.

**Correct use of the seat belts**

- Extend the shoulder belt so that it comes fully over the shoulder, but does not come into contact with the neck or slide off the shoulder.
- Position the lap belt as low as possible over the hips.
- Adjust the position of the seatback. Sit up straight and well back in the seat.
- Do not twist the seat belt.

**■ Child seat belt usage**

The seat belts of your vehicle were principally designed for persons of adult size.

- Use a child restraint system appropriate for the child, until the child becomes large enough to properly wear the vehicle's seat belt. (→P.45)
- When the child becomes large enough to properly wear the vehicle's seat belt, follow the instructions regarding seat belt usage. (→P.28)

**■ Seat belt extender**

If your seat belts cannot be fastened securely because they are not long enough, a personalized seat belt extender is available from your Lexus dealer free of charge.

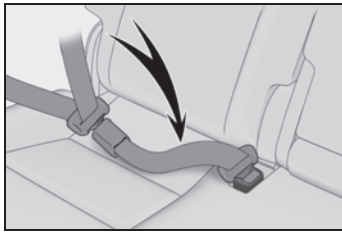

### ⚠ WARNING

#### ■ Using a seat belt extender

Observe the following precautions to reduce the risk of injury in the event of sudden braking, sudden swerving or an accident. Failure to do so may cause death or serious injury.

- Do not wear the seat belt extender if you can fasten the seat belt without the extender.
- Do not use the seat belt extender when installing a child restraint system because the belt will not securely hold the child restraint system, increasing the risk of death or serious injury in the event of an accident.
- The personalized extender may not be safe on another vehicle, when used by another person, or at a different seating position other than the one originally intended.

### ⚠ NOTICE

#### ■ When using a seat belt extender

When releasing the seat belt, press on the buckle release button on the extender, not on the seat belt. This helps prevent damage to the vehicle interior and the extender itself.

## Fastening and releasing the seat belt

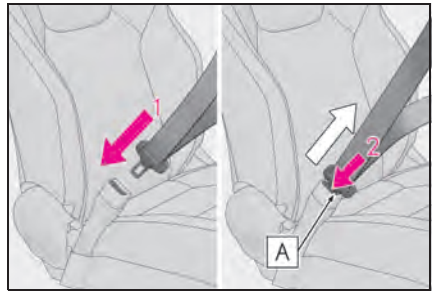

- 1 To fasten the seat belt, push the plate into the buckle until a click sound is heard.
- 2 To release the seat belt, press the release button **A**.

### ■ Emergency locking retractor (ELR)

The retractor will lock the belt during a sudden stop or on impact. It may also lock if you lean forward too quickly. When the seat belt locks, pull the belt strongly and then release the belt, then a slow and easy pulling will allow the belt to extend.

### ■ Automatic locking retractor (ALR)

When a passenger's shoulder belt is completely extended and then retracted even slightly, the belt is locked in that position and cannot be extended. This feature is used to hold the child restraint system (CRS) firmly. To free the belt again, fully retract the belt and then pull the belt out once more. (→P.45)

## Adjusting the seat belt shoulder anchor height (front seats)

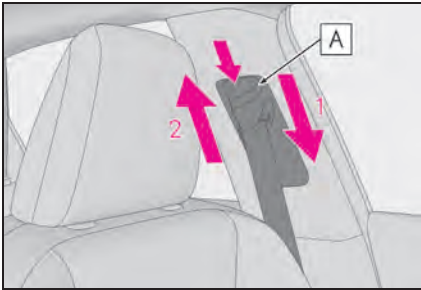

- 1 Push the seat belt shoulder anchor down while pressing the release button **A**.
- 2 Push the seat belt shoulder anchor up while pressing the release button **A**.

Move the height adjuster up and down as needed until you hear a click.

### **⚠ WARNING**

#### ■ Adjustable shoulder anchor

Always make sure the shoulder belt is positioned across the center of your shoulder. The belt should be kept away from your neck, but not falling off your shoulder. Failure to do so could reduce the amount of protection in an accident and cause death or serious injuries in the event of a sudden stop, sudden swerve or accident.

## Seat belt pretensioners (front and outboard rear seats)

When the vehicle is subjected to a severe frontal or side impact or rollover, the pretensioners retract the seat belts of the front seats and rear outer seats to securely restrain the occupants.

The pretensioners will not operate in minor frontal or side impacts, or rear impacts.

### ■ Replacing the belt after the pretensioner has been activated

If the vehicle is involved in multiple collisions, the pretensioner will activate for the first collision, but will not activate for the second or subsequent collisions.

### ■ PCS-linked control

If the PCS (Pre-Collision System) determines that the possibility of a collision with a vehicle is high, the seat belt pretensioners will be prepared to operate.

### **⚠ WARNING**

#### ■ Seat belt pretensioners

Observe the following precautions to reduce the risk of injury in the event of sudden braking or an accident. Failure to do so may result in death or serious injury.

- Do not place anything, such as a cushion, on the front passenger's seat. Doing so will disperse the passenger's weight, which prevents the sensor from detecting the passenger's weight properly. As a result, the seat belt pretensioner for the front passenger's seat may not operate in the event of a collision.
- If a pretensioner has operated, the SRS warning light will illuminate. In this situation, the seat belt cannot be used and must be replaced by your Lexus dealer.

## SRS airbags

The SRS airbags deploy when the vehicle is subjected to certain types of severe impact that may cause significant injury to the occupants. The airbags work together with the seat belts to help reduce the risk of death or serious injury.

### SRS airbag system

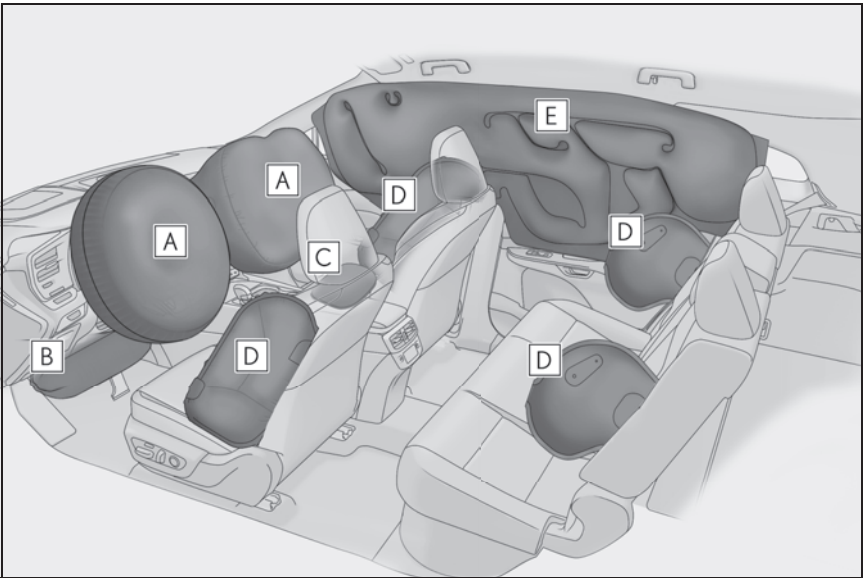

**A** SRS driver airbag/front passenger airbag

Help reduce impact to the head and chest of the driver and front passenger

**B** SRS knee airbag

Help reduce impact to the driver

**C** SRS seat cushion airbags

- Helps reduce impact to the front passenger

**D** SRS side airbags

- Help reduce impact to the chest of the occupants of the front seats
- Help reduce impact to the chest of the occupants of the rear outer seats

**E** SRS curtain shield airbags

- Help reduce impact to the heads of the occupants of the front and rear outer seats
- Can help prevent the occupants from being thrown from the vehicle in the event of a vehicle rollover

Your vehicle is equipped with ADVANCED AIRBAGS designed based on US motor vehicle safety standards (FMVSS208). The airbag sensor assembly (ECU) controls airbag deployment based on information obtained from the sensors, etc., shown in the system components diagram above. This information includes crash severity and occupant information. As the airbags deploy, a chemical reaction in the inflators quickly fills the airbags with non-toxic gas to help restrain the motion of the occupants.

#### ■ If the SRS airbags deploy (inflate)

- Slight abrasions, burns, bruising, etc., may be sustained from SRS airbags, due to the extremely high speed of deployment (inflation) by hot gases.
- A loud noise and white powder will be emitted.
- Parts of the airbag module (steering wheel hub, airbag cover and inflator) as well as the parts around the airbags may be hot for several minutes. The airbag itself may also be hot.
- The windshield may crack.
- The hybrid system will be stopped and fuel supply to the engine will be stopped. (→P.80)
- All of the doors will be unlocked. (→P.120)
- The brakes and stop lights will be controlled automatically. (→P.395)
- The interior lights will turn on automatically. (→P.426)
- The emergency flashers will turn on automatically. (→P.510)
- Vehicles with Safety Connect: If any of the following situations occur, the system is designed to send an emergency call to the response center, notifying them of the vehicle's location (without needing to push the "SOS" button) and an agent will attempt to speak with the occupants to ascertain the level of emergency and assistance required. If the occupants are unable to communicate, the agent automatically treats the call as an emergency and helps to dispatch the necessary emergency services. (→P.67)
  - When an SRS airbag has been deployed
  - When a seat belt pretensioner has oper-

ated

- When the vehicle has been involved in a severe rear-end collision

#### ■ The SRS airbags deploy in a frontal impact when

- The following SRS airbags will deploy in the event of an impact that exceeds a threshold level (level of force corresponding to an approximately 12 - 18 mph [20 - 30 km/h] frontal collision with a fixed wall that does not move or deform):
  - SRS front airbags
  - SRS seat cushion airbags
  - SRS knee airbags
- The threshold level at which the SRS airbags will deploy will be higher than normal in the in the following situations:
  - When the vehicle collides with an object, such as a parked vehicle or sign pole, which moves or deforms on impact
  - If the vehicle is involved in an underride collision, such as a collision in which the front of the vehicle "underrides", or goes under, the bed of a truck
- Depending on the type of collision, only the following may deploy:
  - Seat belt pretensioners
- The SRS airbags for the front passenger's seat will not deploy if there is no passenger in the front passenger seat. However, the SRS airbags for the front passenger's seat may deploy, even if the seat is unoccupied, if luggage is put on the seat.
- The SRS seat cushion airbag for the front passenger's seat will not deploy if the seat belt of the front passenger's seat is unfastened.
- In the event of an especially severe frontal collision, the left and right SRS curtain shield airbags may also deploy.

### ■ The SRS airbags deploy in a side impact when

- The following SRS airbags will deploy in the event of an impact that exceeds the set threshold level (level of force corresponding to the impact force produced by an approximately 3300 lb. [1500 kg] vehicle colliding with the passenger compartment at a perpendicular angle at an approximate speed of 12 - 18 mph [20 - 30 km/h]):
  - SRS side airbags
  - SRS curtain shield airbags
- If the vehicle is involved in a rollover, the following SRS airbags will deploy:
  - Both left and right SRS curtain shield airbags

### ■ The SRS airbags deploy in an underside impact when

- The following airbags may deploy if the underside of the vehicle collides with a hard object:
  - SRS front airbags
  - SRS knee airbags
  - SRS seat cushion airbags
  - SRS side airbags
  - SRS curtain shield airbags

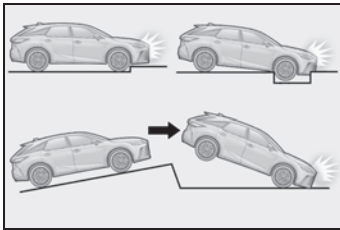

- The following airbags may deploy if the vehicle becomes significantly tilted or is strongly impacted by skidding into a curb, etc.:
  - SRS seat cushion airbags

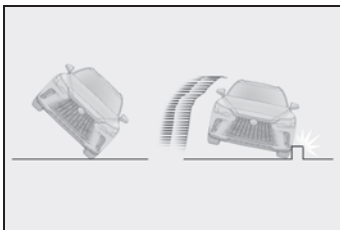

### ■ The SRS side airbags will not deploy when

- The following SRS airbags will not normally deploy in side or rear collisions, vehicle rollovers, or low speed frontal collisions. However, if such a collision causes sufficient sudden deceleration, the SRS airbags may deploy.
  - SRS front airbags
  - SRS knee airbags
  - SRS seat cushion airbags

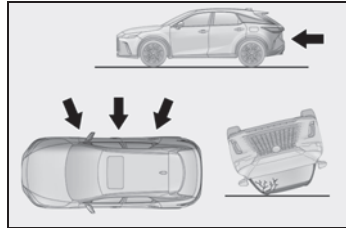

- The following SRS airbags may not deploy if the vehicle is collided with at a certain angle or in a side collision where an area of the vehicle other than the passenger compartment is collided with:
  - SRS side airbags
  - SRS curtain shield airbags

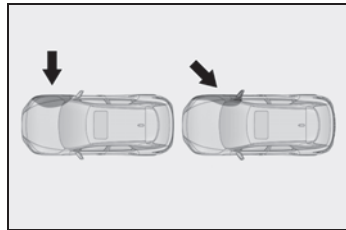

- The following SRS airbags will not normally deploy in front or rear collisions, vehicle rollovers, or low speed side collisions:
  - SRS side airbags

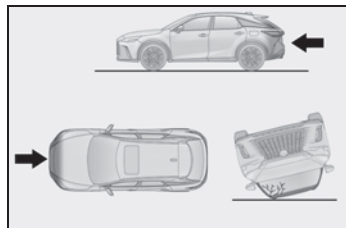

- The following SRS airbags will not normally deploy in rear collisions, end over

end vehicle rollovers, or low speed front or side collisions:

- SRS curtain shield airbags

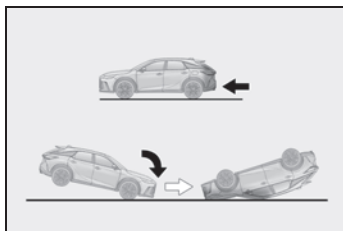

### ■ When to contact your Lexus dealer

In the following situations, the vehicle will require inspection and/or repair. Contact your Lexus dealer as soon as possible.

- When any of the SRS airbags have been deployed
- When the front of the vehicle is damaged or deformed, or was involved in a collision that was not severe enough to cause any of the following SRS airbags to deploy:
  - SRS front airbags
  - SRS knee airbags
  - SRS seat cushion airbags

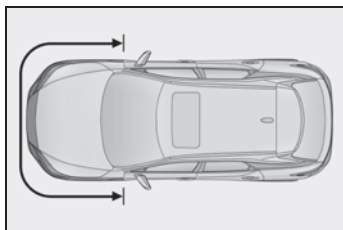

- When a door or its surrounding area is damaged, deformed or has had a hole made in it, or was involved in a collision that was not severe enough to cause any of the following SRS airbags to deploy:
  - SRS side airbags
  - SRS curtain shield airbags

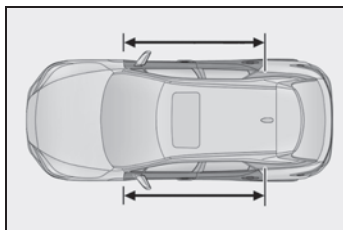

- When the pad section of the steering wheel, the dashboard near the front passenger SRS airbag or the lower side of the instrument panel is scratched, cracked, or otherwise damaged.
- When the seat cushion surface is scratched, cracked, or otherwise damaged.
- When the surface of a seat with an SRS side airbag is scratched, cracked, or otherwise damaged.
- When the part of a front pillar, rear pillar or roof side rail garnish (padding) which covers a SRS curtain shield airbag is scratched, cracked, or otherwise damaged.

### ⚠ WARNING

#### ■ SRS airbag precautions

Observe the following precautions. Failure to do so may result in death or serious injury.

- The driver and all passengers must wear their seat belts correctly. The SRS airbags are supplemental devices to be used with the seat belts.
- The SRS driver airbag deploys with considerable force, and can cause death or serious injury, especially if the driver is very close to the airbag. The National Highway Traffic Safety Administration (NHTSA) advises:

Since the risk zone for the driver's airbag is the first 2 - 3 in. (50 - 75 mm) of inflation, placing yourself 10 in. (250 mm) from your driver airbag provides you with a clear margin of safety. This distance is measured from the center of the steering wheel to your breastbone. If your current driving position places you less than 10 in. (250 mm) away from the driver airbag, you can change your driving position in several ways:

- Move your seat to the rear as far as possible while still being able to reach the pedals comfortably.

## WARNING

- Slightly recline the seatback. Although vehicle designs vary, many drivers can achieve the 10 in. (251 mm) distance, even with the driver seat all the way forward, simply by reclining the seatback somewhat. If reclining the seatback makes it hard to see the road, raise yourself by using a firm, non-slippery cushion, or raise the seat if your vehicle has that feature.
- If your steering wheel is adjustable, tilt it downward. This points the airbag toward your chest instead of your head and neck. The seat should be adjusted as recommended by the NHTSA, while still being able to control the vehicle with the pedals and steering wheel, and maintaining your view of the instrument panel controls.
- If a seat belt extender has been connected to the front passenger seat belt buckle but the latch plate of the front passenger seat belt has not been fastened to the seat belt extender, the SRS airbag system will judge that the front passenger is wearing the seat belt even though the seat belt has not been fastened. In this case, the SRS front airbags for the front passenger may not deploy correctly in a collision, resulting in death or serious injury. Be sure to wear the seat belt correctly when using a seat belt extender.



- The SRS front passenger airbag deploys with considerable force, and can cause death or serious injury, especially if the front passenger is very close to the airbag. The front passenger seat should be positioned as far possible from the airbag with the seatback adjusted so that the passenger is sat upright.
- Improperly seated and/or restrained infants and children can be killed or seriously injured by a deploying airbag. An infant or child who is too small to use a seat belt should be properly secured using a child restraint system. Lexus strongly recommends that all infants and children be placed in the rear seats of the vehicle and properly restrained. The rear seats are safer for infants and children than the front passenger seat. (→P.45)
- Do not sit on the edge of the seat or lean against the dashboard.

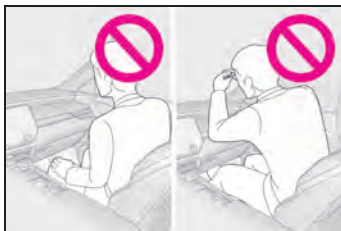

- Do not allow a child to stand in front of the SRS front passenger airbag or sit on the lap of a front passenger.
- Front seat occupants should never hold items on their lap.

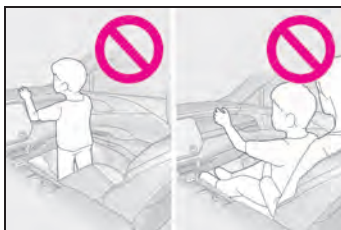

**⚠ WARNING**

- Do not lean against the door, roof side rail, or front, side, or rear pillar.



- Do not allow anyone to kneel on a seat toward the door or put their head or hands outside the vehicle.



- Do not attach anything to or lean anything against areas such as the dashboard, steering wheel pad and lower portion of the instrument panel.



- Do not attach anything to areas such as the doors, windshield, side windows, front or rear pillars, roof side rails and assist grips.



- Do not hang coat hangers or other hard objects on the coat hooks. These items could become projectiles if the SRS curtain shield airbags deploy, possibly leading to death or serious injury.
- If a vinyl cover is attached to the area where the SRS knee airbag deploys, be sure to remove it.
- Do not use seat accessories which cover the parts from which the SRS airbags deploy, as they may interfere with inflation of the SRS airbags. Such accessories may prevent the SRS airbags from deploying correctly, may disable the system or cause the SRS airbags to inflate unintentionally, possibly resulting in death or serious injury.
- Do not strike or apply significant force to the SRS airbag system components, front doors or their surrounding area. Doing so may cause the SRS airbags to malfunction.
- Do not touch any components of the SRS airbags immediately after the SRS airbags have deployed (inflated) as they may be hot.
- If breathing becomes difficult after the SRS airbags have deployed, open a door or window to allow fresh air in, or leave the vehicle if it is safe to do so. Wash off any residue as soon as possible to prevent skin irritation.



## WARNING

- If a part where an SRS airbag is stored is damaged or cracked, have it replaced by your Lexus dealer.
- Do not place anything, such as a cushion, on the front passenger's seat. Doing so will disperse the passenger's weight, which prevents the sensor from detecting the passenger's weight properly. As a result, the SRS front airbags for the front passenger's seat may not deploy in the event of a collision.

### ■ Modification and disposal of SRS airbag system components

Do not dispose of your vehicle or perform any of the following modifications without consulting your Lexus dealer. The SRS airbags may malfunction or deploy unintentionally, possibly leading to death or serious injury.

- Removal, installation, disassembly or repair of the SRS airbags
- Repair, removal or modification of the following parts or their surrounding
  - Steering wheel
  - Instrument panel
  - Dashboard
  - Seats
  - Seat upholstery
  - Front pillars
  - Side pillars
  - Rear pillars
  - Roof side rails
  - Front door panels
  - Front door trim
  - Front door speakers

- Modifications to the front door panels (such as making holes in them)
- Repair or modification of the following parts or their surrounding
  - Front fender
  - Front bumper
  - Sides of the vehicle interior
- Installation of the following parts or accessories
  - Bull bars or kangaroo bars
  - Snow plows
  - Winches
  - Roof luggage carriers
- Modifications to the vehicle's suspension
- Installation of electronic devices such as mobile two-way radios and CD players
- Modifications to your vehicle for a persons with a physical disability

## Front passenger occupant classification system

Your vehicle is equipped with a front passenger occupant classification system.

This system detects the conditions of the front passenger seat and activates or deactivates the following SRS airbags.

- SRS front passenger airbag
- Front passenger's seat SRS seat cushion airbag

## System components

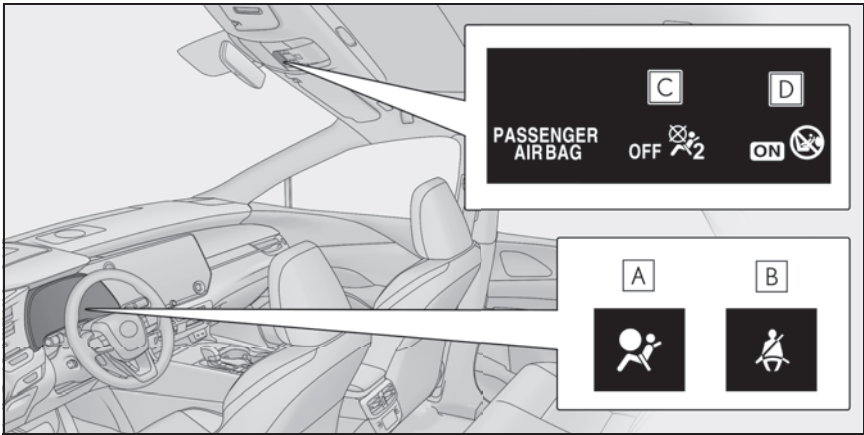

- A** SRS warning light
- B** Front passenger's seat belt reminder light
- C** "AIR BAG OFF" indicator light
- D** "AIR BAG ON" indicator light

**WARNING**

**Front passenger occupant classification system precautions**

Observe the following precautions regarding the front passenger occupant classification system. Failure to do so may cause death or serious injury.

- Wear the seat belt properly.
- Make sure the front passenger's seat belt plate has not been left inserted into the buckle before someone sits in the front passenger seat.

- Make sure the "AIR BAG OFF" indicator light is not illuminated when using the seat belt extender for the front passenger seat. If the "AIR BAG OFF" indicator light is illuminated, disconnect the extender tongue from the seat belt buckle, and reconnect the seat belt. Reconnect the seat belt extender after making sure the "AIR BAG ON" indicator light is illuminated. If you use the seat belt extender while the "AIR BAG OFF" indicator light is illuminated, the SRS airbags for the front passenger will not activate, which could cause death or serious injury in the event of a collision.
- Do not apply a heavy load to the front passenger seat or equipment (e.g. seatback pocket).
- Do not put weight on the front passenger seat by putting your hands or feet on the front passenger seat seatback from the rear passenger seat.

 **WARNING**

- Do not let a rear passenger lift the front passenger seat with their feet or press on the seatback with their legs.
- Do not put objects under the front passenger seat.
- Do not recline the front passenger seatback so far that it touches a rear seat. This may cause the “AIR BAG OFF” indicator light to be illuminated, which indicates that the SRS airbags for the front passenger will not activate in the event of a severe accident. If the seatback touches the rear seat, return the seatback to a position where it does not touch the rear seat. Keep the front passenger seatback as upright as possible when the vehicle is moving. Reclining the seatback excessively may lessen the effectiveness of the seat belt system.
- If an adult sits in the front passenger seat, the “AIR BAG ON” indicator light is illuminated. If the “AIR BAG OFF” indicator is illuminated, ask the passenger to sit up straight, well back in the seat, feet on the floor, and with the seat belt worn correctly. If the “AIR BAG OFF” indicator still remains illuminated, either ask the passenger to move to the rear seat, or if that is not possible, move the front passenger seat fully rearward.
- When it is unavoidable to install a forward-facing child restraint system on the front passenger seat, install the child restraint system on the front passenger seat in the proper order. (→P.51)
- Do not modify or remove the front seats.
- Do not kick the front passenger seat or subject it to severe impact. Otherwise, the SRS warning light may come on to indicate a malfunction of the front passenger occupant classification system. In this case, contact your Lexus dealer immediately.

- Child restraint systems installed on the rear seat should not contact the front seatbacks.
- Do not use a seat accessory, such as a cushion and seat cover, that covers the seat cushion surface.
- Do not modify or replace the upholstery of the front seat.

## Front passenger occupant classification system conditions and operation

### ■ Adult<sup>\*1</sup>

Indicator/warning light	"AIR BAG ON" and "AIR BAG OFF" indicator lights	"AIR BAG ON"
	SRS warning light	Off
	Front passenger's seat belt reminder light	Off <sup>*2</sup> or flashing <sup>*3</sup>
Devices	Front passenger airbag	Activated
	Seat cushion airbag in the front passenger side	Activated <sup>*2</sup> or deactivated <sup>*3</sup>

### ■ Child<sup>\*4</sup>

Indicator/warning light	"AIR BAG ON" and "AIR BAG OFF" indicator lights	"AIR BAG OFF" or "AIR BAG ON" <sup>*4</sup>
	SRS warning light	Off
	Front passenger's seat belt reminder light	Off <sup>*2</sup> or flashing <sup>*3</sup>
Devices	Front passenger airbag	Deactivated or activated <sup>*4</sup>
	Seat cushion airbag in the front passenger side	Deactivated or activated <sup>*4, 2</sup>

### ■ Child restraint system with infant<sup>\*5</sup>

Indicator/warning light	"AIR BAG ON" and "AIR BAG OFF" indicator lights	"AIR BAG OFF" <sup>*6</sup>
	SRS warning light	Off
	Front passenger's seat belt reminder light	Off <sup>*2</sup> or flashing <sup>*3</sup>
Devices	Front passenger airbag	Deactivated
	Seat cushion airbag in the front passenger side	

### ■ Unoccupied

Indicator/warning light	“AIR BAG ON” and “AIR BAG OFF” indicator lights	“AIR BAG OFF”
	SRS warning light	Off
	Front passenger’s seat belt reminder light	
Devices	Front passenger airbag	Deactivated
	Seat cushion airbag in the front passenger side	

### ■ System malfunction

Indicator/warning light	“AIR BAG ON” and “AIR BAG OFF” indicator lights	“AIR BAG OFF”
	SRS warning light	On
	Front passenger’s seat belt reminder light	Off
Devices	Front passenger airbag	Deactivated
	Seat cushion airbag in the front passenger side	

- \*1: The system judges a person of adult size as an adult. When a smaller adult sits in the front passenger seat, the system may not recognize them as an adult depending on their physique and posture.
- \*2: In the event the front passenger is wearing a seat belt.
- \*3: In the event the front passenger does not wear a seat belt.
- \*4: For some children, child in seat, child in booster seat or child in convertible seat, the system may not recognize them as a child. Factors which may affect this can be the physique or posture.
- \*5: Never install a rear-facing child restraint system on the front passenger seat. A forward-facing child restraint system should only be installed on the front passenger seat when it is unavoidable. (→P.45)
- \*6: In case the indicator light is not illuminated, consult this manual on how to install the child restraint system properly. (→P.51)

## Exhaust gas precautions

**Harmful substance to the human body is included in exhaust gases if inhaled.**

### WARNING

Exhaust gases include harmful carbon monoxide (CO), which is colorless and odorless. Observe the following precautions.

Failure to do so may cause exhaust gases enter the vehicle and may lead to an accident caused by light-headedness, or may lead to death or a serious health hazard.

#### ■ Important points while driving

- Keep the back door closed.
- If you smell exhaust gases in the vehicle even when the back door is closed, open the windows and have the vehicle inspected at your Lexus dealer as soon as possible.

#### ■ When parking

- If the vehicle is in a poorly ventilated area or a closed area, such as a garage, stop the hybrid system.
- Do not leave the vehicle with the hybrid system on for a long time. If such a situation cannot be avoided, park the vehicle in an open space and ensure that exhaust fumes do not enter the vehicle interior.
- Do not leave the hybrid system operating in an area with snow build-up, or where it is snowing. If snowbanks build up around the vehicle while the hybrid system is operating, exhaust gases may collect and enter the vehicle.

#### ■ Exhaust pipe

The exhaust system needs to be checked periodically. If there is a hole or crack caused by corrosion, damage to a joint or abnormal exhaust noise, be sure to have the vehicle inspected and repaired by your Lexus dealer.

## Riding with children

Observe the following precautions when children are in the vehicle. Use a child restraint system appropriate for the child, until the child becomes large enough to properly wear the vehicle's seat belt.

- It is recommended that children sit in the rear seats to avoid accidental contact with the shift lever, wiper switch, etc.
- Use the rear door child-protector lock or the window lock switch to avoid children opening the door while driving or operating the power window accidentally. (→P.123, 171)
- Do not let small children operate equipment which may catch or pinch body parts, such as the power window, hood, back door, seats etc.



### WARNING

#### ■ When children are in the vehicle

Never leave children unattended in the vehicle, and never allow children to have or use the key.

Children may be able to start the vehicle or shift the vehicle into neutral. There is also a danger that children may injure themselves by playing with the windows, the moon roof or panoramic moon roof, or other features of the vehicle. In addition, heat build-up or extremely cold temperatures inside the vehicle can be fatal to children.

## Child restraint systems

Before installing a child restraint system in the vehicle, there are precautions that need to be observed, different types of child restraint systems, as well as installation methods, etc., written in this manual.

Use a child restraint system when riding with a small child that cannot properly use a seat belt. For the child's safety, install the child restraint system to a rear seat. Be sure to follow the installation method that is in the operation manual enclosed with the restraint system.

### Table of contents

Points to remember: P.46

Child restraint system: P.51

When using a child restraint system: P.52

Child restraint system compatibility for each seating position (for Puerto Rico): P.47

Child restraint system installation method

- Fixed with a seat belt: P.54
- Fixed with a child restraint LATCH anchor (except for Puerto Rico): P.60
- Fixed with an ISOFIX lower anchorage (for Puerto Rico): P.60
- Using an anchor bracket (for top tether strap) (except for Puerto Rico): P.65
- Using a top tether anchorage (for

Puerto Rico): P.65

### Points to remember

The laws of all 50 states of the U.S.A. as well as Canada now require the use of child restraint systems.

- Prioritize and observe the warnings, as well as the laws and regulations for child restraint systems.
- Use a child restraint system until the child becomes large enough to properly wear the vehicle's seat belt.
- Choose a child restraint system that suits your vehicle and is appropriate to the age and size of the child.



### WARNING

#### ■ When a child is riding

Observe the following precautions. Failure to do so may result in death or serious injury.

- For effective protection in automobile accidents and sudden stops, a child must be properly restrained, using a seat belt or child restraint system which is correctly installed. For installation details, refer to the operation manual enclosed with the child restraint system. General installation instruction is provided in this manual.
- Lexus strongly urges the use of a proper child restraint system that conforms to the weight and size of the child, installed on the rear seat. According to accident statistics, the child is safer when properly restrained in the rear seat than in the front seat.

- Holding a child in your or someone else's arms is not a substitute for a child restraint system. In an accident, the child can be crushed against the windshield or between the holder and the interior of the vehicle.

#### ■ Handling the child restraint system

If the child restraint system is not properly fixed in place, the child or other passengers may be seriously injured or even killed in the event of sudden braking, sudden swerving, or an accident.

- If the vehicle were to receive a strong impact from an accident, etc., it is possible that the child restraint system has damage that is not readily visible. In such cases, do not reuse the restraint system.
- Except for Puerto Rico: Make sure you have complied with all installation instructions provided with the child restraint system manufacturer and that the system is properly secured.
- For Puerto Rico: Depending on the child restraint system, installation may be difficult or impossible. In those cases, check whether the child restraint system is suitable for installation in the vehicle. (→P.47) Be sure to install and observe the usage rules after carefully reading the child restraint system fixing method in this manual, as well as the operation manual enclosed with the child restraint system.
- Keep the child restraint system properly secured on the seat even if it is not in use. Do not store the child restraint system unsecured in the passenger compartment.
- If it is necessary to detach the child restraint system, remove it from the vehicle or store it securely in the luggage compartment.

## Child restraint system compatibility for each seating position (for Puerto Rico)

### ■ Child restraint system compatibility for each seating position

Compatibility of each seating position with child restraint systems (→P.48) displays the type of child restraint systems that can be used and possible seating positions for installation using symbols. Also, the recommended child restraint system that is suitable for your child can be selected.

Otherwise, check [Recommended child restraint systems and Compatibility table] for recommended child restraint systems. (→P.50)

Check the selected child restraint system together with the following [Before confirming the compatibility of each seating position with child restraint systems].

### ■ Before confirming the compatibility of each seating position with child restraint systems

**1** Checking the child restraint system standards.

Use a child restraint system that conforms to UN(ECE) R44<sup>\*1</sup> or UN(ECE) R129<sup>\*1,2</sup>.

The following approval mark is displayed on child restraint systems which are conformed.

Check for an approval mark

attached to the child restraint system.

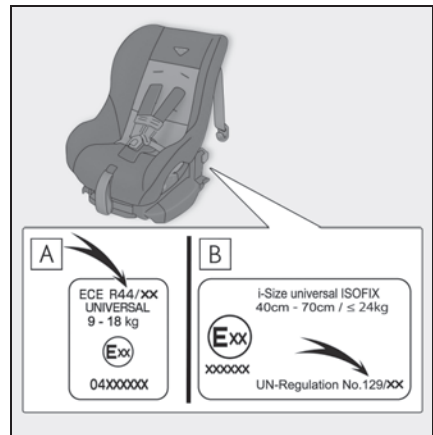

Example of the displayed regulation Number

**A** UN(ECE) R44 approval mark<sup>\*3</sup>  
The weight range of the child who is applicable for an UN(ECE) R44 approval mark is indicated.

**B** UN(ECE) R129 approval mark<sup>\*3</sup>  
The height range of the child who is applicable as well as available weights for an UN(ECE) R129 approval mark is indicated.

**2** Checking the category of the child restraint system.

Check the approval mark of the child restraint system for which of the following categories the child restraint system is suitable.

Also, if there are any uncertainties, check the user's guide included with the child restraint system or contact the retailer of the child restraint system.

- “universal”
- “semi-universal”
- “restricted”

- “vehicle specific”

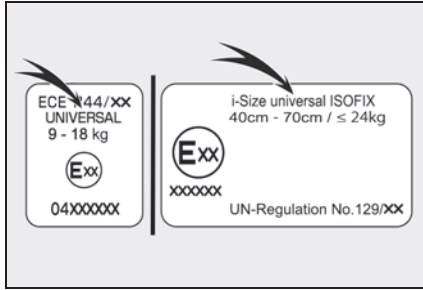



\*1: UN(ECE) R44 and UN(ECE) R129 are U.N. regulations for child restraint systems.

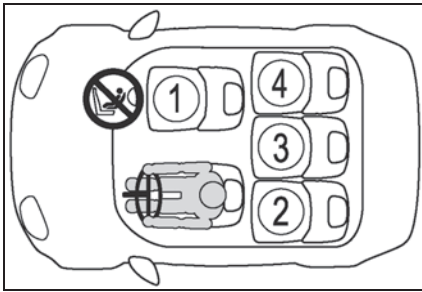

\*2: The child restraint systems mentioned in the table may not be available outside of the EU area.

\*3: The displayed mark may differ depending on the product.

### ■ Compatibility of each seating position with child restraint systems



① *1, 2, 3	UF *4
② *2, 3	U L  

③ *2, 3	U 
④ *2, 3	U L  

**U** Suitable for “universal” category child restraint system fixed with the seat belt.

Suitable for fixed installing a forward-facing child seat with vehicle seat belt “universal” category child restraint system.

**UF**

**L**

Suitable for child restraint systems given on recommended child restraint systems and compatibility table (→P.50).



Suitable for ISOFIX child restraint system.



Includes a top tether anchorage point.



Never use a rear-facing child restraint system on the front passenger seat.

\*1: Move the front seat fully rearward. If the passenger seat height can be adjusted, move it to the upper most position.

\*2: Adjust the seatback angle to the most upright position. When installing a forward-facing child seat, if there is a gap between the child seat and the seatback, adjust the seatback angle until good contact is achieved.

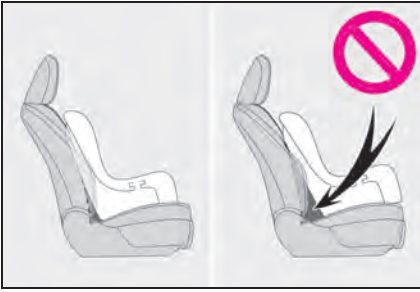

Otherwise, put the head restraint in the upper most position.

\*4: Use only a front-facing child restraint system.

\*3: If the head restraint interferes with your child restraint system, and the head restraint can be removed, remove the head restraint.

### ■ Detail information for child restraint systems installation

Seating position				
Seat position number	①	②	③	④
Seating position suitable for universal belted (Yes/No)	Yes Forward-facing only	Yes	Yes	Yes
i-Size seating position (Yes/No)	No	Yes	No	Yes
Seating position suitable for lateral fixture (L1/L2/No)	No	No	No	No
Suitable rearward facing fixture (R1/R2X/R2/R3/No)	No	R1, R2X, R2, R3	No	R1, R2X, R2, R3
Suitable forward facing fixture (F2X/F2/F3/No)	No	F2X, F2, F3	No	F2X, F2, F3
Suitable junior seat fixture (B2/B3/No)	No	B2, B3	No	B2, B3

ISOFIX child restraint systems are divided into different “fixture”. The child restraint system can be used in the seating positions for “fixture” mentioned in the table above. For kind of “fixture” relation, confirm the following table.

If your child restraint system has no kind of “fixture” (or if you cannot find information in the table below), please refer to the child restraint system “vehicle list” for compatibility information or ask the retailer of your child seat.

Fixture	Description
F3	Full-height, forward-facing child restraint systems
F2	Reduced-height forward-facing child restraint systems
F2X	Reduced-height forward-facing child restraint systems
R3	Full-size, rearward-facing child restraint systems
R2	Reduced-size, rearward-facing child restraint systems
R2X	Reduced-size, rearward-facing child restraint systems
R1	Rearward-facing infant seat
L1	Left lateral-facing (carrycot) infant seat
L2	Right lateral-facing (carrycot) infant seat
B2	Junior seat
B3	Junior seat

### ■ Recommended child restraint systems and Compatibility table

	Recommended Child Restraint System	Seating position			
		①	②	③	④
i-Size child Restraint system	i-Size MIDI (Yes/No)	No	Yes	No	Yes

The child restraint systems mentioned in the table may not be available outside the LATIN America and the Caribbean countries.

When securing some types of child restraint systems in rear seat, it may not be possible to properly use the seat belts in positions next to the child restraint without interfering with it or affecting seat belt effectiveness. Be sure your seat belt fits snugly across your shoulder and low on your hips. If it does not, or if it interferes with the child restraint, move to a different position. Failure to do so may result in death or serious injury.

- When installing a child restraint in the rear seats, adjust the front seat so that it does not interfere with the child or child restraint system.
- When installing a child seat with support base, if the child seat interferes with the seatback when latching it into the support base, adjust the seatback rearward until there is no interference.
- If the seat belt shoulder anchor is ahead of the child seat belt guide, move the seat cushion forward.

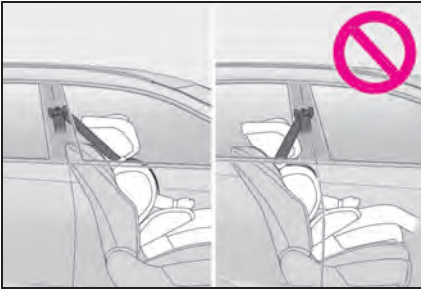

- When installing a junior seat, if the child in your child restraint system is in a very upright position, adjust the seatback angle to the most comfortable position. And if the seat belt shoulder anchor is ahead of the child seat belt guide, move the seat cushion forward.

## Child restraint system

### ■ Types of child restraint system installation methods

Confirm with the operation manual enclosed with the child restraint system about the installation of the child restraint system.

	Installation method	Page
Seat belt attachment		P.54

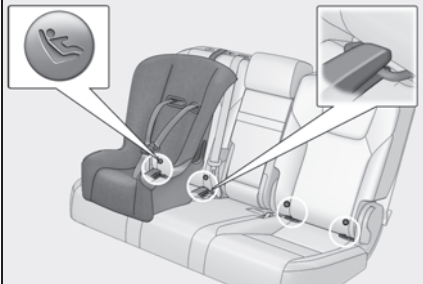
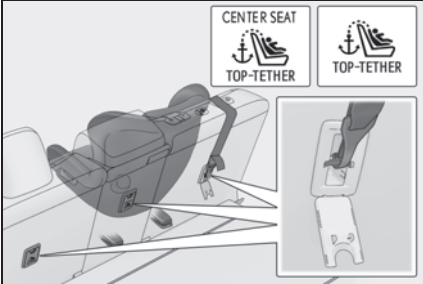
	Installation method	Page
<p>Except for Puerto Rico: Child restraint LATCH anchors attachment</p> <p>For Puerto Rico: ISOFIX lower anchorage attachment</p>		P.60
<p>Except for Puerto Rico: Anchor brackets (for top tether strap) attachment</p> <p>For Puerto Rico: Top tether anchorage attachment</p>		P.65

### When using a child restraint system

#### ■ When installing a child restraint system to a front passenger seat

For the safety of a child, install child restraint systems to a rear seats. When installing child restraint system to a front passenger seat is unavoidable, adjust the seat as follows and install the child restraint system.

- Move the seat fully rearward.
- Move the seat height to the upper most position.
- Adjust the seatback angle to the most upright position.

If there is a gap between the child seat and the seatback, adjust the seatback angle until good contact is achieved.

- If the head restraint interferes with your child restraint system, and the head restraint can be removed, remove the head restraint.

Otherwise, put the head restraint in the upper most position.



### ⚠ WARNING

#### ■ When using a child restraint system

Observe the following precautions. Failure to do so may result in death or serious injury.

## ⚠ WARNING

- Never install a rear-facing child restraint system on the front passenger seat even if the "AIR BAG OFF" indicator light is illuminated. In the event of an accident, the force of the rapid inflation of the front passenger airbag can cause death or serious injury to the child if the rear-facing child restraint system is installed on the front passenger seat.
- A forward-facing child restraint system may be installed on the front passenger seat only when it is unavoidable. A child restraint system that requires a top tether strap should not be used in the front passenger seat since there is no top tether strap anchor for the front passenger seat.
- A forward-facing child restraint system may be installed on the front passenger seat only when it is unavoidable. When installing a forward-facing child restraint system on the front passenger seat, raise the seatback as much as possible, move the seat to the rearmost position, and raise the seat to the highest position, even if the "AIR BAG OFF" indicator light is illuminated.

If the head restraint interferes with the installation of the child restraint system, and the head restraint can be removed, remove the head restraint.

If the head restraint cannot be removed, raise it to the uppermost position.



- Do not allow the child to lean his/her head or any part of his/her body against the door or the area of the seat, front or rear pillars, or roof side rails from which the SRS side airbags or SRS curtain shield airbags deploy even if the child is seated in the child restraint system. It is dangerous if the SRS side airbags and curtain shield airbags inflate, and the impact could cause death or serious injury to the child.

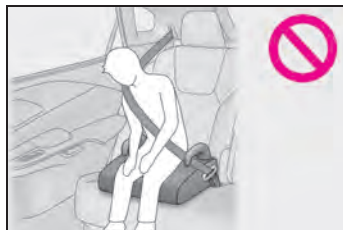

- When a booster seat is installed, always ensure that the shoulder belt is positioned across the center of the child's shoulder. The belt should be kept away from the child's neck, but not so that it could fall off the child's shoulder.
- Use child restraint system suitable to the age and size of the child and install it to the rear seat.
- If the driver's seat interferes with the child restraint system and prevents it from being attached correctly, attach the child restraint system to the right-hand rear seat.



- Adjust the front passenger seat so that it does not interfere with the child restraint system.

## Child restraint system fixed with a seat belt

A child restraint system for a small child or baby must itself be properly restrained on the seat with the lap portion of the lap/shoulder belt.

### ■ Installing child restraint system using a seat belt (child restraint lock function belt)

Install the child restraint system in accordance to the operation manual enclosed with the child restraint system.

For Puerto Rico: If the child restraint system on hand is not within the “universal” category (or the necessary information is not in the table), refer to the “Vehicle List” provided by the child restraint system maker for various possible installation positions, or check the compatibility after asking the retailer of the child seat. (→P.47)

### ■ Rear-facing — Infant seat/convertible seat

#### 1 Adjust the rear seat.

If there is a gap between the child seat and the seatback, adjust the seatback angle until good contact is achieved.

- 2 Place the child restraint system on the rear seat facing the rear of the vehicle.

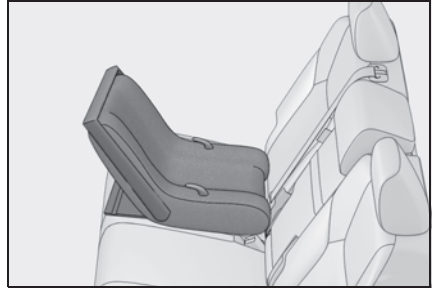

- 3 Run the seat belt through the child restraint system and insert the plate into the buckle. Make sure that the belt is not twisted.

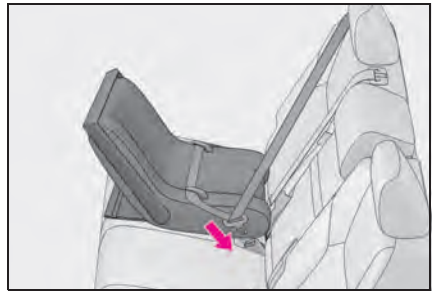

- 4 Fully extend the shoulder belt and allow it to retract to put it in lock mode. In lock mode, the belt cannot be extended.

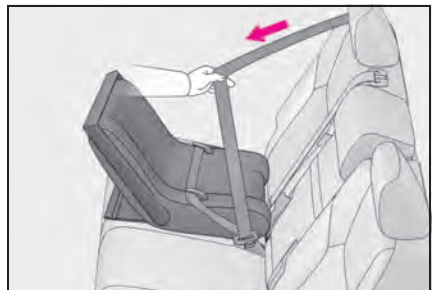

- 5 While pushing the child restraint system down into the rear seat, allow the shoulder belt to retract

until the child restraint system is securely in place.

After the shoulder belt has retracted to a point where there is no slack in the belt, pull the belt to check that it cannot be extended.

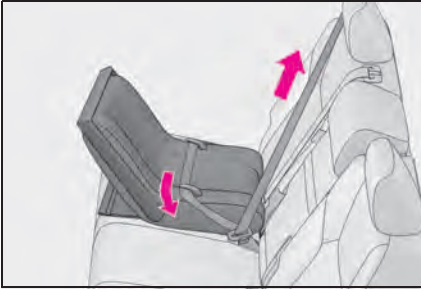

**6** After installing the child restraint system, rock it back and forth to ensure that it is installed securely. (→P.57)

### ■ Forward-facing—Convertible seat

**1** Adjust the seat.

▶ When using the front passenger seat

If installing the child restraint system to the front passenger seat is unavoidable, refer to P.52 for the front passenger seat adjustment.

▶ When using the rear seat

If there is a gap between the child seat and the seatback, adjust the seatback angle until good contact is achieved.

**2** Remove the head restraint if it interferes with your child restraint system. (→P.152)

If the head restraint cannot be removed,

raise it to the uppermost position.

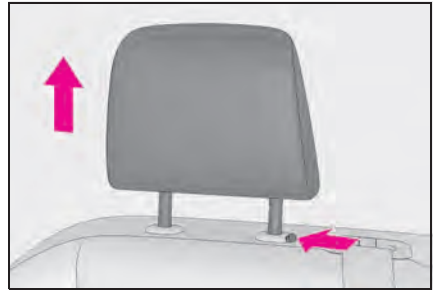

**3** Place the child restraint system on the seat facing the front of the vehicle.



**4** Run the seat belt through the child restraint system and insert the plate into the buckle. Make sure that the belt is not twisted.



**5** Fully extend the shoulder belt and allow it to retract to put it in lock

mode. In lock mode, the belt cannot be extended.

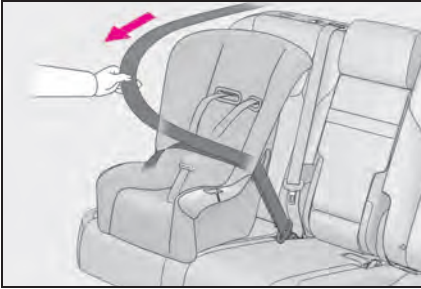

- 6 While pushing the child restraint system into the rear seat, allow the shoulder belt to retract until the child restraint system is securely in place.

After the shoulder belt has retracted to a point where there is no slack in the belt, pull the belt to check that it cannot be extended.

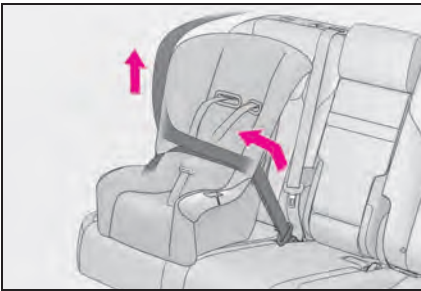

- 7 If the child restraint has a top tether strap, follow the child restraint manufacturer's operation manual regarding the installation, using the top tether strap to latch onto the top tether strap anchor. (→P.65)
- 8 After installing the child restraint system, rock it back and forth to ensure that it is installed securely. (→P.57)

## ■ Booster seat

- 1 If installing the child restraint system to the front passenger seat is unavoidable, refer to P.52 for the front passenger seat adjustment.
- 2 High back type: Remove the head restraint if it interferes with your child restraint system. (→P.152)

If the head restraint cannot be removed, raise it to the uppermost position.

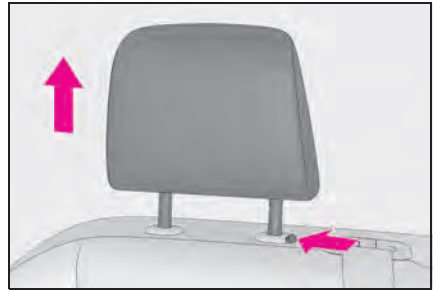

- 3 Place the child restraint system on the seat facing the front of the vehicle.

### ▶ Booster type

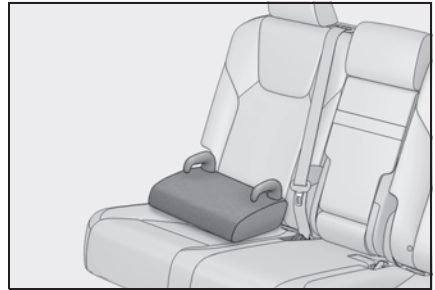

▶ High back type



- 4 Sit the child in the child restraint system. Fit the seat belt to the child restraint system according to the manufacturer's instructions and insert the plate into the buckle. Make sure that the belt is not twisted.

Check that the shoulder belt is correctly positioned over the child's shoulder and that the lap belt is as low as possible. (→P.28)



■ **Removing a child restraint system installed with a seat belt**

Press the buckle release button and fully retract the seat belt.

When releasing the buckle, the child restraint system may spring up due to the rebound of the seat cushion. Release the buckle while holding down the child restraint system.

Since the seat belt automatically reels itself, slowly return it to the stowing position.

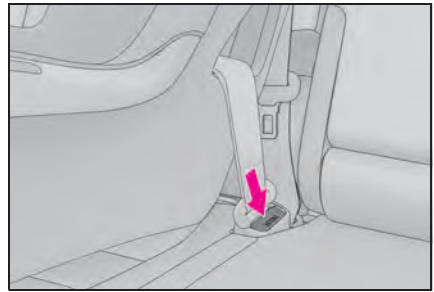

**⚠ WARNING**

■ **When installing a child restraint system**

Observe the following precautions. Failure to do so may result in death or serious injury.

- Do not allow children to play with the seat belt. If the seat belt becomes twisted around a child's neck, it may lead to choking or other serious injuries that could result in death. If this occurs and the buckle cannot be unfastened, scissors should be used to cut the belt.
- Ensure that the belt and plate are securely locked and the seat belt is not twisted.
- Shake the child restraint system left and right, and forward and backward to ensure that it has been securely installed.
- When a booster seat is installed, always ensure that the shoulder belt is positioned across the center of the child's shoulder. The belt should be kept away from the child's neck, but not so that it could fall off the child's shoulder.
- Follow all installation instructions provided by the child restraint system manufacturer.

## WARNING

- When securing some types of child restraint systems in rear seats, it may not be possible to properly use the seat belts in positions next to the child restraint without interfering with it or affecting seat belt effectiveness. Be sure your seat belt fits snugly across your shoulder and low on your hips. If it does not, or if it interferes with the child restraint, move to a different position. Failure to do so may result in death or serious injury.
- When installing a child restraint system in the rear center seat, adjust both seat cushions to the same position and align both seatbacks at the same angle. The seatbacks must be adjusted to the same angle. Otherwise, the child restraint system cannot be securely restrained and this may cause death or serious injuries in the event of sudden braking, sudden swerving or an accident.
- If the seat is adjusted, reconfirm the security of the child restraint system.

### ■ When installing a booster seat

To prevent the belt from going into ALR lock mode, do not fully extend the shoulder belt. ALR mode causes the belt to tighten only. This could cause injury or discomfort to the child. (→P.30)

### ■ Do not use a seat belt extender

If a seat belt extender is used when installing a child restraint system, the seat belt will not securely hold the child restraint system, which could cause death or serious injury to the child or other passengers in the event of sudden braking, sudden swerving or an accident.

## Child restraint system fixed with a child restraint LATCH anchor (except for Puerto Rico)

### ■ Child restraint LATCH anchors

LATCH anchors are provided for the outboard rear seats. (Buttons displaying the location of the anchors are attached to the seats.)

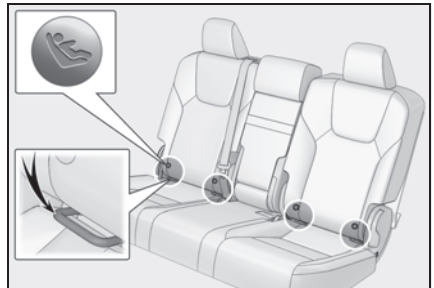

### ■ When installing in the rear outboard seats

Install the child restraint system in accordance to the operation manual enclosed with the child restraint system.

#### 1 Adjust the seat.

If there is a gap between the child seat and the seatback, adjust the seatback angle until good contact is achieved.

#### 2 Remove the head restraint if it interferes with your child restraint system. (→P.152)

If the head restraint cannot be removed,

raise it to the uppermost position.

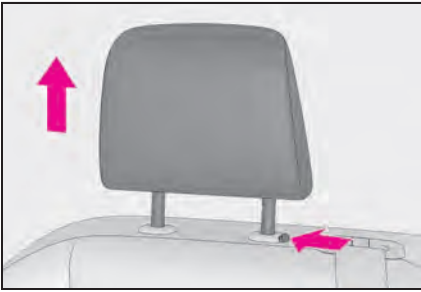

**3** Widen the gap between the seat cushion and seatback slightly.

▶ With flexible lower attachments

**4** Latch the hooks of the lower attachments onto the LATCH anchors.

For owners in Canada:

The symbol on a child restraint system indicates **A** the presence of a lower connector system.

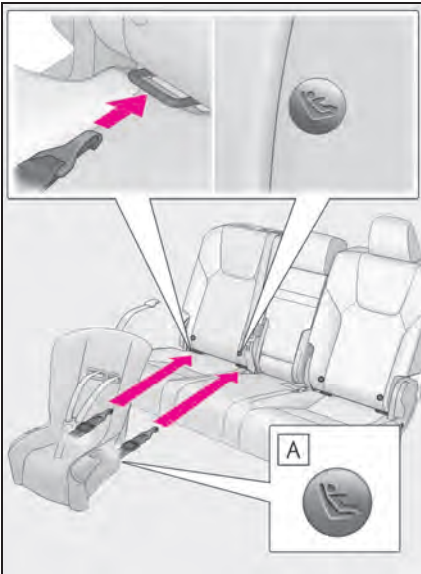

**A** Canada only

▶ With rigid lower attachments

**4** Latch the buckles onto the LATCH anchors.

For owners in Canada:

The symbol on a child restraint system indicates **A** the presence of a lower connector system.

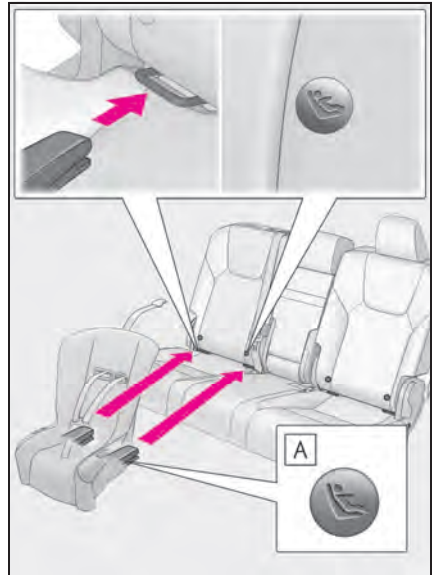

**A** Canada only

**5** If the child restraint has a top tether strap, follow the child restraint manufacturer's operation manual regarding the installation, using the top tether strap to latch onto the top tether strap anchor. (→P.65)

**6** After installing the child restraint system, rock it back and forth to ensure that it is installed securely. (→P.57)

■ **When installing in the rear center seat**

There are no LATCH anchors behind the rear center seat. However, the

inboard LATCH anchors of the outboard seats, which are 18.5 in. (470 mm) apart, can be used if the child restraint system manufacturer's instructions permit use of those anchors with the anchor spacing stated.

Child restraint systems with rigid lower attachments cannot be installed in the center seat. This type of child restraint system can only be installed in the outboard seat.

#### ■ Laws and regulations pertaining to anchors

The LATCH system conforms to FMVSS225 or CMVSS210.2. Child restraint systems conforming to FMVSS213 or CMVSS213 specifications can be used.

This vehicle is designed to conform to SAE J1819.



#### WARNING

##### ■ When installing a child restraint system

Observe the following precautions. Failure to do so may result in death or serious injury.

- When using the LATCH anchors, be sure that there are no foreign objects around the anchors and that the seat belt is not caught behind the child restraint system.
- Follow all installation instructions provided by the child restraint system manufacturer.

- Never attach two child restraint system attachments to the same anchor. In a collision, one anchor may not be strong enough to hold two child restraint system attachments and may break.

If the LATCH anchors are already in use, use the seat belt to install a child restraint system in the center seat.

- When securing some types of child restraint systems in rear seats, it may not be possible to properly use the seat belts in positions next to the child restraint without interfering with it or affecting seat belt effectiveness. Be sure your seat belt fits snugly across your shoulder and low on your hips. If it does not, or if it interferes with the child restraint, move to a different position. Failure to do so may result in death or serious injury.
- If the seat is adjusted, reconfirm the security of the child restraint system.

### Child restraint system fixed with an ISOFIX lower anchorage (for Puerto Rico)

#### ■ ISOFIX lower anchorages (ISOFIX child restraint system)

Lower anchorages are provided for the outboard rear seats. (Buttons displaying the location of the anchorages are attached to the seats.)

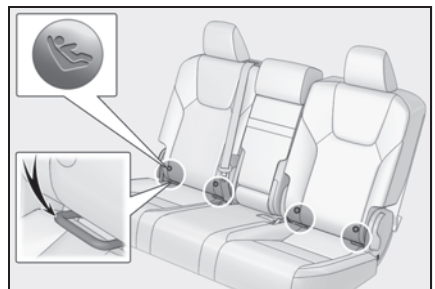

### ■ When installing in the rear out-board seats

If the child restraint system on hand is not within the “universal” category (or the necessary information is not in the table), refer to the “Vehicle List” provided by the child restraint system maker for various possible installation positions, or check the compatibility after asking the retailer of the child restraint system. (→P.47)

#### 1 Adjust the seat.

If there is a gap between the child seat and the seatback, adjust the seatback angle until good contact is achieved.

#### 2 Remove the head restraint if it interferes with your child restraint system. (→P.152)

If the head restraint cannot be removed, raise it to the uppermost position.

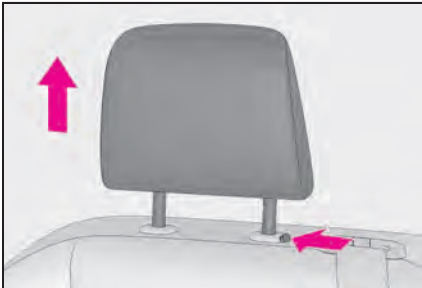

#### 3 Widen the gap between the seat cushion and seatback slightly.

▶ With flexible lower attachments

#### 4 Latch the hooks of the lower attachments onto the lower anchorages.

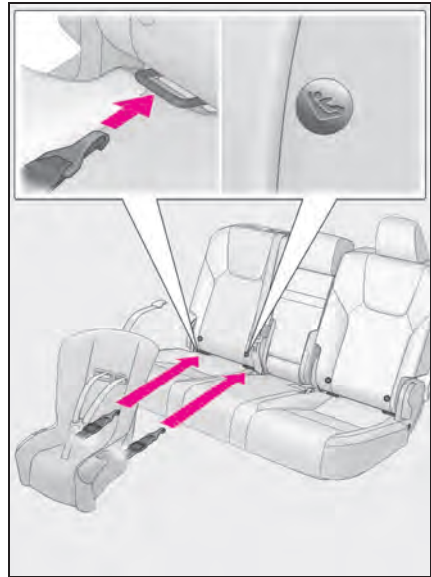

- ▶ With rigid lower attachments
- 4 Latch the buckles onto the lower anchorages.



- 5 If the child restraint has a top tether strap, follow the child restraint manufacturer's operation manual regarding the installation, using the top tether strap to latch onto the top tether strap anchor. (→P.65)
- 6 After installing the child restraint system, rock it back and forth to ensure that it is installed securely. (→P.57)

#### ■ When installing in the rear center seat

There are no lower anchorages behind the rear center seat. However, the inboard lower anchorages of the outboard seats, which are 18.5 in. (470 mm) apart, can be used if the child restraint system manufacturer's instructions permit use of those

anchors with the anchor spacing stated.

Child restraint systems with rigid lower attachments cannot be installed in the center seat. This type of child restraint system can only be installed in the outboard seat.

#### ■ When using an "i-Size MIDI" (for Puerto Rico)

Adjust the support leg and ISOFIX connectors as follows:

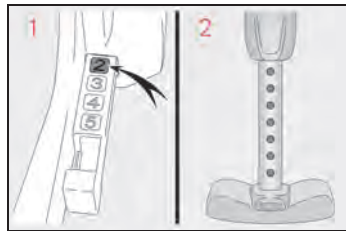

- 1 Lock the ISOFIX connectors where number 2 can be seen.
- 2 Lock the support leg where 7 holes can be seen.

#### ⚠ WARNING

##### ■ When installing a child restraint system

Observe the following precautions. Failure to do so may result in death or serious injury.

- When using the lower anchorages, be sure that there are no foreign objects around the anchors and that the seat belt is not caught behind the child restraint system.
- Follow all installation instructions provided by the child restraint system manufacturer.

**⚠ WARNING**

- Never attach two child restraint system attachments to the same anchor. In a collision, one anchor may not be strong enough to hold two child restraint system attachments and may break. If the lower anchorages are already in use, use the seat belt to install a child restraint system in the center seat.
- When securing some types of child restraint systems in rear seats, it may not be possible to properly use the seat belts in positions next to the child restraint without interfering with it or affecting seat belt effectiveness. Be sure your seat belt fits snugly across your shoulder and low on your hips. If it does not, or if it interferes with the child restraint, move to a different position. Failure to do so may result in death or serious injury.
- If the seat is adjusted, reconfirm the security of the child restraint system.

**Using an anchor bracket (for top tether strap) (except for Puerto Rico)****■ Anchor brackets (for top tether strap)**

Anchor brackets are provided for each rear seat.

Use anchor brackets when fixing the top tether strap.

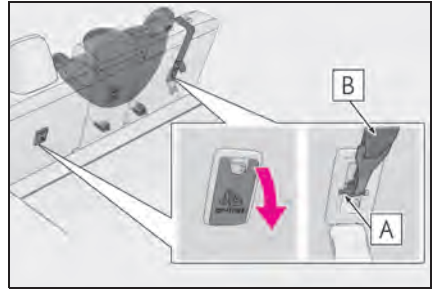
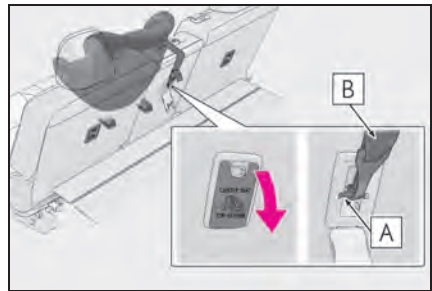
**▶ Outboard rear seats****A** Anchor brackets**B** Top tether strap**▶ Rear center seat****A** Anchor bracket**B** Top tether strap**■ Fixing the top tether strap to the anchor bracket**

Install the child restraint system in accordance to the operation manual enclosed with the child restraint system.

- 1 Remove the head restraint if it interferes with your child restraint system. (→P.152)

If the head restraint cannot be removed,

raise it to the uppermost position.

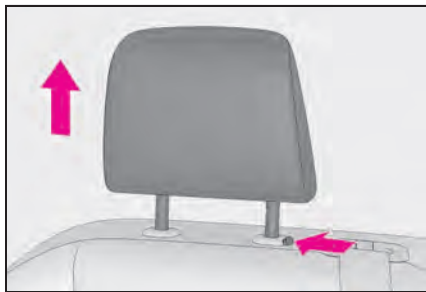

- 2** Open the anchor bracket cover, latch the hook onto the anchor bracket and tighten the top tether strap.

Make sure the top tether strap is securely latched. (→P.57)

When installing the child restraint system with the head restraint being raised, be sure to have the top tether strap pass underneath the head restraint.

► Outboard rear seats

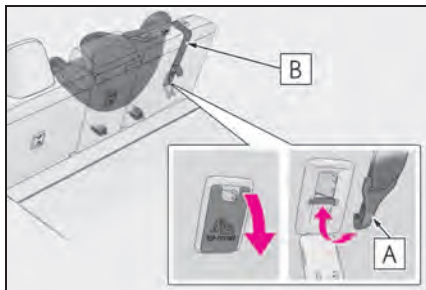

- A** Hook  
**B** Top tether strap

► Rear center seat

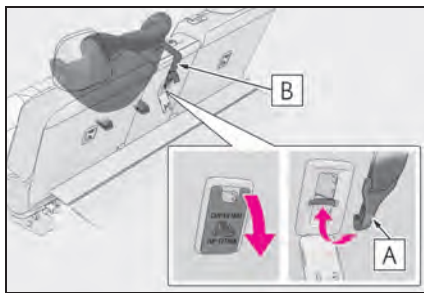

- A** Hook  
**B** Top tether strap

■ **Laws and regulations pertaining to anchors**

The LATCH system conforms to FMVSS225 or CMVSS210.2. Child restraint systems conforming to FMVSS213 or CMVSS213 specifications can be used.

This vehicle is designed to conform to SAE J1819.

**⚠ WARNING**

■ **When installing a child restraint system**

Observe the following precautions. Failure to do so may result in death or serious injury.

- Firmly attach the top tether strap and make sure that the belt is not twisted.
- Do not attach the top strap to anything other than the anchor bracket.
- Follow all installation instructions provided by the child restraint system manufacturer.
- When installing the child restraint system with the head restraint being raised, after the head restraint has been raised and then the anchor bracket has been fixed, do not lower the head restraint.

**⚠ WARNING**

- When installing a child restraint system in the rear center seat, adjust both seat cushions to the same position and align both seatbacks at the same angle. The seatbacks must be adjusted to the same angle. Otherwise, the child restraint system cannot be securely restrained and this may cause death or serious injuries in the event of sudden braking, sudden swerving or an accident.
- If the seat is adjusted, reconfirm the security of the child restraint system.

**⚠ NOTICE****■ Anchor brackets (for top tether strap)**

When not in use, make certain to close the lid. If it remains open, the lid may be damaged.

**Using a top tether anchorage (for Puerto Rico)****■ Top tether anchorages**

Top tether anchorages are provided for each rear seat.

Use top tether anchorages when fixing the top strap.

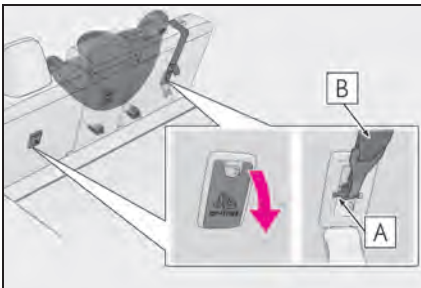
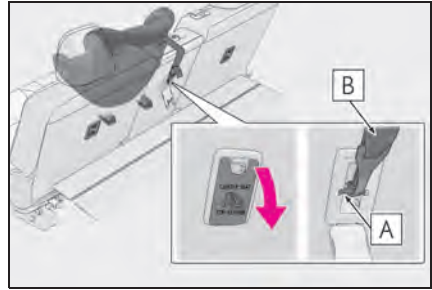
**▶ Outboard rear seats****A** Top tether anchorages**B** Top tether strap**▶ Rear center seat****A** Top tether anchorages**B** Top tether strap**■ Fixing the top strap to the top tether anchorage**

Install the child restraint system in accordance to the operation manual enclosed with the child restraint system.

- 1 Remove the head restraint if it interferes with your child restraint system. (→P.152)

If the head restraint cannot be removed, raise it to the uppermost position.

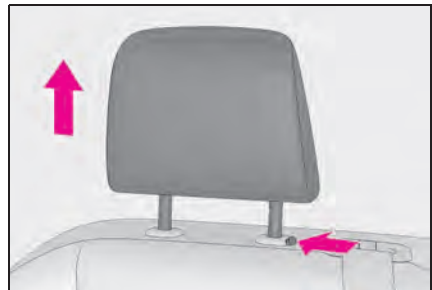

- 2 Open the top tether anchorage cover, latch the hook onto the top tether anchorage and tighten the top strap.

Make sure the top strap is securely latched. (→P.57)

When installing the child restraint system with the head restraint being raised, be sure to have the top strap pass underneath the head restraint.

► Outboard rear seats

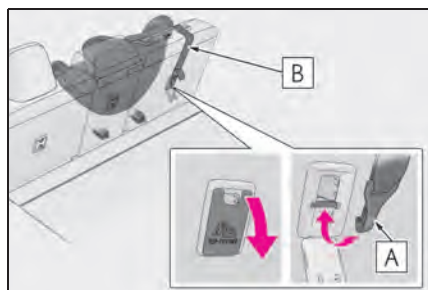

**A** Hook

**B** Top strap

► Rear center seat

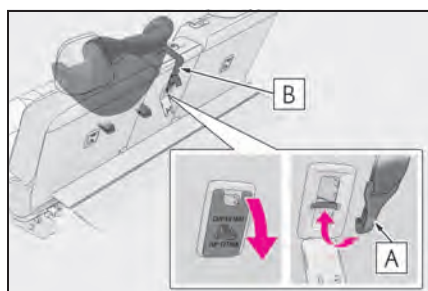

**A** Hook

**B** Top strap

**⚠ WARNING**

■ **When installing a child restraint system**

Observe the following precautions. Failure to do so may result in death or serious injury.

- Firmly attach the top strap and make sure that the belt is not twisted.
- Do not attach the top strap to anything other than the top tether anchorage.

- Follow all installation instructions provided by the child restraint system manufacturer.
- When installing the child restraint system with the head restraint being raised, after the head restraint has been raised and then the top tether anchorage has been fixed, do not lower the head restraint.
- When installing a child restraint system in the rear center seat, adjust both seat cushions to the same position and align both seatbacks at the same angle. The seatbacks must be adjusted to the same angle. Otherwise, the child restraint system cannot be securely restrained and this may cause death or serious injuries in the event of sudden braking, sudden swerving or an accident.
- If the seat is adjusted, reconfirm the security of the child restraint system.

**⚠ NOTICE**

■ **Top tether anchorages**

When not in use, make certain to close the lid. If it remains open, the lid may be damaged.

## Safety Connect

Safety Connect is a subscription-based telematics service that uses Global Positioning System (GPS) data and embedded cellular technology to provide safety and security features to subscribers. Safety Connect is supported by Lexus' designated response center, which operates 24 hours per day, 7 days per week.

Safety Connect service is available by subscription on select, telematics hardware-equipped vehicles.

By using the Safety Connect service, you are agreeing to be bound by the Telematics Subscription Service Agreement and its Terms and Conditions, as in effect and amended from time to time, a current copy of which is available at [Lexus.com](http://Lexus.com). All use of the Safety Connect service is subject to such then-applicable Terms and Conditions.

### System components

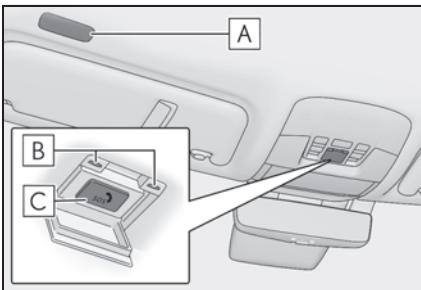

- A** Microphone
- B** LED light indicators
- C** "SOS" button

### Services

Subscribers have the following Safety Connect services available:

- Automatic Collision Notification<sup>\*</sup>  
Helps drivers receive necessary response from emergency service providers. (→P.68)

<sup>\*</sup>: U.S. Patent No. 7,508,298 B2

- Stolen Vehicle Location  
Helps drivers in the event of vehicle theft. (→P.68)

- Emergency Assistance Button ("SOS")  
Connects drivers to response-center support. (→P.68)

- Enhanced Roadside Assistance  
Provides drivers various on-road assistance. (→P.68)

### Subscription

After you have signed the Telematics Subscription Service Agreement and are enrolled, you can begin receiving services.

A variety of subscription terms is available for purchase. Contact your Lexus dealer, call the following or push the "SOS" button in your vehicle for further subscription details.

- The United States  
1-800-25-LEXUS (1-800-255-3987)

- Canada

1-800-26-LEXUS (1-800-265-3987)

- Puerto Rico

1-877-539-8777

### ■ Safety Connect Services Information

- Phone calls using the vehicles Bluetooth<sup>®</sup> technology will not be possible during Safety Connect.
- Safety Connect is available beginning Fall 2009 on select Lexus models (in the contiguous United States only). Contact with the Safety Connect response center is dependent upon the telematics device being in operative condition, cellular connection availability, and GPS satellite signal reception, which can limit the ability to reach the response center or receive emergency service support. Enrollment and Telematics Subscription Service Agreement required. A variety of subscription terms is available; charges vary by subscription term selected and location.
- Automatic Collision Notification, Emergency Assistance and Stolen Vehicle Location will function in the United States, including Hawaii and Alaska, Puerto Rico and in Canada, and Enhanced Roadside Assistance will function in the United States, Puerto Rico and in Canada.
- Automatic Collision Notification, Emergency Assistance, Stolen Vehicle and Enhanced Road Assistance will not function in the United States Virgin Islands. For vehicles first sold in the USVI, no Safety Connect services will function in and outside the United States Virgin Islands.
- Safety Connect services are not subject to section 255 of the Telecommunications Act and the device is not TTY compatible.

### ■ Languages

The Safety Connect response center will offer support in multiple languages. The Safety Connect system will offer voice

prompts in English, Spanish, and French. Please indicate your language of choice when enrolling.

### ■ When contacting the response center

You may be unable to contact the response center if the network is busy.

### ■ Free/Open Source Software Information

This product contains Free/Open Source Software (FOSS). The license information and/or the source code of such FOSS can be found at the following URL.

<https://opensource.lge.com/osSch/list?types=ALL&search=TL21BNU>

## Safety Connect LED light Indicators

When the power switch is turned to ON, the red indicator light comes on for 2 seconds then turns off. Afterward, the green indicator light comes on, indicating that the service is active.

The following indicator light patterns indicate specific system usage conditions:

- Green indicator light on = Active service
- Green indicator light flashing = Safety Connect call in process
- Red indicator light (except at vehicle start-up) = System malfunction (contact your Lexus dealer)
- No indicator light (off) = Safety Connect service not active

## Safety Connect services

### ■ Automatic Collision Notification

In case of either airbag deployment or

severe rear-end collision, the system is designed to automatically call the response center. The responding agent receives the vehicle's location and attempts to speak with the vehicle occupants to assess the level of emergency. If the occupants are unable to communicate, the agent automatically treats the call as an emergency, contacts the nearest emergency services provider to describe the situation, and requests that assistance be sent to the location.

### ■ Stolen Vehicle Location

If your vehicle is stolen, Safety Connect can work with local authorities to assist them in locating and recovering the vehicle. After filing a police report, call the Safety Connect response center at 1-800-25-LEXUS

(1-800-255-3987) in the United States, 1-877-539-8777 in Puerto Rico or 1-800-265-3987 in Canada, and follow the prompts for Safety Connect to initiate this service.

In addition to assisting law enforcement with recovery of a stolen vehicle, Safety-Connect-equipped vehicle location data may, under certain circumstances, be shared with third parties to locate your vehicle. Further information is available at [Lexus.com](http://Lexus.com).

### ■ Emergency Assistance Button ("SOS")

In the event of an emergency on the road, push the "SOS" button to reach the Safety Connect response center. The answering agent will determine your vehicle's location, assess the

emergency, and dispatch the necessary assistance required.

If you accidentally press the "SOS" button, tell the response-center agent that you are not experiencing an emergency.

### ■ Enhanced Roadside Assistance

Enhanced Roadside Assistance adds GPS data to the already included warranty-based Lexus roadside service.

Subscribers can press the "SOS" button to reach a Safety Connect response-center agent, who can help with a wide range of needs, such as: towing, flat tire, fuel delivery, etc. For a description of the Roadside Assistance services and their limitations, please see the Safety Connect Terms and Conditions, which are available at [Lexus.com](http://Lexus.com).

### Safety information for Safety Connect

Important! Read this information about exposure to radio frequency signals before using Safety Connect;

The Safety Connect system installed in your vehicle is a low-power radio transmitter and receiver. It receives and also sends out radio frequency (RF) signals.

In August 1996, the Federal Communications Commission (FCC) adopted RF exposure guidelines with safety levels for mobile wireless phones. Those guidelines are consistent with the safety standards previously set by the following U.S. and international standards bodies.

- ANSI (American National Standards Institute) C95.1 [1992]
- NCRP (National Council on Radiation Protection and Measurement) Report 86 [1986]
- ICNIRP (International Commission on Non-Ionizing Radiation Protection) [1996]

Those standards were based on comprehensive and periodic evaluations of the relevant scientific literature. Over 120 scientists, engineers, and physicians from universities, and government health agencies and industries reviewed the available body of research to develop the ANSI Standard (C95.1).

The design of Safety Connect complies with the FCC guidelines in addition to those standards.

## Remote Connect\*

\*: If equipped

**Remote Connect is a smartphone application that lets you view and remotely control certain aspects of your vehicle. For details about the functions and services of this application, refer to**

**<http://www.lexus.com/enform/>.**

**Function of the Remote Connect is achieved by using an embedded cellular device in the vehicle (DCM: Data Communication Module).**

## Remote Connect subscription

After you sign the Telematics Subscription Service Agreement, download the Lexus App from your smartphone's app store, and register within the app (or enroll and complete registration at the dealer), you can begin using these services.

A variety of subscription terms are available. Contact your Lexus dealer, or call 1-800-25-LEXUS (1-800-255-3987) for further subscription details.

### ■ Availability of service

Remote Connect is not available in some countries or areas.

### ■ Remote Connect Information

- Remote Connect should only be used by authorized users.
- Laws in some communities may require that the vehicle be within view of the user when operating Remote Connect. In

some states, use of Remote Connect may violate state or local laws. Before using Remote Connect, check your state and local laws.

- Any malfunction of the Lexus should be repaired by your Lexus dealer.
- Remote Connect is designed to work at temperatures above -22°F (-30°C). This specification is related to the Remote Connect operation, but is dependent on the vehicle's operating temperature range which may be different.
- Content is subject to change without notice.
- Some features of the Remote Connect may not be available on some models.
- Additional information can be found at <https://www.lexus.com/enform/>.
- Availability of functions of the Remote Connect service is dependent on network reception level.

#### ■ Safety information for Remote Connect

Refer to the safety information for Safety Connect: →P.67

## Service Connect\*

\*: If equipped

**Service Connect uses embedded telematics hardware to collect and transmit vehicle data that allows Lexus to provide:**

- Vehicle Health Report (VHR) (Safety Recalls, Service Campaigns, Current Vehicle Alerts, Required Maintenance, and Vehicle Condition Status)
- Maintenance Notifications
- Vehicle Alert Notifications

For details about this service and how to register, refer to <https://www.lexus.com/enform/>. The Service Connect is achieved by using a Data Communication Module (DCM) built in the vehicle.

#### ■ Availability of service

Service Connect is not available in some countries or areas.

#### ■ Service Connect Information

Availability of functions of the Service Connect is dependent on network reception level.

#### ■ Safety information for Service Connect

Refer to the safety information for Safety Connect: →P.67

## Hybrid system features

Your vehicle is a hybrid electric vehicle. It has characteristics different from conventional vehicles. Be sure you are closely familiar with the characteristics of your vehicle, and operate it with care.

The hybrid system combines the use of a gasoline engine and an electric motor (traction motor) according to driving conditions, improving fuel efficiency and reducing exhaust emissions.

## System components

### ▶ RX350h

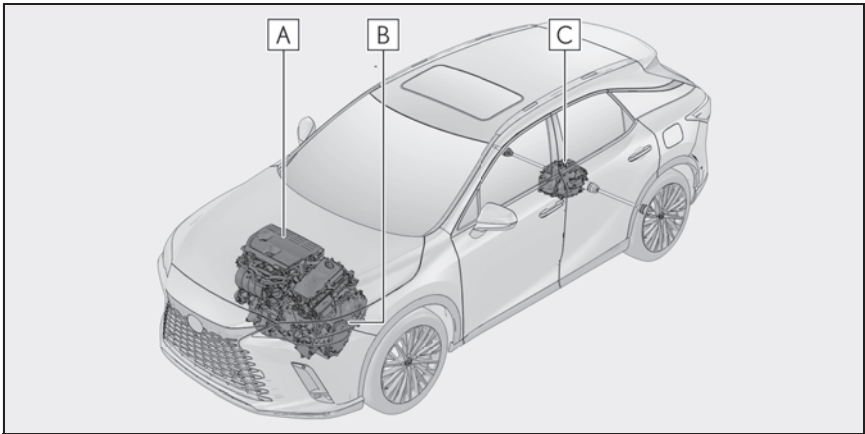

The illustration is an example for explanation and may differ from the actual item.

- A** Gasoline engine
- B** Front electric motor (traction motor)
- C** Rear electric motor (traction motor)

## ▶ RX500h

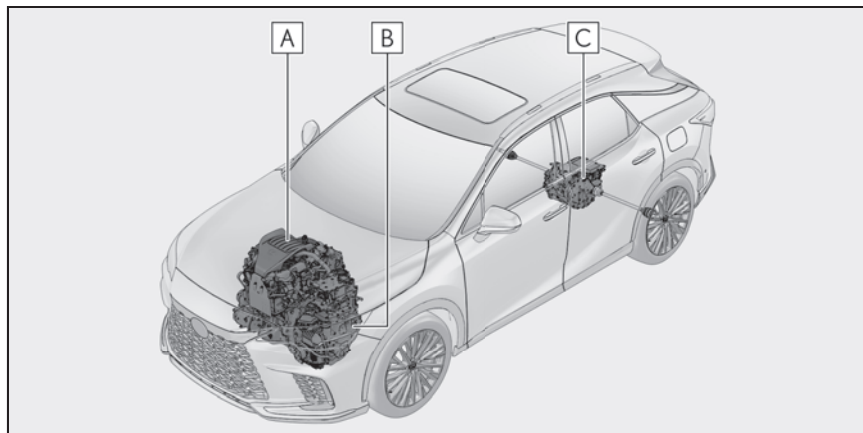

The illustration is an example for explanation and may differ from the actual item.

- A** Gasoline engine
- B** Front electric motor (traction motor)
- C** Rear electric motor (traction motor)

#### ■ When stopped/during start off

The gasoline engine stops\* when the vehicle is stopped. During start off, the electric motor (traction motor) drives the vehicle. At slow speeds or when traveling down a gentle slope, the engine is stopped\* and the electric motor (traction motor) is used.

RX350h: When the shift position is in N, the hybrid battery (traction battery) is not being charged.

\*: When the hybrid battery (traction battery) requires charging or the engine is warming up, etc., the gasoline engine will not automatically stop. (→P.74)

#### ■ During normal driving

The gasoline engine is predominantly used. The electric motor (traction motor) charges the hybrid battery

(traction battery) as necessary.

Depending on the driving conditions, the rear electric motor (traction motor) is powered by the front electric motor (traction motor) to drive the rear wheels.

#### ■ When accelerating sharply

When the accelerator pedal is depressed heavily, the power of the hybrid battery (traction battery) is added to that of the gasoline engine via the electric motor (traction motor).

#### ■ When braking (regenerative braking)

The wheels operate the electric motor (traction motor) as a power generator, and the hybrid battery (traction battery) is charged.

### ■ Regenerative braking

In the following situations, kinetic energy is converted to electric energy and deceleration force can be obtained in conjunction with the recharging of the hybrid battery (traction battery).

- RX350h: The accelerator pedal is released while driving with the shift position in D or S.
- RX500h: The accelerator pedal is released while driving with the shift position in D or M.
- RX350h: The brake pedal is depressed while driving with the shift position in D or S.
- RX500h: The brake pedal is depressed while driving with the shift position in D or M.

### ■ EV indicator

The EV indicator comes on when the vehicle is driven using only the electric motor (traction motor) or the gasoline engine is stopped.

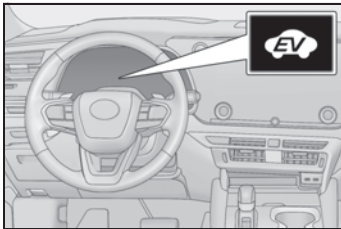

### ■ Conditions in which the gasoline engine may not stop

The gasoline engine starts and stops automatically. However, it may not stop automatically in the following conditions:

- During gasoline engine warm-up
- During hybrid battery (traction battery) charging
- When the temperature of the hybrid battery (traction battery) is high or low
- When the heater is switched on
- When the hood is opened during "READY" indicator is illuminated

Depending on the circumstances, the gasoline engine may also not stop automatically

in other situations.

### ■ Charging the hybrid battery (traction battery)

As the gasoline engine charges the hybrid battery (traction battery), the battery does not need to be charged from an outside source. However, if the vehicle is left parked for a long time the hybrid battery (traction battery) will slowly discharge. For this reason, be sure to drive the vehicle at least once every few months for at least 30 minutes or 10 miles (16 km). If the hybrid battery (traction battery) becomes fully discharged and you are unable to start the hybrid system, contact your Lexus dealer.

### ■ Charging the 12-volt battery

→P.558

### ■ After the 12-volt battery has discharged or when the terminal has been removed and installed during exchange, etc.

The gasoline engine may not stop even if the vehicle is being driven by the hybrid battery (traction battery). If this continues for a few days, contact your Lexus dealer.

### ■ Sounds and vibrations specific to a hybrid electric vehicle

Because there is no engine sound or vibration, it is easy to mistake the hybrid electric vehicle for being off when it is actually still running, as indicated by the "READY" indicator being illuminated. For safety, make sure to always shift the shift position to P and apply the parking brake when parked.

The following sounds or vibrations may occur when the hybrid system is operating and are not a malfunction:

- Motor sounds may be heard from the engine compartment.
- Sounds may be heard from the hybrid battery (traction battery) behind the rear seats when the hybrid system starts or stops.
- Relay operating sounds such as a snap or soft clank will be emitted from the hybrid battery (traction battery), under the rear seats, when the hybrid system is started or stopped.
- Sounds from the hybrid system may be

heard when the back door is open.

- Sounds may be heard from the transmission when the gasoline engine starts or stops, when driving at low speeds, or during idling.
- Engine sounds may be heard when accelerating sharply.
- Sounds may be heard due to regenerative braking when the brake pedal is depressed or as the accelerator pedal is released.
- Vibration may be felt when the gasoline engine starts or stops.
- Cooling fan sounds may be heard from the air intake vents under the rear seats.

#### ■ Maintenance, repair, recycling, and disposal

Contact your Lexus dealer regarding maintenance, repair, recycling and disposal. Do not dispose of the vehicle yourself.

#### ■ Customization

Some functions can be customized. (→P.590)

### Acoustic Vehicle Alerting System

When driving with the gasoline engine stopped, a sound, which changes in accordance with the driving speed, will be played in order to warn people nearby of the vehicle's approach. This sound may be heard inside the vehicle. The sound will stop when the vehicle speed exceeds approximately 22 mph (35 km/h).

#### ■ Acoustic Vehicle Alerting System

In the following cases, the Acoustic Vehicle Alerting System may be difficult for surrounding people to hear.

- In very noisy areas
- In the wind or the rain

#### ■ When "Acoustic Vehicle Alerting System Malfunction Visit your Dealer" is displayed on the multi-information display

The Acoustic Vehicle Alerting System may be malfunctioning. Have the vehicle inspected by your Lexus dealer immediately.

### Predictive efficient drive (vehicles with navigation system)\* (RX350h)

\*: This function can only be used in the mainland U.S.A. It cannot be used in other states and territories, including Alaska and Hawaii.

This system operates based on the driving situation and traffic information to enhance fuel economy.

For details about Predictive efficient drive, refer to the "MULTIMEDIA OWNER'S MANUAL".

#### ■ Predictive deceleration support

- When the vehicle approaches to predictive deceleration support points registered in the navigation system, the engine braking force will be increased according to the driving conditions to more efficiently charge the hybrid battery (traction battery) after the accelerator pedal is released.

#### ■ Predictive SOC\* control

The following types of control are performed based on data such as road and traffic information during route guidance by the navigation system to help ensure that the vehicle efficiently uses electricity.

- When there is a long downhill slope along the route, the system reduces the hybrid battery (traction battery) level before reaching the slope to help ensure charging capacity for regenerative braking while traveling downhill.
- When traffic congestion is predicted along the route, the system helps ensure a certain battery level before reaching congested roads to reduce the frequency of starting the engine to charge the hybrid battery (traction battery) due to low battery levels.

\*: SOC means state of charge

## Hybrid system precautions

Take care when handling the hybrid system, as it is a high voltage system (about  $650\text{ V}^{*1}$  or  $393.6\text{ V}^{*2}$  at maximum) as well as contains parts that become extremely hot when the hybrid system is operating. Obey the warning labels attached to the vehicle.

\*1: RX350h

\*2: RX500h

## System components

### ▶ RX350h

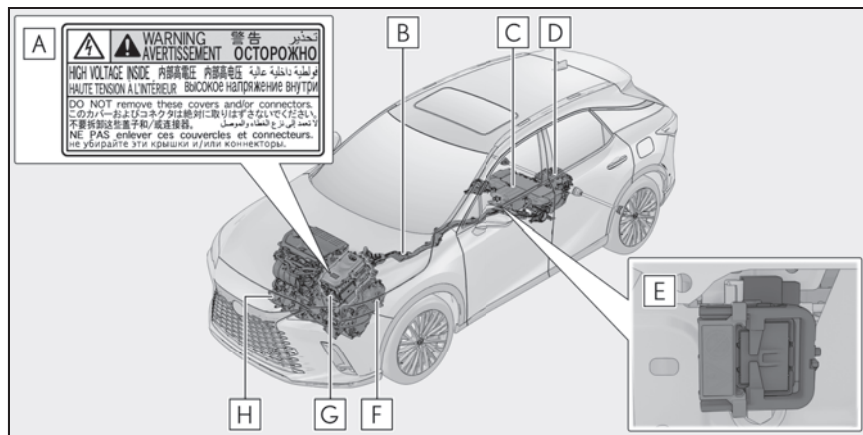

The illustration is an example for explanation and may differ from the actual item.

- A** Warning label
- B** High voltage cables (orange)
- C** Hybrid battery (traction battery)
- D** Rear electric motor (traction motor)
- E** Service plug
- F** Front electric motor (traction motor)
- G** Power control unit
- H** Air conditioning compressor

## ▶ RX500h

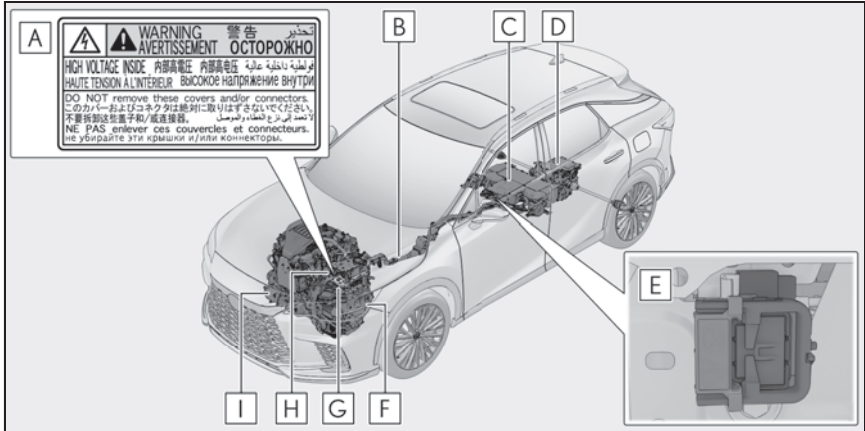

The illustration is an example for explanation and may differ from the actual item.

- A** Warning label
- B** High voltage cables (orange)
- C** Hybrid battery (traction battery)
- D** Rear electric motor (traction motor)/Inverter (rear)
- E** Service plug
- F** Front electric motor (traction motor)
- G** Inverter (front)
- H** DC/DC converter
- I** Air conditioning compressor

### ■ Running out of fuel

When the vehicle has run out of fuel and the hybrid system cannot be started, refuel the vehicle with at least enough gasoline to make the low fuel level warning light (→P.519) go off. If there is only a small amount of fuel, the hybrid system may not be able to start. (The standard amount of fuel is about 2.6 gal. [9.8 L, 2.2 Imp. gal.], when the vehicle is on a level surface. This value may vary when the vehicle is on a slope. Add extra fuel when the vehicle is inclined.)

### ■ Electromagnetic waves

- High voltage parts and cables on hybrid

electric vehicles incorporate electro-magnetic shielding, and therefore emit approximately the same amount of electromagnetic waves as conventional gasoline powered vehicles or home electronic appliances.

- Your vehicle may cause sound interference in some third party-produced radio parts.

### ■ Hybrid battery (traction battery)

The hybrid battery (traction battery) has a limited service life. The lifespan of the hybrid battery (traction battery) can change in accordance with driving style and driving conditions.

**WARNING**

### High voltage precautions

This vehicle has high voltage DC and AC systems as well as a 12-volt system. DC and AC high voltage is very dangerous and can cause severe burns and electric shock that may result in death or serious injury.

- Never touch, disassemble, remove or replace the high voltage parts, cables or their connectors.
- The hybrid system will become hot after starting as the system uses high voltage. Be careful of both the high voltage and the high temperature, and always obey the warning labels attached to the vehicle.
- Never try to open the service plug access hole located under the rear seat. The service plug is used only when the vehicle is serviced and is subject to high voltage.

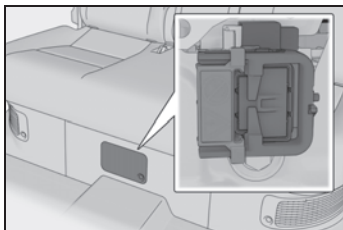

### Road accident cautions

Observe the following precautions to reduce the risk of death or serious injury:

- Stop the vehicle in a safe place to prevent subsequent accidents. While depressing the brake pedal, apply the parking brake and shift the shift position to P to stop the hybrid system. Then, slowly release the brake pedal.
- Do not touch the high voltage parts, cables and connectors.

- If electric wires are exposed inside or outside your vehicle, an electric shock may occur. Never touch exposed electric wires.
  - If a fluid leak occurs, do not touch the fluid as it may be strong alkaline electrolyte from the hybrid battery (traction battery). If it comes into contact with your skin or eyes, wash it off immediately with a large amount of water or, if possible, boric acid solution. Seek immediate medical attention.
  - If a fire occurs in the hybrid electric vehicle, leave the vehicle as soon as possible. Never use a fire extinguisher that is not meant for electric fires. Using even a small amount of water may be dangerous.
  - If your vehicle needs to be towed, do so with all four wheels raised. If the wheels connected to the electric motor (traction motor) are on the ground when towing, the motor may continue to generate electricity. This may cause a fire. (→P.513)
  - Carefully inspect the ground under the vehicle. If you find that liquid has leaked onto the ground, the fuel system may have been damaged. Leave the vehicle as soon as possible.
- ### Hybrid battery (traction battery)
- Never resell, hand over or modify the hybrid battery. To prevent accidents, hybrid batteries that have been removed from a disposed vehicle are collected through your Lexus dealer. Do not dispose of the battery yourself. Unless the battery is properly collected, the following may occur, resulting in death or serious injury:
    - The hybrid battery may be illegally disposed of or dumped, and it is hazardous to the environment or someone may touch a high voltage part, resulting in an electric shock.

**⚠ WARNING**

- The hybrid battery is intended to be used exclusively with your hybrid vehicle. If the hybrid battery is used outside of your vehicle or modified in any way, accidents such as electric shock, heat generation, smoke generation, an explosion and electrolyte leakage may occur.

When reselling or handing over your vehicle, the possibility of an accident is extremely high because the person receiving the vehicle may not be aware of these dangers.

- If your vehicle is disposed of without the hybrid battery having been removed, there is a danger of serious electric shock if high voltage parts, cables and their connectors are touched. In the event that your vehicle must be disposed of, the hybrid battery must be disposed of by your Lexus dealer or a qualified service shop. If the hybrid battery is not disposed of properly, it may cause electric shock that can result in death or serious injury.

**⚠ NOTICE****■ Hybrid battery (traction battery) air intake vents**

Do not carry large amounts of water such as water cooler bottles in the vehicle. If water spills onto the hybrid battery (traction battery), the battery may be damaged. Have the vehicle inspected by your Lexus dealer.

**Hybrid battery (traction battery) air intake**

The air intake vents for the hybrid battery (traction battery) are located under the rear seats.

If the air intake vents are blocked, it

could lead to a reduction in hybrid battery (traction battery) output.

If input/output of the hybrid battery (traction battery) becomes limited and the distance that the vehicle can be driven using the electric motor (traction motor) is reduced, the fuel economy may be reduced.

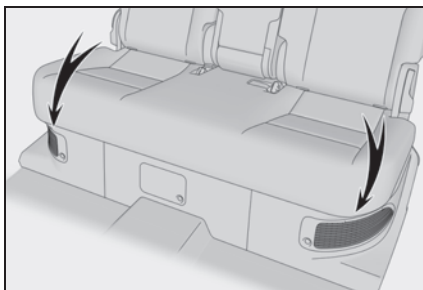
**⚠ NOTICE****■ Hybrid battery (traction battery) air intake vents**

- Make sure not to block the air intake vent with anything, such as a seat cover, plastic cover, or luggage. The input/output of the hybrid battery (traction battery) may be restricted, leading to a reduction in hybrid battery (traction battery) output and a malfunction.
- Periodically clean the air intake vents to prevent them from clogging. (→P.498)
- Do not get water or foreign materials in either the air intake vents as this may cause a short circuit and damage the hybrid battery (traction battery).

**Emergency shut off system**

When a certain level of impact is detected by the impact sensor, the emergency shut off system blocks the high voltage current and stops the fuel pump to minimize the risk of electrocu-

tion and fuel leakage. If the emergency shut off system activates, your vehicle will not restart. To restart the hybrid system, contact your Lexus dealer.

### Hybrid warning message

A message is automatically displayed when a malfunction occurs in the hybrid system or an improper operation is attempted.

If a warning message is shown on the multi-information display, read the message and follow the instructions.

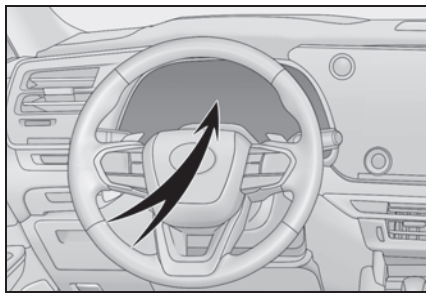

■ **If a warning light comes on, a warning message is displayed, or the 12-volt battery is disconnected**

The hybrid system may not start. In this case, try to start the system again. If the "READY" indicator does not come on, contact your Lexus dealer.

## Immobilizer system

The vehicle's keys have built-in transponder chips that prevent the hybrid system from starting if a key has not been previously registered in the vehicle's on-board computer.

Never leave the keys inside the vehicle when you leave the vehicle.

This system is designed to help prevent vehicle theft but does not guarantee absolute security against all vehicle thefts.

## Operating the system

The indicator light flashes after the power switch has been turned off to indicate that the system is operating.

The indicator light stops flashing after the power switch has been turned to ACC or ON to indicate that the system has been canceled.

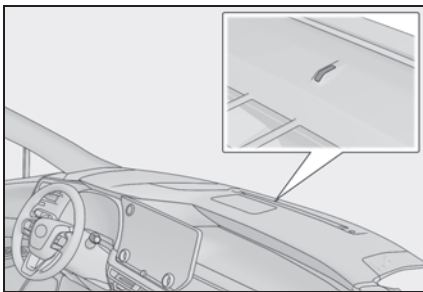

### ■ System maintenance

The vehicle has a maintenance-free type immobilizer system.

### ■ Conditions that may cause the system to malfunction

- If the grip portion of the key is in contact with a metallic object

- If the key is in close proximity to or touching a key registered to the security system (key with a built-in transponder chip) of another vehicle



### NOTICE

- To ensure the system operates correctly

Do not modify or remove the system. If modified or removed, the proper operation of the system cannot be guaranteed.

## Alarm

The alarm uses light and sound to give an alert when an intrusion is detected.

The alarm is triggered in the following situations when the alarm is set:

- A locked door or back door is unlocked or opened in any way other than using the entry function, wireless remote control or mechanical key. (The doors will lock again automatically.)
- The hood is opened.

### Setting/deactivating/stopping the alarm system

#### ■ Items to check before locking the vehicle

To prevent unexpected triggering of the alarm and vehicle theft, make sure of the following:

- Nobody is in the vehicle.
- The windows, moon roof (if equipped) and panoramic moon roof (if equipped) are closed before the alarm is set.
- No valuables or other personal items are left in the vehicle.

#### ■ Setting

Close the doors, back door and hood, and lock all the doors. The system will be set automatically after 30 seconds.

The indicator light changes from being on to flashing when the system is set.

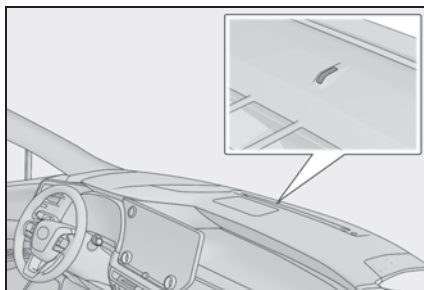

#### ■ Deactivating or stopping

Do one of the following to deactivate or stop the alarms:

- Unlock the doors.
- Turn the power switch to ACC or ON, or start the hybrid system. (The alarm will be deactivated or stopped after a few seconds.)

#### ■ Setting the alarm

The alarm can be set if all the doors are closed even with the hood open.

#### ■ System maintenance

The vehicle has a maintenance-free type alarm system.

#### ■ Triggering of the alarm

The alarm may be triggered in the following situations: (Stopping the alarm deactivates the alarm system.)

- A person inside the vehicle opens a door, the back door or hood, or unlocks the vehicle.



- The 12-volt battery is recharged or replaced when the vehicle is locked. (→P.553)

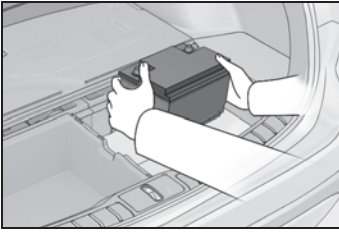

alarm will be deactivated or stopped after a few seconds.)

### ■ Alarm-operated door lock

In the following cases, depending on the situation, the door may automatically lock to prevent improper entry into the vehicle:

- When a person remaining in the vehicle unlocks the door and the alarm is activated.
- While the alarm is activated, a person remaining in the vehicle unlocks the door.
- When recharging or replacing the 12-volt battery



#### NOTICE

#### ■ To ensure the system operates correctly

Do not modify or remove the system. If modified or removed, the proper operation of the system cannot be guaranteed.

### Pre-alarm

If a door is unlocked with the mechanical key while the alarm is being set, the pre-alarm will sound for 10 seconds.

If either the door is locked again or the pre-alarm is stopped within those 10 seconds, an alarm will sound.

Do any of the following in order to deactivate or stop the pre-alarm:

- Close the doors, and lock all doors by smart access system or wireless remote control.
- Turn the power switch to ACC or ON, or start the hybrid system. (The

## Vehicle status information and indicators

# 2

### 2-1. Instrument cluster

Warning lights and indicators .....	<b>86</b>
Gauges and meters .....	<b>90</b>
Multi-information display .....	<b>98</b>
Head-up display .....	<b>101</b>
Displayed content.....	<b>104</b>

## Warning lights and indicators

The warning lights and indicators on the instrument cluster and outside rear view mirrors inform the driver of the status of the vehicle's various systems.

### Warning lights and indicators displayed on the instrument cluster

For the purpose of explanation, the following illustrations display all warning lights and indicators illuminated.

- ▶ Vehicles without a head-up display































- ▶ Vehicles with a head-up display



## Warning lights

Warning lights inform the driver of malfunctions in the indicated vehicle's systems.

- |  |  |   |  |
|--|--|---|--|
|    | Brake system warning light* <sup>1</sup><br>(→P.516)<br>(U.S.A.)             |    | Electric power steering system warning light* <sup>1</sup> (→P.519)<br>(yellow)            |
|    | Brake system warning light* <sup>1</sup><br>(→P.516)<br>(Canada)             |    | Low fuel level warning light<br>(→P.519)   |
|    | Brake system warning light* <sup>1</sup><br>(→P.516)<br>(yellow)             |    | Driver's and front passenger's seat belt reminder light<br>(→P.519)                        |
|    | High coolant temperature warning light* <sup>2</sup> (→P.516)                |    | Rear passengers' seat belt reminder light<br>(Vehicles without a head-up display) (→P.520) |
|    | Hybrid system overheat warning light* <sup>2</sup> (→P.517)                  |    | Rear passengers' seat belt reminder light<br>(Vehicles with a head-up display) (→P.520)    |
|    | Charging system warning light* <sup>2</sup> (→P.517)                         |    | Tire pressure warning light* <sup>1</sup><br>(→P.520)                                      |
|    | Low engine oil pressure warning light* <sup>2</sup> (→P.517)                 |    | Intuitive parking assist OFF indicator (if equipped) (→P.520)                              |
|   | Malfunction indicator lamp* <sup>1</sup><br>(→P.517)<br>(U.S.A.)             |    | PCS warning light* <sup>1</sup> (→P.521)   |
|  | Malfunction indicator lamp* <sup>1</sup><br>(→P.517)<br>(Canada)             |    | LTA indicator (→P.521)<br>(orange)   |
|  | SRS warning light* <sup>1</sup> (→P.518)                                     |   | LDA indicator (→P.521)<br>(orange)   |
|  | ABS warning light* <sup>1</sup> (→P.518)<br>(U.S.A.)                         |  | Dynamic radar cruise control indicator (→P.521)<br>(orange)                                |
|  | ABS warning light* <sup>1</sup> (→P.518)<br>(Canada)                         |  | Cruise control indicator<br>(→P.521)<br>(orange)   |
|  | Inappropriate pedal operation warning light* <sup>2</sup> (→P.518)           |  | PDA indicator (→P.521)<br>(orange)   |
|  | Electric power steering system warning light* <sup>1</sup> (→P.519)<br>(red) |  | Driving assist information indicator* <sup>1</sup> (→P.522)                                |
|  |  |  | Slip indicator* <sup>1</sup> (→P.522)<br>(illuminates)                                     |

**PARK** Parking brake indicator  
(flashes) (→P.522)  
(U.S.A.)

**(P)** Parking brake indicator  
(flashes) (→P.522)  
(Canada)

**HOLD** Brake hold operated indicator<sup>\*1</sup>  
(flashes) (→P.523)

<sup>\*1</sup>: These lights come on when the power switch is turned to ON to indicate that a system check is being performed. They will turn off after the hybrid system is started, or after a few seconds. There may be a malfunction in a system if the lights do not come on, or turn off. Have the vehicle inspected by your Lexus dealer.

<sup>\*2</sup>: This light illuminates on the multi-information display.

### WARNING

#### **■ If a safety system warning light does not come on**

Should a safety system light such as the ABS and SRS warning lights not come on when you start the hybrid system, this could mean that these systems are not available to help protect you in an accident, which could result in death or serious injury. Have the vehicle inspected by your Lexus dealer immediately if this occurs.

### Indicators

The indicators inform the driver of the operating state of the vehicle's various systems.

 Turn signal indicator (→P.226)

 Headlight indicator (→P.232)  
(U.S.A.)

 Tail light indicator (→P.232)  
(Canada)

 Headlight high beam indicator  
(→P.233)  
AHS indicator (if equipped)  
(→P.235)

 AHB indicator (if equipped)  
(→P.237)

 Fog light indicator (→P.240)

 PCS warning light<sup>\*1,2</sup>  
(→P.270)

 Cruise control indicator  
(green/white) (→P.306)  
e)

 Dynamic radar cruise control  
indicator (→P.298)  
(green/white)  
e)

 LDA indicator (→P.282)  
(green/white)  
e)

 LDA OFF indicator<sup>\*2</sup> (if  
equipped) (→P.282)

 LTA indicator (→P.275)  
(green/white)  
e)

 BSM outside rear view mirror  
indicators<sup>\*3</sup> (→P.319, 323,  
337)

 Intuitive parking assist OFF indi-  
cator<sup>\*2</sup> (if equipped) (→P.329)

 Driving assist information indi-  
cator<sup>\*1,2</sup> (→P.319, 323)



(flashes)

Slip indicator\*<sup>1</sup> (→P.395)VSC OFF indicator\*<sup>1,2</sup>  
(→P.395)

"READY" indicator (→P.208)



(U.S.A.)

Parking brake indicator  
(→P.226)

(Canada)

Parking brake indicator  
(→P.226)

HOLD

Brake hold standby indicator\*<sup>1</sup>  
(→P.229)

HOLD

Brake hold operated indicator\*<sup>1</sup>  
(→P.229)

EV

EV indicator (→P.74)



!

Low outside temperature indi-  
cator\*<sup>4</sup> (→P.90)

(green/white)

PDA indicator (→P.289)

Stop light indicator\*<sup>5</sup>

● REC

REC indicator (→P.317)

## ● Drive mode indicators



EV MODE

EV drive mode indicator  
(RX350h only) (→P.212)

ECO

Eco drive mode indicator  
(→P.390)

SPORT

Sport mode indicator  
(→P.390)

CUSTOM

Customize mode indicator  
(→P.390)

!

Trail Mode indicator (→P.392)

\*<sup>1</sup>: These lights come on when the power switch is turned to ON to indicate that a system check is being performed. They will turn off after the hybrid system is started, or after a few seconds. There may be a malfunction in a system if the lights do not come on, or turn off. Have the vehicle inspected by your Lexus dealer.

\*<sup>2</sup>: This light comes on when the system is turned off.

\*<sup>3</sup>: This light illuminates on the outside rear view mirrors.

\*<sup>4</sup>: When the outside temperature is approximately 37°F (3°C) or lower, this indicator will flash for approximately 10 seconds, then stay on.

\*<sup>5</sup>: This light comes on when the stop lights are illuminated by the operation of the brake pedal or the driving assist system.

## Gauges and meters

### Meter display

#### ■ Locations of gauges and meters (except F SPORT models)

##### ▶ Vehicles without a head-up display

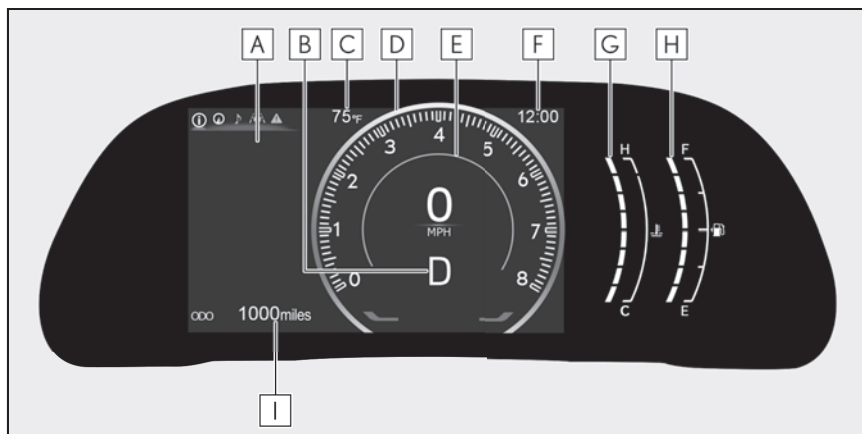

#### **A** Multi-information display

Presents the driver with a variety of vehicle data and displays warning messages if a malfunction occurs. (→P.98, 526)

#### **B** Shift position/shift range

#### **C** Outside temperature

Displays the ambient temperature within the range of -40°F (-40°C) to 140°F (60°C).

#### **D** Tachometer/Hybrid System Indicator/Speedometer

Tachometer: Displays the engine speed in revolutions per minute.

Hybrid System Indicator: Displays hybrid system output or regeneration level. (→P.95)

Depending on the selected drive mode or certain settings, the display will change.

#### **E** Background color of driving mode

Background color changes according to the driving mode.

#### **F** Clock

Automatically adjusts the time by using the GPS time information (GPS clock). For details, refer to the "MULTIMEDIA OWNER'S MANUAL".

#### **G** Engine coolant temperature gauge

Displays the engine coolant temperature.

#### **H** Fuel gauge

Displays the quantity of fuel remaining in the tank.

**I** Odometer and trip meter display (→P.96)

► Vehicles with a head-up display

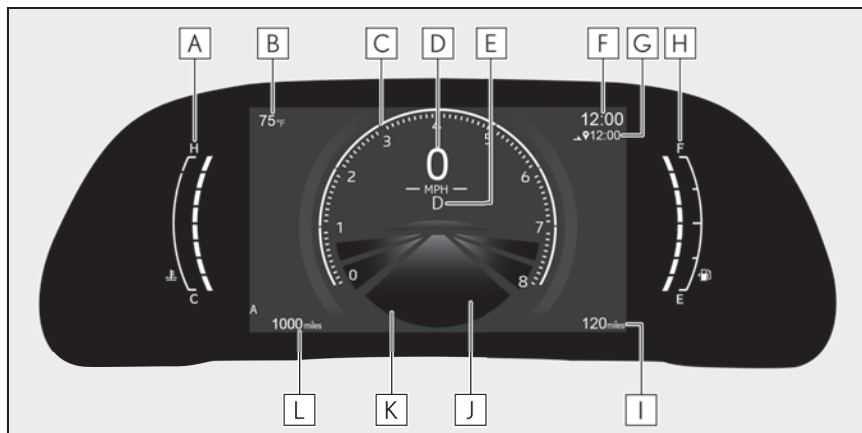

**A** Engine coolant temperature gauge

Displays the engine coolant temperature.

**B** Outside temperature

Displays the ambient temperature within the range of -40°F (-40°C) to 140°F (60°C).

**C** Tachometer/Hybrid System Indicator/Analog speedometer

Tachometer: Displays the engine speed in revolutions per minute.

Hybrid System Indicator: Displays hybrid system output or regeneration level. (→P.95)

Depending on the selected drive mode or certain settings, the display will change.

**D** Digital speedometer

**E** Shift position/shift range

**F** Clock

Automatically adjusts the time by using the GPS time information (GPS clock). For details, refer to the "MULTIMEDIA OWNER'S MANUAL".

**G** Navigation system estimated time of arrival display (if equipped)

Displays the estimated time of arrival according to the navigation system.

**H** Fuel gauge

Displays the quantity of fuel remaining in the tank.

**I** Distance to empty

Displays the driving range with remaining fuel.

**J** Multi-information display

Presents the driver with a variety of vehicle data and displays warning messages if a mal-

function occurs. (→P.98, 526)

**K** Background color of driving mode

Background color changes according to the driving mode.

**L** Odometer and trip meter display (→P.96)

### ■ Locations of gauges and meters (F SPORT models)

Depending on the shift position or current drive mode, the meter displays or position of some gauges will change.

► Ring display state

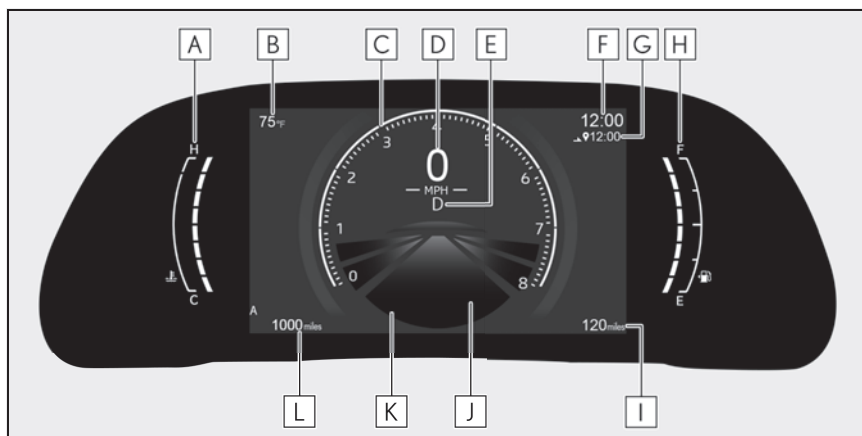

**A** Engine coolant temperature gauge

Displays the engine coolant temperature.

**B** Outside temperature

Displays the ambient temperature within the range of -40°F (-40°C) to 140°F (60°C).

**C** Tachometer/Hybrid System Indicator/Analog speedometer

Tachometer: Displays the engine speed in revolutions per minute.

- Rev indicator
- Rev peak

Hybrid System Indicator: Displays hybrid system output or regeneration level. (→P.95)

Depending on the selected drive mode or certain settings, the display will change.

**D** Digital speedometer

**E** Shift position/shift range/gear position

**F** Clock

Automatically adjusts the time by using the GPS time information (GPS clock). For details, refer to the “MULTIMEDIA OWNER’S MANUAL”.

**G** Navigation system estimated time of arrival display (if equipped)

Displays the estimated time of arrival according to the navigation system.

**H** Fuel gauge

Displays the quantity of fuel remaining in the tank.

**I** Distance to empty

Displays the driving range with remaining fuel.

**J** Multi-information display

Presents the driver with a variety of vehicle data and displays warning messages if a malfunction occurs. (→P.98, 526)

**K** Background color of driving mode

Background color changes according to the driving mode.

**L** Odometer and trip meter display (→P.96)

► Bar display state

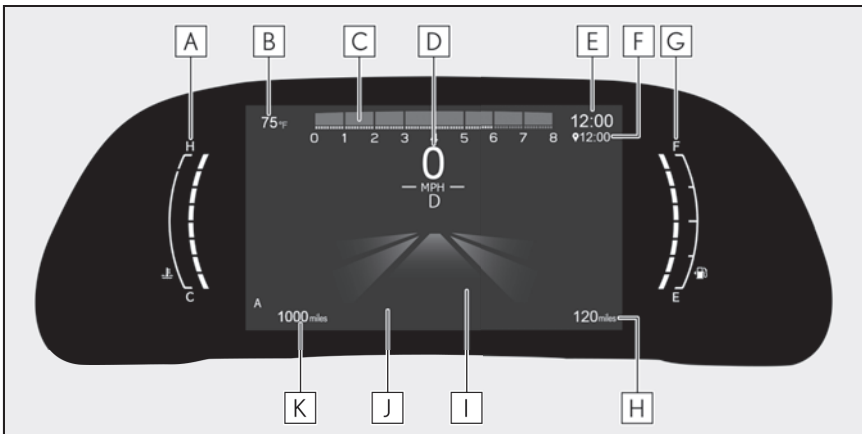

**A** Engine coolant temperature gauge

Displays the engine coolant temperature.

**B** Outside temperature

Displays the ambient temperature within the range of -40°F (-40°C) to 140°F (60°C).

**C** Tachometer/Hybrid System Indicator

Tachometer: Displays the engine speed in revolutions per minute.

- Rev indicator
- Rev peak

Hybrid System Indicator: Displays hybrid system output or regeneration level. (→P.95)

Depending on the selected drive mode or certain settings, the display will change.

**D** Shift position/shift range/gear position/digital speedometer

**E** Clock

Automatically adjusts the time by using the GPS time information (GPS clock). For details, refer to the "MULTIMEDIA OWNER'S MANUAL".

**F** Navigation system estimated time of arrival display (if equipped)

Displays the estimated time of arrival according to the navigation system.

**G** Fuel gauge

Displays the quantity of fuel remaining in the tank.

**H** Distance to empty

Displays the driving range with remaining fuel.

**I** Multi-information display

Presents the driver with a variety of vehicle data and displays warning messages if a malfunction occurs. (→P.98, 526)

**J** Background color of driving mode

Background color changes according to the driving mode.

**K** Odometer and trip meter display (→P.96)

■ **Rev indicator (F SPORT models)**

When the engine speed reaches a set speed or the red zone, the tachometer will be highlighted.

The indicators will be displayed in amber when the engine speed reaches a set speed, and in red when the engine speed reaches the red zone.

The engine speed at which the Rev indicator is displayed can be changed on the center display. (→P.590)

▶ Ring display state



▶ Bar display state

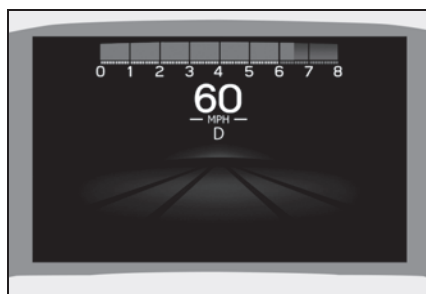

■ **Rev peak (F SPORT models)**

When the engine speed reaches or exceeds 4000 rpm, an afterimage of the tachometer will be displayed at the highest engine speed for approximately 1 second.

► Ring display state



► Bar display state



■ The meters and display illuminate when

The power switch is in ON.

■ Hybrid System Indicator

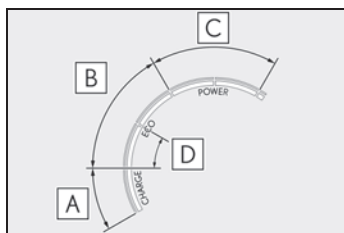

This illustration is for explanation only and may differ depending on the specifications of the vehicle.

**A** Charge area

Shows regeneration\* status.

**B** Eco area

Shows that the vehicle is being driven in an Eco-friendly manner.

**C** Power area

Shows that an Eco-friendly driving range is being exceeded (during full power driving etc.)

**D** Hybrid Eco area

Shows that gasoline engine power is not being used very often.

The gasoline engine will automatically stop and restart under various conditions.

● By keeping the indicator needle within Eco area, more Eco-friendly driving can be achieved.

● Charge area indicates regeneration\* status. Regenerated energy will be used to charge the hybrid battery (traction battery).

\*: When used in this manual, regeneration refers to the conversion of energy created by the movement of the vehicle into electrical energy.

■ Engine speed

On hybrid electric vehicles, engine speed is precisely controlled in order to help improve fuel efficiency and reduce exhaust emissions etc.

There are times when the engine speed that is displayed may differ even when vehicle operation and driving conditions are the same.

■ Outside temperature display

● In the following situations, the correct outside temperature may not be displayed, or the display may take longer than normal to change:

- When stopped, or driving at low speeds (less than 12 mph [20 km/h])
- When the outside temperature has changed suddenly (at the entrance/exit of a garage, tunnel, etc.)

● When "--" or "E" is displayed, the system may be malfunctioning. Take your vehicle to your Lexus dealer.

■ Distance to empty

● This distance is computed based on your average fuel consumption. As a result, the actual distance that can be driven may differ from that displayed.

- When only a small amount of fuel is added to the tank, the display may not be updated. When refueling, turn the power switch off. If the vehicle is refueled without turning the power switch off, the display may not be updated.

### ■ Liquid crystal display

Small spots or light spots may appear on the display. This phenomenon is characteristic of liquid crystal displays, and there is no problem continuing to use the display.

### ■ Free/Open Source Software Information

This product contains Free/Open Source Software (FOSS). The license information and/or the source code of such FOSS can be found at the following URL.

<https://www.denso.com/global/en/opensource/meter/toyota/>



### WARNING

#### ■ The information display at low temperatures

Allow the interior of the vehicle to warm up before using the liquid crystal information display. At extremely low temperatures, the information display monitor may respond slowly, and display changes may be delayed.

For example, there is a lag between the driver's shifting and the new gear number appearing on the display. This lag could cause the driver to downshift again, causing rapid and excessive engine braking and possibly an accident resulting in death or injury.



### NOTICE

#### ■ To prevent damage to the engine and its components

- Do not let the indicator needle of the tachometer enter the red zone, which indicates the maximum engine speed.

- The engine may be overheating if the engine coolant temperature gauge is in the red zone (H); or "Engine Coolant Temp High Stop in a Safe Place See Owner's Manual" is shown on the multiinformation display. In this case, immediately stop the vehicle in a safe place, and check the engine after it has cooled completely. (→P.560)

## Odometer and trip meter display

### ■ Display items

#### ● Odometer

Displays the total distance the vehicle has been driven.

#### ● Trip meter A/trip meter B

Displays the distance the vehicle has been driven since the meter was last reset. Trip meters A and B can be used to record and display different distances independently.

#### ● Distance until next engine oil change

Displays the distance the vehicle can be driven until an oil change is necessary.

### ■ Changing the display

Each time the "ODO TRIP" switch is pressed, the displayed item will be changed. When the trip meter is displayed, pressing and holding the switch will reset the trip meter.

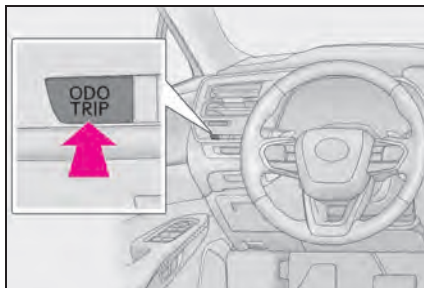

## Changing between the tachometer/hybrid system indicator/speedometer displays

Depending on the current drive mode or settings, the displays will change as follows. Settings can be changed on the center display. (→P.590)

### ▶ Vehicles without a head-up display

#### ● Tachometer

The tachometer will be displayed in the following situations when the meter display type setting is set to display type 1 or display type 3.

- When the tachometer setting is set to always display the tachometer
- When the tachometer setting is set to change according to the driving mode and sport mode is selected

#### ● Hybrid System Indicator

The hybrid system indicator will be displayed in the following situations when the meter display type setting is set to display type 1 or display type 3.

- When the tachometer setting is set to always display the hybrid system indicator
- When the tachometer setting is set to change according to the driving mode and a driving mode other than sport mode is selected

#### ● Speedometer

Always displayed.

The display will change between a digital speedometer and/or analog speedometer depending on the meter display type setting.

### ▶ Vehicles with a head-up display

#### ● Tachometer

Displayed when the meter display type setting is set to display type 1.

F SPORT models: Also displayed in the following situations when the setting is set to display type 3.

- When the tachometer setting is set to always display the tachometer
- When the tachometer setting is set to change according to the driving mode and sport mode is selected

#### ● Hybrid System Indicator

Displayed when the meter display type setting is set to display type 1.

F SPORT models: Also displayed in the following situations when the setting is set to display type 3.

- When the tachometer setting is set to always display the hybrid system indicator
- When the tachometer setting is set to change according to the driving mode and a driving mode other than sport mode is selected

#### ● Speedometer

A digital speedometer is always displayed.

When the meter display type setting is set to display type 2, an analog speedometer will also be displayed.

## Changing the instrument panel light brightness

The brightness of the instrument panel lights can be adjusted.

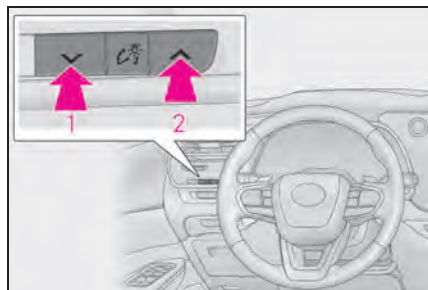

- 1 Darker
- 2 Brighter

### ■ Brightness of the meters (day mode and night mode)

The brightness of the meters is changed between day mode and night mode.

- Day mode: When the tail lights are off or when the tail lights are on but the surrounding area is bright
- Night mode: When the tail lights are on and the surrounding area is dark

When the tail lights are on but the surrounding area is bright, any adjustments made to the meter brightness levels will be applied to both modes at once.

## Multi-information display

### Displayed contents summary

#### ■ Display area

A variety of driving-related information can be displayed. Depending on the situation, warning or advice pop-up displays will also be displayed.

- ▶ Vehicles without a head-up display

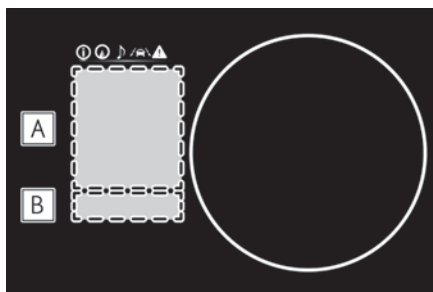

- A Content display area
- B Driving support system information display area

When a menu icon other than  is selected, if the driving support system operates, the system operating state will be displayed.

- ▶ Vehicles with a head-up display

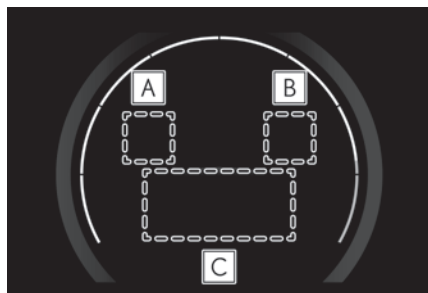

- A Navigation system-linked display area (if equipped)

If the navigation system linked-display is not displayed in the content display area, route guidance will be displayed.

### **B** Driving support system information display area

When driving support system information is not displayed in the content display area, if the driving support system operates, the system operating state will be displayed.

### **C** Content display area

#### ■ Items displayed in the content display area

##### ▶ Vehicles without a head-up display

By selecting menu icons on the multi-information display, the following items can be displayed.



Driving information display



Navigation system-linked display (if equipped)



Audio system-linked display



Driving support system information display



Warning message

##### ▶ Vehicles with a head-up display

The following items can be displayed.

- Drive information 1
- Drive information 2
- Energy monitor/EV driving ratio
- Audio system-linked display
- Navigation system-linked display (if equipped)\*
- RX500h: Boost gauge/engine oil temperature gauge/engine oil pres-

sure gauge

- G-force
- RX500h: Gear Position
- Driving support system information display\*
- Blank (No items)

\* : Displayed on the head-up display when the display mode is set to display the maximum.

#### ■ Liquid crystal display

→P.96

#### **!** WARNING

##### ■ Caution for use while driving

- When operating the multi-information display while driving, pay extra attention to the safety of the area around the vehicle.
- Do not look continuously at the multi-information display while driving as you may fail to see pedestrians, objects on the road, etc. ahead of the vehicle.

##### ■ The information display at low temperatures

→P.96

##### ■ Cautions during setting up the display

As the hybrid system needs to be operating during setting up the display, ensure that the vehicle is parked in a place with adequate ventilation. In a closed area such as a garage, exhaust gases including harmful carbon monoxide (CO) may collect and enter the vehicle. This may lead to death or a serious health hazard.



## NOTICE

**■ While setting up the display**

To prevent 12-volt battery discharge, ensure that the hybrid system is operating while setting up the display features.

## Head-up display \*

\*: If equipped

The head-up display projects a variety of driving-related information and the operating state of the driving support systems on the windshield.

### System components

The content displayed will differ according to the driving conditions and display mode of the head-up display. Depending on the situation, pop-up displays will also be displayed.

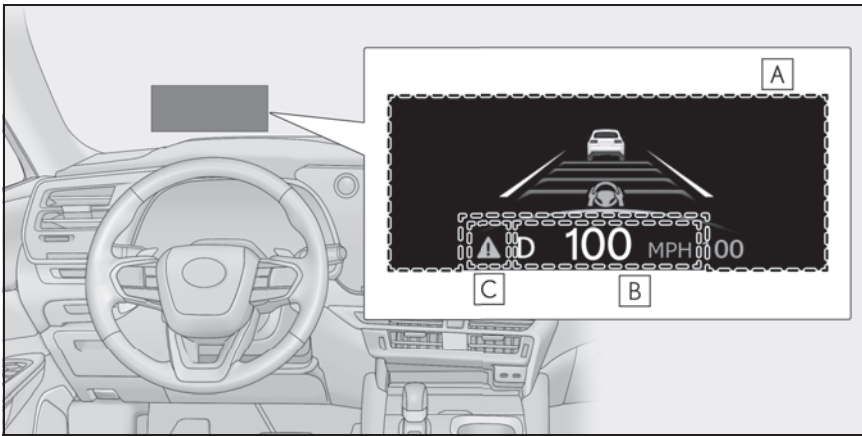

#### **A** Main display area

Displays the following items:

- Driving support system information display
- Hybrid System Indicator/Tachometer
- Compass (if equipped)
- Speed limit of the current road (linked to the navigation system) (U.S.A. only)

#### **B** Driving information display area

Displays the following items:

- Speedometer
- Shift position/shift range/gear position

#### **C** : Master warning icon

Displayed when a warning message is displayed.

#### **■** Head-up display will operate when

The power switch is in ON.

#### **■** Head-up display

The head-up display may seem dark or hard to see when viewed through sunglasses,

especially polarized sunglasses. Adjust the brightness of the head-up display or remove your sunglasses.

### ■ The tachometer/hybrid system indicator is displayed when

When the following conditions are met, the tachometer or hybrid system indicator will be displayed on the head-up display.

- The head-up display is set to display the maximum. (→P.590)
- LTA (Lane Tracing Assist) is disabled. (→P.274)
- LDA (Lane Departure Alert) is disabled. (→P.590)
- The cruise control, selected by pressing the driving assist mode select switch, is canceled. (→P.307, 308)



### WARNING

#### ■ Before using the head-up display

- Check that the position and brightness of the head-up display image does not interfere with safe driving. Incorrect adjustment of the image's position or brightness may obstruct the driver's view and lead to an accident, resulting in death or serious injury.
- Do not continuously look at the head-up display while driving as you may fail to see pedestrians, objects on the road, etc. ahead of the vehicle.



### NOTICE

#### ■ To prevent damage to components

- Do not place any drinks near the head-up display projector. If the projector gets wet, electrical malfunctions may result.

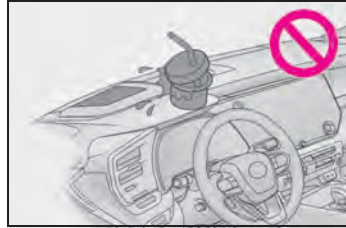

- Do not place anything on or put stickers onto the head-up display projector. Doing so could interrupt head-up display indications.
- Do not touch the inside of the head-up display projector or thrust sharp edges or the like into the projector. Doing so could cause mechanical malfunctions.

## Changing settings of the head-up display

- 1 Select  on the center display.
- 2 Select "Vehicle customize".
- 3 Select "Head up display".







The following settings for the head-up display can be changed. (→P.590)

- Display on/off
- Display mode
- Height
- Brightness
- Angle

### ■ Changing settings with the steering wheel switches

If any of the following items have been set as a favorite steering wheel switch function,

settings of the head-up display can be changed using the steering wheel switches.

-  : Display on/off
-  : Display mode
-  /  : Height
-  + / -  : Brightness

#### ■ Enabling/disabling of the head-up display

If the head-up display is disabled, it will remain disabled when the power switch is turned off then back to ON.

#### ■ Display brightness

In addition to the brightness setting, the brightness of the display will change automatically according to the ambient brightness.

#### ■ Head-up display automatic position adjustment (vehicles with driving position memory)

If the display position is recorded into memory, the head-up display will be automatically adjusted to the desired position.

#### NOTICE

##### ■ When changing the settings of the head-up display

To prevent 12-volt battery discharge, ensure that the hybrid system is operating while the changing the settings of the head-up display.

#### WARNING

##### ■ Caution for changing settings of the head-up display

As the hybrid system needs to be operating while changing the settings of the head-up display, ensure that the vehicle is parked in a place with adequate ventilation. In a closed area such as a garage, exhaust gases including harmful carbon monoxide (CO) may collect and enter the vehicle. This may lead to death or a serious health hazard.

## Displayed content

### Components/Operations

#### ► Vehicles without a head-up display

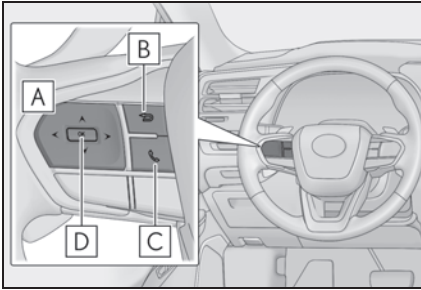

- A** < / > : Select menu icons  
     ^ / v : Change displayed content, scroll up/down the screen and move the cursor up/down
- B** Return to the previous screen
- C** Start/receive call  
     Linked with the hands-free system, sending or receiving call is displayed. For details regarding the hands-free system, refer to the "MULTIMEDIA OWNER'S MANUAL".
- D** Enter/Set

#### ► Vehicles with a head-up display

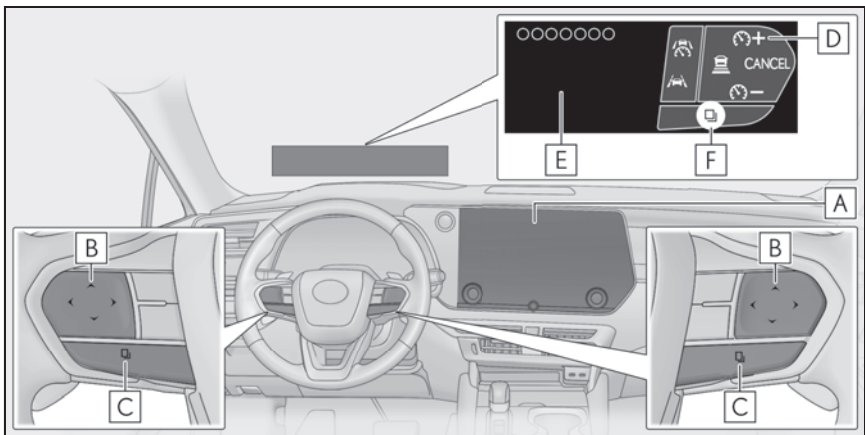

- A** Center display
- B** Steering switch

The function of each switch differs depending on the conditions and settings.

When a switch is touched, the function of each switch is displayed on the head-up display. If the head-up display is off, or when it is not possible to display content on the head-up display, the functions will be displayed on the multi-information display.

Also, preferred functions for each switch can be set on the center display.

**C** Switch function change switch

Each time this switch is pressed, the functions will change.

**D** Switch icon display

The icon of each switch will be displayed. The touched switch will be highlighted. **(F)**

**E** Switch function guide display

The function guide for the touched switch will be displayed.

### ■ Switching the display of the multi-information display (vehicles without a head-up display)

1 Press < or > of the meter control switch.

#### ● Switching driving information

1 Press the < or > meter control switch to select **(i)**. Then press ^ or v .

### ■ Switching the display of the multi-information display (vehicles with a head-up display)

1 Select  on the center display.

2 Select "Vehicle customize".

3 Select "Meter".

4 Select < or > of "Display switching".

The display changes each time the switch is selected.

### ■ If the steering wheel switches do not respond when touched (vehicles with a head-up display)

● It is easier to make the steering wheel switches respond by moving your thumb while touching them.

● If the surface of a steering wheel switch is dirty, turn the power switch off and then clean the switches.

● By turning winter glove mode on, the sensitivity of the switch sensors can be

increased. (→P.590)

### ■ Switching with the steering wheel switches (vehicles with a head-up display)

If **◀DISP / DISP▶** is set as a favorite steering wheel switch function, the display can be switched by pushing **◀DISP** or



### Display of drive information

Driving related information is displayed on the following displays.

- Multi-information display
- Head-up display (If equipped)
- Center display

The items displayed will differ depending on the display.

### Drive information 1

The following items can be displayed on the multi-information display.

Use the displayed values as a reference only.

- Current fuel consumption

Displays instantaneous current fuel consumption

- Average fuel consumption

### Drive information 2

The following items can be displayed on the multi-information display.

- Average vehicle speed
- Total driving time

### Drive information 3 (vehicles without a head-up display)

The following items can be displayed on the multi-information display.

- Distance to empty

Displays the driving range with remaining fuel.

- Average fuel economy since starting

Displays the average fuel consumption since starting.

#### ■ Distance to empty

→P.95

### Energy monitor/EV driving ratio (If equipped)

The energy monitor and EV driving ratio can be displayed on the multi-information display.

The energy monitor screen can be displayed on the center display.

#### ■ Displaying Energy monitor screen on the center display

- 1 Select  on the main menu.
- 2 Select "Energy flow".

#### ■ Energy monitor

The energy monitor can be used to

check the vehicle drive status, hybrid system operation status and energy regeneration status.

The arrows will appear in accordance with the energy flow. When there is no energy flow, arrows will not be displayed.

The color of the arrows will change as follows

- Blue: When the hybrid battery (traction battery) is regenerated or charged.
- Orange: When the hybrid battery (traction battery) is in use.
- Red: When the gasoline engine is in use.

The image shows all the arrows as an example. The actual display will vary depending on conditions.

#### ► Multi-information display

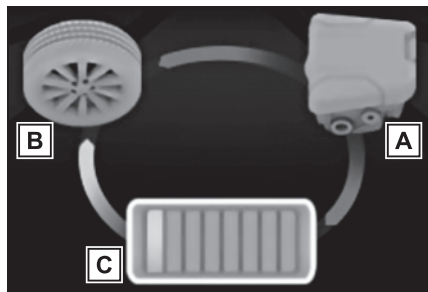

**A** Gasoline engine

**B** Tires

**C** Hybrid battery (traction battery)

This illustration is for explanation only and may differ depending on the specifications of the vehicle.

► Center display

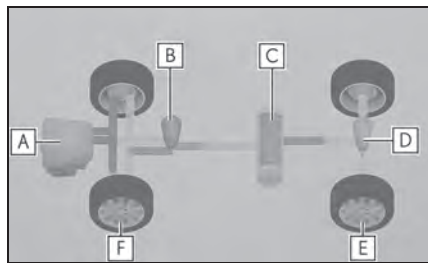

- A** Gasoline engine
- B** Front electric motor (traction motor)
- C** Hybrid battery (traction battery)
- D** Rear electric motor (traction motor)
- E** Rear tires
- F** Front tires

■ **EV driving ratio since starting (If equipped)**

Displays the percentage of EV driving since starting.

It is reset each time the hybrid system stops.

■ **Color of the hybrid battery (traction battery) on the center display**

It will be green when the hybrid battery (traction battery) is being charged, and yellow when the hybrid battery (traction battery) is being used.

■ **Remaining charge amount warning of hybrid battery (traction battery)**

- The buzzer sounds intermittently when the hybrid battery (traction battery) remains without charging while the shift position is in N, or the remaining charge amount drops below a certain level. If the remaining charge amount drops further, the buzzer sounds continuously. (RX350h)
- When a warning message is shown on

the multi-information display and the buzzer sounds, follow the instructions displayed on the screen to perform troubleshooting.

**Boost gauge/engine oil temperature gauge/engine oil pressure gauge (RX500h)**

The following items can be displayed on the multi-information display.



**A** Boost gauge

Displays the boost pressure. The display will change color if the specified pressure is exceeded.

**B** Engine oil temperature gauge

Displays the engine oil temperature. The display will flash if the engine oil temperature exceeds 284 °F (140 °C).

**C** Engine oil pressure gauge

Displays the engine oil pressure. A buzzer will sound and warning message will be displayed if the engine oil pressure becomes low. (→P.526)

This display is intended for use as a guideline. Depending on factors such as the road surface condition, temperature and vehicle speed, the display may not show the actual condition of the vehicle.

**G-force**

Displays lateral G-forces on the vehi-

cle on the multi-information display.

Displays around the periphery of the G-force display, the left and right steering amount, accelerator pedal input, and brake fluid pressure.

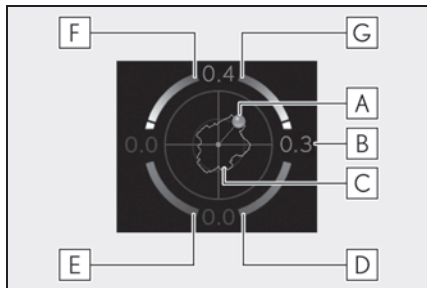

- A** Acceleration G-force on the vehicle
- B** Current G-force value (analyzed value of front/rear and left/right G-forces)
- C** Record of the maximum G-forces
- D** Accelerator pedal input
- E** Brake fluid pressure
- F** Left steering amount
- G** Right steering amount

This display is intended for use as a guideline. Depending on factors such as the road surface condition, temperature and vehicle speed, the display may not show the actual condition of the vehicle.

- Resetting the record of maximum G-forces

The display is reset each time the hybrid system is started.

- Peak hold function

If lateral G-forces of 0.5 G or greater are generated, the G-force value display will turn amber and be held for 2 seconds.

### ■ G-force display

- The G-force values may not be zero even when the vehicle is parked, such as when it is parked on an incline.
- Depending on the vehicle usage conditions, the brake fluid pressure display may not reach its maximum reading even though the brake pedal is fully depressed.
- If a 12-volt battery terminal is disconnected and reconnected, the steering amount display may be disabled temporarily. After driving the vehicle for a while, the display will be enabled.

### Gear Position (RX500h)

Displays the current shift range or gear position when the shift position is in D or M.

### Blank (No items)

Displays no drive information contents on the multi-information display.

### Current fuel consumption/history screen

Fuel consumption information can be displayed on the center display.

#### ■ Displaying fuel consumption/history screen on the center display

- 1 Select  on the main menu.
- 2 Select "Trip information".
- 3 Select "Current" or "History".

## ■ Current fuel consumption screen

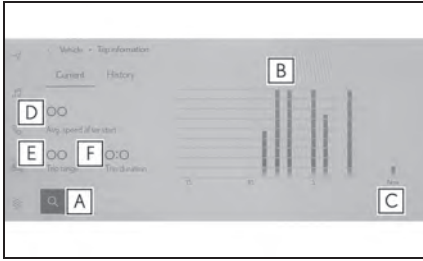

- A** Resetting the history data
- B** Fuel consumption in the past 15 minutes
- C** Current fuel consumption
- D** Average vehicle speed since the hybrid system was started.
- E** Trip range
- F** Elapsed time since the hybrid system was started.

Use the displayed average fuel consumption as a reference. The image is an example only, and may vary slightly from actual conditions.

## ■ History fuel consumption screen



- A** Latest fuel consumption
- B** Best recorded fuel consumption
- C** Previous fuel consumption record
- D** Resetting the history data
- E** Updating the latest fuel consumption data

Use the displayed average fuel consumption as a reference. The image is an example only, and may vary slightly from actual conditions.

### ■ Updating the history data

Update the latest fuel consumption by selecting “Update” to measure the current fuel consumption again.

### ■ Resetting the data

The fuel consumption data can be deleted by selecting “Clear data”.

### ■ Trip range

Displays the estimated maximum distance that can be driven with the quantity of fuel remaining.

This distance is computed based on your average fuel consumption. As a result, the actual distance that can be driven may differ from that displayed.

## AWD operation status display

AWD operation status display can be displayed on the center display.

### ■ Displaying AWD operation status display on the center display

- 1 Select  on the main menu.
- 2 Select “All wheel drive”.

### ■ AWD operation status

**Torque distribution display:** Displays the drive status of each wheel in 6 steps from 0 to 5.

The illustration used is intended as an example, and may differ from the image that is actually displayed on the center display.

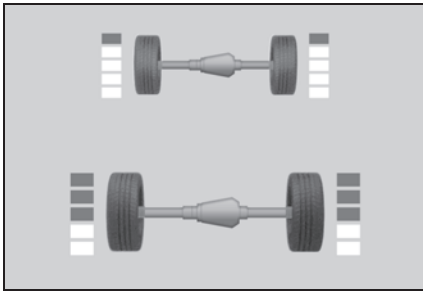

## Tire pressure

The tire pressure detected by the tire pressure warning system can be displayed on the center display.

### ■ Displaying the tire pressure on the center display

- 1 Select  on the main menu.
- 2 Select "Tire pressure".

### ■ Tire inflation pressure

→P.486

## Audio system-linked display

The audio system-linked display displays the operating state of the audio system on the multi-information display.

Operations such as selecting the audio source or track, etc. can be performed.

## Navigation system-linked display (if equipped)

The following information is displayed on the multi-information display.

- Route guidance to destination
- Speed limit of the current road (linked to the navigation system)

(U.S.A. only)

- Street name
- Compass

### ■ Display position (vehicles with a head-up display)

Depending on the display settings of the head-up display, some content may be displayed on the head-up display and not in the content display area of the multi-information display.

## Driving support system information display

The operating state of the following systems can be displayed on the multi-information display or head-up display (if equipped).

- Dynamic radar cruise control (→P.295)
- Cruise control (→P.306)
- LTA (Lane Tracing Assist) (→P.271)
- LDA (Lane Departure Alert) (→P.279)
- LCA (Lane Change Assist) (if equipped) (→P.276)
- RSA (Road Sign Assist) (if equipped) (→P.293)
- PDA (Proactive Driving Assist) (→P.285)
- PCS (Pre-Collision System) (→P.261)

### ■ Display position (vehicles with a head-up display)

When the display mode of the head-up display is set to display the maximum, driving support system information will be displayed on the head-up display and not in

the content display area of the multi-information display.

### Pop-up display information

Pop-up displays will be displayed on the multi-information display or the head-up display (if equipped) when necessary.

When a pop-up display is displayed, a current display may no longer be displayed. In this case, the display will return after the pop-up display disappears.

### Driving support systems

Displays a warning/suggestion/advice message or the operating state of a relevant system.

- Dynamic radar cruise control
- Cruise control
- LTA (Lane Tracing Assist)
- LDA (Lane Departure Alert)
- LCA (Lane Change Assist) (if equipped)
- PDA (Proactive Driving Assist)
- PCS (Pre-Collision System)
- RSA (Road Sign Assist) (if equipped)
- SEA (Safe Exit Assist [with Door Opening Control])
- FCTA (Front Cross Traffic Alert) (if equipped)

### Warning message

Some warning messages are displayed when necessary, according to certain conditions.

### Hands-free system status

Displayed when the hands-free system is operated.

### Suggestion function

Displays suggestions to the driver in the following situations. To select a response to a displayed suggestion, use the steering switches.

- Suggestion to enable the power back door

If the power back door system is disabled (setting on the center display set to off) and the power back door switch on the instrument panel is operated, a suggestion message will be displayed asking if you wish to enable the power back door system.

To enable the power back door system, select "YES".

After enabling the power back door system, press the power back door switch again to open or close the power back door.

### Steering wheel switch operation display

- ▶ Vehicles without a head-up display

Displayed when an audio remote control switch or a talk switch on the steering wheel is operated.

- ▶ Vehicles with a head-up display

When a steering wheel switch is touched, the icon of each switch and a function guide is displayed.

### Navigation system-linked information (if equipped)

Depending on the situation, navigation system-linked route guidance to destination may be displayed.

### Items displayed when the power switch is turned off

The following items will be displayed on the multi-information display when the power switch is turned off.

- Average fuel consumption since starting<sup>\*</sup>
- Distance driven since starting<sup>\*</sup>
- Driving time since starting<sup>\*</sup>
- EV driving ratio since starting<sup>\*</sup>

Displays the percentage of EV driving since starting.

<sup>\*</sup>: It is reset each time the hybrid system stops.

- 3-1. Key information**
  - Keys ..... **114**
  - Digital Key..... **117**
- 3-2. Opening, closing and locking the doors**
  - Side doors ..... **119**
  - Power back door..... **124**
  - Smart access system with push-button start ..... **139**
- 3-3. Adjusting the seats**
  - Front seats..... **144**
  - Rear seats..... **145**
  - Head restraints..... **152**
- 3-4. Adjusting the steering wheel and mirrors**
  - Steering wheel..... **155**
  - Inside rear view mirror..... **156**
  - Digital Rear-view Mirror..... **157**
  - Outside rear view mirrors..... **166**
- 3-5. Opening, closing the windows and moon roof**
  - Power windows..... **169**
  - Moon roof ..... **171**
  - Panoramic moon roof ..... **174**
- 3-6. Favorite settings**
  - Driving position memory ..... **178**
  - My Settings..... **182**

## Keys

### The keys

The following keys are provided with the vehicle.

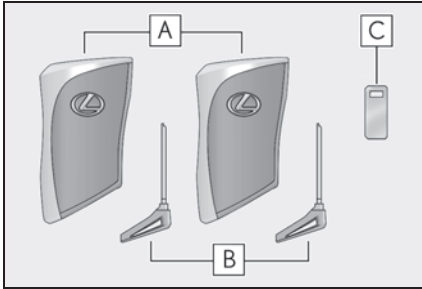

#### A Electronic keys

- Operating the smart access system with push-button start (→P.139)
- Operating the wireless remote control function (→P.115)

#### B Mechanical keys

#### C Key number plate

#### ■ When riding in an aircraft

When bringing an electronic key onto an aircraft, make sure you do not press any buttons on the electronic key while inside the aircraft cabin. If you are carrying an electronic key in your bag, etc., ensure that the buttons are not likely to be pressed accidentally. Pressing a button may cause the electronic key to emit radio waves that could interfere with the operation of the aircraft.

#### ■ Electronic key battery depletion

- The standard battery life is 1 to 2 years. (The card key battery life is about a year and a half.)
- If the battery becomes low, an alarm will sound in the cabin when the hybrid system is stopped.
- To reduce key battery depletion when the electronic key is to not be used for long

periods of time, set the electronic key to the battery-saving mode. (→P.140)

- As the electronic key always receives radio waves, the battery will become depleted even if the electronic key is not used. The following symptoms indicate that the electronic key battery may be depleted. Replace the battery when necessary.
  - The smart access system with push-button start or the wireless remote control does not operate.
  - The detection area becomes smaller.
  - The LED indicator on the key surface does not turn on.
- You can replace the battery by yourself (→P.501). However, as there is a danger that the electronic key may be damaged, it is recommended that replacement is carried out by your Lexus dealer.
- To avoid serious deterioration, do not leave the electronic key within 3 ft. (1 m) of the following electrical appliances that produce a magnetic field:
  - TVs
  - Personal computers
  - Cellular phones, cordless phones and battery chargers
  - Recharging cellular phones or cordless phones
  - Table lamps
  - Induction cookers
- If the electronic key is near the vehicle for longer than necessary, even if the smart access system with push-button start is not used, the key battery may become depleted faster than normal. When not using the smart access system with push-button start, it is recommended not to stay with the electronic key near the vehicle longer than necessary.

#### ■ Replacing the battery

→P.501

#### ■ Confirmation of the registered key number

The number of keys already registered to the vehicle can be confirmed. Ask your Lexus dealer for details.

■ If “A New Key has been Registered Contact Your Dealer for Details” is shown on the multi-information display

This message will be displayed each time the driver's door is opened when the doors are unlocked from the outside for approximately one week after a new electronic key has been registered.

If this message is displayed but you have not had a new electronic key registered, ask your Lexus dealer to check if an unknown electronic key (other than those in your possession) has been registered.



### NOTICE

■ To prevent key damage

- Do not drop the keys, subject them to strong shocks or bend them.
- Do not expose the keys to high temperatures for long periods of time.
- Do not get the keys wet or wash them in an ultrasonic washer, etc.
- Do not attach metallic or magnetic materials to the keys or place the keys close to such materials.
- Do not disassemble the keys.
- Do not attach a sticker or anything else to the surface of the electronic key.
- Do not place the keys near objects that produce magnetic fields, such as TVs, audio systems and induction cookers.
- Do not place the keys near medical electrical equipment such as low-frequency therapy equipment or microwave therapy equipment, and do not receive medical attention with the keys on your person.

■ Carrying the electronic key on your person

Carry the electronic key 3.9 in. (10 cm) or more away from electric appliances that are turned on. Radio waves emitted from electric appliances within 3.9 in. (10 cm) of the electronic key may interfere with the key, causing the key to not function properly.

■ In case of a smart access system with push-button start malfunction or other key-related problems

→P.548

■ When an electronic key is lost

→P.548

## Wireless remote control

The electronic keys are equipped with the following wireless remote control:

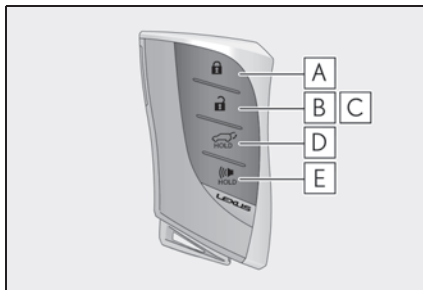

- A** Locks all the doors (→P.119)
- B** Unlocks all the doors (→P.119)
- C** Opens the windows<sup>\*2</sup> and the moon roof<sup>\*1,2</sup> or panoramic moon roof<sup>\*1,2</sup> (→P.119)
- D** Opens and closes the power back door (→P.126)
- E** Sounds the alarm

\*1: If equipped

\*2: These settings must be customized at your Lexus dealer.

### ■ Theft deterrent panic mode

When  is pressed for longer than about one second, an alarm will sound intermittently and the vehicle lights will flash to deter any person from trying to break into or damage your vehicle.

To stop the alarm, press any button on the electronic key.



### Using the mechanical key

To take out the mechanical key, push the release button and take the key out.

The mechanical key can only be inserted in one direction, as the key only has grooves on one side. If the key cannot be inserted in a lock cylinder, turn it over and re-attempt to insert it.

After using the mechanical key, store it in the electronic key. Carry the mechanical key together with the electronic key. If the electronic key battery is depleted or the entry function does not operate properly, you will need the mechanical key. (→P.549)

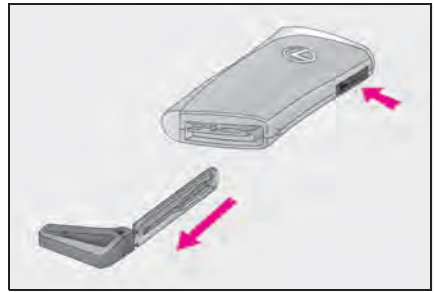

### ■ When required to leave the vehicle's key with a parking attendant

Lock the glove box as circumstances demand. (→P.428)

Remove the mechanical key for your own use and provide the attendant with the electronic key only.

### ■ If you lose your mechanical keys

→P.548

### ■ If a wrong key is used

The key cylinder rotates freely, isolated from the internal mechanism.

## Digital Key\*

\*: If equipped

A smartphone can be used instead of the electronic key of the vehicle by installing the dedicated Digital Key App on a smartphone. Also, Digital Key can be shared with your family or friends using the Digital Key App.

### Free/open source software information

This product contains Free/open source software (FOSS). License information and/or the source code of this FOSS can be obtained at the following URL:

<https://www.denso.com/global/en/opensource/dkey/toyota/>

### Digital key usage conditions

In order to use the Digital Key, you need to install the Lexus App. Register the Vehicle to the customer's Lexus App profile, and subscribe to Remote Services, and enroll in Digital Key.

### Digital key precautions

- A Digital Key can be used when the smartphone and server can communicate. The Digital Key may become unusable if the smartphone is not connected to the Internet. Be sure to carry the electronic key of the vehicle if traveling to a location with unreliable communications.
- If the smartphone battery is depleted, the smartphone cannot be used as Digital Key. If the battery

level is low, be sure to charge the smartphone prior to going out.

- The Digital Key system is related to the smart access system with push-button start. If the smart access system with pushbutton start has been deactivated in the vehicle customization setting, the Digital Key will also be disabled.
  - Depending on the radio wave environment, the Digital Key may not be able to be used. (→P.141)
  - When transferring vehicle ownership, make sure to delete the Digital Keys.
  - If the vehicle is not operated for 14 days or more, the Digital Key will not connect automatically. Therefore, it may take some time before the system operates after a door handle is touched.
  - A part of the services may be stopped for a certain period of time due to server maintenance. However, registered Digital Keys can be used during the maintenance.
  - A smartphone with the Digital Key App enabled will be able to lock and unlock the doors, start the hybrid system and perform any other operations as same as the electronic key of the vehicle. Be especially careful not to lose the smartphone or allow it to be stolen.
- If the smartphone is lost or stolen, contact your Lexus dealer immediately.
- When taking your vehicle to a Lexus dealer for an inspection or repairs,

make sure to bring an electronic key.

- With the digital key alone, no vehicle lights will illuminate when approached to the vehicle. Also, with the digital key alone, some functions, such as the power back door's close & lock (walk-away) function, etc., cannot be used.

## Side doors

The vehicle can be locked and unlocked using the entry function, wireless remote control or door lock switches.

### Unlocking and locking the doors from the outside

#### Smart access system with push-button start

Carry the electronic key to enable this function.

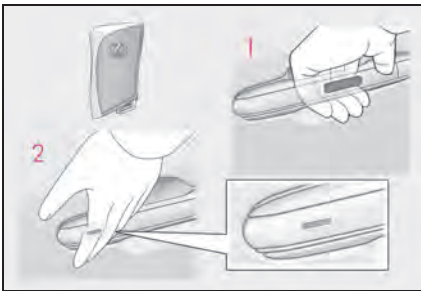

- 1 Grip the driver's door handle to unlock the door. Grip any passenger door handle to unlock all the doors.\*

Make sure to touch the sensor on the back of the handle.

The doors cannot be unlocked for 3 seconds after the doors are locked.

\*: The door unlock settings can be changed.

- 2 Touch the lock sensor (indentation on the surface of the door handle) to lock all the doors.

Check that the door is securely locked.

#### Wireless remote control



- 1 Locks all the doors

Check that the door is securely locked.

- 2 Unlocks all the doors

Pressing the button unlocks the driver's door. Pressing the button again within 3 seconds unlocks the other doors.\*<sup>2</sup>





Press and hold to open the windows\*<sup>2</sup> and the moon roof\*<sup>1,2</sup> or panoramic moon roof\*<sup>1,2</sup>

\*<sup>1</sup>: If equipped



\*<sup>2</sup>: This setting must be customized at your Lexus dealer.

#### Switching the door unlock function

It is possible to set which doors the entry function unlocks using the wireless remote control.

- 1 Turn the power switch off.
- 2 When the indicator light on the key surface is not on, press and hold ,  or  for approximately 5 seconds while pressing and holding .

The setting changes each time an operation is performed, as shown below. (When changing the setting continuously, release the buttons, wait for at least 5 seconds, and repeat step 2.)

Multi-information display/Beep	Unlocking function
 <p>Exterior: Beeps 3 times</p>	<p>Holding the driver's door handle unlocks only the driver's door.</p>
 <p>Exterior: Beeps twice</p>	<p>Holding any of the passenger door handles unlocks all the doors.</p>
 <p>Exterior: Beeps twice</p>	<p>Holding a door handle unlocks all the doors.</p>

To prevent unintended triggering of the alarm, unlock the doors using the wireless remote control and open and close a door once after the settings have been changed. (If a door is not opened within 60 seconds after  is pressed, the doors will be locked again and the alarm will automatically be set.)

In a case that the alarm is triggered, immediately stop the alarm. (→P.83)

#### ■ Impact detection door lock release system

If the vehicle is involved in a severe frontal or rear collision, manual release handle operation will be enabled for all of the doors.

#### ■ Operation signals

Doors:

A buzzer sounds and the emergency flashers flash to indicate that the doors have been locked/unlocked. (Locked: Once; Unlocked: Twice)

Windows and moon roof or panoramic moon roof:

A buzzer sounds.

#### ■ Security feature

If a door is not opened within approximately 60 seconds after the vehicle is unlocked,

the security feature automatically locks the vehicle again.

#### ■ When the door cannot be locked by the lock sensor on the surface of the door handle

When the door cannot be locked even if the lock sensor on the surface of the door handle is touched by a finger, touch the lock sensor with the palm.

When gloves are being worn, remove the gloves.

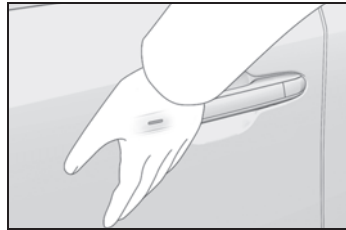

#### ■ Door lock buzzer

If an attempt to lock the doors using the smart key system is made when a door is not fully closed, a buzzer will sound continuously for 5 seconds. Fully close the door to stop the buzzer, and lock the doors again.

#### ■ Setting the alarm

Locking the doors will set the alarm system. (→P.83)

#### ■ Conditions affecting the operation of the smart access system with push-button start or wireless remote control

→P.141

#### ■ If the smart access system with push-button start or the wireless remote control does not operate properly

Use the mechanical key to lock and unlock the doors. (→P.549)

Replace the key battery with a new one if it is depleted. (→P.501)

#### ■ If the 12-volt battery is discharged

The doors cannot be locked and unlocked using the smart access system with push-button start or wireless remote control. Lock or unlock the doors using the mechanical key. (→P.549)

### ■ Rear seat reminder function

As the first reminder so as not to forget luggage, etc. in the rear seat, when the power switch is turned off after any of the following conditions are met, a buzzer will sound and a message will be displayed on the multi-information display for approximately 6 seconds.

Also, as the second reminder, when the doors are locked, a buzzer will sound and the emergency flashers will flash for a few seconds, and a message will be displayed on the multi-information display

- The hybrid system is started within approximately 10 minutes after opening and closing a rear door.
- A rear door has been opened and closed after the hybrid system was started.

The second reminder will not be activated if a rear door was opened before the doors are locked.

However, if a rear door is opened and then closed within approximately 2 seconds, the rear seat reminder function may not operate.

The rear seat reminder function determines that luggage, etc. has been placed in a rear seat based on opening and closing of a rear door. Therefore, depending on the situation, the rear seat reminder function may not operate and you may still forget luggage, etc. in the rear seat, or it may operate unnecessarily.

### ■ Customization

Some functions can be customized. (→P.590)



### WARNING

#### ■ To prevent an accident

Observe the following precautions while driving the vehicle. Failure to do so may result in a door opening and an occupant falling out, resulting in death or serious injury.

- Ensure that all doors are properly closed and locked.

- Do not press an inside door opener switch while driving.

Be especially careful with the front doors, as it can be opened even when the doors are locked

- Set the rear door child-protector locks when children are seated in the rear seats.

#### ■ When opening or closing a door

When closing a door, swing it closed with slight force applied to it. If you press on the door by hand to close it, it may not be closed completely.

Check the surroundings of the vehicle such as whether the vehicle is on an incline, whether there is enough space for a door to open and whether a strong wind is blowing. When opening or closing the door, hold the door handle tightly to prepare for any unpredictable movement.

## Unlocking and locking the doors from the inside

### ■ Door lock switches (to lock/unlock)

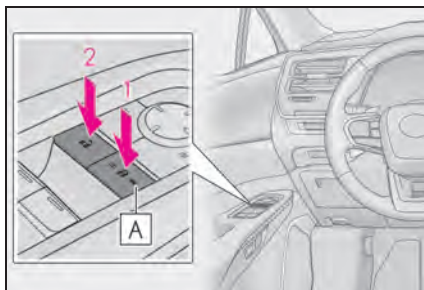

- 1 Driver's door: Locks all the doors  
Doors other than the driver's door: Locks the doors

The indicator **A** comes on.

- 2 Driver's door: Unlocks all the doors  
Doors other than the driver's door:

Unlocks the doors

The indicator **A** turns off.

### Opening the doors from outside the vehicle

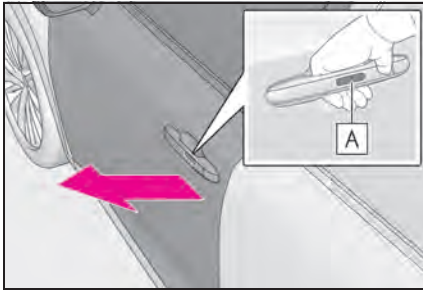

Press the door opener switch **A** of the door handle to open the door.

Make sure to securely press the door opener switch **A** on the inner side of the door handle

#### ■ If the 12-volt vehicle battery is discharged

The doors cannot be locked or unlocked using the smart access system with push-button start or wireless remote control, and the door opener switches will not operate.

Use the mechanical key to enable/disable manual release handle operation. By enabling manual release handle operation, the door can be opened. (→P.551)

### Opening the doors from inside the vehicle

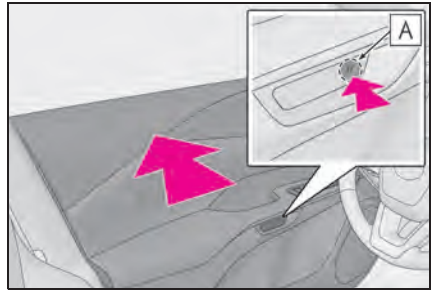

Press the front side of the door opener switch **A** to open the door.

Driver's door: The door will open even if it is locked.

When the door is unlocked, the door lock indicator will turn off.

#### ■ Inside door opener switch operating conditions

When any of the following conditions are met:

- The vehicle speed is less than 2.5 mph (4 km/h) and the parking brake is engaged
- The vehicle speed is less than 2.5 mph (4 km/h) and the brake pedal is depressed
- The shift position is in P

#### ■ When opening a door from inside the vehicle

If the door is not fully unlatched, press the door opener switch twice to open the door.

#### ■ Manual release handles inside the vehicle

The door opener switches inside the vehicle can also be used to manually open the doors.

A door can be opened through electronic operation by pressing the door opener switch, or it can be opened using the door opener switch as a manual release handle and pulling it twice.

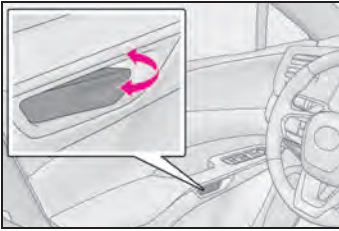

### Rear door child-protector lock

The door cannot be opened from inside the vehicle when the lock is set.

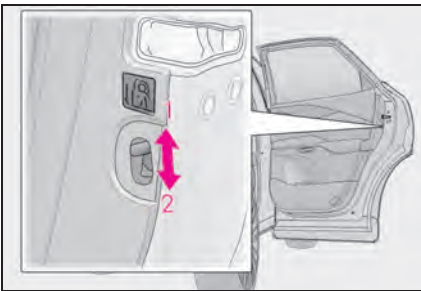

- 1 Unlock
- 2 Lock

These locks can be set to prevent children from opening the rear doors. Push down on each rear door switch to lock both rear doors.

### Automatic door locking and unlocking systems

The following functions can be set or canceled:

For instructions on customizing, refer to P.590.

Function	Operation
Shift position linked door locking function	All doors are automatically locked when shifting the shift position out of P.
Shift position linked door unlocking function	All doors are automatically unlocked when shifting the shift position to P.
Driver's door linked door unlocking function	All doors are automatically unlocked when driver's door is opened.

## Power back door

The power back door can be opened using the power back door opener switch, smart access system with push-button start or wireless remote control.



### WARNING

Observe the following precautions. Failure to do so may result in death or serious injury.

#### ■ Before driving the vehicle

Before driving the vehicle, make sure that the power back door is fully closed. If the power back door is not fully closed, it may open unexpectedly while driving, causing an accident.

#### ■ Caution while driving

- Keep the power back door closed while driving.

If the power back door is left open, it may hit nearby objects while driving or luggage may be unexpectedly thrown out, causing an accident.

In addition, exhaust gases may enter the vehicle, causing death or a serious health hazard. Make sure to close the power back door before driving.

- Never let anyone sit in the luggage compartment. In the event of sudden braking, sudden swerving or a collision, they are susceptible to death or serious injury.

#### ■ When children are in the vehicle

Observe the following precautions. Failure to do so may result in death or serious injury.

- Do not allow children to play in the luggage compartment.

If a child is accidentally locked in the luggage compartment, they could have heat exhaustion or other injuries.

- Do not allow a child to open or close the power back door.

Doing so may cause the power back door to move unexpectedly, or cause the child's hands, arms, head, or neck to be caught by the closing power back door.

#### ■ Operating the power back door

Observe the following precautions. Failure to do so may cause parts of the body to be caught, resulting in death or serious injury.

- Remove any heavy loads, such as snow and ice, from the power back door before opening it. Failure to do so may cause the power back door to suddenly shut again after it is opened.
- When opening or closing the power back door, thoroughly check to make sure the surrounding area is safe.
- If anyone is in the vicinity, make sure they are safe and let them know that the power back door is about to open or close.
- Use caution when opening or closing the power back door in windy weather as it may move abruptly in strong wind.

### ⚠ WARNING

- The power back door may suddenly shut if it is not opened fully. It is more difficult to open or close the back door on an incline than on a level surface, so beware of the back door unexpectedly opening or closing by itself. Make sure that the back door is fully open and secure before using the luggage compartment.



- When closing the power back door, take extra care to prevent your fingers, etc., from being caught.



- When closing the power back door, make sure to press it lightly on its outer surface. If the back door handle is used to fully close the power back door, it may result in hands or arms being caught.
- Do not pull on the back door spindle (→P.136) to close the power back door, and do not hang on the back door spindle.

Doing so may cause hands to be caught or the back door spindle to break, causing an accident.

- If a bicycle carrier or similar heavy object is attached to the power back door, it may suddenly shut again after being opened, causing someone's hands, arms, head or neck to be caught and injured. When installing an accessory part to the power back door, using a genuine Lexus part is recommended.

### Unlocking and locking the power back door from the outside

#### ■ Smart access system with push-button start

Carry the electronic key to enable this function.

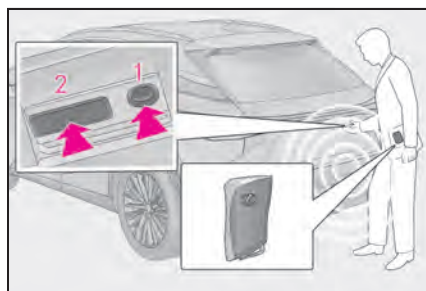

#### 1 Locks all the doors

Check that the door is securely locked.

#### 2 Unlocks all the doors

The doors cannot be unlocked for 3 seconds after the doors are locked.

#### ■ Wireless remote control

→P.115

### Unlocking and locking the power back door from the inside

#### ■ Door lock switch

→P.121

## Opening/closing the power back door

### ■ Opening/closing the power back door using the wireless remote control

Press and hold the switch for approximately 1 second.

The power back door can be operated whether it is locked\* or unlocked.

Pressing the switch while the power back door is opening/closing will stop the operation.

Pressing and holding the switch again for approximately 1 second will operate the power back door in the opposite direction.

\*: Opening of the power back door when it is locked can be disabled by a customized setting.



### ■ Opening/closing the power back door from the inside

Press and hold the switch for approximately 1 second.

A buzzer will sound and the power back door will automatically open or close. However, if the power back door is locked, it will not open.

Pressing the switch while the power back door is opening/closing will stop the operation.

Pressing and holding the switch again for approximately 1 second will operate the power back door in the opposite direction.

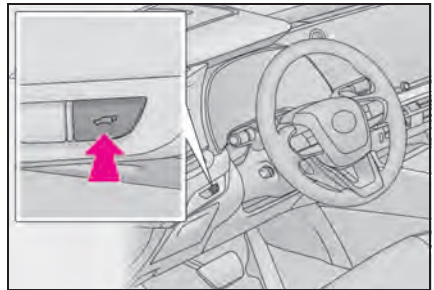

### ■ Back door opener switch

#### ● Open

When the power back door is unlocked:  
Press the back door opener switch.

When the power back door is locked:  
While carrying an electronic key, press and hold the back door opener switch.

A buzzer will sound and the power back door will automatically open.

Pressing the switch while the power back door is opening/closing will stop the operation.

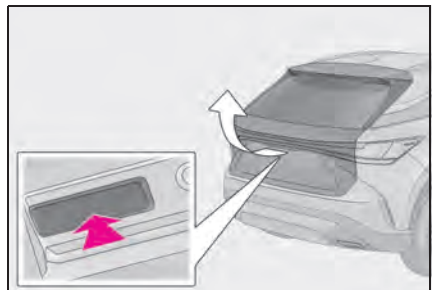

#### ● Close

Press the  switch.

A buzzer will sound and the power back door will automatically close.

Pressing the  switch while the power back door is closing will stop the operation.

Pressing the switch again will open the power back door automatically.

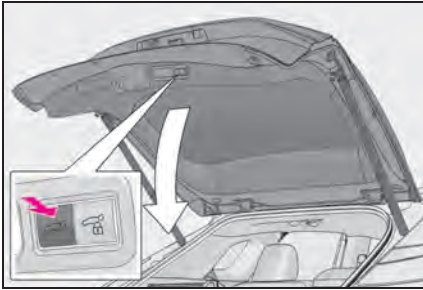

- Close the back door and lock all doors after moving away from the back door (close & lock [Walk-Away] function)
- 1 Close all of the doors except the back door, carrying an electronic key and press the  switch on the lower part of the back door.

A different buzzer than the normal one will sound and the close & lock (Walk-Away) function will go into standby.

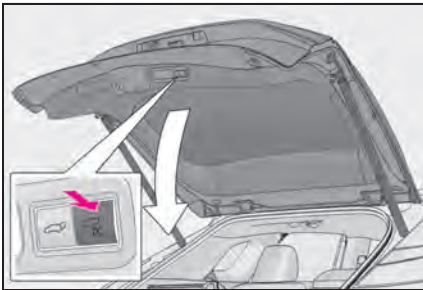

- 2 While the buzzer is sounding, move away from the back door.

When the sensor detects that you are away from the back door, the emergency flashers will flash, and the buzzer will sound. Depending on the direction of moving away from the back door, the location and how to hold the electronic key or circumstances, it may not be detected properly.

All the doors other than the back door will be locked, and after the back door is

closed, the back door will also be locked. When all the doors have been closed and locked, the buzzer (if equipped) will sound and the emergency flashers will flash.

The standby state is canceled if you do not move away from the back door for 30 seconds. To operate the function again, perform the procedure again from the beginning.

If you approach the back door carrying the electronic key, the back door operation will stop, all the doors will be unlocked, and the buzzer (if equipped) will sound and the emergency flashers will flash.

If the  switch is pressed after the back door operation has stopped, the close & lock (Walk-Away) function will go into standby again.

- Close the back door and lock all doors (close & lock function)\*

\*: This setting can be customized by your Lexus dealer.

Press the  switch.

The power back door will close and all of the doors will be locked at the same time.

A different buzzer than the normal one will sound and the power back door will begin closing automatically. When the power back door is closed, all of the doors will lock simultaneously and operation signals will indicate that all of the doors have been locked.

If the  switch is pressed while the power back door is closing, the operation will stop.

Pressing the switch again will open the power back door automatically.

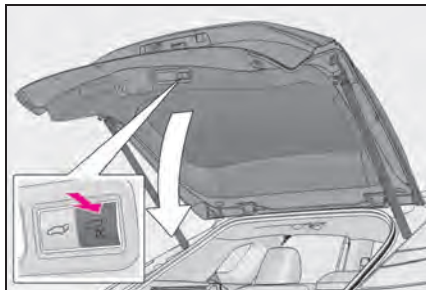

### ■ Closing the power back door using the back door handle

Lower the power back door using the back door handle, then a buzzer will sound and the power back door will automatically close.

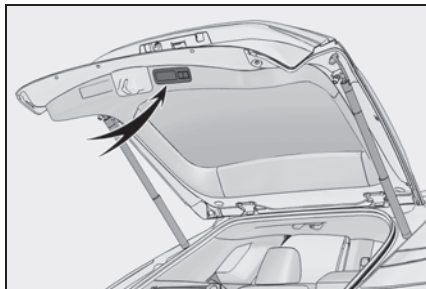

### ■ Hands Free Power Back Door (if equipped)

1 While carrying an electronic key, stand within the smart access system with push-button start operation range, approximately 19.7 to 23.6 in. (50 to 60 cm) from the rear bumper.

#### ▶ Type A

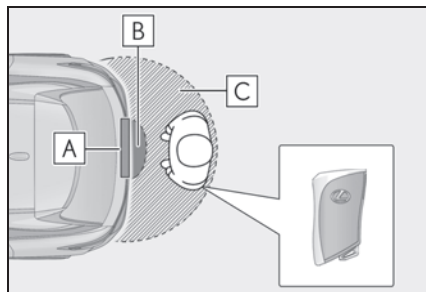

**A** Kick sensor

**B** Hands Free Power Back Door operation detection area

**C** Smart access system with push-button start operation detection area (→P.140)

#### ▶ Type B

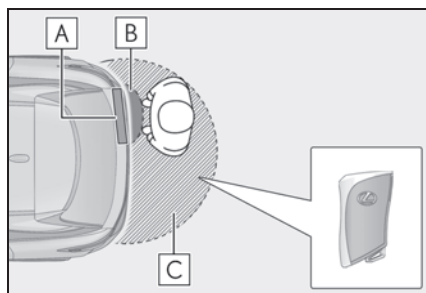

**A** Kick sensor

**B** Hands Free Power Back Door operation detection area

**C** Smart access system with push-button start operation detection area (→P.140)

2 Perform a kick operation by moving your foot to within approximately 3.9 in. (10 cm) of the rear bumper and then pulling your foot back after the buzzer sounds.

● Perform the entire kick operation

within 1 second.

- The Hands Free Power Back Door will not start operating while a foot is detected under the rear bumper.
- Operate the Hands Free Power Back Door without contacting the rear bumper with your foot.
- If another electronic key is in the cabin or luggage compartment, it may take slightly longer than normal for the operation to occur.
- If the buzzer sounds twice, perform a kick operation again.

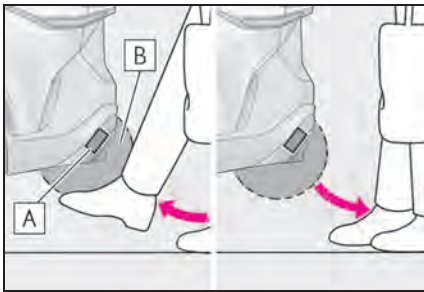

- A** Kick sensor
  - B** Hands Free Power Back Door operation detection area
- 3** When the kick sensor detects that your foot is pulled back, a buzzer will sound and the power back door will automatically fully open/close.

If kick operation is performed again in the middle of back door operating, the operation will stop.

- **Closing and locking the back door after moving away from the back door using the kick sensor (Hands Free close & lock [Walk-Away] function)** \*1,2

\*1: If equipped

\*2: This setting can be customized by your Lexus dealer.

- 1** While carrying an electronic key, stand within the smart access system with push-button start operation range, approximately 19.7 to 23.6 in. (50 to 60 cm) from the rear bumper.

► Type A

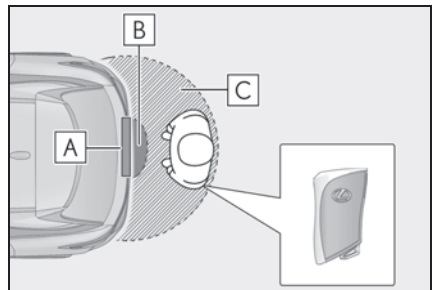

- A** Kick sensor
- B** Hands Free Power Back Door operation detection area
- C** Smart access system with push-button start operation detection area (→P.140)

► Type B

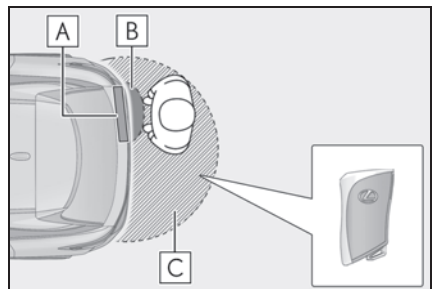

- A** Kick sensor
- B** Hands Free Power Back Door operation detection area
- C** Smart access system with

push-button start operation detection area (→P.140)

- 2 Perform a kick operation by moving your foot to within approximately 3.9 in. (10 cm) of the rear bumper and then pulling your foot back after the buzzer sounds.
  - Perform the entire kick operation within 1 second.
  - The Hands Free Power Back Door will not start operating while a foot is detected under the rear bumper.
  - Operate the Hands Free Power Back Door without contacting the rear bumper with your foot.
  - If another electronic key is in the cabin or luggage compartment, it may take slightly longer than normal for the operation to occur.
  - If the buzzer sounds twice, perform a kick operation again.

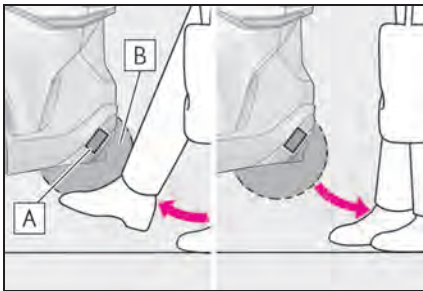

- A** Kick sensor
- B** Hands Free Power Back Door operation detection area
- 3 When the kick sensor detects that your foot is pulled back, a different buzzer than the normal one will sound and the Hands Free close &

lock (Walk-Away) function will go into standby.

- 4 While the buzzer is sounding, move away from the back door.

When the sensor detects that you are away from the back door, the emergency flashers will flash, and the buzzer will sound. Depending on the direction of moving away from the back door, the location and how to hold the electronic key or circumstances, it may not be detected properly.

All the doors other than the back door will be locked, and after the back door is closed, the back door will also be locked. When all the doors have been closed and locked, the buzzer (if equipped) will sound and the emergency flashers will flash.

The standby state is canceled if you do not move away from the back door for 30 seconds. To operate the function again, perform the procedure again from the beginning.

If you approach the back door carrying the electronic key, the back door operation will stop, all the doors will be unlocked, and the buzzer (if equipped) will sound and the emergency flashers will flash.

If the power back door is operated after the back door operation has stopped, the Hands Free close & lock (Walk-Away) function will go into standby again.

#### ■ Luggage compartment lights

- The luggage compartment lights turn on when the back door is opened.
- When the power switch is turned off, the lights will go off automatically after 20 minutes.

#### ■ Back door closer

In the event that the power back door is left slightly open, the back door closer will automatically close it to the fully closed position.

- The back door closer can function when the power switch is in any mode.
- The power back door can be opened using the back door opener switch even if the back door closer is operating.

### ■ Power back door operating conditions

If the following conditions are met with the power back door operation enabled, the power back door can be opened and closed automatically.

- When an electronic key is being carried and the back door opener switch is pressed\*
- When the wireless remote control is used\*
- When the power switch is in ON, the vehicle speed must be lower than 2 mph (3 km/h) and one of the following conditions must be met in addition to the above conditions:
  - The parking brake is engaged.
  - The brake pedal is depressed.
  - The shift position is in P.

\* : When the operation of the power back door when it is locked has been disabled by a customized setting, operate the power back door after it has been unlocked.

### ■ Operation of the power back door

- When the power back door begins to operate, the emergency flashers will flash and a buzzer will sound.
- When the power back door is disabled, the power back door will not operate but can be opened and closed manually.
- The power back door turns to manual operation when the back door opener switch is pressed while the power back door is in an automatic opening/closing operation.
- If anything obstructs the power back door while opening, a buzzer will sound and the power back door will stop immediately. If anything obstructs the power back door while closing, a buzzer will sound and the power back door will automatically move slightly in the opposite direction and then stop.

### ■ Jam protection function

Sensors are installed in the right and left sides of the power back door. When the door is automatically closing and the sen-

sors are pushed due to an object being caught, etc., the jam protection function will operate.

From that position the door will automatically move a little in the opposite direction and then the function will stop.

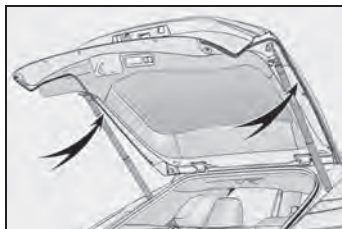

### ■ Fall-down protection function

While the power back door is opening automatically, applying excessive force to it will stop the opening operation to prevent the power back door from suddenly shutting.

### ■ Back door closing assist

If the back door is lowered manually when the back door is stopped at an open position, the back door will fully close automatically.

### ■ Back door reserve lock function

This function reserves the locking of the power back door when the power back door is open. If the following operations are performed, all of the doors except the power back door will lock and then the power back door will lock when it is completely closed.

- 1 Close all of the doors, except the power back door.
- 2 Perform an automatic closing operation of the power back door and lock the doors using the wireless remote control (→P.115) or smart access system with push-button start (→P.119) while the power back door is closing.

Operation signals will indicate that all the doors have been closed and locked. (→P.120)

- If the electronic key is placed inside the vehicle after starting a close operation via the door reserve lock function, the electronic key may become locked inside the vehicle.

- If the back door does not fully close due to the operation of the jam protection function, etc., while the back door is automatically closing after a reserve lock operation is performed, the reserve lock function is canceled and all the doors will unlock.
- Before leaving the vehicle, make sure that all the doors are closed and locked.

#### ■ Close & lock (Walk-Away) function operating conditions

This function can be operated when all of the following conditions are met:

- Close & lock (Walk-Away) function is enabled.
- An electronic key is not detected within the vehicle.
- All of the doors other than the power back door are closed.
- The brake pedal is not depressed.
- The power switch is off.
- The electronic key is within the effective range (detection areas).

#### ■ Situations in which the close & lock (Walk-Away) function may not operate properly

In the following situations, the function may not operate properly:

- When the smart access system with push-button start does not operate properly.
- When the close & lock function does not operate properly.
- When moving away from the back door while the close & lock (Walk-Away) function is in the standby state.

#### ■ Close & lock function\* operating conditions



This function can be operated when all of the following conditions are met:

- An electronic key is not detected within the vehicle.
- All of the doors other than the power back door are closed.
- The power switch is off.

\*: This setting can be customized by your Lexus dealer.

#### ■ Situations in which the close & lock function\* may not operate properly

In the following situations, the close & lock function may not operate properly:

- If the  switch on the lower part of the power back door (→P.126) is pressed by a hand which is holding an electronic key
- If the  switch on the lower part of the power back door (→P.126) is pressed when the electronic key is in a bag, etc. that is placed on the ground
- If the  switch on the lower part of the power back door (→P.126) is pressed with the electronic key not near the vehicle.

\*: This setting can be customized by your Lexus dealer.

#### ■ Hands Free Power Back Door operating conditions (if equipped)

- The Hands Free Power Back Door (kick sensor) setting is on.
- When an electronic key is carried within the operation range.

#### ■ Situations in which the Hands Free Power Back Door may not operate properly (if equipped)

In the following situations, the Hands Free Power Back Door may not operate properly:

- When a foot remains under the rear bumper
- If the rear bumper is strongly hit with a foot or is touched for a while  
If the rear bumper has been touched for a while, wait for a short time before attempting to operate the Hands Free Power Back Door again.
- When standing excessively close to the rear bumper
- When an external radio wave source interferes with the communication between the electronic key and the vehicle (→P.141)

- When the vehicle is parked near metal, or an external radio wave or electrical noise source which affects the sensitivity of the Hands Free Power Back Door, such as a pay parking spot, gas station, electrically heated road, fluorescent light, or metal plate
- When the vehicle is near a TV tower, electric power plant, radio station, large display, airport or other facility that generates strong radio waves or electrical noise
- When a large amount of water is applied to the rear bumper, such as when the vehicle is being washed or in heavy rain
- When mud, snow, ice, etc. is attached to the rear bumper
- When the vehicle has been parked for a while near objects that may move and contact the rear bumper, such as plants
- When an accessory is installed to the rear bumper

If an accessory has been installed, turn the Hands Free Power Back Door (kick sensor) operation setting off.

#### ■ Preventing unintentional operation of the Hands Free Power Back Door (if equipped)

When an electronic key is in the operation detection area, the Hands Free Power Back Door may operate unintentionally, so be careful in the following situations:

- When a large amount of water is applied to the rear bumper, such as when the vehicle is being washed or in heavy rain
- When dirt is wiped off the rear bumper
- When a small animal or small object, such as a ball, moves under the rear bumper
- When an object is moved from under the rear bumper
- If someone is swinging their legs while sitting on the rear bumper
- If the legs or another part of someone's body contacts the rear bumper while passing by the vehicle
- When the vehicle is parked near an electrical noise source which affects the sensitivity of the Hands Free Power Back

Door, such as a pay parking spot, gas station, electrically heated road, or fluorescent light

- When the vehicle is near a TV tower, electric power plant, radio station, large display, airport or other facility that generates strong radio waves or electrical noise
- When the vehicle is parked in a place where objects such as plants are near the rear bumper
- If luggage, etc. is set near the rear bumper
- If accessories or a vehicle cover is installed/removed near the rear bumper
- When the vehicle is being towed

To prevent unintentional operation, turn the Hands Free Power Back Door (kick sensor) operation setting off.

#### ■ Hands Free close & lock (Walk-Away) function<sup>\*1</sup> operating conditions

This function can be operated when all of the following conditions are met:

- Hands Free close & lock (Walk-Away) function is enabled<sup>\*2</sup>.
- Hands Free Power Back Door<sup>\*1</sup> is enabled.
- An electronic key is not detected within the vehicle.
- All of the doors other than the back door are closed.
- The brake pedal is not depressed.
- The power switch is off.
- The electronic key is within the effective range (detection areas).

<sup>\*1</sup>: If equipped

<sup>\*2</sup>: This setting can be customized by your Lexus dealer.

#### ■ Situations in which the Hands Free close & lock (Walk-Away) function<sup>\*1,2</sup> may not operate properly

In the following situations, the function may not operate properly:

- When the smart access system with

push-button start does not operate properly.

- When the close & lock function does not operate properly.
- When moving away from the back door while the Hands Free close & lock (Walk-Away) function is in the standby state.
- When the Hands Free Power Back Door does not operate properly.\*<sup>1</sup>

\*<sup>1</sup>: If equipped

\*<sup>2</sup>: This setting can be customized by your Lexus dealer.

#### ■ If the power back door stops the automatic operation

When the automatic operation of the power back door is enabled and the power back door is left open for a long time, it may stop the automatic operation.

To re-enable the automatic operation, fully close the power back door manually.

#### ■ When reconnecting the 12-volt battery

To operate the power back door properly, close the back door completely by hand then operate for unlocking.

#### ■ If the power back door opener is inoperative

The power back door can be unlocked from the inside

#### 1 Remove the cover.

To prevent damage, cover the tip of the screwdriver with a rag.

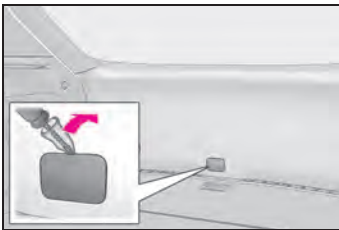

#### 2 Loosen the screw.

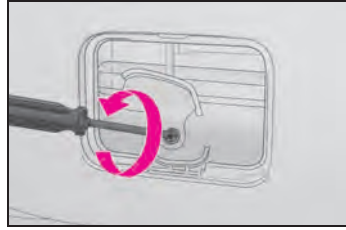

#### 3 Turn the cover.

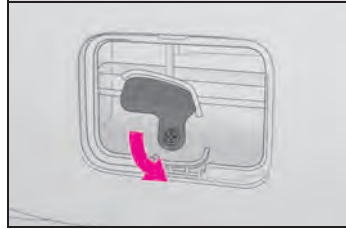

#### 4 Move the lever.

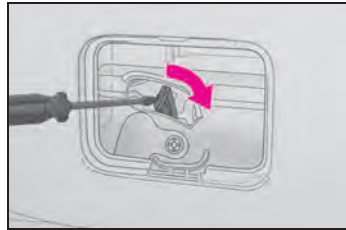

#### 5 When installing, reverse the steps listed.

#### ■ Customization

Some functions can be customized. (→P.590)

**WARNING****Back door closer**

- In the event that the power back door is left slightly open, the back door closer will automatically close it to the fully closed position. It takes several seconds before the back door closer begins to operate. Be careful not to get fingers caught or anything else in the power back door, as this may cause bone fractures or other serious injuries.



- Use caution when using the back door closer as it still operates when the power back door system is disabled.

**Power back door**

Observe the following precautions when operating the power back door. Failure to do so may cause death or serious injury.

- Check the safety of the surrounding area to make sure there are no obstacles or anything that could cause any of your belongings to get caught.
- If anyone is in the vicinity, make sure they are safe and let them know that the power back door is about to open or close.
- If the power back door system is disabled while the power back door is operating, the power back door will stop operating. The power back door must then be operated manually. Take extra care in this situation, as the power back door may open or close suddenly.

- If the operating conditions of the power back door (→P.131) are no longer met, a buzzer may sound and the power back door may stop opening or closing. The power back door must then be operated manually. Take extra care on an incline in this situation, as the power back door may move suddenly.

- On an incline, the power back door may suddenly shut after it opens. Make sure the power back door is fully open and secure.

- In the following situations, the power back door may detect an abnormality and automatic operation may be stopped. In this case, the power back door must then be operated manually. Take extra care in this situation, as the stopped power back door may suddenly open or close, causing an accident.

- When the power back door contacts an obstacle

- When the 12-volt battery voltage suddenly drops, such as when the power switch is turned to ON or the hybrid system is started during automatic operation

- If a bicycle carrier or similar heavy object is attached to the power back door, the power back door may not operate, causing a malfunction, or the power back door may suddenly shut again after being opened, causing someone's hands, arms, head or neck to be caught and injured. When installing an accessory part to the power back door, using a genuine Lexus part is recommended.

**Jam protection function**

Observe the following precautions. Failure to do so may cause death or serious injury.

- Never use any part of your body to intentionally activate the jam protection function.

### WARNING

- The jam protection function may not work if something gets caught just before the power back door fully closes. Be careful not to get fingers caught or anything else.
  - The jam protection function may not work depending on the shape of the object that is caught. Be careful not to catch fingers or anything else.
- **Hands Free Power Back Door (if equipped)**

Observe the following precautions. Failure to do so may cause death or serious injury.

- Check the safety of the surrounding area to make sure there are no obstacles or anything that could cause any of your belongings to get caught.
  - Exhaust gasses cause the exhaust pipes to become quite hot. When operating the Hands Free Power Back Door, be careful not to touch the exhaust pipe.
  - Do not operate the Hands Free Power Back Door if there is little space under the rear bumper.
- **Close & lock (Walk-Away) function and Hands Free close & lock (Walk-Away) function<sup>\*1,2</sup>**

\*1: If equipped

\*2: This setting can be customized by your Lexus dealer.

The back door starts to close automatically when leaving the back door. Check the safety of the surrounding area to make sure there are no obstacles or anything that could cause any of your belongings to get caught.

### NOTICE

#### ■ Back door spindles

The power back door is equipped with spindles **A** that hold the power back door in place.

Observe the following precautions.

Failure to do so may cause damage to the back door spindle **A**, resulting in malfunction.

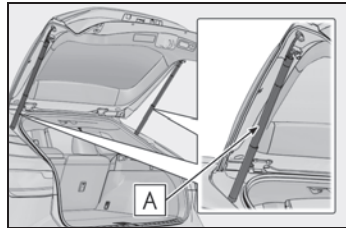

- Do not attach any foreign objects, such as stickers, plastic sheets, or adhesives to the spindle rod.
  - Do not attach any accessories other than genuine Lexus parts to the power back door.
  - Do not place your hand on the spindle or apply lateral forces to it.
- **To prevent back door closer malfunction**
- Do not apply excessive force to the power back door while the back door closer is operating. Applying excessive force may cause the back door closer to malfunction.
  - If the power back door is opened and closed repeatedly in a short amount of time, the back door closer may stop operating. In this case, manually open the power back door once and wait for a while before attempting to close it again.

**NOTICE****■ To prevent malfunction of the power back door**

- Make sure that there is no ice between the power back door and frame that would prevent movement of the power back door. Operating the power back door when excessive load is present on the power back door may cause a malfunction.
- Do not apply excessive force to the power back door while the power back door is operating.
- Take care not to damage the sensors installed on the right and left edges of the power back door (→P.131) with a knife or other sharp object. If a sensor is disconnected, the power back door will not close automatically.

**■ Close & lock function \***

\* : This setting can be customized by your Lexus dealer.

When closing the power back door using the close & lock function, a different buzzer than the normal one will sound before the operation begins.

To check that the operation has started correctly, check that a different buzzer than the normal one has sounded.

Additionally, when the power back door is fully closed and locked, operation signals will indicate that all of the doors have been locked.

Before leaving the vehicle, make sure that the operational signals have operated and that all of the doors are locked.

**■ Hands Free Power Back Door precautions (if equipped)**

The kick sensor is located behind lower center part of the rear bumper. Observe the following to ensure that the Hands Free Power Back Door function operates properly:

- Keep the lower center part of the rear bumper clean at all times.

If the lower center part of the rear bumper is dirty or covered with snow, the Hands Free Power Back Door may not operate. In this situation, clean off the dirt or snow, move the vehicle from the current position and then check if the Hands Free Power Back Door operates. If it does not operate, have the vehicle inspected by your Lexus dealer.

- Do not apply coatings that have a rain clearing (hydrophilic) effect, or other coatings, to the lower center part of the rear bumper.
- Do not park the vehicle near objects that may move and contact the lower center part of the rear bumper, such as grass or trees.

If the vehicle has been parked for a while near objects that may move and contact the lower center part of the rear bumper, such as grass or trees, the Hands Free Power Back Door may not operate. In this situation, move the vehicle from the current position and then check if the Hands Free Power Back Door operates. If it does not operate, have the vehicle inspected by your Lexus dealer.

- Do not subject the rear bumper or its surrounding area to a strong impact.

If the rear bumper or its surrounding area has been subjected to a strong impact, the Hands Free Power Back Door may not operate properly.

If the Hands Free Power Back Door does not operate in the following situations, have the vehicle inspected by your Lexus dealer.

- The kick sensor or its surrounding area has been subjected to a strong impact.
- The lower center part of the rear bumper is scratched or damaged.
- Do not disassemble the rear bumper.
- Do not attach stickers to the rear bumper.



## NOTICE

- Do not paint the rear bumper.
- If a bicycle carrier or similar heavy object is attached to the power back door, disable the Hands Free Power Back Door (kick sensor).

### Canceling the power back door system

The power back door system can be enabled/disabled on the center display. (→P.590)

- 1 Select  on the center display.
- 2 Select "Vehicle customize".
- 3 Select "Door control".
- 4 Select "Power back door".
- 5 Select  (ON)/  
 (OFF).

When OFF is selected and the operations of the power back door is made to stop from the center display, unless it is set to ON, the operation of the power back door will not return. (No return in the power switch operation)

### Canceling the Hands Free Power Back Door (if equipped)

The Hands Free Power Back Door (kick sensor) can be enabled/disabled on the center display. (→P.590)

- 1 Select  on the center display.
- 2 Select "Vehicle customize".
- 3 Select "Door control".
- 4 Select "Hands free".

- 5 Select  (ON)/  
 (OFF).

When OFF is selected and the operations of the Hands Free Power Back Door is made to stop from the center display, unless it is set to ON, the operation of the Hands Free Power Back Door will not return. (No return in the power switch operation)

### Adjusting the open position of the power back door

The open position of the power back door can be adjusted.

- 1 Stop the power back door at the desired position. (→P.126)
- 2 Press and hold the  switch on the lower part of the power back door for 2 seconds.
  - When setting is complete, a buzzer will sound 4 times.
  - The next time the power back door is opened, it will stop at that position.

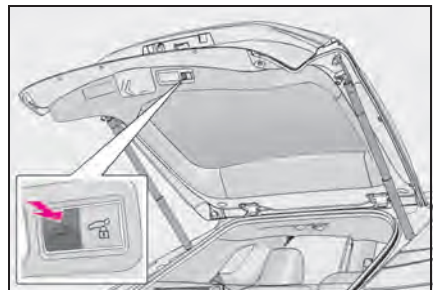

#### ■ Returning the power back door opening position to the default setting

Press and hold the  switch on the lower part of the power back door for 7 seconds.

After the buzzer sounds 4 times, it sounds

twice more. When the power back door does the opening operation the next time, the door will open to the initial settings position.

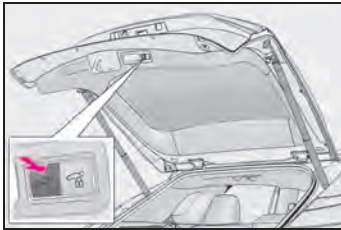

### ■ Customization

The opening position can be set with the center display.

Priority for the stop position is given to the last position set by either the  switch or center display.

(Customizable features: →P.590)

## Smart access system with push-button start

The following operations can be performed simply by carrying the electronic key on your person, for example in your pocket. The driver should always carry the electronic key.

- Locks and unlocks the doors (→P.119)
- Locks and unlocks the back door (→P.125)
- Starts and stops the hybrid system (→P.208)

### ■ Antenna location

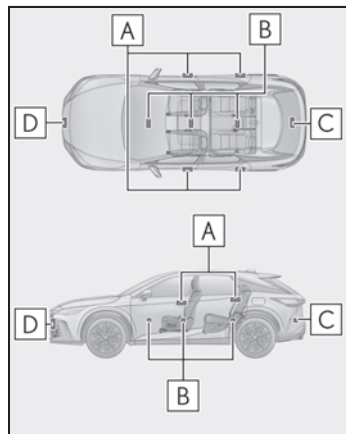

- A** Antennas outside the cabin
- B** Antennas inside the cabin
- C** Antenna outside the luggage compartment
- D** Antennas outside the cabin (Vehicles with Lexus Teammate Advanced Park system)

### ■ Effective range (areas within which the electronic key is detected)

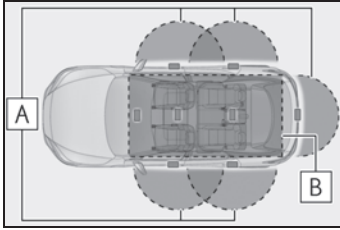

#### A When locking or unlocking the doors

The system can be operated when the electronic key is within about 2.3 ft. (0.7 m) of an outside door handle. (Only the doors detecting the key can be operated.)

#### B When starting the hybrid system or changing power switch modes

The system can be operated when the electronic key is inside the vehicle.

### ■ Alarms and warning messages

An alarm sounds and warning messages are displayed on the multi-information display to protect against unexpected accidents or theft of the vehicle resulting from erroneous operation. When a warning message is displayed, take appropriate measures based on the displayed message. (→P.526)

When only an alarm sounds, circumstances and correction procedures are as follows.

- When an exterior alarm sounds once for 5 seconds

Situation	Correction procedure
An attempt was made to lock the vehicle while a door was open.	Close all of the doors and lock the doors again.

- When an interior alarm sounds continuously

Situation	Correction procedure
The power switch was turned to ACC while the driver's door was open (The driver's door was opened when the power switch was in ACC).	Turn the power switch off and close the driver's door.

### ■ If "Key Detected in Vehicle" is shown on the multi-information display

An attempt was made to lock the doors using the smart access system with push-button start while the electronic key was still inside the vehicle. Retrieve the electronic key from the vehicle and lock the doors again.

### ■ Battery-saving function

The battery-saving function will be activated in order to prevent the electronic key battery and the 12-volt battery from being discharged while the vehicle is not in operation for a long time.

- In the following situations, the smart access system with push-button start may take some time to unlock the doors. Also the illuminated entry system may not operate properly.
  - The electronic key has been left in an area of approximately 11 ft. (3.5 m) of the outside of the vehicle for 10 minutes or longer.
  - The smart access system with push-button start has not been used for 5 days or longer.
- If the smart access system with push-button start has not been used for 14 days or longer, the doors cannot be unlocked at any doors except the driver's door. In this case, take hold of the driver's door handle, or use the wireless remote control or the mechanical key, to unlock the doors.

### ■ Turning an electronic key to battery-saving mode

When battery-saving mode is set, battery depletion is minimized by stopping the electronic key from receiving radio waves.

Press  twice while pressing and holding

 Confirm that the electronic key indicator flashes 4 times.

While the battery-saving mode is set, the smart access system with push-button start cannot be used. To cancel the function, press any of the electronic key buttons.



### ■ When electronic key function stops

If the position of the electronic key has not changed for a certain amount of time such as when the electronic key is left somewhere, the function of the electronic key stops to reduce depletion of the battery.

### ■ Conditions affecting operation

The smart access system with push-button start, wireless remote control and immobilizer system use weak radio waves. In the following situations, the communication between the electronic key and the vehicle may be affected, preventing the smart access system with push-button start, wireless remote control and immobilizer system from operating properly. (Ways of coping: →P.549)

- When the electronic key battery is depleted
- Near a TV tower, electric power plant, gas station, radio station, large display, airport or other facility that generates strong radio waves or electrical noise
- When the electronic key is in contact with, or is covered by the following metallic objects
  - Cards to which aluminum foil is attached
  - Cigarette boxes that have aluminum foil inside
  - Metallic wallets or bags
  - Coins
  - Hand warmers made of metal
  - Media such as CDs and DVDs
- When other wireless keys (that emit radio waves) are being used nearby

- When carrying the electronic key together with the following devices that emit radio waves
  - Portable radio, cellular phone, cordless phone or other wireless communication devices
  - Another vehicle's electronic key, another electronic key of your vehicle, or a wireless key that emits radio waves
  - Personal computers or personal digital assistants (PDAs)
  - Digital audio players
  - Portable game systems
- If window tint with a metallic content or metallic objects are attached to the rear window

- When the electronic key is placed near a battery charger or electronic devices
- When the vehicle is parked in a pay parking spot where radio waves are emitted

If the doors cannot be locked/unlocked using the smart access system with push-button start, lock/unlock the doors by performing any of the following:

- Bring the electronic key close to either front door handle and operate the entry function.
- Operate the wireless remote control.

If the doors cannot be locked/unlocked using the above methods, use the mechanical key. (→P.549)

If the hybrid system cannot be started using the smart access system with push-button start, refer to →P.550

### ■ Note for the entry function

- Even when the electronic key is within the effective range (detection areas), the system may not operate properly in the following cases:
  - The electronic key is too close to the window or outside door handle, near the ground, or in a high place when the doors are locked or unlocked.
  - The electronic key is on the instrument panel, luggage compartment, floor, or in the door pockets or glove box when the hybrid system is started or power switch modes are changed.
- Do not leave the electronic key on top of

the instrument panel or near the door pockets when exiting the vehicle. Depending on the radio wave reception conditions, it may be detected by the antenna outside the cabin and the door will become lockable from the outside, possibly trapping the electronic key inside the vehicle.

- As long as the electronic key is within the effective range, the doors may be locked or unlocked by anyone. However, only the doors detecting the electronic key can be used to unlock the vehicle.
- Even if the electronic key is not inside the vehicle, it may be possible to start the hybrid system if the electronic key is near the window.
- The doors may unlock if a large amount of water splashes on the door handle, such as in the rain or in a car wash when the electronic key is within the effective range. (The door will automatically be locked after approximately 60 seconds if the doors are not opened and closed.)
- If the wireless remote control is used to lock the doors when the electronic key is near the vehicle, there is a possibility that the door may not be unlocked by the entry function. (Use the wireless remote control to unlock the doors.)
- Touching the door lock sensor while wearing gloves may delay or prevent lock operation. Remove the gloves and touch the lock sensor again.
- When the lock operation is performed using the lock sensor, recognition signals will be shown up to two consecutive times. After this, no recognition signals will be given.
- If the door handle becomes wet while the electronic key is within the effective range, the door may lock and unlock repeatedly. In that case, follow the following correction procedures to wash the vehicle:
  - Place the electronic key in a location 6 ft. (2 m) or more away from the vehicle. (Take care to ensure that the key is not stolen.)
  - Set the electronic key to battery-saving mode to disable the smart access system

with push-button start. (→P.140)

- If the electronic key is inside the vehicle and a door handle becomes wet during a car wash, a message may be shown on the multi-information display and a buzzer will sound outside the vehicle. To turn off the alarm, lock all the doors.
- The lock sensor may not work properly if it comes into contact with ice, snow, mud, etc. Clean the lock sensor and attempt to operate it again.
- A sudden approach to the effective range or door handle may prevent the doors from being unlocked. In this case, return the door handle to the original position and check that the doors unlock before pulling the door handle again.
- If there is another electronic key in the detection area, it may take slightly longer to unlock the doors after the door handle is gripped.

#### ■ When the vehicle is not driven for extended periods

- To prevent theft of the vehicle, do not leave the electronic key within 6 ft. (2 m) of the vehicle.
- The smart access system with push-button start can be deactivated in advance.
- Setting the electronic key to battery-saving mode helps to reduce key battery depletion. (→P.140)

#### ■ To operate the system properly

Make sure to carry the electronic key when operating the system. Do not get the electronic key too close to the vehicle when operating the system from the outside of the vehicle.

Depending on the position and holding condition of the electronic key, the key may not be detected correctly and the system may not operate properly. (The alarm may go off accidentally, or the door lock prevention may not operate.)

#### ■ If the smart access system with push-button start does not operate properly

- If the doors cannot be locked or unlocked and the back door cannot be opened,

perform the following.

- Bring the electronic key close to the door handle and perform a lock or unlock operation.
- Bring the electronic key close to the button on the back door (→P.125) and press the button.
- Use the wireless remote control.

If the doors cannot be locked or unlocked by perform the above, use the mechanical key. (→P.549) However, if the mechanical key is used while the alarm system is set, the warning will sound. (→P.83)

- If the hybrid system cannot be started, refer to →P.550

### ■ Customization

Some functions can be customized. (→P.590)

#### ■ If the smart access system with push-button start has been deactivated in a customized setting

- Locking and unlocking the doors: Use the wireless remote control or mechanical key. (→P.119, 126, 549)
- Starting the hybrid system and changing power switch modes: →P.550
- Stopping the hybrid system: →P.208



### WARNING

#### ■ Caution regarding interference with electronic devices

- People with implantable cardiac pacemakers, cardiac resynchronization therapy-pacemakers or implantable cardioverter defibrillators should keep away from the smart access system with push-button start antennas. (→P.139)

The radio waves may affect the operation of such devices. If necessary, the entry function can be disabled. Ask your Lexus dealer for details, such as the frequency of radio waves and timing of the emitted radio waves. Then, consult your doctor to see if you should disable the entry function.

- Users of any electrical medical device other than implantable cardiac pacemakers, cardiac resynchronization therapy-pacemakers or implantable cardioverter defibrillators should consult the manufacturer of the device for information about its operation under the influence of radio waves. Radio waves could have unexpected effects on the operation of such medical devices.

Ask your Lexus dealer for details on disabling the entry function.

## Front seats

### **⚠** WARNING

#### ■ When adjusting the seat position

- Take care when adjusting the seat position to ensure that other passengers are not injured by the moving seat.
- Do not put your hands under the seat or near the moving parts to avoid injury. Fingers or hands may become jammed in the seat mechanism.
- Make sure to leave enough space around the feet so they do not get stuck.

#### ■ Seat adjustment

To reduce the risk of sliding under the lap belt during a collision, do not recline the seat more than necessary.

If the seat is too reclined, the lap belt may slide past the hips and apply restraint forces directly to the abdomen, or your neck may contact the shoulder belt, increasing the risk of death or serious injury in the event of an accident.

Adjustments should not be made while driving as the seat may unexpectedly move and cause the driver to lose control of the vehicle.

## Adjustment procedure

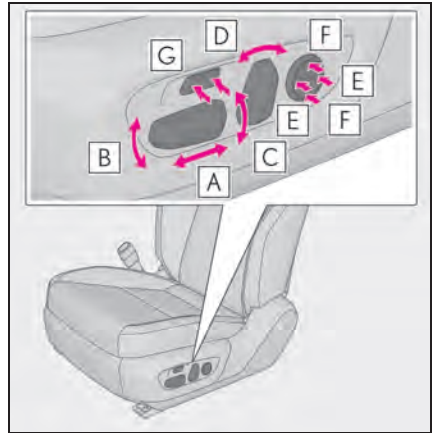

- A** Seat position adjustment switch
- B** Seat cushion (front) angle adjustment switch
- C** Vertical height adjustment switch
- D** Seatback angle adjustment switch
- E** Lumbar support firmness adjustment switch
- F** Lumbar support height adjustment switch (if equipped)
- G** Seat cushion length adjustment switch (if equipped)

#### ■ When adjusting the seat

- Make sure that any surrounding passengers or objects are not contact the seat.
- Make sure that the head restraint does not touch the ceiling or sun visor.

#### ■ Power easy access system (if equipped)

The driver's seat (on some models) and steering wheel move in accordance with power switch mode and the driver's seat belt condition. (→P.178)

#### ■ Jam protection function

While the driving position is recalled or the power easy access system is operating, if an

object is stuck behind the front seat, the front seat will stop and then slightly move forward. When the jam protection function operates, the seat stops at a position other than the set seat position. Check the seat position.

## Rear seats

### WARNING

#### ■ When folding down the rear seatbacks and when the rear seatbacks are folded

Observe the following precautions. Failure to do so may result in death or serious injury.

- Do not fold down the rear seatbacks while driving.
- Stop the vehicle on level ground, apply the parking brake and shift the shift lever to P.
- Do not allow anyone to sit on a folded rear seatback or in the luggage compartment while driving.
- Do not allow children to enter the luggage compartment.

#### ■ When operating the rear seatback

Observe the following precautions. Failure to do so may result in death or serious injury.

- Keep other passengers from being hit by the rear seatback.
- Do not put your hands between the seats or near the moving parts, or let any part of your body get caught.
- Power seat: Do not let children operate the rear seatback. Other passengers may get caught in the seat.
- Power seat: Check that there are no passengers sitting in a seat before folding it down. Do not let passengers sit in the seat while it is being folded down.

#### ■ Seat adjustment

To reduce the risk of sliding under the lap belt during a collision, do not recline the seat more than necessary.

### WARNING

If the seat is reclined excessively, the lap belt may slide past the hips and apply restraint forces directly to the abdomen, or your neck may contact the shoulder belt, increasing the risk of death or serious injury in the event of an accident.

#### ■ After returning the rear seatback to the upright position

Observe the following precautions. Failure to do so may result in death or serious injury.

- Make sure that the rear seatback is securely locked in position by lightly pushing it back and forth.
- Check that the seat belts are not twisted or caught between or behind in the rear seatback.
- Arrange the seat belts in the proper positions for ready use.

#### ■ Jam protection function (power seat)

Observe the following precautions. Failure to do so may result in death or serious injury.

- Never use any part of your body to intentionally activate the jam protection function.
- The jam protection function may not work if something gets caught just before the rear seatback is fully folded forward. Be careful not to get fingers or anything else caught.
- The jam protection function may not work depending on the shape of the object that is caught. Be careful not to get fingers or anything else caught.

### NOTICE

#### ■ Stowing the seat belts

The seat belt for the rear center seat, seat belt buckles and armrest must be stowed before you fold down the rear seatbacks. (→P.441)

## Adjustment procedure

### ► Manual seat

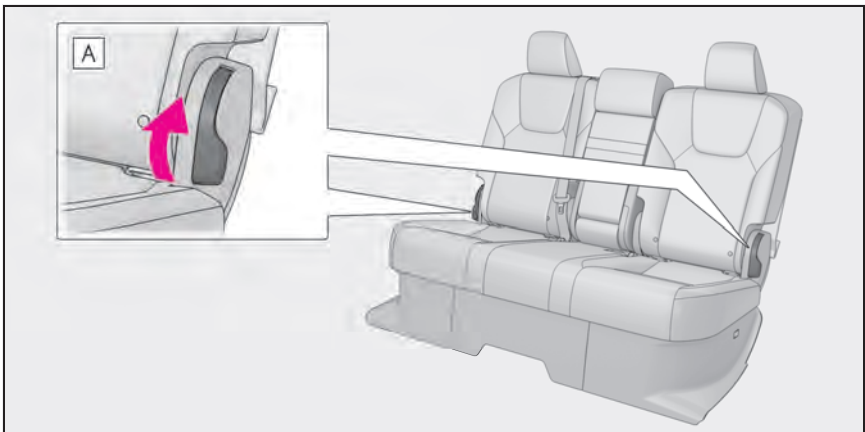

**A** Seatback angle adjustment lever

## ► Power seat

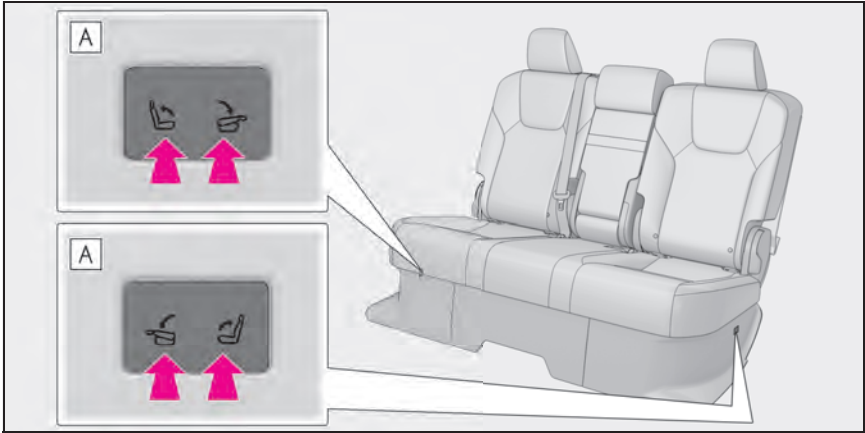
**A** Seatback angle adjustment switch

## ■ The rear seatbacks can be adjusted when (power seat)

When the rear seatback is in a position within the range **A** shown in the illustration, the rear seat operation switch (rear seat) can be used to adjust the rear seatback.

**B** is where the rear seatback is at its most upright position.

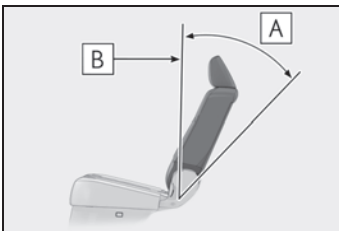

## ■ Fully reclining the rear seatback (power seat)

Operate the rear seat operation switch (rear seat) to recline the rear seatback and stop it partway. To set the rear seatback to the rearmost position, press the button again.

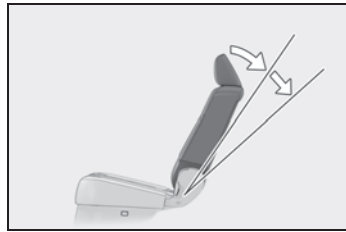
**Folding down the rear seatbacks**

## ■ Before folding down the rear seatbacks

- 1 Stow the rear seat belt and seat belt buckles.

Use the band to secure the center seat buckle.

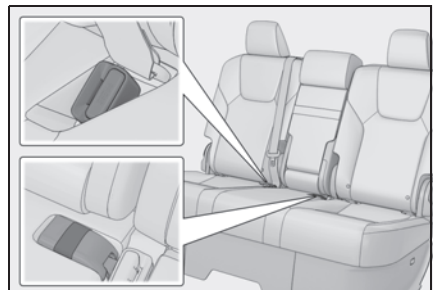

- 2 Lower the rear seat head restraints.  
(→P.152)

### ■ Folding down the rear seatbacks (manual seat)

- Using the seatback angle adjustment lever

Pull the seatback angle adjustment lever and fold down the rear seatback.

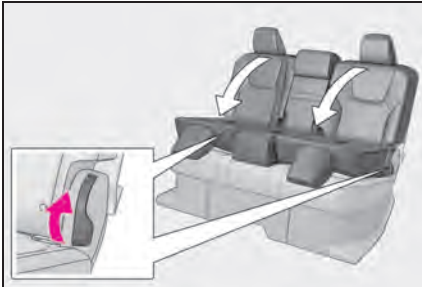

- Using the switch in the luggage compartment

Push the seatback angle adjustment switch and fold down the rear seatback.

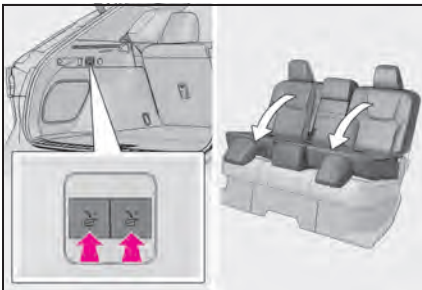

### ■ Folding down the rear seatbacks (power seat)

Press and hold the switch to fold down the rear seatback.

A buzzer will sound and then the operation will start. The buzzer will sound again when the operation is completed.

To stop the operation partway, press either

side of the rear seat operation switch of the operating seat. Any rear seat operation switch for the operating seat, regardless of location, can be used to stop the operation. (A buzzer may sound depending on the position that the rear seatback is stopped.)

- Rear seat operation switch (rear seat)

If the rear seatback is reclined, bring the rear seatback to the most upright position and press and hold the switch again.

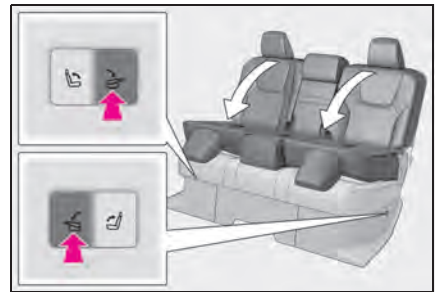

- Rear seat operation switch (luggage compartment)

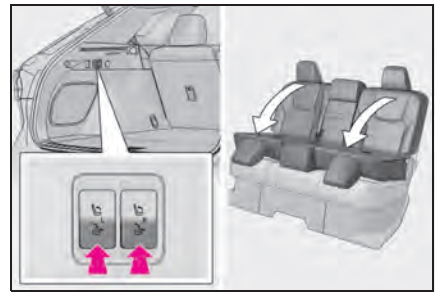

### ■ Returning the rear seatbacks (manual seat)

To avoid trapping the seat belt between the seat and the inside of the vehicle, pass the seat belt inside the seat belt guide **A** and then return the seatback securely to the locked position.

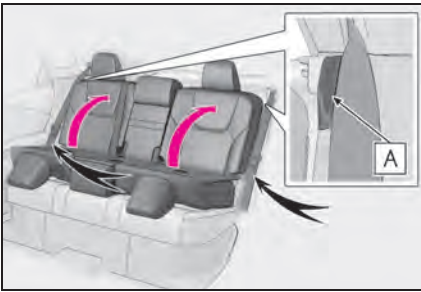

### ■ Returning the rear seatbacks (power seat)

- 1 When operating the rear seat seatback, put the seatbelt in the seatbelt guide **A**. Make sure that the seatbelt is not jammed between the seat and vehicle body.

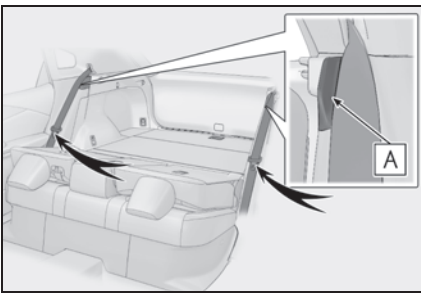

- 2 Press and hold the switch to return the rear seatback.

A buzzer will sound and then the operation will start. The buzzer will sound again when the operation is completed.

To stop the operation partway, press either side of the rear seat operation switch of the operating seat. Any rear seat operation switches for the operating seat, regardless of location, can be used to stop the operation. (A buzzer may sound depending on the position that the rear seatback is stopped.)

- ▶ Rear seat operation switch (rear seat)

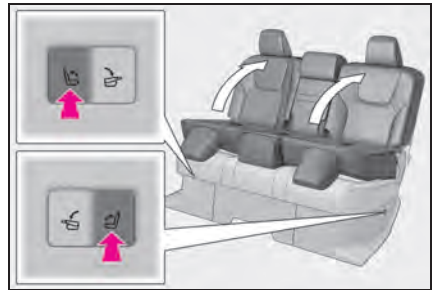

- ▶ Rear seat operation switch (luggage compartment)

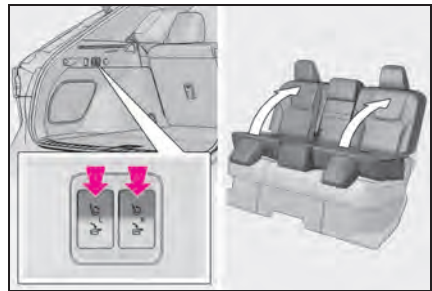

### ■ Folding down the rear center seatback

Pull the lock release lever behind the rear seatback and fold the rear seatback down.

To return the rear center seatback to its original position, lift it up until it locks.



- The power seat can be operated when the rear seatbacks can be folded down or

raised when the power switch is in either of the following modes:

- When the power switch is turned off or in ACC
- When the power switch is in ON and any of the following conditions are met:
  - The parking brake is engaged.
  - The brake pedal is depressed.
  - The shift position is in P.

■ **The rear seatbacks can be folded down when (power seat)**

When all of the following conditions are met, a rear seat operation switch can be used to fold down the rear seatback:

- When using the rear seat operation switch (rear seat): The rear seatback is in a position within the range **A** shown in the illustration with the back door open (**B** is where the rear seatback is at its most upright position)
- When using the rear seat operation switch (luggage compartment): When the back door is open.
- The other seat operation switch for the seat to be operated is not being pressed.

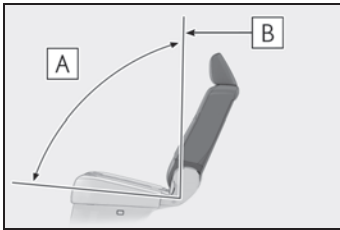

■ **The rear seatbacks can be raised when (power seat)**

When all of the following conditions are met, a rear seat operation switch can be used to return the rear seatback:

- When using the rear seat operation switch (rear seat): The rear seatback is in a position within the range **A** shown in the illustration with the rear door nearest to the seat to be operated open (**C** is where the rear seatback is at its most upright position)
- When using the rear seat operation switch (luggage compartment): The rear

seatback is in a position within the range **B** shown in the illustration with the back door open

- The other seat operation switch for the seat to be operated is not being pressed.

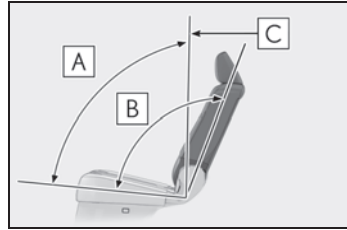

■ **Power seat operations (if equipped)**

If a seat cover or seat cushion has been put on the seat, it may not operate properly. When folding down the rear seatback, make sure that there is nothing on the seat that would interfere with the operation.

■ **Rear seatback jam protection function (power seat)**

When folding down or raising the rear seatback, if an object is detected between the rear seatback and seat cushion, the rear seatback will stop and then move in the opposite direction slightly.

A buzzer will sound continuously when the rear seatback stops and intermittently when moving in the opposite direction.

### Operation of the rear seats from the front seats (if equipped)

The rear seats can be operated on the center display.

► Operating a selected seat

- 1 Select  on the center display.
- 2 Select "Seat controls".
- 3 Select "Rear arrangement".
- 4 Select a seat to be adjusted.
- 5 Select the operation button.

When the button is selected, a buzzer will sound and the operation will start.

To stop the seatback return operation part-way, select “Cancel” stop on the center display.

► Operating all of the seats

- 1 Select  on the center display.
- 2 Select “Seat controls”.
- 3 Select “Rear arrangement”.
- 4 Select the operation button.

When the button is selected, a buzzer will sound and the operation will start.

To stop the seatback return operation part-way, select “Cancel” stop on the center display.

#### ■ The rear seats can be operated on the center display when

When all of the following conditions are met, the seatbacks can be folded by operating a switch.

When an operation switch other than that for the seat to be folded is not pressed

When the power switch is on, the operation is enabled if any of the following conditions is met in addition to the above:

- The parking brake is engaged.
- The brake pedal is depressed.
- The shift position is in P.

#### ■ The rear seatbacks can be raised when (power seat)

If the seatback is within the range **A** shown, the seatback can be returned.

**B** is where the rear seatback is at its most upright position

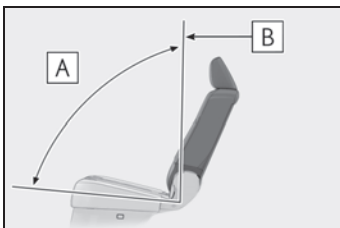

### WARNING

#### ■ Operation of the rear seats from the front seats

Have rear seat passengers exit the vehicle before operating the rear seats.

## Head restraints

Head restraints are provided for all seats.

### ⚠ WARNING

#### ■ Head restraint precautions

Observe the following precautions regarding the head restraints. Failure to do so may result in death or serious injury.

- Use the head restraints designed for each respective seat.
- Adjust the head restraints to the correct position at all times.
- After adjusting the head restraints, push down on them and make sure they are locked in position.
- Do not drive with the head restraints removed.

## Adjusting a head restraint vertically

### ■ Front seats

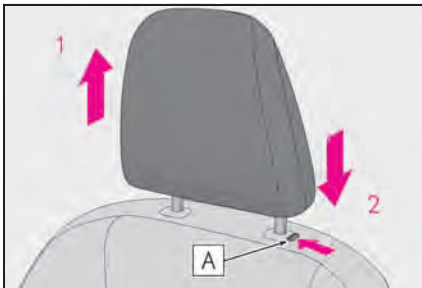

#### 1 Up

Pull the head restraints up.

#### 2 Down

Push the head restraint down while pressing the lock release button **A**.

### ■ Rear outer seats

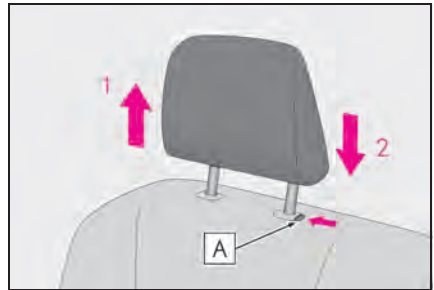

#### 1 Up

Pull the head restraints up.

#### 2 Down

Push the head restraint down while pressing the lock release button **A**.

### ■ Rear center seat

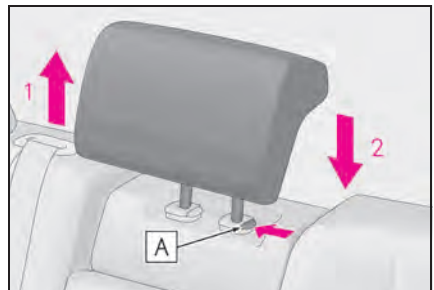

#### 1 Up

Pull the head restraints up.

#### 2 Down

Push the head restraint down while pressing the lock release button **A**.

### ■ Adjusting the height of the head restraints

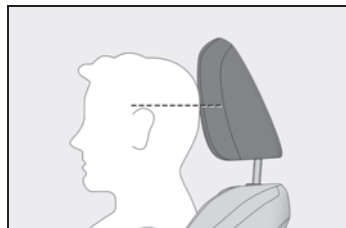

Make sure that the head restraints are adjusted so that the center of the head restraint is closest to the top of your ears.

#### ■ Adjusting the rear center seat head restraints

Always raise the head restraint one level from the stowed position when using.

### Adjusting a head restraint horizontally (if equipped)

The position of the head restraint can be adjusted forward in 4 stages.

If the head restraint is pulled forward from the foremost position, it will return to the rearmost position.

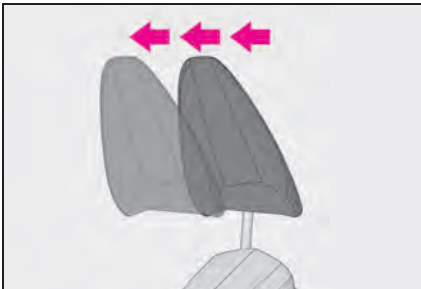

### Removing the head restraints

#### ■ Front seats and rear outer seats

Pull the head restraint up while pressing the lock release button **A**.

If the head restraint touches the ceiling, making the removal difficult, change the seat height or angle. (→P.144, 145)

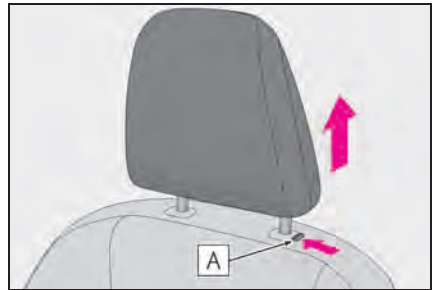

#### ■ Rear center seat

Pull the head restraint up while pressing the lock release button **A**.

If the head restraint touches the ceiling, making the removal difficult, change the seat height or angle. (→P.144, 145)

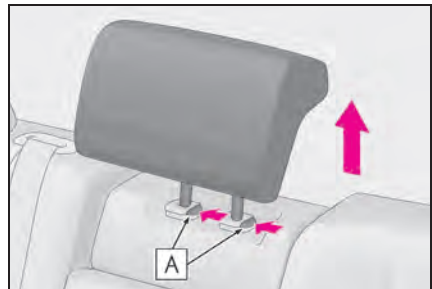

### Installing the head restraints

#### ■ Front seats and rear outer seats

Align the head restraint with the installation holes and push it down to the lock position.

Press and hold the lock release button **A** when lowering the head restraint.

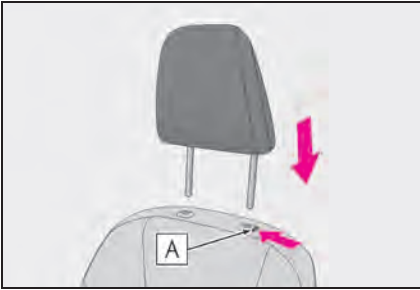

### ■ Rear center seat

Align the head restraint with the installation holes and push it down to the lock position.

Press and hold the lock release button **A** when lowering the head restraint.

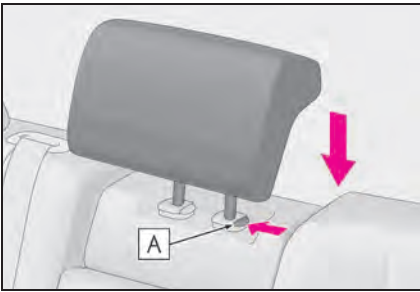

## Steering wheel

### Adjustment procedure

Operating the switch moves the steering wheel in the following directions:

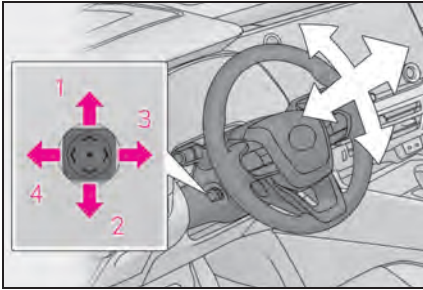

- 1 Up
- 2 Down
- 3 Toward the driver
- 4 Away from the driver

#### ■ The steering wheel can be adjusted when

The power switch is in ACC or ON\*.

\*: If the driver's seat belt is fastened, the steering wheel can be adjusted regardless of power switch mode.

#### ■ Automatic adjustment of the steering position (if equipped)

A desired steering position can be entered to memory and recalled automatically by the driving position memory system. (→P.178)

#### ■ Power easy access system

The steering wheel and driver's seat (on some models) move in accordance with power switch mode and the driver's seat belt condition. (→P.178)

#### ■ Customization

Some functions can be customized. (→P.590)

### ⚠ WARNING

#### ■ Caution while driving

Do not adjust the steering wheel while driving.

Doing so may cause the driver to mishandle the vehicle and cause an accident, resulting in death or serious injury.

### Auto tilt away

When the power switch is turned off, the steering wheel returns to its stowed position by moving up and away to enable easier driver entry and exit.

Turning the power switch to ACC or ON will return the steering wheel to the original position.

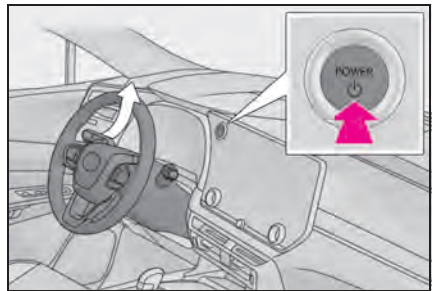

### Sounding the horn

Press on or close to the  mark.

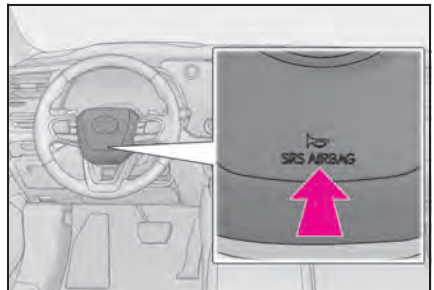

### Inside rear view mirror \*

\*: If equipped

The rear view mirror's position can be adjusted to enable sufficient confirmation of the rear view.

### Adjusting the height of rear view mirror

The height of the rear view mirror can be adjusted to suit your driving posture.

Adjust the height of the rear view mirror by moving it up and down.

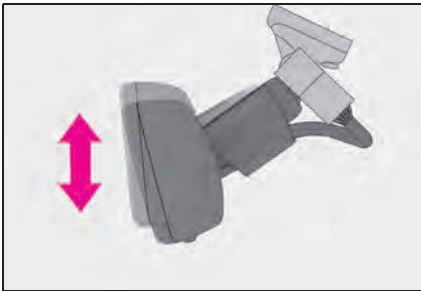

#### WARNING

#### Caution while driving

Do not adjust the position of the mirror while driving. Doing so may lead to mishandling of the vehicle and cause an accident, resulting in death or serious injury.

### Anti-glare function

Responding to the level of brightness of the headlights of vehicles behind, the reflected light is automatically reduced.

Turn the automatic anti-glare function

mode on/off

When the automatic anti-glare function is in ON mode, the indicator **A** illuminates. The function will set to ON mode each time the power switch is turned to ON. Pressing the button turns the function to OFF mode. (The indicator **A** also turns off.)

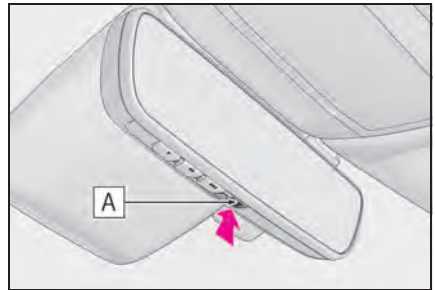

#### To prevent sensor error

To ensure that the sensors operate properly, do not touch or cover them.

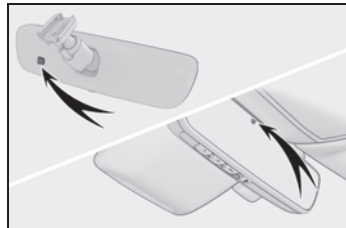

## Digital Rear-view Mirror\*

\*: If equipped

The Digital Rear-view Mirror is a system that uses the camera on the rear of the vehicle and displays its image on the display of the Digital Rear-view Mirror.

The Digital Rear-view Mirror can be changed between optical mirror mode and digital mirror mode by operating the lever.

The Digital Rear-view Mirror allows the driver to see the rear view despite obstructions, such as the head restraints or luggage, ensuring rear visibility. Also, the rear seats are not displayed and privacy of the passengers is enhanced.

### ⚠ WARNING

Observe the following precautions. Failure to do so may result in death or serious injury.

#### ■ Before using the Digital Rearview Mirror

- Make sure to adjust the mirror before driving. (→P.158)
- Change to optical mirror mode and adjust the position of the Digital Rear-view Mirror so that the area behind your vehicle can be viewed properly.
- Change to digital mirror mode and adjust the display settings.
- As the range of the image displayed by the Digital Rear-view Mirror is different from that of the optical mirror, make sure to check this difference before driving.

## System components

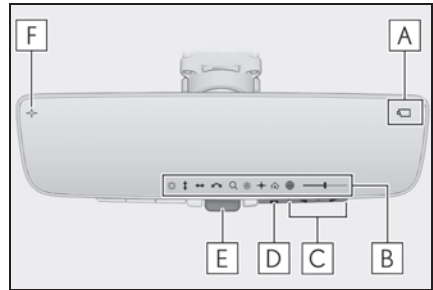

### A Camera indicator

Indicates that the camera is operating normally.

### B Icon display area

Displays icons, adjusting gauge, etc. (→P.159)

### C Select/adjust button

Press to change the setting of the item you want to adjust.

### D Menu button

Press to display the icon display area and select the item you want to adjust.

### E Lever

Operate to change between digital mirror mode and optical mirror mode.

### F Digital mirror anti-glare function indicator

Displayed in digital mirror mode when the anti-glare function of the digital mirror is enabled. (→P.159)

## Changing modes

Operate the lever to change between digital mirror mode and optical mirror mode.

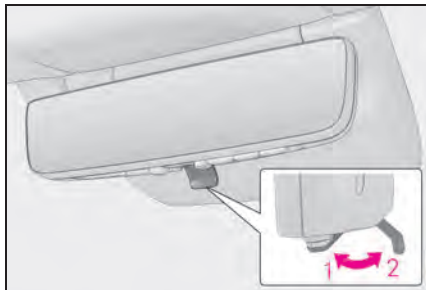

### 1 Digital mirror mode

Displays an image of the area behind the vehicle.

 will illuminate in this mode.

### 2 Optical mirror mode

Turns off the display of the Digital Rearview Mirror allows it to be used as an optical mirror.

#### ■ Digital mirror mode operating condition

The power switch is turned to ON.

When the power switch is changed from ON to OFF or ACC, the image will disappear after several seconds.

#### ■ When using the Digital Rearview Mirror in digital mirror mode

- If it is difficult to see the displayed image due to light reflected off the Digital Rear-view Mirror, the camera being dirty or covered with water droplets, dust, etc., or if lights of a vehicle behind your vehicle or the displayed image are bothering you, change to optical mirror mode.
- When it is raining, if the image is unclear due to water on the rear window, operate the rear wiper.
- When the back door is open, the Digital Rear-view Mirror image may not display properly. Before driving, make sure the back door is closed.
- If the display is difficult to see due to reflected light, close the sunshade for the moon roof (if equipped) or the electronic sunshade for the panoramic moon roof (if equipped).

- Any of the following conditions may occur when driving in the dark, such as at night. None of them indicates that a malfunction has occurred.
  - Colors of objects in the displayed image may differ from their actual color.
  - Depending on the height of the lights of the vehicle behind, the area around the vehicle may appear white and blurry.
  - Automatic image adjustment for brighter surrounding image may cause flickering.

If it is difficult to see the displayed image or flickering bothers you, change to optical mirror mode.

- The Digital Rear-view Mirror may become hot while it is in digital mirror mode. This is not a malfunction.
- Depending on your physical condition or age, it may take longer than usual to focus on the displayed image. In this case, change to optical mirror mode.
- Do not let passengers stare at the displayed image when the vehicle is being driven, as doing so may cause motion sickness.

#### ■ When the system malfunctions

If the symbol shown in the illustration is displayed when using the Digital Rear-view Mirror in digital mirror mode, the system may be malfunctioning. The symbol will disappear in a few seconds. Operate the lever, change to optical mirror mode and have the vehicle inspected by your Lexus dealer.

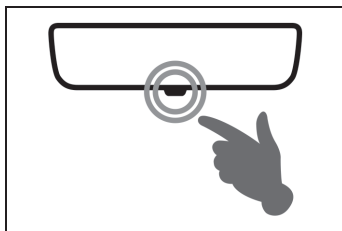

## Adjusting the mirror

### ■ Adjusting the mirror height

The height of the rear view mirror can be adjusted to suit your driving pos-

ture.

Change to optical mirror mode, adjusting the height of the rear view mirror by moving it up and down.

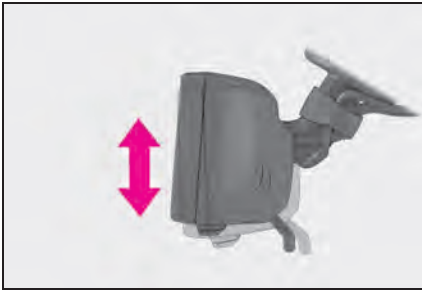

### ■ Display settings (digital mirror mode)

Settings of the display in the digital mirror mode, on/off operation of the automatic anti-glare function, etc. can be changed.

1 Press the menu button.



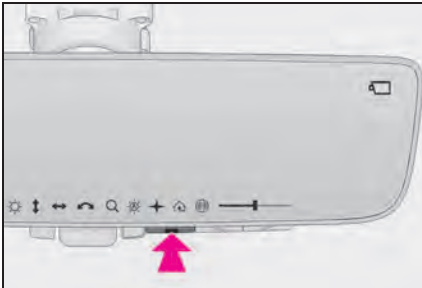



The icons will be displayed.





2 Press the menu button repeatedly and select the item you want to adjust.

3 Press  or  to change the setting.

The icons will disappear if a button is not operated for approximately 5 seconds or more.

Icons	Settings
	Select to adjust the brightness of the display.
	Select to adjust the area displayed up/down.
	Select to adjust the area displayed to the left/right.
	Select to adjust the angle of the displayed image.
	Select to zoom in/out the displayed image.
	Select to enable/disable the automatic anti-glare function.*  Responding to the brightness of the headlights of vehicles behind, the reflected light is automatically adjusted.  The automatic anti-glare function is enabled each time the power switch is changed to ON.
	Select to display HomeLink® Training Tutorial to assist customersto train their garage door opener system. (→P.450)

Icons	Settings
	Select to change the language of the Homelink® Training Tutorial.
	The anti-glare function of the digital mirror can be enabled/disabled.  When enabled, image on the digital mirror at night-time will be displayed at a reduced brightness level, reducing the headlight glare of the following vehicle.

\*: This is a function for the optical mirror mode, however, the setting can also be changed while using the digital mirror mode.

#### ■ Enabling/disabling the automatic anti-glare function (optical mirror mode)

The automatic anti-glare function in the optical mirror mode can be enabled/disabled. The setting can be changed in both the digital mirror mode and the optical mirror mode.

▶ When using the digital mirror mode



→P.159

▶ When using the optical mirror mode

1 Press the menu button.

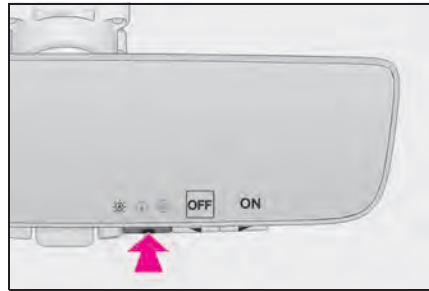
The icons will be displayed.



2 Press  or  to enable ("ON")/disable ("OFF") the automatic anti-glare function.

The icons will disappear if a button is not operated for approximately 5 seconds or more.

#### ■ Adjusting the display (digital mirror mode)

- The icons will disappear if a button is not operated for approximately 5 seconds or more.
- If the displayed image is adjusted, it may appear distorted. This is not a malfunction.
- If the brightness of the Digital Rearview Mirror is set too high, it may cause eye strain. Adjust the Digital Rear-view Mirror to an appropriate brightness. If your eyes become tired, change to optical mirror mode.
- The anti-glare function of the digital mirror is operational only when the surrounding area of the vehicle is dark enough. Depending on the brightness conditions of the surrounding area, the brightness of the displayed image on the digital mirror may not be reduced, not enabling to reduce the headlight glare of the following vehicle.
- The brightness of the Digital Rear-view Mirror will change automatically according to the brightness of the area in front of your vehicle.

### ■ To prevent the light sensors from malfunctioning

To prevent the light sensors from malfunctioning, do not touch or cover them.

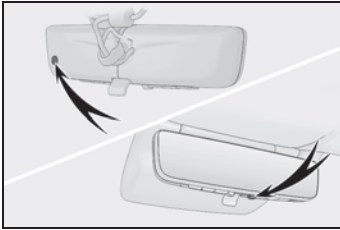

### ⚠ WARNING

Observe the following precautions. Failure to do so may result in death or serious injury.

#### ■ While driving

- Do not adjust the position of the Digital Rear-view Mirror or adjust the display settings while driving. Stop the vehicle and operate the Digital Rear-view Mirror control switches. Failure to do so may cause a steering wheel operation error, resulting in an unexpected accident.
- Always pay attention to the vehicle's surroundings.

The size of the vehicles and other objects may look different when in digital mirror mode and optical mirror mode. When backing up, make sure to directly check the safety of the area around your vehicle, especially behind the vehicle. Additionally, if a vehicle approaches from the rear in the dark, such as at night, the surrounding area may appear dim.

#### ■ To prevent causes of fire

If the driver continues using the Digital Rear-view Mirror while smoke or odor comes from the mirror, it may result in fire. Stop using the system immediately and contact your Lexus dealer.

## Cleaning the Digital Rearview Mirror

### ■ Cleaning the mirror surface

If the mirror surface is dirty, the image on the display may be difficult to see. Clean the mirror surface gently using a soft dry cloth.

### ■ The camera

The camera for the Digital Rear-view Mirror is located as shown.

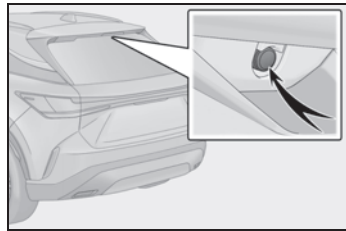

### ⚠ NOTICE

#### ■ To prevent the camera from malfunctioning

- Observe the following precautions, otherwise the Digital Rear-view Mirror may not operate properly.
  - Do not strike or hit the camera or subject it to a strong impact, as the camera installation position and angle may be changed.
  - Do not remove, disassemble or modify the camera.
  - Do not allow an organic solvent, car wax, window cleaner or glass coating to adhere to the camera. If this happens, wipe it off as soon as possible.
  - When applying colored film (including transparent film) to the rear window glass, do not apply it to the area in front of the camera. If film is applied to the area in front of the camera, the image from the camera may not display properly.

**NOTICE**

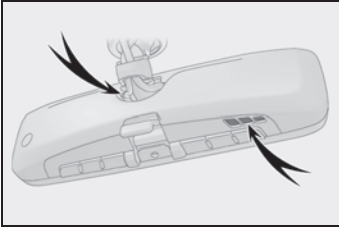

- Do not subject the camera to a strong impact as this could cause a malfunction. If this happens, have the vehicle inspected by your Lexus dealer as soon as possible.
- Do not block the vent holes of the mirror. Otherwise, the mirror may be hot, leading to a malfunction or a fire.



**If you notice any symptoms**

If you notice any of the following symptoms, refer to the following table for the likely cause and the solution.

If the symptom is not resolved by the solution, have the vehicle inspected by your Lexus dealer.

Symptom	Likely cause	Solution
The image is difficult to see.	The mirror surface is dirty.	Clean the mirror surface gently, using a soft dry cloth.
	Sunlight or headlights are shining directly into the Digital Rear-view Mirror.	Change to optical mirror mode. (If the light is coming through the moon roof [if equipped] or panoramic moon roof [if equipped], close the sunshade or electronic sunshade.)
	<ul style="list-style-type: none"> <li>• The vehicle is in a dark area.</li> <li>• The vehicle is near a TV tower, broadcasting station, electric power plant, or other location where strong radio waves or electrical noise may be present.</li> <li>• The temperature around the camera is extremely high/low.</li> <li>• The ambient temperature is extremely low.</li> <li>• It is raining or humid.</li> <li>• Sunlight or headlights are shining directly into the camera lens.</li> <li>• The vehicle is under fluorescent lights, sodium lights, mercury lights, etc.</li> <li>• Exhaust gas is obstructing the camera.</li> </ul>	Change to optical mirror mode. (Change back to digital mirror mode when the conditions have improved.)

Symptom	Likely cause	Solution
The image is difficult to see.	Foreign matters such as water droplets or dust is on the camera lens.	Have the vehicle inspected by your Lexus dealer.
	The luggage in the luggage compartment is reflected off the rear window glass and obstructing the camera.	<ul style="list-style-type: none"> <li>• Change to optical mirror mode.</li> <li>• Move the luggage to a position where it does not obstruct the camera or cover it with a black cloth to reduce the amount it is reflected off the rear window glass.</li> </ul>
	The rear window glass is fogged up.	Change to optical mirror mode. After defogging the rear window using the rear window defogger (→P.416), use the digital mirror mode again.
	The outside of the rear window glass is dirty.	Use the rear window wiper to remove dirt.
	The inside of the rear window glass is dirty.	Have the vehicle inspected by your Lexus dealer.
The image is out of alignment.	The back door is not fully closed.	Fully close the back door.
	The camera or its surrounding area has received a strong impact.	Change to optical mirror mode and have the vehicle inspected by your Lexus dealer.
The display is dim and  is displayed.	The system may be malfunctioning.	Change to optical mirror mode and have the vehicle inspected by your Lexus dealer.
 goes off.		

Symptom	Likely cause	Solution
 is displayed.	<p>The Digital Rear-view Mirror is extremely hot.</p> <p>(The display will gradually become more dim. If the temperature continues to increase, the Digital Rearview Mirror will turn off.)</p>	<p>Reducing the cabin temperature is recommended to reduce the temperature of the mirror.</p> <p>( will disappear when the mirror becomes cool.)</p> <p>If  does not disappear even though the mirror is cool, have the vehicle inspected by your Lexus dealer.</p>
<p>The lever cannot be operated properly.</p>	<p>The lever may be malfunctioning.</p>	<p>Change to optical mirror mode and have the vehicle inspected by your Lexus dealer.</p> <p>(To change to optical mirror mode, press and hold the menu button for approximately 10 seconds.)</p>

## Outside rear view mirrors

The rear view mirror's position can be adjusted to enable sufficient confirmation of the rear view.

### ■ When using the outside rear view mirrors in a cold weather

When it is cold and the outside rear view mirrors are frozen, it may not be possible to fold/extend them or adjust the mirror surface. Remove the ice, snow, etc. covering the outside rear view mirrors.

### ⚠ WARNING

#### ■ Important points while driving

Observe the following precautions while driving.

Failing to do so may result in loss of control of the vehicle and cause an accident, resulting in death or serious injury.

- Do not adjust the mirrors while driving.
- Do not drive with the mirrors folded.
- Both the driver and passenger side mirrors must be extended and properly adjusted before driving.

## Adjustment procedure

- 1 To select a mirror to adjust, press the switch.

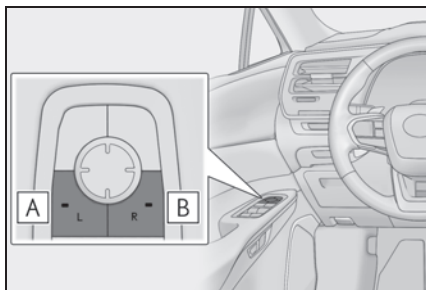

**A** Left

**B** Right

Pressing the same switch again will put the switch in neutral.

- 2 To adjust the mirror, press the switch.

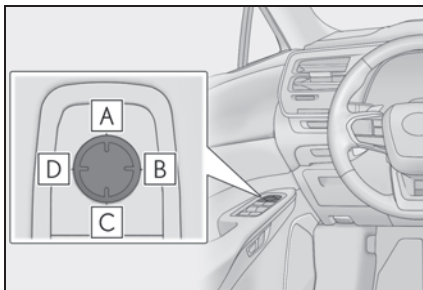

**A** Up

**B** Right

**C** Down

**D** Left

### ■ Mirror angle can be adjusted when

The power switch is in ACC or ON.

### ■ Defogging the mirrors

The outside rear view mirrors can be cleared using the mirror defoggers. Turn on the rear window defogger to turn on the outside rear view mirror defoggers. (→P.416)

### ■ Automatic adjustment of the mirror angle (if equipped)

A desired mirror face angle can be entered to memory and recalled automatically by the driving position memory. (→P.178)

### ■ Auto anti-glare function (if equipped)

When the anti-glare inside rear view mirror is set to automatic mode, the outside rear view mirrors will activate in conjunction with the anti-glare inside rear view mirror to reduce reflected light. (→P.156)

**⚠ WARNING****■ When the mirror defoggers are operating**

Do not touch the rear view mirror surfaces, as they can become very hot and burn you.

**Folding and extending the mirrors****■ Using the switch**

Press the switch to fold the mirrors.

Press it again to extend them to the original position.

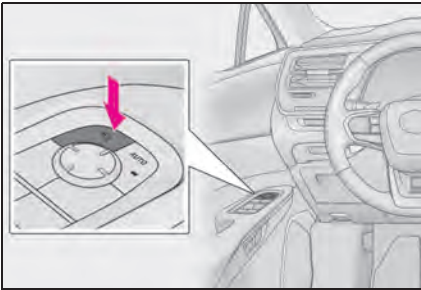
**■ Setting automatic mode**

Automatic mode allows the folding or extending of the mirrors to be linked to locking/unlocking of the doors.

Press the “AUTO” switch to set automatic mode.

The indicator **A** will come on.

Pressing the switch once more will return to manual mode.

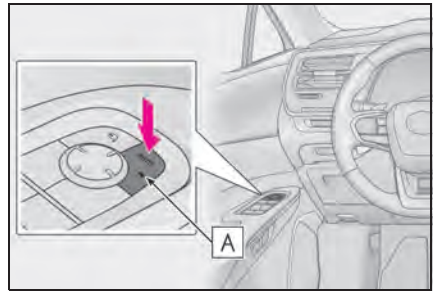
**■ When disconnecting and reconnecting 12-volt battery terminals**

The automatic folding/extending mirror function will return to off as default. To turn the function on, press the switch again to select on.

**■ Customization**

Some functions can be customized. (→P.590)

**⚠ WARNING****■ When a mirror is moving**

To avoid personal injury and mirror malfunction, be careful not to get your hand caught by the moving mirror.

**Linked mirror function when reversing**

When either “L” or “R” of the mirror select switch is selected, the outside rear view mirrors will automatically angle downwards when the vehicle is reversing in order to give a better view of the ground.

To disable this function, select neither “L” nor “R”.

**■ Adjusting the mirror angle when the vehicle is reversing**

With the shift position in R, adjust the mirror angle at a desired position.

The adjusted angle will be memorized and the mirror will automatically tilt to the memorized angle whenever the shift position is shifted to R from next time.

The memorized downward tilt position of the mirror is linked to the normal position (angle adjusted with the shift position in other than R). Therefore, if the normal position is changed after adjustment, the tilt position will also change.

When the normal position is changed, readjust the angle in reversing.

## Power windows

### Opening and closing the power windows

The power windows can be opened and closed using the switches. Operating the switch moves the windows as follows:

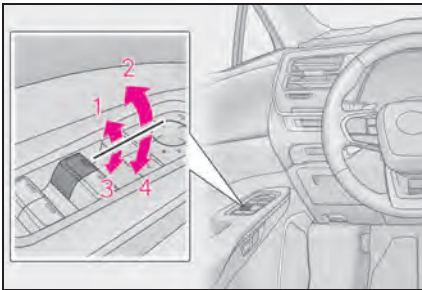

- 1 Closing
- 2 One-touch closing \*
- 3 Opening
- 4 One-touch opening \*

\* : To stop the window partway, operate the switch in the opposite direction.

#### ■ The power windows can be operated when

The power switch is in ON.

#### ■ Operating the power windows after turning the hybrid system off

The power windows can be operated for approximately 45 seconds even after the power switch is turned to ACC or turned off. They cannot, however, be operated once either front door is opened.

#### ■ Jam protection function

If an object becomes jammed between the window and the window frame while the window is closing, window movement is stopped and the window is opened slightly.

#### ■ Catch protection function

If an object becomes caught between the door and window while the window is opening, window movement is stopped.

#### ■ When the window cannot be opened or closed

When the jam protection function or catch protection function operates unusually and the door window cannot be opened or closed, perform the following operations with the power window switch of that door.

● Stop the vehicle. With the power switch in ON, within 4 seconds of the jam protection function or catch protection function activating, continuously operate the power window switch in the one-touch closing direction or one-touch opening direction so that the door window can be opened and closed.

● If the door window cannot be opened and closed even when performing the above operations, perform the following procedure for function initialization.

- 1 Turn the power switch to ON.
- 2 Pull and hold the power window switch in the one-touch closing direction and completely close the door window.
- 3 Release the power window switch for a moment, resume pulling the switch in the one-touch closing direction, and hold it there for approximately 6 seconds or more.
- 4 Press and hold the power window switch in the one-touch opening direction. After the door window is completely opened, continue holding the switch for an additional 1 second or more.
- 5 Release the power window switch for a moment, resume pushing the switch in the one-touch opening direction, and hold it there for approximately 4 seconds or more.
- 6 Pull and hold the power window switch in the one-touch closing direction again. After the door window is completely closed, continue holding the switch for a further 1 second or more.

If you release the switch while the window is moving, start again from the beginning.

If the window reverses and cannot be fully closed or opened, have the vehicle inspected by your Lexus dealer.

#### ■ Door lock linked window operation

- The power windows can be opened and closed using the mechanical key.\* (→P.550)
- The power windows can be opened using the wireless remote control.\* (→P.119)

\* : These settings must be customized at your Lexus dealer.

#### ■ Alarm

The alarm may be triggered if the alarm is set and a power window is closed using the door lock linked power window operation function. (→P.83)

#### ■ Power windows open warning buzzer

A buzzer sounds and a message is shown on the multi-information display in the instrument cluster when the power switch is turned off and the driver's door is opened with the power windows open. However, if the window close suggestion function is on, this buzzer will not operate.

#### ■ Customization

Some functions can be customized. (→P.590)



### WARNING

Observe the following precautions. Failing to do so may result in death or serious injury.

#### ■ Closing the windows

- The driver is responsible for all the power window operations, including the operation for the passengers. In order to prevent accidental operation, especially by a child, do not let a child operate the power windows. It is possible for children and other passengers to have body parts caught in the power window. Also, when riding with a child, it is recommended to use the window lock switch. (→P.171)

- Check to make sure that all passengers do not have any part of their body in a position where it could be caught when a window is being operated.

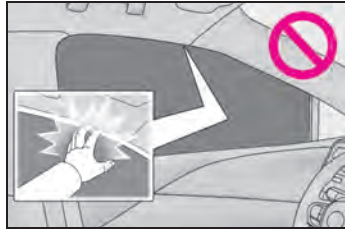

- When using the wireless remote control or mechanical key and operating the power windows, operate the power window after checking to make sure that there is no possibility of any passenger having any of their body parts caught in the window. Also do not let a child operate window by the wireless remote control or mechanical key. It is possible for children and other passengers to get caught in the power window.
- When exiting the vehicle, turn the power switch off, carry the key and exit the vehicle along with the child. There may be accidental operation, due to mischief, etc., that may possibly lead to an accident.

#### ■ Jam protection function

- Never use any part of your body to intentionally activate the jam protection function.
- The jam protection function may not work if something gets jammed just before the window is fully closed. Be careful not to get any part of your body jammed in the window.

#### ■ Catch protection function

- Never use any part of your body or clothing to intentionally activate the catch protection function.

**! WARNING**

- The catch protection function may not work if something gets caught just before the window is fully opened. Be careful not to get any part of your body or clothing caught in the window.

**Preventing accidental operation (window lock switch)**

This function can be used to prevent children from accidentally opening or closing a passenger window.

Press the switch.

The indicator **A** will come on and the passenger windows will be locked.

The passenger windows can still be opened and closed using the driver's switch even if the lock switch is on.

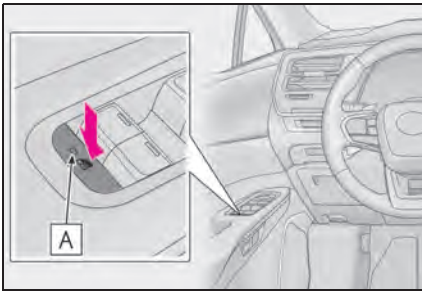

- **The power windows can be operated when**

The power switch is in ON.

- **When the 12-volt battery is disconnected**

The window lock switch is disabled. If necessary, press the window lock switch after reconnecting the 12-volt battery.

**Moon roof\***

\*: If equipped

**Use the overhead switches to open and close the moon roof and tilt it up and down.**

**Operating the moon roof**

- **Opening and closing**

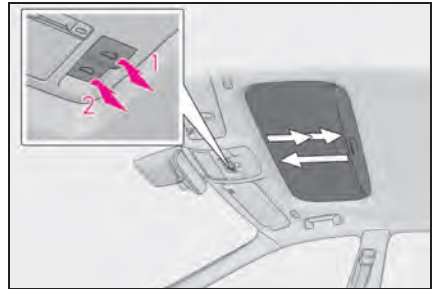

- 1** Opens the moon roof\*

The moon roof stops slightly before the fully open position to reduce wind noise. Press the switch again to fully open the moon roof.

- 2** Closes the moon roof\*

\*: Lightly press either side of the moon roof switch to stop the moon roof partway.

- **Tilting up and down**

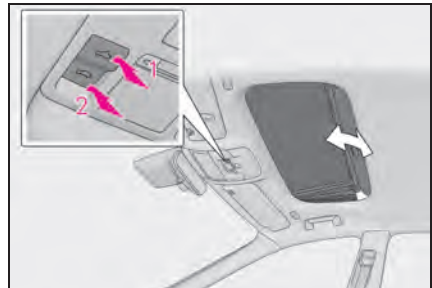

- 1** Tilts the moon roof up\*

## 2 Tilts the moon roof down\*

\*: Lightly press either side of the moon roof switch to stop the moon roof partway.

### ■ The moon roof can be operated when

The power switch is in ON.

### ■ Operating the moon roof after turning the hybrid system off

The moon roof can be operated for approximately 45 seconds after the power switch is turned to ACC or turned off. It cannot, however, be operated once the driver's door is opened.

### ■ Jam protection function

If an object is detected between the moon roof and the frame while the moon roof is closing or tilting down, travel is stopped and the moon roof opens slightly.

### ■ Sunshade

The sunshade can be opened and closed manually. However, the sunshade will open automatically when the moon roof is opened.

### ■ Door lock linked moon roof operation

- The moon roof can be opened and closed using the mechanical key.\* (→P.550)
- The moon roof can be opened using the wireless remote control.\* (→P.119)
- The alarm may be triggered if the alarm is set and the moon roof is closed using the door lock linked moon roof operation function. (→P.83)

\*: These settings must be customized at your Lexus dealer.

### ■ When the moon roof does not close normally

Perform the following procedure:

▶ If the moon roof closes but then re-opens slightly

1 Stop the vehicle.

2 Press and hold the  switch.\*<sup>1</sup>

The moon roof will close, reopen and pause

for approximately 10 seconds.\*<sup>2</sup> Then it will close again, tilt up and pause for approximately 1 second. Finally, it will tilt down, open and close.

3 Check to make sure that the moon roof is completely closed and then release the switch.

▶ If the moon roof tilts down but then tilts back up



1 Stop the vehicle.

2 Press and hold the  switch\*<sup>1</sup> until the moon roof moves into the tilt up position and stops.

3 Release the switch once and then press and hold the  switch again.\*<sup>1</sup> The moon roof will pause for approximately 10 seconds in the tilt up position.\*<sup>2</sup> Then it will adjust slightly and pause for approximately 1 second. Finally, it will tilt down, open and close.

4 Check to make sure that the moon roof is completely closed and then release the switch.

\*<sup>1</sup>: If the switch is released at the incorrect time, the procedure will have to be performed again from the beginning.

\*<sup>2</sup>: If the switch is released after the above mentioned 10 second pause, automatic operation will be disabled. In that case, press and hold the  or  switch, and the moon roof will tilt up and pause for approximately 1 second. Then it will tilt down, open and close. Check to make sure that the moon roof is completely closed and then release the switch.

If the moon roof does not fully close even after performing the above procedure correctly, have the vehicle inspected by your Lexus dealer.

### ■ Moon roof open warning buzzer

A buzzer sounds and a message is shown on the multi-information display in the instrument cluster when the power switch is turned off and the driver's door is opened with the moon roof open.

### ■ Customization

Some functions can be customized.  
(→P.590)

### ⚠ WARNING

Observe the following precautions.  
Failing to do so may cause death or serious injury.

#### ■ Opening the moon roof

- Do not allow any passengers to put their hands or heads outside the vehicle while it is moving.
- Do not sit on top of the moon roof.

#### ■ Opening and closing the moon roof

- The driver is responsible for moon roof opening and closing operations. In order to prevent accidental operation, especially by a child, do not let a child operate the moon roof. It is possible for children and other passengers to have body parts caught in the moon roof.
- Check to make sure that all passengers do not have any part of their body in a position where it could be caught when the moon roof is being operated.

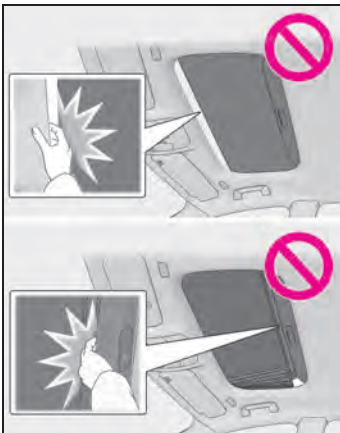

- When using the wireless remote control or mechanical key and operating the moon roof, operate the moon roof after checking to make sure that there is no possibility of any passenger having any of their body parts caught in the moon roof. Also, do not let a child operate moon roof by the wireless remote control or mechanical key. It is possible for children and other passengers to get caught in the moon roof.

- When exiting the vehicle, turn the power switch off, carry the key and exit the vehicle along with the child. There may be accidental operation, due to mischief, etc., that may possibly lead to an accident.

#### ■ Jam protection function

- Never use any part of your body to intentionally activate the jam protection function.
- The jam protection function may not work if something gets caught just before the moon roof is fully closed. Also, the jam protection function is not designed to operate while the switch is being pressed. Take care so that your fingers, etc. do not get caught.

## Panoramic moon roof\*

\*: If equipped

Use the overhead switches to operate the panoramic moon roof and electronic sunshade.

### Operating the panoramic moon roof

#### ■ Opening and closing the electronic sunshade

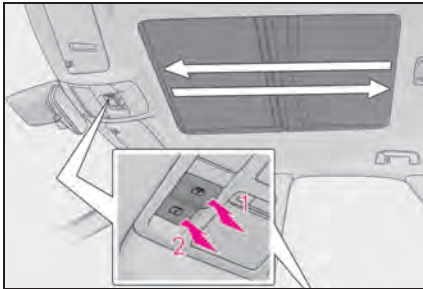



#### 1 Opens the electronic sunshade

If the  switch is pressed and held, the electronic sunshade will fully open automatically.\*<sup>1</sup>

#### 2 Closes the electronic sunshade

If the  switch is pressed and held, the electronic sunshade will fully close automatically.\*<sup>2</sup>

\*<sup>1</sup>: Lightly press either end of the  switch to stop the electronic sunshade while it is operating.

\*<sup>2</sup>: Lightly press either end of the  switch to stop the electronic sunshade while it is operating.

#### ■ Tilting the panoramic moon roof up and down

Tilts the panoramic moon roof up (press)\*

When the panoramic moon roof is tilted up, the electronic sunshade will open to the half-open position of the roof.

\*: Lightly press the  switch again to stop the panoramic moon roof partway.

Tilts the panoramic moon roof down (press and hold)

The panoramic moon roof can be tilted down only when it is in the tilt-up position.

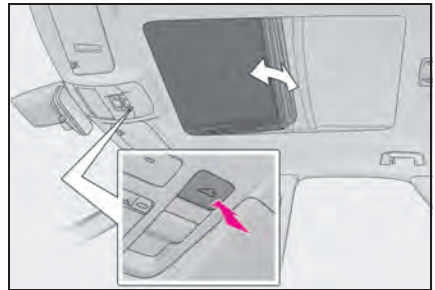

#### ■ Opening and closing the panoramic moon roof

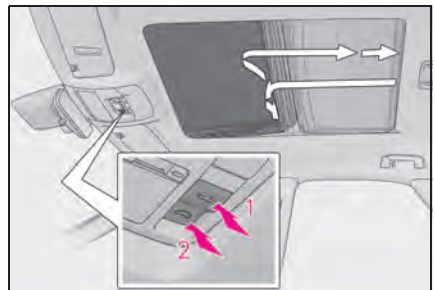

#### 1 Opens the panoramic moon roof\*<sup>1</sup>

Lightly press either end of the panoramic moon roof  switch to stop the panoramic moon roof while it is operating.

The panoramic moon roof can be opened from the tilt-up position.

**2** Closes the panoramic moon roof\*<sup>2</sup>

The panoramic moon roof can be opened from the tilt-up position.

Press the  switch. The panoramic moon roof will fully close automatically.

\*<sup>1</sup>: Lightly press either end of the  switch to stop the electronic sunshade while it is operating.

\*<sup>2</sup>: Lightly press either end of the  switch to stop the electronic sunshade while it is operating.

---

**■ The panoramic moon roof can be operated when**

The power switch is in ON.

**■ Operating the panoramic moon roof after turning the hybrid system off**

The panoramic moon roof and electronic sunshade can be operated for approximately 45 seconds after the power switch is turned to ACC or turned off. They cannot, however, be operated once the driver's door is opened.

**■ Jam protection function**

If an object is detected between the panoramic moon roof and the frame in the following situations, travel is stopped and the panoramic moon roof opens slightly:

- The panoramic moon roof is closing or tilting down.
- The electronic sunshade is closing.

**■ Door lock linked panoramic moon roof operation**

- The panoramic moon roof can be opened and closed using the mechanical key.\* (→P.550)
- The panoramic moon roof can be opened using the wireless remote control.\* (→P.119)
- The alarm may be triggered if the alarm is set and the panoramic moon roof is closed using the door lock linked moon roof operation function. (→P.83)

\*: These settings must be customized at your Lexus dealer.



**■ Closing both the panoramic moon roof and electronic sunshade**

Press the  switch.

The electronic sunshade will close to the half-open position and pause. The panoramic moon roof will then fully close. Then the electronic sunshade will fully close.

**■ When the panoramic moon roof or electronic sunshade does not close normally**

Perform the following procedure:

- 1 Stop the vehicle.
- 2 Turn the power switch to ON.
- 3 Press and hold the  switch or  switch. Continue pressing the switch for approximately 10 seconds after the panoramic moon roof or electronic sunshade closes and reopens. The panoramic moon roof and electronic sunshade will start to close.\*
- 4 Check that the panoramic moon roof and electronic sunshade are fully closed and release the switch.

\*: If the switch is released at the incorrect time, the procedure will have to be performed again from the beginning.

If the panoramic moon roof or electronic sunshade does not fully close even after performing the above procedure correctly, have the vehicle inspected by your Lexus dealer.

**■ Panoramic moon roof open warning buzzer**

A buzzer sounds and a message is shown on the multi-information display in the instrument cluster when the power switch is turned off and the driver's door is opened with the panoramic moon roof open.

**■ Customization**

Some functions can be customized. (→P.590)

## WARNING

Observe the following precautions. Failing to do so may cause death or serious injury.

### ■ Opening and closing the electronic sunshade

- Check to make sure that all passengers do not have any part of their body in a position where it could be caught when the electronic sunshade is being operated.



- Do not let a child operate the electronic sunshade. Closing the electronic sunshade on someone can cause death or serious injury.

### ■ Opening and closing the panoramic moon roof

- The driver is responsible for panoramic moon roof opening and closing operations. In order to prevent accidental operation, especially by a child, do not let a child operate the panoramic moon roof. It is possible for children and other passengers to have body parts caught in the panoramic moon roof.

- Check to make sure that all passengers do not have any part of their body in a position where it could be caught when the panoramic moon roof is being operated.

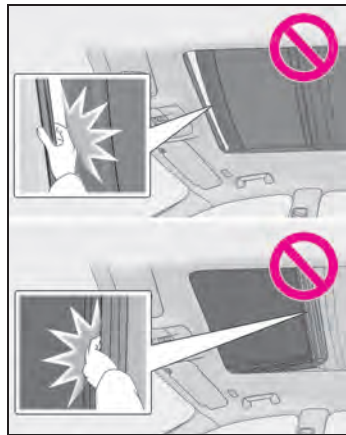

- When using the wireless remote control or mechanical key and operating the panoramic moon roof, operate the panoramic moon roof after checking to make sure that there is no possibility of any passenger having any of their body parts caught in the panoramic moon roof. Also, do not let a child operate panoramic moon roof by the wireless remote control or mechanical key. It is possible for children and other passengers to get caught in the panoramic moon roof.
- When exiting the vehicle, turn the power switch off, carry the key and exit the vehicle along with the child. There may be accidental operation, due to mischief, etc., that may possibly lead to an accident.

### ■ Jam protection function

- Never use any part of your body to intentionally activate the jam protection function.



**WARNING**

- The jam protection function may not work if something gets caught just before the panoramic moon roof or electronic sunshade is fully closed. Also, the jam protection function is not designed to operate while the switch is being pressed. Take care so that your fingers, etc. do not get caught.

**■ To prevent burns or injuries**

Do not touch the area between the underside of the panoramic moon roof and the electronic sunshade. Your hand may get caught and you could injure yourself. Also, if the vehicle is left in direct sunlight for a long time, the underside of the panoramic moon roof could become very hot and could cause burns.

**NOTICE****■ To prevent damage to the panoramic moon roof**

- Before opening the panoramic moon roof, make sure that there are no foreign objects, such as stones or ice, around the opening.
- Do not hit the surface or edge of the panoramic moon roof with hard objects.
- Do not continuously press the  switch or  switch after the panoramic moon roof has been fully opened or closed.

**■ After the vehicle has been washed or rained on**

Before opening the panoramic moon roof, wipe any water off the panoramic moon roof. Otherwise, water may enter the cabin when the panoramic moon roof is opened.

## Driving position memory \*

\*: If equipped

This feature automatically adjusts the driver's seat (on some models), steering wheel, outside rear view mirrors and head-up display (if equipped) to make entering and exiting the vehicle easier or to suit your preferences.

Up to 3 different driving positions can be recorded.

Each electronic key can be registered to recall your preferred driving position.

## Power easy access system (driver's side only)

The seat and steering wheel are automatically adjusted to allow the driver to enter and exit the vehicle easily.

When all of the following have been performed, the seat and steering wheel are automatically adjusted to a position that allows driver to enter and exit the vehicle easily.

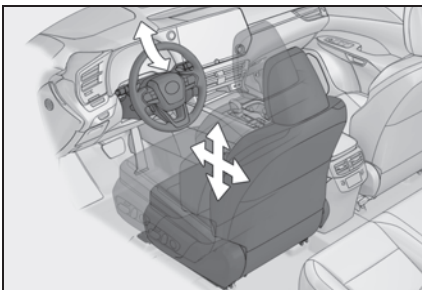

- The shift position has been shifted to P.

- The power switch has been turned off.
- The driver's seat belt has been unfastened.

When any of the following has been performed, the seat and steering wheel automatically return to their original positions.

- The power switch has been turned to ACC or ON.
- The driver's seat belt has been fastened.

## ■ Operation of the power easy access system

When exiting the vehicle, the power easy access system may not operate if the seat is already close to the rearmost position, etc.

## ■ Jam protection function

While the power easy access system is operating, if an object is stuck behind the front seat, the front seat will stop and then slightly move forward. When the jam protection function operates, the seat stops at a position other than the set seat position. Check the seat position.

## ■ Customization

Some functions can be customized. (→P.590)

## ⚠ WARNING

- While the power easy access system is operating and the steering wheel and seat is moving

Be careful not to get body parts or luggage caught. Failure to do so may cause an injury or damage to the luggage.

## Recording a driving position into memory

- 1 Check that the shift position is in P.

- 2 Turn the power switch to ON.
- 3 Adjust the driver's seat, steering wheel, outside rear view mirrors and head-up display (if equipped) to the desired positions.
- 4 While pressing the "SET" button, or within 3 seconds after the "SET" button is pressed, press button "1", "2" or "3" until the buzzer sounds.

If the selected button has already been preset, the previously recorded position will be overwritten.

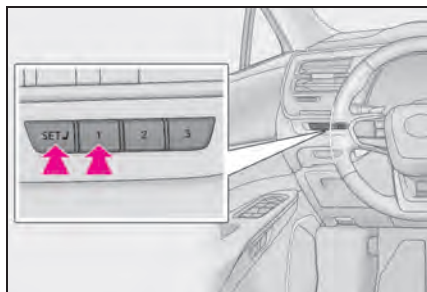

#### ■ Seat positions that can be memorized (→P.144)

The adjusted positions other than the position adjusted by lumbar support switch can be recorded.

#### ■ In order to correctly use the driving position memory function

If a seat position is already in the furthest possible position and the seat is operated in the same direction, the recorded position may be slightly different when it is recalled.



### WARNING

#### ■ Seat adjustment caution

Take care during seat adjustment so that the seat does not strike the rear passenger or squeeze your body against the steering wheel.

### Recalling a driving position

- 1 Check that the shift position is in P.
- 2 Turn the power switch to ON.
- 3 Press one of the buttons for the driving position you want to recall until the buzzer sounds.

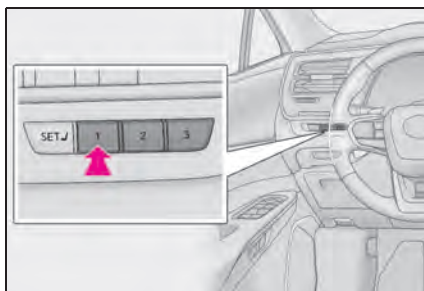

#### ■ To stop the position recall operation part-way through

Perform any of the following operations:

- Press the "SET" button.
- Press button "1", "2" or "3".
- Operate any of the seat adjustment switches (only cancels seat position recall).
- Operate the tilt and telescopic steering control switch (only cancels steering wheel position recall).

#### ■ Jam protection function

While the driving position is recalled or the power easy access system is operating, if an object is stuck behind the front seat, the front seat will stop and then slightly move forward. When the jam protection function operates, the seat stops at a position other than the set seat position. Check the seat position.

#### ■ Operating the driving position memory after turning the power switch off

Recorded seat positions can be activated up to 180 seconds after the driver's door is opened and another 60 seconds after it is closed again.

### ■ When the recorded seat position cannot be recalled

The seat position may not be recalled in some situations when the seat position is recorded in a certain range. For details, contact your Lexus dealer.

### ■ Using the voice control system\*

\* : If equipped

The following operations can be performed using the voice control system:

- Driving position registration
- Driving position recall (only when the shift position is in P)

For details, refer to the "MULTIMEDIA OWNER'S MANUAL"

## Registering/canceling/recall a driving position to an electronic key (memory recall function) (driver's side only)

### ■ Identifying a driver with the electronic key assigned and registered in My Settings

The driving positions can be automatically recalled for each registered driver by registering electronic key assignments in My Settings.

- Driving position registration procedure

When the shift position is shifted to P after driving the vehicle, the current driving position will be recorded.

- Driving position recall procedure

- 1 Carry only the key that has been assigned and registered in My Settings, and then unlock and open the driver's door using the smart access system with push-button start or wireless remote control.

The driving position other than the steering wheel and head-up display (if equipped) will move to the recorded position. However, the seat will move to a position slightly behind the recorded position in order to make entering the vehicle easier.

If the driving position is in a position that has already been recorded, the driving position will not move.

- 2 Turn the power switch to ACC or ON.

The seat, steering wheel and head-up display (if equipped) (only when the power switch is in ON) will move to the recorded position.

- Memory recall function cancelation procedure

Initialize the driver registered settings in My Settings.

For information on initializing driver registered settings, refer to the "MULTIMEDIA OWNER'S MANUAL".

### ■ Identifying a driver with face information assigned and registered in My Settings

The driving positions can be automatically recalled for each registered driver by registering face information in the face authentication system and registering the face information assignment in My Settings.

- Driving position registration procedure

When the shift position is shifted to P after driving the vehicle, the current driving position will be recorded.

- Driving position recall procedure

Turn the power switch to ACC or ON.

After face authentication is performed successfully, the seat, steering wheel, and head-up display will move to the registered

driving position (only when the power switch is turned on). They will not move if already in the registered driving position.

If the driving position is in a position that has already been recorded, the driving position will not move.

- Memory recall function cancelation procedure

Delete face information from the face authentication system.

For information on deleting fingerprint information, refer to the "MULTIMEDIA OWNER'S MANUAL".

- Vehicles without a My Settings function

Each electronic key can be registered to automatically recall your preferred driving position.

- Driving position registration procedure

Record your driving position to button "1", "2" or "3" before performing the following:

Carry only the key you want to register, and then close the driver's door.

If 2 or more keys are in the vehicle, the driving position cannot be recorded properly.

- 1 Check that the shift position is in P.
- 2 Turn the power switch to ON mode.
- 3 Recall the driving position that you want to record.
- 4 While pressing the recalled button, press and hold the door lock switch (either lock or unlock) until the buzzer sounds.

If the button could not be registered, the buzzer sounds continuously for approximately 3 seconds.

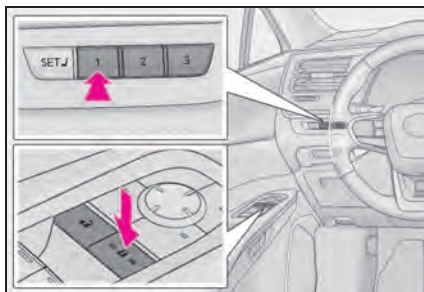

- Driving position recall procedure

- 1 Make sure that the doors are locked before recalling the driving position. Carry the electronic key that has been registered to the driving position, and then unlock and open the driver's door using the smart access system with push-button start or wireless remote control.

The driving position will move to the recorded position (not including the steering wheel and head-up display [if equipped]). However, the seat will move to a position slightly behind the recorded position in order to make entering the vehicle easier.

If the driving position is in a position that has already been recorded, the seat and outside rear view mirrors will not move.

- 2 Turn the power switch to ACCESSORY mode or ON mode, or fasten a seat belt.

The seat, steering wheel and head-up display (if equipped) will move to the recorded position.

- Memory recall function cancelation procedure

Carry only the key you want to cancel and then close the driver's door.

If 2 or more keys are in the vehicle, the

driving position cannot be canceled properly.

- 1 Check that the shift position is in P.
- 2 Turn the power switch to ON mode.
- 3 While pressing the "SET" button, press and hold the door lock switch (either lock or unlock) until the buzzer sounds twice.

If it button could not be canceled, the buzzer sounds continuously for approximately 3 seconds.

#### ■ Recalling the driving position using the memory recall function (vehicles with the My setting)

Different driving positions can be registered for each electronic key. Therefore, the driving position that is recalled may be different depending on the key being carried.

#### ■ Recalling the driving position using the memory recall function (vehicles without the My setting)

- Different driving positions can be registered for each electronic key. Therefore, the driving position that is recalled may be different depending on the key being carried.
- If a door other than the driver's door is unlocked with the smart access system with push-button start, the driving position cannot be recalled. In this case, press the driving position button which has been set.

#### ■ Jam protection function

While the driving position is recalled or the power easy access system is operating, if an object is stuck behind the front seat, the front seat will stop and then slightly move forward. When the jam protection function operates, the seat stops at a position other than the set seat position. Check the seat position.

#### ■ Customization

Some functions can be customized. (→P.590)

## My Settings\*

\*: If equipped

By identifying an individual through a device, such as an electronic key, the driving position and vehicle settings recorded for that driver can be recalled when the vehicle is entered.

By assigning an authentication device to a driver in advance, the driver can enter the vehicle with their preferred settings.

Settings for up to 3 drivers can be recorded by My Settings.

For details on how to assign/delete electronic keys, set driver names, perform initialization, change drivers manually, or delete a driver, refer to the "MULTIMEDIA OWNER'S MANUAL".

## Types of assigned authentication devices

An individual can be identified using the following authentication devices:

### ● Electronic key/Digital key\*

An individual is identified when the smart access system with push-button start detects their electronic key/digital key. (→P.117, 139)

### ● Face authentication system\*

An individual is identified at the opening/closing of the door when face information registered using the driver monitor camera is identified. (→P.259)

Individual identification by face authentication is prioritized than by electronic key/digital key<sup>\*</sup>, if the latter has identified with another registered driver.

### ● Bluetooth<sup>®</sup> devices

An individual can be identified if the same Bluetooth<sup>®</sup> device that was used as a hands-free phone the last time the vehicle was entered is connected to the audio system.

If an individual is identified by detecting an electronic key, identification by Bluetooth<sup>®</sup> device will not be performed.

\*: If equipped

## Recalled functions

When an individual is identified from an authentication device, settings for the following functions are recalled:

### ● Driving position (memory recall function)

After an individual is identified, the driving position that was set when driving was last completed (with shift position set to P) is recalled when the following operation is performed.

- When an individual is identified from an electronic key: Unlocking the doors using the smart access system with push-button start or wireless remote control
- When an individual is identified from a digital key<sup>\*1</sup>: Unlocking the doors using the smart access system with push-button start
- When an individual is identified from the face authentication system<sup>\*1</sup>: After the driver monitor identifies face information, turning the power switch to ACC or

ON.

- Meter displays<sup>\*2</sup>, head-up display<sup>\*2</sup>, and center display<sup>\*2</sup>

When an individual is identified, the vehicle settings used when the power switch was last turned off are recalled.

- Safe driving support function<sup>\*2</sup>

When an individual is identified, the vehicle settings used when the power switch was last turned off are recalled.

- Vehicle settings available on the center display<sup>\*2</sup>

When an individual is identified, the vehicle settings used when the power switch was last turned off are recalled.

\*1: If equipped

\*2: Some settings are excluded



- 4-1. Before driving**
- Driving the vehicle..... **187**
  - Cargo and luggage..... **193**
  - Vehicle load limits..... **196**
  - Trailer towing (vehicles without towing package)..... **197**
  - Trailer towing (vehicles with towing package)..... **197**
  - Dinghy towing ..... **207**
- 4-2. Driving procedures**
- Power (ignition) switch..... **208**
  - EV drive mode ..... **212**
  - Automatic transmission..... **214**
  - Hybrid transmission ..... **220**
  - Turn signal lever..... **226**
  - Parking brake ..... **226**
  - Brake Hold..... **229**
  - ASC (Active Sound Control) **231**
- 4-3. Operating the lights and wipers**
- Headlight switch..... **232**
  - AHS (Adaptive High-beam System)..... **234**
  - AHB (Automatic High Beam) ..... **237**
  - Fog light switch ..... **240**
  - Windshield wipers and washer ..... **241**
  - Rear window wiper and washer ..... **245**
- 4-4. Refueling**
- Opening the fuel tank cap.... **247**
- 4-5. Using the driving support systems**
- Lexus Safety System + 3/Traffic Jam Assist software update ..... **250**
  - Lexus Safety System + 3..... **252**
  - Driver monitor..... **259**
  - PCS (Pre-Collision System) ..... **261**
  - LTA (Lane Tracing Assist) ..... **271**
  - LCA (Lane Change Assist) ..... **276**
  - LDA (Lane Departure Alert) ..... **279**
  - PDA (Proactive driving assist) ..... **285**
  - FCTA (Front Cross Traffic Alert) ..... **290**
  - RSA (Road Sign Assist)..... **293**
  - Dynamic radar cruise control ..... **295**
  - Cruise control ..... **306**
  - Emergency Driving Stop System ..... **311**
  - Traffic Jam Assist ..... **313**
  - BSM (Blind Spot Monitor).... **319**
  - Safe Exit Assist..... **323**
  - Intuitive parking assist..... **328**
  - RCTA (Rear cross traffic alert) function..... **337**

RCD (Rear Camera Detection) function.....	342
PKSB (Parking Support Brake) .....	345
Lexus Teammate Advanced Park .....	356
Driving mode select switch...	390
Trail Mode.....	392
Driving assist systems.....	393

#### 4-6. Driving tips

Hybrid electric vehicle driving tips .....	400
Winter driving tips .....	402
Utility vehicle precautions.....	405

## Driving the vehicle

The following procedures should be observed to ensure safe driving:

### Driving procedure

#### ■ Starting the hybrid system

→P.208

#### ■ Driving

- 1 With the brake pedal depressed, shift the shift position to D.  
(→P.220)

Check that the shift position indicator shows D.

- 2 If the parking brake is set, release the parking brake. (→P.226)

If the parking brake is in automatic mode, the parking brake will be released automatically. (→P.227)

- 3 Gradually release the brake pedal and gently depress the accelerator pedal to accelerate the vehicle.

#### ■ Stopping

- 1 Depress the brake pedal.
- 2 If necessary, set the parking brake.  
(→P.226)

If the vehicle is to be stopped for an extended period of time, shift the shift position to P. (→P.214, 220)

#### ■ Parking the vehicle

- 1 Depress the brake pedal to stop the vehicle completely.
- 2 If the parking brake is released, set the parking brake. (→P.226)
- 3 Shift the shift position to P.  
(→P.214, 220)

Check that the shift position indicator shows P and the parking brake indicator is illuminated.

- 4 Press the power switch to stop the hybrid system.
- 5 Slowly release the brake pedal.
- 6 Lock the door, making sure that you have the electronic key on your person.

If parking on a hill, block the wheels as needed.

#### ■ Starting off on a steep uphill

- 1 Firmly depress the brake pedal and shift the shift position to D.  
(→P.214, 220)

The hill-start assist control will be activated.

- 2 Set the parking brake. (→P.226)
- 3 Release the brake pedal and gently depress the accelerator pedal to accelerate the vehicle.
- 4 Release the parking brake.  
(→P.226)

#### ■ For fuel-efficient driving

Keep in mind that hybrid vehicles are similar to conventional vehicles, and it is necessary to refrain from activities such as sudden acceleration. (→P.400)

#### ■ Driving in the rain

- Drive carefully when it is raining, because visibility will be reduced, the windows may become fogged-up, and the road will be slippery.
- Drive carefully when it starts to rain, because the road surface will be especially slippery.
- Refrain from high speeds when driving on an expressway in the rain, because there may be a layer of water between the tires and the road surface, preventing the steering and brakes from operating properly.

### ■ Engine speed while driving (RX500h)

In the following conditions, the engine speed may become high while driving. This is due to automatic up-shifting control or down-shifting implementation to meet driving conditions. It does not indicate sudden acceleration.

- The vehicle is judged to be driving uphill or downhill
- When the accelerator pedal is released
- When the brake pedal is depressed while sport mode is selected

### ■ Restraining the hybrid system output (Brake Override System)

- When the accelerator and brake pedals are depressed at the same time, the hybrid system output may be restrained.
- A warning message is displayed on the multi-information display while the system is operating.

### ■ Breaking in your new Lexus

To extend the life of the vehicle, observing the following precautions is recommended:

- For the first 200 miles (300 km):

Avoid sudden stops.

- For the first 500 miles (800 km):

Do not tow a trailer. (vehicles with towing package)

- For the first 1000 miles (1600 km):
  - Do not drive at extremely high speeds.
  - Avoid sudden acceleration.
  - Do not drive continuously in low gears.
  - Do not drive at a constant speed for extended periods.

### ■ Operating your vehicle in a foreign country

Comply with the relevant vehicle registration laws and confirm the availability of the correct fuel. (→P.570)

### ■ Idling time before engine stop (RX500h)

To prevent damage to the turbocharger, allow the hybrid system to idle immediately after high-load driving.

Driving condition	Idling time
Normal city driving or high-speed driving (at the highway speed limit or recommended speed)	Not necessary
Steep hill driving, continuous driving (race track driving etc.), or towing a trailer or another vehicle (vehicles with towing package)	Approximately 1 minute

### ■ Eco-friendly driving

→P.97

### WARNING

Observe the following precautions. Failure to do so may result in death or serious injury.

#### ■ When starting the vehicle

Always keep your foot on the brake pedal while stopped with the “READY” indicator is illuminated. This prevents the vehicle from creeping.

#### ■ When driving the vehicle

- Do not drive if you are unfamiliar with the location of the brake and accelerator pedals to avoid depressing the wrong pedal.
- Accidentally depressing the accelerator pedal instead of the brake pedal will result in sudden acceleration that may lead to an accident.
- When backing up, you may twist your body around, leading to a difficulty in operating the pedals. Make sure to operate the pedals properly.
- Make sure to keep a correct driving posture even when moving the vehicle only slightly. This allows you to depress the brake and accelerator pedals properly.

 **WARNING**

- Depress the brake pedal using your right foot. Depressing the brake pedal using your left foot may delay response in an emergency, resulting in an accident.
- The driver should pay extra attention to pedestrians when the vehicle is powered only by the electric motor (traction motor). As there is no engine noise, the pedestrians may misjudge the vehicle's movement. Even though the vehicle is equipped with the Acoustic Vehicle Alerting System, drive with care as pedestrians in the vicinity may still not notice the vehicle if the surrounding area is noisy.
- Do not drive the vehicle over or stop the vehicle near flammable materials. The exhaust system and exhaust gases can be extremely hot. These hot parts may cause a fire if there is any flammable material nearby.
- During normal driving, do not turn off the hybrid system. Turning the hybrid system off while driving will not cause loss of steering or braking control, however, power assist to the steering will be lost. This will make it more difficult to steer smoothly, so you should pull over and stop the vehicle as soon as it is safe to do so.  
In the event of an emergency, such as if it becomes impossible to stop the vehicle in the normal way: →P.510
- Use engine braking (downshift) to maintain a safe speed when driving down a steep hill.  
Using the brakes continuously may cause the brakes to overheat and lose effectiveness. (→P.214, 220)
- Do not adjust the positions of the steering wheel, the seat, or the inside or outside rear view mirrors while driving.  
Doing so may result in a loss of vehicle control.

- Always check that all passengers' arms, heads or other parts of their body are not outside the vehicle.
- This vehicle is not designed for extreme off-roading.  
When driving in sand or mud is unavoidable, drive carefully and avoid continuous driving on sand or mud.
- Do not drive across a river or through other bodies of water.  
This may cause electric/electronic components to short circuit, damage the hybrid system or cause other serious damage to the vehicle.
- Do not drive in excess of the speed limit. Even if the legal speed limit permits it, do not drive over 85 mph (140 km/h) unless your vehicle has high-speed capability tires. Driving over 85 mph (140 km/h) may result in tire failure, loss of control and possible injury. Be sure to consult a tire dealer to determine whether the tires on your vehicle are high-speed capability tires or not before driving at such speeds.
- **When driving on slippery road surfaces**
  - Sudden braking, acceleration and steering may cause tire slippage and reduce your ability to control the vehicle.
  - Sudden acceleration, engine braking due to shifting, or changes in engine speed could cause the vehicle to skid.
  - After driving through a puddle, lightly depress the brake pedal to make sure that the brakes are functioning properly. Wet brake pads may prevent the brakes from functioning properly. If the brakes on only one side are wet and not functioning properly, steering control may be affected.

**WARNING**
**■ When shifting the shift position**

- Do not let the vehicle roll backward while a forward driving position is selected, or roll forward while the shift position is in R. Doing so may result in an accident or damage to the vehicle.
- Do not shift the shift position to P while the vehicle is moving. Doing so can damage the transmission and may result in a loss of vehicle control.
- Do not shift the shift position to R while the vehicle is moving forward. Doing so can damage the transmission and may result in a loss of vehicle control.
- Do not shift the shift position to a driving position while the vehicle is moving backward. Doing so can damage the transmission and may result in a loss of vehicle control.
- Changing the shift position to N while the vehicle is moving will disengage the hybrid system. Regenerative braking is not available with the hybrid system disengaged.
- Be careful not to change the shift position with the accelerator pedal depressed. Changing the shift position to any positions other than P or N may lead to unexpected rapid acceleration of the vehicle that may cause an accident and result in death or serious injury. After changing the shift position, make sure to confirm the current shift position displayed on the shift position indicator inside the meter.

**■ If you hear a squealing or scraping noise (brake pad wear limit indicators)**

Have the brake pads checked and replaced by your Lexus dealer as soon as possible.

Rotor damage may result if the pads are not replaced when needed.

It is dangerous to drive the vehicle when the wear limits of the brake pads and/or those of the brake discs are exceeded.

**■ When the vehicle is stopped**

- Do not depress the accelerator pedal unnecessarily. If the shift position is in any position other than P or N, the vehicle may accelerate suddenly and unexpectedly, causing an accident.
- In order to prevent accidents due to the vehicle rolling away, always keep depressing the brake pedal while stopped with the "READY" indicator is illuminated, and apply the parking brake as necessary.
- If the vehicle is stopped on an incline, in order to prevent accidents caused by the vehicle rolling forward or backward, always depress the brake pedal and securely apply the parking brake as needed.
- Avoid revving or racing the engine. Running the engine at high speed while the vehicle is stopped may cause the exhaust system to overheat, which could result in a fire if combustible material is nearby.

**■ When the vehicle is parked**

- Do not leave glasses, cigarette lighters, spray cans, or soft drink cans in the vehicle when it is in the sun. Doing so may result in the following:
  - Gas may leak from a cigarette lighter or spray can, and may lead to a fire.

**WARNING**

- The temperature inside the vehicle may cause the plastic lenses and plastic material of glasses to deform or crack.
- Soft drink cans may fracture, causing the contents to spray over the interior of the vehicle, and may also cause a short circuit in the vehicle's electrical components.
- Do not leave cigarette lighters in the vehicle. If a cigarette lighter is in a place such as the glove box or on the floor, it may be lit accidentally when luggage is loaded or the seat is adjusted, causing a fire.
- Do not attach adhesive discs to the windshield or windows. Do not place containers such as air fresheners on the instrument panel or dashboard. Adhesive discs or containers may act as lenses, causing a fire in the vehicle.
- Do not leave a door or window open if the curved glass is coated with a metallized film such as a silver-colored one. Reflected sunlight may cause the glass to act as a lens, causing a fire.
- Always apply the parking brake, shift the shift position to P, stop the hybrid system and lock the vehicle. Do not leave the vehicle unattended while the "READY" indicator is illuminated. If the vehicle is parked with the shift position in P but the parking brake is not set, the vehicle may start to move, possibly leading to an accident.
- Do not touch the exhaust pipes while the "READY" indicator is illuminated or immediately after turning the hybrid system off. Doing so may cause burns.

**■ When taking a nap in the vehicle**

Always turn the hybrid system off. Otherwise, if you accidentally move the shift lever or depress the accelerator pedal, this could cause an accident or fire due to hybrid system overheating. Additionally, if the vehicle is parked in a poorly ventilated area, exhaust gases may collect and enter the vehicle, leading to death or a serious health hazard.

**■ When braking**

- When the brakes are wet, drive more cautiously. Braking distance increases when the brakes are wet, and this may cause one side of the vehicle to brake differently than the other side. Also, the parking brake may not securely hold the vehicle.
- If the electronically controlled brake function does not operate, do not follow other vehicles closely and avoid hills or sharp turns that require braking. In this case, braking is still possible, but the brake pedal should be depressed more firmly than usual. Also, the braking distance will increase. Have your brakes fixed immediately.
- The brake system consists of 2 or more individual hydraulic systems; if one of the systems fails, the other(s) will still operate. In this case, the brake pedal should be depressed more firmly than usual and the braking distance will increase. Have your brakes fixed immediately.

**■ If the vehicle becomes stuck**

Do not spin the wheels excessively when any of the tires is up in the air, or the vehicle is stuck in sand, mud, etc. This may damage the driveline components or propel the vehicle forward or backward, causing an accident.



## NOTICE

### ■ When driving the vehicle

- Do not depress the accelerator and brake pedals at the same time during driving, as this may restrain the hybrid system output.
- Do not use the accelerator pedal or depress the accelerator and brake pedals at the same time to hold the vehicle on a hill.

### ■ Avoiding damage to vehicle parts

- Do not turn the steering wheel fully in either direction and hold it there for an extended period of time. Doing so may damage the power steering motor.
- When driving over bumps on the road, drive as slowly as possible to avoid damaging the wheels, underside of the vehicle, etc.
- RX500h: Make sure to idle the engine immediately after high-load driving. Stop the engine only after the turbocharger has cooled down. Failure to do so may cause damage to the turbocharger.

### ■ If you get a flat tire while driving

A flat or damaged tire may cause the following situations. Hold the steering wheel firmly and gradually depress the brake pedal to slow down the vehicle.

- It may be difficult to control your vehicle.
- The vehicle will make abnormal sounds or vibrations.
- The vehicle will lean abnormally.

Information on what to do in case of a flat tire (→P.539)

### ■ When encountering flooded roads

Do not drive on a road that has flooded after heavy rain etc. Doing so may cause the following serious damage to the vehicle:

- Engine stalling
- Short in electrical components
- Engine damage caused by water immersion

In the event that you drive on a flooded road and the vehicle is flooded, be sure to have your Lexus dealer check the following:

- Brake function
- Changes in quantity and quality of oil and fluid used for the engine, transmission, transaxle, etc.
- Lubricant condition for bearings and suspension joints (where possible), and the function of all joints, bearings, etc.

If the shift control system is damaged by flooding, it may not be possible to shift the shift position to P, or from P to other positions. In this case, contact your Lexus dealer.

### ■ When parking the vehicle

Always set the parking brake and shift the shift position to P. Failure to do so may cause the vehicle to move or the vehicle may accelerate suddenly if the accelerator pedal is accidentally depressed.

## Sudden start restraint control (Drive-Start Control [DSC])

When the following unusual operation is performed with the accelerator pedal depressed, the hybrid system output may be restrained.

- When the shift position is shifted to R\*.
- When the shift position is shifted from P or R to forward drive shift position such as D\*.

When the system operates, a message appears on the multi-information display. Read the message and follow the instruction.

\*: Depending on the situation, the shift position may not be changed.

### ■ Drive-Start Control (DSC)

When the TRAC is turned off (→P.395), sudden start restraint control also does not operate. If your vehicle have trouble escaping from the mud or fresh snow due to sudden start restraint control operation, deactivate TRAC (→P.395) so that the vehicle may become able to escape from the mud or fresh snow.

Also, sudden start restraint control will not operate in the following conditions:

- When Trail Mode is turned on

## Cargo and luggage

Take notice of the following information about storage precautions, cargo capacity and load.

### Capacity and distribution

Cargo capacity depends on the total weight of the occupants.

(Cargo capacity) = (Total load capacity) – (Total weight of occupants)

Steps for Determining Correct Load Limit –

(1) Locate the statement “The combined weight of occupants and cargo should never exceed XXX kg or XXX lbs.” on your vehicle’s placard.

(2) Determine the combined weight of the driver and passengers that will be riding in your vehicle.

(3) Subtract the combined weight of the driver and passengers from XXX kg or XXX lbs.

(4) The resulting figure equals the available amount of cargo and luggage load capacity.

For example, if the “XXX” amount equals 1400 lbs. and there will be five 150 lb passengers in your vehicle, the amount of available cargo and luggage load capacity is 650 lbs. (1400 – 750 (5 × 150) = 650 lbs.)

(5) Determine the combined weight of luggage and cargo being loaded on the vehicle. That weight may not safely exceed the available cargo and lug-

gage load capacity calculated in Step 4.

(6) If your vehicle will be towing a trailer, load from your trailer will be transferred to your vehicle. Consult this manual to determine how this reduces the available cargo and luggage load capacity of your vehicle. (→P.196)

Vehicles without towing package: Lexus does not recommend towing a trailer with your vehicle. Your vehicle is not designed for trailer towing.

### Calculation formula for your vehicle

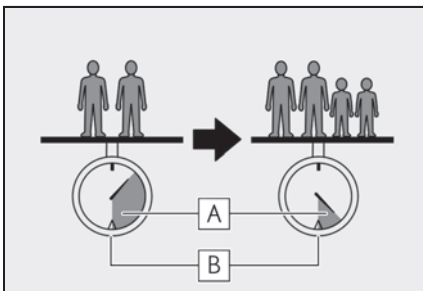

**A** Cargo capacity

**B** Total load capacity (vehicle capacity weight) (→P.568)

When 2 people with the combined weight of A lb. (kg) are riding in your vehicle, which has a total load capacity (vehicle capacity weight) of B lb. (kg), the available amount of cargo and luggage load capacity will be C lb. (kg) as follows:

$$B^{*2} \text{ lb. (kg)} - A^{*1} \text{ lb. (kg)} = C^{*3} \text{ lb. (kg)}$$

<sup>\*1</sup>: A =Weight of people

<sup>\*2</sup>: B =Total load capacity

<sup>\*3</sup>: C =Available cargo and luggage load

In this condition, if 3 more passengers with the combined weight of D lb. (kg) get on, the available cargo and luggage load will be reduced E lb. (kg) as follows:

$$C \text{ lb. (kg)} - D^{*4} \text{ lb. (kg)} = E^{*5} \text{ lb. (kg)}$$

<sup>\*4</sup>: D =Additional weight of people

<sup>\*5</sup>: E =Available cargo and luggage load

As shown in the example above, if the number of occupants increases, the cargo and luggage load will be reduced by an amount that equals the increased weight due to the additional occupants. In other words, if an increase in the number of occupants causes an excess of the total load capacity (combined weight of occupants plus cargo and luggage load), you must reduce the cargo and luggage on your vehicle.

### **!** WARNING

#### ■ Things that must not be carried in the luggage compartment

The following things may cause a fire if loaded in the luggage compartment:

- Receptacles containing gasoline
- Aerosol cans

#### ■ Storage precautions

Observe the following precautions. Failure to do so may prevent the pedals from being depressed properly, may block the driver's vision, or may result in items hitting the driver or passengers, possibly causing an accident.

- Stow cargo and luggage in the luggage compartment whenever possible.

**WARNING**

- Do not stack cargo and luggage in the luggage compartment higher than the seatbacks.
- When you fold down the rear seats, long items should not be placed directly behind the front seats.
- Never allow anyone to ride in the luggage compartment. It is not designed for passengers. They should ride in their seats with their seat belts properly fastened.
- Do not place cargo or luggage in or on the following locations.
  - At the feet of the driver
  - On the front passenger or rear seats (when stacking items)
  - On the luggage cover
  - On the instrument panel
  - On the dashboard
- Secure all items in the occupant compartment.

**Capacity and distribution**

- Do not exceed the maximum axle weight rating or the total vehicle weight rating.
- Even if the total load of occupant's weight and the cargo load is less than the total load capacity, do not apply the load unevenly. Improper loading may cause deterioration of steering or braking control which may cause death or serious injury.

**When using a roof luggage carrier (vehicles with roof rails)**

Observe the following precautions:

- Place the cargo so that its weight is distributed evenly between the front and rear axles.

- If loading long or wide cargo, never exceed the vehicle overall length or width. (→P.568)
- Before driving, make sure the cargo is securely fastened on the roof luggage carrier.
- Loading cargo on the roof luggage carrier will make the center of gravity of the vehicle higher. Avoid high speeds, sudden starts, sharp turns, sudden braking or abrupt maneuvers, otherwise it may result in loss of control or vehicle rollover due to failure to operate this vehicle correctly and result in death or serious injury.
- If driving for a long distance, on rough roads, or at high speeds, stop the vehicle now and then during the trip to make sure the cargo remains in its place.
- Do not exceed 154 lb. (70 kg) cargo weight on the roof luggage carrier.

**NOTICE****When loading cargo (vehicles with a moon roof or panoramic moon roof)**

Be careful not to scratch the surface of the moon roof or panoramic moon roof.

## Vehicle load limits

Vehicle load limits include total load capacity, seating capacity, trailer weight rating and cargo capacity.

- Total load capacity (vehicle capacity weight): →P.568

Total load capacity means the combined weight of occupants, cargo and luggage.

- Seating capacity: →P.568

Seating capacity means the maximum number of occupants whose estimated average weight is 150 lb. (68 kg) per person.

- TWR (Trailer Weight Rating) (vehicles with towing package): →P.202, 568

TWR means the maximum gross trailer weight (trailer weight plus its cargo weight) that your vehicle is able to tow.

- TWR (Trailer Weight Rating) (vehicles without towing package)

Lexus does not recommend towing a trailer with your vehicle.

- Cargo capacity

Cargo capacity may increase or decrease depending on the weight and the number of occupants.



### WARNING

#### Overloading the vehicle

Do not overload the vehicle. It may not only cause damage to the tires, but also degrade steering and braking ability, resulting in an accident.

#### ■ Total load capacity and seating capacity

These details are also described on the tire and loading information label. (→P.493)

### Trailer towing (vehicles without towing package)

Lexus does not recommend towing a trailer with your vehicle. Lexus also does not recommend the installation of a tow hitch or the use of a tow hitch carrier for a wheelchair, scooter, bicycle, etc. Your vehicle is not designed for trailer towing or for the use of tow hitch mounted carriers.



### Trailer towing (vehicles with towing package)

Your vehicle is designed primarily as a passenger-and-load-carrying vehicle. Towing a trailer can have an adverse impact on handling, performance, braking, durability, and fuel consumption. For your safety and the safety of others, you must not overload your vehicle or trailer. You must also ensure that you are using appropriate towing equipment, that the towing equipment has been installed correctly and used properly, and that you employ the requisite driving habits.

Vehicle-trailer stability and braking performance are affected by trailer stability, brake performance and setting, trailer brakes, the hitch and hitch systems (if equipped).

To tow a trailer safely, use extreme care and drive the vehicle in accordance with your trailer's characteristics and operating conditions.

Lexus warranties do not apply to damage or malfunction caused by towing a trailer for commercial purposes.

Contact your Lexus dealer for further information about additional requirements such as a towing kit, etc.

- Matching trailer ball height to trailer coupler height

No matter which class of tow hitch applies,

for a more safe trailer hookup, the trailer ball setup must be the proper height for the coupler on the trailer.

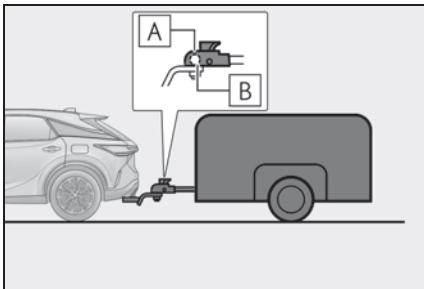
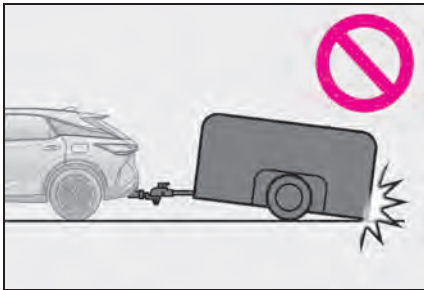

**A** Coupler

**B** Trailer ball

### ■ Before towing

Check that the following conditions are met:

- Ensure that your vehicle's tires are properly inflated. (→P.576)
- Trailer tires are inflated according to the trailer manufacturer's recommendation.
- All trailer lights work as required by law.
- All lights work each time you connect them.
- The trailer ball is set at the proper height for the coupler on the trailer.
- The trailer is level when it is hitched.  
Do not drive if the trailer is not level, and check for improper tongue weight, overloading, worn suspension, or other possible causes.
- The trailer cargo is securely loaded.
- The rear view mirrors conform to all applicable federal, state/provincial or

local regulations. If they do not, install rear view mirrors appropriate for towing purposes.

### ■ Adaptive Variable Suspension System (if equipped)

The suspension can be switched for improvement in driveability. (→P.394)

### ■ When towing a trailer

Disable the following systems, as the systems may not operate properly.

- LTA (Lane Tracing Assist) (→P.271)
- LCA (Lane Change Assist) (if equipped) (→P.276)
- LDA (Lane Departure Alert) (→P.279)
- Dynamic radar cruise control (→P.295)
- Cruise control (→P.306)
- BSM (Blind Spot Monitor) (→P.319)
- Intuitive parking assist (if equipped) (→P.328)
- RCTA (Rear Cross Traffic Alert) function (→P.337)
- RCD (Rear Camera Detection) function (if equipped) (→P.342)
- PKSB (Parking Support Brake) (if equipped) (→P.345)

### ■ Break-in schedule

If your vehicle is new or equipped with any new power train components (such as an engine, hybrid transmission, rear differential or wheel bearing), Lexus recommends that you do not tow a trailer until the vehicle has been driven for over 500 miles (800 km).

After the vehicle has been driven for over 500 miles (800 km), you can start towing. However, for the next 500 miles (800 km), drive the vehicle at a speed of less than 50 mph (80 km/h) when towing a trailer, and avoid full throttle acceleration.

### ■ Maintenance

- If you tow a trailer, your vehicle will require more frequent maintenance due to the additional load. (See "Warranty and Services Guide", "Owner's Manual Supplement" or "Scheduled Maintenance".)
- Retighten the fixing bolts of the towing ball and bracket after approximately 600 miles (1000 km) of trailer towing.

### ■ If trailer sway occurs

One or more factors (crosswinds, passing vehicles, rough roads, etc.) can adversely affect handling of your vehicle and trailer, causing instability.

#### ● If trailer swaying occurs:

- Firmly grip the steering wheel. Steer straight ahead.  
Do not try to control trailer swaying by turning the steering wheel.
- Begin releasing the accelerator pedal immediately but very gradually to reduce speed.  
Do not increase speed. Do not apply vehicle brakes.

If you make no extreme correction with the steering or brakes, your vehicle and trailer should stabilize. (if enabled, Trailer Sway Control can also help to stabilize the vehicle and trailer.)

#### ● After the trailer swaying has stopped:

- Stop in a safe place. Get all occupants out of the vehicle.
- Check the tires of the vehicle and the trailer.
- Check the load in the trailer.  
Make sure the load has not shifted.  
Make sure the tongue weight is appropriate, if possible.
- Check the load in the vehicle.  
Make sure the vehicle is not overloaded after occupants get in.

If you cannot find any problems, the speed at which trailer swaying occurred is beyond the limit of your particular vehicle-trailer combination. Drive at a lower speed to prevent instability. Remember that swaying of the towing vehicle-trailer increases as speed increases.



## WARNING

### ■ Trailer towing precautions

To tow a trailer safely, use extreme care and drive the vehicle in accordance with the trailer's characteristics and operating conditions. Failure to do so could cause an accident resulting in death or serious injury. Vehicle stability and braking performance are affected by trailer stability, brake setting and performance, and the hitch. Your vehicle will handle differently when towing a trailer.

### ■ To avoid accident or injury

- Do not exceed the TWR, unbraked TWR, GCWR, GVWR or GAWR.
- If the gross trailer weight is over 2000 lb. (907 kg), a sway control device with sufficient capacity is required.
- Adjust the tongue weight within the appropriate range. Place heavier loads as close to the trailer axle as possible.
- Do not exceed 65 mph (104 km/h), the posted towing speed limit or the speed limit for your trailer as set forth in your trailer owner's manual, whichever is lowest. Slow down sufficiently before making a turn, in cross winds, on wet or slippery surface, etc. to help avoid an accident. If you experience a vehicle-trailer instability from reducing a certain speed, slow down and make sure you keep your vehicle speed under the speed of which you experience the instability.
- Do not make jerky, abrupt or sharp turns.
- Do not apply the brakes suddenly as you may skid, resulting in jackknifing and loss of vehicle control. This is especially true on wet or slippery surfaces.
- Do not exceed the trailer hitch assembly weight, gross vehicle weight, gross axle weight and trailer tongue weight capacities.

### WARNING

- Slow down and downshift before descending steep or long downhill grades. Do not make sudden downshifts while descending steep or long downhill grades.
  - Vehicle-trailer instability is more likely on steep long downhills. Before descending steep or long downhill grades, slow down and downshift. Do not make sudden downshifts when descending steep or long downhill grades. Avoid holding the brake pedal down too long or applying the brakes too frequently. This could cause the brakes to overheat and result in reduced braking efficiency.
  - Do not tow a trailer when the compact spare tire is installed on your vehicle.
- When towing a trailer**
- Lexus recommends trailers with brakes that conform to any applicable federal and state/provincial regulations.
- If the gross trailer weight exceeds unbraked TWR, trailer brakes are required. Lexus recommends trailers with brakes that conform to all applicable federal and state/provincial regulations.
  - Never tap into your vehicle's hydraulic system, as this will lower the vehicle's braking effectiveness.
  - Never tow a trailer without using a safety chain securely attached to both the trailer and the vehicle. If damage occurs to the coupling unit or hitch ball, there is danger of the trailer wandering into another lane.

### NOTICE

#### ■ When installing a trailer hitch

Use only the position recommended by your Lexus dealer. Do not install the trailer hitch on the bumper; this may cause body damage.

#### ■ Do not directly splice trailer lights

Do not directly splice trailer lights. Directly splicing trailer lights may damage your vehicle's electrical system and cause a malfunction.

## Towing related terms

### ■ GCWR (Gross Combination Weight Rating)

The maximum allowable gross combination weight. The gross combination weight is the sum of the total vehicle weight (including the occupants, cargo and any optional equipment installed on the vehicle) and the weight of the trailer being towed (including the cargo in the trailer).

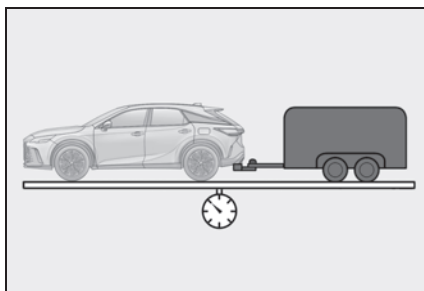

### ■ GVWR (Gross Vehicle Weight Rating)

The maximum allowable gross vehicle weight. The gross vehicle weight is the total weight of the vehicle. When towing a trailer, it is the sum of the vehicle weight (including the occupants, cargo

and any optional equipment installed on the vehicle) and the tongue weight.

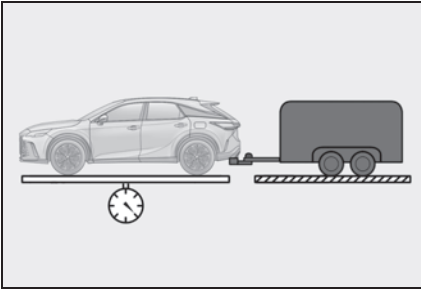

### ■ GAWR (Gross Axle Weight Rating)

The maximum allowable gross axle weight. The gross axle weight is the load placed on each axle (front and rear).

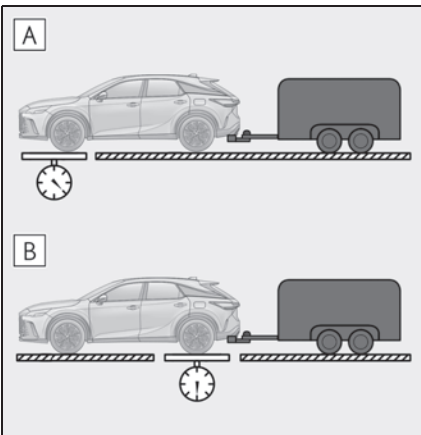

**A** Front GAWR

**B** Rear GAWR

### ■ TWR (Trailer Weight Rating)

The maximum allowable gross trailer weight. The gross trailer weight is the sum of the trailer weight and the weight of the cargo in the trailer.

TWR is calculated assuming base vehicle with one driver, one front passen-

ger, towing package (if available), hitch and hitch systems (if required).

Additional optional equipment, passengers and cargo in the vehicle will reduce the trailer weight rating so as not to exceed GCWR, GVWR and GAWR.

If the gross trailer weight exceeds 3000 lb. (1360 kg), it is recommended to use a trailer with 2 or more axles.

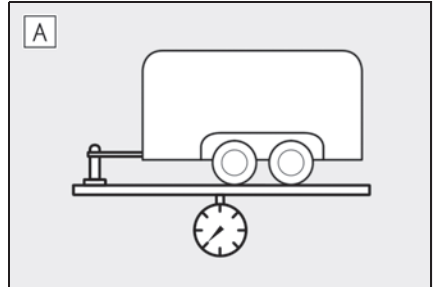

**A** With brakes

### ■ Unbraked TWR (Unbraked Trailer Weight Rating)

The trailer weight rating for towing a trailer without a trailer service brake system.

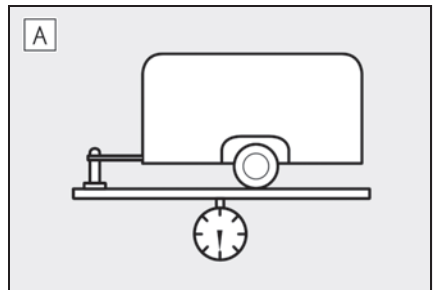

**A** Without brakes

### ■ Tongue Weight

The load placed on the trailer hitch ball. (→P.202)

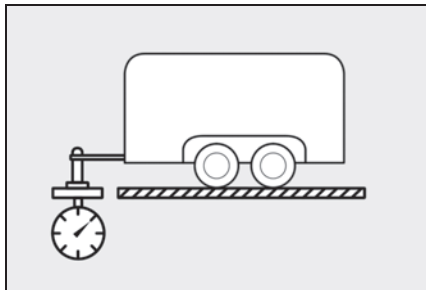

### Weight limits

- The gross trailer weight must never exceed 3500 lb. (1585 kg).
- The gross combination weight must never exceed the following:
  - ▶ RX350h  
9250 lb. (4195 kg)
  - ▶ RX500h  
9495 lb. (4306 kg)
- The gross vehicle weight must never exceed the GVWR indicated on the Certification Label. (→P.568)
- The gross axle weight on each axle must never exceed the GAWR indicated on the Certification Label. (→P.568)
- If the gross trailer weight is over the unbraked TWR, trailer service brakes are required.
- If the gross trailer weight is over 2000 lb. (907 kg), a sway control device with sufficient capacity is required.

### GCWR, TWR and Unbraked TWR

Confirm that the gross trailer weight,

gross combination weight, gross vehicle weight, gross axle weight and tongue weight are all within the limits.

#### ■ GCWR\*

- ▶ RX350h  
9250 lb. (4195 kg)
- ▶ RX500h  
9495 lb. (4306 kg)

#### ■ TWR\*

3500 lb. (1585 kg)

#### ■ Unbraked TWR\*

1000 lb. (453 kg)

\*: This models meet the tow-vehicle trailering requirement of SAE International per SAE J2807.

### Trailer Tongue Weight

- A recommended tongue weight varies in accordance with the types of trailers or towing as described below.
- To ensure the recommended values shown below, the trailer must be loaded by referring to the following instructions.
  - Tongue Weight

The gross trailer weight should be distributed so that the tongue weight is 9% to 11%.

(Tongue weight/Gross trailer weight x 100 = 9% to 11%)

The gross trailer weight, gross axle weight and tongue weight can be measured with platform scales found at a highway weighing station, building supply company, trucking company, junk yard, etc.

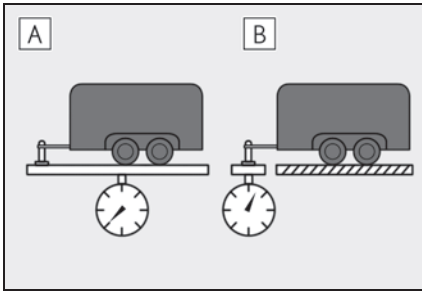

**A** Gross trailer weight

**B** Tongue weight

## Hitch

Trailer hitch assemblies have different weight capacities. Lexus recommends the use of Lexus hitch/bracket for your vehicle. For details, contact your Lexus dealer.

- If you wish to install a trailer hitch, contact your Lexus dealer.
- Use only a hitch that conforms to the gross trailer weight requirement of your vehicle.
- Follow the directions supplied by the hitch manufacturer.
- Lubricate the hitch ball with a light coating of grease.
- Remove the hitch ball whenever you are not towing a trailer. Remove the trailer hitch if you do not need it. After removing the hitch, seal any mounting hole in the vehicle body to prevent entry of any substances into the vehicle.

## ⚠ WARNING

### Hitches

Trailer hitch assemblies have different weight capacities established by the hitch manufacturer. Even though the vehicle may be physically capable of towing a higher weight, the operator must determine the maximum weight rating of the particular hitch assembly and never exceed the maximum weight rating specified for the trailer-hitch. Exceeding the maximum weight rating set by the trailer-hitch manufacturer can cause an accident resulting in death or serious personal injuries.

## Selecting trailer ball

Use the correct trailer ball for your application.

Trailer class	Typical trailer ball size
IV	2 5/16 in.
II and III	2 in.
I	1 7/8 in.

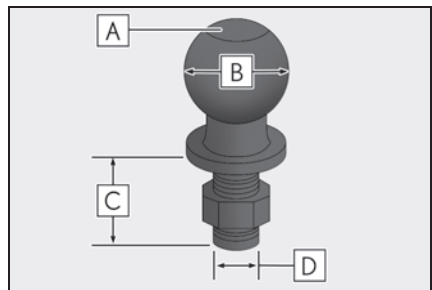

**A** Trailer ball load rating

Matches or exceeds the gross trailer weight rating of the trailer.

**B** Ball diameter

Matches the size of the trailer coupler. Most couplers are stamped with the required trailer ball size.

**C** Shank length

Protrudes beyond the bottom of the lock washer and nut by at least 2 threads.

**D** Shank diameter

Matches the ball mount hole diameter size.

### Positions for towing hitch receiver and hitch ball

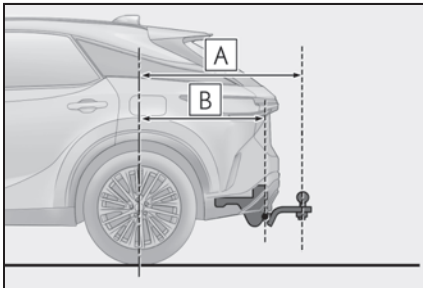

**A** Weight carrying ball position:  
40.75 in. (1035 mm)

**B** Hitch receiver pin hole position:  
33.50 in. (851 mm)

### Connecting trailer lights (if equipped)

Use the wire harness stored in the rear end under body.

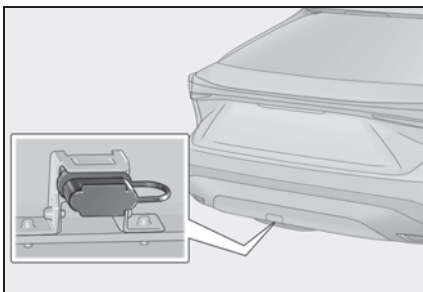
**■ Auto current cut-off function**

In case of over current, the auto cut-off function stops the power flowing to the

trailer lights to prevent damage to the vehicle's electrical system.

This function is activated when the rated current of any of the following trailer light circuit components is exceeded:

- Tail lights: maximum 7.8 A
- Stop/turn signal light (right): maximum 4.5 A
- Stop/turn signal light (left): maximum 4.5 A

**■ When the auto current cut function is activated**

If a trailer light does not come on due to the activation of the auto current cut function, the light system will need to be reset.

Follow the reset procedure shown below.

- If a tail light does not come on, turn off the headlight switch.
- If the right-side stop/turn signal light does not come on, put the turn signal in the off position or remove foot from the brake pedal.
- If the left-side stop/turn signal light does not come on, put the turn signal in the off position or remove foot from the brake pedal.

If the emergency flashers do not operate, press the emergency flasher switch to turn them off.

After the light system is reset, operate the light switches again to see if the lights operate normally.

If the lights do not operate normally, have the vehicle inspected by your Lexus dealer.

### Trailer towing tips

Your vehicle will handle differently when towing a trailer. Help to avoid an accident, death or serious injury, keep the following in mind when towing:

- Speed limits for towing a trailer vary by state or province. Do not exceed the posted towing speed limit.

- Lexus recommends that the vehicle-trailer speed limit is 65 mph (104 km/h) on a flat, straight, dry road. Do not exceed this limit, the posted towing speed limit or the speed limit for your trailer as set forth in your trailer owner's manual, whichever is lowest. Instability of the towing vehicle-trailer combination (trailer sway) increases as speed increases. Exceeding speed limits may cause loss of control.
  - Before starting out, check the trailer lights, tires and the vehicle-trailer connections. Recheck after driving a short distance.
  - Practice turning, stopping and reversing with the trailer attached in an area away from traffic until you become accustomed to the feel of the vehicle-trailer combination.
  - Reversing with a trailer attached is difficult and requires practice. Grip the bottom of the steering wheel and move your hand to the left to move the trailer to the left. Move your hand to the right to move the trailer to right. (This is generally opposite to reversing without a trailer attached.) Avoid sharp or prolonged turning. Have someone guide you when reversing to reduce the risk of an accident.
  - As stopping distance is increased when towing a trailer, vehicle-to-vehicle distance should be increased. For each 10 mph (16 km/h) of speed, allow at least one vehicle and trailer length.
  - Avoid sudden braking as you may skid, resulting in the trailer jackknifing and a loss of vehicle control. This is especially true on wet or slippery surfaces.
  - Avoid jerky starts or sudden acceleration.
  - Avoid jerky steering and sharp turns, and slow down before making turn.
  - Note that when making a turn, the trailer wheels will be closer than the vehicle wheels to the inside of the turn. Compensate by making a wider than normal turning radius.
  - Slow down before making a turn, in cross winds, on wet or slippery surfaces, etc. Increasing vehicle speed can destabilize the trailer.
  - Take care when passing other vehicles. Passing requires considerable distance. After passing a vehicle, do not forget the length of your trailer, and be sure you have plenty of room before changing lanes.
  - To maintain engine braking efficiency and charging system performance when using engine braking, do not put the transmission in D.
- RX500h: If in the M mode, the hybrid transmission shift range position must be in 6 or lower. (→P.214)
- RX350h: If in the S mode, the hybrid transmission shift range position must be in 5 or lower. (→P.220)
- Instability happens more frequently when descending steep or long downhill grades. Before descend-

ing, slow down and downshift. Do not make sudden downshifts while descending steep or long downhill grades.

- Avoid holding the brake pedal down too long or applying the brakes too frequently. This could cause the brakes to overheat and result in reduced braking efficiency.
- Due to the added load of the trailer, your vehicle's engine may overheat on hot days (at temperatures over 85°F [30°C]) when driving up a long or steep grade. If the engine coolant temperature gauge indicates overheating, immediately turn off the air conditioning (if in use), pull your vehicle off the road and stop in a safe spot. (→P.560)
- Always place wheel blocks under both the vehicle's and the trailer's wheels when parking. Put the transmission in P and apply the parking brake. Avoid parking on a slope, but if unavoidable, do so only after performing the following:
  - 1 Apply the brakes and keep them applied.
  - 2 Have someone place wheel blocks under both the vehicle's and trailer's wheels.
  - 3 When the wheel blocks are in place, release the brakes slowly until the blocks absorb the load.
  - 4 Shift into P and apply the parking brake.
  - 5 Turn off the hybrid system.
- When restarting after parking on a slope:
  - 1 With the transmission in P, start the hybrid system. Be sure to keep the brake pedal depressed.
  - 2 Shift into a forward gear. If reversing, shift into R.
  - 3 If the parking brake is in manual mode, release the parking brake. (→P.226)
  - 4 Release the brake pedal, and slowly pull or back away from the wheel blocks. Stop and apply the brakes.
  - 5 Have someone retrieve the blocks.

## Dinghy towing

Your vehicle is not designed to be dinghy towed (with 4 wheels on the ground) behind a motor home.

### NOTICE

- To avoid serious damage to your vehicle

Do not tow your vehicle with the four wheels on the ground.

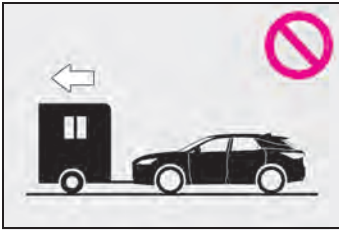

- To prevent causing serious damage to the hybrid transmission and Hybrid AWD system

Never tow this vehicle with any of the wheels on the ground. This may cause serious damage to the hybrid transmission and AWD system.



## Power (ignition) switch

Performing the following operations when carrying the electronic key on your person starts the hybrid system or changes power switch modes.

### Starting the hybrid system

- 1 Pull the parking brake switch to check that the parking brake is set. (→P.226)

The parking brake indicator will come on.

- 2 Firmly depress the brake pedal.

 and a message will be displayed on the multi-information display. If it is not displayed, the hybrid system cannot be started.

When the shift position is N, the hybrid system cannot start.

Shift the shift position to P when starting the hybrid system. (→P.214, 220)

- 3 Press the power switch shortly and firmly.

When operating the power switch, one short, firm press is enough. It is not necessary to press and hold the switch.

If the “READY” indicator turns on, the hybrid system will operate normally.

Continue depressing the brake pedal until the “READY” indicator is illuminated.

The hybrid system can be started from any

power switch mode.



- 4 Check that the “READY” indicator is illuminated.

The vehicle will not move when the “READY” indicator is off.

### ■ Power switch illumination

According to the situation, the power switch illumination operates as follows.

- If a door is open or the power switch is turned from ACC or ON to OFF, the power switch light will illuminate dimly.
- If the brake pedal is depressed while carrying an electronic key, the power switch light will illuminate brightly.
- When the power switch is in ACC or ON, the power switch illumination illuminates.

### ■ If the hybrid system does not start

- The immobilizer system may not have been deactivated. (→P.82)  
Contact your Lexus dealer.
- If a message related to start-up is shown on the multi-information display, read the message and follow the instructions.
- If the door is unlocked with the mechanical key, the hybrid system cannot be started using the smart access system with push-button start. Refer to P.550 to start the hybrid system. However, if the electronic key is carried inside the vehicle and the doors are locked (→P.121), the

hybrid system can be started.

■ **When the ambient temperature is low, such as during winter driving conditions**

When starting the hybrid system, the flashing time of the "READY" indicator may be long. Leave the vehicle as it is until the "READY" indicator is steady on, as steady means the vehicle is able to move.

■ **Sounds and vibrations specific to a hybrid vehicle**

→P.72

■ **Electronic key battery depletion**

→P.114

■ **Conditions affecting operation**

→P.141

■ **Note for the entry function**

→P.141

■ **When "Access System with Elec.Key malfunction See owner's manual" is displayed on the multi-information display**

The system may be malfunctioning. Have the vehicle inspected by your Lexus dealer immediately.

■ **If the "READY" indicator does not come on**

In the event that the "READY" indicator does not come on even after performing the proper procedures for starting the vehicle, contact your Lexus dealer immediately.

■ **If the hybrid system is malfunctioning**

→P.81

■ **Electronic key battery**

→P.501

■ **Operation of the power switch**

- If the switch is not pressed shortly and firmly, the power switch mode may not change or the hybrid system may not start.
- If attempting to restart the hybrid system immediately after turning the power switch off, the hybrid system may not start in some cases. After turning the power switch off, please wait a few seconds before restarting the hybrid system.

■ **Customization**

If the smart access system with push-button start has been deactivated in a customized setting, refer to P.549.

 **WARNING**

■ **When starting the hybrid system**

Always start the hybrid system while sitting in the driver's seat. Do not depress the accelerator pedal while starting the hybrid system under any circumstances. Doing so may cause an accident resulting in death or serious injury.

 **NOTICE**

■ **When starting the hybrid system**

If the hybrid system becomes difficult to start, have your vehicle checked by your Lexus dealer immediately.

■ **Symptoms indicating a malfunction with the power switch**

If the power switch seems to be operating somewhat differently than usual, such as the switch sticking slightly, there may be a malfunction. Contact your Lexus dealer immediately.

## Stopping the hybrid system

- 1 Stop the vehicle completely.
- 2 Set the parking brake. (→P.226)
- 3 Press the P position switch. (→P.215, 221)

Check that the shift position indicator shows P and the parking brake indicator is illuminated.

- 4 Press the power switch.

The hybrid system will stop, and the meter display will be extinguished (the shift position indicator will be extinguished a few seconds after the meter display).

- 5 Release the brake pedal and check that ACC or ON is not shown on the meter.

#### ■ When the shift control system malfunctions

If the shift control system is malfunctioning, when attempting to turn the power switch off, it may not be able to be turned off. In this situation, it may be possible to turn the power switch off by applying the parking brake and then operating the power switch.

If there is a malfunction in the system, have the vehicle inspected by your Lexus dealer immediately.

#### ■ Automatic hybrid system shut off feature

- The vehicle is equipped with a feature that automatically shuts off the hybrid system when the shift position is in P with the hybrid system operating for an extended period.
- The hybrid system will automatically shut off after approximately 1 hour if it has been left running while the shift position is in P.
- The timer for the automatic hybrid system shut off feature will reset if the brake pedal is depressed or if the shift position is in a position other than P.
- After the vehicle is parked, if the door is locked with the door lock switch (→P.121) from the inside or the mechanical key (→P.549) from the outside, the automatic hybrid system shut off feature will be disabled. The timer for the automatic hybrid system shut off feature will be re-enabled if the driver's door is opened.

#### ■ When the hybrid system is stopped (RX500h)

Even if the power switch is turned off, the cooling fan may continue to operate for a short time.

### WARNING

#### ■ Stopping the hybrid system in an emergency

- If you want to stop the hybrid system in an emergency while driving the vehicle, press and hold the power switch for more than 2 seconds, or press it briefly 3 times or more in succession. (→P.510)  
However, do not touch the power switch while driving except in an emergency. Turning the hybrid system off while driving will not cause loss of steering or braking control, however, power assist to the steering will be lost. This will make it more difficult to steer smoothly, so you should pull over and stop the vehicle as soon as it is safe to do so.
- If the power switch is operated while the vehicle is running, a warning message will be shown on the multi-information display and a buzzer sounds.
- To restart the hybrid system after performing an emergency shutdown, shift the shift position to N and then press the power switch.

#### ■ When parking

Exhaust gases include harmful carbon monoxide (CO), which is colorless and odorless. Observe the following precautions.

Failure to do so may cause exhaust gases to enter the vehicle and may lead to an accident caused by light-headedness, or may lead to death or a serious health hazard.

- If the vehicle is in a poorly ventilated area or a closed area, such as a garage, stop the hybrid system.
- Do not leave the vehicle with the hybrid system operating for a long time. If such a situation cannot be avoided, park the vehicle in an open space and ensure that exhaust fumes do not enter the vehicle interior.

**⚠ WARNING**

- Do not leave the hybrid system operating in an area with snow build-up, or where it is snowing. If snowbanks build up around the vehicle while the hybrid system is operating, exhaust gases may collect and enter the vehicle.

**Changing power switch modes**

Modes can be changed by pressing the power switch with brake pedal released. (The mode changes each time the switch is pressed.)

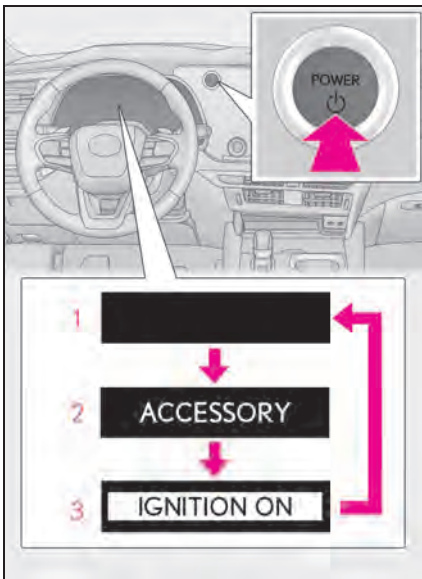
**1 Off**

The emergency flashers can be used.

**2 ACC\***

Some electrical components such as the audio system can be used.

**3 ON**

All electrical components can be used.

\*: ACC mode can be enabled/disabled on the customize menu. (→P.590)

**■ Auto power off function**

- If the vehicle is left in ACC or ON (the hybrid system is not operating) for more than 20 minutes with the shift position in P, the power switch will automatically turn to OFF.
- If the 12-volt battery is low with the shift position in P and the power switch is in ACC or ON (the hybrid system is not operating). The power switch is automatically turn to OFF.

However, this function cannot entirely prevent the 12-volt battery discharge. Do not leave the vehicle with the power switch in ACC or ON for long periods of time when the hybrid system is not operating.

**■ When ACC customization is in off**

- With the power switch is turned off, the center display can still be used for a certain time until the battery saving function starts operating.
- When the safe exit assist is operating, a buzzer will sound and a voice guidance will be given. (→P.324)

**⚠ NOTICE****■ To prevent 12-volt battery discharge**

- Do not leave the power switch in ACC or ON for long periods of time without the hybrid system on.
- If "ACCESSORY" or "IGNITION ON" is displayed on the meters while the hybrid system is not operating, the power switch is not off. Exit the vehicle after turning the power switch off.

## EV drive mode (RX350h)

In EV drive mode, electric power is supplied by the hybrid battery (traction battery), and only the electric motor (traction motor) is used to drive the vehicle.

This mode allows you to drive in residential areas early in the morning and late at night, or in indoor parking lots, etc., without concern for noises and gas emissions.

### Operating instructions

Turns EV drive mode on/off

When EV drive mode is turned on, the EV drive mode indicator will come on. Pressing the switch when in EV drive mode will return the vehicle to normal driving (using the gasoline engine and electric motor [traction motor]).

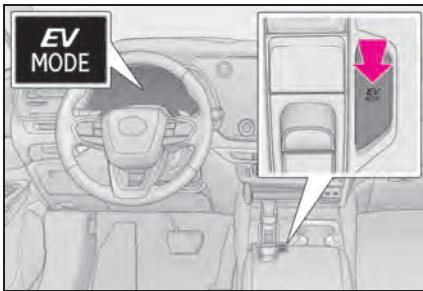

#### ■ Situations in which EV drive mode cannot be turned on

It may not be possible to turn EV drive mode on in the following situations. If it cannot be turned on, a buzzer will sound and a message will be shown on the multi-information display.

- The temperature of the hybrid system is high.  
The vehicle has been left in the sun,

driven on a hill, driven at high speeds, etc.

- The temperature of the hybrid system is low.  
The vehicle has been left in temperatures lower than about 68°F (20°C) for a long period of time, etc.
- The gasoline engine is warming up.
- The hybrid battery (traction battery) is low.  
The remaining battery level indicated in the "Energy Monitor" display is low. (→P.106)
- Vehicle speed is high.
- The accelerator pedal is depressed firmly or the vehicle is on a hill, etc.
- The windshield defogger is in use.

#### ■ Switching to EV drive mode when the gasoline engine is cold

If the hybrid system is started while the gasoline engine is cold, the gasoline engine will start automatically after a short period of time in order to warm up. In this case, you will become unable to switch to EV drive mode.

After the hybrid system has started and the "READY" indicator has illuminated, press the EV drive mode switch before the gasoline engine starts to switch to EV drive mode.

#### ■ Automatic cancelation of EV drive mode

When driving in EV drive mode, the gasoline engine may automatically restart in the following situations. When EV drive mode is canceled, a buzzer will sound, the EV drive mode indicator will go off after flashing, and a message is displayed on the multi-information display.

- The hybrid battery (traction battery) becomes low.  
The remaining battery level indicated in the "Energy Monitor" display is low. (→P.106)
- Vehicle speed is high.
- The accelerator pedal is depressed firmly or the vehicle is on a hill, etc.

### ■ Possible driving distance when driving in EV drive mode

EV drive mode's possible driving distance ranges from a few hundred meters to approximately 0.6 mile (1 km). However, depending on vehicle conditions, there are situations when EV drive mode cannot be used.

(The distance that is possible depends on the hybrid battery [traction battery] level and driving conditions.)

### ■ Fuel economy

The hybrid system is designed to achieve the best possible fuel economy during normal driving (using the gasoline engine and electric motor [traction motor]). Driving in EV drive mode more than necessary may lower fuel economy.

### ■ If "EV Mode Unavailable" is shown on the multi-information display

The EV drive mode is not available. The reason the EV drive mode is not available (the vehicle is idling, battery charge is low, vehicle speed is higher than the EV drive mode operating speed range or accelerator pedal is depressed too much) may be displayed. Use the EV drive mode when it becomes available.

### ■ If "EV Mode Deactivated" is shown on the multi-information display

The EV drive mode has been automatically canceled. The reason the EV drive mode is not available (the battery charge is low, vehicle speed is higher than the EV drive mode operating speed range or accelerator pedal is depressed too much) may be displayed. Drive the vehicle for a while before attempting to turn on the EV drive mode again.



## WARNING

### ■ Caution while driving

When driving in EV drive mode no engine noise is made. As such, pedestrians, people riding bicycles or other people and vehicles in the surrounding area may not be aware of the vehicle starting off or approaching them. Therefore, take extra care while driving even if the Acoustic Vehicle Alerting System is active.

## Automatic transmission (RX500h)

Select the shift position depending on your purpose and situation.

### Shift position purpose and functions

Shift position	Objective or function
P	Parking the vehicle/starting the hybrid system
R	Reversing
N	Neutral (Condition in which the power is not transmitted)
D	Normal driving <sup>*1</sup>
M	M mode driving <sup>*2</sup> (→P.218)

<sup>\*1</sup>: To improve fuel efficiency and reduce noise, set the shift position in D for normal driving. You can choose gear range suitable for your driving situation by operating the paddle shift switches.

<sup>\*2</sup>: Any gear range can be fixed when driving in M mode.

#### ■ To protect the automatic transmission

If the automatic transmission fluid temperature is high, "Transmission Oil Temp High Stop in a Safe Place and See Owner's Manual" will be displayed on the multi-information display. Have the vehicle inspected by your Lexus dealer.

#### ■ When driving with dynamic radar cruise control activated

Even when performing the following actions with the intent of enabling engine braking, engine braking will not be activated because dynamic radar cruise con-

trol will not be canceled.

- While driving in the D position, downshifting to D5 or D4. (→P.217)
- When switching the driving mode to sport mode while driving in the D position (→P.390)

#### ■ Sudden start restraint control (Drive-Start Control [DSC])

→P.192

#### ■ AI-SHIFT

The AI-SHIFT automatically selects the suitable gear according to driver performance and driving conditions.

The AI-SHIFT automatically operates when the shift position is in D. (Shifting the shift position to the M position cancels the function.)

#### ■ If a message about a shift operation is shown

To prevent the shift position from being selected incorrectly or the vehicle from moving unexpectedly, the shift position may be changed automatically or operating the shift lever may be required. In this case, change the shift position following the messages on the multi-information display.

#### ■ After recharging/reconnecting the 12-volt battery

→P.558

### WARNING

#### ■ When driving on slippery road surfaces

Do not accelerate or shift the shift position suddenly.

Sudden changes in engine braking may cause the vehicle to spin or skid, resulting in an accident.



## NOTICE

**■ Situations where shift control system malfunctions are possible**

If any of the following situations occurs, shift control system malfunctions are possible.

Immediately stop the vehicle in a safe place on level ground, apply the parking brake, and then contact your Lexus dealer.

- When the warning message indicating the shift control system appears on the multi-information display. (→P.526)
- The display indicates that no shift position is selected for more than a few seconds.

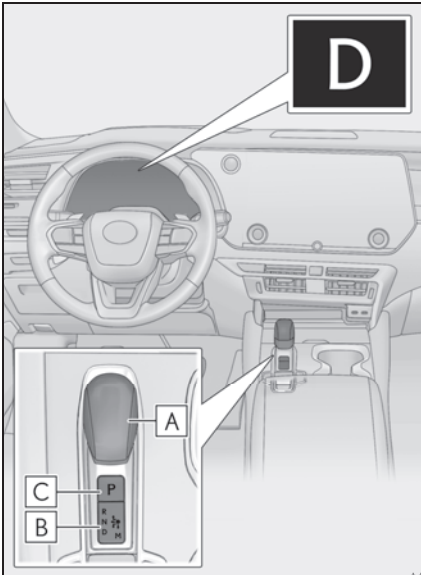
**Shift position display and how to change the shift position****A** Shift lever

Operate the shift lever gently and securely in the direction of the arrow on the shift position indicator.

To shift to N, slide the shift lever in the

direction of the arrow and hold it.

Release the shift lever after each shifting operation to allow it to return to its regular position (●).

Shifting to M is only possible when the shift position is in D.

When shifting from P to N, D or R, from N, D, M or R to P, from D or M to R, or from R to D, ensure that the brake pedal is being depressed and the vehicle is stationary.

**B** Shift position indicator

Meter display:

The current shift position is illuminated.

Shift lever display:

The current shift position is illuminated.

When selecting the shift position, make sure that the shift position has been changed to the desired position by checking the shift position indicator provided on the instrument cluster.

**C** P position switch

Fully stop the vehicle and set the parking brake, and then press the P position switch.

When the shift position is changed to P, the switch illuminates.

Check that the shift position indicator shows P.

**■ Changing the shift position in each power switch mode**

- The shift position cannot be changed when the power switch is in ACC or off.
- When the power switch is in ON, if the "READY" indicator is not illuminated, the shift position can only be changed to N.
- When the "READY" indicator is illuminated, the shift position can be changed from P to D, N, or R.
- When the "READY" indicator is flashing, the shift position cannot be changed from P to any other position, even if the shift lever is operated. Operate the shift lever

again after the "READY" indicator changes from flashing to illuminated.

#### ■ Shifting the shift position from P to other positions

- While depressing the brake pedal firmly, operate the shift lever. If the shift lever is operated without depressing the brake pedal, the buzzer will sound and the shifting operation will be disabled.
- When selecting the shift position, make sure that the shift position has been changed to the desired position by checking the shift position indicator provided on the instrument cluster.
- The shift position cannot be changed from P to M directly.

#### ■ The shift position cannot be changed when

In the following situations, a buzzer will sound to inform you that the shift position cannot be changed. Use the appropriate operation to attempt to change the shift position again.

- When attempting to change the shift position from P with the brake pedal not depressed
- When attempting to change the shift position from P with the accelerator pedal depressed
- When attempting to change the shift position from N while stopped or driving at an extremely low speed with the brake pedal not depressed
- When attempting to change the shift position from N while stopped or driving at an extremely low speed with the accelerator pedal depressed
- When attempting to change the shift position from P or N to M
- When the P position switch is pressed while driving

When driving at an extremely low speed, the shift position may change to P.

#### ■ The shift position automatically changes to N when

In the following situations, a buzzer will sound to inform you that the shift position has been changed to N. Use the appropri-

ate operation to attempt to change the shift position again.

- When attempting to change the shift position to R while the vehicle is moving forward

When driving at a low speed, the shift position may change to R.

- When attempting to change the shift position to D while the vehicle is moving backward

When driving at a low speed, the shift position may change to D.

- When attempting to change the shift position from R to M

#### ■ If the N shift position is selected while driving

If the shift lever is moved to N while driving above a certain speed, the shift position will change to N without holding the shift lever in the N position. In this situation, a buzzer will sound and a message will be displayed on the multi-information display to inform you that the shift position has been changed to N.

#### ■ Automatic P position selection function

In the following situations, the shift position is automatically changed to P.

- When pressing the power switch with the vehicle stopped while the power switch is in ON and the shift position is in a position other than P (after the shift position has changed to P, the power switch will turn off)\*
- If the driver's door is opened and all of the following conditions are met, while the shift position is in a position other than P
  - The power switch is in ON.
  - The driver is not wearing the seat belt.
  - The brake pedal is not depressed.

To start off the vehicle after the shift position is changed to P, operate the shift lever again.

- When the vehicle is stopped after the hybrid system has been stopped in an emergency while driving.
- When voltage of the 12-volt battery

drops while the shift position is in a position other than P.

- \* : When the power switch is pressed while driving at extremely slow speeds, such as immediately before stopping the vehicle, the shift position may automatically change to P. Make sure that the vehicle is completely stopped before pressing the power switch.

#### ■ If the shift position cannot be shifted from P

There is a possibility that the 12-volt battery is discharged. Check the 12-volt battery in this situation. (→P.553)

#### ■ Customization

Some functions can be customized. (→P.590)



### WARNING

#### ■ For the shift lever

- Do not remove the shift lever knob or use anything but a genuine Lexus shift lever knob. Also, do not hang anything on the shift lever. Doing so could prevent the shift lever from returning to position, causing unexpected accidents to occur when the vehicle is in motion.
- In order to prevent the shift position from accidentally being changed, do not touch the shift lever when not using them.

#### ■ P position switch

- Do not press the P position switch while the vehicle is moving.

If the P position switch is pressed when driving at very low speeds (for example, directly before stopping the vehicle), the vehicle may stop suddenly when the shift position switches to P, which could lead to an accident.

- In order to prevent the shift position from accidentally being changed, do not touch the P position switch when not using them.



### NOTICE

#### ■ When exiting the vehicle (driver's seat only)

Check that the shift position indicator shows P and that the parking brake indicator is illuminated before opening the door and exiting the vehicle.

## Selecting the driving mode

### ■ Driving mode

→P.390

## Selecting shift ranges in the D position

To drive using temporary shift range selection, operate the “-” or “+” paddle shift switch.

When the “-” paddle shift switch is operated, the shift range switches to a range that enables engine braking force that is suitable to driving conditions. When the “+” paddle shift switch is operated, the shift range switches to a range that is one range higher than the current range.

Changing the shift range allows restriction of the highest gear, preventing unnecessary upshifting and enabling the level of engine braking force to be selected.

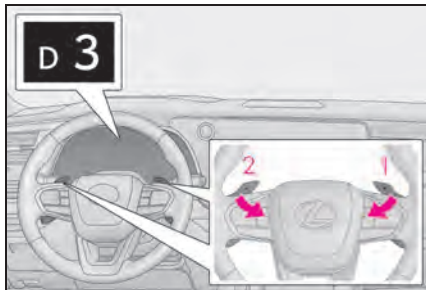

- 1 Upshifting
- 2 Downshifting

The selected shift range, from D1 to D6, will be displayed on the meter.

To return to normal D position driving, the "+" paddle shift switch must be held down for a period of time.

#### ■ Shift ranges and their functions

Meter display	Function
D2 - D6	A gear in the range between 1 and the selected gear is automatically chosen depending on vehicle speed and driving conditions
D1	1st gear is set

A lower shift range will provide greater engine braking forces than a higher shift range.

#### ■ Automatic deactivation of shift range selection in the D position

Shift range selection in the D position will be deactivated in the following situations:

- When the vehicle comes to a stop
- If the accelerator pedal is depressed for more than a certain period of time
- When the shift position is shifted to a position other than D.

#### ■ Downshifting restriction warning buzzer

To help ensure safety and driving performance, downshifting operation may sometimes be restricted. In some circumstances, downshifting may not be possible even when the paddle shift switch is operated. (A buzzer will sound twice.)

#### Selecting gears in the M position

To enter M mode, shift the shift position to M. Gears can be selected by operating the paddle shift switches, allowing you to drive in the gear of your choosing.

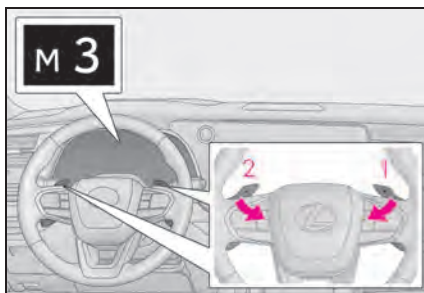

- 1 Upshifting
- 2 Downshifting

The gear changes once every time the paddle shift switch is operated.

The selected gear, from M1 to M6, will be fixed and displayed on the meter.

When in the M position, the gear will not change unless the paddle shift switches are operated. Also, the gear will not shift when the vehicle speed is low, even if an upshift operation is performed.

However, even when in the M position, the gears will be automatically changed in the following situations:

- When vehicle speed drops

(downshift only).

- When vehicle speed increases (upshift only).
- When the accelerator pedal is firmly depressed.
- When it is necessary to protect the transmission when the transmission fluid temperature is high or low, or other reasons.

#### ■ Downshifting restriction warning buzzer

To help ensure safety and driving performance, downshifting operation may sometimes be restricted. In some circumstances, downshifting may not be possible even when the paddle shift switch is operated. (A buzzer will sound twice.)

#### Keeping the shift position in N without activating the automatic P position selection function

- By performing the following operation, the shift position can be held in N until the shift position switches to P without activating the automatic P position selection function.
- 1 Operate the shift lever and change the shift position to N when the hybrid system is operating.
  - 2 Return the shift lever to its regular position ( ● ).
  - 3 Operate the shift lever to N and hold it there until the buzzer sounds.
  - 4 Press the power switch within 5 seconds after the buzzer sounds.

The hybrid system stops with the shift posi-

tion in N\*

Make sure to check that the buzzer sounds and “Holding N Push P Switch When Done” is displayed on the multi-information display.

- In order to shift to a position other than N, first press the P position switch to change the shift position to P.
- Make sure to operate the shift lever with the hybrid system is operating. If the hybrid system is not operating, it may not be possible to hold the shift position in N.

\*: To keep this state, do not operate the power switch. If the power switch is operated repeatedly, the power switch will turn off after the shift position has automatically changed to P.



#### NOTICE

#### ■ Keeping the shift position in N without activating the automatic P position selection function

Make sure that the hybrid system is started. If an operation is performed when the hybrid system is not started, the shift position may change to P.

## Hybrid transmission (RX350h)

Select the shift position depending on your purpose and situation.

### Shift position purpose and functions

Shift position	Objective or function
P	Parking the vehicle/starting the hybrid system
R	Reversing
N	Neutral (Condition in which the power is not transmitted)
D	Normal driving <sup>*1</sup>
S	S mode driving <sup>*2</sup> (→P.224)

<sup>\*1</sup>: To improve fuel efficiency and reduce noise, set the shift position in D for normal driving. You can choose gear range suitable for your driving situation by operating the paddle shift switches.

<sup>\*2</sup>: By selecting shift ranges using S mode, you can control accelerating force and engine braking force.

#### ■ When driving with the dynamic radar cruise control activated

Even when performing the following actions with the intent of enabling engine braking, engine braking will not be activated because the dynamic radar cruise control will not be canceled.

- While driving in D or S mode, downshifting to 5 or 4. (→P.223)
- When switching the driving mode to sport mode while driving in the D position (→P.390)

#### ■ Sudden start restraint control (Drive-Start Control [DSC])

→P.192

#### ■ If a message about a shift operation is shown

To prevent the shift position from being selected incorrectly or the vehicle from moving unexpectedly, the shift position may be changed automatically or operating the shift lever may be required. In this case, change the shift position following the messages on the multi-information display.

#### ■ After recharging/reconnecting the 12-volt battery

→P.558

### WARNING

#### ■ When driving on slippery road surfaces

Do not accelerate or shift the shift position suddenly. Sudden changes in engine braking may cause the vehicle to spin or skid, resulting in an accident.

### NOTICE

#### ■ Hybrid battery (traction battery) charge

If the shift position is in N, the hybrid battery (traction battery) will not be charged. To help prevent the battery from discharging, avoid leaving the N position selected for a certain amount of time.

#### ■ Situations where shift control system malfunctions are possible

If any of the following situations occurs, shift control system malfunctions are possible. Immediately stop the vehicle in a safe place on level ground, apply the parking brake, and then contact your Lexus dealer.



## NOTICE

- When the warning message indicating the shift control system appears on the multi-information display. (→P.526)
- The display indicates that no shift position is selected for more than a few seconds.

## Shift position display and how to change the shift position

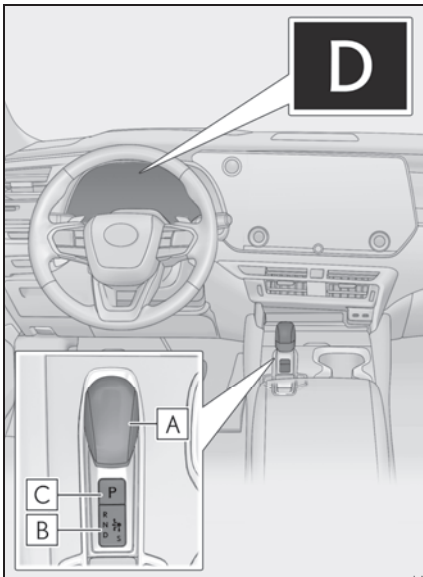

### A Shift lever

Operate the shift lever gently and securely in the direction of the arrow on the shift position indicator.

To shift to N, slide the shift lever in the direction of the arrow and hold it.

Release the shift lever after each shifting operation to allow it to return to its regular position (●).

Shifting to S is only possible when the shift position is in D.

When shifting from P to N, D or R, from N,

D, S or R to P, from D or S to R, or from R to D, ensure that the brake pedal is being depressed and the vehicle is stationary.

### B Shift position indicator

Meter display:

The current shift position is illuminated.

Shift lever display:

The current shift position is illuminated.

When selecting the shift position, make sure that the shift position has been changed to the desired position by checking the shift position indicator provided on the instrument cluster.

### C P position switch

Fully stop the vehicle and set the parking brake, and then press the P position switch.

When the shift position is changed to P, the switch illuminates.

Check that the shift position indicator shows P.

### Changing the shift position in each power switch mode

- The shift position cannot be changed when the power switch is in ACC or off.
- When the power switch is in ON, if the "READY" indicator is not illuminated, the shift position can only be changed to N.
- When the "READY" indicator is illuminated, the shift position can be changed from P to D, N, or R.
- When the "READY" indicator is flashing, the shift position cannot be changed from P to any other position, even if the shift lever is operated. Operate the shift lever again after the "READY" indicator changes from flashing to illuminated.

### Shifting the shift position from P to other positions

- While depressing the brake pedal firmly, operate the shift lever. If the shift lever is operated without depressing the brake pedal, the buzzer will sound and the shifting operation will be disabled.

- When selecting the shift position, make sure that the shift position has been changed to the desired position by checking the shift position indicator provided on the instrument cluster.
- The shift position cannot be changed from P to S directly.

#### ■ The shift position cannot be changed when

In the following situations, a buzzer will sound to inform you that the shift position cannot be changed. Use the appropriate operation to attempt to change the shift position again.

- When attempting to change the shift position from P with the brake pedal not depressed
- When attempting to change the shift position from P with the accelerator pedal depressed
- When attempting to change the shift position from N while stopped or driving at an extremely low speed with the brake pedal not depressed
- When attempting to change the shift position from N while stopped or driving at an extremely low speed with the accelerator pedal depressed
- When attempting to change the shift position from P or N to S
- When the P position switch is pressed while driving

When driving at an extremely low speed, the shift position may change to P.

#### ■ The shift position automatically changes to N when

In the following situations, a buzzer will sound to inform you that the shift position has been changed to N. Use the appropriate operation to attempt to change the shift position again.

- When attempting to change the shift position to R while the vehicle is moving forward

When driving at a low speed, the shift position may change to R.

- When attempting to change the shift

position to D while the vehicle is moving backward

When driving at a low speed, the shift position may change to D.

- When attempting to change the shift position from R to S

#### ■ If the N shift position is selected while driving

If the shift lever is moved to N while driving above a certain speed, the shift position will change to N without holding the shift lever in the N position. In this situation, a buzzer will sound and a message will be displayed on the multi-information display to inform you that the shift position has been changed to N.

#### ■ Automatic P position selection function

In the following situations, the shift position is automatically changed to P.

- When pressing the power switch with the vehicle stopped while the power switch is in ON and the shift position is in a position other than P (after the shift position has changed to P, the power switch will turn off)\*
- If the driver's door is opened and all of the following conditions are met, while the shift position is in a position other than P
  - The power switch is in ON.
  - The driver is not wearing the seat belt.
  - The brake pedal is not depressed.

To start off the vehicle after the shift position is changed to P, operate the shift lever again.

- When the vehicle is stopped after the hybrid system has been stopped in an emergency while driving.
- When voltage of the 12-volt battery drops while the shift position is in a position other than P.

\* : When the power switch is pressed while driving at extremely slow speeds, such as immediately before stopping the vehicle, the shift position may automatically change to P. Make sure that the vehicle is completely stopped before pressing

the power switch.

### ■ If the shift position cannot be shifted from P

There is a possibility that the 12-volt battery is discharged. Check the 12-volt battery in this situation. (→P.553)

### ■ Customization

Some functions can be customized. (→P.590)

## ⚠ WARNING

### ■ For the shift lever

- Do not remove the shift lever knob or use anything but a genuine Lexus shift lever knob. Also, do not hang anything on the shift lever. Doing so could prevent the shift lever from returning to position, causing unexpected accidents to occur when the vehicle is in motion.

Doing so could prevent the shift lever from returning to position, causing unexpected accidents to occur when the vehicle is in motion.

- In order to prevent the shift position from accidentally being changed, do not touch the shift lever when not using them.

### ■ P position switch

- Do not press the P position switch while the vehicle is moving.

If the P position switch is pressed when driving at very low speeds (for example, directly before stopping the vehicle), the vehicle may stop suddenly when the shift position switches to P, which could lead to an accident.

- In order to prevent the shift position from accidentally being changed, do not touch the P position switch when not using them.

## ⚠ NOTICE

### ■ When exiting the vehicle (driver's seat only)

Check that the shift position indicator shows P and that the parking brake indicator is illuminated before opening the door and exiting the vehicle.

## Selecting the driving mode

### ■ Driving mode

→P.390

## Selecting shift ranges in the D position

To drive using temporary shift range selection, operate the “-” paddle shift switch. Changing the shift range enables the level of engine braking force to be selected. The shift range can then be selected by operating the “-” and “+” paddle shift switches.



1 Upshifting

2 Downshifting

The selected shift range, from D1 to D5, will be displayed on the meter.

The initial shift range when the “-” paddle shift switch is operated is automatically set to D4.

To return to normal D position driving, hold

the “+” paddle shift switch for a period of time or operate the “+” paddle shift switch in the D5 range.

#### ■ Shift ranges and their functions

- You can choose from 5 levels of engine braking force.
- A lower shift range will provide greater engine braking force than a higher shift range, and the engine revolutions will also increase.

#### ■ When the “-” paddle shift switch is operated with the shift lever in the D position

The shift range is downshifted to a range that enables engine braking force that is suitable to driving conditions.

#### ■ Automatic deactivation of shift range selection in the D position

Shift range selection in the D position will be deactivated in the following situations:

- When the vehicle comes to a stop
- If the accelerator pedal is depressed for more than a certain period of time
- When the shift position is shifted to a position other than D.

#### ■ Downshifting restriction warning buzzer

To help ensure safety and driving performance, downshifting operation may sometimes be restricted. In some circumstances, downshifting may not be possible even when the paddle shift switch is operated. (A buzzer will sound twice.)

### Selecting gears in the S position

To enter S mode, shift the shift position to S. Gears can be selected by operating the paddle shift switches, allowing you to drive in the gear of your choosing. The shift range can then be selected by operating the “-” and “+” paddle shift switches.

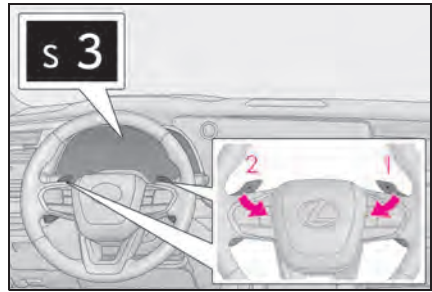

- 1 Upshifting
- 2 Downshifting

The selected shift range, from S1 to S6, will be displayed on the meter.

The initial shift range in S mode is automatically set to S4.

#### ■ Shift ranges and their functions

- You can choose from 6 levels of accelerating force and engine braking force.
- A lower shift range will provide greater accelerating force and engine braking force than a higher shift range, and the engine revolutions will also increase.

#### ■ S mode

- To prevent the engine from over-revving, upshifting may automatically occur when the shift range is S3 or lower.
- When in S4 or lower, if the paddle shift switch is held toward “+” the shift range will be set to S6.

#### ■ Downshifting restrictions warning buzzer

To help ensure safety and driving performance, downshifting operation may sometimes be restricted. In some circumstances, downshifting may not be possible even when the paddle shift switch is operated. (A buzzer will sound twice.)

### Keeping the shift position in N without activating the automatic P position selection function

- By performing the following operation, the shift position can be held in N until the shift position switches to P without activating the automatic P position selection function.
- 1 Operate the shift lever and change the shift position to N when the hybrid system is operating.
  - 2 Return the shift lever to its regular position ( ● ).
  - 3 Operate the shift lever to N and hold it there until the buzzer sounds.
  - 4 Press the power switch within 5 seconds after the buzzer sounds.

The hybrid system stops with the shift position in N\*.

Make sure to check that the buzzer sounds and “Holding N Push P Switch When Done” is displayed on the multi-information display.

- In order to shift to a position other than N, first press the P position switch to change the shift position to P.
- Make sure to operate the shift lever with the hybrid system is operating. If the hybrid system is not operating, it may not be possible to hold the shift position in N.

\*: To keep this state, do not operate the power switch. If the power switch is operated repeatedly, the power switch will turn off after the shift position has

automatically changed to P.



#### NOTICE

- Keeping the shift position in N without activating the automatic P position selection function

Make sure that the hybrid system is started.

If an operation is performed when the hybrid system is not started, the shift position may change to P.

## Turn signal lever

### Operating instructions

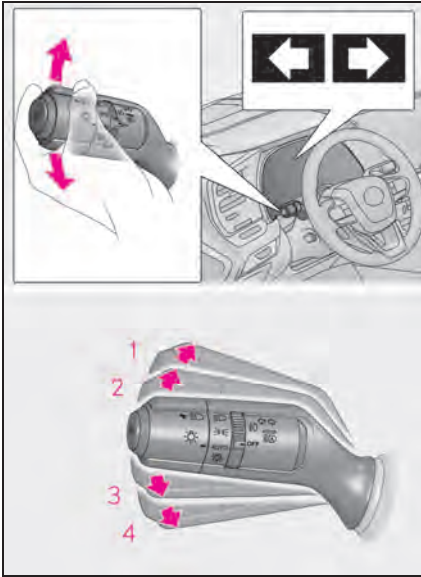

- 1 Right turn
- 2 Lane change to the right (move the lever partway and release it)  
The right hand signals will flash 3 times.
- 3 Lane change to the left (move the lever partway and release it)  
The left hand signals will flash 3 times.
- 4 Left turn

#### ■ Turn signals can be operated when

The power switch is in ON.

#### ■ If the indicator flashes faster than usual

Have the vehicle inspected by your Lexus dealer.

#### ■ If the turn signals stop flashing before a lane change has been performed

Operate the lever again.

## Parking brake

The parking brake can be set or released automatically or manually.

In automatic mode, the parking brake can be set or released automatically according to the shift lever operation.

Also, even in automatic mode, the parking brake can be set or released manually.

### Operating instructions

#### ■ Using the manual mode

The parking brake can be set and released manually.

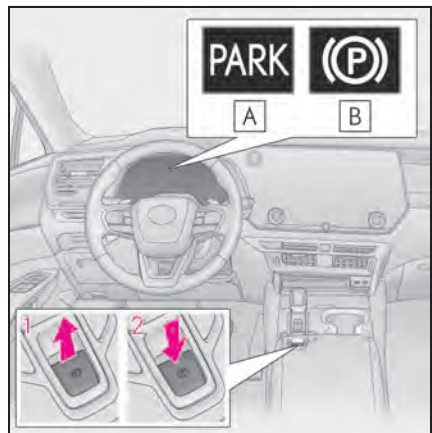

**A** Parking brake indicator (U.S.A.)

**B** Parking brake indicator (Canada)

- 1 Pull the switch to set the parking brake.

The parking brake indicator light will turn on.

Pull and hold the parking brake switch if an emergency occurs and it is necessary to

operate the parking brake while driving.

- 2** Press the switch to release the parking brake.
- Operate the parking brake switch while depressing the brake pedal.
  - Using the parking brake automatic release function, the parking brake can be released by depressing the accelerator pedal. When using this function, slowly depress the accelerator pedal. (→P.227)

Make sure that the parking brake indicator light turn off.

If the parking brake indicator light flash, operate the switch again. (→P.522)

### ■ Turning the automatic mode on

While the vehicle is stopped, pull and hold the parking brake switch until a buzzer sounds and a message is shown on the multi-information display.

When the automatic mode is turned on, the parking brake operates as follows.

- When the shift position is shifted from P, the parking brake will be released, and the parking brake indicator light will turn off.
- When the shift position is shifted to P, the parking brake will be set, and the parking brake indicator light will turn on.

Operate the shift lever and P position switch with the vehicle stopped and the brake pedal depressed.

The auto function may not operate if the shift lever is moved extremely quickly. In this situation, apply the parking brake manually. (→P.226)

### ■ Turning the automatic mode off

While the vehicle is stopped and depressing the brake pedal, press and hold the parking brake switch until a buzzer sounds and a message is shown on the multi-information display.

### ■ Parking brake operation

- When the power switch is not in ON, the parking brake cannot be released using the parking brake switch.
- When the power switch is not in ON, automatic mode (automatic brake setting and releasing) is not available.

### ■ Parking brake automatic release function

When all of the following conditions are met, the parking brake can be released by depressing the accelerator pedal.

- The driver's door is closed
- The driver is wearing the seat belt
- The shift lever is in a forward driving position or reverse driving position
- The malfunction indicator lamp or brake system warning light is not illuminated.

When depressing the accelerator pedal, depress it slowly.

If the parking brake is not released when the accelerator pedal is depressed, release the parking brake manually.

When the shift position is shifted from P, the parking brake will be released automatically.

### ■ Parking brake automatic lock function

The parking brake will be set automatically under the following conditions:

- The brake pedal is not depressed
- The driver's door is open
- The driver's seat belt is not fastened
- The shift position is in a position other than P or N

(Vehicles with Lexus Teammate Advanced Park: The shift position is in P during Advanced Park operation.)

- The malfunction indicator lamp and brake system warning light are not illuminated

- If “Parking Brake Temporarily Unavailable” is displayed on the multi-information display

If the parking brake is operated repeatedly over a short period of time, the system may restrict operation to prevent overheating. If this happens, refrain from operating the parking brake. Normal operation will return after about 1 minute.

- If “EPB Activation Stopped Incompletely” or “Parking Brake Unavailable” is displayed on the multi-information display

Operate the parking brake switch. If the message does not disappear after operating the switch several times, the system may be malfunctioning. Have the vehicle inspected by your Lexus dealer.

- Parking brake operation sound

When the parking brake operates, a motor sound (whirring sound) may be heard. This does not indicate a malfunction.

- Parking brake indicator light

- Depending on the power switch mode, the parking brake indicator light will turn on and stay on as described below:  
ON: Comes on until the parking brake is released.  
Not in ON: Stays on for approximately 15 seconds.
- When the power switch is turned off with the parking brake set, the parking brake indicator light will stay on for about 15 seconds. This does not indicate a malfunction.

- When the parking brake switch malfunctions

Automatic mode (automatic brake setting and releasing) will be turned on automatically.

- Parking the vehicle

→P.187

- Parking brake engaged warning buzzer

A buzzer will sound if the vehicle is driven

with the parking brake engaged. “Parking Brake ON” is displayed on the multi-information display (with the vehicle reaching a speed of 3 mph [5 km/h]).

- If the brake system warning light comes on

→P.516

- Usage in winter time

→P.403



### WARNING

- When parking the vehicle

Do not leave a child in the vehicle alone. The parking brake may be released unintentionally by a child and there is the danger of the vehicle moving that may lead to an accident resulting in death or serious injury.

- Parking brake switch

Do not set any objects near the parking brake switch. Objects may interfere with the switch and may lead the parking brake to unexpectedly operate.

- Parking brake automatic lock function

Never use the automatic parking brake engagement function in place of normal parking brake operation. This function is designed to reduce the risk of a collision due to the driver forgetting to engage the parking brake. Over-reliance on this function to park the vehicle safely may lead to an accident resulting in death or serious injury.



### NOTICE

- When parking the vehicle

Before you leave the vehicle, shift the shift position to P, set the parking brake and make sure that the vehicle does not move.



## NOTICE

**■ When the system malfunctions**

Stop the vehicle in a safe place and check the warning messages.

**■ When the vehicle 12-volt battery is discharged**

The parking brake system cannot be activated. (→P.553)

**■ When the parking brake cannot be released due to a malfunction**

Driving the vehicle with the parking brake set will lead to brake components overheating, which may affect braking performance and increase brake wear. Have the vehicle inspected by your Lexus dealer immediately if this occurs.

**Brake Hold**

## ▶ RX500h

The brake hold system keeps the brake applied when the shift position is in D, M or N with the system on and the brake pedal has been depressed to stop the vehicle. The system releases the brake when the accelerator pedal is depressed with the shift position in D or M to allow smooth start off.

## ▶ RX350h

The brake hold system keeps the brake applied when the shift position is in D, S or N with the system on and the brake pedal has been depressed to stop the vehicle. The system releases the brake when the accelerator pedal is depressed with the shift position in D or S to allow smooth start off.

**Enabling the system**

Turns the brake hold system on

The brake hold standby indicator (green)

**A** comes on. While the system is holding the brake, the brake hold operated indicator (yellow) **B** comes on.

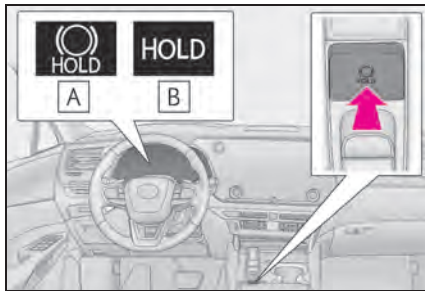

### ■ Brake hold system operating conditions

The brake hold system cannot be turned on in the following conditions:

- The driver's door is not closed.
- The driver is not wearing the seat belt.
- The parking brake is engaged.
- "EPB Activation Stopped Incompletely" or "Parking Brake Malfunction Visit Your Dealer" is displayed on the multi-information display.

If any of the conditions above are detected when the brake hold system is enabled, the system will turn off and the brake hold standby indicator light will go off. In addition, if any of the conditions are detected while the system is holding the brake, a warning buzzer will sound and a message will be shown on the multi-information display. The parking brake will then be set automatically.

### ■ Brake hold function

- If the brake pedal is left released for a period of about 3 minutes after the system has started holding the brake, the parking brake will be set automatically. In this case, a warning buzzer sounds and a message is shown on the multi-information display.
- To turn the system off while the system is holding the brake, firmly depress the brake pedal and press the button again.
- The brake hold function may not hold the vehicle when the vehicle is on a steep incline. In this situation, it may be necessary for the driver to apply the brakes. A warning buzzer will sound and the multi-information display will inform the driver of this situation. If a warning mes-

sage is shown on the multi-information display, read the message and follow the instructions.

- When do not wish for the parking brake to operate automatically, press and hold the brake hold switch until the standby indicator (green) turns off, and then turn the power switch off.
- **When the parking brake is set automatically while the system is holding the brakes**

Perform any of the following operations to release the parking brake.

- Depress the accelerator pedal. (The parking brake will not be released automatically if the seat belt is not fastened.)
- Operate the parking brake switch with the brake pedal depressed.

Make sure that the parking brake indicator light goes off. (→P.226)

### ■ When an inspection at your Lexus dealer is necessary

When the brake hold standby indicator (green) does not illuminate even when the brake hold switch is pressed with the brake hold system operating conditions met, the system may be malfunctioning. Have the vehicle inspected at your Lexus dealer.

### ■ If "Brake Hold Malfunction Press Brake to Deactivate Visit Your Dealer" or "Brake Hold Malfunction Visit Your Dealer" is displayed on the multi-information display

The system may be malfunctioning. Have the vehicle inspected by your Lexus dealer.

### ■ Warning messages and buzzers

Warning messages and buzzers are used to indicate a system malfunction or to inform the driver of the need for caution. If a warning message is shown on the multi-information display, read the message and follow the instructions.

### ■ If the brake hold operated indicator flashes

→P.523

**WARNING****■ When the vehicle is on a steep incline**

Take care when using the brake hold system on a steep incline, exercise caution. The brake hold function may not hold brakes in such situations.

Also, the system may not activate depending on the angle of the slope.

**■ When stopped on a slippery road**

The system cannot stop the vehicle when the gripping ability of the tires has been exceeded. Do not use the system when stopped on a slippery road.

**NOTICE****■ When parking the vehicle**

The brake hold system is not designed for use when parking the vehicle for a long period of time. Turning the power switch off while the system is holding the brake may release the brake, which would cause the vehicle to move. When operating the power switch, depress the brake pedal, shift the shift position to P and set the parking brake.

**ASC (Active Sound Control)  
(RX500h)**

The ASC system is designed to allow the driver to feel the state of driving, such as accelerating and decelerating, more strongly. The vehicle's response to the driver's accelerator operation and shift operation are sonically emphasized.

**■ Customization**

Some functions can be customized. (→P.590)

## Headlight switch

The headlights can be operated manually or automatically.

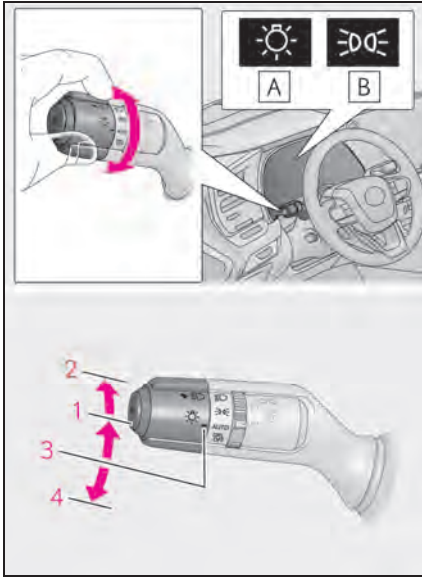

### Operating instructions

Operating the  switch turns on the lights as follows:



**A** U.S.A.

**B** Canada

- 1**  The side marker, parking, tail, license plate, instrument panel lights, and daytime running lights (→P.232) turn on.
- 2**  The headlights and all lights listed above (except daytime running lights) turn on.
- 3** AUTO The headlights, daytime running lights (→P.232) and all the

lights listed above turn on and off automatically.  
(When the power switch is in ON.)

**4**  (U.S.A.) Off

### ■ AUTO mode can be used when

The power switch is in ON.

### ■ Daytime running light system

- The daytime running lights illuminate using the same lights as the parking lights and illuminate brighter than the parking lights.
- To make your vehicle more visible to other drivers during daytime driving, the daytime running lights turn on automatically when all of the following conditions are met. (The daytime running lights are not designed for use at night.)
  - The hybrid system is started
  - The parking brake is released
  - The headlight switch is in the  or AUTO\* position

\*: When the surroundings are bright

The daytime running lights remain on after they illuminate, even if the parking brake is set again.

- For the U.S.A.: Daytime running lights can be turned off by operating the switch.
- Compared to turning on the headlights, the daytime running light system offers greater durability and consumes less electricity, so it can help improve fuel economy.

### ■ Headlight control sensor

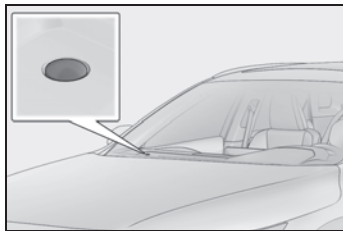

The sensor may not function properly if an object is placed on the sensor, or anything that blocks the sensor is affixed to the windshield.

Doing so interferes with the sensor detecting the level of ambient light and may cause the automatic headlight system to malfunction.



### ■ Automatic light off system

- When the headlights are on: The headlights and tail lights turn off 30 seconds after the driver's door is opened and closed if the power switch is turned off. (The lights turn off immediately if  on the key is pressed after all the doors are closed.)
- When only the tail lights are on: The tail lights turn off automatically if the power switch is turned off and the driver's door is opened.

To turn the lights on again, turn the power switch to ON, or turn the light switch off once and then back to  or .

### ■ Automatic headlight leveling system (if equipped)

The level of the headlights is automatically adjusted according to the number of passengers and the loading condition of the vehicle to ensure that the headlights do not interfere with other road users.

### ■ Light reminder buzzer

A buzzer sounds when the power switch is turned to ACC or OFF and the driver's door is opened while the lights are turned on.

### ■ Windshield wiper linked headlight illumination

When driving during daytime with the headlight switch turned to AUTO, if the windshield wipers are used, the headlights will turn on automatically after several seconds to help enhance the visibility of your vehicle.

### ■ 12-volt battery-saving function

In order to prevent the 12-volt battery of the vehicle from discharging, if the headlights and/or tail lights are on when the power

switch is turned off the 12-volt battery saving function will operate and automatically turn off all the lights after approximately 20 minutes. When the power switch is turned to ON, the 12-volt battery-saving function will be disabled.

When any of the following are performed, the 12-volt battery-saving function is canceled once and then reactivated. All the lights will turn off automatically 20 minutes after the 12-volt battery-saving function has been reactivated:

- When the headlight switch is operated
- When a door is opened or closed

### ■ When unlocking the doors (welcome lamp)

The parking lights automatically turn on when the surroundings are dark and the doors are unlocked using the entry function or wireless remote control if the light switch is in the AUTO position.

### ■ Customization

Some functions can be customized. (→P.590)

### NOTICE

#### ■ To prevent 12-volt battery discharge

Do not leave the lights on longer than necessary when the hybrid system is off.

## Turning on the high beam headlights

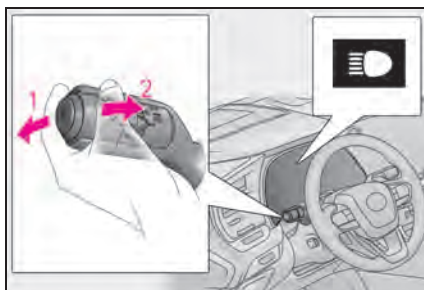

- 1 With the headlights on, push the lever away from you to turn on the

high beams.

Pull the lever toward you to the center position to turn the high beams off.

- 2 Pull the lever toward you and release it to flash the high beams once.

You can flash the high beams with the headlights on or off.

### Cornering lights (if equipped)

When any of the following conditions is met, while the headlights (low beam) are on, the cornering lights will additionally turn on and light up the direction of movement for the vehicle. This is to ensure excellent visibility when either driving at intersections or parking at night.

- The steering wheel is operated
- The turn signal lever is operated
- The shift position is in R (both left and right side cornering lights)

#### ■ Cornering light control

- When vehicle speed is approximately 22 mph (35 km/h) or higher, the cornering lights will not turn on.
- After the lights remain illuminated for 30 minutes, they automatically turn off.

## AHS (Adaptive High-beam System)\*

\*: If equipped

The Adaptive High-beam System uses a front camera located on the upper portion of the windshield to detect the brightness of the lights of vehicles ahead, streetlights, etc., and automatically controls the light distribution of the headlights.

### WARNING

#### ■ For safe use

Do not overly rely on the Adaptive High-beam System. Always drive safely, taking care to observe your surroundings and turning the high beams on or off manually if necessary.

#### ■ To prevent unintentional operation of the Adaptive High-beam System

When it is necessary to disable the system: →P.252

### System controls

- According to the vehicle speed, the brightness and illuminated area of the high beams are adjusted.
- The high beams are illuminated so that the area around a vehicle ahead is shaded. (Shaded high beam)

The shaded high beam helps ensure forward visibility while reducing the dazzling effect on the drivers of vehicles ahead.

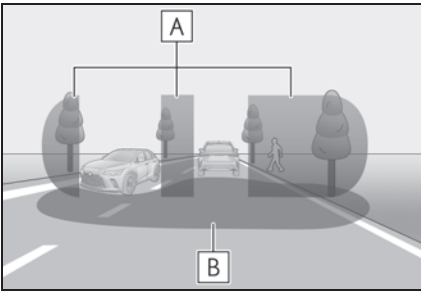

**A** Area illuminated by the high beams

**B** Area illuminated by the low beams

- According to the distance to a preceding vehicle, the illuminated area of the low beams is adjusted.

### Using the Adaptive High-beam System

- 1 Press the Adaptive High-beam System switch.

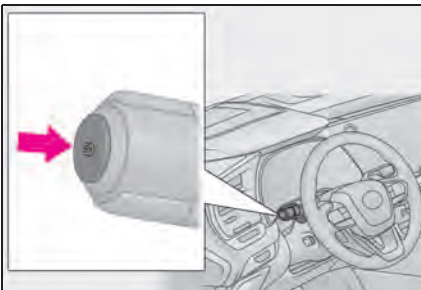

- 2 Turn the headlight switch to the AUTO or  position.

When the headlight switch lever is in the low beam position, the AHS will be enabled and the AHS indicator will illumi-

nate.

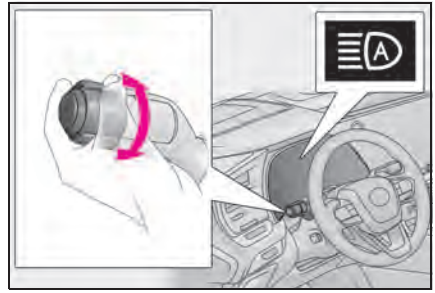

### System operating conditions

- When all of the following conditions are met, the high beams will illuminate and the system will operate:
    - The vehicle speed is approximately 19 mph (30 km/h) or more.
    - The area ahead of the vehicle is dark.
  - When all of the following conditions are met, the headlights will change to the shaded high beams according to the position of vehicles ahead:
    - The vehicle speed is approximately 19 mph (30 km/h) or more
    - The area ahead of the vehicle is dark.
    - There is a vehicle ahead with lights on.
    - There are few streetlights or other lights on the road ahead.
  - If any of the following conditions are met, the system will change to the low beams:
    - The vehicle speed is approximately 16 mph (25 km/h) or lower.
    - The area ahead of the vehicle is not dark.
    - There are many vehicles ahead.
    - There are many streetlights or other lights on the road ahead.
- ### Front camera detection
- In the following situations, the high beams may not be automatically changed to the shaded high beams:
    - When a vehicle cuts in front of your vehicle
    - When another vehicle crosses in front of the vehicle
    - When vehicles ahead are repeatedly detected and then hidden due to repeated curves, road dividers or road-side trees
    - When a vehicle ahead approaches from

- a far lane
- When a vehicle ahead is far away
- When a vehicle ahead has no lights
- When the lights of a vehicle ahead are dim
- When a vehicle ahead is reflecting strong light, such as the headlights of your vehicle
- Situations in which the sensors may not operate properly: →P.257
- The high beams may change to the shaded high beams if a vehicle ahead that is using fog lights without its headlights turned on is detected.
- House lights, street lights, traffic signals, and illuminated billboards or signs and other reflective objects may cause the high beams to change to the shaded high beams, cause the high beams not to change to the shaded high beams, or change the area that is not illuminated.
- The following may change the speed at which the shaded areas change or the timing at which the headlights change to the low beams:
  - The brightness of lights of vehicles ahead
  - The movement and direction of vehicles ahead
  - The distance between the vehicle and a vehicle ahead
  - When a vehicle ahead only has lights illuminated on one side
  - When a vehicle ahead is a two-wheeled vehicle
  - The condition of the road (gradient, curve, condition of the road surface, etc.)
  - The number of passengers and amount of luggage
- The light distribution control of the headlights may not match the driver's expectations
- Bicycles and other small vehicles may not be detected.
- In the following situations, the system may not be able to correctly detect the brightness of the surroundings. This may cause the low beams to remain on or the high beams to flash or dazzle pedestrians or vehicles ahead. In such a case, it is necessary to manually change between the high beams and low beams.
  - When there are lights similar to head-

- lights or tail lights in the surrounding area
- When headlights or tail lights of vehicles ahead are turned off, dirty, changing color, or not aimed properly
- When the headlights are repeatedly changing between the high beams and low beams.
- When use of the high beams is inappropriate or when the high beams may be flashing or dazzling pedestrians or other drivers.
- When the vehicle is used in an area in which vehicles travel on the opposite side of the road of the country for which the vehicle was designed, for example using a vehicle designed for right-hand traffic in a left-hand traffic area, or vice versa
- When it is necessary to disable the system: →P.252
- Situations in which the sensors may not operate properly: →P.257

#### ■ Customization

The settings of some functions can be changed. (→P.590)

### Turning the high beams on/off manually

#### ■ Changing to the high beams

- 1 Push the lever forward.

The AHS indicator will turn off and the high beam indicator will turn on.

Pull the lever to its original position to enable the Adaptive High-beam System again.

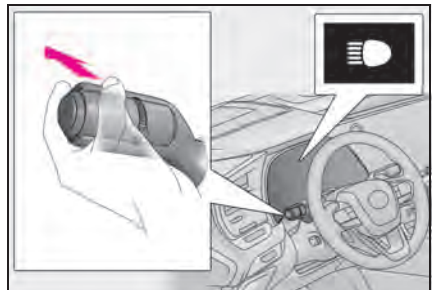

### ■ Changing to the low beams

- 1 Press the Adaptive High-beam System switch.

The AHS indicator will turn off.

Press the switch to enable the Adaptive High-beam System again.

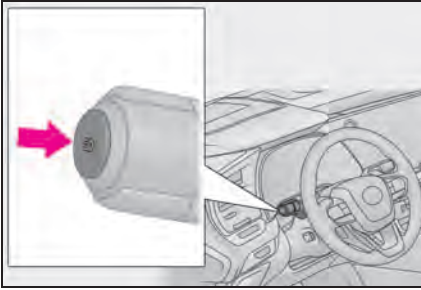

### ■ Temporarily changing to the low beams

It is recommended to switch to the low beams when use of the high beams is inappropriate or when the high beams may cause problems or distress to other drivers or pedestrians nearby.

- 1 Pull the lever rearward and then return it to its original position.

The high beams will illuminate while the lever is pulled, however, after the lever is returned to its original position, the low beams will remain on for a certain amount of time. After this, the Adaptive High-beam System will operate.

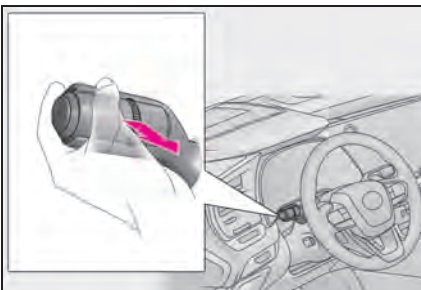

### AHB (Automatic High Beam)\*

\*: If equipped

The Automatic High Beam uses a front camera located on the upper portion of the windshield to detect the brightness of the lights of vehicles ahead, streetlights, etc., and automatically changes the head lights between the high beams and low beams.

#### ⚠ WARNING

##### ■ For safe use

Do not overly rely on the Automatic High Beam. Always drive safely, taking care to observe your surroundings and turning the high beams on or off manually if necessary.

##### ■ To prevent unintentional operation of the Automatic High Beam System

When it is necessary to disable the system: →P.252

### Using the Automatic High Beam system

- 1 Press the Automatic High Beam switch.

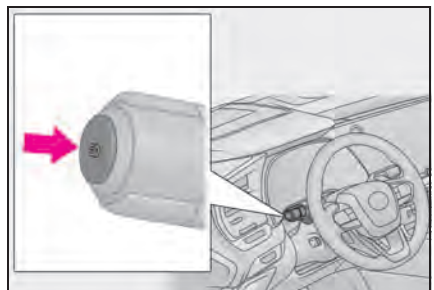

## 2 Turn the headlight switch to the

AUTO or  position.

When the headlight switch lever is in the low beam position, the AHB system will be enabled and the AHB indicator will illuminate.

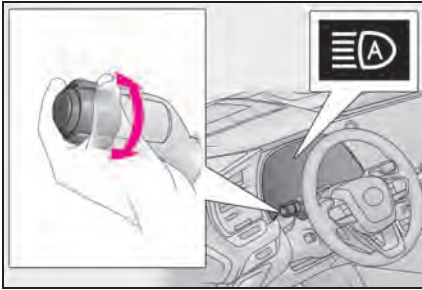

### ■ Automatic operating conditions of the high beams

- When all of the following conditions are met, the high beams will illuminate automatically:
  - The vehicle speed is approximately 21 mph (34 km/h) or more.
  - The area ahead of the vehicle is dark.
  - There are no vehicles ahead with lights on.
  - There are few streetlights or other lights on the road ahead.
- If any of the following conditions are met, the headlights will change to the low beams:
  - Vehicle speed drops below approximately 17 mph (27 km/h).
  - The area ahead of the vehicle is not dark.
  - There is a vehicle ahead with lights on.
  - There are many streetlights or other lights on the road ahead.

### ■ Front camera detection

- In the following situations, the high beams may not be automatically changed to the low beams:
  - When a vehicle cuts in front of your vehicle
  - When another vehicle crosses in front of the vehicle
  - When vehicles ahead are repeatedly detected and then hidden due to repeated curves, road dividers or road-

- side trees
- When a vehicle ahead approaches from a far lane
- When a vehicle ahead is far away
- When a vehicle ahead has no lights
- When the lights of a vehicle ahead are dim
- When a vehicle ahead is reflecting strong light, such as own headlights
- Situations in which the sensors may not operate properly: →P.257
- The headlights may change to the low beams if a vehicle ahead that is using fog lights without its headlights turned on is detected.
- House lights, street lights, traffic signals, and illuminated billboards or signs may cause the high beams to change to the low beams, or the low beams to remain on.
- The following may change the timing at which the headlights change to the low beams:
  - The brightness of lights of vehicles ahead
  - The movement and direction of vehicles ahead
  - The distance between the vehicle and a vehicle ahead
  - When a vehicle ahead only has lights illuminated on one side
  - When a vehicle ahead is a two-wheeled vehicle
  - The condition of the road (gradient, curve, condition of the road surface, etc.)
  - The number of passengers and amount of luggage
- The headlights may change between the high beams and low beams unexpectedly.
- Bicycles and other small vehicles may not be detected.
- In the following situations, the system may not be able to correctly detect the brightness of the surroundings. This may cause the low beams to remain on or the high beams to flash or dazzle pedestrians or vehicles ahead. In such a case, it is necessary to manually change between the high beams and low beams.
  - When there are lights similar to headlights or tail lights in the surrounding area
  - When headlights or tail lights of vehicles ahead are turned off, dirty, changing

- color, or not aimed properly
- When the headlights are repeatedly changing between the high beams and low beams.
- When use of the high beams is inappropriate or when the high beams may be flashing or dazzling pedestrians or other drivers.
- When the vehicle is used in an area in which vehicles travel on the opposite side of the road of the country for which the vehicle was designed, for example using a vehicle designed for right-hand traffic in a left-hand traffic area, or vice versa
- When it is necessary to disable the system: →P.252
- Situations in which the sensors may not operate properly: →P.257

#### ■ Temporarily reducing front camera sensitivity

The sensitivity of the front camera can be temporarily reduced.

- 1 Turn the power switch off with the following conditions met.
  - The headlight switch is in the  or AUTO position.
  - The headlight switch lever is in the low beam position.
  - The Automatic High Beam switch is on.
- 2 Turn the power switch to ON.
- 3 Within 60 seconds after performing step 2, push the headlight switch lever to the high beam position then pull it to the original position quickly 10 times, then leave the lever in its original position.
- 4 If the sensitivity is changed, the Automatic High Beam indicator will blink 3 times.

### Turning the high beams on/off manually

#### ■ Changing to the high beams

- 1 Push the lever forward.

The AHB indicator will turn off and the high beam indicator will turn on.

Pull the lever to its original position to enable the Automatic High Beam system again.

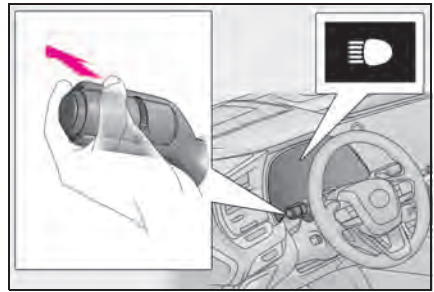

#### ■ Changing to the low beams

- 1 Press the Automatic High Beam switch.

The AHB indicator will turn off.

Press the switch to enable the Automatic High Beam system again.

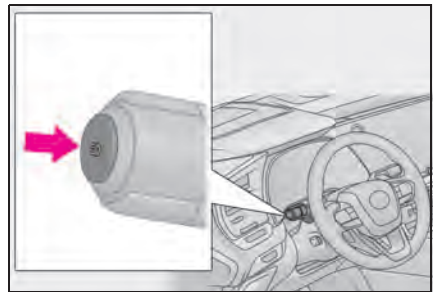

#### Temporarily changing to the low beams

It is recommended to switch to the low beams when use of the high beams is inappropriate or when the high beams may cause problems or distress to other drivers or pedestrians nearby.

- 1 Pull the lever rearward and then return it to its original position.

The high beams will illuminate while the lever is pulled, however, after the lever is returned to its original position, the low beams will remain on for a certain amount

of time. After this, the Automatic High Beam system will operate.

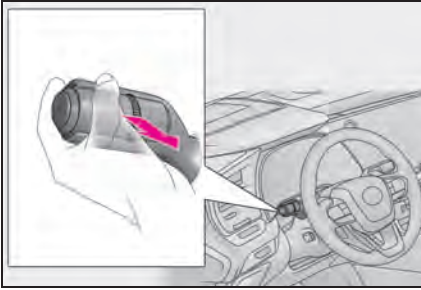

## Fog light switch

The fog lights secure excellent visibility in difficult driving conditions, such as in rain and fog.

## Operating instructions

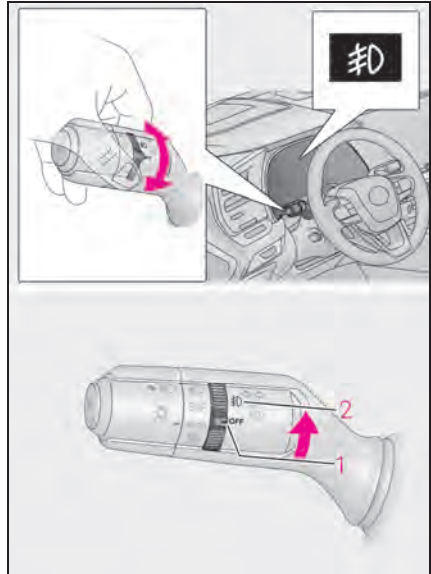

- 1** OFF (U.S.A.) or  $\circ$  (Canada)  
Turns the fog lights off
- 2**  $\neq \text{D}$  Turns the fog lights on

■ Fog lights can be used when  
The headlights are on in low beam.

## Windshield wipers and washer

Operating the lever can switch between automatic operation and manual operation, or can use the washer.

### NOTICE

#### When the windshield is dry

Do not use the wipers, as they may damage the windshield.

## Operating the wiper lever

Operating the  lever operates the wipers or washer as follows:

When **AUTO** is selected, the wipers will operate automatically when the sensor detects falling rain. The system automatically adjusts wiper timing in accordance with rain volume and vehicle speed.

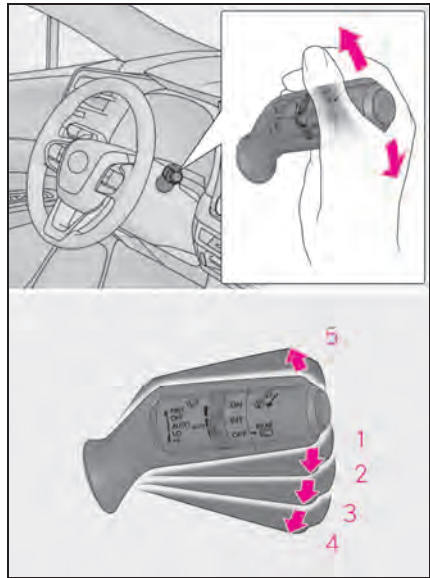

- 1** OFF (U.S.A.) or ○ (Canada)  
Off
- 2** AUTO Rain-sensing wiper operation
- 3** LO (U.S.A.) or ▼ (Canada)  
Low speed operation
- 4** HI (U.S.A.) or ▼ (Canada)  
High speed operation
- 5** MIST (U.S.A.) or △ (Canada)  
Temporary operation

When **AUTO** is selected, the sensor sensitivity can be adjusted by turning the switch ring.

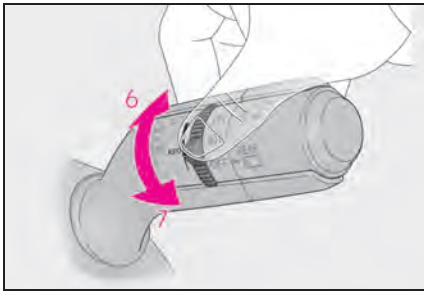

- 6** Increases the sensitivity  
**7** Decreases the sensitivity



- 8**  Washer/wiper dual operation

Pulling the lever operates the wipers and washer.

(After operating several times, the wipers operate once more time after a short delay to prevent dripping. However, the dripping prevention does not operate while the vehicle is moving.)

Vehicles with headlight cleaners:

When the power switch is in ON and the headlights are on, if the lever is pulled, the headlight cleaners will operate once. After this, the headlight cleaners will operate every 5th time the lever is pulled.

#### ■ The windshield wipers and washer can be operated when

The power switch is in ON.

#### ■ Operating the windshield wipers and washer using the voice control system \*

\*: If equipped

The following operation can be performed using the voice control system.

- Operating the windshield wipers only once
- Operating the windshield washer (it can be performed only when the vehicle is stopped)

For details regarding the voice control system, refer to the "MULTIMEDIA OWNER'S MANUAL".

#### ■ Effects of vehicle speed on wiper operation

With low speed windshield wiper operation selected, wiper operation will be switched from low speed to intermittent wiper operation when the vehicle is stationary. (However, when the sensor sensitivity is adjusted to the highest level, the mode will not switch.)

#### ■ Raindrop sensor

- The raindrop sensor judges the amount of raindrops.

An optical sensor is adopted. It may not operate properly when sunlight from the rising or setting of the sun intermittently strikes the windshield, or if bugs, etc. are present on the windshield.

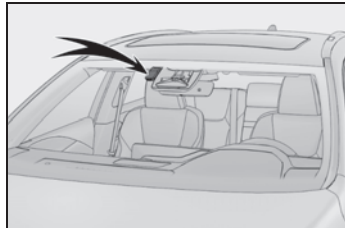

- If the wiper switch is turned to the AUTO position while the power switch is in ON, the wipers will operate once to show that AUTO mode is activated.
- When the sensor sensitivity ring is turned toward high while in AUTO position, the wipers will operate once to indicate that the sensor sensitivity is enhanced.
- If the temperature of the raindrop sensor is 185°F (85°C) or higher, or 5°F (-15°C) or lower, automatic operation may not occur. In this case, operate the

wipers in any mode other than AUTO mode.

#### ■ If no windshield washer fluid sprays

Check that the washer nozzles are not blocked, if there is washer fluid in the washer fluid tank.



#### ■ Front door opening linked windshield wiper stop function

When AUTO is selected and the windshield wipers are operating, if a front door is opened, the operation of the windshield wipers will be stopped to prevent anyone near the vehicle from being sprayed by water from the wipers, provided the vehicle is stopped with the parking brake applied or the shift position in P. When the front door is closed, wiper operation will resume.

### ⚠ WARNING

#### ■ Caution regarding the use of windshield wipers in AUTO mode

The windshield wipers may operate unexpectedly if the sensor is touched or the windshield is subject to vibration in AUTO mode. Take care that your fingers, etc. do not become caught in the windshield wipers.

#### ■ Caution regarding the use of washer fluid

When it is cold, do not use the washer fluid until the windshield becomes warm. The fluid may freeze on the windshield and cause low visibility. This may lead to an accident, resulting in death or serious injury.

### ⚠ NOTICE

#### ■ When the washer fluid tank is empty

Do not operate the switch continually as the washer fluid pump may overheat.

#### ■ When a nozzle becomes blocked

In this case, contact your Lexus dealer. Do not try to clear it with a pin or other object. The nozzle will be damaged.

#### ■ To prevent 12-volt battery discharge

Do not leave the wipers on longer than necessary when the hybrid system is off.

### Changing the windshield wiper rest position/Lifting the windshield wipers

When the windshield wipers are not being used, they retract to below the hood. To enable the windshield wipers to be lifted when parking in cold conditions or when replacing a windshield wiper insert, change the rest position of the windshield wipers to the service position using the wiper lever.

#### ■ Raising the wipers to the service position

Within approximately 45 seconds of turning the power switch off, move the wiper lever to the MIST (U.S.A.) or Δ (Canada) position and hold it for approximately 2 seconds or more.

The wipers will move to the service position.

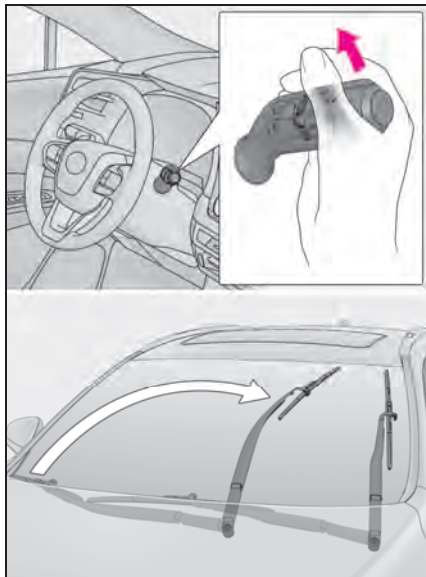

### ■ Lifting the windshield wipers

While holding the hook portion of the wiper arm, lift the windshield wiper from the windshield.

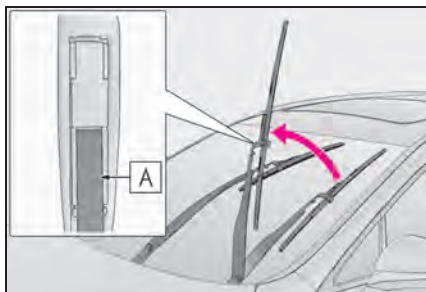

**A** Hook portion

### ■ Lowering the windshield wipers to the retracted position

With the windshield wipers placed on the windshield, turn the power switch to ON and then move the wiper lever to an operating position. When the wiper switch is turned off, the windshield wipers will stop at the retracted position.

### ■ Operating the windshield wipers and washer using the voice control system\*

\* If equipped

► For the U.S.A.

The windshield wipers can be moved to the service position using the voice control system. (Operation is possible only when the vehicle is stopped with the wiper switch in OFF.)

► For Canada

The windshield wipers can be moved to the service position using the voice control system. (Operation is possible only when the vehicle is stopped with the wiper switch in  $\odot$ .)

For details regarding the voice control system, refer to the "MULTIMEDIA OWNER'S MANUAL".

### ⚠ NOTICE

#### ■ When lifting the windshield wipers

- Do not lift the windshield wipers when they are in the retracted position below the hood. Otherwise, they may contact the hood, possibly resulting in damage to a windshield wiper and/or the hood.
- Do not lift a windshield wiper by the wiper blade. Otherwise, the wiper blade may be deformed.

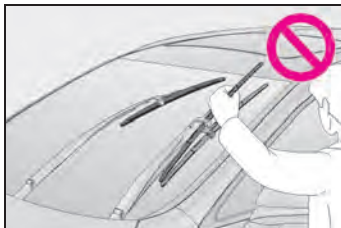

- Do not operate the wiper lever when the windshield wipers are lifted. Otherwise, the windshield wipers may contact the hood, possibly resulting in damage to the windshield wipers and/or hood.

## Rear window wiper and washer

### NOTICE

#### When the rear window is dry

Do not use the wiper, as it may damage the rear window.

## Operating the wiper lever

Operating the  switch operates the rear wiper as follows:

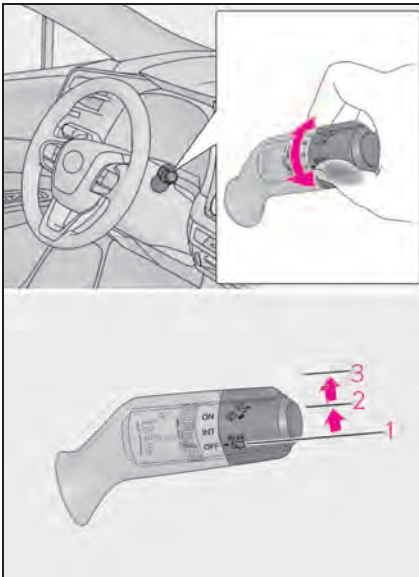

- 1 OFF (U.S.A.) or ○ (Canada) Off
- 2 INT (U.S.A.) or --- (Canada) Intermittent operation
- 3 ON (U.S.A.) or — (Canada) Normal operation

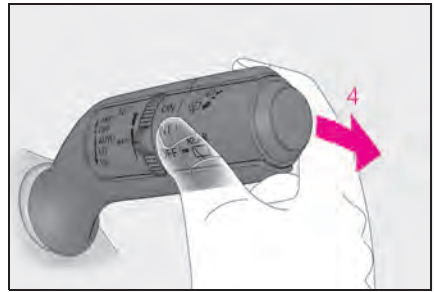

### 4 Washer/wiper dual operation

Pushing the lever operates the wiper and washer.

The wiper will automatically operate a couple of times after the washer squirts.

Vehicles with camera cleaning washer: The washer will automatically operate and clean the rear camera.\*

\*: Refer to "MULTIMEDIA OWNER'S MANUAL".

### ■ The rear window wiper and washer can be operated when

The power switch is in ON.

### ■ Operating the rear window wiper and washer using the voice control system\*

\*: If equipped

The following operation can be performed using the voice control system.

- Operating the rear window wiper only once
- Operating the rear window washer (it can be performed only when the vehicle is stopped)

For details regarding the voice control system, refer to the "MULTIMEDIA OWNER'S MANUAL".

### ■ If no washer fluid sprays

Check that the washer nozzle is not blocked if there is washer fluid in the washer fluid tank.

#### ■ Reverse-linked rear window wiper function

When the shift position is shifted to R when the front wipers are operating, the rear window wiper will operate once.

#### ■ Back door opening linked rear window wiper stop function

When the rear window wiper is operating, if the back door is opened while the vehicle is stopped, operation of the rear window wiper will be stopped to prevent anyone near the vehicle from being sprayed by water from the wiper. When the back door is closed, wiper operation will resume.



#### NOTICE

##### ■ When the washer fluid tank is empty

Do not operate the switch continually as the washer fluid pump may overheat.

##### ■ When a nozzle becomes blocked

In this case, contact your Lexus dealer. Do not try to clear it with a pin or other object. The nozzle will be damaged.

##### ■ To prevent 12-volt battery discharge

Do not leave the wiper on longer than necessary when the hybrid system is off.

## Opening the fuel tank cap

The fuel tank of your vehicle has a special structure, which requires a reduction in fuel tank pressure before refueling. After the opener switch has been pressed, it will take several seconds until the vehicle is ready for refueling.

## Before refueling the vehicle

- Close all the doors and windows, and turn the power switch off.
- Confirm the type of fuel.

### ■ Fuel types

→P.579

### ■ Fuel tank opening for unleaded gasoline

To help prevent incorrect fueling, your vehicle has a fuel tank opening that only accommodates the special nozzle on unleaded fuel pumps.



## WARNING

### ■ When refueling the vehicle

Observe the following precautions while refueling the vehicle. Failure to do so may result in death or serious injury.

- After exiting the vehicle and before opening the fuel door, touch an unpainted metal surface to discharge any static electricity. It is important to discharge static electricity before refueling because sparks resulting from static electricity can cause fuel vapors to ignite while refueling.

- Always hold the grips on the fuel tank cap and turn it slowly to remove it. A whooshing sound may be heard when the fuel tank cap is loosened. Wait until the sound cannot be heard before fully removing the cap. In hot weather, pressurized fuel may spray out of the filler neck and cause injury.
- Do not allow anyone that has not discharged static electricity from their body to come close to an open fuel tank.
- Do not inhale vaporized fuel. Fuel contains substances that are harmful if inhaled.
- Do not smoke while refueling the vehicle. Doing so may cause the fuel to ignite and cause a fire.
- Do not return to the vehicle or touch any person or object that is statically charged. This may cause static electricity to build up, resulting in a possible ignition hazard.

### ■ When refueling

Observe the following precautions to prevent fuel overflowing from the fuel tank:

- Securely insert the fuel nozzle into the fuel filler neck.
- Stop filling the tank after the fuel nozzle automatically clicks off.
- Do not top off the fuel tank.



## NOTICE

### Refueling

- Finish refueling within 30 minutes. If more than 30 minutes passes, the internal valve closes. In this condition, fuel may overflow during the refueling process. Press the fuel filler door opener switch again.
- Make sure that the fuel filler door lock is not pushed by the fuel nozzle boot, etc. If the lock is held, the internal valve closes and fuel may overflow. To prevent it, press the fuel filler door opener switch again.

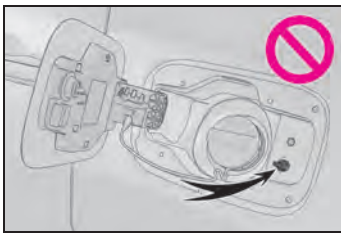

- Do not spill fuel during refueling. Doing so may damage the vehicle, such as causing the emission control system to operate abnormally or damaging fuel system components or the vehicle's painted surface.

### Opening the fuel tank cap

- 1 Press the switch to open the fuel filler door.

The fuel filler door will open within about 10 seconds of the switch being pressed. Before refueling is possible, a message will be shown on the multi-information display in the instrument cluster to indicate the

progress of the fuel filler door opener.

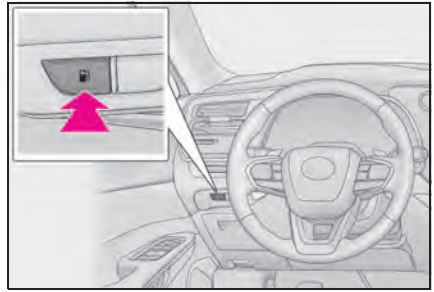

- 2 Turn the fuel tank cap slowly and remove it, then put it into the holder on the fuel filler door.

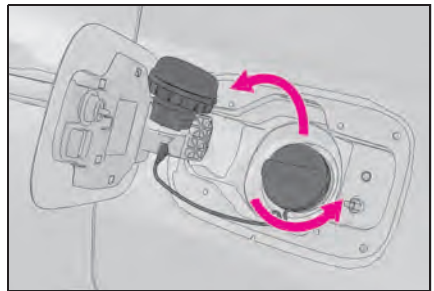

- If the fuel filler door cannot be opened  
Consult your Lexus dealer.

### Closing the fuel tank cap

After refueling, turn the fuel tank cap until you hear a click. Once the cap is released, it will turn slightly in the opposite direction.

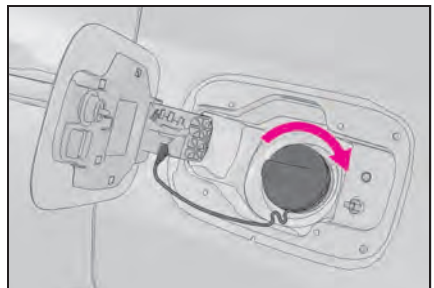

---

■ **When “Check Fuel Cap” is displayed on the multi-information display**

The fuel tank cap may be unfastened or loose. Turn the power switch off, check the cap and tighten it securely. If the message remains, wait a few seconds and then turn the power switch off once again.



**WARNING**

■ **When replacing the fuel tank cap**

Do not use anything but a genuine Lexus fuel tank cap designed for your vehicle. Doing so may cause a fire or other incident which may result in death or serious injury.

## Lexus Safety System + 3/Traffic Jam Assist software update

It is necessary to enter a connected services contract, provided by Lexus, to use these functions. For details, contact your Lexus dealer.

### WARNING

#### ■ For safe use

When the Lexus Safety System + 3/Traffic Jam Assist software is updated, the operating methods of functions may change. Using this system without knowing the correct operating methods may lead to an accident resulting in death or serious injury.

- Make sure to read the Digital Owner's Manual which corresponds to the software version of the system, available at the Owner's Manual website, before using this system.

## Content of the Lexus Safety System + 3/Traffic Jam Assist Owner's Manual

This Owner's Manual contains information for Ver. 2. For the latest information about the controls, use, warnings/precautions, etc. of each function of Lexus Safety System + 3/Traffic Jam Assist, refer to the Digital Owner's Manual at the Owner's Manual website.

If the software of this system has been updated after initial purchase of the vehicle, before using this system, be sure to read the Owner's Manual which corresponds to the software ver-

sion of the system.

### ■ Precautions for use

- Be aware that some functions may temporarily be disabled if a legal or safety related issue occurs.
- If a connected services contract has not been entered or has expired, software updates will not be able to be performed wirelessly.

## Checking your vehicle's Lexus Safety System + 3/Traffic Jam Assist version

If the software of this system has been updated after initial purchase of the vehicle, to access the appropriate Owner's Manual, it is necessary to check the software version of the system and then visit the Owner's Manual website.

### Checking the version using Lexus App

The software version of the system can be checked using Lexus App.

### Using your vehicle's Lexus Safety System + 3/Traffic Jam Assist version

- 1 Access the following URL using a computer or smartphone:

► For U.S.A. owners

<https://drivers.lexus.com/lexusdrivers/resources/owners-manuals/manual?om=om0e095u.rx.2023.2210.hev.vh>



► For Canadian owners

<https://www.lexus.ca/lexus/know-your-lexus/manual?om=om0e095u.rx.2023.2210.hev.vh>



2 Select the file which includes the previously checked system version.

## Updating the software

If a software update is available, a notification will be displayed by Lexus App. Follow the instructions displayed on the screen.

### ■ Software update precautions

- After a software update has been performed, it will not be possible to revert to a previous version.
- Depending on the communication environment and the content of an update, a software update may take several hours. Although an update will be suspended when the power switch is turned off, it will resume when the power switch is changed back to ON.

- Lexus Safety System + 3/Traffic Jam Assist can still be used while a software update is being performed.

### ■ What can be checked using the Lexus App

The following items can be checked or performed.

- Software version, update details, precautions, use methods, etc.
- Software update

## Lexus Safety System + 3

The Lexus Safety System + 3 consists of the driving assist systems and contributes to a safe and comfortable driving experience:

### WARNING

#### ■ Lexus Safety System + 3

The Lexus Safety System + 3 operates under the assumption that the driver will drive safely, and is designed to help reduce the impact to the occupants in a collision and assist the driver under normal driving conditions.

As there is a limit to the degree of recognition accuracy and control performance that this system can provide, do not overly rely on this system. The driver is solely responsible for paying attention to the vehicle's surroundings and driving safely.

#### ■ For safe use

- Do not overly rely on this system. The driver is solely responsible for paying attention to the vehicle's surroundings and driving safely. This system may not operate in all situations and provided assistance is limited. Over-reliance on this system to drive the vehicle safely may lead to an accident resulting in death or serious injury.
- Do not attempt to test the operation of the system, as it may not operate properly, possibly leading to an accident.
- If attention is necessary while performing driving operations or a system malfunction occurs, a warning message or warning buzzer will be operated. If a warning message is displayed on the display, follow the instructions displayed.

- Depending on external noise, the volume of the audio system, etc. it may be difficult to hear the warning buzzer. Also, depending on the road conditions, it may be difficult to recognize the operation of the system.

#### ■ When it is necessary to disable the system

In the following situations, make sure to disable the system.

Failure to do so may lead to the system not operating properly, possibly leading to an accident resulting in death or serious injury.

- When the vehicle is tilted due to being overloaded or having a flat tire
- When driving at extremely high speeds
- When towing another vehicle
- When the vehicle is being transported by a truck, ship, train, etc.
- When the vehicle is raised on a lift and the tires are allowed to rotate freely
- When inspecting the vehicle using a drum tester such as a chassis dynamometer or speedometer tester, or when using an on vehicle wheel balancer
- When the vehicle is driven in a sporty manner or off-road
- When using an automatic car wash
- When a sensor is misaligned or deformed due to a strong impact being applied to the sensor or the area around the sensor
- When accessories which obstruct a sensor or light are temporarily installed to the vehicle
- When a compact spare tire or tire chains are installed to the vehicle or an emergency tire puncture repair kit has been used

**⚠ WARNING**

- When the tires are excessively worn or the inflation pressure of the tires is low
- When tires other than the manufacturer specified size are installed
- When the vehicle cannot be driven stably, due to a collision, malfunction, etc.

**Driving assist systems**■ **AHS (Adaptive High-beam System)\***

→P.234

\* : If equipped

■ **AHB (Automatic High Beam)\***

→P.237

\* : If equipped

■ **PCS (Pre-Collision System)**

→P.261

■ **LTA (Lane Tracing Assist)**

→P.271

■ **LDA (Lane Departure Alert)**

→P.279

■ **LCA (Lane Change Assist)\***

→P.276

\* : If equipped

■ **FCTA (Front Cross Traffic Alert)\***

→P.290

\* : If equipped

■ **PDA (Proactive Driving Assist)**

→P.285

■ **RSA (Road Sign Assist)\***

→P.293

\* : If equipped

■ **Dynamic radar cruise control**

→P.295

■ **Cruise control**

→P.306

■ **Emergency Driving Stop System**

→P.311

■ **Traffic Jam Assist\***

→P.313

\* : If equipped

■ **Driver monitor\***

→P.259

\* : If equipped

**Sensors used by Lexus Safety System + 3**

Various sensors are used to obtain the necessary information for system operation.

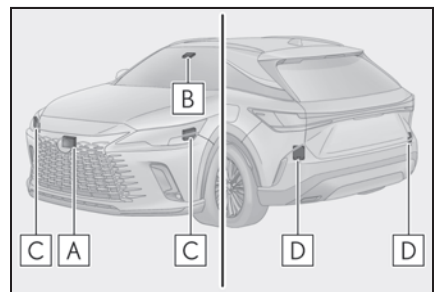
■ **Sensors which detect the surrounding conditions**

[A] Front radar sensor

[B] Front camera

**C** Front side radar sensors \*

**D** Rear side radar sensors

\* : If equipped

### ■ Sensors which detect the driver condition

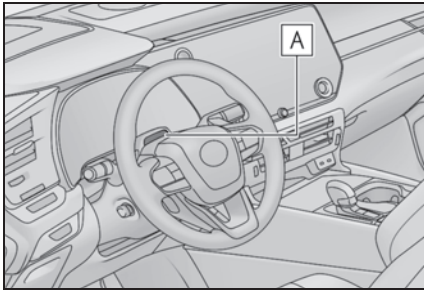

**A** Driver monitor camera \*

\* : If equipped

### ⚠ WARNING

#### ■ To prevent malfunction of the radar sensors

Observe the following precautions.

Failure to do so may lead to a radar sensor not operating properly, possibly leading to an accident resulting in death or serious injury.

- Keep the radar sensors and radar sensor covers clean at all times.

Clean the front of a radar sensor or the front or back of a radar sensor cover if it is dirty or covered with water droplets, snow, etc.

When cleaning the radar sensor and radar sensor cover, use a soft cloth to remove dirt so as to not damage them.

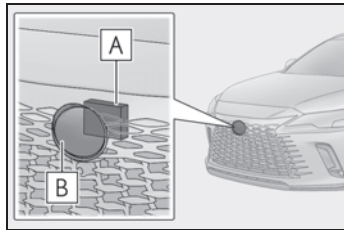

**A** Radar sensor

**B** Radar sensor cover

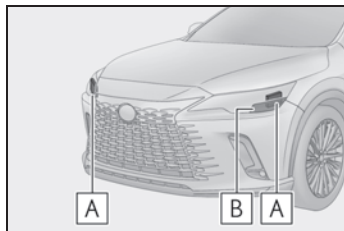

**A** Radar sensor

**B** Radar sensor cover

- Vehicles with front side radar sensors: Keep the surrounding area of the front side radar sensors on the front bumper clean at all times.
- Do not attach accessories, stickers (including transparent stickers), aluminum tape, etc. to a radar sensor or radar sensor cover and their surrounding area.
- Do not subject a radar sensor or its surrounding area to impact. If a radar sensor, the front grille, or front bumper has been subjected to an impact, have the vehicle inspected by your Lexus dealer.

**WARNING**

- Do not disassemble the radar sensors.
- Do not modify or paint the radar sensors or radar sensor cover, or replace them with anything other than Lexus genuine parts.
- In the following situations, recalibration of the radar sensors will be necessary. For details, contact your Lexus dealer.
  - When a radar sensor is removed and installed, or replaced
  - When the front bumper or the front grille has been replaced
- **Radar sensor cover with a heater (if equipped)**

When the system determines that snow may pile up over the radar sensor cover, the heater will operate automatically. If the area around the radar sensor cover is to be touched, such as during cleaning, make sure that the radar sensor cover is cool enough to prevent burns.

■ **To prevent malfunction of the front camera**

Observe the following precautions.

Failure to do so may lead to the front camera not operating properly, possibly leading to an accident resulting in death or serious injury.

- Always keep the windshield clean.
  - If the windshield is dirty or covered with an oily film, water droplets, snow, etc., clean the windshield.
  - Even if a glass coating agent is applied to the windshield, it will still be necessary to use the windshield wipers to remove water droplets, etc. from the area of the windshield in front of the front camera.
  - If the inner side of the windshield where the front camera is installed is dirty, contact your Lexus dealer.

- Do not attach stickers (including transparent stickers) or other items to the area of the windshield in front of the front camera (shaded area in the illustration).

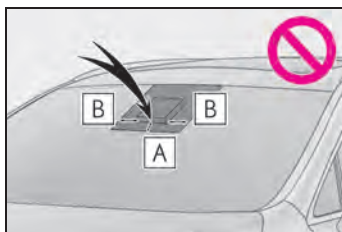

- A** Approximately 1.6 in. (4 cm)
- B** Approximately 1.6 in. (4 cm)

- If the part of the windshield in front of the front camera is fogged up or covered with condensation or ice, use the windshield defogger to remove the fog, condensation, or ice.
- If water droplets cannot be properly removed from the area of the windshield in front of the front camera by the windshield wipers, replace the wiper insert or wiper blade.
- Do not attach window tint to the windshield.
- Replace the windshield if it is damaged or cracked. If the windshield has been replaced, recalibration of the front camera will be necessary. For details, contact your Lexus dealer.
- Do not allow liquids to contact the front camera.
- Do not allow bright lights to shine into the front camera.

**WARNING**

- Do not damage the lens of the front camera or allow it to become dirty. When cleaning the inside of the windshield, do not allow glass cleaner to contact the lens of the front camera. Do not touch the lens of the front camera. If the lens of the front camera is dirty or damaged, contact your Lexus dealer.
- Do not subject the front camera to a strong impact.
- Do not change the position or orientation of the front camera or remove it.
- Do not disassemble the front camera.
- Do not modify any parts around the front camera, such as the inside rear view mirror or ceiling.
- Do not attach accessories which may obstruct the front camera to the hood, front grille, or front bumper. For details, contact your Lexus dealer.
- If a surfboard or other long object is to be mounted on the roof, make sure that it will not obstruct the front camera.
- Do not modify or change the headlights and other lights.

**■ Front camera installation area on the windshield**

If the system determines that the windshield may be fogged up, it will automatically operate the heater to defog the part of the windshield around the front camera. When cleaning, etc., be careful not to touch the area around the front camera until the windshield has cooled sufficiently, as touching it may cause burns.

**■ Precautions for the driver monitor camera (if equipped)**

Observe the following precautions.

Failure to do so may lead to malfunction of the driver monitor camera and the systems not operating properly, possibly leading to an accident resulting in death or serious injury.

- Do not subject the driver monitor camera or its surrounding area to strong impact.
- If subjected to a strong impact, the driver monitor camera may move out of alignment and the driver may no longer be detected correctly. In this case, have the vehicle inspected by your Lexus dealer.
- Do not disassemble or modify the driver monitor camera.
- Do not attach accessories, stickers (including transparent stickers), etc. to the driver monitor camera or its surrounding area.
- Do not allow the driver monitor camera or its surrounding area to get wet.
- Do not cover the driver monitor camera or place anything in front of it.
- Keep the lens of the driver monitor camera free from damage.
- Do not touch the lens of the driver monitor camera or allow it to become dirty.

When there is dirt or fingerprints on the camera lens, clean it with a dry, soft cloth so as to not mark or damage it.

- When cleaning the lens, do not use detergents or organic solvents that may damage plastic.

**■ Precautions for use**

Vehicles with a 9.8 inch display audio: It is necessary to enter a connected services contract, provided by Lexus, to use these functions. For details, contact your Lexus dealer.

- Radar Cruise Control: Extended resume time

→P.295

- Traffic Jam Assist (if equipped)

→P.313

■ **Situations in which the sensors may not operate properly**

- When the height or inclination of the vehicle has been changed due to modifications
- When the windshield is dirty, fogged up, cracked or damaged
- When the ambient temperature is high or low
- When mud, water, snow, dead insects, foreign matter, etc., is attached to the front of the sensor
- When in inclement weather such as heavy rain, fog, snow, or a sandstorm
- When water, snow, dust, etc. is thrown up in front of the vehicle, or when driving through mist or smoke
- When the headlights are not illuminated while driving in the dark, such as at night or when in a tunnel
- When the lens of a headlight is dirty and illumination is weak
- When the headlights are misaligned
- When a headlight is malfunctioning
- When the headlights of another vehicle, sunlight, or reflected light shines directly into the front camera
- When the brightness of the surrounding area changes suddenly
- When driving near a TV tower, broadcasting station, electric power plant, radar equipped vehicles, etc., or other location where strong radio waves or electrical noise may be present
- When a wiper blade is blocking the front camera
- When in a location or near objects which strongly reflect radio waves, such as the following:
  - Tunnels
  - Truss bridges
  - Gravel roads
  - Rutted, snow-covered roads
  - Walls

- Large trucks
- Manhole covers
- Guardrail
- Metal plates
- When near a step or protrusion
- When a detectable vehicle is narrow, such as a small mobility vehicle
- When a detectable vehicle has a small front or rear end, such as an unloaded truck
- When a detectable vehicle has a low front or rear end, such as a low bed trailer

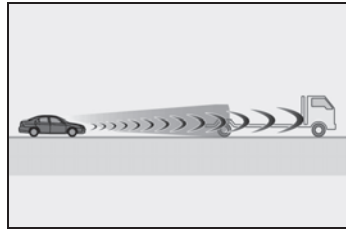

- When a detectable vehicle has extremely high ground clearance

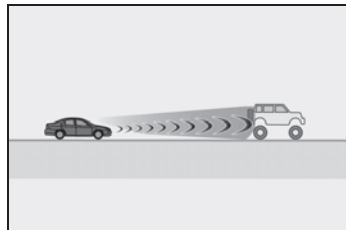

- When a detectable vehicle is carrying a load which protrudes from its cargo area
- When a detectable vehicle has little exposed metal, such as a vehicle which is partially covered with cloth, etc.
- When a detectable vehicle is irregularly shaped, such as a tractor, sidecar, etc.
- When the distance between the vehicle and a detectable vehicle has become extremely short
- When a detectable vehicle is at an angle
- When snow, mud, etc. is attached to a detectable vehicle
- When driving on the following kinds of roads:
  - Roads with sharp curves or winding roads

- Roads with changes in grade, such as sudden inclines or declines
- Roads which is sloped to the left or right
- Roads with deep ruts
- Roads which are rough and unmaintained
- Roads which frequently undulate or are bumpy
- When the steering wheel is being operated frequently or suddenly
- When the vehicle is not in a constant position within a lane
- When parts related to this system, the brakes, etc. are cold or extremely hot, wet, etc.
- When the wheels are misaligned
- When driving on slick road surfaces, such as when it is covered with ice, snow, gravel, etc.
- When the course of the vehicle differs from the shape of a curve
- When the vehicle speed is excessively high when entering a curve
- When entering/exiting a parking lot, garage, car elevator, etc.
- When driving in a parking lot
- When driving through an area where there are obstructions which may contact your vehicle, such as tall grass, tree branches, a curtain, etc.
- When driving in strong wind
- **Situations in which the lane may not be detected**
- When the lane is extremely wide or narrow
- Immediately after changing lanes or passing through an intersection
- When driving in a temporary lane or lane regulated by construction
- When there are structures, patterns, shadows which are similar to lane lines in the surrounding
- When there are multiple white lines for a lane line
- When the lane lines are not clear or driving on a wet road surface
- When a lane line is on a curb
- When driving on a bright, reflective road surface, such as concrete
- **Situations in which some or all of the functions of the system cannot operate**
- When a malfunction is detected in this system or a related system, such as the brakes, steering, etc.
- When the VSC, TRAC, or other safety related system is operating
- When the VSC, TRAC, or other safety related system is off
- **Changes in brake operation sound and pedal response**
- When the brakes have been operated, brake operation sounds may be heard and the brake pedal response may change, but this does not indicate a malfunction.
- When the system is operating, the brake pedal may feel stiffer than expected or sink. In either situation the brake pedal can be depressed further. Further depress the brake pedal as necessary.
- **Situations in which the driver monitor may not operate properly (if equipped)**
- In situations such as the following, the driver monitor camera may not be able to detect the driver's face, and the function may not operate properly.
- When the inside of the vehicle is hot, such as after the vehicle has been parked in the sun
- When a very bright light, such as the sun or the headlights of following vehicle, shines onto the driver monitor camera
- When the brightness inside the vehicle changes frequently due to the shadows of surrounding structures, etc.
- When a very bright light, such as the sun or the headlights of an oncoming vehicle, is shining onto the driver's face
- When light, either inside or outside of the vehicle, is being reflected from the lenses of eyeglasses or sunglasses
- When there are multiple faces in the detection range of the driver monitor

camera, such as when a front or rear passenger is leaning toward the driver's seat

- When the driver's face is outside of the detection range of the driver monitor camera, such as when leaned forward or when their head is outside of the window
- When the driver monitor camera is being blocked by the steering wheel, a hand holding the steering wheel, an arm, etc.
- When the driver is wearing a hat
- When the driver is wearing an eyepatch
- When the driver is wearing eyeglasses or sunglasses that do not easily transmit infrared rays
- When the driver is wearing contact lenses
- When the driver is wearing a face mask
- When the driver is laughing or their eyes are only slightly open
- When the driver's eyes, nose, mouth, or shape of their face is blocked
- When the driver is wearing makeup which makes it difficult to detect their eyes, nose, mouth, or shape of their face
- When the driver's eyes are blocked by the frame of eyeglasses, sunglasses, hair, etc.
- When there is a device inside the vehicle that radiates near infrared rays, such as a non-genuine driver monitoring system.

## Driver monitor\*

\*: If equipped

### Basic functions

During controlled driving, the driver monitor camera detects the position and direction the driver is facing, and whether their eyes are opened or closed. Through this, the system determines if the driver is checking their surroundings and if the driver can perform driving operations.

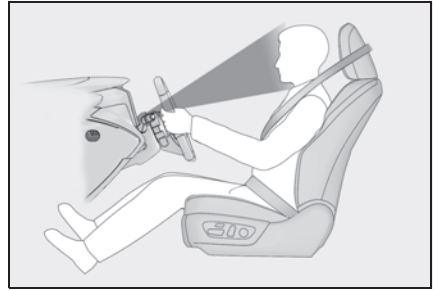

### ■ Warning function

In situations such as the following, a buzzer will sound and a message will be displayed to warn the driver.

- When the system determines that the driver is not paying attention to the road or their eyes are closed
- When the driver's face cannot be detected or the system determines that the driver has poor driving posture

### ■ Face identification

The driver monitor is used as a device to identify faces in order to identify an individual.

For information about how to use the face identification function, priorities among other devices of individual identification, and linked vehicle settings, see “My Settings”. (→P.182)



### WARNING

#### ■ For safe use

- The driver monitor is not designed to prevent the driver from driving carelessly or having a poor driving posture. Pay careful attention to the surrounding conditions in order to ensure safe driving.
- The driver monitor cannot reduce drowsiness. If you feel unable to concentrate or drowsy, take a break and sleep as necessary in order to ensure safe driving.

#### ■ Warning function

These functions may not operate when the vehicle speed is low.

#### ■ Face identification

Face identification starts when the door is opened then closed.

In face identification, facial traits are digitized and stored in a built-in computer, to be used for identification in My Settings.

- Face image or video are not stored. Voice is not stored either.
- Digitized face information is not used for any purpose other than identification in My Settings. Additionally, face information cannot be decoded and will not be disclosed or provided to a third party.
- Face information stored in the vehicle computer cannot be decoded or moved to another media. Therefore, it is necessary to register face information again once it is deleted or relevant parts are replaced.
- Face information can be deleted by yourself.
- Once deleted, face information cannot

be restored. It is necessary to register face information again.

#### ■ Situations where face identification may not be performed correctly

This system is designed for use to identify facial traits. In the following situations, face information may not be able to be registered or identified correctly:

- When a part of the driver’s face (eyebrows, eyes, nose, or mouth) is not visible
- When the driver is wearing glasses/sun glasses, a face mask, muffler, etc.
- When the driver is not facing front
- When part of driver’s face is covered with hair, beard, a hand, clothes, jewelry, etc.
- When the driver is closing eyes
- When a non-registered driver is a twin, etc. with a registered driver, whose face looks quite alike with each other

#### ■ Situations in which the driver monitor may not operate properly

→P.258

### Changing Driver monitor settings

The settings of Driver monitor can be changed through customize settings. (→P.590)

## PCS (Pre-Collision System)

The pre-collision system uses sensors to detect objects (→P.261) in the path of the vehicle. When the system determines that the possibility of a frontal collision with a detectable object is high, a warning operates to urge the driver to take evasive action and the potential brake pressure is increased to help the driver avoid the collision. If the system determines that the possibility of a collision is extremely high, the brakes are automatically applied to help avoid the collision or help reduce the impact of the collision.

The pre-collision system can be disabled/enabled and the warning timing can be changed. (→P.270)



### WARNING

#### ■ For safe use

- Driving safely is solely the responsibility of the driver. Pay careful attention to the surrounding conditions in order to ensure safe driving.

Never use the pre-collision system in place of normal braking operations. This system cannot help avoid or reduce the impact of a collision in every situation. Over-reliance on this system to drive the vehicle safely may lead to an accident resulting in death or serious injury.

- Although the pre-collision system is designed to help avoid or help reduce the impact of a collision, its effectiveness may change according to various conditions. Therefore, it may not always be able to achieve the same level of performance. Read the following items carefully. Do not overly rely on this system and always drive carefully.

- For safe use: →P.252

#### ■ When to disable the pre-collision system

- When it is necessary to disable the system: →P.252

## Detectable objects

The system can detect the following as detectable objects. (Detectable objects differ depending on the function.)

- Vehicles
- Bicycles\*
- Pedestrians
- Motorcycles\*
- Walls

\*: Detected as a detectable object only when being ridden.

## System functions

### ■ Pre-collision warning

When the system determines that the possibility of a collision is high, a buzzer will sound and an icon and warning message will be displayed on the multi-information display to urge the driver to take evasive action.

If the detectable object is a vehicle, moderate braking will be performed with the warning.

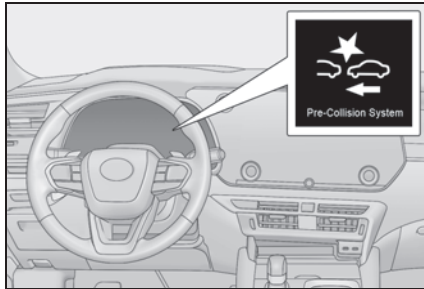

If the system determines that the accelerator pedal is strongly depressed, the following icon and message will be displayed on the multi-information display.



#### ■ Pre-collision brake assist

If the system determines that the possibility of a collision is high and the brake operation by the driver is insufficient, the braking power will be increased.

#### ■ Pre-collision brake control

If the system determines that the possibility of a collision is extremely high, the brakes are automatically applied to help avoid the collision or reduce the impact of the collision.

#### ■ Emergency steering assist

If the system determines that the fol-

lowing conditions are met, assistance will be provided to help enhance vehicle stability and prevent lane departure. During assistance, in addition to the pre-collision warning, the following icon will be displayed on the multi-information display.

- The possibility of a collision is high
- There is sufficient space within the lane to perform evasive steering maneuvers
- The driver is operating the steering wheel

Vehicles with active steering function: The brakes and steering are controlled to help avoid a collision or reduce the impact of a collision, regardless of the evasive steering maneuvers performed by the driver.

During assistance, the pre-collision warning will operate and a message will be displayed to warn the driver.



#### ■ Intersection collision avoidance support (left/right turn)

In situations such as the following, if the system determines that the possibility of a collision is high, the pre-collision warning and pre-collision braking will operate.

Depending on the intersection, assistance may not operate correctly.

- When turning left/right at an intersection and crossing the path of an oncoming vehicle

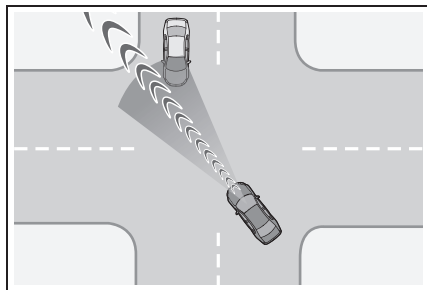

- When turning left/right and a pedestrian or bicycle is detected

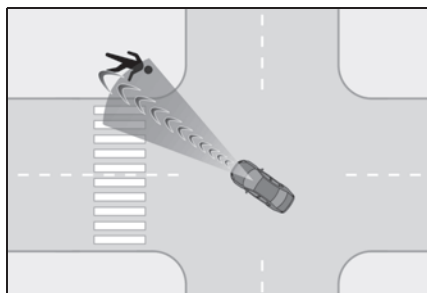

#### ■ Intersection collision avoidance support (crossing vehicles)

At an intersection, etc., if the system determines that the possibility of a collision with an approaching vehicle or motorcycle is high, the pre-collision warning and pre-collision braking will operate.

Depending on the intersection, assistance may not operate correctly.

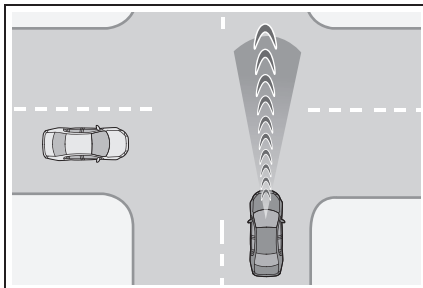

#### ■ Acceleration Suppression at Low Speed

When driving at a low speed, if the accelerator pedal is strongly depressed and the system determines that there is a possibility of a collision, hybrid system output will be restrained or the brakes will be applied weakly to restrict acceleration. During operation, a buzzer will sound and a warning indicator and message will be displayed on the multi-information display.



#### ■ Suspension control (if equipped)

When the system determines that the possibility of a collision is high, the Adaptive Variable Suspension system (→P.394) controls the damping force of the shock absorbers to help maintain an appropriate vehicle posture.

**WARNING**

### ■ Pre-collision braking

- When the pre-collision braking function is operating, a large amount of braking force will be applied.
- The pre-collision braking function is not designed to hold the vehicle stopped. If the vehicle is stopped by pre-collision brake control, the driver should operate the brakes immediately as necessary.
- The pre-collision braking function may not operate if certain operations are performed by the driver. If the accelerator pedal is being depressed strongly or the steering wheel is being turned, the system may determine that the driver is taking evasive action and possibly prevent the pre-collision braking function from operating.
- If the brake pedal is being depressed, the system may determine that the driver is taking evasive action and possibly delay the operation timing of the pre-collision brake control.

### ■ Acceleration Suppression at Low Speed

If the steering wheel is being turned, the system may determine that the driver is taking evasive action and possibly prevent the Acceleration Suppression at Low Speed function from operating or possibly causing its operation to be canceled.

### ■ Emergency steering assist

- The emergency steering assist will be canceled when the system determines that lane departure prevention control has completed.
- Depending on operations performed by the driver, emergency steering assist may not operate or operation may be canceled.
  - If the accelerator pedal is depressed strongly, the steering wheel is turned heavily, the brake pedal is depressed, or the turn signal lever is operated, the system may determine that the driver is taking evasive action and the emergency steering assist may not operate.
  - While the emergency steering assist is operating, if the accelerator pedal is depressed strongly, the steering wheel is turned heavily, or the brake pedal is depressed, the system may determine that the driver is taking evasive action and emergency steering assist operation may be canceled.
  - While the emergency steering assist is operating, if the steering wheel is held or turned in the opposite direction of system operation, emergency steering assist operation will be canceled.

### ■ Operating conditions of each function of the pre-collision system

The pre-collision system is enabled and the system determines that the possibility of a frontal collision with a detected object is high.

However, the system will not operate in the following situations:

- When the vehicle has not been driven a certain amount after a terminal of the 12-volt battery has been disconnected and reconnected
- When the shift position is in R
- When the VSC OFF indicator is illuminated (only the pre-collision warning function will be operational)

The following are the operational speeds and cancelation conditions of each function:

- Pre-collision warning

Detectable objects	Vehicle speed	Relative speed between your vehicle and object
Preceding vehicles, stopped vehicles	Approximately 3 to 110 mph (5 to 180 km/h)	Approximately 3 to 110 mph (5 to 180 km/h)
Oncoming vehicles	Approximately 20 to 110 mph (30 to 180 km/h)	Approximately 50 to 130 mph (80 to 220 km/h)
Bicycles	Approximately 3 to 50 mph (5 to 80 km/h)	Approximately 3 to 50 mph (5 to 80 km/h)
Pedestrians	Approximately 3 to 50 mph (5 to 80 km/h)	Approximately 3 to 50 mph (5 to 80 km/h)
Preceding motorcycles, stopped motorcycles	Approximately 3 to 110 mph (5 to 180 km/h)	Approximately 3 to 50 mph (5 to 80 km/h)
Oncoming motorcycles	Approximately 20 to 110 mph (30 to 180 km/h)	Approximately 20 to 110 mph (30 to 180 km/h)

While the pre-collision warning is operating, if the steering wheel is operated heavily or suddenly, the pre-collision warning may be cancelled.

- Pre-collision brake assist

Detectable objects	Vehicle speed	Relative speed between your vehicle and object
Preceding vehicles, stopped vehicles	Approximately 20 to 110 mph (30 to 180 km/h)	Approximately 7 to 110 mph (10 to 180 km/h)
Bicycles	Approximately 20 to 50 mph (30 to 80 km/h)	Approximately 20 to 50 mph (30 to 80 km/h)
Pedestrians	Approximately 20 to 50 mph (30 to 80 km/h)	Approximately 20 to 50 mph (30 to 80 km/h)
Preceding motorcycles, stopped motorcycles	Approximately 20 to 110 mph (30 to 180 km/h)	Approximately 7 to 50 mph (10 to 80 km/h)

● Pre-collision braking

Detectable objects	Vehicle speed	Relative speed between your vehicle and object
Preceding vehicles, stopped vehicles	Approximately 3 to 110 mph (5 to 180 km/h)	Approximately 3 to 110 mph (5 to 180 km/h)
Oncoming vehicles	Approximately 20 to 110 mph (30 to 180 km/h)	Approximately 50 to 130 mph (80 to 220 km/h)
Bicycles	Approximately 3 to 50 mph (5 to 80 km/h)	Approximately 3 to 50 mph (5 to 80 km/h)
Pedestrians	Approximately 3 to 50 mph (5 to 80 km/h)	Approximately 3 to 50 mph (5 to 80 km/h)
Preceding motorcycles, stopped motorcycles	Approximately 3 to 110 mph (5 to 180 km/h)	Approximately 3 to 50 mph (5 to 80 km/h)
Oncoming motorcycles	Approximately 20 to 110 mph (30 to 180 km/h)	Approximately 20 to 110 mph (30 to 180 km/h)

If either of the following occur while the pre-collision braking function is operating, it will be canceled:

- The accelerator pedal is strongly depressed
- The steering wheel is operated heavily or suddenly

● Emergency steering assist

The emergency steering assist will not operate when the turn signal lights are flashing.

Detectable objects	Vehicle speed	Relative speed between your vehicle and object
Preceding vehicles, stopped vehicles, bicycles, pedestrians, motorcycles	Approximately 25 to 50 mph (40 to 80 km/h) Active steering function: * to 50 mph (* to 80 km/h)	Approximately 25 to 50 mph (40 to 80 km/h) Active steering function: * to 50 mph (* to 80 km/h)

\*: Minimum vehicle speed: Vehicle speed at which evasion using pre-collision brake control is difficult

While the emergency steering assist is operating, if any of the following are performed, emergency steering assist operation may be cancelled:

- The accelerator pedal is strongly depressed
  - The steering wheel is operated heavily or suddenly
  - The brake pedal is depressed
- Intersection collision avoidance support (left/right turn)

The intersection collision avoidance support (for left/right turning vehicles) will not operate when the turn signal lights are not flashing.

Detectable objects	Vehicle speed	Oncoming vehicle speed	Relative speed between your vehicle and object
Oncoming vehicles	Approximately 3 to 25 mph (5 to 40 km/h)	Approximately 3 to 45 mph (5 to 75 km/h)	Approximately 7 to 70 mph (10 to 115 km/h)
Pedestrians	Approximately 3 to 20 mph (5 to 30 km/h)	—	Approximately 3 to 25 mph (5 to 40 km/h)
Bicycles	Approximately 3 to 20 mph (5 to 30 km/h)	—	Approximately 3 to 30 mph (5 to 50 km/h)
Oncoming motorcycles	Approximately 3 to 25 mph (5 to 40 km/h)	Approximately 3 to 45 mph (5 to 75 km/h)	Approximately 7 to 70 mph (10 to 115 km/h)

- Intersection collision avoidance support (crossing vehicles)
- ▶ Vehicles without front side radars

Detectable objects	Vehicle speed	Crossing vehicle speed	Relative speed between your vehicle and object
Vehicles, Motorcycles (side)	Approximately 3 to 38 mph (5 to 60 km/h)	<ul style="list-style-type: none"> <li>• Your vehicle speed or less</li> <li>• Approximately 25 mph or less (40 km/h or less)</li> </ul>	Approximately 3 to 38 mph (5 to 60 km/h)

- ▶ Vehicles with front side radars

Detectable objects	Vehicle speed	Crossing vehicle speed	Relative speed between your vehicle and object
Vehicles, Motorcycles (side)	Approximately 3 to 38 mph (5 to 60 km/h)	Approximately 31mph or less (50 km/h or less)	Approximately 3 to 38 mph (5 to 60 km/h)

When driving at approximately 29 mph (40 km/h) or more, this system will only operate when the speed of the other vehicle is approximately 29 mph (40 km/h) or less.

The system operates only when the crossing vehicle speed is same as or less than the vehicle speed.

- Acceleration Suppression at Low Speed

The Acceleration Suppression at Low Speed function will not operate when the turn signal

lights are flashing.

Detectable objects	Vehicle speed	Relative speed between your vehicle and object
Preceding vehicles, stopped vehicles, Pedestrians, Bicycles, Wall	Approximately 0 to 9 mph (0 to 15 km/h)	Approximately 0 to 9 mph (0 to 15 km/h)

While the Acceleration Suppression at Low Speed function is operating, if any of the following are performed, the low speed sudden acceleration suppression function operation will be cancelled:

- The accelerator pedal is released.
- The steering wheel is operated heavily or suddenly

#### ■ Detection of detectable objects

Objects are detected based on their size, shape, and movement.

Depending on the ambient brightness, movement, posture and direction of a detectable object, it may not be detected and the system may not operate properly.

The system detects shapes, such as the following, as detectable objects.

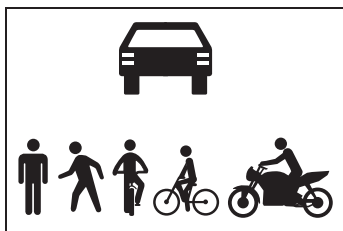

#### ■ Situations in which the system may operate even though the possibility of a collision is not high

- In certain situations, such as the following, the system may determine that the possibility of a collision is high and operate:
  - When passing a detectable object
  - When changing lanes while overtaking a detectable object
  - When suddenly approaching a detectable object
  - When approaching a detectable object or other object on the roadside, such as guardrails, utility poles, trees, walls, etc.
  - When there is a detectable object or other object by the roadside at the entrance of a curve

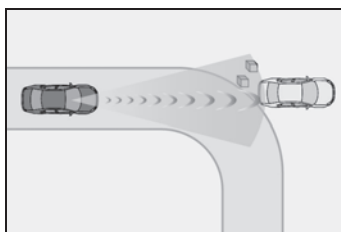

- When there are patterns or a painting ahead of the vehicle that may be mistaken for a detectable object
- When passing a detectable object that is changing lanes or turning left/right

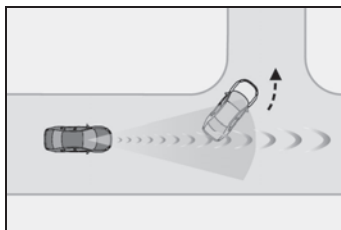

- When passing a detectable object which is stopped to make a left/right turn

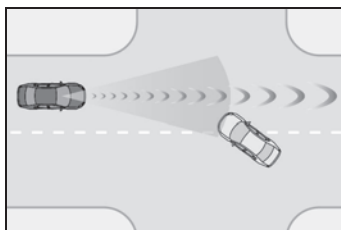

- When a detectable object stops immediately before entering the path of the vehicle

- When passing through a location with a structure above the road (traffic sign, billboard, etc.)

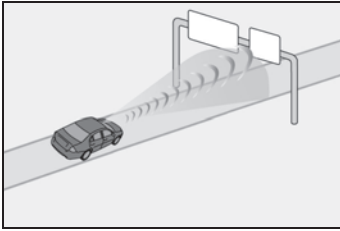

- When approaching an electric toll gate barrier, parking lot barrier, or other barrier that opens and closes
- When turning left/right and an oncoming vehicle, oncoming motorcycle, pedestrian or bicycle crosses in front of the vehicle
- When attempting to turn left/right in front of an oncoming vehicle, oncoming motorcycle, pedestrian or bicycle
- When turning left/right and an oncoming vehicle, oncoming motorcycle, pedestrian or bicycle stops or changes course immediately before entering the path of the vehicle
- When turning left/right and an oncoming vehicle turns left/right in front of the vehicle

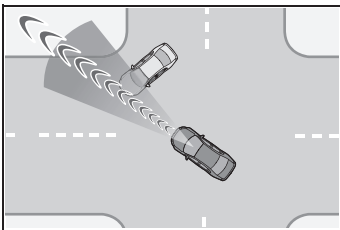

- When the steering wheel is operated toward the path of an oncoming vehicle
- When there is an object moving above or under the road

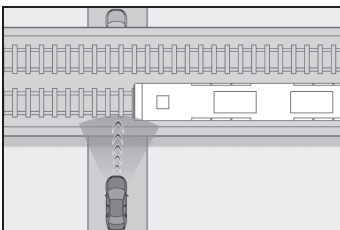

### ■ Situations in which the system may not operate properly

- In certain situations, such as the following, a detectable object may not be detected by the front sensors, and the system may not operate properly:
  - When a detectable object is approaching your vehicle
  - When your vehicle or a detectable object is wandering
  - When a detectable object makes an abrupt maneuver (such as sudden swerving, acceleration or deceleration)
  - When suddenly approaching a detectable object
  - When the detectable object is near a wall, fence, guardrail, manhole cover, steel plate on the road surface, or another vehicle
  - When there is a structure above a detectable object
  - When part of a detectable object is hidden by another object (large luggage, umbrella, guardrail, etc.)
  - When multiple detectable objects are overlapping
  - When a bright light, such as the sun, is reflecting off of a detectable object
  - When a detectable object is white and looks extremely bright
  - When the color or brightness of a detectable object causes it to blend in with its surroundings
  - When a detectable object cuts in front of or suddenly emerges in front of your vehicle
  - When approaching a vehicle which is diagonal
  - If a bicycle is a child sized bicycle, is carrying a large load, is carrying an extra passenger, is carrying a forward leaning rider, or has an unusual shape (bicycles equipped with a child seat, tandem bicycles, etc.)
  - If a pedestrian or bicycle is shorter than approximately 3.2 ft. (1 m) or taller than approximately 6.5 ft. (2 m).
  - When the silhouette of a pedestrian or bicycle is unclear (such as when they are wearing a raincoat, long skirt, etc.)
  - When a pedestrian is bending forward or squatting
  - When a pedestrian or bicycle is moving at high speed

- When a pedestrian is pushing a stroller, wheelchair, bicycle or other vehicle
- When a detectable object blends in with the surrounding area, such as when it is dim (at dawn or dusk) or dark (at night or in a tunnel)
- When the vehicle has not been driven for a certain amount of time after the hybrid system was started
- While turning left/right or a few seconds after turning left/right
- While driving around a curve and a few seconds after driving around a curve
- When turning left/right and an oncoming vehicle is driving in a lane 3 or more lanes from the vehicle
- When turning left/right and the direction of the vehicle differs greatly from the direction traffic flows in the oncoming lane

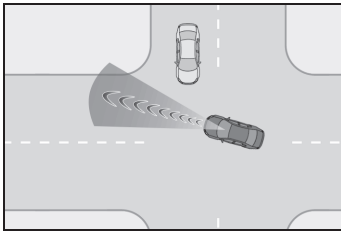

- When turning left/right, a pedestrian or bicycle behind the vehicle comes in front of it as if it overtakes the vehicle

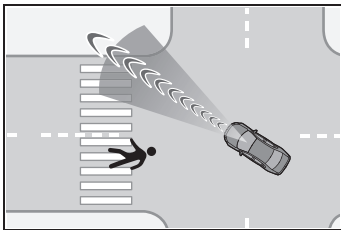

- When at an intersection, the approaching crossing vehicle is long in overall length, such as a large truck, towing trailer, etc.
- In addition to the preceding, in certain situations, such as the following, the emergency steering assist may not operate properly:
  - When a detectable object is too close to the vehicle
  - When there is insufficient space to perform evasive steering maneuvers or an

- obstruction exists in the evasion direction
- When there is an oncoming vehicle
- In addition to the preceding, in certain situations, such as the following, walls may not be detected as a target object and the Acceleration Suppression at Low Speed function may not operate properly:
  - When scenery behind the wall is visible, such as a glass door, grid fence, etc.
  - When the wall is slanted or low
  - When the wall is narrow, such as a pole, etc.
  - When the wall is made of plants, such as a hedge, etc.
  - When the road, etc. is reflected on the wall
  - When the vehicle is approaching the wall at an angle

### Changing the pre-collision setting

- The pre-collision system can be enabled/disabled through a customize setting. (→P.590)

The system is enabled each time the power switch is turned to ON.

- When the system is disabled, the PCS warning light will illuminate and a message will be displayed on the multi-information display.
- The pre-collision setting can be changed on the customize settings. (→P.590)
- Vehicles with active steering function: When the pre-collision warning timing is changed, the emergency steering assist timing will also be changed. When "Later" is selected, the emergency steering assist (excluding the active steering function) will not operate in most cases.

- Vehicles with a driver monitor camera: When the system determines that the driver is not facing forward, the pre-collision warning and emergency steering assist will operate at the “Earlier” timing, regardless of the user setting.
- When the dynamic radar cruise control is operating, the pre-collision warning will operate at the “Earlier” timing, regardless of the user setting.
- Vehicles with Traffic Jam Assist: When the Traffic Jam Assist is operating, the pre-collision warning will operate at the “Earlier” timing, regardless of the user setting.

## LTA (Lane Tracing Assist)

### LTA functions

- When driving on a road with clear lane lines with the dynamic radar cruise control operating, lane lines and preceding and surrounding vehicles are detected using the front camera and radar sensor, and the steering wheel is operated to maintain the vehicle’s lane position.

Use this function only on highways and expressways.

If the dynamic radar cruise control is not operating, the function will not operate.

In situations where the lane lines are difficult to see or are not visible, such as when in a traffic jam, support will be provided using the path of preceding and surrounding vehicles.

If the system determines that the steering wheel has not been operated for a certain amount of time or the steering wheel is not being firmly gripped, the driver will be alerted and this function will be temporarily canceled.

If the steering wheel is firmly gripped, the function will begin operating again.

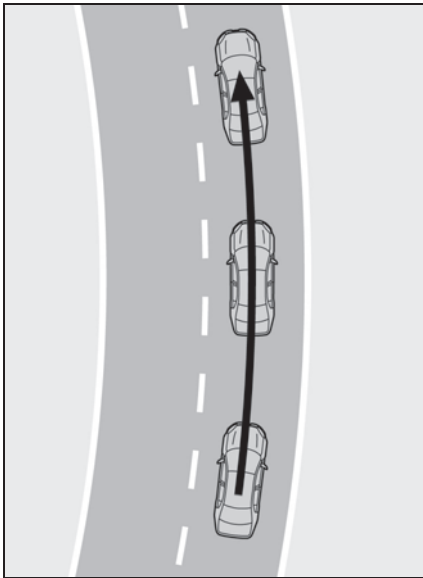

- When the function is operating, if the vehicle is likely to depart from its lane, the driver will be alerted via a display and buzzer.

When the buzzer sounds, check the area around the vehicle and carefully operate the steering wheel to move the vehicle back to the center of the lane.

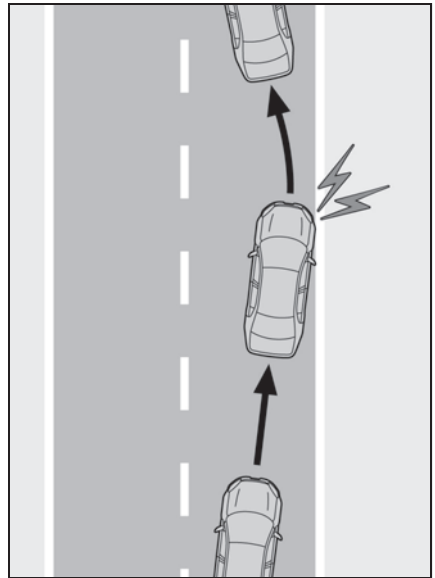

#### WARNING

##### ■ Before using the LTA system

- Do not overly rely on the LTA system. The LTA system is not a system which provides automated assistance in driving and it is not a system which reduces the amount of attention necessary for safe driving. The driver is solely responsible for paying attention to their surroundings and operating the steering wheel as necessary to ensure safety. Also, the driver is responsible for taking adequate breaks when fatigued, such as when driving for a long time.
- Failure to perform appropriate driving operations and pay careful attention may lead to an accident.
- When not using the LTA system, turn it off using the LTA switch.

##### ■ Operating conditions of function

This function is operable when all of the following conditions are met:

- The LTA system detects lane lines or the path of preceding or surrounding vehi-

cles.

- The dynamic radar cruise control is operating.
- The lane width is approximately 10 to 13 ft. (3 to 4 m).
- The turn signal lever is not being operated.
- The vehicle is not being driven around a sharp curve.
- The vehicle is not accelerating or decelerating more than a certain amount.
- The steering wheel is not being turned with a large force.
- The hands off steering wheel warning (→P.273) is not operating.
- The vehicle is being driven in the center of a lane.

#### ■ Temporary cancelation of functions

- When the operating conditions are no longer met, a function may be temporarily canceled. However, when the operation conditions are met again, operation of the function will automatically be restored. (→P.272)
- If the operating conditions of a function are no longer met while the function is operating, a buzzer may sound to indicate that the function has been temporarily canceled.
- The steering assist operation of the function can be overridden by the steering wheel operation of the driver.

#### ■ Lane departure warning function when the LTA is operating

- Even if the LDA warning method is changed to vibration of the steering wheel, if the vehicle deviates from the lane while the LTA is operating, the warning buzzer will sound to alert the driver.
- If steering wheel operation equivalent to that necessary for a lane change is detected, the system will determine the vehicle is not deviating from the lane and the warning will not operate.

#### ■ Hands off steering wheel warning operation

- When the system determines the driver is

not holding the steering wheel, a message urging the driver to grip the steering wheel and the icon shown in the illustration will be displayed on the multi-information display to warn the driver. If the system detects that the steering wheel is held, the warning will be canceled. When using the system, make sure to grip the steering wheel firmly, regardless of whether the warning is operating or not.

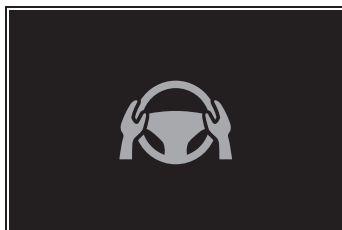

- If no operations are detected for a certain amount of time, the warning will operate and the function will be temporarily canceled. This warning may also operate if the driver only operates steering wheel a small amount continuously.
- Situations in which the hands off steering wheel warning may not operate properly
  - Depending on the condition of the vehicle, handle control condition and road surface, the warning function may not operate.
  - Vehicles with LCA: In the following situations, the system may not be able to detect when the driver's hands are off the steering wheel.
    - When a steering wheel cover is installed
    - When the driver is wearing gloves
    - When foreign matter is attached to the steering wheel
    - When the driver is gripping the wood trim, seam of the leather, spokes, or other part of the steering wheel that does not have sensors
  - Vehicles with LCA: In the following situations, the hands off steering wheel warning may not operate and the LTA function may continue operating even though the driver's hands are off the steering wheel:
    - When something other than a hand is contacting the steering wheel
    - When a wide object or arms are held

across the steering wheel

### Enabling/disabling the system

The LTA will change between ON/OFF each time the LTA switch is pressed.

When the LTA is ON, the LTA indicator will illuminate.

► Vehicles without a head-up display

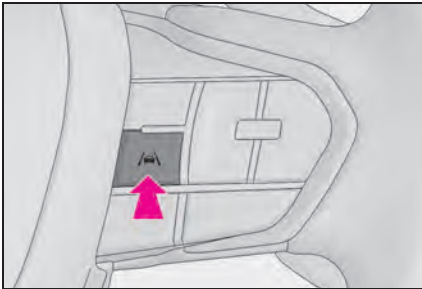

► Vehicles with a head-up display

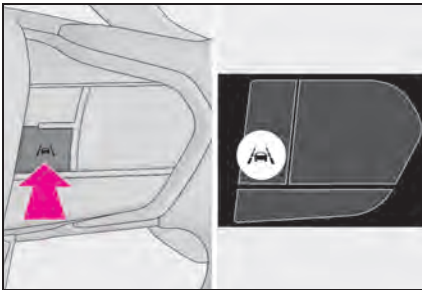

### ⚠ WARNING

#### ■ Situations in which the functions may not operate properly

In the following situations, the functions may not operate properly and the vehicle may depart from its lane. Do not overly rely on these functions. The driver is solely responsible for paying attention to their surroundings and operating the steering wheel as necessary to ensure safety.



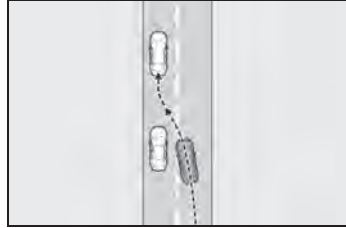





- When a preceding or surrounding vehicle changes lanes (Your vehicle may follow the preceding or surrounding vehicle and also change lanes)



- When a preceding or surrounding vehicle is swaying (Your vehicle may sway accordingly and depart from the lane)
- When a preceding or surrounding vehicle departs from a lane (Your vehicle may follow the preceding or surrounding vehicle and also depart from the lane)
- When a preceding or surrounding vehicle is being driven extremely close to the left/right lane line (Your vehicle may follow the preceding or surrounding vehicle accordingly and depart from the lane)
- When there are moving objects or structures in the surrounding area (Depending on the position of the moving object or structure relative to your vehicle, your vehicle may sway)
- When the vehicle is struck by a cross-wind or the turbulence of other nearby vehicles
- Situations in which the sensors may not operate properly: →P.257
- Situations in which the lane may not be detected: →P.258
- When it is necessary to disable the system: →P.252

## Operation display of steering wheel operation support

The operating state of the LTA system is indicated.

Indicator	Lane display	Steering icon	Situation
 White	 Grey/White	 Grey	LTA is on standby
 Green	 Green	 Green	LTA is operating
 Orange Flashing	 Orange Flashing	 Green	The vehicle is departing the lane toward the side which the lane display is flashing

## LCA (Lane Change Assist)\*

\*: If equipped

### LCA functions

This function is linked to the LTA and provides assistance in performing lane changes through steering wheel operations.

Use the this function only on highways and expressways.

The steering assist operation can be overridden by the steering wheel operation of the driver.

The lane change assist function is not designed to operate when changing lanes at a junction.

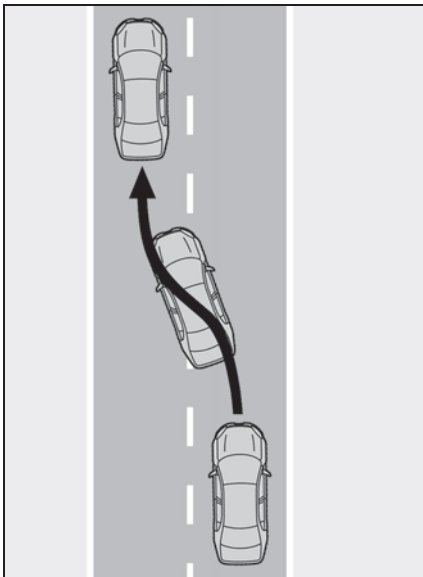

## ⚠ WARNING

### ■ Before using the LCA system

- Do not overly rely on the LCA system.

The LCA system is not a system which provides automated assistance in driving and it is not a system which reduces the need for checking an adjacent lane for other vehicles, approaching vehicles, etc. when changing lanes. The driver is solely responsible for paying attention to their surroundings and operating the steering wheel as necessary to ensure safety.

Also, do not use the LCA to change lanes into which a lane change should not be performed (oncoming lanes, road shoulders, etc.).

- Failure to perform appropriate driving operations and pay careful attention may lead to an accident.

### ■ Operating conditions of function

This function is operable when all of the following conditions are met:

- The LTA is operating.
- The lane change assist function is enabled by a customize setting.
- The vehicle speed is between approximately 55 and 85 mph (90 and 140 km/h).
- The system detects a broken white line on the side which the lane change is to be performed.
- A vehicle is not detected in the lane toward which the turn signal is operated.
- The steering wheel is not being turned with a large force.
- The hands off steering wheel warning (→P.273) is not operating.

### ■ Cancellation of functions

In the following situations, operation of the LCA may be canceled with the display and buzzer:

- When the operating conditions (→P.276) are no longer met
- When the system can no longer detect lane lines
- When the turn signal lever is operated to the second position (→P.277)
- When the turn signal lever is operated in the opposite direction of the lane change
- When the system detects operation of the steering wheel, brake pedal or accelerator pedal by the driver.

If the system detects that a vehicle is quickly approaching in the lane toward which the turn signal is operated a buzzer will sound and a message will be displayed to alert the driver. At the same time the steering wheel may be slightly operated to help keep the vehicle away from the approaching vehicle.

#### ■ Hands off steering wheel warning operation

When the system determines the driver is not holding the steering wheel, a message urging the driver to grip the steering wheel and the icon shown in the illustration will be displayed on the multi-information display to warn the driver. If the system detects that the steering wheel is held, the warning will be canceled. When using the system, make sure to grip the steering wheel firmly, regardless of whether the warning is operating or not.

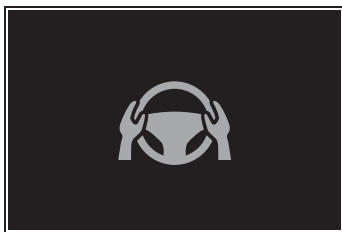

#### ■ Situations in which the hands off steering wheel warning may not operate properly

- Depending on the condition of the vehicle, handle control condition and road surface, the warning function may not operate.
- In the following situations, the system may not be able to detect when the driver's hands are off the steering wheel.

- When a steering wheel cover is installed
- When the driver is wearing gloves
- When foreign matter is attached to the steering wheel
- When the driver is gripping the wood trim, seam of the leather, spokes, or other part of the steering wheel that does not have sensors
- In the following situations, the hands off steering wheel warning may not operate and the LCA function may continue operating even though the driver's hands are off the steering wheel:
  - When something other than a hand is contacting the steering wheel
  - When a wide object or arms are held across the steering wheel

### Operating the LCA

If the turn signal lever is held in the first position, the lane change direction will be displayed and the function will operate.

To change lanes by holding the turn signal lever in the first position without using the LCA, turn the customize setting of the LCA off.

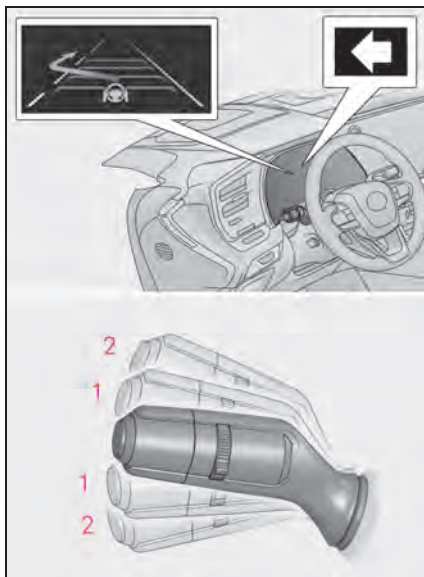

- 1 First position: LCA is operational
- 2 Second position: LCA is not operational

### WARNING

- Situations in which the LCA should not be used
- When driving on a one lane road





- When there is no broken white line between the current lane and the lane to be changed to

### Enabling/disabling the system

LCA can be enabled/disabled through a customize setting. (→P.590)

## Displays and system operation

The operating state of the LCA system is indicated.

LCA display	Steering icon	Condition
 Blue arrow and white line	 Green	LCA is operating
	 Grey	Approaching vehicle detected while LCA is operating
Not displayed	 Grey	Lane line no longer detected while LCA is operating

## LDA (Lane Departure Alert)

### Basic functions

The LDA system warns the driver if the vehicle may deviate from the current lane or course<sup>\*</sup>, and also can slightly operate the steering wheel to help avoid deviation from the lane or course<sup>\*</sup>.

The front camera is used to detect lane lines or a course<sup>\*</sup>.

\*: Boundary between the asphalt and grass, soil, etc., or structures, such as a curb, guardrail, etc.

#### ■ Lane departure alert function

When the system determines that the vehicle might depart from its lane or course<sup>\*</sup>, a warning is displayed on a display, and either a warning buzzer will sound or the steering wheel will vibrate to alert the driver.

Check the area around your vehicle and carefully operate the steering wheel to move the vehicle back to the center of the lane or course<sup>\*</sup>.

If the system determines that the vehicle may collide with a vehicle in an adjacent lane, the lane departure alert will operate even if the turn signals are operating.

\*: Boundary between the asphalt and grass, soil, etc., or structures, such as a curb, guardrail, etc.

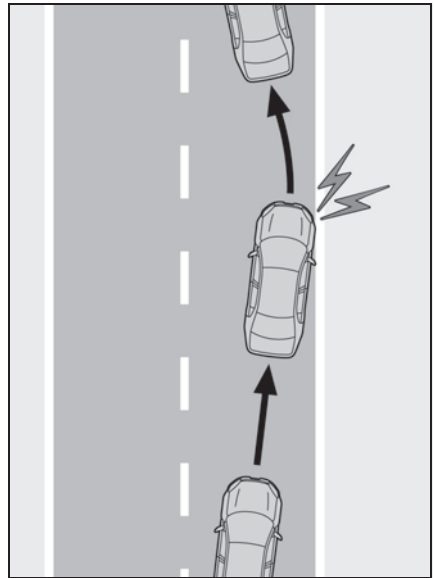

#### ■ Lane departure prevention function

If the system determines that the vehicle is likely to depart from its lane or course<sup>\*</sup>, it provides assistance through steering wheel operations to help avoid deviation from the lane or course<sup>\*</sup>.

If the system determines that the steering wheel has not been operated for a certain amount of time or the steering wheel is not being firmly gripped, a warning message may be displayed and a warning buzzer may sound to alert the driver.

If the system determines that the vehicle may collide with a vehicle in an adjacent lane, the lane departure prevention function will operate even if the turn signals are operating.

\*: Boundary between the asphalt and grass, soil, etc., or structures, such as a curb, guardrail, etc.

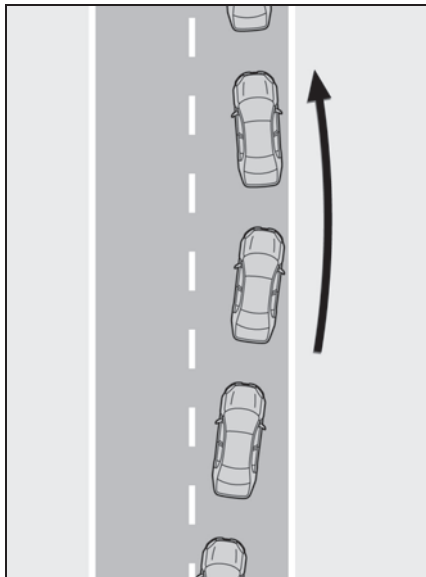

### ■ Break suggestion function

If the vehicle is swaying, a message will be displayed and a buzzer will sound to urge the driver to take a break.

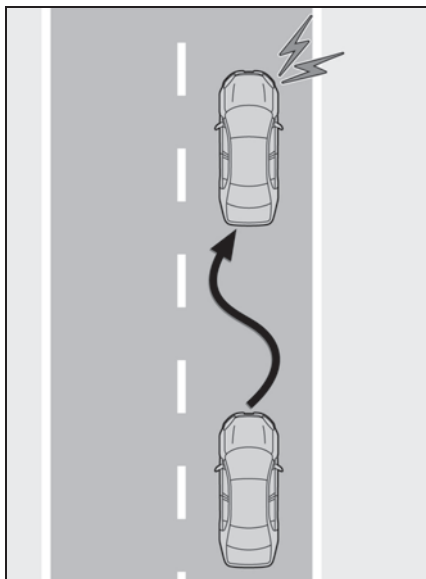

### ⚠ WARNING

#### ■ Before using the LDA system

- Do not overly rely on the LDA system. The LDA system is a system which provides automated assistance in driving. However, as it is not a system which reduces the amount of attention necessary for safe driving. The driver is solely responsible for paying attention to their surroundings and operating the steering wheel as necessary to ensure safety. Also, the driver is responsible for taking adequate breaks when fatigued, such as when driving for a long time.
- Failure to perform appropriate driving operations and pay careful attention may lead to an accident.

#### ■ Operating conditions of each function

##### ● Lane departure alert/prevention function

This function is operable when all of the following conditions are met:

- The vehicle speed is approximately 30 mph (50 km/h) or more.

Operation may be possible when the vehicle speed is approximately 25 mph (40 km/h) or more if vehicles, motorcycles, bicycles, or pedestrians are detected near the lane.

- The system recognizes a lane or course\* . (When recognized on only one side, the system will operate only for the recognized side.)
- The lane width is approximately 9.8 ft. (3 m) or more.
- The turn signal lever is not being operated.

(Except when a vehicle is detected in the direction that the turn signal lever is operated.)

- The vehicle is not being driven around a sharp curve.
- The vehicle is not accelerating or decelerating more than a certain amount.
- The steering wheel is not being turned sufficiently to perform a lane change.

- When the VSC or TRAC system is not turned off.

\* : Boundary between the asphalt and grass, soil, etc., or structures, such as a curb, guardrail, etc.

#### ■ Temporary cancellation of functions

When the operating conditions are no longer met, a function may be temporarily canceled. However, when the operation conditions are met again, operation of the function will automatically be restored. (→P.280)

#### ■ Operation of the lane departure alert function/lane departure prevention function

- Depending on the vehicle speed, road conditions, lane departure angle, etc., operation of the lane departure prevention function may not be felt or the function may not operate.
  - Depending on the conditions, the warning buzzer may operate even if vibration is selected through a customize setting.
  - If a course\* is not clear or straight, the lane departure alert function or lane departure prevention function may not operate.
  - The lane departure alert function or lane departure prevention function may not operate if the system judges that the vehicle is intentionally being steered to avoid a pedestrian or parked vehicle.
  - It may not be possible for the system to judge if there is danger of a collision with a vehicle in an adjacent lane.
  - Vehicles with a driver monitor camera: Depending on the driver condition, the lane departure alert function or lane departure prevention function changes the timing of operation.
  - The steering assist operation of the lane departure prevention function can be overridden by the steering wheel operation of the driver.
- \* : Boundary between the asphalt and grass, soil, etc., or structures, such as a curb, guardrail, etc.

#### ■ Hands off steering wheel warning operation

In the following situations, a message urging the driver to operate the steering wheel and an icon will be displayed and a buzzer will sound to warn the driver. When using the system, make sure to grip the steering wheel firmly, regardless of whether the warning is operating or not.

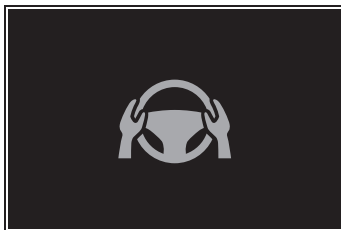

- When the system determines that the driver is not securely holding the steering wheel, or the steering wheel is not being operated when the steering assist operation of the lane departure prevention function is operating

Except for Puerto Rico: The length of time that the warning buzzer operates will become longer as the frequency of the steering assist operating increases. If the system judges that the steering wheel has been operated, the warning buzzer will stop.

For Puerto Rico: The length of time that the warning buzzer operates will become longer as the frequency of the steering assist operating increases. Even if the system judges that the steering wheel has been operated, the warning buzzer will sound for a certain amount of time.

#### ■ Break suggestion function

This function is operable when all of the following conditions are met:

- The vehicle speed is approximately 40 mph (65 km/h) or more.\*<sup>1</sup>
- The vehicle speed is approximately 32 mph (50 km/h) or more.\*<sup>2</sup>
- The lane width is approximately 9.8 ft. (3 m) or more.

Depending on the condition of the vehicle and road surface, the break suggestion function may not operate.



Vehicles without a head-up display: Press the  meter control switch to turn off the message.<sup>\*1</sup>

Vehicles with a head-up display: Press the  steering switch to turn off the message.<sup>\*1</sup>

Unless  or  is pressed, the message of the break suggestion function will remain displayed.<sup>\*1</sup>

<sup>\*1</sup>: For Puerto Rico <sup>\*3</sup>

<sup>\*2</sup>: Except for Puerto Rico <sup>\*3</sup>

<sup>\*3</sup>: The countries and areas for each region listed in the table are current as of October 2022. However, depending on when the vehicle was sold, the countries and areas of each region may be different. Contact your Lexus dealer for details.

## Changing LDA settings

- The LDA system can be

enabled/disabled through a customize setting. (→P.590)

- The settings of the LDA can be changed on the customize settings. (→P.590)

## WARNING

### ■ Situations in which the system may not operate properly













In the following situations, the system may not operate properly and the vehicle may depart from its lane. Do not overly rely on these functions. The driver is solely responsible for paying attention to their surroundings and operating the steering wheel as necessary to ensure safety.

- When the boundary between the asphalt and grass, soil, etc., or structures, such as a curb, guardrail, etc. is not clear or straight
- When the vehicle is struck by a crosswind or the turbulence of other nearby vehicles
- Situations in which the lane may not be detected: →P.258
- Situations in which the sensors may not operate properly: →P.257
- Situations in which some or all of the functions of the system cannot operate: →P.258
- When it is necessary to disable the system: →P.252



## Displays and system operation









The operating state of the lane departure alert function and steering assist operation of the lane departure prevention function are indicated.

## ► Except for Puerto Rico

Indicator	Lane display	Steering icon	Situation
Not illuminated	Not illuminated	Not illuminated	System disabled
 White	 Grey	Not illuminated	Lane lines are not detected by the system
 White	 White	Not illuminated	Lane lines are detected by the system
 Orange Flashing	 Orange Flashing	Not illuminated	Lane departure alert function is operating for the side which the lane display is flashing
 Green	 Green	 Green	Lane departure prevention function is operating for the side which the lane display is illuminated
 Orange Flashing	 Orange Flashing	 Green	Lane departure alert function/lane departure prevention function is operating for the side which the lane display is flashing

## ► For Puerto Rico

Indicator	Lane display	Steering icon	Situation
 Orange Illuminated	Not illuminated	Not illuminated	System disabled
Not illuminated	 Grey	Not illuminated	Lane lines are not detected by the system
Not illuminated	 White	Not illuminated	Lane lines are detected by the system

Indicator	Lane display	Steering icon	Situation
 Orange Flashing	 Orange Flashing	Not illuminated	Lane departure alert function is operating for the side which the lane display is flashing
 Green	 Green	 Green	Lane departure prevention function is operating for the side which the lane display is illuminated
 Orange Flashing	 Orange Flashing	 Green	Lane departure alert function/lane departure prevention function is operating for the side which the lane display is flashing

## PDA (Proactive driving assist)

When a detectable object (→P.285) is detected, the proactive driving assist operates the brakes and steering wheel to help prevent the vehicle from approaching too close to the object.



### WARNING

#### ■ For safe use

Driving safely is solely the responsibility of the driver.

- The proactive driving assist is designed to provide some assistance for regular braking and steering operations, as well as helping to prevent the vehicle from approaching too close to a detectable object. However, the scope of this assistance is limited.

The driver should perform brake and steering operations as necessary. Read the following items carefully. Do not overly rely on the proactive driving assist and always drive carefully. (→P.287)

- The proactive driving assist is not a system which reduces the amount of attention necessary for safe driving. Even if the system is operating correctly, the surrounding conditions as recognized by the driver and detected by the system may differ. It is necessary for the driver to pay attention, assess risks, and ensure safety. Over-reliance on this system to drive the vehicle safely may lead to an accident resulting in death or serious injury.

- Proactive driving assist is not a system which allows for inattentive driving and is not a system which assists in poor visibility conditions. The driver is solely responsible for paying attention to their surroundings and driving safely.

#### ■ When turning proactive driving assist off

- Situations in which the sensors may not operate properly: →P.257
- When it is necessary to disable the system: →P.252

## System operating conditions and detectable objects

According to the driving conditions, the operation and detectable objects of the proactive driving assist will change as follows.

Function	Conditions	Operation	Detectable objects
Obstacle Anticipation Assist	A detectable object is detected crossing the road	Assistance with some brake operations is provided in order to reduce the possibility of a collision.	<ul style="list-style-type: none"> <li>• Pedestrians</li> <li>• Bicyclists</li> </ul>
	A detectable object is detected on the side of the road	<p>Assistance with some brake and steering wheel operations are provided according to the surrounding conditions to help prevent the vehicle from approaching too close to a detected object.</p> <p>Assistance with steering wheel operations is provided within a range that the vehicle will not deviate from its current lane.</p>	<ul style="list-style-type: none"> <li>• Pedestrians</li> <li>• Bicyclists</li> <li>• Parked vehicles</li> </ul>
Deceleration Assist	A preceding vehicle or an adjacent vehicle cutting in front of the vehicle is detected	The vehicle is gently decelerated so that the vehicle-to-vehicle distance will not be excessively short.	<ul style="list-style-type: none"> <li>• Preceding vehicles</li> <li>• Motorcycles</li> </ul>
	A curve is detected ahead of the vehicle	The vehicle is gently decelerated if the vehicle speed is determined to be too high for the curve ahead.	None
Steering Assist	Lane is detected	The system anticipates the driver's operation and supports the operation of the steering wheel.	None

■ **Vehicle speeds at which the system can operate**

- Detectable object crossing the road assistance

Approximately 20 to 35 mph (30 to 60

km/h)

- Detectable object on the side of the road assistance

Approximately 20 to 35 mph (30 to 60 km/h)

- Preceding vehicle deceleration assist-

tance

Approximately 15 mph (20 km/h) or more

● Curve deceleration assistance

Approximately 15 mph (20 km/h) or more

● Steering assist within a lane

Approximately 5 to 80 mph (10 to 140 km/h)

■ **System operation will be canceled when**

● In the following situations, system operation will be canceled:

- When the dynamic radar cruise control or cruise control is operating
- When the PCS is off
- Situations in which some or all of the functions of the system cannot operate: →P.258
- When the P, R or N shift position is selected

● In the following situations, the brake operation assist will be canceled:

- Approximately 9 mph (15 km/h) or less
- When a certain vehicle speed has been reached, as judged by the system, according to the surrounding conditions

● In the following situations, system operation may be canceled:

- When the brake control or output restriction control of a driving support system operates

(For example: PCS, drive-start control)

- When the system determines that a detected object has moved away from the vehicle
- When lane lines can no longer be detected
- When the brake pedal has been depressed
- When the accelerator pedal has been depressed
- When the steering wheel has been operated with more than a certain amount of force
- When the turn signal lever is operated to the left/right turn position



**WARNING**

■ **Situations in which the system may not operate properly**

- Situations in which the lane may not be detected: →P.258
- When a detectable object stops immediately before entering the path of the vehicle
- When passing extremely close to a detectable object behind a guardrail, fence, etc.
- When changing lanes while overtaking a detectable object
- When passing a detectable object that is changing lanes or turning left/right
- When there are objects (guardrails, power poles, trees, walls, fences, poles, traffic cones, mailboxes, etc.) in the surrounding area
- When there are patterns or a painting ahead of the vehicle that may be mistaken for a detectable object
- When passing through a place with a low structure above the road (tunnel with a low ceiling, traffic sign, sign-board, etc.)
- When driving on snowy, icy, or rutted roads
- When a detectable object is approaching your vehicle
- When your vehicle or a detectable object is wandering
- When the movement of a detectable object changes (change in direction, sudden acceleration or deceleration, etc.)
- When suddenly approaching a detectable object
- When a preceding vehicle or motorcycle is not directly in front of your vehicle

**WARNING**

- When there is a structure above a detectable object
- When part of a detectable object is hidden by another object (large luggage, umbrella, guardrail, etc.)
- When multiple detectable objects are overlapping
- When a bright light, such as the sun or headlights of another vehicle, is reflecting off of the detectable object
- When the detectable object is white and looks extremely bright
- When the color or brightness of the detectable object causes it to blend in with its surroundings
- When a detectable object cuts in front of or emerges from beside a vehicle
- When approaching a vehicle ahead which is perpendicular or at an angle to the vehicle, or is facing the vehicle
- If a parked vehicle is perpendicular or at an angle to the vehicle
- When a bicycle is a child sized bicycle, is carrying a large load, is carrying an extra passenger, or has an unusual shape (bicycles equipped with a child seat, tandem bicycles, etc.)
- When a pedestrian or bicyclist is shorter than approximately 3.2 ft. (1 m) or taller than approximately 6.5 ft. (2 m)
- When the silhouette of a pedestrian or bicyclist is unclear (such as when they are wearing a raincoat, long skirt, etc.)
- When a pedestrian or bicyclist is bending forward or squatting
- When a pedestrian or bicyclist is moving at high speed

- When a pedestrian is pushing a stroller, wheelchair, bicycle or other vehicle
- When a detectable object blends in with the surrounding area, such as when it is dim (at dawn or dusk) or dark (at night, in a tunnel, etc.)
- When the lane width is 13.1 ft. (4 m) or more
- When the lane width is 8.2 ft. (2.5 m) m or less
- When the vehicle has not been driven for a certain amount of time after the hybrid system was started
- While turning left or right or a few seconds after turning left or right
- While changing lanes or a few seconds after changing lanes
- When entering a curve, driving around a curve and a few seconds after driving around a curve







### Changing proactive driving assist settings

- The proactive driving assist can be enabled/disabled through a customize setting. (→P.590)
- The following settings of the proactive driving assist can be changed through customize settings. (→P.590)

## System operation display

Depending on the situation, the following indicators or icons will be displayed.

Some icons cannot be displayed unless the display is changed to the driving safety support function information screen.

Icon	Meaning
	<ul style="list-style-type: none"> <li>• White: Monitoring for detectable objects</li> <li>• Green: Detectable object crossing the road or detectable object on the side of the road assistance operating</li> </ul>
	A pedestrian has been detected as crossing the road or on the side of the road and brake or steering assistance is operating
	A vehicle has been detected on the side of the road and brake or steering operation assistance is being performed
	<ul style="list-style-type: none"> <li>• Steering operation assistance is being performed to prevent the vehicle from approaching too close to a detectable object on the side of the road</li> <li>• When the steering assist is operating</li> </ul>
	Preceding vehicle deceleration assistance is being performed
	Warning to maintain appropriate vehicle-to-vehicle distance
	Curve deceleration assistance is being performed

### ■ Hands off steering wheel warning operation

In the following situations, a message urging the driver to grip the steering wheel and the icon shown in the illustration will be displayed on the display to warn the driver. If the system detects that the steering wheel is held, the warning will be canceled. When using the system, make sure to grip the steering wheel firmly, regardless of whether

the warning is operating or not.

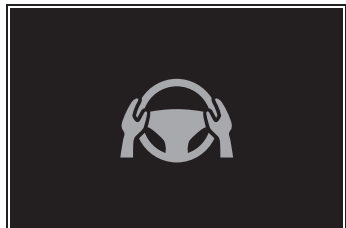

- When assistance to a detectable object

crossing the road or assistance to a detectable object on the side of the road is performed and the system determines the driver is not holding the steering wheel

If no operations are detected for a certain amount of time, a buzzer will sound, the warning will operate. This warning may also operate if the driver only operates steering wheel a small amount continuously.

■ **Warning operation after preceding vehicle deceleration assistance has ended**

After preceding vehicle deceleration assistance has ended, if the driver does not operate the brake pedal or accelerator pedal and the vehicle approaches the preceding vehicle, the display will flash and a buzzer will sound to urge the driver to decelerate. If the system determines that the driver is operating the brake pedal or accelerator pedal, the warning will be canceled.



## FCTA (Front Cross Traffic Alert)\*

\*: If equipped

**When approaching an intersection, etc., at a low speed, vehicles approaching from the left and right of the front of the vehicle can be detected and the driver informed of these vehicles.**

## FCTA system control

- When the system detects a vehicle approaching from the left or right in front of your vehicle when approaching an intersection, a notification will be displayed.
- Head-up display

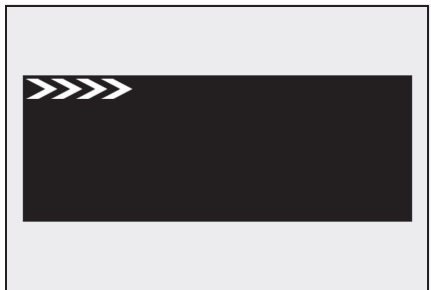

- When the system determines that your vehicle may be about to enter an intersection even though a vehicle is approaching from the left or right in front of your vehicle, a buzzer will sound and a message will be displayed to urge you to depress the brake pedal.
- Multi-information display

**WARNING****■ For safe use**

Driving safely is solely the responsibility of the driver. Pay careful attention to the surrounding conditions in order to ensure safe driving.

The FCTA system is a supplementary system that informs the driver of vehicles approaching from the left and right of the front of the vehicle.

Over-reliance on this system may lead to an accident resulting in death or serious injury.

The details of the warning display may differ from the actual traffic conditions.

Although the warning display will stop being displayed after a certain amount of time, this does not necessarily indicate that there are no longer any vehicles or pedestrians around your vehicle.

**■ FCTA system operating conditions**

The system will operate when all of the following conditions are met:

- A shift position other than P or R is selected
- The vehicle speed is approximately 10 mph (15 km/h) or less
- A vehicle is approaching from the left or right in front of your vehicle at a speed between approximately 7 to 37 mph (10 to 60 km/h)
- There are no vehicles in front of your vehicle

- The accelerator pedal is not being strongly depressed
- The brake pedal is not being strongly depressed

**■ Situations in which the system may operate even though no vehicles are approaching**

In certain situations, such as the following, the system may operate even though no vehicles are approaching:

- When approaching objects on the roadside, such as guardrails, traffic signs, utility poles, street lights, trees, tall grass, walls, etc.
- When passing an object on the side of the road, such as a parked vehicle
- When a vehicle or pedestrian is approaching from the left or right in front of your vehicle in the distance
- When a vehicle or pedestrian is moving within a parking spot, etc., next to the lane your vehicle is in
- When a pedestrian or bicyclist is approaching on a sidewalk
- When a vehicle or pedestrian is moving away from your vehicle
- When an approaching vehicle is decelerating or stops
- When an approaching vehicle makes a left/right turn immediately in front of your vehicle
- When a pedestrian is approaching your vehicle
- When an oncoming vehicle makes a right/left turn
- When your vehicle enters an intersection before a vehicle approaching from the left or right in front of your vehicle
- When stopped at traffic light and a vehicle approaches from the left or right in front of your vehicle
- When making a left/right turn in front of an approaching vehicle

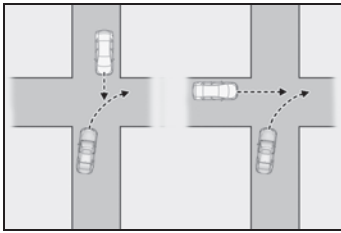

- When an oncoming vehicle approaches and passes
- When being overtaken by another vehicle
- When driving next to another vehicle or a pedestrian
- When a vehicle or pedestrian approaches the side of your vehicle

#### ■ Situations in which the system may not operate properly

In situations such as the following, a vehicle may not be detected by a front side radar sensor and the system may not operate properly:

- If an approaching vehicle moves suddenly (sudden steering, acceleration, deceleration, etc.)

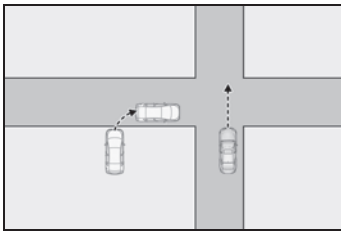

- If a vehicle is approaching from the left or right of the front of your vehicle diagonally
- When a vehicle is approaching from the left or right in front of your vehicle in the distance
- When there is an object between your vehicle and an approaching vehicle
- When several vehicles are approaching with little space between them
- Situations in which the sensors may not operate properly: →P.257
- Situations in which some or all of the functions of the system cannot operate:

→P.258

### Changing FCTA settings

- The FCTA can be enabled/disabled through a customize setting. (→P.590)
- The following settings of the FCTA can be changed through customize settings. (→P.590)

## RSA (Road Sign Assist)\*

\*: If equipped

The RSA system detects specific road signs using the front camera and/or navigation system (when speed limit information is available) and warns the driver via displays and buzzers.



### WARNING

#### ■ For safe use

- Driving safely is solely the responsibility of the driver. Pay careful attention to the surrounding conditions in order to ensure safe driving.
- Do not rely solely upon the RSA. The RSA assists the driver by providing road sign information, but it is not a replacement for the driver's own vision and awareness. Driving safely is solely the responsibility of the driver. Pay careful attention to the surrounding conditions in order to ensure safe driving.

#### ■ Situations in which the RSA should not be used

- When it is necessary to disable the system: →P.252

#### ■ Situations in which the system may not operate properly

- Situations in which the sensors may not operate properly: →P.257

## Display Function

- When the front camera detects a sign or information of a sign is available from the navigation system, the sign will be displayed on the display.
- Multiple signs can be displayed.

Depending on the specifications of the vehicle, the number of displayed signs may be limited.

#### ■ Operating conditions of sign display

Signs will be displayed when the following conditions are met:

- The system has detected a sign

In the following situations, a displayed sign may stop being displayed:

- When a new sign has not been detected for a certain distance
- When the system determines that the road being driven on has changed, such as after a left or right turn

#### ■ Situations in which the display function may not operate properly

In the following situations, the RSA system may not operate properly and may not detect signs or may display the incorrect sign. However, this does not indicate a malfunction.

- When a sign is dirty, faded, tilted or bent
- When the contrast of an electronic sign is low
- When all or part of a sign is hidden by a tree, utility pole, etc.
- When a sign is detected by the front camera for a short amount of time
- When the driving state (turning, changing lanes, etc.) is judged incorrectly
- When a sign is immediately after a free-way junction or in an adjacent lane just before merging
- When stickers are attached to the rear of a preceding vehicle
- When a sign similar to a system compatible sign is detected as a system compatible sign
- When a speed limit sign for a frontage road is within detection range of the front camera
- When driving around a roundabout
- When a sign intended for trucks, etc. is detected

- When the navigation system map data is out of date
- When the navigation system cannot be used

In this case, the speed limit signs displayed on the multi-information display and navigation system display may differ.

### Notification function

In the following situations, the RSA system will output a warning to notify the driver.

- If the vehicle speed exceeds the speed warning threshold of the speed limit sign displayed on the display, the sign display will be emphasized and a buzzer will sound.
- When the RSA system detects a do not enter sign and determines that the vehicle has entered a no-entry area, the do not enter sign displayed on the display will flash and a buzzer will sound.

### ■ Operating conditions of the notification functions

- Excess speed notification function

This function will operate when the following condition is met:

- A speed limit road sign is recognized by the system.

- No entry notification function

This function will operate when all of the following conditions are met:

- More than one no entry road signs are recognized by the system simultaneously.
- The vehicle is passing between no entry road signs recognized by the system.

### Types of road signs supported

- The following types of road signs can be displayed.

However, non-standard or recently introduced traffic signs may not be displayed.

	Speed limit
	
	Do Not Enter
	No U-turn
	No Turn On Red
	Stop
	Yield
	Warning

### Changing RSA settings

The following settings of the RSA can be changed through customize settings. (→P.590)

## Dynamic radar cruise control

This dynamic radar cruise control detects the presence of vehicles ahead, determines the current vehicle-to-vehicle distance, and operates to maintain a suitable distance from the vehicle ahead. The desired vehicle-to-vehicle distance can be set by operating the vehicle-to-vehicle distance switch.

Use the dynamic radar cruise control only on highways and expressways.



### WARNING

#### ■ For safe use

- Driving safely is solely the responsibility of the driver. Do not overly rely on this system, and pay careful attention to the surrounding conditions in order to ensure safe driving.
- The dynamic radar cruise control provides driving assistance to reduce the driver's burden. However, there are limitations to the assistance provided.

Read the following items carefully. Do not overly rely on this system and always drive carefully.

- Conditions under which the system may not operate correctly: →P.302
- Set the speed appropriately according to the speed limit, traffic flow, road conditions, weather conditions, etc. The driver is responsible for confirming the set speed.

- Even if the system is operating correctly, the condition of a preceding vehicle as recognized by the driver and detected by the system may differ. Therefore, it is necessary for the driver to pay attention, assess risks, and ensure safety. Over-reliance on this system to drive the vehicle safely may lead to an accident resulting in death or serious injury.

#### ■ Precautions for the driving assist systems

Observe the following precautions, as there are limitations to the assistance provided by the system. Over-reliance on this system may lead to an accident resulting in death or serious injury.

- Details of support provided for the driver's vision

The dynamic radar cruise control is only intended to help the driver in determining the distance between the driver's own vehicle and a designated preceding vehicle. It is not a system which allows for careless or inattentive driving, and is not a system which assists in poor visibility conditions.

The driver must pay attention to their surroundings, even when the vehicle stops.

- Details of support provided for the driver's judgement

The dynamic radar cruise control determines whether the distance between the driver's own vehicle and a designated preceding vehicle is within a set range. It is not capable of making any other type of judgement. Therefore, it is absolutely necessary for the driver to remain vigilant and to determine whether or not there is a possibility of danger.

**WARNING**

- Details of support provided for the driver's operation

The dynamic radar cruise control does not include functions which will prevent or avoid collisions with vehicles ahead of your vehicle. Therefore, if there is ever any possibility of danger, the driver must take immediate and direct control of the vehicle and act appropriately in order to ensure safety.

- **Situations in which the dynamic radar cruise control should not be used**

Do not use the dynamic radar cruise control in the following situations. As the system will not be able to provide appropriate control, using it may lead to an accident resulting in death or serious injury.

- Roads where there are pedestrians, cyclists, etc.
- When driving on a highway or expressway entrance or exit
- When the approach warning sounds frequently
- Situations in which the sensors may not operate properly: →P.302
- Situations in which the lane may not be detected: →P.258

## Basic functions

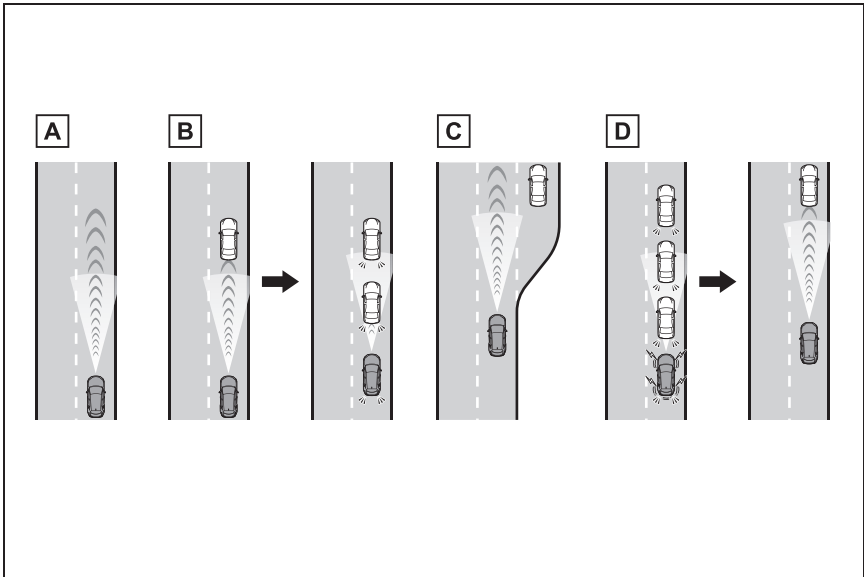
**A** Constant speed cruising:

When there are no vehicles ahead

The vehicle drives at the speed set by the driver.

If the set vehicle speed is exceeded while driving down a hill, the set vehicle speed display will blink and a buzzer will sound.

**B** Deceleration and follow-up cruising:

When a preceding vehicle driving slower than the set vehicle speed is detected

When a vehicle is detected driving ahead of your vehicle, the vehicle automatically decelerates and if a greater reduction in vehicle speed is necessary, the brakes are applied (the stop lights will come on at this time). The vehicle is controlled to maintain the vehicle-to-vehicle distance set by the driver, in accordance with changes in the speed of the preceding vehicle. If vehicle deceleration is not sufficient and the vehicle approaches the vehicle ahead, the approach warning will sound.

**C** Acceleration:

When there are no longer any preceding vehicles driving slower than the set vehicle speed

The vehicle accelerates until the set vehicle speed is reached and then resumes constant speed cruising.

**D** Starting off:

If a preceding vehicle stops, the vehicle will also stop (controlled stop). After the preceding vehicle starts off, pressing the "RES" switch or depressing the accelerator pedal will resume

follow-up cruising (start off operation). If a start off operation is not performed, the controlled stop will continue.

Vehicles with Traffic Jam Assist: While driving on a highway or expressway, if a preceding vehicle stops, your vehicle will stop accordingly. On some highways and expressways, if the system determines that the preceding vehicle starts off within approximately 3 minutes of stopping, a buzzer will sound and a message will be displayed on the multi-information display to notify the driver, and your vehicle will start off accordingly following the preceding vehicle. (Extended resume time)

## System components

### ■ Meter display

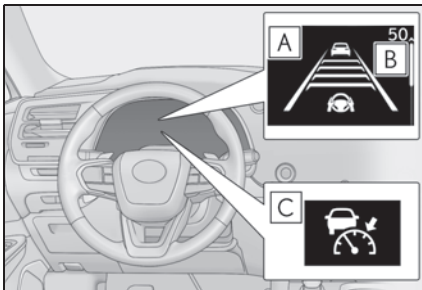

**A** Multi-information display

**B** Set vehicle speed

**C** Indicators

### ■ Switches

#### ► Vehicles without a head-up display

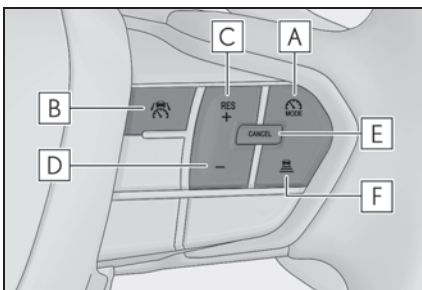

**A** Driving assist mode select switch

**B** Driving assist switch

**C** "+" switch/"RES" switch

**D** "-" switch

**E** Cancel switch

**F** Vehicle-to-vehicle distance switch

#### ► Vehicles with a head-up display

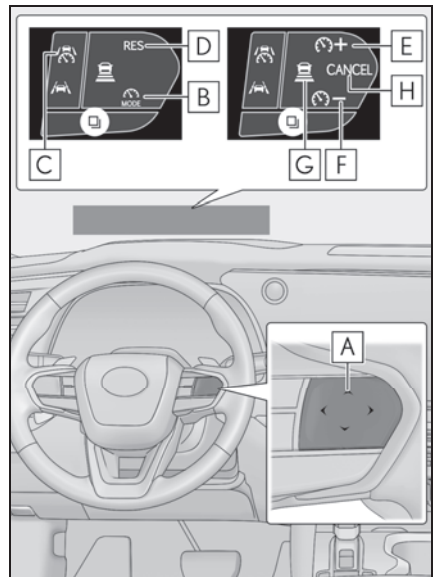

**A** The function of each switch differs depending on the conditions and settings.

When a switch is touched, the function of each switch is displayed on the head-up display. If the head-up display is off, the functions will be displayed on the multi-information display.

**B** Driving assist mode select switch

**C** Driving assist switch

**D** "RES" switch

- E** "+" switch
- F** "-" switch
- G** Vehicle-to-vehicle distance switch
- H** Cancel switch

## Using the dynamic radar cruise control

### Setting the vehicle speed

- 1** Press the driving assist mode select switch to select dynamic radar cruise control.

The dynamic radar cruise control indicator will illuminate.

- ▶ Vehicles without a head-up display

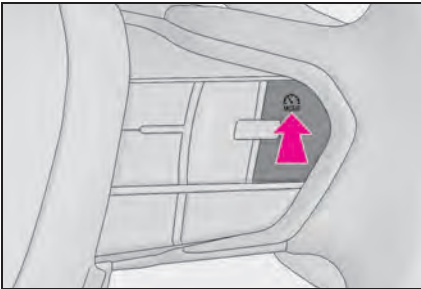

- ▶ Vehicles with a head-up display



- 2** Using the accelerator pedal, accelerate or decelerate to the desired vehicle speed (approximately 20 mph [30 km/h] or more), and press

the driving assist switch to set the set vehicle speed.

The set vehicle speed will be displayed on the multi-information display.

The vehicle speed at the moment the switch is released will be the set vehicle speed.

- ▶ Vehicles without a head-up display

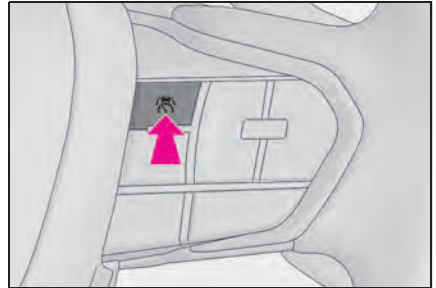

- ▶ Vehicles with a head-up display

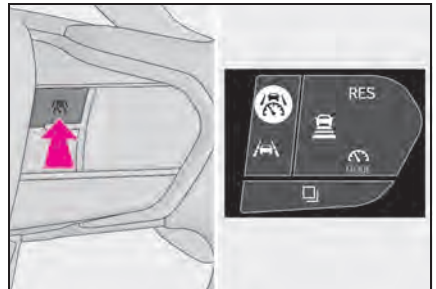

### Adjusting the set vehicle speed

- Adjusting the set vehicle speed using the switches

To change the set vehicle speed, press the "+" switch or "-" switch until the desired speed is displayed.

- Vehicles without a head-up display

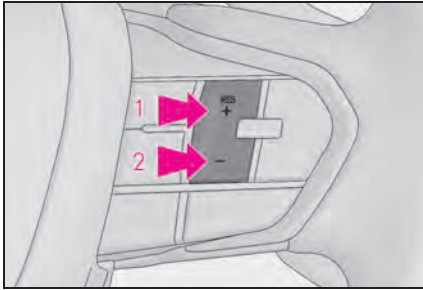

- 1 Increase set vehicle speed
- 2 Decrease set vehicle speed

- Vehicles with a head-up display

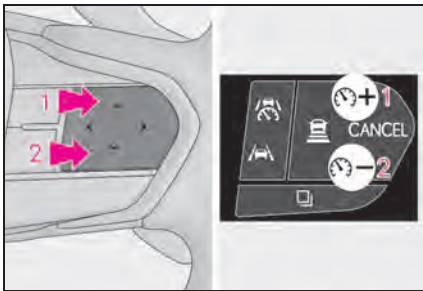

- 1 Increase set vehicle speed
- 2 Decrease set vehicle speed

Short press adjustment: Press the switch

Long press adjustment: Press and hold the switch until the desired set vehicle speed is reached.

The set vehicle speed will increase or decrease as follows:

Short press adjustment: Increases or decreases by 1 mph (1.6 km/h) each time the switch is pressed

Long press adjustment: Increases or decreases in 1 mph (1.6 km/h) increments continuously while the switch is pressed and held

- Increasing the set vehicle speed using the accelerator pedal

- 1 Depress the accelerator pedal to accelerate the vehicle to the desired vehicle speed.
- 2 Press the “+” switch.

### Canceling/resuming control

- Vehicles without a head-up display

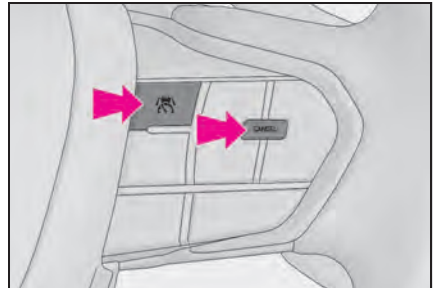

- Vehicles with a head-up display

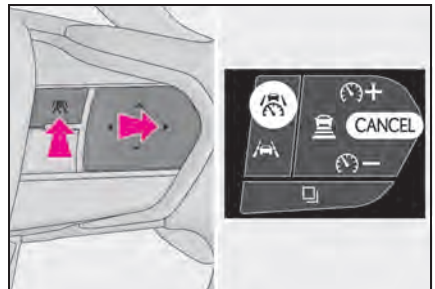

- 1 Press the cancel switch or driving assist switch to cancel control.

Control will also be canceled if the brake pedal is depressed.

(If the vehicle has been stopped by system control, depressing the brake pedal will not cancel control.)

- 2 Press the “RES” switch to resume control.

### Changing the vehicle-to-vehicle distance

Each time the switch is pressed, the

vehicle-to-vehicle distance setting will change as follows:

If a preceding vehicle is detected, the preceding vehicle mark will be displayed.

► Vehicles without a head-up display

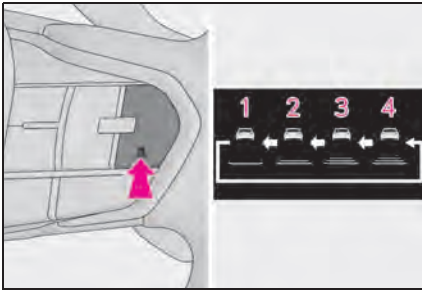

► Vehicles with a head-up display

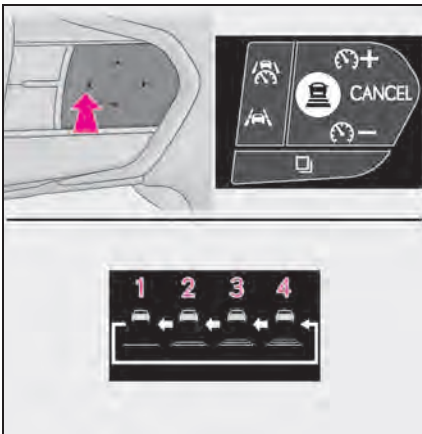

Illustration Number	Vehicle-to-vehicle distance	Approximate Distance (Vehicle Speed: 60 mph [100 km/h])
1	Short	Approximately 85 ft. (25 m)
2	Medium	Approximately 100 ft. (30 m)

Illustration Number	Vehicle-to-vehicle distance	Approximate Distance (Vehicle Speed: 60 mph [100 km/h])
3	Long	Approximately 145 ft. (45 m)
4	Extra long	Approximately 200 ft. (60 m)

The actual vehicle-to-vehicle distance varies in accordance with the vehicle speed. Also, when the vehicle is stopped by system control, it will be stopped at a certain distance from the preceding vehicle, depending on the situation, regardless of the setting.

■ Operating conditions

- The shift position is in D.
- The desired set speed can be set when the vehicle speed is approximately 20 mph (30 km/h) or more.
- If the vehicle speed is set while driving at below approximately 20 mph (30 km/h), the set vehicle speed will be approximately 20 mph (30 km/h).
- If the vehicle speed is set while driving at a speed that exceeds the system's upper limit, the set vehicle speed will be the system's upper limit.

■ Accelerating after setting the vehicle speed

As with normal driving, acceleration can be performed by depressing the accelerator pedal. After accelerating, the vehicle will return to the set vehicle speed. However, while in vehicle-to-vehicle distance control mode, the vehicle speed may decrease to below the set vehicle speed in order to maintain the distance from the preceding vehicle.

■ When the vehicle is stopped by system control during follow-up cruising

- When the "RES" switch is pressed while the vehicle is stopped by system control, if the preceding vehicle starts off within approximately 3 seconds, follow-up

cruising will resume.

- If the preceding vehicle starts off within approximately 3 seconds of the vehicle being stopped by system control, follow-up cruising will resume.

#### ■ Automatic cancellation of vehicle-to-vehicle distance control mode

In the following situations, vehicle-to-vehicle distance control mode will be canceled automatically:

- When the brake control or output restriction control of a driving support system operates  
(For example: Pre-Collision System, drive-start control)
- When the parking brake has been operated
- When the vehicle is stopped by system control on a steep incline
- When any of the following are detected while the vehicle is stopped by system control:
  - The driver's seat belt is unfastened
  - The driver's door is opened
  - Approximately 3 minutes have elapsed since the vehicle was stopped

The parking brake may be activated automatically.

- Situations in which some or all of the functions of the system cannot operate: →P.258

#### ■ Dynamic radar cruise control system warning messages and buzzers

For safe use: →P.252

#### ■ Preceding vehicles that the sensor may not detect correctly

In the following situations, depending on the conditions, if the system cannot provide sufficient deceleration or acceleration is necessary, operate the brake pedal or accelerator pedal.

As the sensor may not be able to correctly detect these types of vehicles, the approach warning (→P.302) may not operate.

- When a vehicle cuts in front of your vehicle or changes lanes away from your vehicle extremely slowly or quickly

- When changing lanes
- When a preceding vehicle is driving at a low speed
- When a vehicle is stopped in the same lane as the vehicle
- When a motorcycle is traveling in the same lane as the vehicle

#### ■ Conditions under which the system may not operate correctly

In the following situations, operate the brake pedal (or accelerator pedal, depending on the situation) as necessary.

As the sensor may not be able to correctly detect a vehicle, the system may not operate properly.

- When a preceding vehicle brakes suddenly
- When changing lanes at low speeds, such as in a traffic jam

#### ■ Conditions for extended resume time (vehicles with Traffic Jam Assist)

Extended resume time is activated when all of the following conditions are satisfied:

- Vehicles with a display audio: The connected service that Lexus provides is subscribed to. Contact your Lexus dealer for details.
- The vehicle is driving on a vehicle-only road, such as an expressway.
- There is a preceding vehicle and the system is able to detect it.
- No vehicle interruptions occur.
- The preceding vehicle has not been replaced.
- Clearance sonar and FCTA are not detecting the object in front of you.
- The driver monitor judges that the driver is looking forward.
- The steering wheel has not been operated.
- The brake pedal has not been operated.

### Approach warning

In situations where the vehicle

approaches a preceding vehicle and the system cannot provide sufficient deceleration, such as if a vehicle cuts in front of the vehicle, a warning display will flash and a buzzer will sound to alert the driver. Depress the brake pedal to ensure appropriate vehicle-to-vehicle distance.

#### ■ Warnings may not occur when

In the following situations, the warning may not operate even though the vehicle-to-vehicle distance is short.

- When the preceding vehicle is traveling at the same speed or faster than your vehicle
- When the preceding vehicle is traveling at an extremely low speed
- Immediately after the vehicle speed has been set
- When the accelerator pedal is depressed

#### Curve speed reduction function

When a curve is detected, the vehicle speed will begin being reduced. When the curve ends, the vehicle speed reduction will end.

Depending on the situation, the vehicle speed will then return to the set vehicle speed.

In situations where vehicle-to-vehicle distance control needs to operate, such as when a preceding vehicle cuts in front of your vehicle, the curve speed reduction function will be canceled.



#### ■ Situations in which the curve speed reduction function may not operate

In situations such as the following, the curve speed reduction function may not operate:

- When the vehicle is being driven around a gentle curve
- When the accelerator pedal is being depressed
- When the vehicle is being driven around an extremely short curve

#### Driver Monitor support function (if equipped)

While a warning of the driver monitor is being displayed, the vehicle acceleration will be restrained.

When the warning of the driver monitor disappears, the restrained acceleration control will end.

#### Support for lane change

If your vehicle is being driven at approximately 50 mph (80 km/h) or more and a lane change to the passing lane is performed, when the turn signal lever is operated and the lane is changed, the vehicle will accelerate up to the set speed to assist in overtaking.

The system's recognition of which lane is the passing lane may be based solely on

the location of the steering wheel in the vehicle (left-hand drive/right-hand drive). If the vehicle is driven in a location where the passing lane is on the opposite side of that where the vehicle was originally sold, the vehicle may accelerate when the turn signal lever is operated away from the passing lane. (e.g. The vehicle was manufactured for a right-hand traffic location, but is being driven in a left-hand traffic location. The vehicle may accelerate when the turn signal lever is operated to the right.)

If your vehicle is being driven at approximately 50 mph (80 km/h) or





more and the lane is changed to that with a vehicle traveling slower than your vehicle, when the turn signal lever is operated the vehicle will gradually decelerate to assist in changing lanes.







### Changing Dynamic radar cruise control settings

- The settings of Dynamic radar cruise control can be changed through customize settings. (→P.590)

### Display and system operation state

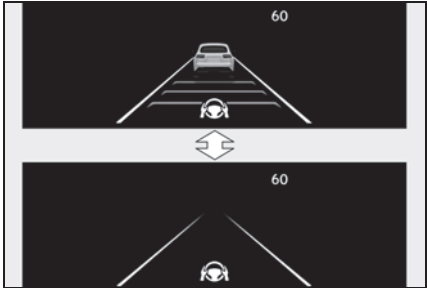
The operating state of Dynamic radar cruise control is indicated.

Indicator	Multi-information display	Situation
 White		Vehicle-to-vehicle distance setting: Grey  Dynamic radar cruise control being OFF
 Green		Vehicle-to-vehicle distance setting: Blue  Set vehicle speed: Green  Constant speed cruising

Indicator	Multi-information display		Situation
 Green		Vehi- cle-to-vehicle distance set- ting: Blue  Set vehicle speed: Green  Preceding vehicle: White	Follow-up cruising
 Green		Vehi- cle-to-vehicle distance set- ting: Orange flashing  Set vehicle speed: Green  Preceding vehicle: Orange flash- ing	Approach warning
 Green		Vehi- cle-to-vehicle distance set- ting: Grey  Set vehicle speed: White  Preceding vehicle: Grey	Accelerating with the accel- erator pedal
 Green		Set vehicle speed: Green in reverse dis- play	Set vehicle speed being exceeded

## Cruise control

The vehicle can be driven at a set speed even if the accelerator pedal is not depressed.

Use the cruise control only on highways and expressways.

### ⚠ WARNING

#### ■ For safe use

- Driving safely is solely the responsibility of the driver. Therefore, do not overly rely on this system. The driver is solely responsible for paying attention to the vehicle's surroundings and driving safely.
- Set the speed appropriately according to the speed limit, traffic flow, road conditions, weather conditions, etc. The driver is responsible for confirming the set speed.

#### ■ Situations in which cruise control should not be used

Do not use the cruise control in the following situations. As the system will not be able to provide appropriate control, using it may lead to an accident resulting in death or serious injury.

- On roads with sharp bends
- On winding roads
- On slippery roads, such as those covered with rain, ice or snow
- On steep downhill, or where there are sudden changes between sharp up and down gradients

Vehicle speed may exceed the set speed when driving down a steep hill.

- When it is necessary to disable the system: →P.252

## System Components

### ■ Meter display

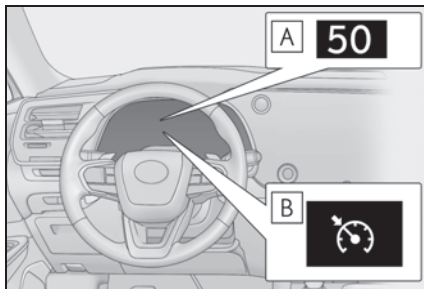

**A** Set vehicle speed

**B** Cruise control indicator

### ■ Switches

#### ▶ Vehicles without a head-up display

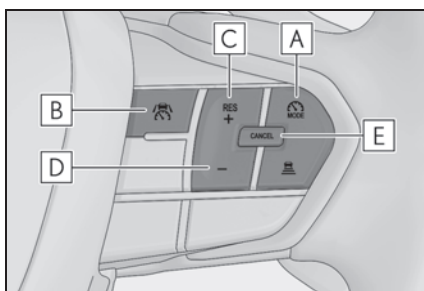

**A** Driving assist mode select switch

**B** Driving assist switch

**C** "+" switch/"RES" switch

**D** "-" switch

**E** Cancel switch

► Vehicles with a head-up display

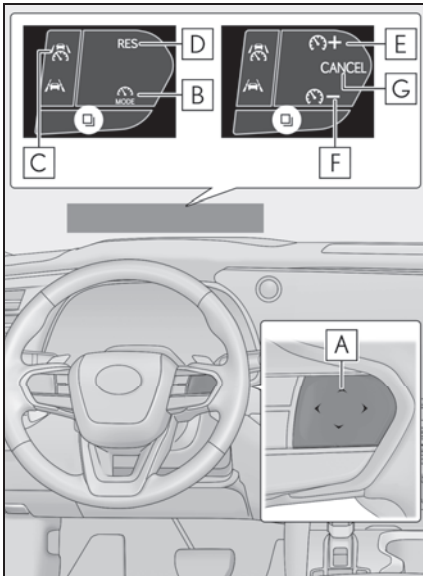

**A** The function of each switch differs depending on the conditions and settings.

When a switch is touched, the function of each switch is displayed on the head-up display. If the head-up display is off, the functions will be displayed on the multi-information display.

- B** Driving assist mode select switch
- C** Driving assist switch
- D** "RES" switch
- E** "+" switch
- F** "-" switch
- G** Cancel switch

## Using the cruise control

### Setting the vehicle speed

- 1** Press the driving assist mode select switch to select cruise control.

The cruise control indicator will illuminate.

► Vehicles without a head-up display

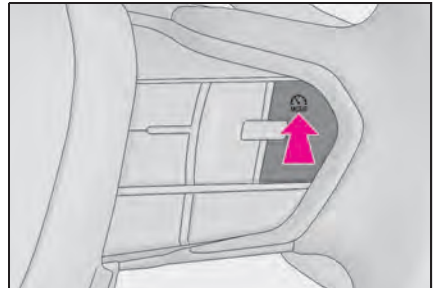

► Vehicles with a head-up display

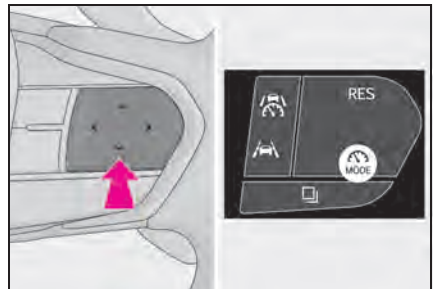

- 2** Using the accelerator pedal, accelerate to the desired vehicle speed (approximately 20 mph [30 km/h] or more), and press the driving assist switch to set the set vehicle speed.

The vehicle speed at the moment the switch is released will be the set vehicle speed.

## ▶ Vehicles without a head-up display

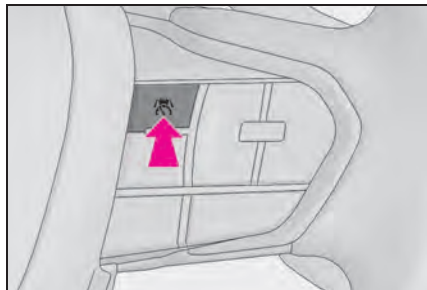

## ▶ Vehicles with a head-up display

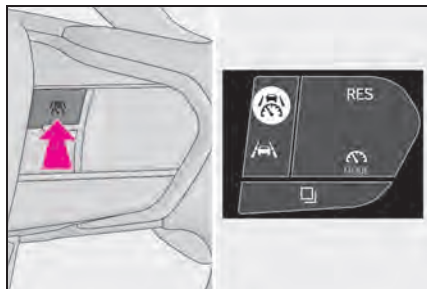

### Adjusting the set vehicle speed

- Adjusting the set vehicle speed using the switches

To change the set vehicle speed, press the “+” switch or “-” switch until the desired speed is displayed.

## ▶ Vehicles without a head-up display

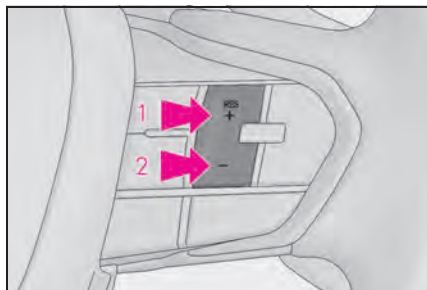

- 1 Increase set vehicle speed
- 2 Decrease set vehicle speed

## ▶ Vehicles with a head-up display

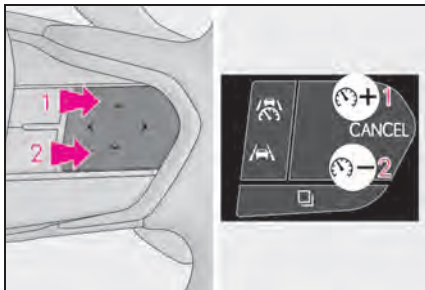

- 1 Increase set vehicle speed
- 2 Decrease set vehicle speed

The set vehicle speed will increase or decrease as follows:

Fine adjustment: By 0.6 mph (1 km/h) or 1 mph (1.6 km/h) each time the switch is pressed

Large adjustment: Increases continuously while the switch is pressed and held

- Increasing the set vehicle speed using the accelerator pedal
- 1 Depress the accelerator pedal to accelerate the vehicle to the desired vehicle speed.
  - 2 Press the “+” switch.

### Canceling/resuming control

## ▶ Vehicles without a head-up display

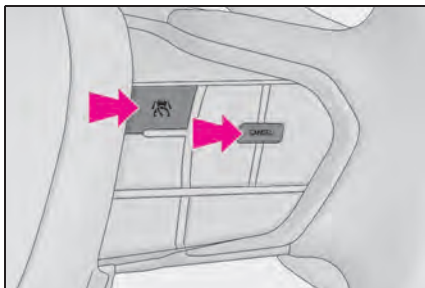

► Vehicles with a head-up display

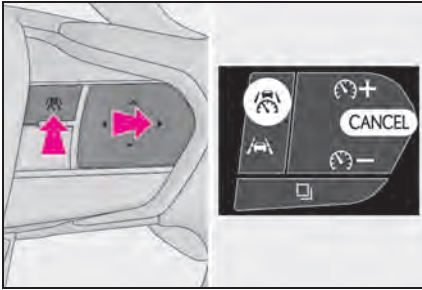

- 1 Press the cancel switch or driving assist switch to cancel control.

Control will also be canceled if the brake pedal is depressed.

- 2 Press the "RES" switch to resume control.

### ■ Automatic cancellation of the cruise control

In the following situations, the cruise control will be canceled automatically:



- When the vehicle speed drops approximately 10 mph (16 km/h) or more below the set vehicle speed
- When the vehicle speed drops below approximately 20 mph (30 km/h)
- When the brake control or output restriction control of a driving support system operates





(For example: PCS, drive-start control)

- When the parking brake has been operated
- Situations in which some or all of the functions of the system cannot operate:  
→P.258

## Display and system operation state

The operating state of cruise control is indicated.

Indicator	Multi-information display	Situation
 White		Blank Cruise control being OFF

Indicator	Multi-information display		Situation
 Green			Set vehicle speed: Green  Constant speed cruising
 Green			Set vehicle speed: Green in reverse display  Set vehicle speed being exceeded

## Emergency Driving Stop System

The emergency driving stop system is a system which automatically decelerates and stops the vehicle within its lane if the driver becomes unable to continue driving the vehicle, such as if they have suffered a medical emergency, etc.

During LTA (Lane Tracing Assist) control, if the system does not detect driving operations, such as if the driver is not holding the steering wheel, and determines the driver is not responsive, the vehicle will be decelerated and stopped within its current lane to help avoid a collision or reduce the impact of a collision.

The vehicle will also decelerate/stop during the Traffic Jam Assist (if equipped) controls, when no driver's response to the vehicle's warning to hold the steering wheel is detected.



### WARNING

#### ■ For safe use

- Driving safely is solely the responsibility of the driver. Pay careful attention to the surrounding conditions in order to ensure safe driving. The emergency driving stop system is designed to provide support in an emergency where it is difficult for the driver to continue driving, such as if they have had a medical emergency. It is not designed to support driving while drowsy or in poor physical health, or inattentive driving.

- Although the emergency driving stop system is designed to decelerate the vehicle within its lane to help avoid or help reduce the impact of a collision if the system determines that it is difficult for the driver to continue driving, its effectiveness may change according to various conditions. Therefore, it may not always be able to achieve the same level of performance. Also, if the operating conditions are not met, this function will not operate.
- After the emergency driving stop system operates, if driving becomes possible again, immediately begin driving again or, if necessary, park the vehicle on the shoulder of the road and set a warning reflector and flare to warn other drivers of your stopped vehicle.
- After this system operates, passengers should attend to the driver as necessary and take appropriate hazard prevention measures, such as moving to a place where safety can be ensured, such as the shoulder of the road or behind a guardrail.
- This system detects the condition of the driver through the operation of the steering wheel. This system may operate if the driver is aware but intentionally and continuously does not operate the vehicle. Also, the system may not operate if it cannot determine that the driver is not responsive, such as if they are leaning on the steering wheel.
- Situations in which the driver monitor may not operate properly (vehicles with a driver monitor): →P.258

## Summary of the system

Operation of this system is separated into 4 control states. Through control state "Warning phase 1" and "Warning phase 2", the system determines if the driver is aware and responsive while outputting a warning and controlling

the vehicle speed. If the system determines the driver is not responsive, it will operate in control state “Deceleration stop phase” and “Stop hold phase” and decelerate and stop the vehicle. It will then operate continuously in “Stop hold phase”.

#### ■ Operating conditions

This system operates when all of the following conditions are met:

- When the LTA is on

Or during the Traffic Jam Assist controls (if equipped)

- When the vehicle speed is approximately 30 mph (50 km/h) or more

During the Traffic Jam Assist (if equipped) controls, the system may operate at below 30 mph (50 km/h).

#### ■ Operation cancelation conditions

In the following situations, system operation will be canceled:

- When LTA control has been canceled (the LTA switch has been pressed, etc.)
- When the dynamic radar cruise control has been canceled
- When driver operations are detected (the steering wheel is held, the brake pedal, accelerator pedal, parking brake, hazard light switch, or turn signal lever is operated)
- When the driving assist switch is pressed while in the stop and hold phase
- When the power switch has been turned from ON to off
- Situations in which some or all of the functions of the system cannot operate:  
→P.258

#### ■ LTA control when operation is canceled

When emergency driving stop system operation is canceled, LTA control may also be canceled.

### Warning phase 1

If driving operations are not detected after the hands off steering wheel warning operates, a buzzer will sound intermittently and a message will be displayed to warn the driver, and the system will judge if the driver is responsive or not. If driving operations, such as holding the steering wheel, are not performed within a certain amount of time, the system will enter warning phase 2.

Vehicles with a driver monitor camera: Depending on the type of detection of the driver’s unresponsiveness, the system may skip warning phase 1 and start the control of warning phase 2.

### Warning phase 2

After entering warning phase 2, a buzzer will sound in short intervals and a message will be displayed to warn the driver, and the vehicle will slowly decelerate. If driving operations, such as holding the steering wheel, are not performed within a certain amount of time, the system will determine that the driver is not responsive and enter the deceleration stop phase.

The audio system will be muted until the driver becomes responsive.

When the vehicle is decelerating, the brake lights may illuminate, depending on the road conditions, etc.

### Deceleration stop phase

After entering the deceleration stop

phase, a buzzer will sound continuously and a message will be displayed to warn the driver, and the vehicle will slowly decelerate and stop. After the vehicle stops, the system will enter the stop and hold phase.

### Stop hold phase

After the vehicle is stopped, the parking brake will be applied automatically. After entering the stop and hold phase, the buzzer will continue sounding continuously and the emergency flashers (hazard lights) will flash to warn other drivers of the emergency.

#### ■ Restricted functions after the operation is canceled

After shifting to the deceleration stop phase, the following functions will not be available until the hybrid system is re-started even though the emergency driving stop system is canceled:

- LTA
- LCA (if equipped)
- Traffic Jam Assist (if equipped)

## Traffic Jam Assist\*

\*: If equipped

### Function Outline

Traffic Jam Assist is a system which, through confirmation of the conditions by the driver, provides lane keeping, accelerating/decelerating, stopping, and starting off support on some highways and expressways. Also, in an emergency, the system can decelerate and stop, to help avoid a collision or help reduce the impact of a collision.

#### ■ Precautions for use

→P.256

### Sensors that support the Traffic Jam Assist

- Sensors which detect the surrounding conditions (→P.253)
- Sensors which detect the driver condition (→P.254)

#### ■ Situations in which some or all of the functions of the system cannot operate

→P.258

#### ■ Changes in brake operation sound and pedal response

→P.258

#### ■ Situations in which the driver monitor may not operate properly

→P.258

## Emergency Driving Stop System

→P.311

## Extended resume time of Dynamic radar cruise control

→P.295

## Traffic Jam Assist Function

The Traffic Jam Assist function, through confirmation of the conditions by the driver, provides lane keeping, accelerating/decelerating and stopping support on some highways and expressways.

This function is operable when all of the operation conditions are met.

When this function is operating, it is possible to take your hands off of the steering wheel. (→P.316)

Before using the Traffic Jam Assist function, familiarize yourself with the content of the dynamic radar cruise control and the LTA (Lane Tracing Assist).

Make sure that the driver steers the vehicle when entering a service area/parking area or toll gate, or when changing lanes.

## Driver monitor camera recording

When the operation of Traffic Jam Assist is started, the following message will be displayed:

- “Allow Driver Monitor Camera Recording?”

When recording is approved, the system records images of the area around the driver in certain crash or near crash-like situations, such as an SRS airbag being deployed or the vehicle hitting an object on the road. (→P.9)

## WARNING

### ■ For safe use

- Driving safely is solely the responsibility of the driver. Do not overly rely on this system, and pay careful attention to the surrounding conditions in order to ensure safe driving.
- The Traffic Jam Assist function is not an automated driving system. This function provides the driver with information and driving assistance according to the road shape and conditions, traffic conditions, and the condition of the driver themselves. Always pay careful attention to the surrounding conditions as use of the system is the responsibility of the driver.
- Depending on the condition of the surrounding area, the road, or the driver, the Traffic Jam Assist function may not operate or operation may be suspended. Also, it may not always be able to achieve the same level of performance. Read the operating conditions of the function carefully. Do not overly rely on this function and always drive carefully.
- As the recognition performance and control performance of the Traffic Jam Assist function are limited, driver operation is necessary to ensure safety while the system is operating. Also, the steering assist of this system is designed to operate only for slow steering operations during a traffic jam. While this function is operating, the lane deviation control function of the LDA will not operate. If, for some reason, the vehicle is about to deviate the lane, it is the driver's responsibility to drive properly.

**WARNING**

- Even if Traffic Jam Assist is operating properly, the surrounding conditions as recognized by the driver and detected by the system may differ. Therefore, it is necessary for the driver to pay attention, assess risks, and ensure safety. Over-reliance on this system to drive the vehicle safely may lead to an accident resulting in death or serious injury.
- While the Traffic Jam Assist function is operating, as driver operation may become necessary, the driver must ensure they have clear visibility of their surroundings.
- In certain situations, a message urging the driver to hold the steering wheel may be displayed by the Traffic Jam Assist function. In this case, hold the steering wheel and drive the vehicle manually to ensure safety.
- The Traffic Jam Assist function cannot detect the following objects. Operate the steering wheel, accelerator pedal, or brake pedal as necessary to avoid a collision. As the function will not be able to provide appropriate control, using it may lead to an accident resulting in death or serious injury.
  - Objects on the road surface
  - Vehicles outside of a lane (such as on the shoulder of the road)
  - Potholes, cracks, ruts, or other road damage
  - Road construction zones
  - Vehicles running in parallel with your vehicle or nearby walls
  - Animals

**■ Situations in which Traffic Jam Assist Function should not be used**

Do not use Traffic Jam Assist Function in situations such as the following. As the system will not be able to provide appropriate control, using it may lead to an accident resulting in death or serious injury.

- When it is necessary to disable the system  
→P.252
- Situations in which the sensors may not operate properly  
→P.257
- Situations in which the lane may not be detected  
→P.258

**■ Situations in which the function may not operate properly**

In situations such as the following, the Traffic Jam Assist function may not operate properly. Manually operate the vehicle as necessary.

- When a sensor is splashed by water
- When the ambient temperature is high or low
- When a vehicle cuts in front of your vehicle
- When another lane merges into the lane in the same traveling direction as your vehicle
- When driving in low visibility condition
- When the vehicle posture is changing
- When the traction on the road surface differs greatly between the left and right side tires
- When driving on an expressway with no median strips or when driving on an expressway equipped with temporary median markers, such as poles.

**WARNING**

● When there is a significant difference in speed between your vehicle and the other vehicle

● The map data has not been updated properly.

■ **To prevent malfunction of the radar sensors**

→P.254

■ **To prevent malfunction of the front camera**

→P.255

■ **Front camera installation area on the windshield**

→P.256

### ■ Operating conditions of the function

This function is operable when all of the following conditions are met:

- The system detects lane lines and the path of preceding or surrounding vehicles.
- The dynamic radar cruise control and the lane tracing assist are operating.
- The turn signal lever is not being operated.
- The vehicle is not being driven around a sharp curve.
- The vehicle is being driven in the center of a lane.
- The driver monitor camera is detecting that the driver is facing front of the vehicle.
- The vehicle is driving in traffic jam on a highway or expressway at approximately 25 mph (40 km/h) or less. (In some situations, such as when a traffic jam starts, this function may be operational at approximately 20 mph [30 km/h] or less.)
- Vehicles with a connected navigation (display audio): Safety Connect is being

subscribed to.

- The driver's door is closed.
- The driver's seat belt is fastened.
- Customized setting of the Traffic Jam Assist is not set to off.
- Functions and components composing the system are in proper condition.
- Customized setting of the PCS (Pre-Collision System) is not set to off.
- Customized setting of the dynamic radar cruise control (re-start time extension) is not set to off.

### ■ Temporary cancelation of the function

- When the operating conditions are no longer met, a function may be temporarily canceled. However, when the operation conditions are met again, operation of the function will automatically be restored.
- If the operating conditions of a function are no longer met while the function is operating, a buzzer may sound with a display to indicate that the function has been temporarily canceled. If no driver's responses to the indication are detected, the driver emergency stop assist function may operate. For types of display and action to be taken, see the page mentioned below. (→P.317)

### ■ Driving operations during controlled driving

#### ● Accelerator pedal

As with normal driving, acceleration can be performed by depressing the accelerator pedal. In some situations, such as when driving at approximately 6 mph (10 km/h) or more and the accelerator pedal is depressed, this function will be canceled.

#### ● Brake pedal

As with normal driving, deceleration can be performed by depressing the brake pedal. However, controlled driving will be cancelled.

#### ● Steering wheel

As with normal driving, the steering wheel

can be operated. If the steering wheel is operated more than a certain amount, controlled driving will be cancelled.

■ **When a warning message is displayed**

- "Traffic Jam Asst System Malfunction Visit Your Dealer"

The Traffic Jam Assist function may not be operating properly.

- "Traffic Jam Asst Unavailable Stop Assist Activated"





The system temporarily cannot be used as the driver emergency stop assist function has operated.



### Changing Traffic Jam Assist settings

- The setting of Traffic Jam Assist can be enabled/disabled through a customize setting. (→P.590)
- The setting of driver monitor camera recording can be enabled/disabled through a customize setting. (→P.590)

### Displays and system operation

The following displays indicate the operating status of the Traffic Jam Assist function:

Display	Status	Action to be taken
	Traffic Jam Assist function is operating	—
 (Grey)	Traffic Jam Assist function is about to end	Hold the steering wheel.
 (Orange)	Traffic Jam Assist function has ended	Hold the steering wheel.
 (Red)	Operation of either or both of dynamic radar cruise control /LTA (Lane Tracing Assist) ended	Manually operate the steering wheel immediately.

Display	Status	Action to be taken
 (Yellow)	Indicates that driving actions are necessary to cope with cut-in or other behavior of surrounding vehicles	The driver must operate the steering wheel, accelerator pedal and brake pedal in accordance with the surrounding environment.
	Indicates that the recording function of the driver monitor camera is operational (Blinking of this icon indicates that recording is undergoing, and constant illumination indicates ready for recording.)	—

## BSM (Blind Spot Monitor)

The Blind Spot Monitor is a system that uses rear side radar sensors installed on the inner side of the rear bumper on the left and right side to assist the driver in confirming safety when changing lanes.

### ⚠ WARNING

#### ■ Cautions regarding the use of the system

- The driver is solely responsible for safe driving. Always drive safely, taking care to observe your surroundings.
- The Blind Spot Monitor is a supplementary function which alerts the driver that a vehicle is in a blind spot of the outside rear view mirrors or is approaching rapidly from behind into a blind spot. Do not overly rely on the Blind Spot Monitor. As the function cannot judge if it is safe to change lanes, over reliance could lead to an accident resulting in death or serious injury.  
As the system may not function correctly under certain conditions, the driver's own visual confirmation of safety is necessary.

### System components

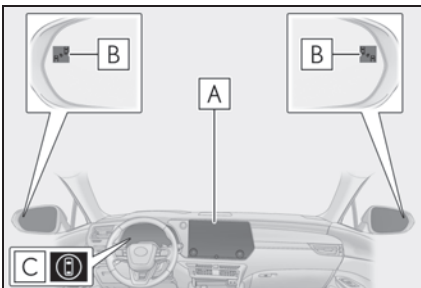

#### A Center display

Turning the Blind Spot Monitor on/off.

#### B Outside rear view mirror indicators/buzzer

When a vehicle is detected in a blind spot of the outside rear view mirrors or approaching rapidly from behind into a blind spot, the outside rear view mirror indicator on the detected side will illuminate. If the turn signal lever is operated toward the detected side, the outside rear view mirror indicator will flash and a buzzer will sound.

#### C Driving assist information indicator

Illuminates when the Blind Spot Monitor is turned off. At this time, "Blind Spot Monitor OFF" will be displayed on the multi-information display.

#### ■ Outside rear view mirror indicator visibility

In strong sunlight, the outside rear view mirror indicator may be difficult to see.

#### ■ Buzzer

If the volume setting of the audio system is high or the surrounding area is loud, it may be difficult to hear the buzzer.

#### ■ Customization

Some functions can be customized.  
(→P.590)

### ⚠ WARNING

#### ■ To ensure the system can operate properly

Blind Spot Monitor sensors are installed behind the left and right sides of the rear bumper respectively. Observe the following to ensure the Blind Spot Monitor can operate correctly.

### WARNING

- Keep the sensors and the surrounding areas on the rear bumper clean at all times.

If a sensor or its surrounding area on the rear bumper is dirty or covered with snow, the Blind Spot Monitor may not operate and a warning message will be displayed. In this situation, clear off the dirt or snow and drive the vehicle with the operation conditions of the BSM function (→P.322) satisfied for approximately 10 minutes. If the warning message does not disappear, have the vehicle inspected by your Lexus dealer.

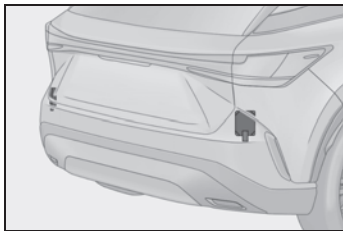

- Do not attach accessories, stickers (including transparent stickers), aluminum tape, etc. to a sensor or its surrounding area on the rear bumper.
- Do not subject a sensor or its surrounding area on the rear bumper to a strong impact.  
If a sensor is moved even slightly off position, the system may malfunction and vehicles may not be detected correctly.  
In the following situations, have your vehicle inspected by your Lexus dealer.
  - A sensor or its surrounding area is subject to a strong impact.
  - If the surrounding area of a sensor is scratched or dented, or part of them has become disconnected.
- Do not disassemble the sensor.

- Do not modify the sensor or surrounding area on the rear bumper.
- If a sensor or the rear bumper needs to be removed/installed or replaced, contact your Lexus dealer.
- The sensors are likely to be affected by paint on the rear bumper. If the rear bumper is not repaired correctly, the Blind Spot Monitor may not operate with a warning message displayed. If any paint repair is needed, contact your Lexus dealer.

### Turning the Blind Spot Monitor on/off

The blind spot monitor can be enabled/disabled on  of the center display. (→P.590)

When the Blind Spot Monitor is off, the driving assist information indicator (→P.88) will illuminate. At this time, “Blind Spot Monitor OFF” will be displayed on the multi-information display.

Each time the power switch is turned to ON, the Blind Spot Monitor is enabled.

## Blind Spot Monitor operation

### ■ Objects that can be detected while driving

The Blind Spot Monitor uses rear side radar sensors to detect the following vehicles traveling in adjacent lanes and advises the driver of the presence of such vehicles via the indicators on the outside rear view mirrors.

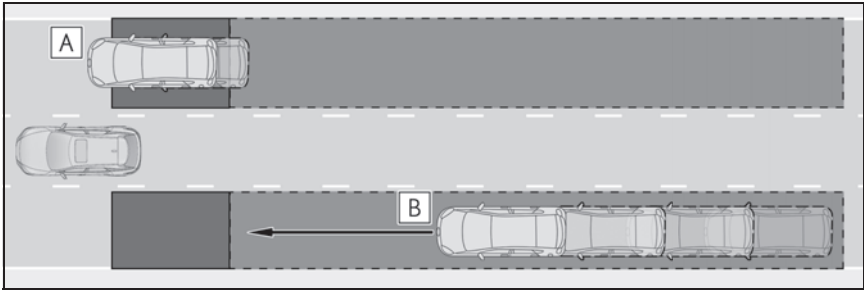

- A** Vehicles that are traveling in areas that are not visible using the outside rear view mirrors (the blind spots)
- B** Vehicles that are approaching rapidly from behind in areas that are not visible using the outside rear view mirrors (the blind spots)

### ■ Detection range while driving

The areas that vehicles can be detected in are outlined below.



The range of each detection area is:

- A** Approximately 1.6 ft. (0.5 m) to 11.5 ft. (3.5 m) from either side of the vehicle <sup>\*1</sup>
- B** Approximately 3.3 ft. (1 m) forward of the rear bumper <sup>\*2</sup>
- C** Approximately 9.8 ft. (3 m) from the rear bumper
- D** Approximately 9.8 ft. (3 m) to 230 ft. (70 m) from the rear bumper <sup>\*3</sup>

<sup>\*1</sup>: The area between the side of the vehicle and 1.6 ft. (0.5 m) from the side of the vehicle cannot be detected.

<sup>\*2</sup>: While the vehicle is to be overtaken, up to approximately 9.8 ft. (3 m) forward of the

rear bumper will be detected.

<sup>3</sup>: The greater the difference in speed between your vehicle and the detected vehicle is, the farther away the vehicle will be detected, causing the outside rear view mirror indicator to illuminate or flash.

### ■ The Blind Spot Monitor linked function

The LDA (Lane Departure Alert) has a function that uses information of detected vehicles driving in an adjacent lane. For details about the function and its operating conditions, P.279

#### ■ The Blind Spot Monitor is operational when

The Blind Spot Monitor is operational when all of the following conditions are met:

- The power switch is in ON.
- The Blind Spot Monitor is on.
- The shift position is in a position other than R.
- The vehicle speed is greater than approximately 7 mph (10 km/h).

#### ■ The Blind Spot Monitor will detect a vehicle when

The Blind Spot Monitor will detect a vehicle present in the detection area in the following situations:

- A vehicle in an adjacent lane overtakes your vehicle.
- You overtake a vehicle in an adjacent lane slowly.
- Another vehicle enters the detection area when it changes lanes.

#### ■ Situations in which the blind spot monitor cannot detect vehicles.

The blind spot monitor cannot detect the following vehicles and other objects:

- Small motorcycles, bicycles, pedestrians, etc.<sup>\*</sup>
- Vehicles traveling in the opposite direction
- Guardrails, walls, signs, parked vehicles

and similar stationary objects<sup>\*</sup>

- Following vehicles that are in the same lane<sup>\*</sup>
- Vehicles traveling 2 lanes away from your vehicle<sup>\*</sup>
- Vehicles which are being overtaken rapidly by your vehicle<sup>\*</sup>

<sup>\*</sup>: Depending on the conditions, detection of a vehicle and/or object may occur.

#### ■ Conditions under which the System may not function correctly

- The Blind Spot Monitor may not detect vehicles correctly in the following situations:
  - When the sensor is misaligned due to a strong impact to the sensor or its surrounding area
  - When mud, snow, ice, a sticker, etc. is covering the sensor or surrounding area on the rear bumper
  - When driving on a road surface that is wet with standing water during bad weather, such as heavy rain, snow, or fog
  - When multiple vehicles are approaching with only a small gap between each vehicle
  - When the distance between your vehicle and a following vehicle is short
  - When there is a significant difference in speed between your vehicle and the vehicle that enters the detection area
  - When the difference in speed between your vehicle and another vehicle is changing
  - When a vehicle enters a detection area traveling at about the same speed as your vehicle
  - As your vehicle starts from a stop, a vehicle remains in the detection area
  - When driving up and down consecutive steep inclines, such as hills, dips in the road, etc.
  - When driving on roads with sharp bends, consecutive curves, or uneven surfaces

- When vehicle lanes are wide, or when driving on the edge of a lane, and the vehicle in an adjacent lane is far away from your vehicle
- When an accessory (such as a bicycle carrier) is installed to the rear of the vehicle
- When there is a significant difference in height between your vehicle and the vehicle that enters the detection area
- Immediately after the Blind Spot Monitor is turned on
- When towing with the vehicle
- Instances of the Blind Spot Monitor unnecessarily detecting a vehicle and/or object may increase in the following situations:
  - When the sensor is misaligned due to a strong impact to the sensor or its surrounding area
  - When the distance between your vehicle and a guardrail, wall, etc. that enters the detection area is short
  - When driving up and down consecutive steep inclines, such as hills, dips in the road, etc.
  - When vehicle lanes are narrow, or when driving on the edge of a lane, and a vehicle traveling in a lane other than the adjacent lanes enters the detection area
  - When driving on roads with sharp bends, consecutive curves, or uneven surfaces
  - When the tires are slipping or spinning
  - When the distance between your vehicle and a following vehicle is short
  - When an accessory (such as a bicycle carrier) is installed to the rear of the vehicle
  - When towing with the vehicle

## Safe Exit Assist

The safe exit assist (with door opening control) is a system that uses rear side radar sensors installed on the inner side of the rear bumper to help occupants judge if an approaching vehicle or bicycle may collide with a door when exiting or cancel opening of a door, to help reduce the possibility of a collision.

### ⚠ WARNING

#### ■ Cautions regarding the use of the system

- The driver is solely responsible for safe driving. Always drive safely, taking care to observe your surroundings.
- The safe exit assist is a supplementary system that, when the vehicle is stopped, informs occupants of the existence of approaching vehicles and bicycles. As this system alone cannot be used to judge safety, over-reliance on this system may lead to an accident resulting in death or serious injury.

In certain situations, this system may not function to its fullest extent. Therefore it is necessary for the occupants to visually check for safety directly and using the mirrors.

## System components

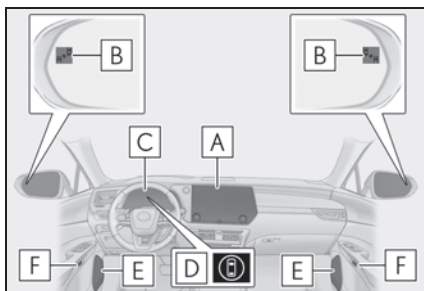

**A** Center display

Turning the safe exit assist on/off.

**B** Outside rear view mirror indicators

When a vehicle or bicycle which may collide with a door (other than the back door) when opened is detected, the outside rear view mirror indicator on the detected side will illuminate. If the door on the detected side is open, or opening of the door is canceled, the outside rear view mirror indicator will blink.

**C** Meter

If collision with a door is likely and the door is opened or opening of the door is canceled, the door will be displayed on the multi-information display. Also, if a door is opened when an outside rear view mirror indicator is illuminated, a buzzer will sound as a warning.

**D** Driving assist information indicator

Illuminates when the safe exit assist is turned off. At this time, "Safe Exit Assist OFF" will be displayed on the multi-information display.

**E** Speakers

When the outside rear view mirror indicator blinks, the driver is informed through voice guidance that the system has operated. After the notification through voice guidance is made, no more voice guidance notifications will be made again until the door is fully closed.

**F** Door opener switch (manual release handle)

If a door opener switch is operated to open a door while the outside rear view mirror indicator on that side is illuminated, opening of the door will be canceled.

**■ Outside rear view mirror indicator visibility**

In strong sunlight, the outside rear view mirror indicator may be difficult to see.

**■ Buzzer**

If the volume setting of the audio system is high or the surrounding area is loud, it may be difficult to hear the buzzer.

**■ Voice notifications**

In the following situations, voice notifications will not be output:

- When it is estimated that no occupants are on board\*
- After opening a door and entering the vehicle, until the hybrid system is started
- When 3 minutes or more have elapsed since the hybrid system was stopped
- When the language setting of the center display has been set to a language that does not support voice notifications
- When all of the doors have been locked from outside the vehicle
- When a door remains open for 1 minute or more after the hybrid system is stopped
- When the ACC mode (→P.590) has been enabled through a customize setting on the center display and the hybrid system has been stopped
- When the parking assist volume setting on the center display has been set to off

\* : For each seating position, judgment is made based on the opening and closing of a door, before driving for ingress and after driving for egress.

**■ Opening of a door can be canceled when**

Opening of a door can be canceled only when the inside door opener switch is pushed in. Opening of a door will not be able to be canceled when the outside door opener switch is used.

**■ Customization**

Some functions can be customized.

(→P.590)



### WARNING

■ To ensure the system can operate properly

→P.319

## Turning the safe exit assist system ON/OFF

The safe exit assist can be enabled/dis-

abled on  of the center display.

(→P.590)

When the safe exit assist is off, the driving assist information indicator will illuminate. At this time, "Safe Exit Assist OFF" will be displayed on the multi-information display.

Each time the power switch is turned to ON, the safe exit assist is enabled.

## Safe exit assist operation

### ■ Objects that can be detected by the safe exit assist

When the safe exit assist detects the following vehicles or bicycles behind your vehicle using a rear side radar sensor, the occupants of the vehicle are informed through an outside rear view mirror indicator, buzzer, multi-information display, and voice notification.

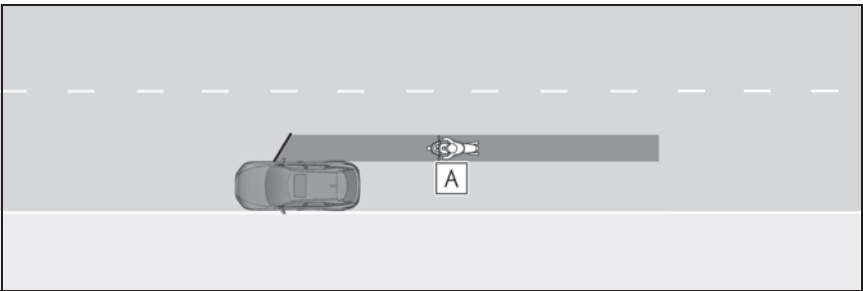

**A** Vehicle or bicycle which has a high possibility of colliding with a door (other than the back door) when opened

### ■ The safe exit assist detection areas

The areas that vehicles can be detected in are outlined below.

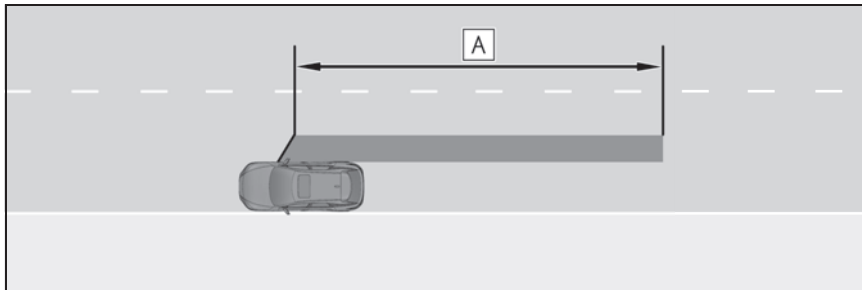

**A** Approximately 145 ft. (45 m) rearward from the front door<sup>\*</sup>

<sup>\*</sup>: The faster a vehicle or bicycle is approaching, the distance at which an outside rear view mirror indicator will illuminate or blink will become further.

#### ■ The safe exit assist is operational when

The safe exit assist is operational when all of the following conditions are met:

- When the power switch is ON, less than 3 minutes have elapsed since the hybrid system was off, or less than 3 minutes have elapsed since a door was opened and someone has entered the vehicle (the time which operation is possible may be extended if a door is opened and closed)
- Safe exit assist is on
- The vehicle is stopped.
- The shift position is in a position other than R.

#### ■ The safe exit assist will detect a vehicle when

The safe exit assist will detect a vehicle present in the detection area in the following situations:

- When the vehicle is stopped and a vehicle or bicycle, which is traveling parallel to the vehicle, is approaching within the area that a door opens (other than the back door)

#### ■ Conditions under which the system will not detect a vehicle

- Safe exit assist does not detect the following objects, vehicles, and bicycles:
  - Vehicles or bicycles which are approaching slowly<sup>\*</sup>
  - Vehicles or bicycles which are deter-

mined to have a low possibility of colliding with a door (other than the back door)

- when opened<sup>\*</sup>
- Vehicles or bicycles which are approaching from directly behind<sup>\*</sup>
- Vehicles or bicycles which are approaching from the front<sup>\*</sup>
- Guardrails, walls, signs, parked vehicles, and other stationary objects<sup>\*</sup>
- Pedestrians, animals, etc.<sup>\*</sup>

- In situations such as the following, safe exit assist will not operate:
  - When 3 minutes or more have elapsed since the hybrid system off (the time which operation is possible may be extended if a door is opened and closed)
  - When your vehicle is not completely stopped

<sup>\*</sup>: Depending on the conditions, detection of a vehicle and/or object may occur.

#### ■ Opening the doors when opening is canceled by the system

Perform the following operation to open a door.

After the approaching vehicle or bicycle passes or changes direction, check the surrounding area and press the inside door opener switch again. Perform the following only in an emergency, etc., to open a door while the warning is operating, after checking the safety of the area around your vehicle.

- Press and hold an inside door opener

switch for approximately 3 seconds or more

- Press an inside door opener switch quickly 3 times or more
- Pull a manual release handle

■ **Conditions under which the system may not function correctly**

● The safe exit assist may not detect vehicles correctly in the following situations:

- When the sensor is misaligned due to a strong impact to the sensor or its surrounding area
  - When mud, snow, ice, a sticker, etc. is covering the sensor or surrounding area on the rear bumper
  - When driving on a road surface that is wet with standing water during bad weather, such as heavy rain, snow, or fog
  - When a vehicle or bicycle approaches from behind a nearby parked vehicle
  - When an approaching vehicle or bicycle suddenly changes direction
  - Immediately after a vehicle or bicycle starts moving
  - When the back door is open
  - When a bicycle carrier, ramp, or other accessory is installed to the back of the vehicle
  - When a parked vehicle, wall, sign, person or other stationary object is behind the vehicle
  - When the vehicle is stopped at an angle to the road
  - When a vehicle is traveling near an approaching vehicle or bicycle
  - When an approaching vehicle or bicycle is traveling along a stationary object, such a wall or sign
  - When a vehicle or bicycle is approaching at high speed
  - When towing with the vehicle
  - When stopped on a steep slope
  - When stopped on a curve or at the exit of a curve
- Instances of the safe exit assist unnecessarily detecting a vehicle and/or object may increase in the following situations:
- When the sensor is misaligned due to a strong impact to the sensor or its surrounding area
  - When a vehicle or bicycle approaches from behind your vehicle at an angle

- When the vehicle is stopped at an angle to the road
- When a vehicle or bicycle approaches from behind a parked vehicle at an angle
- When a parked vehicle, wall, sign, person or other stationary object is behind the vehicle
- When an approaching vehicle or bicycle suddenly changes direction
- When an approaching vehicle or bicycle is traveling along a stationary object, such a wall or sign
- When the back door is open
- When a bicycle carrier, ramp, or other accessory is installed to the back of the vehicle
- When a vehicle or bicycle is approaching at high speed
- When towing with the vehicle
- When stopped on a steep slope
- When stopped on a curve or at the exit of a curve

## Intuitive parking assist\*

\*: If equipped

The distance from your vehicle to objects, such as a wall, when parallel parking or maneuvering into a garage is measured by the sensors and communicated via the center display and a buzzer. Always check the surrounding area when using this system.

### System components

#### ■ Types of sensors

► Except F SPORT models

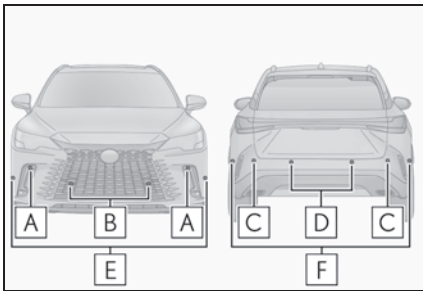

- A** Front corner sensors
- B** Front center sensors
- C** Rear corner sensors
- D** Rear center sensors
- E** Front side sensors (vehicles with Advanced Park)
- F** Rear side sensors (vehicles with Advanced Park)

► F SPORT models

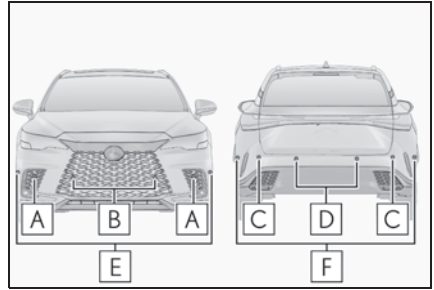

- A** Front corner sensors
- B** Front center sensors
- C** Rear corner sensors
- D** Rear center sensors
- E** Front side sensors (vehicles with Advanced Park)
- F** Rear side sensors (vehicles with Advanced Park)

#### ■ Display

When the sensors detect an object, such as a wall, a graphic is shown on the center display depending on the position and distance to the object.

For details regarding the center display, refer to the "MULTIMEDIA OWNER'S MANUAL".

Display example:

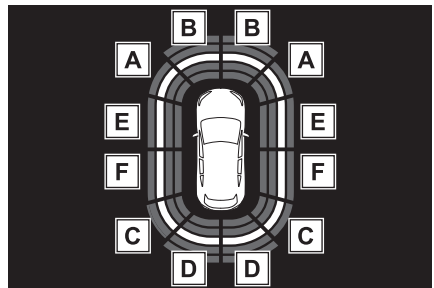

- A** Front corner sensor detection

- B** Front center sensor detection
- C** Rear corner sensor detection
- D** Rear center sensor detection
- E** Front side sensor detection (vehicles with Advanced Park)
- F** Rear side sensor detection (vehicles with Advanced Park)

### Turning intuitive parking assist on/off

The intuitive parking assist can be enabled/disabled on  of the center display. (→P.590)

When the intuitive parking assist function is disabled, the intuitive parking assist OFF indicator (→P.88) illuminates.

When turned off, the intuitive parking assist will be disabled and will not be enabled until the setting is changed to on again in center display.

If disabled using this method, the system will not be re-enabled by turning the power switch off and then to ON.



#### WARNING

##### ■ Cautions regarding the use of the system

There is a limit to the degree of recognition accuracy and control performance that this system can provide, do not overly rely on this system. The driver is always responsible for paying attention to the vehicle's surroundings and driving safely.

##### ■ To ensure the system can operate properly

Observe the following precautions. Failing to do so may result in the vehicle being unable to be driven safely and possibly cause an accident.

- Do not damage the sensors, and always keep them clean.
- Do not attach a sticker or install an electronic component, such as a backlit license plate (especially fluorescent type), fog lights, fender pole or wireless antenna near a radar sensor.
- Do not subject the surrounding area of the sensor to a strong impact. If subjected to an impact, have the vehicle inspected by your Lexus dealer. If the front or rear bumper needs to be removed/installed or replaced, contact your Lexus dealer.
- Do not modify, disassemble or paint the sensors.
- Do not attach a license plate cover.
- Keep your tires properly inflated.

##### ■ When to disable the function

In the following situations, disable the function as it may operate even though there is no possibility of a collision.

- Failing to observe the warnings above.
- A non-genuine Lexus suspension (lowered suspension, etc.) is installed.

##### ■ Notes when washing the vehicle

Do not apply intensive bursts of water or steam to the sensor area.

Doing so may result in the sensor malfunctioning.

- When using a high pressure washer to wash the vehicle, do not spray the sensors directly, as doing so may cause a sensor to malfunction.

**WARNING**

- When using steam to clean the vehicle, do not direct steam too close to the sensors as doing so may cause a sensor to malfunction.

---

**■ The system can be operated when**

- The power switch is ON.
- Intuitive parking assist function is on.
- The vehicle speed is less than about 6 mph (10 km/h).
- A shift position other than P is selected.

**■ If “Parking Assist Unavailable Sensor Blocked” is displayed on the multi-information display**

A sensor may be covered with water drops, ice, snow, dirt, etc.

Remove the water drops, ice, snow, dirt, etc., from the sensor to return the system to normal.

If a sensor is dirty, the position of the dirty sensor will be shown on the display.

Also, due to ice forming on a sensor at low temperatures, a warning message may be displayed or the sensor may not be able to detect an object. Once the ice melts, the system will return to normal.

If a warning message is displayed even if the sensor is clean, there may be a sensor malfunction. Have the vehicle inspected by your Lexus dealer.

**■ Sensor detection information**

- The sensor’s detection areas are limited to the areas around the vehicle’s front and rear bumpers.
- The following situations may occur during use.
  - Depending on the shape of the object and other factors, the detection distance may shorten, or detection may be impossible.
  - Detection may be impossible if static objects draw too close to the sensor.
  - There will be a short delay between static object detection and display (warning buzzer sounds). Even at low speeds,

there is a possibility that the object will come within 1.0 ft. (30 cm) before the display is shown and the warning buzzer sounds.

- It might be difficult to hear the buzzer due to the volume of the audio system or air flow noise of the air conditioning system.
- It may be difficult to hear the sound of this system due to the buzzers of other systems.

**■ Objects which the system may not be properly detected**

The shape of the object may prevent the sensor from detecting it. Pay particular attention to the following objects:

- Wires, fences, ropes, etc.
- Cotton, snow and other materials that absorb sound waves
- Sharply-angled objects
- Low objects
- Tall objects with upper sections projecting outwards in the direction of your vehicle

People may not be detected if they are wearing certain types of clothing.

**■ Situations in which the system may not operate properly**

Certain vehicle conditions and the surrounding environment may affect the ability of a sensor to correctly detect objects. Particular instances where this may occur are listed below.

- There is dirt, snow, water drops or ice on a sensor. (Cleaning the sensors will resolve this problem.)
- A sensor is frozen. (Thawing the area will resolve this problem.)  
In especially cold weather, if a sensor is frozen the sensor display may be displayed abnormally, or objects, such as a wall, may not be detected.
- When a sensor or the area around a sensor is extremely hot or cold.

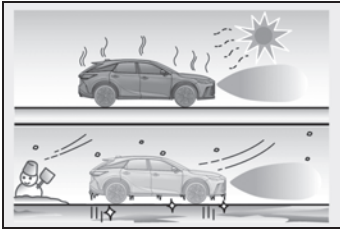

- On an extremely bumpy road, on an incline, on gravel, or on grass.
- When vehicle horns, vehicle detectors, motorcycle engines, air brakes of large vehicles, the clearance sonar of other vehicles or other devices which produce ultrasonic waves are near the vehicle
- A sensor is coated with a sheet of spray or heavy rain.
- If objects draw too close to the sensor.
- When a pedestrian is wearing clothing that does not reflect ultrasonic waves (ex. skirts with gathers or frills).
- When objects that are not perpendicular to the ground, not perpendicular to the vehicle traveling direction, uneven, or waving are in the detection range.
- Strong wind is blowing
- When driving in inclement weather such as fog, snow or a sandstorm
- When an object that cannot be detected is between the vehicle and a detected object
- If an object such as a vehicle, motorcycle, bicycle or pedestrian cuts in front of the vehicle or runs out from the side of the vehicle
- If the orientation of a sensor has been changed due to a collision or other impact
- When equipment that may obstruct a sensor is installed, such as a towing eyelet, bumper protector (an additional trim strip, etc.), bicycle carrier, or snow plow
- If the front of the vehicle is raised or lowered due to the carried load
- If the vehicle cannot be driven in a stable manner, such as when the vehicle has been in an accident or is malfunctioning

- When a tire chains or compact spare tire is used
- **Situations in which the system may operate even if there is no possibility of a collision**

In some situations, such as the following, the system may operate even though there is no possibility of a collision.

- When driving on a narrow road

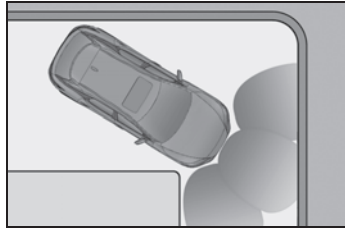

- When driving toward a banner, flag, low-hanging branch or boom barrier (such as those used at railroad crossings, toll gates and parking lots)
- When there is a rut or hole in the surface of the road
- When driving on a metal cover (grating), such as those used for drainage ditches
- When driving up or down a steep slope
- If a sensor is hit by a large amount of water, such as when driving on a flooded road
- There is dirt, snow, water drops or ice on a sensor. (Cleaning the sensors will resolve this problem.)
- A sensor is coated with a sheet of spray or heavy rain
- When driving in inclement weather such as fog, snow or a sandstorm
- When strong winds are blowing

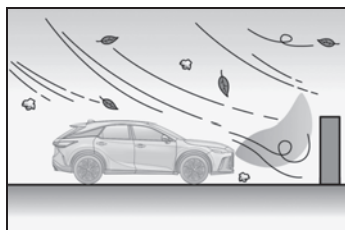

- When vehicle horns, vehicle detectors,

motorcycle engines, air brakes of large vehicles, the clearance sonar of other vehicles or other devices which produce ultrasonic waves are near the vehicle

- If the front of the vehicle is raised or lowered due to the carried load
- When towing a trailer
- If the orientation of a sensor has been changed due to a collision or other impact
- The vehicle is approaching a tall or curved curb
- Driving close to columns (H-shaped steel beams, etc.) in multi-story parking garages, construction sites, etc.
- If the vehicle cannot be driven in a stable manner, such as when the vehicle has been in an accident or is malfunctioning
- On an extremely bumpy road, on an incline, on gravel, or on grass

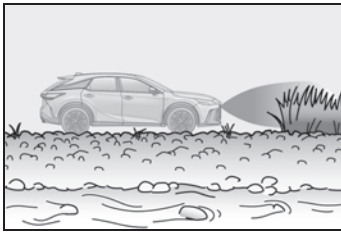

- When a tire chains or compact spare tire is used

## System detection range

### ■ Detection range of the sensors (vehicles without Advanced Park)

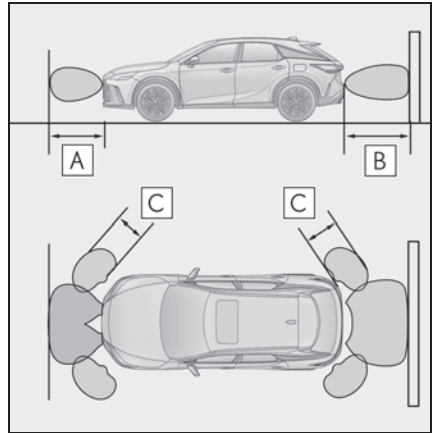

**A** Approximately 3.3 ft. (100 cm)

**B** Approximately 4.9 ft. (150 cm)

**C** Approximately 2.0 ft. (60 cm)

The diagram shows the detection range of the sensors. Note that the sensors cannot detect objects that are extremely close to the vehicle.

The range of the sensors may change depending on the shape of the object, etc.

### ■ Detection range of the sensors (vehicles with Advanced Park)

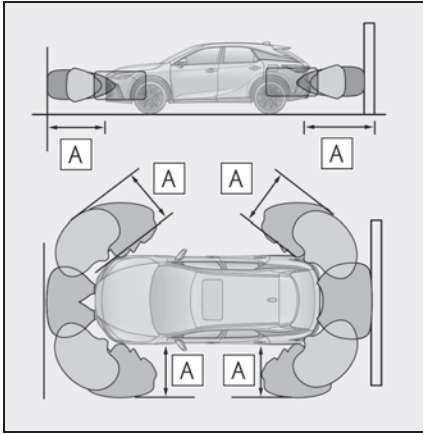

**A** Approximately 6.6 ft (200 cm)

The diagram shows the detection range of the sensors. Note that the sensors cannot detect objects that are extremely close to the vehicle.

The range of the sensors may change depending on the shape of the object, etc.

### ■ The distance and buzzer (vehicles without Advanced Park)

Approximate distance to obstacle	Buzzer
Front sensor: 3.3 ft. to 2.0 ft. (100 cm to 60 cm)* Rear sensor: 4.9 ft. to 2.0 ft. (150 cm to 60 cm)*	Slow
2.0 ft. to 1.5 ft. (60 cm to 45 cm)*	Medium
1.5 ft. to 1.0 ft. (45 cm to 30 cm)*	Fast
Less than 1.0 ft. (30 cm), Less than 0.5 ft. (15 cm)*	Continuous

\*: Automatic buzzer mute function is enabled. (→P.334)

### ■ The distance and buzzer (vehicles with Advanced Park)

Approximate distance to obstacle	Buzzer
Front center sensor: 6.6 ft. to 3.3 ft. (200 cm to 100 cm) Rear center sensor: 6.6 ft. to 4.9 ft. (200 cm to 150 cm) Side sensor: 6.6 ft. to 4.1 ft. (200 cm to 125 cm) Corner sensor: 6.6 ft. to 2.0 ft (200 cm to 60 cm)	Does not sound (Display only)
Front center sensor: 3.3 ft. to 2.0 ft. (100 cm to 60cm)* Rear center sensor: 4.9 ft. to 2.0 ft. (150 cm to 60 cm)* Side sensor: 4.1 ft. to 2.0 ft. (125 cm to 60 cm)*	Slow
2.0 ft. to 1.5 ft. (60 cm to 45 cm)*	Medium
1.5 ft. to 1.0 ft. (45 cm to 30 cm)*	Fast
Less than 1.0 ft. (30 cm), Less than 0.5 ft. (15 cm)*	Continuous

\* : Automatic buzzer mute function is enabled. (→P.334)

#### ■ Buzzer operation and distance to an object

A buzzer sounds when the sensors are operating.

- The buzzer beeps faster as the vehicle approaches an object.
- When the vehicle comes within approximately 1.0 ft (30 cm) of the object, the buzzer sounds continuously.
- When 2 or more sensors simultaneously detect a static object, the buzzer sounds for the nearest object.

- Even when the sensors are operating, the buzzer will be muted in some situations. (automatic buzzer mute function)

#### ■ Adjusting the buzzer volume

The buzzer volume can be adjusted on  of the center display. (→P.590)

#### ■ Muting a buzzer

A mute button will be displayed on the center display when an object is detected. To mute the buzzer, select a mute button.

The buzzers for the intuitive parking

assist, RCTA and RCD (if equipped) function will be muted simultaneously.

Mute will be canceled automatically in the following situations:

- When the shift position is shifted.
- When the vehicle speed exceeds a certain speed.
- When there is malfunction in a sensor or the system is temporarily unavailable.
- When the operating function is disabled manually.
- When the power switch is turned off.

### Object warning function (vehicles with Advanced Park)

The object warning function informs the driver of the existence of objects along the side of the vehicle, using a display and buzzer, if the objects are within the estimated path of the vehicle.

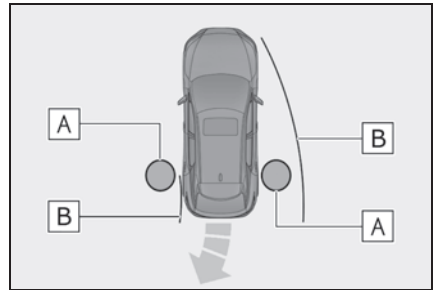

- A** Object
- B** Calculated vehicle route

When the vehicle is moving, the side sensors or side cameras can detect objects. While the vehicle is moving, if a detected object can no longer be detected by the side sensors or side cameras, the location of the object relative to the vehicle is estimated. If the object is determined to be in the estimated path of the vehicle, the object warning function will operate.

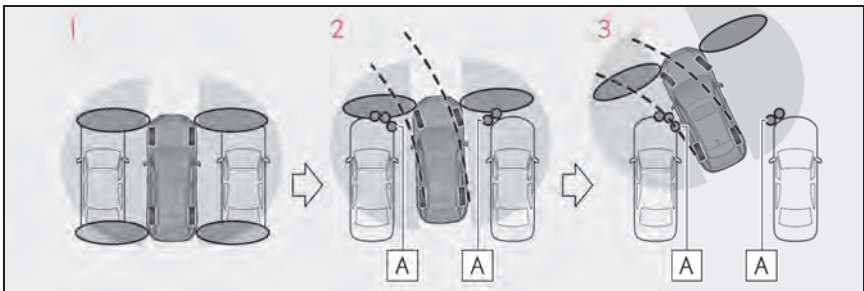

- A** Object detected by side sensors or side cameras

- 1 The vehicle is stopped and objects along the sides of the vehicle are not detected.
- 2 Objects are detected as the vehicle is moving.

- 3 Even though the objects are outside of the detection area of the side sensors or side cameras, a warning is displayed and a buzzer sounds.

#### ■ Object warning function operating conditions

The object warning function is operational when the intuitive parking assist OFF indicator is not illuminated or flashing and any of the following conditions is met:

- The Advanced Park is operating.
- The vehicle moves approximately 23.0 ft. (7 m) after the hybrid system is started.
- The R shift position is selected.
- After the D shift position has been selected, the vehicle has moved 23.0 ft. (7 m) or less.
- Camera switch has been pressed and the center display is displayed.
- The front or rear sensor detects a stationary object.

#### ■ Detection of objects along the sides of the vehicle

- Objects along the sides of the vehicle are not instantaneously detected. The location of objects in relation to the vehicle is estimated after they are first detected by the front or rear side sensors, or side cameras. Therefore, after the power switch is changed to ON, even if an object is along the side of the vehicle, it may not be detected until the vehicle has been driven a small amount and the side sensors or side cameras completely scan the areas along the sides of the vehicle.
- If a vehicle, person, animal, etc. is detected by a side sensor or side camera, but then leaves the detection area of the side sensor or side camera, the system will assume the object has not moved.

- When starting off shortly after the power switch is turned to ON and a small vehicle or other object which cannot be detected by a front side sensor is next to the vehicle.

In the situation shown in the following illustration, even if the vehicle starts off, as the vehicle on the left will not be detected and the object warning function will not operate.

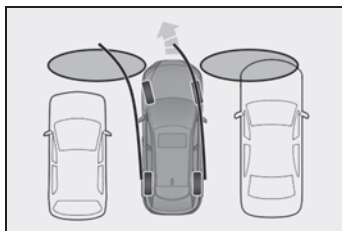

- When an object or person is in a position which cannot be detected by the side sensors or side cameras.
- When, after the side sensors or side cameras have completed scanning the areas along the sides of the vehicle, a vehicle, person, or other object approaches the side of the vehicle and cannot be detected.
- When the outside rear view mirror is closed, the side sensors or side cameras cannot detect objects.
- If the 12-volt battery was discharged or has been removed and installed, fold and extend the outside rear view mirrors.



#### WARNING

##### ■ Object warning function

In situations such as the following, the function may not operate correctly, possibly leading to an accident. Proceed carefully.

## RCTA (Rear cross traffic alert) function

The RCTA function uses the BSM rear side radar sensors installed behind the rear bumper. This function is intended to assist the driver in checking areas that are not easily visible when backing up.

### ⚠ WARNING

#### ■ Cautions regarding the use of the system

The driver is solely responsible for safe driving. Always drive safely, taking care to observe your surroundings. The RCTA function is only a supplementary function which alerts the driver that a vehicle is approaching from the right or left at the rear of the vehicle. As the RCTA function may not function correctly under certain conditions, the driver's own visual confirmation of safety is necessary. Over reliance on this function may lead to an accident resulting death or serious injury.

#### ■ To ensure the system can operate properly

→P.319

## System components

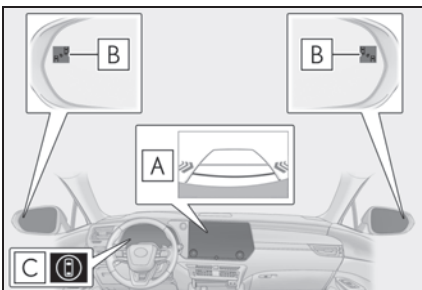

### A Center display

Turning the RCTA function on/off in center

display. If a vehicle approaching from the right or left at the rear of the vehicle is detected, the RCTA icon (→P.338) for the detected side will be displayed on the center display. This illustration\* shows an example of a vehicle approaching from both sides of the vehicle.

\*: Depending on the vehicle grade and equipped options, the actual screen may be different from this illustration.

### B Outside rear view mirror indicators

If a vehicle is detected as approaching from the left or right behind the vehicle, both outside rear view mirror indicators will blink and a buzzer will sound.

### C Driving assist information indicator

Illuminates when the RCTA is turned off. At this time, "Rear Cross Traffic Alert OFF" will be displayed on the multi-information display.

## Turning the RCTA function on/off

The RCTA can be enabled/disabled on  of the center display. (→P.590)

When the RCTA function is off, the driving assist information indicator (→P.88) will illuminate. At this time, "Rear Cross Traffic Alert OFF" will be displayed on the multi-information display. Each time the power switch is turned to ON, the RCTA function is enabled.

### ■ Outside rear view mirror indicator visibility

In strong sunlight, the outside rear view mirror indicator may be difficult to see.

### ■ Hearing the RCTA buzzer

The RCTA buzzer may be difficult to hear over loud noises, such as if the audio system volume is high.

### ■ Rear side radar sensors

→P.319

## RCTA function

### ■ Operation of the RCTA function

The RCTA function uses rear side radar sensors to detect vehicles approaching from the right or left at the rear of the vehicle and alerts the driver of the presence of such vehicles by flashing the outside rear view mirror indicators and sounding a buzzer.

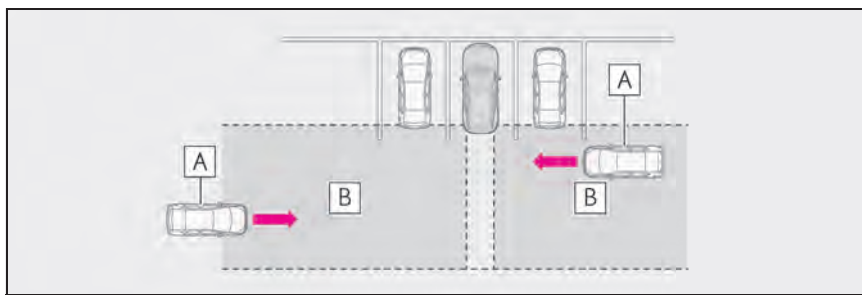

**A** Approaching vehicles

**B** Detection areas of approaching vehicles

### ■ RCTA icon display

When a vehicle approaching from the right or left at the rear of the vehicle is detected, the following will be displayed on the center display.

- Example (Panoramic view monitor) (if equipped): Vehicles are approaching from both sides of the vehicle

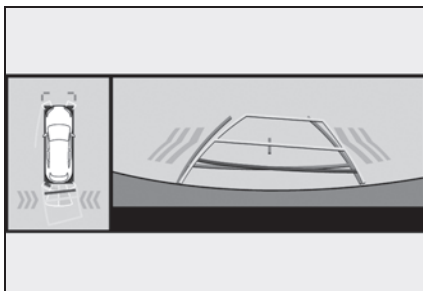

### ■ RCTA function detection areas

The areas that vehicles can be detected in are outlined below.

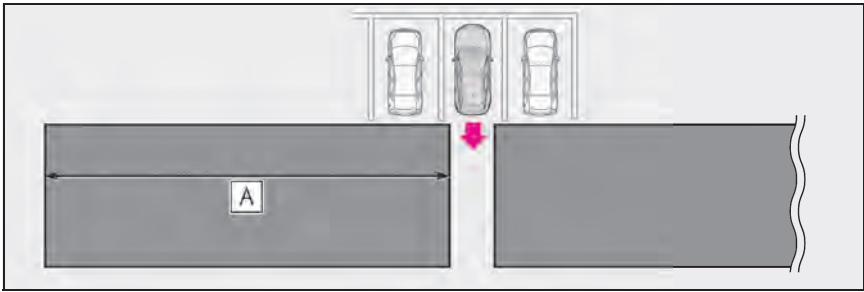

The buzzer can alert the driver of faster vehicles approaching from farther away.

Example:

Approaching vehicle speed	<b>A</b> Approximate alert distance
34 mph (56 km/h) (fast)	131 ft. (40 m)
5 mph (8 km/h) (slow)	18 ft. (5.5 m)

#### ■ The RCTA function is operational when

The RCTA function operates when all of the following conditions are met:

- The power switch is ON.
- The RCTA function is on.
- The shift position is in R.
- The vehicle speed is less than approximately 9 mph (15 km/h).
- The approaching vehicle speed is between approximately 5 mph (8 km/h) and 34 mph (56 km/h).

#### ■ Setting the buzzer volume

The buzzer volume of the RCTA, intuitive parking assist (if equipped) and RCD (if equipped) can be adjusted all together on

 of the center display. (→P.590)

#### ■ Muting a buzzer temporarily

When an object is detected, the temporary mute switch is displayed on the center display. Select the switch to mute the buzzer of the intuitive parking assist (if equipped),

RCTA, and RCD (if equipped) all together.

Mute will be canceled automatically in the following situations:

- When the shift position is shifted.
- When the vehicle speed exceeds a certain speed.
- When there is a malfunction in a sensor or the system is temporarily unavailable.
- When the operating function is disabled manually.
- When the power switch is turned off.

#### ■ Conditions under which the system will not detect a vehicle

The RCTA function is not designed to detect the following types of vehicles and/or objects:

- Vehicles approaching from directly behind
- Vehicles backing up in a parking space next to your vehicle
- Vehicles that the sensors cannot detect due to obstructions

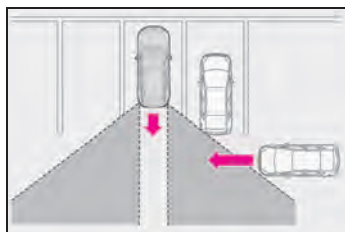

- Guardrails, walls, signs, parked vehicles and similar stationary objects\*
- Small motorcycles, bicycles, pedestrians, etc.\*
- Vehicles moving away from your vehicle

- Vehicles approaching from the parking spaces next to your vehicle\*
- The distance between the sensor and approaching vehicle gets too close

\* : Depending on the conditions, detection of a vehicle and/or object may occur.

### ■ Situations in which the system may not operate properly

The RCTA function may not detect vehicles correctly in the following situations:

- When the sensor is misaligned due to a strong impact to the sensor or its surrounding area
- When mud, snow, ice, a sticker, etc., is covering the sensor or surrounding area on the position above the rear bumper
- When driving on a road surface that is wet with standing water during bad weather, such as heavy rain, snow, or fog
- When multiple vehicles are approaching with only a small gap between each vehicle
- When a vehicle is approaching at high speed
- When equipment that may obstruct a sensor is installed, such as a towing eyelet, bumper protector (an additional trim strip, etc.), bicycle carrier, or snow plow
- When backing up on a slope with a sharp change in grade

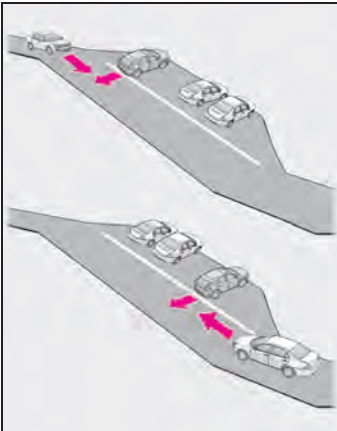

- When backing out of a sharp angle parking spot

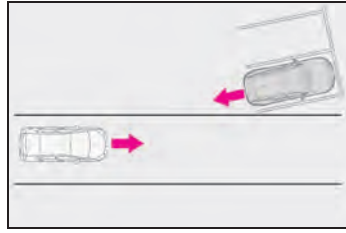

- Immediately after the RCTA function is turned on
- Immediately after the hybrid system is started with the RCTA function on
- When the sensors cannot detect a vehicle due to obstructions
- When towing a trailer
- When there is a significant difference in height between your vehicle and the vehicle that enters the detection area
- When a sensor or the area around a sensor is extremely hot or cold
- If the suspension has been modified or tires of a size other than specified are installed
- If the front of the vehicle is raised or lowered due to the carried load
- When turning while backing up

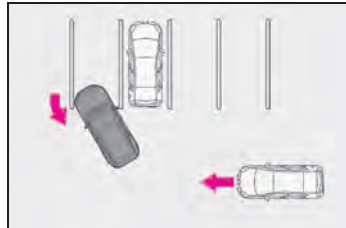

- When a vehicle turns into the detection area



■ **Situations in which the system may operate even if there is no possibility of a collision**

Instances of the RCTA function unnecessarily detecting a vehicle and/or object may increase in the following situations:

- When the parking space faces a street and vehicles are being driven on the street

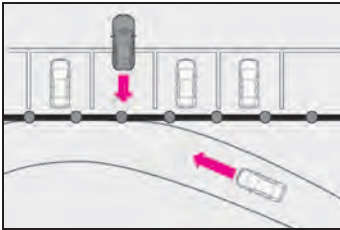

- When the distance between your vehicle and metal objects, such as a guardrail, wall, sign, or parked vehicle, which may reflect electrical waves toward the rear of the vehicle, is short



- When equipment that may obstruct a sensor is installed, such as a towing eyelet, bumper protector (an additional trim strip, etc.), bicycle carrier, or snow plow
- When a vehicle passes by the side of your vehicle



- When a detected vehicle turns while approaching the vehicle

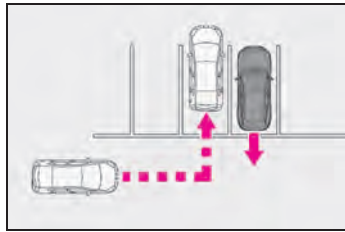

- When there are spinning objects near your vehicle such as the fan of an air conditioning unit
- When water is splashed or sprayed toward the rear bumper, such as from a sprinkler
- Moving objects (flags, exhaust fumes, large rain droplets or snowflakes, rain water on the road surface, etc.)
- When the distance between your vehicle and a guardrail, wall, etc., that enters the detection area is short
- Gratings and gutters
- When a sensor or the area around a sensor is extremely hot or cold
- If the suspension has been modified or tires of a size other than specified are installed
- If the front of the vehicle is raised or lowered due to the carried load

## RCD (Rear Camera Detection) function\*

\*: If equipped

When the vehicle is backing up, the rear camera detection function can detect pedestrians in the detection area behind the vehicle. If a pedestrian is detected, a buzzer will sound and an icon will be displayed on the center display to inform the driver of the pedestrian.



### WARNING

#### ■ Cautions regarding the use of the system

The recognition and control capabilities for this system are limited.

The driver should always drive safely by always being responsible without over-relying on the system and have a understanding of the surrounding situations.

#### ■ To ensure the system can operate properly

Observe the following, otherwise there is the danger that could lead to an accident.

- Always clean the camera with damaging it.
- Do not install market electronic parts (such as illuminated license plate, fog lamps, etc.) in the camera vicinity.
- Do not subject the camera vicinity to strong impacts. If the vicinity is subjected to a strong impact, have the vehicle inspected at your Lexus dealer.
- Do not disassemble, remodel or paint the camera.
- Do not attach accessories or stickers to the camera.

- Do not install market protection parts (bumper trim, etc.) to the rear bumper.
- Maintain suitable tire air pressure.
- Make sure the back door is completely closed.

#### ■ RCD function is turned off

In the following situations the system turns off. The RCD function may not operate properly and thus there is the danger that an accident may occur.

- The contents mentioned above are not observed.
- Suspensions other than genuine parts are installed.

## RCD display

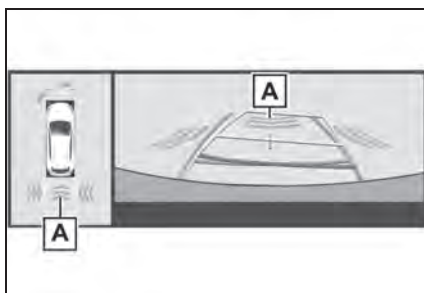

### A Pedestrian detection icon

Displayed automatically when a pedestrian is detected.

## Turning the RCD function on/off

The RCD can be enabled/disabled on  of the center display. (→P.590)

When the RCD function is off, the driving assist information indicator (→P.88) will illuminate. At this time, the message will be displayed on the multi-information display.

Each time the power switch is turned to ON, the RCD function is enabled.

### When a pedestrian is detected

If the rear camera detection function detects a pedestrian in the detection area, the buzzer and pedestrian detection will operate as follows:

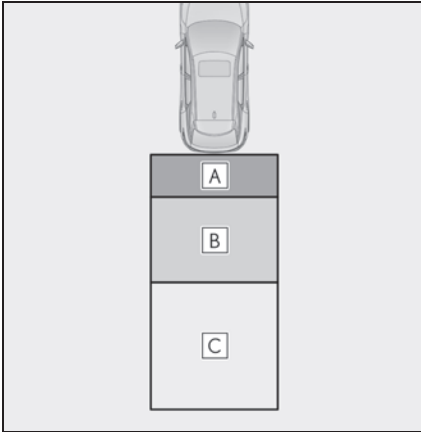

**A** If a pedestrian is detected in area

**A**

Buzzer: Sounds repeatedly  
Pedestrian detection icon: Blinks

**B** If a pedestrian is detected in area

**B**

Buzzer (When the vehicle is stationary): Sounds 3 times  
Buzzer (When the vehicle is backing up, when a pedestrian approaches the rear of the vehicle): Sounds repeatedly  
Pedestrian detection icon: Blinks

**C** If the system determines that your vehicle may collide with a pedestrian in area **C**

Buzzer: Sounds repeatedly

Pedestrian detection icon: Blinks

#### ■ The rear camera detection function is operational when

- The power switch is in ON.
- RCD function is on.
- The shift position is in R.
- Advanced Park (if equipped) is not operating

#### ■ Setting the buzzer volume

The buzzer volume can be adjusted on the center display.

The buzzer volume of the intuitive parking assist (if equipped), RCTA and RCD can be adjusted all together on  of the center display. (→P.590)

#### ■ Muting a buzzer temporarily

When an object is detected, the temporary mute (  ) switch is displayed on the center display. Select the switch to mute the buzzer of the intuitive parking assist (if equipped), RCTA, and RCD all together.

The buzzers for the intuitive parking assist, RCTA and RCD function will be muted simultaneously.

Mute will be canceled automatically in the following situations:

- When the shift position is shifted.
- When the vehicle speed exceeds a certain speed.
- When there is a malfunction in a sensor or the system is temporarily unavailable.
- When the operating function is disabled manually.
- When the power switch is turned off.

#### ■ Situations in which the system may not operate properly

- Some pedestrians, such as the following, may not be detected by the rear camera detection function, preventing the function from operating properly:
  - Pedestrians who are bending forward or squatting
  - Pedestrians who are lying down
  - Pedestrians who are running

- Pedestrians who suddenly enter the detection area
- People riding a bicycle, skateboard, or other light vehicle
- Pedestrians wearing oversized clothing such as a rain coat, long skirt, etc., making their silhouette obscure
- Pedestrians whose body is partially hidden by an object, such as a cart or umbrella
- Pedestrians which are obscured by darkness, such as at night
- In some situations, such as the following, pedestrians may not be detected by the rear camera detection function, preventing the function from operating properly:
  - When backing up in inclement weather (rain, snow, fog, etc.)
  - When the rear camera is obscured (dirt, snow, ice, etc. are attached) or scratched
  - When a very bright light, such as the sun, or the headlights of another vehicle, shines directly into the rear camera
  - When backing up in a place where the surrounding brightness changes suddenly, such as at the entrance or exit of a garage or underground parking lot
  - When backing up in a dim environment such as during dusk or in an underground parking lot
  - When the camera position and direction are deviated
  - When a towing hook is attached
  - When towing with the vehicle
  - When water droplets are flowing on the camera lens
  - When the vehicle height is extremely changed (nose up, nose down)
  - When a tire chains, compact spare tire or an emergency tire puncture repair kit is used
  - If the suspension has been modified or tires of a size other than specified are installed
  - When install market electronic parts (such as illuminated license plate, fog lamps, etc.) in the camera vicinity
  - If a bumper protector, such as an additional trim strip, is installed to the rear bumper
- **Situations in which the system may operate unexpectedly**
  - Even though there are no pedestrians in the detection area, some objects, such as the following, may be detected, possibly causing the rear camera detection function to operate.
    - Three dimensional objects, such as a pole, traffic cone, fence, or parked vehicle
    - Moving objects, such as a car or motorcycle
    - Objects moving toward your vehicle when backing up, such as flags or puddles (or airborne matter, such as smoke, steam, rain, or snow)
    - Cobblestone or gravel roads, tram rails, road repairs, white lines, pedestrian crossings or fallen leaves on the road
    - Metal covers (gratings), such as those used for drainage ditches
    - Objects reflected in a puddle or on a wet road surface
    - Shadows on the road
  - In some situations, such as the following, the rear camera detection function may operate even though there are no pedestrians in the detection area.
    - When backing up toward the roadside or a bump on the road
    - When backing up toward an incline/decline
    - If the rear of the vehicle is raised or lowered due to the carried load
    - When install market electronic parts (such as illuminated license plate, fog lamps, etc.) in the camera vicinity
    - If a bumper protector, such as an additional trim strip, is installed to the rear bumper
    - If the orientation of the rear camera has been changed
    - If a towing eyelet is installed to the rear of the vehicle
    - When towing with the vehicle
    - When water is flowing over the rear camera lens
    - When the rear camera is obscured (dirt, snow, ice, etc. are attached) or scratched
    - If there is a flashing light in the detection area, such as the emergency flashers of another vehicle
    - When a tire chains or an emergency tire puncture repair kit is used
  - Situations in which the rear camera detection function may be difficult to

- notice
- The buzzer may be difficult to hear if the surrounding area is noisy, the volume of the audio system volume is high, the air conditioning system is being used, etc.
- If the temperature in the cabin is extremely high or low, the audio system screen may not operate correctly.

### PKSB (Parking Support Brake)\*

\*: If equipped

The PKSB (Parking Support Brake) system consists of the following functions that operate when driving at a low speed or backing up, such as when parking. When the system determines that a collision with a detected object or pedestrian is high, a warning operates to urge the driver to take evasive action. If the system determines that the possibility of a collision with a detected object or pedestrian is extremely high, the brakes are automatically applied to help avoid the collision or help reduce the impact of the collision.

### PKSB (Parking Support Brake) system

The system can detect the following as detectable objects. (Detectable objects differ depending on the function.)

- Static Objects Front and Rear of the vehicle (→P.350)
- Moving Vehicles Rear of the Vehicle (→P.352)
- Pedestrians Rear of the Vehicle (→P.353)
- Static Objects Around the vehicle (vehicles with Advanced Park) (→P.354)

**WARNING****■ Cautions regarding the use of the system**

Do not overly rely on the system, as doing so may lead to an accident. Always drive while checking the safety of the surroundings of the vehicle.

Depending on the vehicle and road conditions, weather, etc., the system may not operate.

The detection capabilities of sensors, radars and camera are limited. Always drive while checking the safety of the surroundings of the vehicle.

- The driver is solely responsible for safe driving. Always drive carefully, taking care to observe your surroundings. The PKSB (Parking Support Brake) system is designed to provide support to lessen the severity of collisions. However, it may not operate in some situations.
- The PKSB (Parking Support Brake) system is not designed to stop the vehicle completely. Additionally, even if the system has stopped the vehicle, it is necessary to depress the brake pedal immediately as brake control will be canceled after approximately 2 seconds.
- It is extremely dangerous to check the system operations by intentionally driving the vehicle into the direction of a wall, etc. Never attempt such actions.

**■ When to disable the PKSB (Parking Support Brake) system**

In the following situations, disable the PKSB (Parking Support Brake) as the system may operate even though there is no possibility of a collision.

- When inspecting the vehicle using a chassis roller, chassis dynamo or free roller

- When loading the vehicle onto a boat, truck or other transport vessel
- If the suspension has been modified or tires of a size other than specified are installed
- If the front of the vehicle is raised or lowered due to the carried load
- When equipment that may obstruct a sensor is installed, such as a towing eyelet, bumper protector (an additional trim strip, etc.), bicycle carrier, or snow plow
- When using automatic car washing devices
- If the vehicle cannot be driven in a stable manner, such as when the vehicle has been in an accident or is malfunctioning
- When the vehicle is driven in a sporty manner or off-road
- When the tires are not properly inflated
- When the tires are very worn
- When a tire chains or compact spare tire is used
- When your vehicle is towing a trailer or during emergency towing

**■ Precautions for the suspension**

Do not modify the suspension of the vehicle. If the height or tilt of the vehicle is changed, the sensors may not be able to detect detectable objects and the system may not operate correctly, possibly leading to an accident.

**Enabling/Disabling the PKSB (Parking Support Brake)**

The PKSB (Parking Support Brake) can be enabled/disabled on  of the center display. (→P.590)

When the PKSB (Parking Support Brake) function is off, the driving assist information indicator (→P.88) will illuminate and a message will be displayed on the multi-information display.

When turned OFF (disabled), the PKSB (Parking Support Brake) will be disabled and will not be enabled until the setting is changed to ON again in center display. (The function will not be reenabled by operating the power switch.)

### PKSB (Parking Support Brake) displays and buzzers

If the hybrid system output restriction control or brake control operates, a buzzer will sound and a message will be displayed on the multi-information display and center display to alert the driver.

Depending on the situation, hybrid system output restriction control will operate to either limit acceleration or restrict output as much as possible.

- Hybrid system output restriction control is operating (acceleration restriction)

Acceleration greater than a certain amount is restricted by the system.

Center display: No warning displayed

Multi-information display: "Object Detected Acceleration Reduced"

Driving assist information indicator: Not illuminated

Buzzer: Does not sound

- Hybrid system output restriction control is operating (output restricted as much as possible)

The system has determined that stronger-than-normal brake operation is necessary.

Center display/multi-information display: A display urging to operate the brakes

Driving assist information indicator: Not illuminated

Buzzer: Short beep

- Brake control is operating

The system determined that emergency braking is necessary.

Center display/multi-information display: A display urging to operate the brakes

Driving assist information indicator: Not illuminated

Buzzer: Short beep

- Vehicle stopped by system operation

The vehicle has been stopped by brake control operation.

Center display: "Press Brake Pedal"

Multi-information display: "Switch to Brake" (If the accelerator pedal is not depressed, "Press Brake Pedal" will be displayed.)

Driving assist information indicator: Illuminated

Buzzer: Sounds repeatedly

### System overview

If the PKSB (Parking Support Brake) determines that a collision with a detected object or pedestrian is possible, the hybrid system output will be restricted to restrain any increase in the vehicle speed. (Hybrid system output restriction con-

trol: See figure 2.)

Additionally, if the accelerator pedal continues to be depressed, the brakes will be applied automatically to reduce the vehicle speed. (Brake control: See figure 3.)

- Figure 1 When the PKSB (Parking Support Brake) is not operating

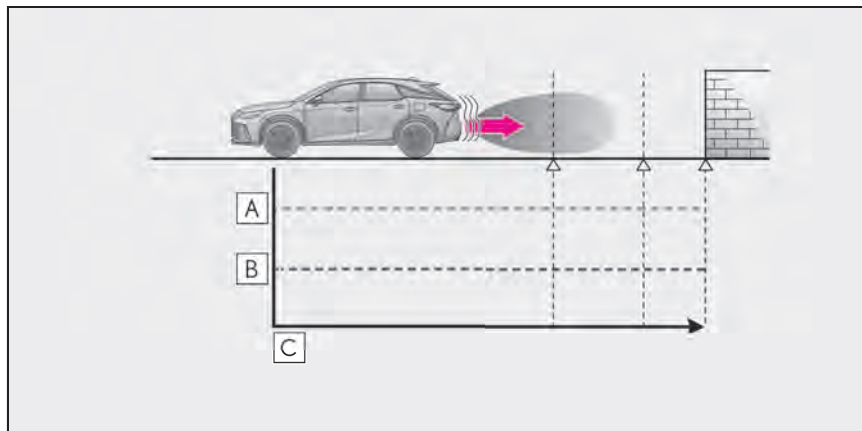

**A**] Hybrid system output

**B**] Braking force

**C**] Time

- Figure 2 When hybrid system output restriction control operates

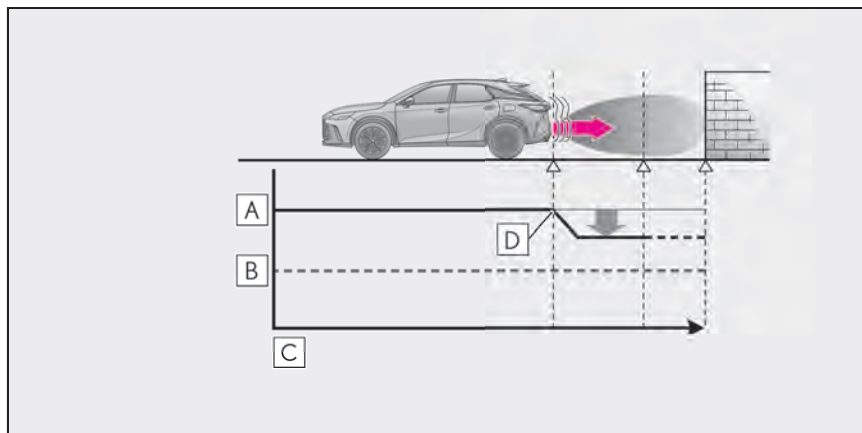

**A**] Hybrid system output

**B**] Braking force

**C**] Time

**D**] Hybrid system output restriction control begins operating (System determines

that possibility of collision with detected object is high)

● Figure 3 When brake control operates

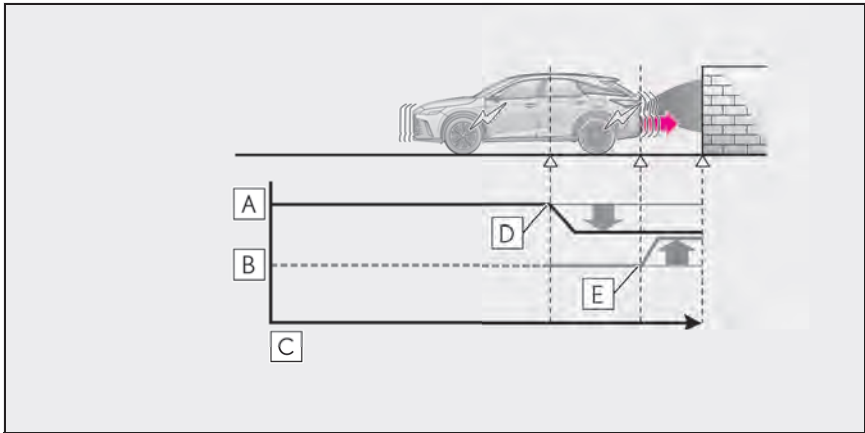

**A** Hybrid system output

**B** Braking force

**C** Time

**D** Hybrid system output restriction control begins operating (System determines that possibility of collision with detected object is high)

**E** Brake control begins operating (System determines that possibility of collision with detected object is extremely high)

■ If the PKSB (Parking Support Brake) has operated

If the vehicle is stopped due to operation of the PKSB (Parking Support Brake), the PKSB (Parking Support Brake) will be disabled and the driving assist information indicator will illuminate. If the PKSB (Parking Support Brake) operates unnecessarily, brake control can be canceled by depressing the brake pedal or waiting for approximately 2 seconds for it to automatically be canceled. Then, the vehicle can be operated by depressing the accelerator pedal.

■ Re-enabling the PKSB (Parking Support Brake) system

To re-enable the PKSB (Parking Support Brake) when it has been disabled due to operation of the PKSB (Parking Support Brake), either enable the system again (→P.346), or turn the power switch off and

then back to ON.

Additionally, if any of the following conditions are met, the system will be re-enabled automatically and the driving assist information indicator will turn off:

- The P shift position is selected
- The object is no longer detected in the traveling direction of the vehicle
- The traveling direction of the vehicle changes

## Static Objects Front and Rear of the vehicle

If the sensors detect a static object, such as a wall, in the travelling direction of the vehicle and the system determines that a collision may occur due to the vehicle suddenly moving forward due to an accidental accelerator pedal operation, the vehicle moving the unintended direction due to the wrong shift position, or while parking or traveling at low speeds, the system will operate to lessen the impact with the detected static object and reduce the resulting damage.

The system operates in the following situations when a static object is detected in the traveling direction of the vehicle.

- **When traveling at a low speed and the brake pedal is not depressed, or is depressed late**

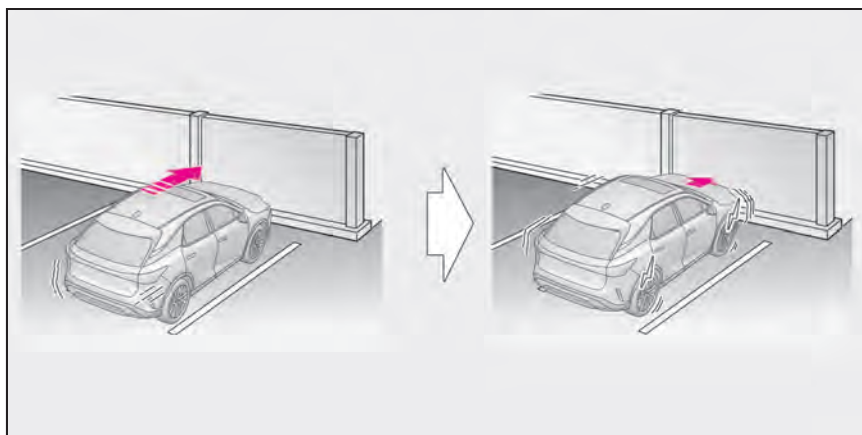

- **When the accelerator pedal is depressed excessively**

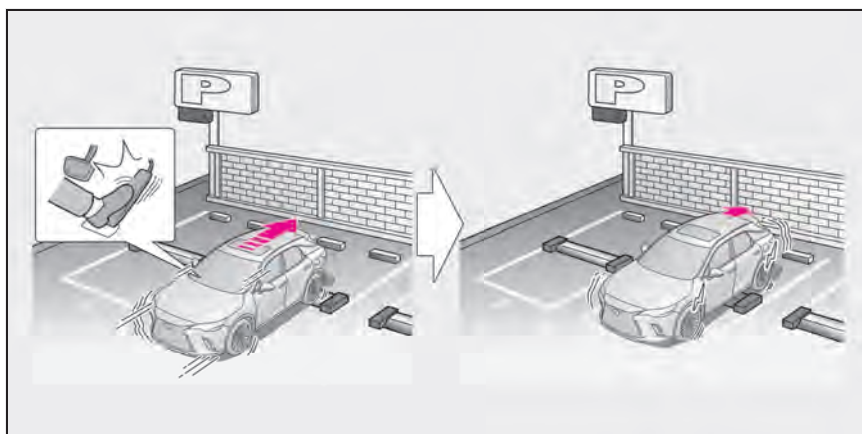

## ■ When the vehicle moves in the unintended direction due to the wrong shift position

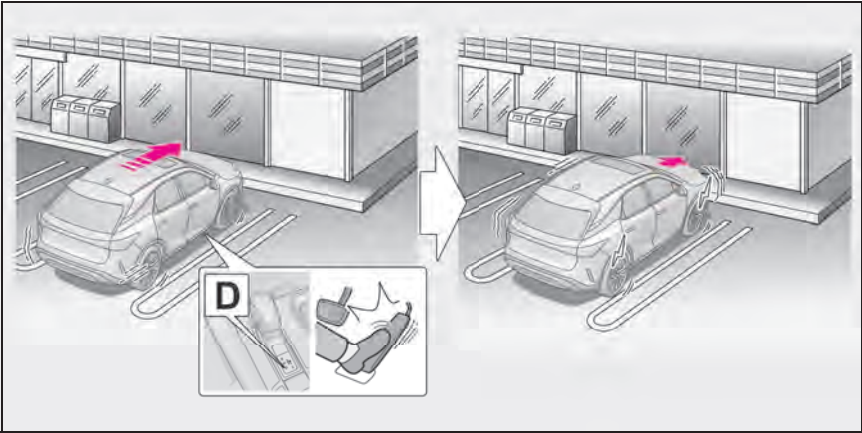

### ■ Types of sensors

→P.328

#### **!** WARNING

■ To ensure the system can operate properly

→P.329

■ If the system operates unnecessarily, such as at a railroad crossing

→P.349

■ Notes when washing the vehicle

→P.329

### ■ The system will operate when

The function will operate when the driving assist information indicator is not illuminated (→P.87, 522) and all of the following conditions are met:

- Hybrid system output restriction control
- PKSB (Parking Support Brake) system is enabled.
- The vehicle speed is approximately 9 mph (15 km/h) or less.
- There is a static object in the traveling direction of the vehicle and approximately 6 to 13 ft. (2 to 4 m) away.

- The PKSB (Parking Support Brake) determines that a stronger-than-normal brake operation is necessary to avoid a collision.

- Brake control
- Hybrid system output restriction control is operating.
- The PKSB (Parking Support Brake) determines that an immediate brake operation is necessary to avoid a collision.

### ■ The system will stop operating when

The function will stop operating if any of the following conditions are met:

- Hybrid system output restriction control
- PKSB (Parking Support Brake) system is disabled.
- The system determines that the collision has become avoidable with normal brake operation.
- The static object is no longer approximately 6 to 13 ft. (2 to 4 m) away from the vehicle or in the traveling direction of the vehicle.
- Brake control
- PKSB (Parking Support Brake) system is disabled.
- Approximately 2 seconds have elapsed since the vehicle was stopped by brake control.
- The brake pedal is depressed after the vehicle is stopped by brake control.

- The static object is no longer approximately 6 to 13 ft. (2 to 4 m) away from the vehicle or in the traveling direction of the vehicle.

■ **Situations in which the system may not operate properly**

→P.330

■ **Situations in which the system may operate even if there is no possibility of a collision**

→P.331

## Moving Vehicles Rear of the Vehicle

If a rear radar sensor detects a vehicle approaching from the right or left at the rear of the vehicle and the system determines that the possibility of a collision is high, this function will perform brake control to reduce the likelihood of an impact with the approaching vehicle.

This function will operate in situations such as the following if a vehicle is detected in the traveling direction of the vehicle.

- **When reversing, a vehicle is approaching and the brake pedal is not depressed, or is depressed late**

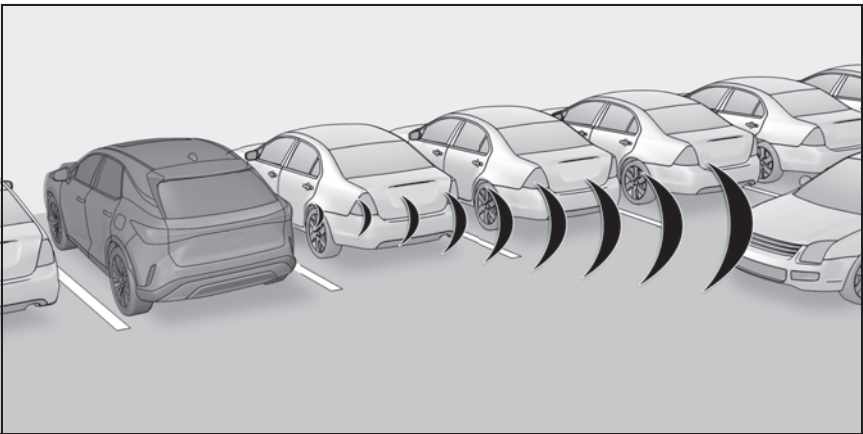

■ **Types of sensors**

→P.319



**WARNING**

- **To ensure the system can operate properly**

→P.319

■ **The system will operate when**

The function will operate when the driving assist information indicator is not illuminated (→P.87, 522) and all of the following conditions are met:

- Hybrid system output restriction control
- PKSB (Parking Support Brake) system is enabled.
- The vehicle speed is approximately 9 mph (15 km/h) or less.
- Vehicles which are approaching from the

right or left at the rear of the vehicle at a traveling speed of approximately 5 mph (8 km/h) or more.

- The shift position is in R.
- The PKSB (Parking Support Brake) determines that a stronger than normal brake operation is necessary to avoid a collision.
- Brake control
- Hybrid system output restriction control is operating.
- The PKSB (Parking Support Brake) determines that an emergency brake operation is necessary to avoid a collision with an approaching vehicle.

#### ■ The system will stop operating when

The function will stop operating if any of the following conditions are met:

- Hybrid system output restriction control
- PKSB (Parking Support Brake) system is disabled.

- The collision becomes avoidable with normal brake operation.
- A vehicle is no longer approaching from the right or left at the rear of the vehicle.
- Brake control
- PKSB (Parking Support Brake) system is disabled.
- Approximately 2 seconds have elapsed since the vehicle was stopped by brake control.
- The brake pedal is depressed after the vehicle is stopped by brake control.

#### ■ Situations in which the system may not operate properly

→P.340

#### ■ Situations in which the system may operate even if there is no possibility of a collision

→P.341

## Pedestrians Rear of the Vehicle

If the rear camera sensor detects a pedestrian behind the vehicle while backing up and the system determines that the possibility of colliding with the detected pedestrian is high, a buzzer will sound. If the system determines that the possibility of colliding with the detected pedestrian is extremely high, the brakes will be applied automatically to help reduce the impact of the collision.

When a pedestrian is detected behind the vehicle while backing up, the brake pedal is not depressed or is depressed late.

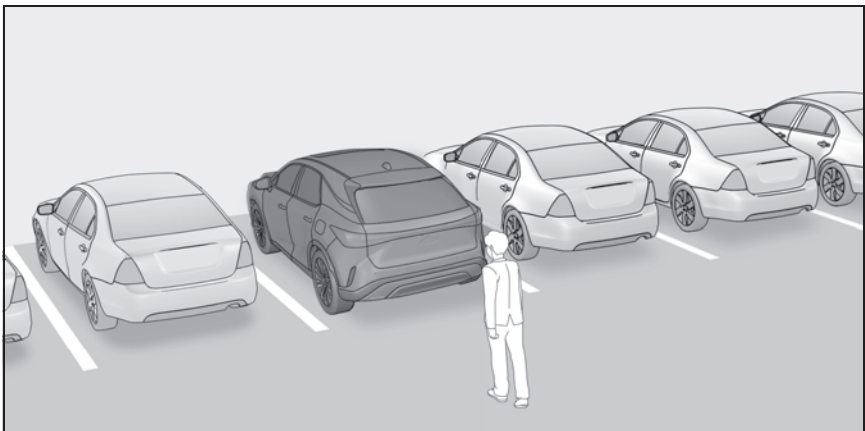

### ■ Center display

Displays a message to urge the driver to take evasive action when a pedestrian is detected in the detection area behind the vehicle.

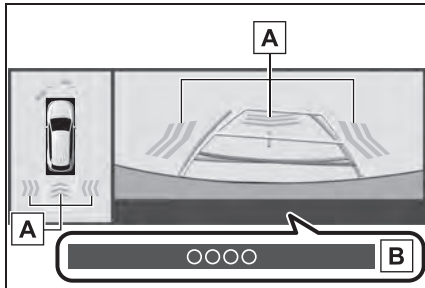

**A** Pedestrian detection icon

**B** Brake reminder

### ⚠ WARNING

#### ■ If the system operates unnecessarily

Depress the brake pedal immediately after the system operates. (Operation of the function is canceled by depressing the brake pedal.)

#### ■ Correct use of the system

→P.342

### ■ The system will operate when

The function will operate when the driving assist information indicator is not illuminated (→P.87, P.522) and all of the following conditions are met:

- Hybrid system output restriction control
- PKSB (Parking Support Brake) system is enabled.

- The vehicle speed is 9 mph (15 km/h) or less.
- The shift position is in R.
- A pedestrian is behind the vehicle.
- The system determines that a slightly stronger brake operation than usual is needed to avoid a collision.

### ● Brake control

- Hybrid system output restriction control is operating.
- The PKSB (Parking Support Brake) determines that an emergency brake operation is necessary to avoid a collision with a pedestrians.

### ■ The system will stop operating when

The function will stop operating if any of the following conditions are met:

- Hybrid system output restriction control
- PKSB (Parking Support Brake) system is disabled.
- The collision becomes avoidable with normal brake operation.
- The pedestrian is no longer detected behind your vehicle.
- Brake control
- PKSB (Parking Support Brake) system is disabled.
- Approximately 2 seconds have elapsed since the vehicle was stopped by brake control.
- The brake pedal is depressed after the vehicle is stopped by brake control.

### ■ Re-enabling the system

→P.349

### ■ Situations in which the system may not operate properly

→P.343

### ■ Situations in which the system may operate unexpectedly

→P.344

## Static Objects Around the vehicle (vehicles with Advanced Park)

While parking, if a sensor detects a surrounding stationary object, such as a wall, with which a collision is likely, the system will operate to help avoid a collision or reduce the impact of the collision.

The system will operate in the following situations when a stationary object is detected in the surrounding area.

- When moving forward and a collision with a stationary object on the inner side of a turn is likely

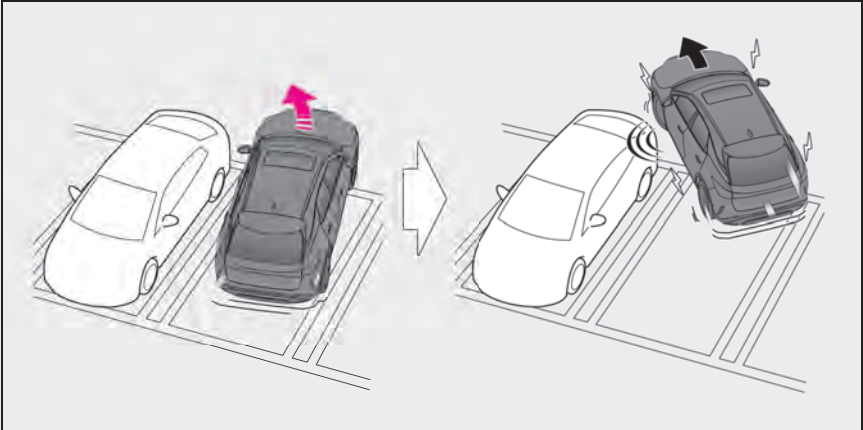

- When reversing and a collision with a stationary object on the outer side of a turn is likely

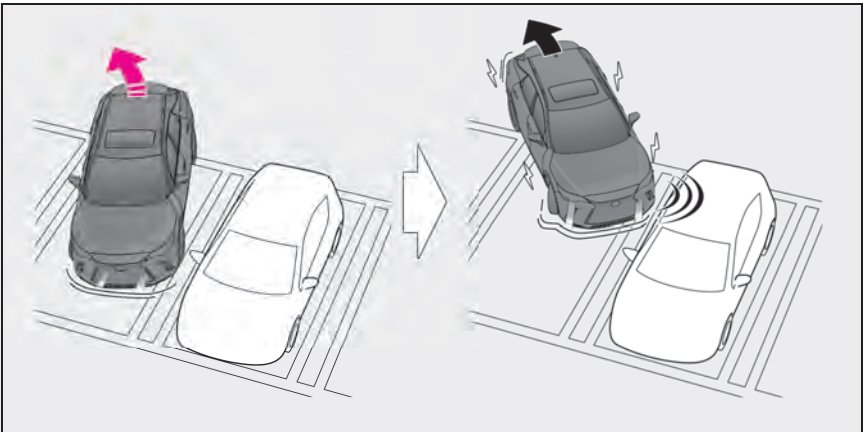

#### ■ Operating conditions

This function is operable when any of the following conditions are met in addition to the operating conditions for stationary objects in around the vehicle.

- After the engine has been started, the vehicle has moved approximately 23.0 ft (7 m) or less

- The R shift position is selected
- After the shift position has been shifted from R to D, the vehicle has moved approximately 23.0 ft (7 m) or less

- The system will stop operating when  
→P.351

- **Objects which the sensor may not be properly detected**

→P.330

- **Intuitive parking assist buzzer**

Regardless of whether the intuitive parking assist buzzer is enabled or not (→P.329), if the PKSB (Parking Support Brake) system is enabled (→P.346), the front or rear sensors detect an object and brake control is performed, the intuitive parking assist buzzer will sound to notify the driver of the approximate distance to the object.

- **Situations in which the system may not operate properly**

→P.330

- **Object warning function (vehicles with Advanced Park)**

→P.335

- **Situations in which the system may operate even though there is no possibility of a collision**

In addition to the situations in which stationary objects around the vehicle (→P.331) may not be detected, objects may not be detected by the sensors when your vehicle is moving sideways, such as when parallel parking.

- **Detection of objects along the sides of the vehicle**

→P.336

## Lexus Teammate Advanced Park\*

\*: If equipped

### Function description

The Advanced Park is a system which assists in a safe and smooth parking or exiting from a parking space by displaying the blind spots around the vehicle and the target parking spot through a bird's eye view, delivering operation guidance through displays and buzzer operation, and changing the shift position, operating the steering wheel, accelerator pedal, and brake pedal.

Additionally, the panoramic view monitor\* can display the area in front, behind, and from above the vehicle, helping confirm the condition of the area around the vehicle.

The turn signal lights will blink automatically when the parking assistance starts until the vehicle reaches the target parking spot, to notify people around the vehicle that parking is being performed.

Depending on the condition of the road surface or the vehicle, the distance between the vehicle and a parking space, etc., it may not be possible to assist in parking in the target space.

\*: For details on the panoramic view monitor refer to the "MULTIMEDIA OWNER'S MANUAL".

- **Remote control function (if equipped)**

Remote control function is a system

which assists in parking or exiting from a parking space selected on the center display by allowing changing the shift position, operating the steering wheel, accelerator pedal, and brake pedal from outside of the vehicle via a smartphone.

The turn signal lights will blink automatically when the parking assistance, except that for moving the vehicle forward and backward, starts until the vehicle reaches the target parking spot, to notify people around the vehicle that parking is being performed.

Preparation before using: →P.384

## Functions

### ■ Perpendicular parking (forward/reverse) function

Assistance is provided from the position the vehicle is stopped near the target parking space until the vehicle is in the parking space. (→P.366)

### ■ Perpendicular exiting (forward/reverse) function

Assistance is provided from the parked position until the vehicle is in a position where you can easily exit from the parking space. (→P.369)

### ■ Parallel parking function

Assistance is provided from the position the vehicle is stopped near the target parking space until the vehicle is in the parking space. (→P.371)

### ■ Parallel exiting function

Assistance is provided from the parked

position until the vehicle is in a position where you can easily exit from the parking space. (→P.374)

### ■ Memory function

Assistance is provided until the vehicle is guided into a previously registered parking space. (→P.376)

### ■ Remote control function (if equipped)

By operating a smartphone, assistance in entering or exiting a nearby target parking space, confirmed on the screen of the smartphone, is provided from outside of the vehicle. (→P.380)



## WARNING

### ■ Cautions regarding the use of the system

The recognition and control capabilities for this system are limited. The driver should always drive safely by always being responsible without over relying on the system and have a understanding of the surrounding situations.

- As with a normal vehicle, take care to observe your surroundings while the vehicle is moving.
- Always pay attention to the vehicle's surroundings while the system is operating and depress the brake pedal as necessary to slow or stop the vehicle.
- When parking, make sure that the vehicle can be parked in the target parking space before beginning operation.



## WARNING

- Depending on the condition of the road surface or the vehicle, the distance between the vehicle and a parking space, etc., it may not be possible to detect a parking space or the system may not be able to provide assistance to the point the vehicle is fully parked.
- This system will guide the vehicle to appropriate positions for changing the direction of travel, however, if you feel that the vehicle is approaching too close to an adjacent parked vehicle at any time, depress the brake pedal and shift the shift position. However, if this is performed, the number of times the vehicle changes direction may increase, and the vehicle may be parked at an angle.
- As following objects may not be detected, make sure to check the safety of the area around your vehicle and depress the brake pedal to stop the vehicle if it may collide with an object.
  - Wires, fences, ropes, etc.
  - Cotton, snow and other materials that absorb sound waves
  - Sharply-angled objects
  - Low objects (curb stones, parking blocks, etc.)
  - Tall objects with upper sections projecting outwards in the direction of your vehicle
- Even if there is an object in the target parking space, it may not be detected and assistance may be performed.
- While the system is operating, if it is likely that your vehicle will collide with a nearby vehicle, parking block, object, or person, depress the brake pedal to stop the vehicle and press the Advanced Park main switch to disable the system.

- Never use only the center display to view the area behind the vehicle. The image displayed may differ than the actual situation. Using only the screen when backing up may lead to an accident, such as a collision with another vehicle. When backing up, make sure to look directly or use the mirrors to check the safety of the area around your vehicle, especially behind the vehicle.
- When the ambient temperature is extremely low, the screen may appear dark or the displayed image may become unclear. Also, as moving objects may appear distorted or may not be able to be seen on the screen, make sure to directly check the safety of the area around your vehicle.
- In the following situations, while the vehicle is stopped and held by Advanced Park, it may be canceled and the vehicle may start moving. Immediately depress the brake pedal. Failure to do so may lead to an accident.
  - When the driver's door is opened
  - When operations instructed by the system are not performed within a certain amount of time
  - When the brake pedal is depressed and the vehicle is stopped for a certain amount of time
  - When the system malfunctions
- As the steering wheel will turn while this system is operating, pay attention to the following.
  - Be careful so that a necktie, scarf, or arm does not get caught. Keep your upper body away from the steering wheel. Also, keep children away from the steering wheel.
  - Long fingernails may be caught and when the steering wheel is rotating, leading to injury.

**WARNING**

- In an emergency, depress the brake pedal to stop the vehicle, and then press the Advanced Park main switch to disable the system.
  - Do not allow anyone to put their hands outside of a window while this system is operating.
  - **To ensure correct operation of the Advanced Park**
- Observe the following precautions. Failing to do so may result in the vehicle being unable to be driven safely and possibly cause an accident.
- Do not use this system in situations such as the following:
    - When in areas other than common parking spaces
    - When the surface of the parking space is sand or gravel and is not clearly defined with parking space lines
    - When the parking space is not level, such as when on a slope or has differences in height
    - Mechanical parking system
    - Parking lot with a device which raises to contact the bottom of the vehicle
    - When the road surface is frozen, slick, or covered with snow
    - When it is extremely hot and the asphalt is melting
    - When there are objects around the vehicle
    - When there is an object between your vehicle and the target parking spot or within the target parking spot (within the displayed blue box)
    - When there is a gutter between your vehicle and the target parking space or within the target parking spot (within the displayed blue box)

- When there is a hole or gutter in the exit direction
- When in high pedestrian or vehicle traffic areas
- When the parking space is in a location that is difficult to park in (too narrow for your vehicle, etc.)
- When images are unclear due to dirt or snow attached to the camera lens, light being shined into the camera or shadows
- When tire chains or a compact spare tire is installed to the vehicle
- When the doors or back door are not completely closed
- When an arm is held outside of a window
- In inclement weather such as heavy rain or snow
- Make sure to use only standard sized tires, such as those that were installed to the vehicle when it was shipped from the factory. Otherwise, Advanced Park may not operate properly. Also, when the tires have been replaced, the displayed position of the lines or box displayed on the screen may become incorrect. When replacing the tires, contact your Lexus dealer.
- In situations such as the following, it may not be possible for the system to provide assistance to a registered parking spot:
  - When the tires are extremely worn or the tire inflation pressure is low
  - When carrying a heavy load
  - When the vehicle is tilted due to the carried load
  - When a heater is installed in the surface of the parking space (road surface freeze prevention heater)

**WARNING**

- When the wheels are misaligned, such as after a wheel has been subjected to a strong impact
- When a pedestrian or passing vehicle is detected during assistance
- When something is incorrectly detected as a parking line (light, reflections from a building, difference in height on the parking surface, a gutter, painted road lines, redrawn lines, etc.)

If the vehicle deviates greatly from the set parking space in any situation other than the above, have the vehicle inspected by your Lexus dealer.

#### ■ When using Remote control function

- Remote control function is a function of the Advanced Park system. When using Remote control function on public roads, be sure to follow all local road traffic laws and regulations.
- Remote control function can only be used after agreeing to the disclaimer of the smartphone application.
- Remote control function can only perform some driving operations. It should only be operated by a driver with a valid driving license. While using application, carry electronic key. While operating, do not stare at the application screen, and pay attention to the vehicle's surroundings. In an emergency, cancel the Remote control function operation and stop the vehicle.
- As with a normal vehicle, take care to observe the area around the vehicle while the vehicle is moving.
- Always pay attention to the vehicle's surroundings while the system is operating.

- Remote control function is a system which assists in remote parking or exiting operations using a smartphone. When using Remote control function, the driver must carry the electronic key and smartphone and confirm the safety of the area around the vehicle.
- While using Remote control function, the vehicle can be stopped by stop continuously operating the smartphone (stopping movement of your finger, removing your finger from the screen, etc.). The vehicle can also be stopped by touching the cancel button on the smartphone application, unlocking the doors using the electronic key, or opening a door.
- If it seems like your vehicle may contact an obstruction, etc., stop operating the smartphone and cancel Remote control function if necessary.
- System operation will only be performed at a fixed speed and the vehicle cannot be accelerated or decelerated even if the speed of continuous operation of the smartphone is increased or decreased.
- Never drive the vehicle while staring at the smartphone screen.
- When driving, make sure to directly check the safety of the area around your vehicle.
- Do not use Remote control function when passengers or pets are in the vehicle.
- In an emergency, the system can be canceled by operating a switch on the electronic key or by opening a door.
- To use Remote control function, it is necessary to have a smartphone with the latest version of the Remote Park app. The following operating systems are supported:
  - Android™
  - Apple® iOS

**WARNING**

- When registering the vehicle to the Remote Park smartphone app, disconnect any other apps which are connected to the vehicle.
- To enable Remote control function, make sure to disable the Apple CarPlay connection.
- When parking, make sure that the vehicle can be parked in the target parking space before beginning operation.
- Only use Remote control function on level road surfaces which are not slick. Do not use Remote control function for parking spaces on a downward or upward slope.
- While Remote control function is operating, if a malfunction or system limitation is detected, the following will occur automatically:
  - Remote control function will be canceled
  - The vehicle will stop
  - The shift position will shift to P and the parking brake will be engaged
  - The power switch will turn off (for some malfunctions, the power switch will not turn off or cannot be turned off. Enter the vehicle and take corrective action according to the message displayed on the smartphone.)
  - The doors will remain locked
- When starting Remote control function, unlock the doors with wireless remote control by electronic key.

- When Remote control function is operating, the driver should remain within approximately 9.8 ft. (3 m) of the vehicle. If the driver becomes more than approximately 9.8 ft. (3 m) away, Remote control function will be suspended and a message will be displayed on the smartphone. Remote control function operation can be resumed by approaching the vehicle.
- The headlights will be turned on if the surrounding area is dark.
- If system operation is canceled due to a malfunction, the emergency flashers will flash. The emergency flashers will turn off if any of the following conditions are met:
  - A door is opened
  - 3 minutes have elapsed since the emergency flashers began flashing
- Remote control function can only be started when the following conditions are met:
  - When the hybrid system is starting, after assist mode is selected
  - When the power switch is off
  - When the remote air conditioning is operating
- After unlocking the doors using the wireless remote control, if the doors are locked using the smart entry function, the lock operation may be delayed.

**NOTICE****■ Precautions for use Advanced Park**

If the 12-volt battery was discharged or has been removed and installed, fold and extend the outside rear view mirrors.



## NOTICE

### ■ When using Remote control function

- Check the battery charge level of the smartphone before using Remote control function. If the battery of the smartphone dies while operating Remote control function, assist will be suspended. Also, if the battery charge level of the smartphone is 20% or less when attempting to start Remote control function, Remote control function will not be started.
- Turn on the Bluetooth communication function of the smartphone before using Remote control function. Remote control function cannot be used if the Bluetooth function is off.
- Do not turn off the Bluetooth function of the smartphone or disconnect from the multi-media system while using Remote control function. If the vehicle cannot be connected to via Bluetooth, Remote control function cannot be used.
- While using Remote control function, if a call is received, etc., and another app is opened, Remote control function will be suspended. Assist can be resumed if the Remote Park app is reopened within 3 minutes. If 3 minutes or more elapse, assist will be canceled.
- While using Remote control function, if the home button or power button of the smartphone is pressed and the screen is locked, Remote control function will be suspended. Assist can be resumed if the Remote Park app is reopened within 3 minutes. If 3 minutes or more elapse, assist will be canceled.
- Do not force close the Remote Park app while Remote Park is being used. If the app is force closed, assist will be canceled.
- When the ambient temperature is low, it may take time for the system to start, due to 12-volt battery charging.

- If the 12-volt battery voltage drops, assistance will be canceled.
- When using Remote control function on a slope, the vehicle speed will be slower and the distance that the vehicle will approach objects will become longer than when on a level road surface.
- If a system temporary failure occurs, after the vehicle is stopped by the electronic parking brake or the shift position being shifted to P, the power switch may turn off and the system may be canceled. In this case, have the vehicle inspected by your Lexus dealer.
- If a system malfunction occurs, assistance may be temporarily suspended. If the system returns to normal, operation can be resumed. Follow the content on the smartphone screen to resume operation.
- Remote control function cannot be started if the hybrid system has been started using an aftermarket remote starter.
- After Remote control function completes, the parking brake will be engaged as per regulations. As the parking brake may freeze and not be able to be released, avoid using Remote control function in extremely cold areas. Also, if the parking brake freezes, it may make a noise when it is released. However, this does not indicate a malfunction.
- Do not use Remote control function when the electronic key battery is depleted.

### Types of cameras and sensors used for the Advanced Park

Cameras and sensors are used to detect parked vehicles, making it easier to identify parking spaces.

## ▶ Front camera

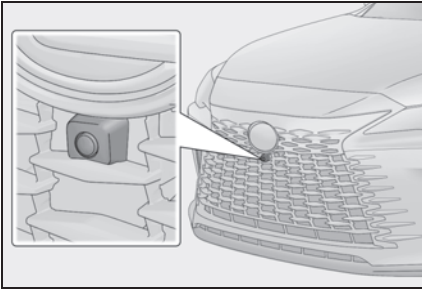

## ▶ Side cameras

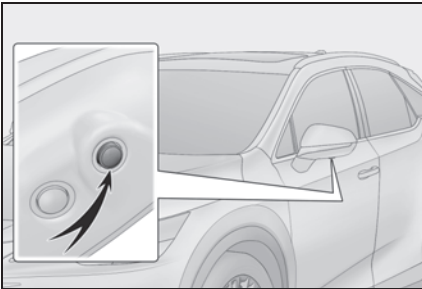

## ▶ Rear camera

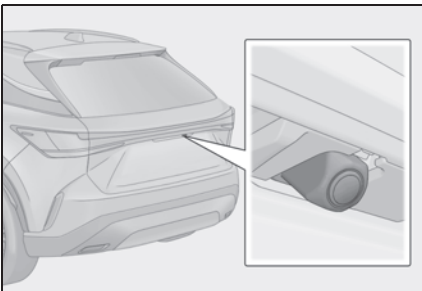

## ▶ Sensors

→P.328

## ■ Camera images

As special cameras are used, the colors in displayed images may differ from the actual color.

## ■ Precautions for use

For details on the following, refer to “Panoramic view monitor (Vehicles equipped with Lexus Teammate Advanced Park)” of “Peripheral monitoring system” in the

“MULTIMEDIA OWNER’S MANUAL”.

- Displayable range of the screens
- Cameras
- Differences between displayed images and the actual road
- Differences between displayed images and the actual objects
- **Detection range of the cameras and sensors**
  - If a parked vehicle is behind the target parking space and the distance between it and the vehicle becomes far, it may no longer be able to be detected. Depending on shape or condition of a parked vehicle, the detection range may become short or the vehicle may not be detected.
  - Objects other than parked vehicles, such as columns, walls, etc., may not be detected. Also, if they are detected, they may cause the target parking space to be misaligned.
- **Situations in which parking space lines may not be recognized properly**
  - In situations such as the following, parking space lines on the road surface may not be detected:
    - When the parking space does not use lines (parking space boundaries are marked with rope, blocks, etc.)
    - When the parking space lines are faded or dirty, making them unclear
    - When the road surface is bright, such as concrete, and the contrast between it and the white parking space lines is small
    - When the parking space lines are any color other than yellow or white
    - When the area surrounding the parking space is dark, such as at night, in an underground parking lot, parking garage, etc.
    - When it is raining or has rained and the road surface is wet and reflective or there are puddles
    - When the sun is shining directly into a camera, such as in the early morning or evening
    - When the parking space is covered with snow or de-icing agent
    - When there are marks from repairs or other marks on the road surface, or there is a

traffic bollard, or other object on the road surface

- When the color or brightness of the road surface is uneven
- When a camera has been splashed by hot or cold water and the lens has fogged up
- When the appearance of the parking space is affected by the shadow of the vehicle or trees
- When a camera lens is dirty or covered with water droplets
- In situations such as the following, the target parking space may not be recognized correctly:
  - When there marks from repairs or other marks on the road surface, or there is a parking block, traffic bollard, or other object on the road surface
  - When it is raining or has rained and the road surface is wet and reflective or there are puddles
  - When the area around the vehicle is dark or backlit
  - When the color or brightness of the road surface is uneven
  - When the parking space is on a slope
  - When there are diagonal lines (access aisle) near the parking space
  - When the appearance of the parking space is affected by the shadow of a parked vehicle (such as shadows from the grille, side step, etc.)
  - When accessories which obstruct the view of the camera are installed
  - When the parking space lines are faded or dirty, making them unclear
  - When the appearance of the parking space is affected by the shadow of the vehicle or trees

#### ■ Sensor detection information

→P.330

#### ■ Objects which the sensor may not be properly detected

→P.330

#### ■ Situations in which the sensor may not operate properly

→P.330

#### ■ Situations in which parking assistance may not operate even if there is no possibility of a collision

→P.331

### WARNING

#### ■ Precautions for the cameras and sensors

- Due to the characteristics of the camera lens, the position of and distance to people and objects displayed on the screen may differ from the actual situation. For details, refer to the "MULTIMEDIA OWNER'S MANUAL".
- Make sure to observe the precautions for using the intuitive parking assist, otherwise a sensor may not operate correctly, possibly leading to an accident. (→P.329)
- In situations such as the following, the sensors may not operate correctly, possibly leading to an accident. Proceed carefully.
  - When there is a parked vehicle next to the target parking space, if the displayed target parking space is far from the actual target parking space, a sensor may be misaligned. Have the vehicle inspected by your Lexus dealer.
  - Do not install any accessories near the detection area of the sensors.

### Turning the Advanced Park system on/off

- 1 Press the Advanced Park main switch.

If the switch is pressed while assistance is being performed, the assistance will be

anceled.

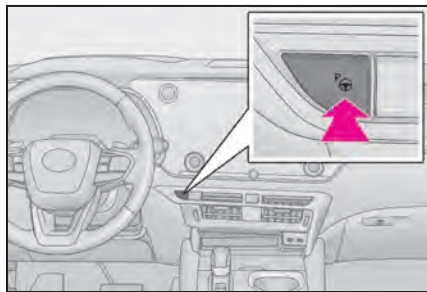

### ■ Operating conditions of the Advanced Park

Assistance will begin when all of the following conditions are met:

- The brake pedal is depressed
- The vehicle is stopped
- The driver's seat belt is fastened
- The steering wheel is not being operated
- The accelerator pedal is not depressed
- All of the doors and the back door are closed
- The outside rear view mirrors are not folded
- The parking brake is not engaged
- The dynamic radar cruise control are not operating
- ABS, VSC, TRAC, PCS and PKSB are not operating
- The vehicle is not on a steep slope
- The VSC and TRAC are not turned off

If assistance cannot be started, check the message displayed on the center display. (→P.389)

### Advanced Park guidance screens

Guidance screens are displayed on the center display.

### ▶ Guidance screen (When assistance starts)

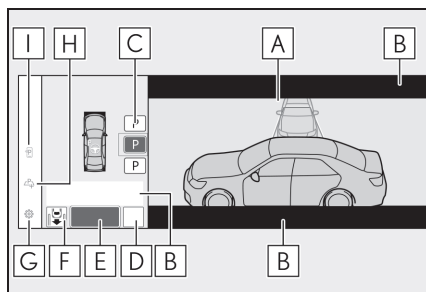

**A** Target parking space box (blue)

**B** Advice display

**C** Parking type change button

If multiple buttons are displayed, depending on the condition of the button its function differs as follows.

**P** or **P** : Change the target to another parking space.

**P** or **P** : Select the current target parking space.

**(P)** : Select to change to the parallel parking function

**P** : Change the perpendicular parking (forward/reverse) function

**D** "MODE" button

Select to change between the memory function and the perpendicular parking (forward/reverse) function and parallel parking function. (→P.376)

**E** "Start" button

Select to start parking assistance.

**F** Perpendicular parking direction change button

Select to change between the parking (forward) function and parking (reverse) function.

**(P)** : Change the perpendicular parking

(forward) function

: Change the perpendicular parking (reverse) function

### **G** Customize setting button

Select to display the Advanced Park setting screen. (→P.387)

### **H** Registration button

Select to begin registering a parking space.

### **I** Remote control function start button\*

Select to start parking assistance operation on the smartphone display.

\*: If equipped

### ▶ Guidance screen (When reversing)

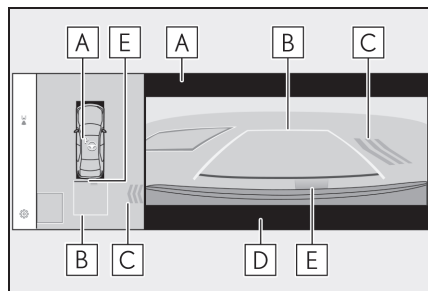

### **A** Operation icon

Displayed when the Advanced Park is operating.

### **B** Guide lines (yellow and red)

Display points from the center of the edge of the front or rear bumper to the target stopping position (yellow)\* and approximately 1 ft. (0.3 m) (red) from the vehicle.

### **C** Moving object warning icon

### **D** Emergency support brake control operation display

“Brake” is displayed.

### **E** Intuitive parking assist display

→P.328

\*: The yellow lateral line is not displayed when the target stopping position is approximately 8.2 ft. (2.5 m) or more away from the vehicle.

### ■ Intuitive parking assist pop-up display

Regardless of whether the intuitive parking assist is off or on (→P.329), if an object is detected by the intuitive parking assist when the Advanced Park is operating, the intuitive parking assist pop-up display will automatically be displayed over the guidance display.

### ■ Brake control operation when Advanced Park is operating

While the Advanced Park is operating, if the system determines that the possibility of collision with detected moving or stationary object is high, the hybrid system output restriction control and brake control will operate.

If brake control operates, Advanced Park operation will be suspended and a message will be displayed on the multi-information display.

### ■ Buzzer

Depending on surrounding sounds or sounds from other systems, it may be difficult to hear the buzzer of this system.

### ■ If a black screen is displayed on the center display when the Advanced Park is operating

The system is being affected by radio waves or may be malfunctioning. If a radio antenna is installed near a camera, move it to a location as far from the cameras as possible. If a radio antenna is not installed near a camera, and the screen does not return to normal after turning the power switch off and then starting the hybrid system again, have the vehicle inspected by your Lexus dealer.

## Perpendicular parking (forward/reverse) function

The perpendicular parking (forward/reverse) function can be used if

the target parking space can be detected when the vehicle is stopped close and perpendicular to the center of the parking space. Also, depending on the condition of the parking space, etc., if it is necessary to change the direction of travel of the vehicle, the shift position can be shifted by assistance control.

### Parking using the perpendicular parking (forward/reverse) function

- 1 Stop the vehicle at a position close and perpendicular to the center of the target parking space.
  - ▶ If there are parking space lines

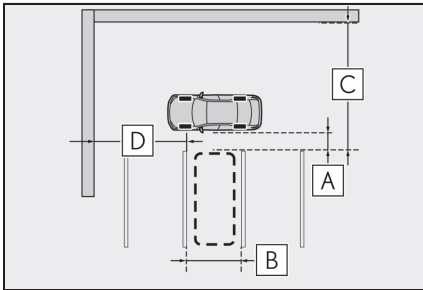

- A** Approximately 3.3 ft. (1 m)\*
- B** Approximately 8.2 ft. (2.5 m)\*
- C** Approximately 19.7 ft. (6 m) or more\*
- D** Approximately 18.0 ft. (5.5 m) or more\*

The system can operate even if there is a parking space line on only one side of the target parking space.

\*: This is a reference measurement for detection of a parking space. Depending on the surrounding environment, detection may not be possible.

tion may not be possible.

- ▶ If there is an adjacent parked vehicle

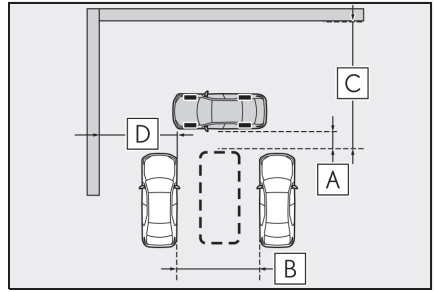

- A** Approximately 3.3 ft. (1 m)\*
- B** Approximately 9.8 ft. (3 m) or more\*
- C** Approximately 19.7 ft. (6 m) or more\*
- D** Approximately 18.0 ft. (5.5 m) or more\*



The system can operate even if there is a vehicle on only one side of the target parking space.

\*: This is a reference measurement for detection of a parking space. Depending on the surrounding environment, detection may not be possible.

- 2 Press the Advanced Park main switch and check that a possible

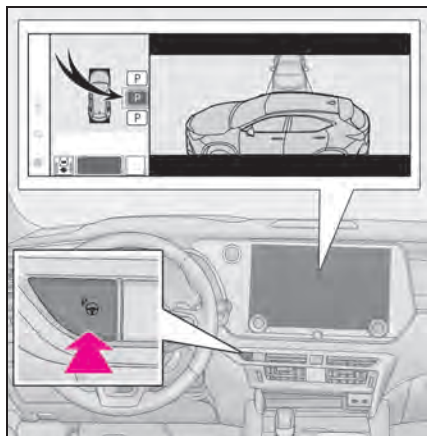
parking space is displayed on the center display.



- If a space which your vehicle can be parked is detected, a target parking space box will be displayed.
- If it is possible to parallel park in the space, select the parking space, and then select  to change to the parallel parking function.
- If it is possible to change the direction which a parking space is entered, select the parking space, and then select  or  change the direction.
- Depending on the surrounding environment, it may not be possible to use this function. According to the information displayed on the center display, use the function on another parking space.

### 3 Select "Start" button.

A buzzer will sound, an operation message will be displayed on the multi-information

display, and assistance will begin operating.

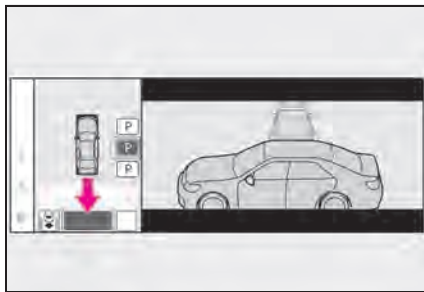

- When the brake pedal is released, "Moving Forward..." , "Backing Up..." will be displayed and the vehicle will begin moving forward/reverse.
- To cancel assistance, press the Advanced Park main switch.

If assistance is canceled, "Advanced Park Canceled" will be displayed.

If you feel that the vehicle is approaching close to a surrounding vehicle, object, person, or gutter: P.369

- 4 Perform operations as indicated by the advice displays until the vehicle stops in the target parking space.

When the vehicle stops, "Advanced Park Finished" will be displayed and parking assistance will end.

If the seat belt is unfastened or door opened before shifting the shift position to P, a buzzer sounds, and a message is displayed on the center display. Also, if the driver's seat is unfastened and brake pedal released, the horn will sound. Shift the shift position to P and end the assistance.

If you select  on the center display, the vehicle displayed on the parking assist

completion screen will rotate.

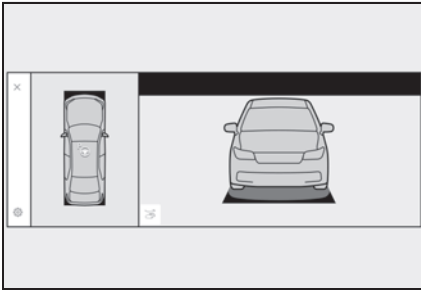

■ **If you feel that the vehicle is approaching close to a surrounding vehicle, object, person, or gutter**

Depress the brake pedal to stop the vehicle and then shift the shift position to change the direction of travel of the vehicle. At this time, assist will be suspended. However, if the “Start” button is selected, assist will resume and the vehicle will move in the direction corresponding to the selected shift position.

■ **When the brakes have been operated**

When the brakes have been operated, brake operation sound may be heard. This does not indicate a malfunction.

 **NOTICE**

■ **When using the perpendicular parking (forward/reverse) function**

- Make sure that there are no obstructions within the yellow guide lines and between the vehicle and target parking spot. If there are any obstructions between the vehicle and the target parking space, or between the yellow guide lines, cancel the function.
- As the target parking space will not be able to be set correctly if the surface of the parking space is on a slope or has differences in height, the vehicle may stray from the target parking space or be slanted. Therefore, do not use the function for this kind of parking spot.

- When parking in a narrow parking space, the vehicle may closely approach an adjacent parked vehicle. If a collision seems likely, depress the brake pedal to stop the vehicle.
- If a detected parked vehicle is narrow or parked extremely close to the curb, the position at which assistance will park the vehicle will also be close to the curb. If it seems likely the vehicle will collide with something or drive off of the road, depress the brake pedal to stop the vehicle, and then press the Advance Park main switch to disable the system.

### Advanced Park perpendicular exiting (forward/reverse) function

When exiting from a perpendicular parking space, if the system determines that exit is possible the perpendicular exiting (forward/reverse) function can be used. Also, depending on the surrounding environment, if it is necessary to change the direction of travel of the vehicle, the shift position can be shifted by assistance control.

#### Leaving a parking space using the perpendicular exiting (forward/reverse) function

- 1 With the brake pedal depressed and P shift position selected, press the Advanced Park main switch and check that the exit direction

selection screen is displayed on the center display.

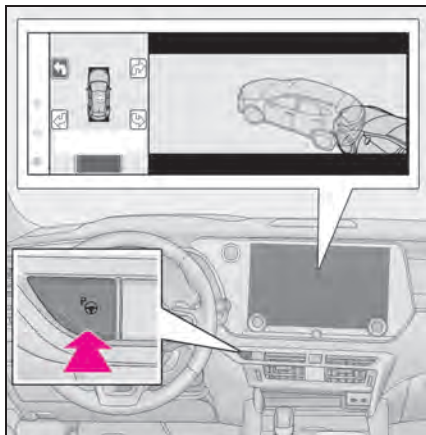

- 2 Select an arrow on the center display to select the direction you wish to exit.

If the turn signal lever is operated, only exit to the left or right can be selected.

- 3 Depress the brake pedal and select "Start" button.

A buzzer will sound, an operation message will be displayed on the multi-information display, and assistance will begin operating.

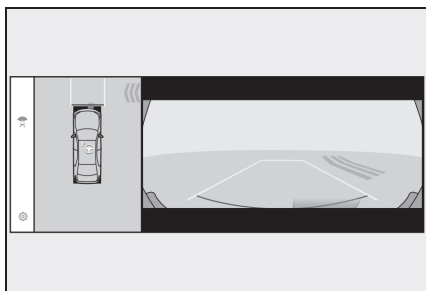

To cancel assistance, press the Advanced Park main switch.

If assistance is canceled, "Advanced Park Canceled" will be displayed.

If you feel that the vehicle is approaching close to a surrounding vehicle, object, person, or gutter: →P.369

- 4 Perform operations as indicated by the advice displays until the vehicle is in a position where exit is possible.

When the vehicle reaches a position where exit is possible, "You can exit by moving the steering wheel" will be displayed. If the steering wheel is operated, "Advanced Park Finished" will be displayed and assistance will end.

As assistance will end while the vehicle is moving, grip the steering wheel and drive forward.

If the steering wheel is not operated, the vehicle will stop at the exit position. Assistance can be ended by depressing the accelerator pedal or brake pedal.

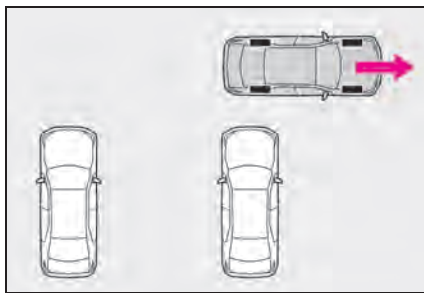

- If you feel that the vehicle is approaching close to a surrounding vehicle, object, person, or gutter

→P.369

- Perpendicular exiting (forward/reverse) function

Do not use exiting (forward/reverse) function in any situation other than when exiting a parallel parking spot. If assistance is started unintentionally, depress the brake pedal and stop the vehicle, then press the Advanced Park main switch to cancel assistance.

- Situations in which the perpendicular exiting (forward/reverse) function will not operate

In situations such as the following, the perpendicular exiting (forward/reverse) function will not operate:

- When a vehicle which is waiting to park is in the exit direction

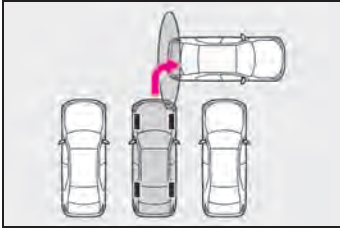

- When a wall, column, or person is detected as near a front or rear center or corner sensor

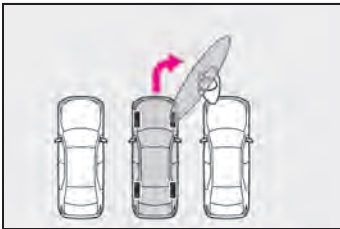

- When the brakes have been operated  
→P.369

### Advanced Park parallel parking function

The parallel parking function can be used if the target parking space can be detected when the vehicle is stopped close and aligned with the center of the parking space. Also, depending on the condition of the parking space, etc., if it is necessary to change the direction of travel of the vehicle, the shift position can be shifted by assistance control.

#### Parking using the parallel parking function

- 1 Stop the vehicle with it aligned near the center of the target parking space.

- ▶ If there are parking space lines

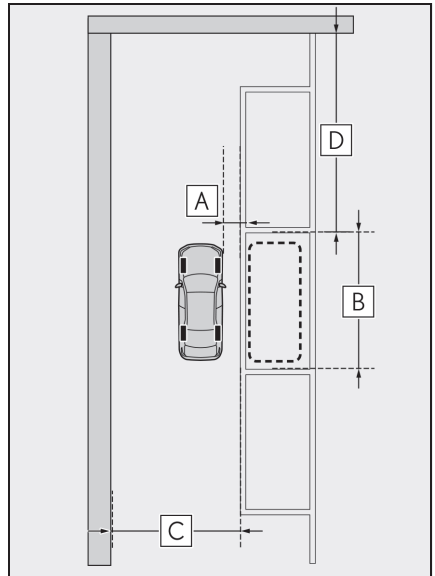

- A** Approximately 3.3 ft. (1 m)<sup>\*</sup>
- B** Approximately 19.7 ft. (6 m)<sup>\*</sup>
- C** Approximately 14.8 ft. (4.5 m) or more<sup>\*</sup>
- D** Approximately 26.2 ft. (8 m) or more<sup>\*</sup>

<sup>\*</sup>: This is a reference measurement for detection of a parking space. Depending on the surrounding environment, detection may not be possible.

- If there is an adjacent parked vehicle

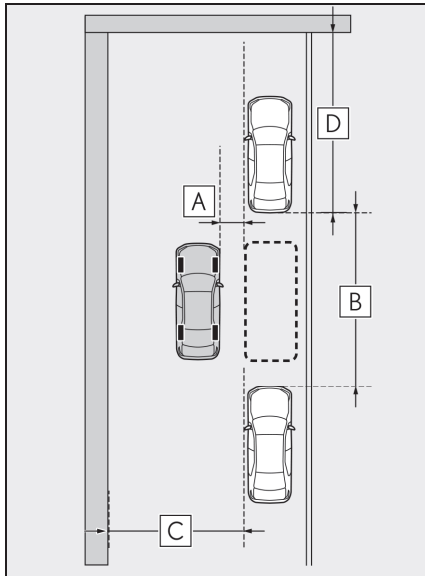

- A** Approximately 3.3 ft. (1 m)<sup>\*</sup>  
**B** Approximately 23.0 ft. (7 m)<sup>\*</sup>  
**C** Approximately 14.8 ft. (4.5 m) or more<sup>\*</sup>  
**D** Approximately 26.2 ft. (8 m) or more<sup>\*</sup>

<sup>\*</sup>: This is a reference measurement for detection of a parking space. Depending on the surrounding environment, detection may not be possible.

- 2** Press the Advanced Park main switch and check that a possible

parking space is displayed on the center display.

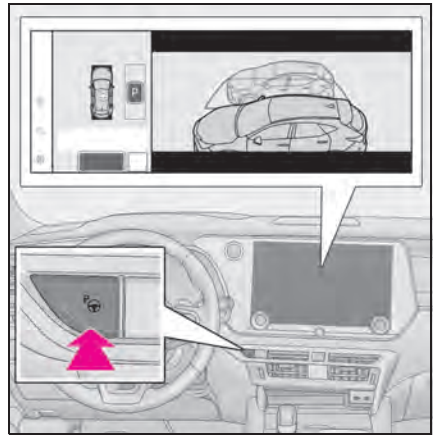

- If a space which your vehicle can be parked is detected, a target parking space box will be displayed.
  - If it is possible to perpendicular parking (forward/reverse) in the space, select the parking space, and then select **P** to change to the perpendicular parking (forward/reverse) function.
  - Depending on the surrounding environment, it may not be possible to use this function. According to the information displayed on the center display, use the function on another parking space.
- 3** Select "Start" button.

A buzzer will sound, an operation message will be displayed on the multi-information

display, and assistance will begin operating.

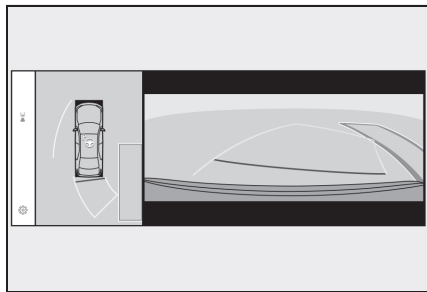

- When the brake pedal is released, “Moving Forward...” will be displayed and the vehicle will begin moving forward.
- To cancel assistance, press the Advanced Park main switch.

If assistance is canceled, “Advanced Park Canceled” will be displayed.

If you feel that the vehicle is approaching close to a surrounding vehicle, object, person, or gutter: →P.369

- 4 Perform operations as indicated by the advice displays until the vehicle stops in the target parking space.

When the vehicle stops, “Advanced Park Finished” will be displayed and parking assistance will end.

If you select  on the center display, the vehicle displayed on the parking assist completion screen will rotate.

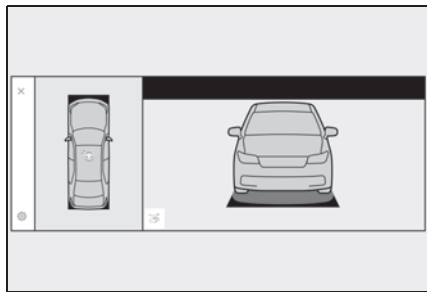

- If you feel that the vehicle is approaching close to a surrounding vehicle, object, person, or gutter

→P.369

- “No available parking space” is displayed

Even if the vehicle is stopped parallel to a parking space, an adjacent parked vehicle may not be detected. In this case, if the vehicle is moved to a position that a parked vehicle can be detected, assistance can be started.

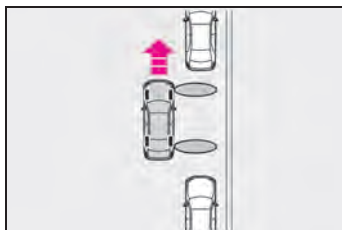

- When the brakes have been operated

→P.369

#### NOTICE

- When using the parallel parking function

- Make sure that there are no obstructions within the yellow guide lines and between the vehicle and target parking spot. If any obstructions are detected within the yellow guide lines or between the vehicle and the target parking space, the parallel parking function will be cancelled or suspended.
- As the target parking space will not be able to be set correctly if the surface of the parking space is on a slope or has differences in height, the vehicle may stray from the target parking space or be slanted. Therefore, do not use the parallel parking function for this kind of parking spot.



## NOTICE

- If an adjacent parked vehicle is narrow or parked extremely close to the curb, the position at which assistance will park the vehicle will also be close to the curb. If it seems likely the vehicle will collide with the curb or drive off of the road, depress the brake pedal to stop the vehicle, and then press the Advanced Park main switch to disable the system.

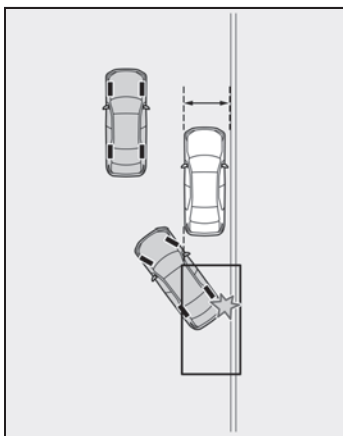

- If there is a wall or other barrier on the inner side of the parking space, the vehicle may stop at a position slightly outside of the set target parking space.

### Advanced Park parallel exiting function

When exiting from a parallel parking space, if the system determines that exit is possible the parallel exiting function can be used. Also, depending on the surrounding environment, if it is necessary to change the direction of travel of the vehicle, the shift position can be shifted by assistance control.

### Leaving a parking space using the parallel exiting function

- 1 With the brake pedal depressed and P shift position selected, press the Advanced Park main switch and check that the exit direction selection screen is displayed on the center display.

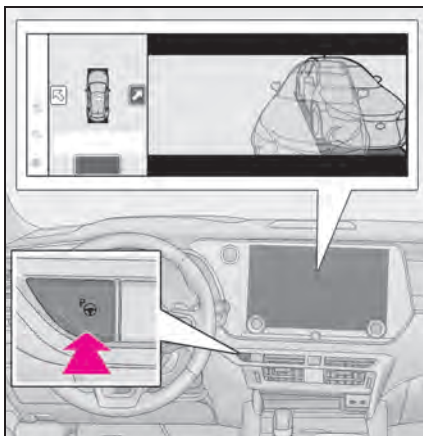

- 2 Select an arrow on the center display to select the direction you wish to exit.

If the turn signal lever is operated, only exit to the left or right can be selected.

- 3 Depress the brake pedal and select "Start" button.

A buzzer will sound, an operation message will be displayed on the multi-information display, and assistance will begin operating. To cancel assistance, press the Advanced Park main switch.

If assistance is canceled, "Advanced Park Canceled" will be displayed.

If you feel that the vehicle is approaching close to a surrounding vehicle, object, person, or gutter: →P.369

- 4 Perform operations as indicated by the advice displays until the vehicle

is in a position where exit is possible.

When the vehicle reaches a position where exit is possible, "You can exit by moving the steering wheel" will be displayed. If the steering wheel is operated, "Advanced Park Finished" will be displayed and assistance will end.

As assistance will end while the vehicle is moving, grip the steering wheel and drive forward.

If the steering wheel is not operated, the vehicle will stop at the exit position. Assistance can be ended by depressing the accelerator pedal or brake pedal.

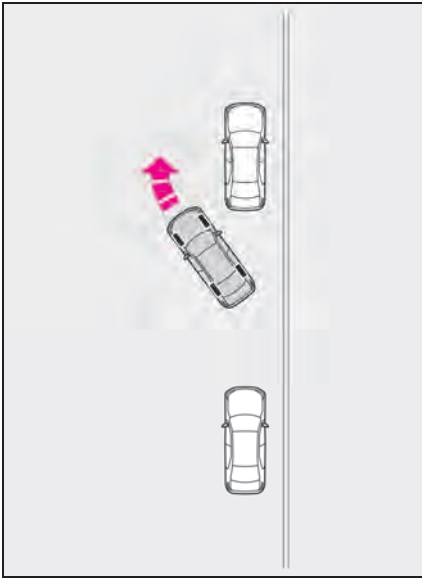

- If you feel that the vehicle is approaching close to a surrounding vehicle, object, person, or gutter

→P.369

#### ■ Parallel exiting function

Do not use parallel exiting function in any situation other than when exiting a parallel parking spot. If assistance is started unintentionally, depress the brake pedal and stop the vehicle, then press the Advanced Park main switch to cancel assistance.

#### ■ Situations in which the parallel exiting function will not operate

In situations such as the following, the parallel exiting function will not operate:

- When vehicles waiting at a traffic signal in the exit direction

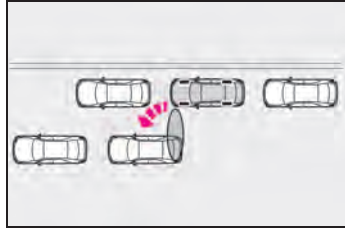

- When a vehicle is stopped in the area behind where the vehicle will exit

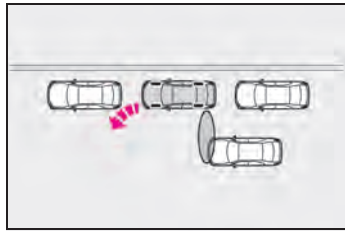

- When a wall, column, or person is detected as near a front or rear side sensor

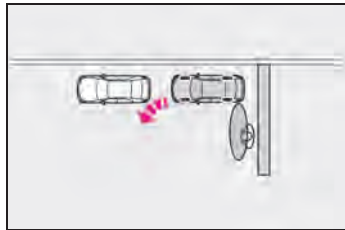

- When the vehicle has been parked on a curb and a side sensor detects the road surface

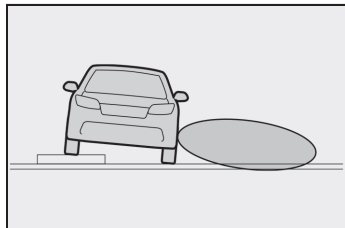

- When a vehicle is not parked in front of

the vehicle

- When there is excessive space between the front of the vehicle and a parked vehicle
- When the brakes have been operated  
→P.369

### Advanced Park memory function

The memory function can be used to park in a previously registered parking space, even if there are no parking space lines or adjacent parked vehicles.

Up to 3 parking spaces can be registered.

#### Registering a parking space

- 1 Stop the vehicle with it aligned near the center of the target parking space.

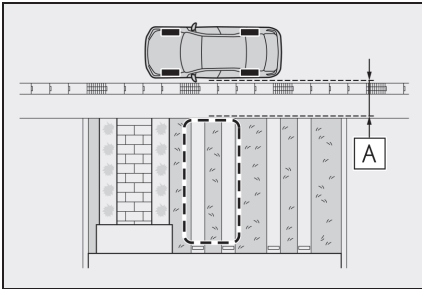

**A** Approximately 3.3 ft. (1 m)

- 2 Press the main switch and then select  $\triangleleft P_{\rightarrow}$ .

If the Advanced Park main switch is pressed at a parking space without parking lines or any adjacent parked vehicles, "No available parking space" may be displayed.

Continuously select and hold  $\triangleleft P_{\rightarrow}$ .

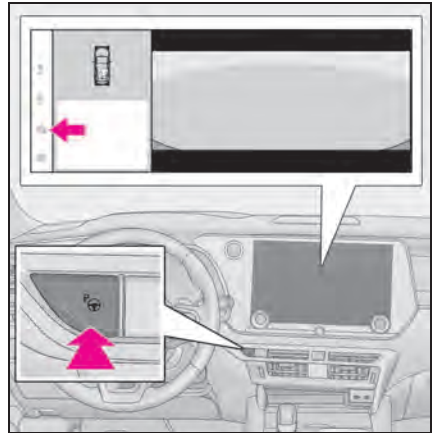

- 3 Select perpendicular parking (forward/reverse) function or parallel parking function.

Only parking spaces for which assist can be performed are displayed.

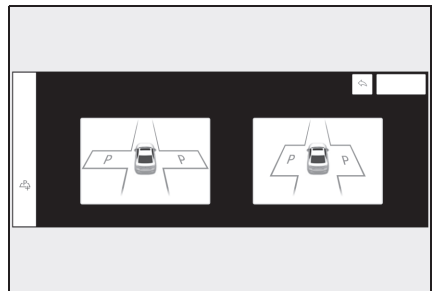

- 4 Select the parking direction.

When perpendicular parking (forward/reverse) was selected in step 3:

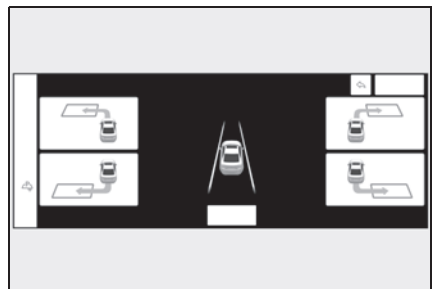

When parallel parking was selected in step

3:

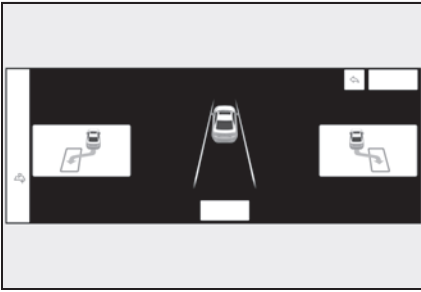

- 5 Using the arrow buttons, adjust the position of the parking space to be registered, and then select "OK" button.

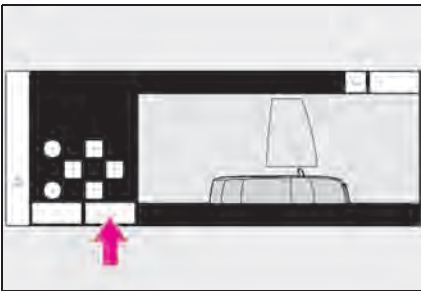

- 6 Select "Start" button.

A buzzer will sound, an operation message will be displayed on the multi-information display, and assistance will begin operating. When the brake pedal is released, "Moving Forward..." will be displayed and the vehicle will begin moving forward.

If you feel that the vehicle is approaching close to a surrounding vehicle, object, per-

son, or gutter: →P.369

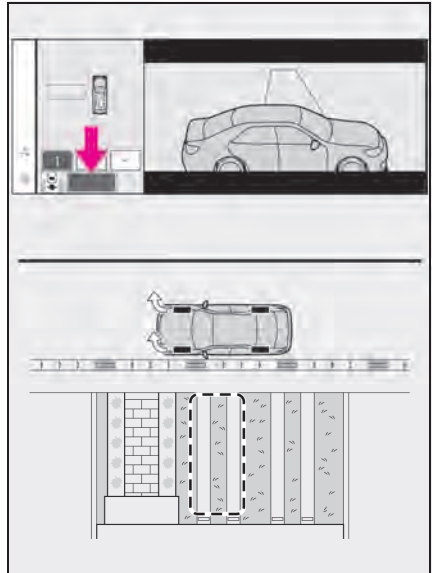

- 7 Perform operations as indicated by the advice displays until the vehicle stops in the target parking space.
- 8 Check the position that the vehicle has stopped. If necessary, adjust the position of the parking spot to be registered using the arrow buttons, and then select "Reg." button.

"Registration Completed" will be displayed on the center display.

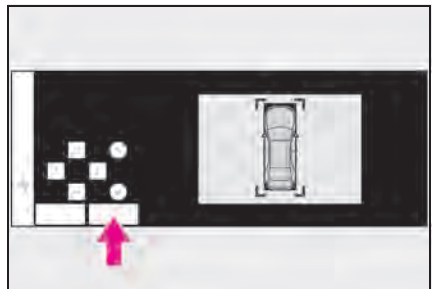

- Register the parking space only if there are no obstructions within the area shown by the thick lines.

- The amount that the position of the parking spot to be registered can be adjusted is limited.

### When parking in a parking space registered to the memory function

- 1 Stop the vehicle with it aligned near the center of the target parking space.

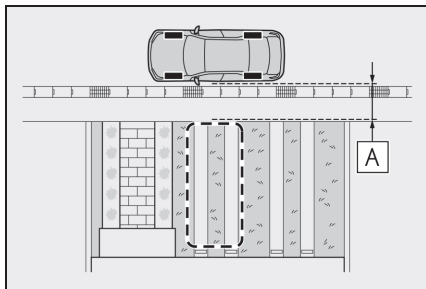

**A** Approximately 3.3 ft. (1 m)

- 2 Press the Advanced Park main switch and check that a possible parking space is displayed on the center display.

If the "MODE" button is displayed, the button can be touched to change between the memory function, perpendicular parking (forward/reverse) function and parallel

parking function.

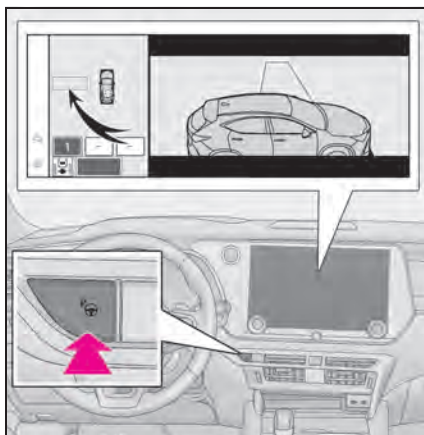

- 3 Select the desired parking space, and then select "Start" button.

Perform the procedure for the perpendicular parking (forward/reverse) function from step 3. (→P.369)

- If you feel that the vehicle is approaching close to a surrounding vehicle, object, person, or gutter

→P.369

- When overwriting a registered parking space

If the maximum number of parking spaces have been registered and  $\triangle P_{\pm}$  is selected, a registered parking space can be selected and then overwritten with a new parking space.

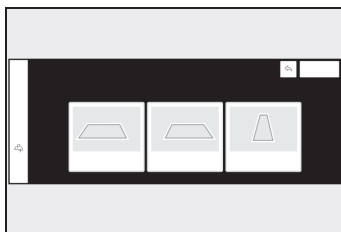

- When multiple parking spaces are registered

Select the desired parking space, and then select "Start" button.

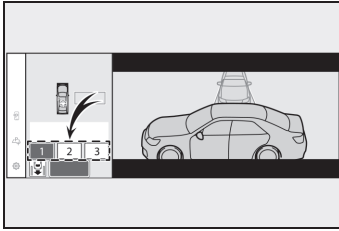

■ When the brakes have been operated  
→P.369

 NOTICE

■ When using the memory function  
(→P.369, P.373)

- The memory function is a function which provides assistance in parking in a previously registered parking space. If the condition of the road surface, vehicle, or surrounding area differs from when registration was performed, the parking space may not be able to be detected correctly or assistance may not be provided to the point that the vehicle is fully parked.
- Do not register a parking space in situations such as the following, as the set parking space may not be able to be registered or assistance may not be possible later.
  - When a camera lens is dirty or covered with water droplets
  - When it is raining or snowing
  - When the surrounding area is dark (at night, etc.)
- In situations such as the following, it may not be possible to register a parking space.
  - When there is insufficient space between the road and parking space
  - When the road surface around the parking space does not have any differences the system can recognize

- If a parking space has been registered in situations such as the following, assistance may not be able to be started later or assistance to the registered position may not be possible.
- When shadows are cast on the parking space (there is a carport over the parking space, etc.)

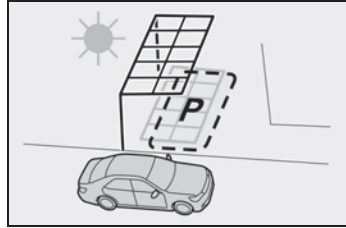

- When there are leaves, garbage, or other objects which will likely move, in the parking space
- When the road surface around the parking space has the same repeating pattern (brick, etc.)

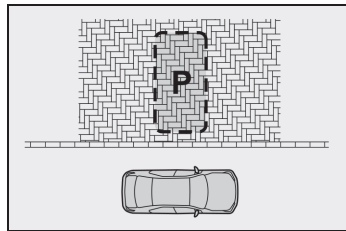

- In situations such as the following, it may not be possible for the system to provide assistance to a registered parking spot:
  - When the appearance of the parking space is affected by the shadow of the vehicle or trees
  - When an object is detected in the registered parking space
  - When a pedestrian or passing vehicle is detected during assistance
  - When the position the vehicle is stopped when assistance is started differs from the position when registration was performed

**NOTICE**

- When the registered parking space cannot be reached due to the existence of parking blocks, etc.
- When the road surface around the parking space has changed (road surface has degraded or been resurfaced)
- When the sunlight conditions differ from when registration was performed (due to weather or time of day)
- When the sun is shining directly into a camera, such as in the early morning or evening
- When the color or brightness of the road surface is uneven
- When a light is temporarily shined on the parking space (lights of another vehicle, security light, etc.)
- When the road surface around the parking space has the same repeating pattern
- When there is a low protrusion on the road surface near the parking space
- When the parking space is on a slope
- When a camera has been splashed by hot or cold water and the lens has fogged up
- When a camera lens is dirty or covered with water droplets
- When accessories which obstruct the view of the camera are installed

If assistance is ended during registration, perform registration again.

- When registering a parking space to the memory function, if the road surface cannot be detected “No available parking space to register” will be displayed.

- When using the memory function, make sure to stop immediately in front of the stop position. Otherwise the parking space may not be able to be detected correctly or assistance may not be provided to the point that the vehicle is fully parked.
- Do not use the memory function if a camera has been subjected to a strong impact or images of the panoramic view monitor are misaligned.
- If a camera has been replaced, as the installation angle of the camera will have changed, it will be necessary to reregister parking spaces of the memory function.

**Remote control function**

A smartphone can be used to remotely operate the parking functions and exit functions. Also, assistance can be provided to remotely move the vehicle forward or backward into a garage, etc.

**Parking using Remote control function**

A smartphone can be used to remotely operate the parking function if the target parking space can be detected when the vehicle is stopped close and perpendicular to the center of the parking space. Also, depending on the condition of the parking space, etc., if it is necessary to change the direction of travel of the vehicle, the shift position can be shifted by assistance control.

- 1 Stop the vehicle with it aligned near the center of the target parking space. (→P.367, P.371)

- 2 Press the Advanced Park main switch and check that a possible parking space is displayed on the center display. (→P.367, P.371)
- 3 Select  and then select “Perpendicular/parallel”.
- 4 Select “OK” button.
- 5 Exit the vehicle while carrying the electronic key and smartphone, and then start the Remote Park app on the smartphone.

The detection area of the electronic key is within approximately 9.8 ft. (3 m) around the vehicle.

If there is an obstruction in the path of the vehicle, move it before parking the vehicle. A cone can also be moved after exit the vehicle.

- 6 From outside of the vehicle, confirm the parking space on the screen of the smartphone and then select the start button.

Start operation of Remote control function while standing approximately 1.6 ft. (50 cm) or more from the vehicle and out of the path of the vehicle.

- 7 Checking the safety of the area around the vehicle, trace the operation area on the screen of the smartphone.

While continuously tracing the operation area, the vehicle will move and parking assistance will be performed.

If operation of the screen of the smartphone is stopped, assistance can be suspended and the vehicle can be stopped.

When the operation of the screen of the smartphone is resumed to move the vehicle, the vehicle will be locked automatically before moving.

- 8 When the parking space is reached, after the vehicle is

stopped by the parking brake, the shift position will be shifted to P, the power switch will be turned off, and the doors will be locked.

A completion screen will be displayed on the smartphone.

#### ■ The parking function can be used even if obstructions exist if

- When using the parking functions at a parking space made of white lines, even if an obstruction exists in the parking space, the space can be set as the target parking space. This allows for assistance to continue after setting a parking space from inside the vehicle and then exiting the vehicle to move an obstruction, such as a traffic cone placed in a handicapped parking space.
- When perpendicular parking using Advanced Park, 3 parking spaces on each side of the vehicle (up to 6 total) can be detected. However, when using Remote control function, only 1 parking space on each side of the vehicle can be detected.

#### ■ When the brakes have been operated

→P.369

### Moving the vehicle forward and backward using Remote control function

After the vehicle is stopped, assistance can be provided to move the vehicle into a garage, etc., by using the forward and backward movement function.

- 1 Stop the vehicle at the location you would like to start assistance.

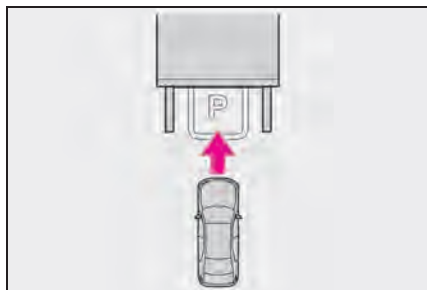

- 2 Press the Advanced Park main switch. (→P.367)
- 3 Select  and then select "Forward/reverse".
- 4 Select "OK" button.
- 5 Exit the vehicle while carrying the electronic key and smartphone, and then start the Remote Park app on the smartphone.

The detection area of the electronic key is within approximately 9.8 ft. (3 m) around the vehicle.

- 6 From outside of the vehicle, confirm the direction of travel on the screen of the smartphone and then select the start button.

Start operation of Remote control function while standing approximately 1.6 ft. (50 cm) or more from the vehicle and out of the path of the vehicle. The detection area of the electronic key is within approximately 9.8 ft. (3 m) around the vehicle.

- 7 Checking the safety of the area around the vehicle, trace the operation area on the screen of the smartphone.

While continuously tracing the operation area, the vehicle will move and forward and reverse movement assistance will be performed.

If operation of the screen of the smartphone is stopped, assistance can be suspended and the vehicle can be stopped.

While assistance is being performed, it can be stopped part way or the direction of travel of the vehicle can be changed.

- 8 Select the power button on the screen of the smartphone.

The power switch will then turn OFF and the doors will lock automatically.

#### ■ Changing the direction of travel

While assistance is being performed, the direction of travel of the vehicle can be changed by the forward and reverse movement function.

When there is a wall behind the vehicle, etc., by operating the direction of travel changing button on the screen of the smartphone, the vehicle can be slightly moved forward to allow loading of items and then moved back to its original position.

- When the brakes have been operated  
→P.369

#### Exiting using Remote control function

Assistance can be provided to exit from a perpendicular or parallel parking space when the power switch OFF.

When forward and backward movement is selected, the maximum distance the vehicle can move is 23.0 ft. (7 m) from the starting point and possible to change the direction of travel.

- 1 While near the parked vehicle, unlock the doors using the electronic key, and then start the Remote Park app on the smartphone.

If the smartphone cannot connect to the vehicle, using the electronic key, unlock the

doors again.



- 2 Select the start button on the screen of the smartphone.

The power switch will change to ON.

- 3 Check that a possible exit direction is displayed, select the exit direction.

- 4 Checking the safety of the area around the vehicle, trace the operation area on the screen of the smartphone.

While continuously tracing the operation area, the vehicle will move and departure assistance will be performed.

If operation of the screen of the smartphone is stopped, assistance can be suspended and the vehicle can be stopped.

While assistance is being performed, it can be stopped part way or the direction of travel of the vehicle can be changed.

- 5 Move the vehicle to the position where assistance ends and enter the vehicle while carrying the electronic key.

To stop assistance part way, stop operating the smartphone or enter the vehicle.

#### ■ Exit using the remote air conditioning

- Assistance can be provided to exit from a parking space, even when the remote air conditioning is operating.
- When Remote control function is started while the remote air conditioning is oper-

ating, if tracing operations are not performed on a smartphone, assistance can be canceled by entering the vehicle and depressing the brake pedal.

- When the brakes have been operated  
→P.369

#### Parking using the Remote control function and memory function

A smartphone can be used to remotely operate the memory function if the target parking space can be detected when the vehicle is stopped close to a parking space which was previously registered to the memory function.

Also, depending on the condition of the parking space, etc., if it is necessary to change the direction of travel of the vehicle, the shift position can be shifted by assistance control.

- 1 Stop the vehicle with it aligned near the center of the target parking space. (→P.378)
- 2 Press the Advanced Park main switch and check that a possible parking space is displayed on the center display. (→P.378)
- 3 Select  and then select "Perpendicular/parallel".
- 4 Select "OK" button.

If the "MODE" button is displayed, the button can be selected to change between the memory function, perpendicular parking (forward/reverse) function and parallel parking function.

- 5 Exit the vehicle while carrying the electronic key and smartphone, and then start the Remote Park app on the smartphone.

The detection area of the electronic key is within approximately 9.8 ft. (3 m) around the vehicle. If there is a cone or other obstruction in the path of the vehicle, move it after exiting the vehicle.

- 6 From outside of the vehicle, confirm the parking space on the screen of the smartphone and then select the start button.

Start operation of Remote control function while standing approximately 1.6 ft. (50 cm) or more from the vehicle and out of the path of the vehicle.

- 7 Checking the safety of the area around the vehicle, trace the operation area on the screen of the smartphone.

While continuously tracing the operation area, the vehicle will move and parking assistance will be performed.

If operation of the screen of the smartphone is stopped, assistance can be suspended and the vehicle can be stopped.

When the operation of the screen of the smartphone is resumed to move the vehicle, the vehicle will be locked automatically before moving.

- 8 When the parking space is reached, after the vehicle is stopped by the parking brake, the shift position will be shifted to P, the power switch will be turned off, and the doors will be locked.

A completion screen will be displayed on the smartphone.

#### ■ When the brakes have been operated

→P.369

### Preparation before using Remote control function

#### ■ Preparation before using

Make sure to perform the following before using Remote control function:

- 1 Download the Remote Park app from the app store.
- 2 Turn the power switch to ON and register the smartphone as a Bluetooth device to the multimedia system.

For details on registering a Bluetooth device, refer to the "MULTIMEDIA OWNER'S MANUAL".

- 3 Setup the Remote Park app and register the vehicle.
- 4 The registered vehicle will be displayed on the screen of the smartphone. Select the vehicle.

The name and image of the vehicle can be changed on the new vehicle registration screen.

Vehicles can be added through the menu screen.

#### ■ Remote control function on/off

- 1 Select  and then select "Advanced Park" on the center display.
- 2 Select "Remote Park" to turn it on/off. (The default setting is on.)
- 3 Press the Advanced Park main switch.

If the switch is pressed while assistance is being performed, the assistance will be

canceled.

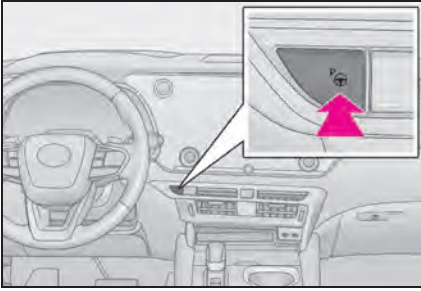

- 4 Select the  button displayed on the center display.



#### NOTICE

##### Remote control function

- When using Remote control function, make sure carry an electronic key in your pocket, etc.
- If an electronic key is held together with a smartphone, etc., the electronic key may not be able to be detected.
- Vehicles with a digital key: Remote control function cannot be used when carrying only a digital key. The driver should always carry the electronic key.
- When entering the vehicle after using Remote control function, make sure that the electronic key is brought into the vehicle and all of the doors are closed.

Vehicles with a power easy access system: After entering the vehicle and ending Remote control function operation, the seat return function will operate when the driver's seat seat belt is fastened or the brake pedal is depressed.

- If the power switch is turned off when Remote control function operation has finished or been canceled, the doors will be locked automatically. However, if a door is open, it may not be locked. Check the vehicle condition after Remote control function operation has finished.

- When the doors are locked after Remote control function operation has finished or been canceled, an alarm may sound if someone is detected inside the vehicle.

##### Situations in which the function may not operate correctly

- When the functions of the smart access system with push button start may not operate correctly: →P.142
- When the vehicle is near fluorescent lights

##### Radio wave interference: →P.143

##### Electronic key battery consumption

- When Remote control function is being used, the electronic key battery will be used as the electronic key will continuously send and receive radio waves.
- If the electronic key battery is depleted: →P.501

##### Situations in which the sensors may not operate properly

→P.330

- When using Remote control function, visibility of the area around the vehicle may be limited. Make sure to check the following when using Remote control function:
  - The vehicle and area around the vehicle are clearly visible
  - There are no people, animals, or objects in the path of the vehicle

**NOTICE**

- An appropriate distance from the vehicle can be maintained and the safety of yourself and others can be ensured
- Caution for the area around the vehicle is always maintained and there is no potential for danger
- You can cancel Remote control function immediately if necessary

**Advanced Park cancelation/suspension****■ Assistance will be canceled when**

In situations such as the following, Advanced Park operation will be canceled. Firmly hold the steering wheel and depress the brake pedal to stop the vehicle.

As system operation has been canceled, begin the operation again or continue parking manually, using the steering wheel.

- The Advanced Park main switch is pushed
- The shift position has been shifted to P
- The parking brake is engaged
- A door or the back door is opened
- The driver's seat belt is unfastened
- The outside rear view mirrors are folded
- The TRAC or VSC is turned off
- The TRAC, VSC or ABS operates
- The power switch is pressed
- The system determines assistance

cannot be continued in the current parking environment

- The system malfunctions
  - While the vehicle was stopped, "Cancel" was selected on the center display
- Assistance will be suspended when**

In situations such as the following, Advanced Park operation will be suspended.

Assistance can be started again by following the directions displayed on the center display.

Also, when assistance is suspended, if the shift position is shifted twice with the brake pedal depressed, assistance will be canceled in that shift position. However, if assistance is suspended by shifting the shift position, assistance will be canceled if the shift position is shifted once.

- The steering wheel is operated
- The accelerator pedal is depressed
- The shift position has been shifted
- The shift position was shifted while the vehicle was moving (except to P position)
- A moving object or stationary object that may collide with your vehicle has been detected, resulting in the operation of the hybrid system output control/braking control.
- Camera switch is pressed

**■ Remote control function assistance will be canceled when**

In situations such as the following,

Remote control function operation will be canceled.

As system operation has been canceled, while carrying an electronic key, enter the vehicle and park the vehicle manually, using the steering wheel.

- When a condition for stopping Advanced Park assistance is met, with the exception suspension due to a door being opened or the driver's seat belt being released
- When Remote control function is operated while the remote air conditioning is operating and the power switch is changed to ON before remote air conditioning has ended
- When 5 minutes have elapsed since Remote control function operation was started
- When 3 minutes have elapsed since any operation was performed
- When 30 seconds have elapsed with the vehicle not being able to be driven, even though the screen of the smartphone is being operated to drive the vehicle
- When the power button on the screen of the smartphone is selected
- When the Remote Park app is force closed
- When the vehicle is on a steep slope
- When an electronic key is detected inside the vehicle while Remote control function operation is suspended

- When the ambient temperature is 14°F (-10°C) or less

#### ■ Remote control function assistance will be suspended when

In situations such as the following, assistance will be suspended.

- When the Bluetooth communication between the smartphone and multimedia system get lost
- When smartphone continuous operation is suspended
- When the Remote Park app is pushed to the background (a call is received, the home button is pressed, etc.)
- When electronic key does not detected
- When there is an obstruction in the movement direction of the vehicle
- When the vehicle is operated while it is being driven by assistance
- When the smart key is operated while it is being driven by assistance
- When the door is unlocked while it is being driven by assistance
- When a door is opened while the vehicle is being driven

### Changing the Advanced Park settings

Select  on the center display, and then select "Advanced Park".

#### ■ Remote Park\*

Remote control function can be turned on/off.

### ■ Speed Profile

The vehicle speed for when assistance is performed can be set.

This setting cannot be changed when registering a parking space to the memory function.

### ■ Obstacle detection range

The distance from which obstacles will be avoided while assistance is being performed can be set.

### ■ Preferred parking method

The preferred parking direction displayed when at a parking space which perpendicular (forward/reverse) or parallel parking is possible can be set.

### ■ Preferred parking direction

The preferred parking direction displayed when it is possible to pull perpendicular forward or reverse into a parking space can be selected.

### ■ Preferred exit direction (perpendicular)

The preferred exit direction displayed when it is possible to pull forward or reverse to the left or right out of a parking space can be selected.

### ■ Preferred exit direction (parallel)

The preferred exit direction displayed when it is possible to exit to the left or right from a parallel parking space can be selected.

### ■ Camera view when parking

The display angle of the camera image when using the perpendicular parking (forward/reverse) function or parallel parking function can be set.

### ■ Camera view when exiting

The display angle of the camera image when using the perpendicular exiting (forward/reverse) function or parallel parking exit function can be set.

### ■ Parking path adjustment

The course for when parking assistance is operating can be adjusted inward or outward.

If the tires are worn, the path of vehicle may be offset from the center of the parking space. In this case, use this setting to adjust the parking course.

### ■ Road width adjustment

When parking assistance is started, the amount of lateral movement while the vehicle is moving forward can be adjusted.

### ■ Park position adjustment (forward)

The position at which perpendicular parking (forward) is completed can be adjusted. (Except when using the memory function.)

### ■ Park position adjustment (reverse)

The position at which perpendicular parking (reverse) is completed can be adjusted. (Except when using the memory function.)

### ■ Rear accessory setting

If an accessory, such as a trailer hitch, has been installed to the rear of the vehicle, the length of the rear of the vehicle can be adjusted to help avoid colliding with objects to the rear of the vehicle.

### ■ Clear registered parking space

The parking spaces registered to the memory function can be deleted. Parking space information cannot be deleted when assistance is being performed or when registering parking space information to the memory function.



#### NOTICE

- Take care when using the park position adjustment (forward) or park position adjustment (reverse) for adjusting because the vehicle may collide with parking blocks, curb stones, or other low objects.
- If it is likely that your vehicle will collide with a nearby vehicle/object, parking block, curb stone, etc., depress the brake pedal to stop the vehicle and press the Advanced Park main switch to disable the system.

## Changing the Remote Park app settings

### ■ Intuitive parking assist warning sound ON/OFF (Smartphone setting)

The warning sounds of the intuitive parking assist from smartphone application can be turned on/off using the Remote Park app.

### ■ Intuitive parking assist warning sound volume adjustment (Smartphone setting)

The volume of the warning sounds of the intuitive parking assist from smartphone application can be adjusted using the Remote Park app.

## Advanced Park displayed messages

The operating state, assistance operation, etc. of the Advanced Park is displayed on the center display. If a message is displayed, respond according to the content displayed.

### ■ If “No available parking space” is displayed

Move the vehicle to a location where a parking space or parking lines can be detected.

### ■ If “Unavailable in current condition” is displayed

Move the vehicle to another location and use the system.

### ■ If “Not enough space to exit” is displayed

The parallel parking exit function cannot be used due to a situation such as the distance between your vehicle and vehicles parked in front of and behind your vehicle being short, the existence of an object in the exit direction, etc.

Check the conditions of the area around your vehicle and exit from the parking space manually.

### ■ If “Cannot control speed” is displayed

The system judged that it cannot adjust the speed of the vehicle when using the system in an area with a slope or step and assistance was canceled.

Use the system in a level location.

### ■ If “Obstacle detected” is displayed

As a moving object or stationary object that may collide with your vehicle has been detected, the hybrid system output control/braking control operates to suspend Advanced Park assistance.

Check the condition of the surrounding area. To resume assistance, select the “Start” button on the center display.

- If “No available parking space to register” is displayed

This message is displayed when  $\triangle P_{\rightarrow}$  is selected at a parking space that cannot be detected.

Operate the system at a parking space where differences in the road surface can be recognized. (→P.376)

## Driving mode select switch

The driving modes can be selected to suit driving conditions.

### Selecting a drive mode

- 1 Select  on the center display.
- 2 Select “Drive mode”.
- 3 Select driving mode.

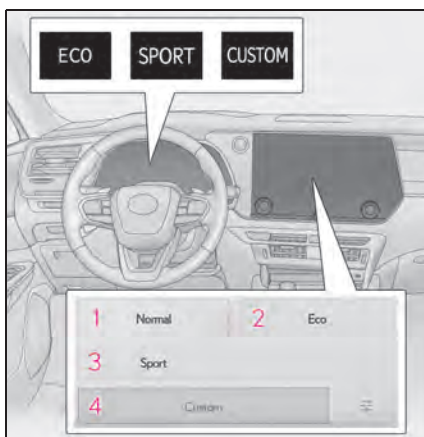

#### 1 Normal mode

Provides an optimal balance of fuel economy, quietness, and dynamic performance. Suitable for city driving.

#### 2 Eco drive mode

Helps the driver accelerate in an eco-friendly manner and improve fuel economy through moderate throttle characteristics and by controlling the operation of the air conditioning system (heating/cooling).

When the Eco drive mode is selected, Eco drive mode indicator comes on.

#### 3 Sport mode

Vehicles without Adaptive Variable Suspension System: Controls the hybrid sys-

tem to provide quick, powerful acceleration. This mode also changes the steering feel, making it suitable for when agile driving response is desired, such as when driving on roads with many curves.

Vehicles with Adaptive Variable Suspension System: Helps to ensure steering performance and driving stability by simultaneously controlling the steering and suspension in addition to the hybrid system. Suitable for sportier driving.

When the Sport mode is selected, "Sport" indicator will come on.

#### 4 Custom mode

Allows you to drive with the power train, steering, suspensions\* and air conditioning system functions set to your preferred settings. (→P.590)

When the Custom mode is selected, Custom mode indicator comes on.

\*: Vehicles with Adaptive Variable Suspension System

#### ■ When a driving mode other than normal mode is selected

The AWD control switches to that suitable for the selected driving mode.

#### ■ Operation of the air conditioning system in Eco drive mode

Eco drive mode controls the heating/cooling operations and fan speed of the air conditioning system to enhance fuel efficiency. To improve air conditioning performance, perform the following operations:

- Adjust the fan speed (→P.411)
- Turn off Eco drive mode

#### ■ Automatic deactivation of sport mode and custom mode

If the power switch is turned off after driving in sport mode or custom mode, the drive mode will be changed to normal mode.

#### ■ Display of the multi-information display according to selected driving mode

According to the driving mode selected, the gauges displayed on the multi-information display may change.

#### ■ Customization

Some functions can be customized. (→P.590)

## Trail Mode

Trail Mode is designed to control the spinning of the drive wheels by integratedly controlling 4WD, brake and drive force control systems. Use the Trail Mode when driving bumpy roads, etc.

### Enabling the system

Press the Trail Mode switch.

Press the Trail Mode switch, to turn the Trail Mode on. The Trail Mode indicator light will come on the multi-information display.

To turn the system off, press the Trail Mode switch again.

#### ▶ RX500h

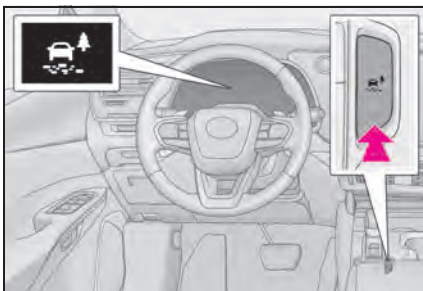

#### ▶ RX350h

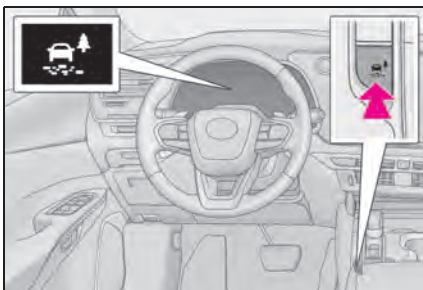

## When the Trail Mode is operating

If the tires are spinning, the slip indicator flashes to indicate that the Trail Mode is controlling the spinning of the tires.



### ■ Trail Mode

- Trail Mode controls the vehicle so that it can use the maximum amount of drive force when driving on rough roads. As a result, fuel efficiency may diminish when compared to driving with Trail Mode off.
- If Trail Mode is continuously used for a long period of time, depending on the driving conditions, the load on related parts increases and the system may not function correctly. In this case, "Traction Control Turned OFF" will be shown on the multi-information display but the vehicle can be driven normally. The "Traction Control Turned OFF" on the multi-information display will turn off after a short while and the system will operate properly.

### ■ When Trail Mode is canceled

In the following situations, Trail Mode is automatically canceled even if it is selected:

- When the driving mode is changed. (→P.390)
- When the hybrid system is restarted.

### ■ Sounds and vibrations when driving in Trail Mode

Any of the following conditions may occur when Trail Mode is operating. None of

these indicates that a malfunction has occurred:

- Vibrations may be felt throughout the vehicle or steering
- Sounds may be heard from the engine compartment
- **When the Trail Mode indicator does not illuminate**

When the Trail Mode indicator does not illuminate even though the Trail Mode switch is pressed, the system may be malfunctioning. Have the vehicle inspected by your Lexus dealer immediately.



### WARNING

#### ■ Before using Trail Mode

Make sure to observe the following precautions. Failure to observe these precautions may result in an unexpected accident.

- Trail mode is intended for use when driving on rough roads.
- Check that the Trail Mode indicator is illuminated before driving.
- Trail Mode is not intended to expand the limits of the vehicle. Thoroughly check the road conditions and drive with caution.



### NOTICE

#### ■ In order to ensure that Trail Mode operates properly

Do not continuously use the Trail Mode for a long period of time. Depending on the driving conditions, the load on related parts increases and the system may not operate properly.

## Driving assist systems

To keep driving safety and performance, the following systems operate automatically in response to various driving situations. Be aware, however, that these systems are supplementary and should not be relied upon too heavily when operating the vehicle.

### Summary of the driving assist systems

#### ■ ECB (Electronically Controlled Brake System)

The electronically controlled system generates braking force corresponding to the brake operation

#### ■ ABS (Anti-lock Brake System)

Helps to prevent wheel lock when the brakes are applied suddenly, or if the brakes are applied while driving on a slippery road surface

#### ■ Brake assist

Generates an increased level of braking force after the brake pedal is depressed when the system detects a panic stop situation

#### ■ VSC (Vehicle Stability Control)

Helps the driver to control skidding when swerving suddenly or turning on slippery road surfaces.

#### ■ Enhanced VSC (Enhanced Vehicle Stability Control)

Provides cooperative control of the ABS, TRAC, VSC and EPS.

Helps to maintain directional stability when swerving on slippery road surfaces by controlling steering performance.

#### ■ Trailer Sway Control

Helps the driver to control trailer sway by selectively applying brake pressure for individual wheels and reducing driving torque when trailer sway is detected.

#### ■ TRAC (Traction Control)

Helps to maintain drive power and prevent the drive wheels from spinning when starting the vehicle or accelerating on slippery roads

#### ■ Active Cornering Assist (ACA)

Helps to prevent the vehicle from drifting to the outer side by performing inner wheel brake control when attempting to accelerate while turning

#### ■ Hill-start assist control

Helps to reduce the backward movement of the vehicle when starting on an uphill

#### ■ DRS (Dynamic Rear Steering) (RX 500h)

Contributes to maneuverability at low speeds, responsiveness at medium speeds and stability at high speeds by controlling the steering angle of the rear wheels in accordance with the steering wheel operation and vehicle speed.

#### ■ EPS (Electric Power Steering)

Employs an electric motor to reduce the amount of effort needed to turn the

steering wheel

#### ■ E-Four<sup>\*1</sup>/DIRECT4<sup>\*2</sup> (Electronic AWD system)

<sup>\*1</sup>: RX350h

<sup>\*2</sup>: RX500h

Automatically controls the drive torque distribution between the front and rear wheels according to various running conditions including normal driving, during cornering, on a uphill, when starting off, during acceleration, on a slippery roads due to snow or rain, thus contributing to stable operability and driving stability.

#### ■ Adaptive Variable Suspension System (if equipped)

By independently controlling the damping force of the shock absorbers for each of the 4 wheels according to the road and driving conditions, this system helps riding comfort with superior vehicle stability, and helps good vehicle posture.

Also, the damping force changes depending on the selected driving mode. (→P.390)

#### ■ VDIM (Vehicle Dynamics Integrated Management) (RX 500h)

Provides integrated control of the ABS, brake assist, TRAC, VSC, hill-start assist control, EPS, DRS and Adaptive Variable Suspension systems. Helps to maintain vehicle stability when swerving on slippery road surfaces by controlling the brakes, hybrid system output, steering assist and steering ratio.

## ■ The Secondary Collision Brake

When the SRS airbag sensor detects a collision and the system operates, the brakes and brake lights are automatically controlled to reduce the vehicle speed and help reduce the possibility of further damage due to a secondary collision.

## ■ When the TRAC/VSC/ABS/DRS\* / Trailer Sway Control systems are operating

The slip indicator light will flash while the TRAC/VSC/ABS/DRS\*/TrailerSwayControl systems are operating.

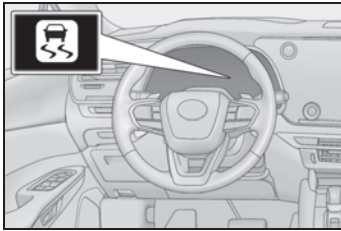

\* : Only when DRS is operated in line with VDIM

## ■ Disabling the TRAC system

If the vehicle gets stuck in mud, dirt or snow, the TRAC system may reduce power from the hybrid system to the wheels. Pressing the  switch to turn the system off may make it easier for you to rock the vehicle in order to free it.

To turn the TRAC system off, quickly press and release the  switch.

The "Traction Control Turned OFF" will be shown on the multi-information display.

Press the  switch again to turn the system back on.

## ▶ RX500h

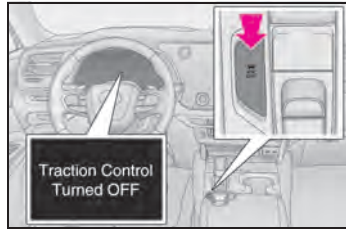

## ▶ RX350h

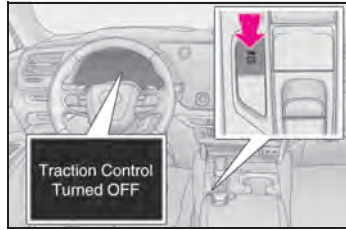

## ■ Turning off both TRAC, VSC and Trailer Sway Control systems

To turn the TRAC, VSC and Trailer Sway Control systems off, press and hold the

 switch for more than 3 seconds while the vehicle is stopped.

The VSC OFF indicator light will come on and the "Traction Control Turned OFF" will be shown on the multi-information display.\*

Press the  switch again to turn the system back on.

\* : On vehicles with PCS (Pre-Collision System), PCS will also be disabled (only Pre-Collision warning is available). The PCS warning light will come on and a message will be displayed on the multi-information display. (→P.261)

## ■ When the message is displayed on the multi-information display showing that TRAC has been disabled even if the

 switch has not been pressed

TRAC is temporarily deactivated. If the information continues to show, contact your Lexus dealer.

### ■ Operating conditions of hill-start assist control

When the following four conditions are met, the hill-start assist control will operate:

- The shift position is in a position other than P or N (when starting off forward/backward on an upward incline)
- The vehicle is stopped
- The accelerator pedal is not depressed
- The parking brake is not engaged
- Power switch is turned to ON

### ■ Automatic system cancellation of hill-start assist control

The hill-start assist control will turn off in any of the following situations:

- The shift position is shifted to P or N
- The accelerator pedal is depressed
- The brake pedal is depressed and the parking brake is engaged
- A maximum of 2 seconds have elapsed after the brake pedal is released
- Power switch is turned to OFF

### ■ Turning path when DRS operates

Turning radius of the vehicle is reduced by steering the rear wheels in the opposite direction from the front wheels at low speeds. At this time, the rear wheels pass outside in case of moving forward or inside in case of reversing than the vehicle without the DRS system. Therefore, take care also to observe the rear of the vehicle when moving forward or the side of the vehicle when reversing in narrow spaces such as parking lots.

#### ▶ When moving forward

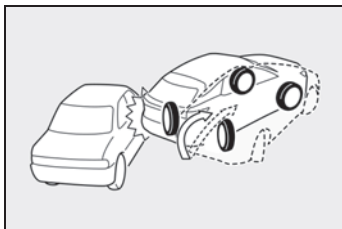

#### ▶ When reversing

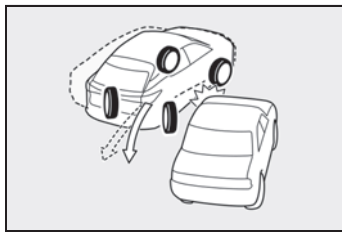

### ■ DRS is disabled when

DRS may stop operating in the following situations. In this case, the minimum turning radius becomes larger than when the DRS system operates.

- When the steering wheel is operated for an extended period of time while the vehicle is moving very slowly
- When the vehicle is started and stopped repeatedly in a short period of time with the steering wheel operated

The system will restart after these situations have passed.

- When the 12-volt battery terminals are disconnected and reconnected

The system will restart when the vehicle has been driven for a certain amount of time after the 12-volt battery terminals are connected.

### ■ Sounds and vibrations caused by the ABS, brake assist, VSC, Trailer Sway Control, TRAC and hill-start assist control systems

- A sound may be heard from the engine compartment when the brake pedal is depressed repeatedly, when the hybrid system is started or just after the vehicle begins to move. This sound does not indicate that a malfunction has occurred in any of these systems.
- Any of the following conditions may occur when the above systems are operating. None of these indicates that a malfunction has occurred.
  - Vibrations may be felt through the vehicle body and steering.
  - A motor sound may be heard also after the vehicle comes to a stop.

### ■ ECB operating sound

ECB operating sound may be heard in the following cases, but it does not indicate that a malfunction has occurred.

- Operating sound heard from the engine compartment when the brake pedal is operated.
- Motor sound of the brake system heard from the front part of the vehicle when the driver's door is opened.
- Operating sound heard from the engine compartment when one or two minutes passed after the stop of the hybrid system.

### ■ Active Cornering Assist operation sounds and vibrations

When the Active Cornering Assist is operated, operation sounds and vibrations may be generated from the brake system, but this is not a malfunction.

### ■ EPS operation sound

When the steering wheel is operated, a motor sound (whirring sound) may be heard. This does not indicate a malfunction.

### ■ Reduced effectiveness of the EPS system

The effectiveness of the EPS system is reduced to prevent the system from overheating when there is frequent steering input over an extended period of time. The steering wheel may feel heavy as a result. Should this occur, refrain from excessive steering input or stop the vehicle and turn the hybrid system off. The EPS system should return to normal within 10 minutes.

### ■ Automatic reactivation of TRAC, Trailer Sway Control and VSC systems

After turning the TRAC, Trailer Sway Control and VSC systems off, the systems will be automatically re-enabled in the following situations:

- When the power switch is turned off
- If only the TRAC system is turned off, the TRAC will turn on when vehicle speed increases  
If both the TRAC and VSC systems are turned off, automatic re-enabling will not occur when vehicle speed increases.

### ■ Operating conditions of Active Cornering Assist

The system operates when the following occurs.

- TRAC/VSC can operate
- The driver is attempting to accelerate while turning
- The system detects that the vehicle is drifting to the outer side
- The brake pedal is released

### ■ Secondary Collision Brake operating conditions

The system operates when the SRS airbag sensor detects a collision while the vehicle is in motion. However, the system does not operate when the components are damaged.

### ■ Secondary Collision Brake automatic cancellation

The system is automatically canceled in any of the following situations.

- The vehicle speed drops below approximately 0 mph (0 km/h)
- A certain amount of time elapses during operation
- The accelerator pedal is depressed a large amount

### ■ When "DRS Malfunction Visit Your Dealer" is displayed on the multi-information display

DRS may not operate properly. At this time, the minimum turning radius may become larger than when the DRS system operates properly or the vehicle may go straight with the steering wheel turned. Have the vehicle inspected by your Lexus dealer.

### ■ If a message about AWD is shown on the multi-information display

Perform the following actions.

- "AWD System Overheated Switching to 2WD Mode"

AWD system is overheated. Stop the vehicle in a safe place with the hybrid system running.

If the message disappears after a while, there is no problem. If the message remains,

have the vehicle inspected by your Lexus dealer immediately.

- “AWD System Overheated 2WD Mode Engaged”

AWD system has been temporarily released and switched to front-wheel drive due to overheating. Stop the vehicle in a safe place with the hybrid system running.

- “AWD System Malfunction 2WD Mode Engaged Visit Your Dealer”

A malfunction occurs in the AWD system. Have the vehicle inspected by your Lexus dealer immediately.

\*: When stopping the vehicle, do not stop the hybrid system until the display message has turned off.



## WARNING

### ■ The ABS does not operate effectively when

- The limits of tire gripping performance have been exceeded (such as excessively worn tires on a snow covered road).
- The vehicle hydroplanes while driving at high speed on wet or slick roads.

### ■ Stopping distance when the ABS is operating may exceed that of normal conditions

The ABS is not designed to shorten the vehicle's stopping distance. Always maintain a safe distance from the vehicle in front of you, especially in the following situations:

- When driving on dirt, gravel or snow-covered roads
- When driving with tire chains
- When driving over bumps in the road
- When driving over roads with potholes or uneven surfaces

### ■ TRAC/VSC may not operate effectively when

Directional control and power may not be achievable while driving on slippery road surfaces, even if the TRAC/VSC system is operating. Drive the vehicle carefully in conditions where stability and power may be lost.

### ■ Active Cornering Assist does not operate effectively when

- Do not overly rely on Active Cornering Assist. Active Cornering Assist may not operate effectively when accelerating down slopes or driving on slippery road surfaces.
- When Active Cornering Assist frequently operates, Active Cornering Assist may temporarily stop operating to ensure proper operation of the brakes, TRAC and VSC.

### ■ Hill-start assist control does not operate effectively when

- Do not overly rely on hill-start assist control. Hill-start assist control may not operate effectively on steep inclines and roads covered with ice.
- Unlike the parking brake, hill-start assist control is not intended to hold the vehicle stationary for an extended period of time. Do not attempt to use hill-start assist control to hold the vehicle on an incline, as doing so may lead to an accident.

### ■ When the TRAC/ABS/VSC/Trailer Sway Control is activated

The slip indicator light flashes. Always drive carefully. Reckless driving may cause an accident. Exercise particular care when the indicator light flashes.

**WARNING****■ When the TRAC/VSC/Trailer Sway Control systems are turned off**

- Be especially careful and drive at a speed appropriate to the road conditions. As these are the systems to help ensure vehicle stability and driving force, do not turn the TRAC/VSC/Trailer Sway Control systems off unless necessary.
- Trailer Sway Control is part of the VSC system and will not operate if VSC is turned off or experiences a malfunction.

**■ Replacing tires**

Make sure that all tires are of the specified size, brand, tread pattern and total load capacity. In addition, make sure that the tires are inflated to the recommended tire inflation pressure level.

The ABS, TRAC, Trailer Sway Control and VSC systems will not function correctly if different tires are installed on the vehicle.

Contact your Lexus dealer for further information when replacing tires or wheels.

**■ Handling of tires and the suspension**

Using tires with any kind of problem or modifying the suspension will affect the driving assist systems, and may cause a system to malfunction.

**■ Trailer Sway Control precaution**

The Trailer Sway Control system is not able to reduce trailer sway in all situations. Depending on many factors such as the conditions of the vehicle, trailer, road surface and driving environment, the Trailer Sway Control system may not be effective. Refer to your trailer owner's manual for information on how to tow your trailer properly.

**■ If trailer sway occurs**

Observe the following precautions. Failing to do so may cause death or serious injury.

- Firmly grip the steering wheel. Steer straight ahead. Do not try to control trailer sway by turning the steering wheel.
- Begin releasing the accelerator pedal immediately but very gradually to reduce speed. Do not increase speed. Do not apply vehicle brakes.

If you make no extreme correction with the steering or brakes, your vehicle and trailer should stabilize. (→P.199)

**■ Secondary Collision Brake**

Do not rely solely upon the Secondary Collision Brake. This system is designed to help reduce the possibility of further damage due to a secondary collision, however, that effect changes according to various conditions. Overly relying on the system may result in death or serious injury.

## Hybrid electric vehicle driving tips

For economical and ecological driving, pay attention to the following points:

### Using Eco drive mode

When using Eco drive mode, the torque corresponding to the accelerator pedal depression amount can be generated more smoothly than it is in normal conditions. In addition, the operation of the air conditioning system (heating/cooling) will be minimized, improving the fuel economy. (→P.390)

### Use of Hybrid System Indicator

The Eco-friendly driving is possible by keeping the indicate of Hybrid System Indicator within Eco area. (→P.95)

### Changing the shift position

Shift the shift position to D when stopped at a traffic light, or driving in heavy traffic, etc. Shift the shift position to P when parking. When using the N position, there is no positive effect on fuel consumption.

RX350h: In the N position, the gasoline engine operates but electricity cannot be generated. Also, when using the air conditioning system, etc., the hybrid battery (traction battery) power is consumed.

## Accelerator pedal/brake pedal operation

- Drive your vehicle smoothly. Avoid abrupt acceleration and deceleration. Gradual acceleration and deceleration will make more effective use of the electric motor (traction motor) without having to use gasoline engine power.
- Avoid repeated acceleration. Repeated acceleration consumes hybrid battery (traction battery) power, resulting in poor fuel consumption. Battery power can be restored by driving with the accelerator pedal slightly released.

### When braking

Make sure to operate the brakes gently and in a timely manner. A greater amount of electrical energy can be regenerated when slowing down.

### Delays

Repeated acceleration and deceleration, as well as long waits at traffic lights, will lead to bad fuel economy. Check traffic reports before leaving and avoid delays as much as possible. When driving in a traffic jam, gently release the brake pedal to allow the vehicle to move forward slightly while avoiding overuse of the accelerator pedal. Doing so can help control excessive gasoline consumption.

## Highway driving

Control and maintain the vehicle at a constant speed. Before stopping at a toll booth or similar, allow plenty of time to release the accelerator and gently apply the brakes. A greater amount of electrical energy can be regenerated when slowing down.

## Air conditioning

Use the air conditioning only when necessary. Doing so can help reduce excessive gasoline consumption. In summer: When the ambient temperature is high, use the recirculated air mode. Doing so will help to reduce the burden on the air conditioning system and reduce fuel consumption as well.

In winter: Because the gasoline engine will not automatically cut out until it and the interior of the vehicle are warm, it will consume fuel. Also, fuel consumption can be improved by avoiding overuse of the heater.

## Checking tire inflation pressure

Make sure to check the tire inflation pressure frequently. Improper tire inflation pressure can cause poor fuel economy.

Also, as snow tires can cause large amounts of friction, their use on dry roads can lead to poor fuel economy. Use tires that are appropriate for the season.

## Luggage

Carrying heavy luggage will lead to poor fuel economy. Avoid carrying unnecessary luggage. Installing a large roof rack will also cause poor fuel economy.

## Warming up before driving

Since the gasoline engine starts up and cuts out automatically when cold, warming up the engine is unnecessary. Moreover, frequently driving short distances will cause the engine to repeatedly warm up, which can lead to excess fuel consumption.

## Winter driving tips

Carry out the necessary preparations and inspections before driving the vehicle in winter. Always drive the vehicle in a manner appropriate to the prevailing weather conditions.

### Preparation for winter

- Use fluids that are appropriate to the prevailing outside temperatures.
  - Engine oil
  - Engine/power control unit coolant
  - Washer fluid
- Have a service technician inspect the condition of the 12-volt battery.
- Have the vehicle fitted with four snow tires or purchase a set of tire chains for the front tires.

Ensure that all tires are the specified size and brand, and that chains match the size of the tires.



### WARNING

#### ■ Driving with snow tires

Observe the following precautions to reduce the risk of accidents. Failure to do so may result in a loss of vehicle control and cause death or serious injury.

- Use tires of the specified size.
- Maintain the recommended level of air pressure.
- Do not drive in excess of 75 mph (120 km/h), regardless of the type of snow tires being used.

- Use snow tires on all, not just some wheels.

#### ■ Driving with tire chains

Observe the following precautions to reduce the risk of accidents. Failure to do so may result in the vehicle being unable to be driven safely, and may cause death or serious injury.

- Do not drive in excess of the speed limit specified for the tire chains being used, or 30 mph (50 km/h), whichever is lower.
- Avoid driving on bumpy road surfaces or over potholes.
- Avoid sudden acceleration, abrupt steering, sudden braking and shifting operations that cause sudden engine braking.
- Slow down sufficiently before entering a curve to ensure that vehicle control is maintained.
- Do not use the LTA (Lane Tracing Assist) system.



### NOTICE

#### ■ Repairing or replacing snow tires

Request repairs or replacement of snow tires from Lexus dealers or legitimate tire retailers.

This is because the removal and attachment of snow tires affects the operation of the tire pressure warning valves and transmitters.

### Before driving the vehicle

Perform the following according to the driving conditions:

- Do not try to forcibly open a window or move a wiper that is frozen. Pour warm water over the frozen area to melt the ice. Wipe away the water

immediately to prevent it from freezing.

- To ensure proper operation of the climate control system fan, remove any snow that has accumulated on the air inlet vents in front of the windshield.
- Check for and remove any excess ice or snow that may have accumulated on the exterior lights, outside rear view mirrors, windows, vehicle's roof, chassis, around the tires or on the brakes.
- Remove any snow or mud from the bottom of your shoes before getting in the vehicle.
- When the outside door opener switch becomes stiff, it may be difficult to press on it. Open the door while pressing the door opener switch slightly harder.

### When driving the vehicle

Accelerate the vehicle slowly, keep a safe distance between you and the vehicle ahead, and drive at a reduced speed suitable to road conditions.

### When parking the vehicle

- Turn automatic mode of the parking brake off. Otherwise, the parking brake may freeze and not be able to be released automatically.

Also, avoid using the following as the parking brake may operate automatically, even if automatic mode is off.

- Brake hold system

- Advanced Park (Remote Controlled) (if equipped)
- Park the vehicle and shift the shift position to P without setting the parking brake. The parking brake may freeze up, preventing it from being released. If the vehicle is parked without setting the parking brake, make sure to block the wheels.

Failure to do so may be dangerous because it may cause the vehicle to move unexpectedly, possibly leading to an accident.

- When the parking brake is in automatic mode, release the parking brake after shifting the shift position to P. (→P.227)
- If the vehicle is parked without setting the parking brake, confirm that the shift position cannot be moved out of P.
- If the vehicle is left parked with the brakes damp in cold temperatures, there is a possibility of the brakes freezing.

### Selecting tire chains

Use the correct tire chain size when mounting the tire chains.

Chain size is regulated for each tire size.

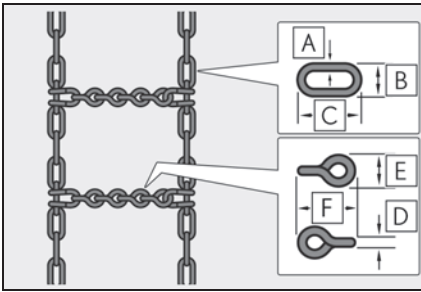

- A** Side chain (0.12 in. [3 mm] in diameter)
- B** Side chain (0.43 in. [10.8 mm] in width)
- C** Side chain (0.98 in. [25 mm] in length)
- D** Cross chain (0.15 in. [3.9 mm] in diameter)
- E** Cross chain (0.54 in. [13.8 mm] in width)
- F** Cross chain (1.00 in. [25.3 mm] in length)

### Regulations on the use of tire chains

Regulations regarding the use of tire chains vary depending on location and type of road. Always check local regulations before installing chains.

#### ■ Tire chain installation

Observe the following precautions when installing and removing chains:

- Install and remove tire chains in a safe location.
- Install tire chains on the front tires only. Do not install tire chains on the rear tires.
- Install tire chains on the front tires as tightly as possible. Retighten chains after driving 1/4—1/2 mile (0.5—1.0 km).

- Install tire chains following the instructions provided with the tire chains.

#### ⚠ NOTICE

##### ■ Fitting tire chains

The tire pressure warning valves and transmitters may not function correctly when tire chains are fitted.

### Windshield wipers

To enable the windshield wipers to be lifted when heavy snow or icy conditions are expected, change the rest position of the windshield wipers from the retracted position below the hood to the service position using the wiper lever. (→P.243)

## Utility vehicle precautions

This vehicle belongs to the utility vehicle class, which has higher ground clearance and narrower tread in relation to the height of its center of gravity.

## Utility vehicle feature

- Specific design characteristics give it a higher center of gravity than ordinary passenger cars. This vehicle design feature causes this type of vehicle to be more likely to rollover. And, utility vehicles have a significantly higher rollover rate than other types of vehicles.
- An advantage of the higher ground clearance is a better view of the road allowing you to anticipate problems.
- It is not designed for cornering at the same speeds as ordinary passenger cars any more than low-slung sports cars are designed to perform satisfactorily under off-road conditions. Therefore, sharp turns at excessive speeds may cause the vehicle to rollover.



### WARNING

#### Utility vehicle precautions

Always observe the following precautions to minimize the risk of death, serious injury or damage to your vehicle:

- In a rollover crash, an unbelted person is significantly more likely to die than a person wearing a seat belt. Therefore, the driver and all passengers should always fasten their seat belts.
- Avoid sharp turns or abrupt maneuvers, if at all possible. Failure to operate this vehicle correctly may result in loss of control or vehicle rollover causing death or serious injury.
- Loading cargo on the roof luggage carrier (if equipped) will make the center of the vehicle gravity higher. Avoid high speeds, sudden starts, sharp turns, sudden braking or abrupt maneuvers, otherwise it may result in loss of control or vehicle rollover due to failure to operate this vehicle correctly.
- Always slow down in gusty crosswinds. Because of its profile and higher center of gravity, your vehicle is more sensitive to side winds than an ordinary passenger car. Slowing down will allow you to have better control.
- Do not drive horizontally across steep slopes. Driving straight up or straight down is preferred. Your vehicle (or any similar off-road vehicle) can tip over sideways much more easily than forward or backward.

## Off-road driving

Your vehicle is not designed to be driven off-road. However, in the event that off-road driving cannot be avoided, please observe the following precautions to help avoid the areas prohibited to vehicles.

- Drive your vehicle only in areas where off-road vehicles are permitted to travel.
- Respect private property. Get

owner's permission before entering private property.

- Do not enter areas that are closed. Honor gates, barriers and signs that restrict travel.
- Stay on established roads. When conditions are wet, driving techniques should be changed or travel delayed to prevent damage to roads.
- Avoid driving on very steep, slippery roads and other surfaces, such as sand, where the tires are liable to lose traction. Your vehicle may not perform as well as conventional AWD on-road vehicles on these surfaces.

#### ■ Additional information for off-road driving

- ▶ For owners in U.S. mainland, Hawaii and Puerto Rico:

To obtain additional information pertaining to driving your vehicle off-road, consult the following organizations.

- State and Local Parks and Recreation Departments
- State Motor Vehicle Bureau
- Recreational Vehicle Clubs
- U.S. Forest Service and Bureau of Land Management



#### WARNING

##### ■ Off-road driving precautions

Always observe the following precautions to minimize the risk of death, serious injury or damage to your vehicle:

- Drive carefully when off the road. Do not take unnecessary risks by driving in dangerous places.

- Do not grip the steering wheel spokes when driving off-road. A bad bump could jerk the wheel and injure your hands. Keep both hands and especially your thumbs on the outside of the rim.
- Always check your brakes for effectiveness immediately after driving in sand, mud, water or snow.
- After driving through tall grass, mud, rock, sand, rivers, etc., check that there is no grass, bush, paper, rags, stone, sand, etc. adhering or trapped on the underbody. Clear off any such matter from the underbody. If the vehicle is used with these materials trapped or adhering to the underbody, a breakdown or fire could occur.
- When driving off-road or in rugged terrain, do not drive at excessive speeds, jump, make sharp turns, strike objects, etc. This may cause loss of control or vehicle rollover causing death or serious injury. You are also risking expensive damage to your vehicle's suspension and chassis.



#### NOTICE

##### ■ To prevent water damage

Take all necessary safety measures to ensure that water damage to the hybrid battery (traction battery), hybrid system or other components does not occur.

- Water entering the engine compartment may cause severe damage to the hybrid system. Water entering the interior may cause the hybrid battery (traction battery) stowed under the rear seats to short circuit.
- Water entering the transmission and rear electric motor (traction motor) will cause deterioration in transmission quality. The malfunction indicator may come on, and the vehicle may not be drivable.

**NOTICE**

- Water can wash the grease from wheel bearings, causing rusting and premature failure, and may also enter the transmission case, reducing the gear oil's lubricating qualities.

**■ When you drive through water**

If driving through water, such as when crossing shallow streams, first check the depth of the water and the bottom of the riverbed for firmness. Drive slowly and avoid deep water.

**■ Inspection after off-road driving**

- Sand and mud that has accumulated around brake discs may affect braking efficiency and may damage brake system components.
- Always perform a maintenance inspection after each day of off-road driving that has taken you through rough terrain, sand, mud, or water. For scheduled maintenance information, refer to the "Warranty and Services Guide/Owner's Manual Supplement/Scheduled Maintenance".



- 5-1. **Lexus Climate Concierge**  
Lexus Climate Concierge..... **410**
- 5-2. **Using the air conditioning system and defogger**  
Front automatic air conditioning system ..... **411**  
Rear air conditioning system ..... **420**  
Heated steering wheel/seat heaters/seat ventilators..... **422**
- 5-3. **Using the interior lights**  
Interior lights list..... **424**
- 5-4. **Using the storage features**  
List of storage features..... **427**  
Luggage compartment features ..... **431**
- 5-5. **Using the other interior features**  
Other interior features ..... **434**  
Using the power outlets (1500 W)..... **444**  
If the power outlets (1500 W) cannot be used..... **449**  
Garage door opener..... **450**

## Lexus Climate Concierge

The climate control seats are automatically controlled according to the set temperature of the air conditioning system, outside temperature, cabin temperature, etc. Lexus Climate Concierge allows a comfortable condition to be maintained without adjusting each system.

### Turning on Lexus Climate Concierge

Lexus Climate Concierge operates in conjunction with "AUTO" of the air conditioning system.

- 1 Select the option screen switch. (→P.411)
- 2 Select the "Climate concierge" switch.
- 3 Turn the "AUTO" switch on.

### Automatically controllable functions

- Automatic air conditioning system (→P.411)

Operation of the air conditioning system is performed automatically according to the temperature setting for the driver's side/front passenger's side.

- Seat heaters (→P.422)

Operation of the seat heaters is performed automatically according to the temperature setting for the driver's side/front passenger's side.

Operation will automatically change between the seat heaters and seat ventila-

tors according to the temperature setting of the air conditioning system, outside temperature, etc.

- Seat ventilators (→P.422)\*

Operation of the seat ventilators is performed automatically according to the temperature setting for the driver's side/front passenger's side.

Operation will automatically change between the seat heaters and seat ventilators according to the temperature setting of the air conditioning system, outside temperature, etc.

- Heated steering wheel (→P.422)\*

Operation of the heated steering wheel is performed automatically according to the temperature setting of the air conditioning system, outside temperature, etc.

\* : If equipped

### Passenger detection functions

- When a passenger is detected in the front passenger seat, the seat heater and ventilator will operate automatically.
- When the seat heater/seat ventilator switch is set to AUTO, the passenger detection function will not operate.

### Rear seat heater operation (vehicles with rear seat heaters)

The rear seat heaters are not controlled by the Lexus Climate Concierge.

## Front automatic air conditioning system

When the “AUTO” switch is on, the air outlets and fan speed will automatically be changed according to the set temperature.

### Option screen switch

▶ 14-inch center display model

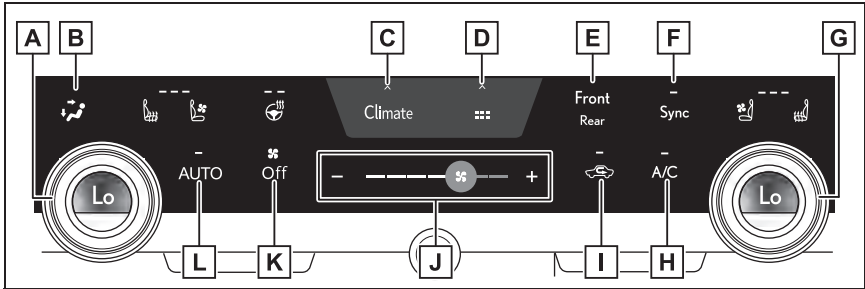

- A** Left-hand side temperature control switch
- B** Airflow mode control switch
- C** Option screen switch
- D** Shortcut screen switch  
Select to display shortcut icons for various functions.
- E** Front/rear control screen switch
- F** “Sync” switch
- G** Right-hand side temperature control switch
- H** “A/C” switch
- I** Outside/recirculated air mode switch
- J** Fan speed control switch
- K** “Off” switch
- L** “AUTO” switch

## ► 9.8-inch center display model

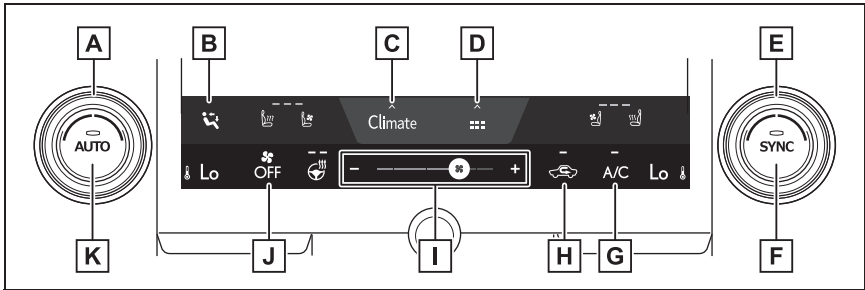

**A** Left-hand side temperature control switch

**B** Airflow mode control switch

**C** Option screen switch

**D** Shortcut screen switch

Select to display shortcut icons for various functions.

**E** Right-hand side temperature control switch

**F** "SYNC" switch

**G** "A/C" switch

**H** Outside/recirculated air mode switch

**I** Fan speed control switch

**J** "OFF" switch

**K** "AUTO" switch

### ■ Adjusting the temperature

Turn temperature control dial clockwise to increase the temperature and turn the dial counterclockwise to decrease the temperature.

When the indicator on the "Sync" switch is illuminated, the temperature setting for the front passenger's side and the rear seats side will match the setting for the driver's side.

When the indicator on the "Sync" switch is off, turning the "Sync" switch on will illuminate the "Sync" switch indicator and the temperature setting for

the front passenger's side and the rear seats side will become the same as that for the driver's side.

When the front passenger's side temperature adjustment switch is operated, the indicator on the "Sync" switch will turn off and the temperature setting for the front passenger's side will be able to be adjusted.

When the rear seats side temperature adjustment switch is operated, the indicator on the "Sync" switch will turn off and the temperature setting for the rear seats side will be able to be adjusted.

If the "A/C" indicator is turned off, the sys-

tem will blow ambient temperature air or heated air.

When the front passenger's side and the rear seats side temperature adjustment switch is operated, adjust the temperature for the driver, front passenger and rear seats separately. ("3-ZONE" mode)

### ■ Setting the fan speed

To increase the fan speed, select the "+" fan speed adjustment switch or slide the icon of the fan speed adjustment switch right. To decrease the fan speed, select the "-" fan speed adjustment switch or slide the icon of the fan speed adjustment switch left.

Select the "Off" switch to turn the fan off.

The fan can also be stopped by touching and holding the "-" fan speed adjustment switch or sliding the icon of the fan speed adjustment switch to the leftmost position and holding it.

### ■ Changing the air flow mode

Select the airflow mode control switch.

The airflow mode changes each time the switch is selected.

The air outlets and air volume changes according to the selected air flow mode.



: Air flows to the upper body



: Air flows to the upper body  
and feet



: Air flows to the feet



: Air flows to the feet and the  
windshield defogger operates

### ■ Location of air outlets

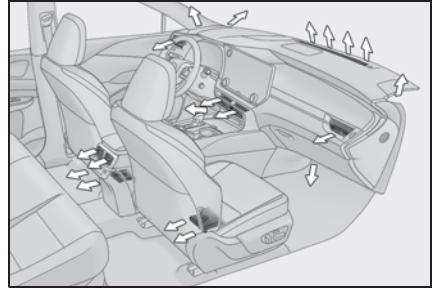

### ■ Switching between outside air and recirculated air modes

Temporarily changing the air mode to recirculated air mode is recommended to prevent dirty air from entering the vehicle, such as when in a tunnel or heavy traffic, and to help cool the interior when the outside air temperature is high.

Select the outside/recirculated air mode switch.

The air mode changes between outside air mode and recirculated air mode each time the switch is selected. When recirculated air mode is selected, the indicator will illuminate.

The air mode may change automatically depending on the temperature setting, temperature inside the vehicle, etc.

### ■ When the outside temperature exceeds 75°F (24°C) and the air conditioning system is on

- In order to reduce the air conditioning power consumption, the air conditioning system may switch to recirculated air mode automatically. This may also

reduce fuel consumption.

- Recirculated air mode is selected as a default mode when the power switch is turned to ON.
- It is possible to switch to outside air mode at any time by pressing the outside/recirculated air mode switch.

### ■ Front seat concentrated airflow mode (S-Flow)

This function automatically controls the airflow of the air conditioning system to prioritize airflow to the front seats. Fuel economy can be enhanced by reducing unnecessary cooling

Front seat concentrated airflow mode operates in the following situations.

- No passengers are detected in the rear seats
- The windshield defogger is not operating

The S-Flow switch is  (ON) on the option screen.

In front seat concentrated airflow mode, directing airflow to the front seats only and to all seats can be switched via switch operation. When the mode has been switched manually, automatic airflow control stops operating.

- 1 Select the option screen switch. (→P.411)
  - 2 Select the “S-Flow” switch.
- Indicator illuminated: Airflow to the front seats only
  - Indicator off: Airflow to all the seats

### ■ Operation of automatic airflow control

- In order to maintain a comfortable interior, airflow may be directed to seats without passengers immediately after the

hybrid system is started and at other times depending on the outside temperature.

- After the hybrid system is started, if passengers move around inside or enter/exit the vehicle, the system cannot accurately detect the presence of passengers and automatic airflow control will not operate.

### ■ Operation of manual airflow control

Even if the function is manually switched to directing airflow to only the front seats, when a rear seat is occupied, it may automatically direct airflow to all seats.

### ■ To return to automatic airflow control

- 1 With the indicator off, turn the power switch off.
- 2 After 60 minutes or more elapse, turn the power switch to ON.

### ■ Eco air conditioning mode

The air conditioning is controlled with low fuel consumption prioritized such as reducing fan speed, etc.

- 1 Select the option screen switch. (→P.411)
  - 2 Select the “Eco heat/cool” switch.
- In Eco drive mode, the air conditioning system is controlled as follows to prioritize fuel efficiency. To improve air conditioning performance, turn off Eco air conditioning mode.
    - Engine speed and compressor operation controlled to restrict heating/cooling capacity.
    - Fan speed restricted when automatic mode is selected.
  - When the driving mode is set to Eco driving mode, the Eco air conditioning mode will be turned on automatically. Even in this case, the Eco air conditioning mode can be turned

off by selecting the “Eco heat/cool”.

### ■ Warming the interior quickly (Max heat)

When “MAX heat” is turned on, in order to warm the interior quickly, the settings of the air conditioning system will be changed immediately.

- 1 Select the shortcut screen switch. (→P.411)
- 2 Select the “MAX heat” switch.
  - The temperature setting of the air conditioning system will be set to “Hi” and the “AUTO” switch will be turned on.
  - Seat heaters will be set to Hi.
  - Heated steering wheel will be set to Hi. (vehicles with heated steering wheel)
  - In the following situations, the front passenger’s side seat heater/seat ventilator will be set to “AUTO”.
    - When “Climate concierge” is on
    - When the system determines that a passenger is in the front passenger seat
    - When the indicator on the “Sync” switch is illuminated, the temperature setting for the front passenger’s side and the rear seats side will also be set to “Hi”.

### ■ Cooling the interior quickly (Max cool)

When “MAX cool” is turned on, in order to cool the interior quickly, the settings of the air conditioning system will be changed immediately.

- 1 Select the shortcut screen switch. (→P.411)
- 2 Select the “MAX cool” switch.
  - The temperature setting of the air conditioning system will be set to “Lo” and the “AUTO” switch will be turned on.
  - Seat ventilators will be set to Hi. (vehicles with seat ventilators)
  - In the following situation, the heated steering wheel will be set to “AUTO”. (vehicles with heated steering wheel)
    - When “Climate concierge” is on
  - In the following situations, the front passenger’s side seat heater/seat ventilator will be set to “AUTO”.
    - When “Climate concierge” is on
    - When the system determines that a passenger is in the front passenger seat
    - When the indicator on the “Sync” switch is illuminated, the temperature setting for the front passenger’s side and the rear seats side will also be set to “Lo”.

### ■ Defogging the windshield

Defoggers are used to defog the windshield and front side windows.

Press the windshield defogger switch.

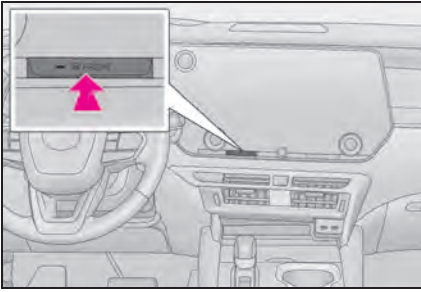

The dehumidification function will operate and the air flow will increase.

Set the outside/recirculated air mode button to outside air mode if the recirculated air mode is used. (It may switch automatically.)

To defog the windshield and the side windows early, turn the air flow and temperature up.

To return to the previous mode, press the windshield defogger switch again when the windshield is defogged.

### ■ Defogging the rear window and outside rear view mirrors

Defoggers are used to defog the rear window, and to remove raindrops, dew and frost from the outside rear view mirrors.

Press the rear window and outside rear view mirror defoggers switch.

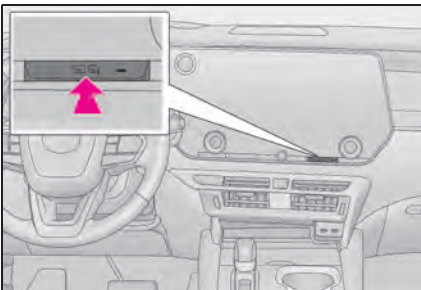

The rear window defogger and outside rear view mirror defoggers will operate and defog the rear window and outside

rear view mirrors.

The defoggers will automatically turn off after a period of time.

### ■ Windshield wiper de-icer (if equipped)

Use the windshield wiper de-icer to help prevent the windshield wiper blades from freezing to the windshield.

1 Select the option screen switch.  
(→P.411)

2 Select the “Deicer” switch.

The windshield wiper de-icer will automatically turn off after a period of time.

### ■ When driving on dusty roads

Close all windows. If dust thrown up by the vehicle is still drawn into the vehicle after closing the windows, it is recommended that the air intake mode be set to outside air mode and the fan speed to any setting except off.

### ■ When the outside temperature is low

The dehumidification function may not operate even when “A/C” is selected.

### ■ Ventilation and air conditioning odors

- To let fresh air in, set the air conditioning system to the outside air mode.
- During use, various odors from inside and outside the vehicle may enter into and accumulate in the air conditioning system. This may then cause odor to be emitted from the vents.
- To reduce potential odors from occurring:
  - It is recommended that the air conditioning system be set to outside air mode prior to turning the vehicle off.
  - The start timing of the blower may be delayed for a short period of time immediately after the air conditioning system is started in automatic mode.
- When parking, the system automatically switches to outside air mode to encourage better air circulation throughout the

vehicle, helping to reduce odors that occur when starting the vehicle.

#### ■ “MAX heat”

- The “MAX heat” switch cannot be used to turn the setting off.
- After the “MAX heat” switch has been operated, the temperature setting can be adjusted using the temperature control switches of the air conditioning system.
- When “Climate concierge” is on, if the “AUTO” switch is turned on, the seat heaters and seat ventilators\* of the front seats, and the heated steering wheel\* will be operated automatically according to the temperature setting.
- Each function can also be adjusted to the desired setting.

\* : If equipped

#### ■ “MAX cool”

- The “MAX cool” switch cannot be used to turn the setting off.
- After the “MAX cool” switch has been operated, the temperature setting can be adjusted using the temperature control switches of the air conditioning system.
- When “Climate concierge” is on, if the “AUTO” switch is turned on, the seat heaters and seat ventilators\* of the front seats, and the heated steering wheel\* will be operated automatically according to the temperature setting.
- Each function can also be adjusted to the desired setting.

\* : If equipped

#### ■ Fogging up of the windows

The windows will easily fog up when the humidity in the vehicle is high. Selecting “A/C” on will dehumidify the air from the outlets and defog the windshield effectively.

- If you turn “A/C” off, the windows may fog up more easily.
- The windows may fog up if the recirculated air mode is used.

#### ■ Air conditioning system refrigerant

- A label regarding the refrigerant of the

air conditioning system is attached to the hood at the location shown in the following illustration.

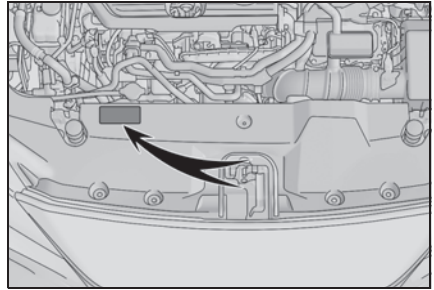

- The meaning of each symbol on the label are as follows:

	Caution
	Air conditioning system
	Air conditioning system lubricant type
	Requires registered technician to service air conditioning system
	Flammable refrigerant

#### ■ Using the voice control system

Air conditioning system can be operated using voice controls. For details, refer to the “MULTIMEDIA OWNER’S MANUAL”.

#### ■ Air conditioning filter

→P.496

#### ■ Customization

Functions that are linked to automatic mode (when the “AUTO” switch is on) can be set through “Vehicle customize” on the center display. Exhaust gas sensor sensitivity settings can also be changed. (if equipped) (→P.590)

### WARNING

- **To prevent the windshield defogger from operating improperly**
- Do not use the windshield defogger in extremely humid areas when the air conditioning system is set to a low temperature. The difference between the temperature of the outside air and that of the windshield can cause the outer surface of the windshield to fog up, blocking your vision.
- Do not place anything on the instrument panel which may cover the air outlets. Otherwise, air flow may be obstructed, preventing the windshield defoggers from defogging.

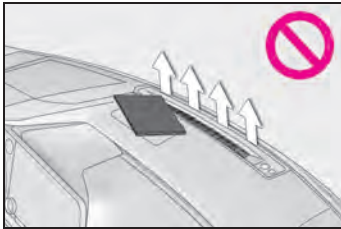

- **When the outside rear view mirror defoggers are operating**

Do not touch the surface of the outside rear view mirrors when the rear window defogger and outside rear view mirror defoggers are operating, as the surface of the mirrors will become extremely hot and may cause burns.

- **To prevent the windshield from fogging up**

Do not touch the lower part of the windshield or parts along the front pillars when the windshield wiper de-icer is on, as they will be hot and may cause burns.

### NOTICE

- **To prevent 12-volt battery discharge**

Do not leave the air conditioning system on longer than necessary when the hybrid system is off.

- **When repairing/replacing parts of the air conditioning system**

Have repair/replacement performed by your Lexus dealer.

When a part of the air conditioning system, such as the evaporator, is to be replaced, it must be replaced with a new one.

## Air outlet layout and operations

- **Adjusting the position of and opening and closing the air outlets**

To adjust the position of and opening and closing the air outlets, perform the following operations:

- ▶ Front center

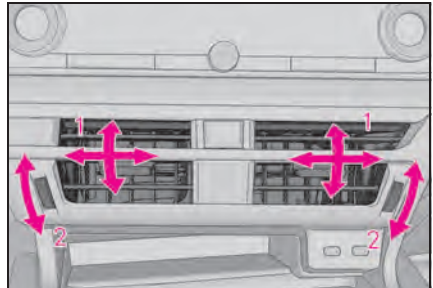

- 1** Direct air flow to the left or right, up or down
- 2** Turn the knob to open or close the vent

## ► Front side

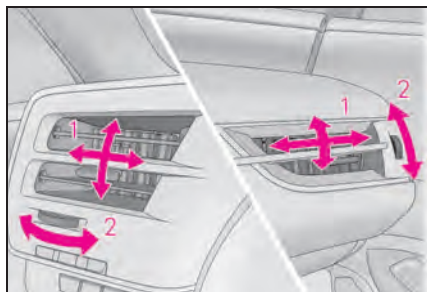

- 1 Direct air flow to the left or right, up or down
- 2 Turn the knob to open or close the vent

## ► Rear

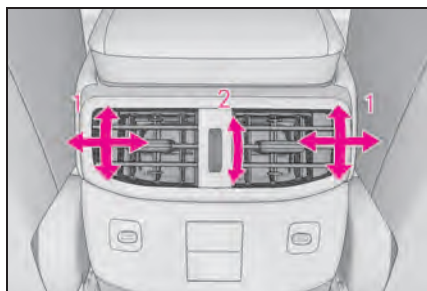

- 1 Direct air flow to the left or right, up or down
- 2 Turn the knob to open or close the vent

## Rear air conditioning system

The rear air conditioning system can be operated selecting “Rear” switch on the center display and rear air conditioning system control panel.

### Rear air conditioning control operation

#### ■ Center display

##### ▶ 14-inch center display model

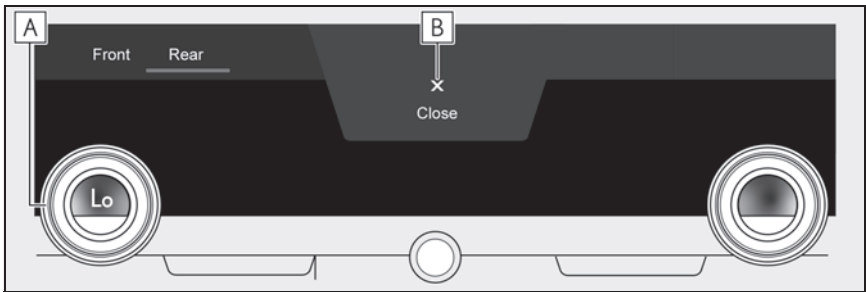

#### **A** Rear seats temperature control switch

Turn temperature control dial clockwise to increase the temperature and turn the dial counterclockwise to decrease the temperature.

#### **B** Close the rear air conditioning control screen

##### ▶ 9.8-inch center display model

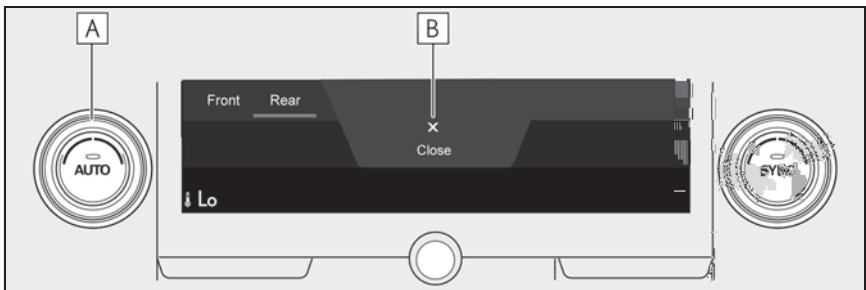

#### **A** Rear seats temperature control switch



Turn temperature control dial clockwise to increase the temperature and turn the dial counterclockwise to decrease the temperature.

#### **B** Close the rear air conditioning control screen

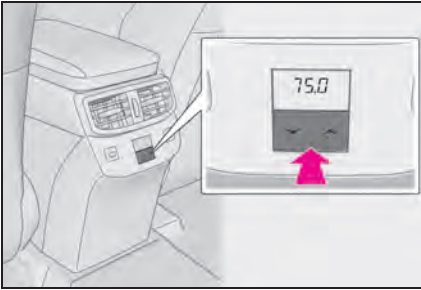
## ■ Rear air conditioning system control panel



Adjust the rear seats temperature setting

Press  to increase the temperature and  to decrease the temperature.

## Adjusting the temperature setting of the rear seats

The temperature setting of the rear seats can be adjusted using the following methods:

- When the “Sync” indicator is on:  
Adjust the driver’s seat temperature.

Adjust the temperature setting of each rear seat using the center display or rear air conditioning system control panel.

- Adjust the temperature setting of rear seats using the center display (rear air conditioning control screen) or rear air conditioning system control panel.

## Air outlets

→P.418

### NOTICE

#### ■ To prevent 12-volt battery discharge

Do not leave the air conditioning system on longer than necessary when the hybrid system is off.

## Heated steering wheel\*/seat heaters/seat ventilators\*

\*: If equipped

### ● Heated steering wheel

Warms up the grip of the steering wheel

### ● Seat heaters

Warm up the seat upholstery

### ● Seat ventilators

Maintain good ventilation using a fan built into the seat

## WARNING

### ■ To prevent minor burn injuries

Care should be taken if anyone in the following categories comes in contact with the steering wheel or seats when the heater is on:

- Babies, small children, the elderly, the sick and the physically challenged
- Persons with sensitive skin
- Persons who are fatigued
- Persons who have taken alcohol or drugs that induce sleep (sleeping drugs, cold remedies, etc.)

## NOTICE

### ■ To prevent damage to the seat heaters

Do not put heavy objects that have an uneven surface on the seat and do not stick sharp objects (needles, nails, etc.) into the seat.

### ■ To prevent 12-volt battery discharge

Do not use the functions when the hybrid system is off.

## Heated steering wheel

Select  on the center display.

Each time the switch is selected, the operation condition changes as follows.

AUTO→Hi (2 segments lit)→Lo (1 segment lit)→Off

The level indicator (red) lights up during operation. "AUTO" indicator lights up during automatic operation.

### ■ Operation condition



The power switch is in ON.

### ■ Customization

The temperature setting of the heated steering wheel can be set through "Vehicle customize" on the center display. (→P.590)

## Seat heaters

### ■ Front seats

Select  or  on the center display.

Each time the switch is selected, the operation condition changes as follows.

AUTO→Hi (3 segments lit)→Mid (2 segments lit)→Lo (1 segment lit)→Off

#### ▶ Vehicles without seat ventilators

The level indicator (red) lights up during operation. "AUTO" indicator lights up during automatic operation.

#### ▶ Vehicles with seat ventilators

The level indicator (yellow) lights up during operation.

### ■ Rear seats\*

Press the switch.

Each time the switch is selected, the operation condition changes as follows.

Hi (3 segments lit)→Mid (2 segments lit)→Lo (1 segment lit)→Off

The level indicators (yellow) light up during operation.



\* : If equipped

#### ■ Operation condition

The power switch is in ON.

#### ■ Customization

The temperature setting of the seat heaters of the front seats can be set through "Vehicle customize" on the center display. (→P.590)

The level indicator (blue) lights up during operation. "AUTO" indicator lights up during automatic operation.

#### ■ Operation condition

The power switch is in ON.

#### ■ Air conditioning system-linked control mode

When a seat ventilator is set to Hi, the fan speed of the seat ventilator may increase according to the fan speed of the air conditioning system.

#### ■ Customization

The temperature setting of the seat ventilators of the front seats can be set through "Vehicle customize" on the center display. (→P.590)



### ⚠ WARNING

#### ■ To prevent overheating and minor burn injuries

Observe the following precautions when using the seat heaters.

- Do not cover the seat with a blanket or cushion when using the seat heater.
- Do not use seat heater more than necessary.

### Seat ventilators (front seats)

Select  or  on the center display.

Each time the switch is pressed, the operation condition changes as follows.

AUTO→Hi (3 segments lit)→Mid (2 segments lit)→Lo (1 segment lit)→Off

## Interior lights list

### Location of the interior lights

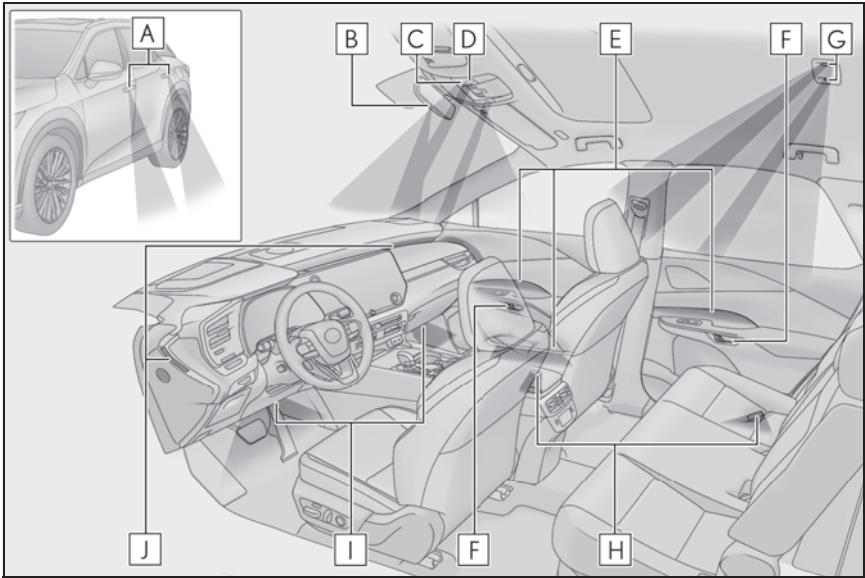

- A** Outer foot lights
- B** Shift lever light
- C** Interior lights (→P.425)
- D** Front personal lights (→P.425)
- E** Door trim ornament lights <sup>\*1,2</sup>
- F** Inside door handle lights <sup>\*1</sup>
- G** Rear personal lights (→P.425)
- H** Door courtesy lights
- I** Footwell lights
- J** Instrument panel ornament lights <sup>\*1</sup>

<sup>\*1</sup>: The illumination color can also be changed. <sup>\*2</sup>

Refer to the "MULTIMEDIA OWNER'S MANUAL" to change the settings.

<sup>\*2</sup>: If equipped

## Operating the interior lights

### ■ Turning the interior lights on/off

Touch the light

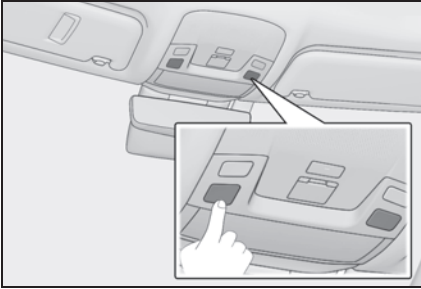

### ■ Turning the door position on

Press the door-linked interior light switch

The lights are turned on and off according to whether the doors are opened/closed.

When the door position is on, the indicator

**A** illuminates.

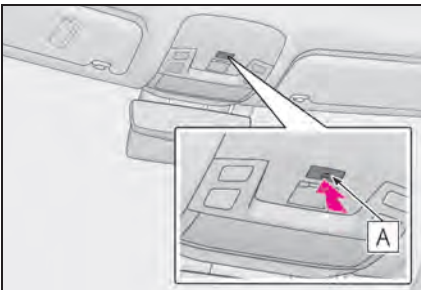

## Operating the personal lights

### ■ Turning the front personal lights on/off

Touch the light

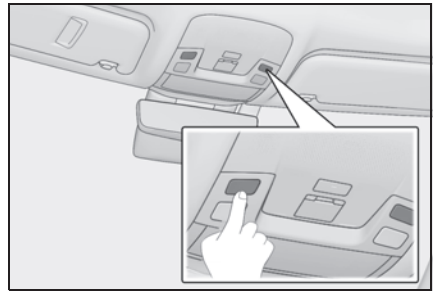

### ■ Turning the rear personal lights on/off

Touch the light

The rear interior lights turn on/off together the front interior lights.

When a door is opened while the door position is on, the lights turn on.

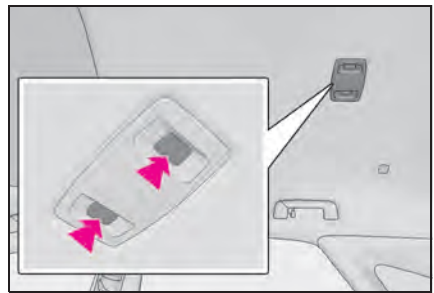

### ■ Illuminated entry system

The lights automatically turn on/off according to the power switch mode, the presence of the electronic key, whether the doors are locked/unlocked, and whether the doors are opened/closed. Also, the brightness of the lights is automatically adjusted linked with the shift operation.

### ■ To prevent the 12-volt battery from being discharged

If the interior lights remain on when the power switch is turned off, the lights will go off automatically after 20 minutes.

### ■ When interior light or personal lights do not respond as normal

In the following cases, the interior lights and personal lights may not respond as normal.

- When water, dirt, etc., have adhered to the lens surface
- When operated with a wet hand
- When wearing gloves, etc.

#### ■ The interior lights may turn on automatically when

If any of the SRS airbags deploy (inflate) or in the event of a strong rear impact, the interior lights will turn on automatically.

The interior lights will turn off automatically after approximately 20 minutes.

The interior lights can be turned off manually. However, in order to help prevent further collisions, it is recommended that they be left on until safety can be ensured.

(The interior lights may not turn on automatically depending on the force of the impact and conditions of the collision.)

#### ■ Using the voice control system\*

\* : If equipped

The following operations can be performed using the voice control system.

- Turning interior light on/off
- Changing color of each lights\*

For details, refer to the "MULTIMEDIA OWNER'S MANUAL".

\* : If equipped

#### ■ Customization

Some functions can be customized.  
(→P.590)



#### NOTICE

##### ■ Removing light lenses

Never remove the lens for the interior light and personal lights. Otherwise, the lights will be damaged. If the lens need to remove, contact your Lexus dealer.

##### ■ To prevent 12-volt battery discharge

Do not leave the lights on longer than necessary when the hybrid system is off.

## List of storage features

### Location of the storage features

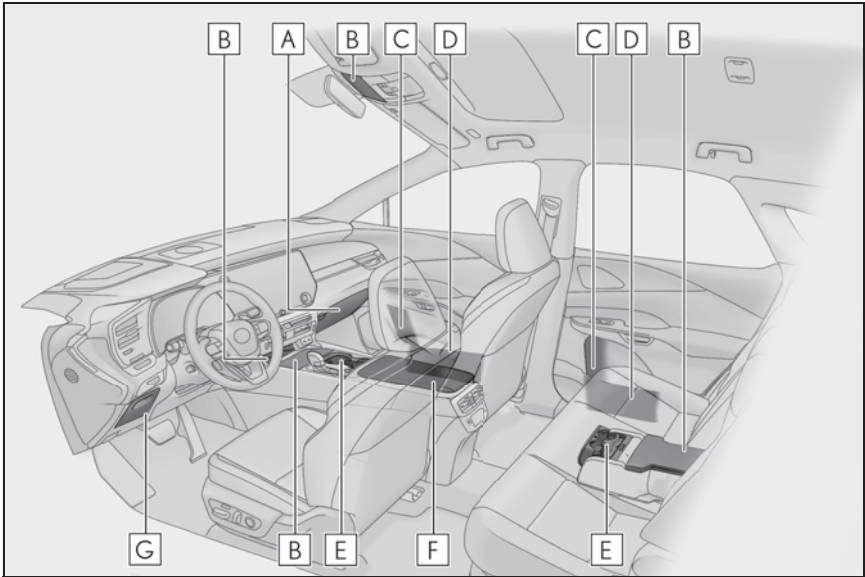

- A** Glove box (→P.428)
- B** Auxiliary boxes (if equipped) (→P.430)
- C** Bottle holders (→P.429)
- D** Door pockets
- E** Cup holders (→P.428)
- F** Console box (→P.428)
- G** Coin box (→P.430)

#### WARNING

##### ■ Items that should not be left in the storage spaces

Do not leave glasses, lighters or spray cans in the storage spaces, as this may cause the following when cabin temperature becomes high:

- Glasses may be deformed by heat or cracked if they come into contact with other stored items.

- Lighters or spray cans may explode. If they come into contact with other stored items, the lighter may catch fire or the spray can may release gas, causing a fire hazard.

## Glove box

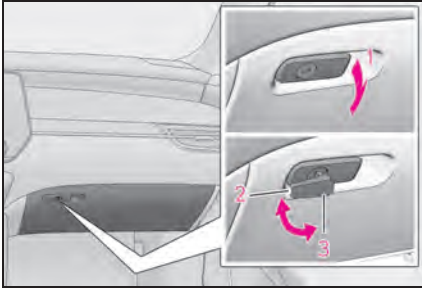

- 1 Open (pull the lever)
- 2 Lock with the mechanical key
- 3 Unlock with the mechanical key

### Glove box light

The glove box light turns on when the tail lights are on.

#### WARNING

##### ■ Caution while driving

Keep the glove box closed. In the event of sudden braking or sudden swerving, an accident may occur due to an occupant being struck by the open glove box or the items stored inside.

## Console box

### ► Type A

Push the lid.

To close, press in and release the lid.

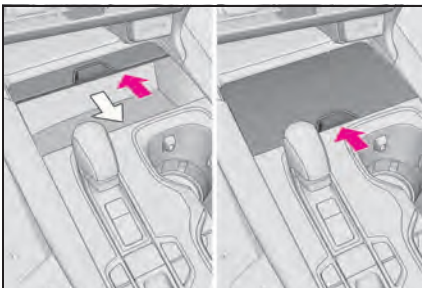

### ► Type B

Press the button, lift up and open the lid.

The console box can be opened from either side.

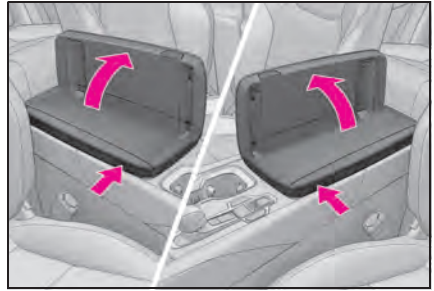

### ■ Console box light

The console box light turns on when the tail lights are on.

#### WARNING

##### ■ Caution while driving

Keep the console box closed. In the event of sudden braking or sudden swerving, an accident may occur due to an occupant being struck by the open console box or the items stored inside.

## Cup holders

### ► Front

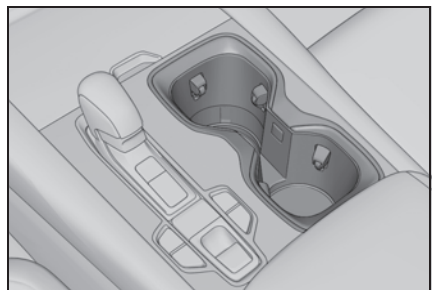

### ► Rear

Pull down the armrest and then press

down the button.

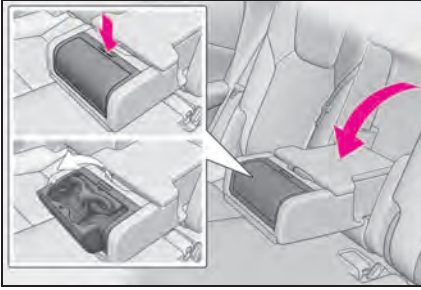

■ **The depth of the front cup holder can be changed.**

- 1 To store a water bottle, push down the bottom of the cup holder.

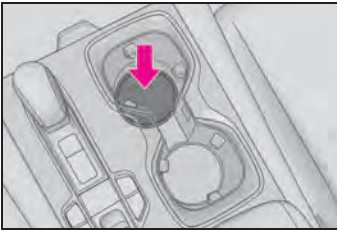

- 2 To return the bottom to its original position, press the button.



**⚠ WARNING**

■ **Items unsuitable for the cup holder**

Do not place anything other than cups, aluminum cans, or water bottles in the cup holders. Other items may be thrown out of the holders in the event of an accident or sudden braking, possibly causing injury. If possible, cover hot drinks to prevent burns.

■ **When not in use (rear cup holder)**

Keep the cup holders closed. Injuries may result in the event of an accident or sudden braking.

**⚠ NOTICE**

■ **To prevent damage to the rear cup holder**

Stow the rear cup holders before stowing the rear armrest.

**Bottle holders**

► **Front**

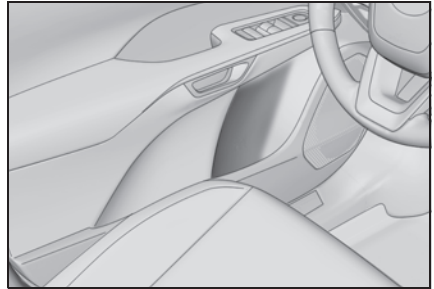

► **Rear**

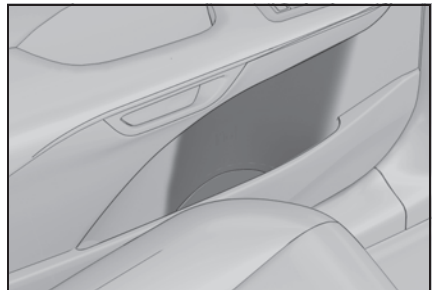

■ **Bottle holders**

- When storing a bottle, close the cap.
- The bottle may not be stored depending on its size or shape.

**NOTICE****Items unsuitable for the bottle holders**

Do not place open bottle, glass or paper cups containing liquid in the bottle holders. Otherwise, contained liquid may be spilled. Glass cups may break if used in the bottle holders.

**Coin box**

Press in the button.

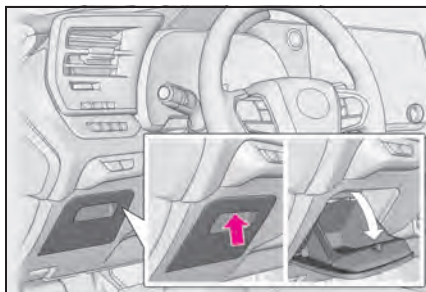
**WARNING****Caution while driving**

Keep the coin box closed. In the event of sudden braking or sudden swerving, an accident may occur due to an occupant being struck by the open coin box or the items stored inside.

**Auxiliary boxes**

► Instrument panel

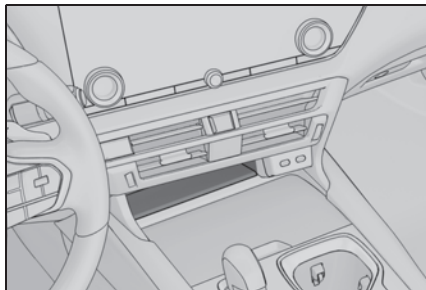

► Overhead

Press in the lid.

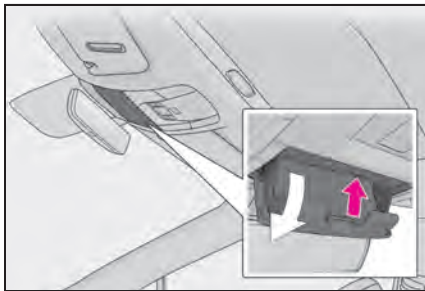

► Rear seat (if equipped)

Pull up the lever to release the lock, and lift the lid.

**WARNING****Items unsuitable for storing (Instrument panel)**

Do not store items in the box that can easily shift or roll out. In the event of sudden braking, etc., stowed items may fly out, possibly leading to an accident.

**Items unsuitable for storing (overhead)**

Do not store items heavier than 0.44 lb. (200 g). Doing so may cause the auxiliary box to open and the items inside may fall out, resulting in an accident.

**⚠ WARNING****■ Caution while driving**

Keep the auxiliary boxes closed. In the event of sudden braking or sudden swerving, an accident may occur due to an occupant being struck by the open auxiliary boxes or the items stored inside.

**Luggage compartment features****Cargo hooks**

Pull down the hook to use.

The cargo hooks are provided for securing loose items.

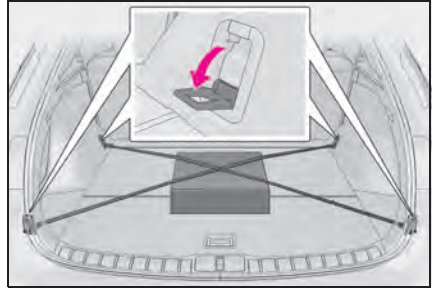
**⚠ WARNING****■ When cargo hooks are not in use**

To avoid injury, always return the hooks to their stowed positions when not in use.

**Cargo net hooks**

To hang the cargo net, use the cargo net hooks and rear cargo hooks.

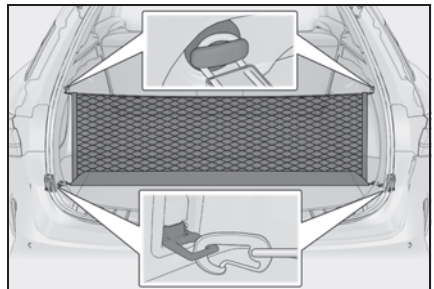
**⚠ WARNING****■ When the cargo net is not in use**

To avoid injury, always return the hooks to their stowed positions when not in use.

## Grocery bag hooks

To use the grocery bag hook, push it in.

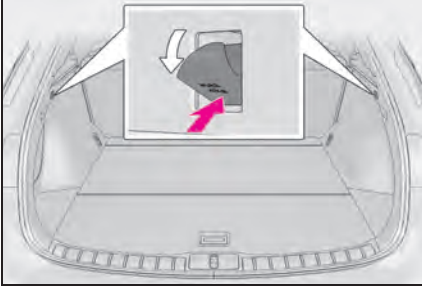

### NOTICE

- To prevent damage to the grocery bag hooks

Do not hang any object heavier than 8.8 lb. (4 kg) on the grocery bag hooks.

## Luggage cover

### ■ Installing the luggage cover

- 1 Insert either end of the luggage cover into the recess, then compress the other end of the luggage cover and insert it into the recess.

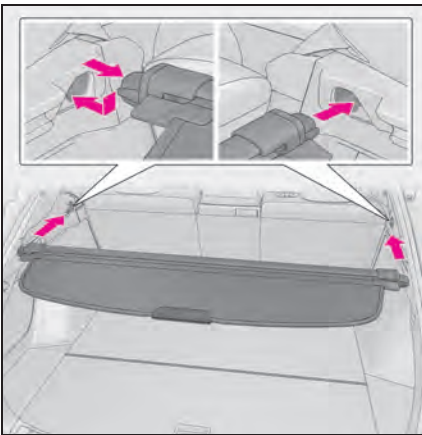

- 2 Pull out the luggage cover and hook it onto the anchors.

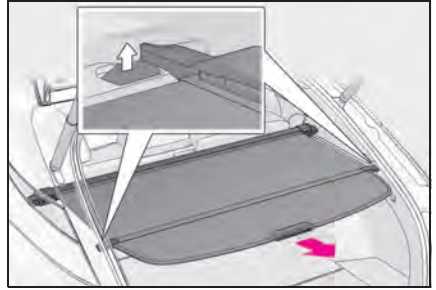

### ■ Removing the luggage cover

- 1 Lift the rear portion of the cover to release the left and right anchors and allow the cover to retract.

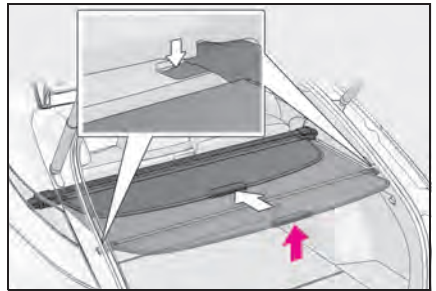

- 2 Compress the end of the luggage cover and lift the luggage cover up.

After removing the luggage cover, place it somewhere other than the passenger compartment.

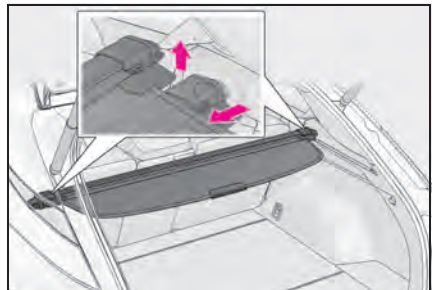

**⚠ WARNING****■ Luggage cover**

- Do not place anything on the luggage cover. In the event of sudden braking or turning, the item may go flying and strike an occupant. This could lead to an unexpected accident, resulting in death or serious injury.
- Do not allow children to climb on the luggage cover. Climbing on the luggage cover could result in damage to the luggage cover, possibly causing death or serious injury to the child.

**Deck board****■ Opening the deck board**

- 1 Pull the lever up and fold the flap of the deck board.

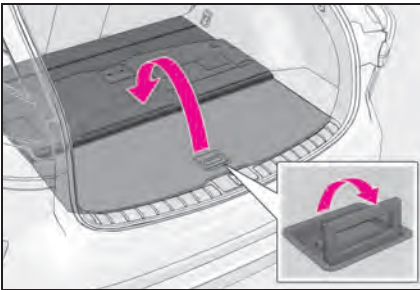

- 2 Lift the deck board and disengage the hook on the underside of the deck board.

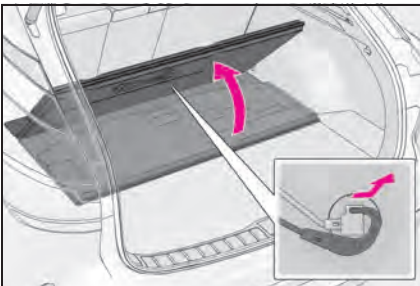

- 3 Attach the hook to the upper edge of the back door opening as shown.

When closing, reverse the steps listed.

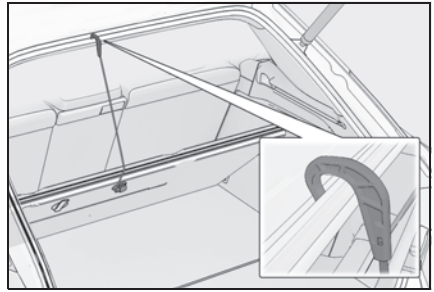
**⚠ WARNING****■ If the deck board is folded or removed**

Return it to its original position before driving. In the event of sudden braking, an accident may occur due to an occupant being struck by the deck board or the items stored in the deck under tray.

**⚠ NOTICE****■ When closing the back door**

Do not leave the deck board hook hooked on the edge of the back door opening. The deck board hook may get damaged.

## Other interior features

### USB charging ports

The USB charging ports are used to supply 3.0 A of electricity at 5 V to external devices.

The USB charging ports are for charging only. They are not designed for data transfer or other purposes. Depending on the external device, it may not charge properly. Refer to the manual included with the device before using a USB charging port.

#### ■ Using the USB charging ports

- ▶ On the instrument panel

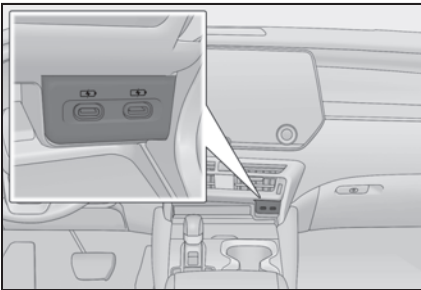

- ▶ Inside the console box

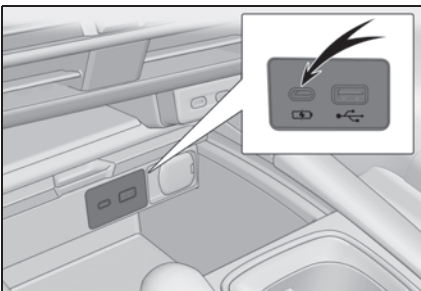

- ▶ On the rear console

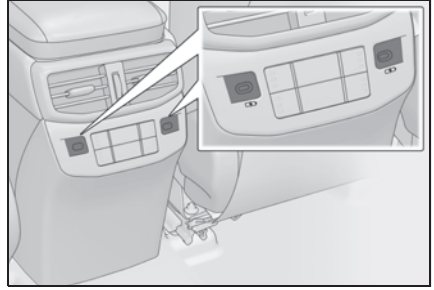

#### ■ The USB charging ports can be used when

The power switch is in ACC or ON.

#### ■ Situations in which the USB charging ports may not operate correctly

- If a device which consumes more than 3.0 A at 5 V is connected
- If a device designed to communicate with a personal computer, such as a USB memory device, is connected
- If the connected external device is turned off (depending on device)
- If the temperature inside the vehicle is high, such as after the vehicle has been parked in the sun

#### ■ About connected external devices

Depending on the connected external device, charging may occasionally be suspended and then start again. This is not a malfunction.

#### ⚠ NOTICE

#### ■ To prevent damage to the USB charging ports

- Do not insert foreign objects into the ports.
- Do not spill water or other liquids into the ports.
- Do not apply excessive force to or impact the USB charging ports.
- Do not disassemble or modify the USB charging ports.

**NOTICE****■ To prevent damage to external devices**

- Do not leave external devices in the vehicle. The temperature inside the vehicle may become high, resulting in damage to an external device.
- Do not push down on or apply unnecessary force to an external device or the cable of an external device while it is connected.

**■ To prevent 12-volt battery discharge**

Do not use the USB charging ports for a long period of time with the hybrid system stopped.

**Wireless charger (if equipped)**

A portable device, such as a smartphone or mobile battery, can be charged by just placing it on the charging area, provided the device is compatible with the Qi wireless charging standard created by the Wireless Power Consortium.

The wireless charger cannot be used with a portable device that is larger than the charging area. Additionally, depending on the portable device, the wireless charger may not operate properly. Refer to the operation manual of the portable device.

**■ The “Qi” symbol**

The “Qi” symbol is a trademark of the Wireless Power Consortium.

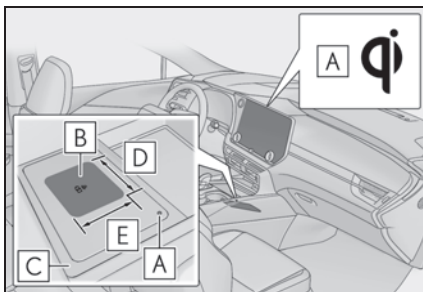
**■ Name for all parts**

- A** Operation indicator light
- B** Charge area \*
- C** Charging tray
- D** Approximately 2.8 in. (7 cm)
- E** Approximately 2.4 in. (6 cm)

\*: Compatible portable devices and the wireless charger contain charging coils. The charging coil in the wireless charger can be moved within the charge area near the center of the charging tray.

When the charging coil inside a portable device is detected within the charging area, the charging coil in the wireless charger will move near the other coil and charging will begin. If the charging coil inside the portable device is moved out of the charging area, charging will be stopped automatically.

Additionally, if 2 or more portable devices are placed on the charging tray at the same time, each charging coil may not be detected correctly and charging may not be possible.

**■ Using the wireless charger**

Place the portable device on the wireless charger.

Place the charging side of the portable device down with the center of the device in the center of the charge area.

Depending on the portable device, the charging coil may not be located in the center of the device. In this case, place the portable device so that its charging coil is in the center of the wireless charger.

When charging, the operation indicator light (orange) on the wireless charger comes on.

If charging is not occurring, try placing the portable device as close to the center of the charging area as possible.

If charging is not performed, the operation indicator light will slowly illuminate in green and orange alternatively and a sound of charging coil operation may be heard repeatedly.

When charging is complete, the operation indicator light (green) on the wireless charger comes on.

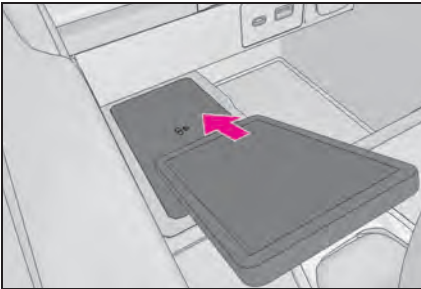

### ■ Recharging function

- If a certain amount of time has

### ■ Operation indicator light status

Operation indicator light		Conditions
Charging tray	Center display	
Turning off	Disappear	When the Wireless charger power supply is off
Green (comes on)	Gray	On Standby (charging possible state) <sup>*1</sup>
		When charging is complete <sup>*2</sup>

elapsed since charging completed and the portable device has not been moved, the wireless charger will restart charging.

- If a portable device is moved significantly within the charging area, the charging coil may disconnect and charging may temporarily be stopped. However, if a charging coil is detected within the charging area, the charging coil inside the wireless charger will move near the other coil and charging will resume.

### ■ Rapid charging function

The following portable devices support rapid charging.

- Portable devices compliant with WPC Ver1.2.4 and compatible with rapid charging
- iPhone's with an iOS version that supports 7.5 W charging (iPhone 8 and later models)

When a portable device that supports rapid charging is charged, charging automatically switches to the rapid charging function.

Operation indicator light		Conditions
Charging tray	Center display	
Orange (comes on)	Blue	When placing the portable device on the charging area (detecting the portable device)
		Charging

\*1: Charging power will not be output during standby. A metallic object will not be heated, if it is placed on the wireless charger in this state.

\*2: Depending on the portable device, there are cases where the operation indicator light will continue being lit up orange even after the charging is complete.

### ■ When the wireless charger does not operate properly

When the wireless charger does not operate properly, handle the probable cause based on the following tables.

Operation indicator light		Suspected causes/Handling method
Charging tray	Center display	
Green (Flashing repeatedly once every second)	Disappear	Wireless charger and multimedia system communication failure → <b>If the hybrid system is operating, stop and then restart the hybrid system.</b> If the power switch is in ACC, start the hybrid system. (→P.208)
Orange (Flashing repeatedly once every second)	Gray	Vehicle to wireless charger communication failure → <b>If the hybrid system is operating, stop and then restart the hybrid system.</b> If the power switch is in ACC, start the hybrid system. (→P.208)
Green (comes on)	Blue	AM radio stations are being automatically selected → <b>Wait until the system has completed the automatic selection of AM radio stations. In the case that automatic selection cannot be completed, stop automatic selection.</b>
		The smart access system with pushbutton start is detecting the key. → <b>Wait until the system has completed the automatic selection of AM radio stations. In the case that automatic selection cannot be completed, stop automatic selection.</b>

Operation indicator light		Suspected causes/Handling method
Charging tray	Center display	
Orange (Repeatedly flashes 3 times continuously)	Gray	Foreign substance detection: A metallic foreign substance is in the charge area, and so the abnormal heating prevention function of the metallic foreign object operated → <b>Remove the foreign substance from the charge area.</b>
		Portable device misaligned: The charging coil in the portable device moved outside of the charge area, and so the abnormal heating prevention function operated → <b>Remove the portable device from the wireless charger, check that the operation indicator light on the wireless charger changes back to green, and then place the portable device so that it is near the center of the wireless charger. Also, if a case or cover is installed to the portable device, remove it.</b>
Orange (Repeatedly flashes 4 times continuously)	Gray	Safety shutdown resulting when the temperature within the wireless charger exceeded the set value → <b>Stop charging, remove the portable device from the wireless charger, wait for the temperature to drop, and then start charging again.</b>

■ **The wireless charger can be operated when**

The power switch is in ACC or ON.

■ **Portable devices that can be charged**

- Portable devices compatible with the Qi wireless charging standard can be charged by the wireless charger. However, compatibility with all devices which meet the Qi wireless charging standard is not guaranteed.
- The wireless charger is designed to supply low power electricity (5 W or less) to a cellular phone, smartphone, or other portable device.

However, portable devices, such as the following, can be charged with more than 5

W.

- 7.5 W charging compatible iPhones can be charged at 7.5 W or less.
- Portable devices compliant with EPP output as defined by WPC standard Ver1.2.4. can be charged at 10 W or less.

■ **Using the smart access system with push-button start**

During charging, when the smart access system with push-button start searches for an electronic key, charging may be temporarily suspended.

■ **If a cover or accessory is attached to the portable device**

Do not charge a portable device if a cover or accessory which is not Qi compatible is attached. Depending on the type of cover

(including the certain genuine manufacture parts) and/or accessory attached, it may not be possible to charge the portable device. If the portable device is placed on the charging area and does not charge, remove the cover and/or accessories.

#### ■ While charging, noise enters the AM radio

- During charging, if noise occurs when listening to the AM radio, the charging frequency is automatically changed to reduce the noise.
- Rapid charging may not be performed as AM radio reception is prioritized.
- When automatically seeking AM radio stations, charging will be suspended to prevent charging noise from being detected as a radio station. Charging will resume automatically when seek tuning is stopped.

#### ■ Charging precautions

While charging, the wireless charger and the portable device will become warm. This is not a malfunction. If a portable device becomes warm while charging and charging stops due to the protection function of the portable device, wait until the portable device cools down and charge it again.

Also, to decrease the temperature inside the wireless charger, a fan may operate. This does not indicate a malfunction.

#### ■ Sound generated during operation

Operation sounds may be heard when the power switch is pressed to change to ACC or ON, or when a portable device is being detected. This does not indicate a malfunction.

#### ■ Cleaning the wireless charger

→P.462

#### ■ Situations in which the wireless charger may not operate correctly

In the following situations, the wireless charger may not operate correctly:

- When a portable device is fully charged
- When a portable device is being charged by a wired connection

- When there is a foreign object between the charging area and portable device
- When the temperature of a portable device becomes high while charging
- When the temperature near the charging tray is 95°F (35°C) or more due to being in direct sunlight, etc.
- When a portable device is placed with its charging surface facing up
- When a portable device is not centered on the charging area
- When a portable device is larger than the charging tray
- When a foldable portable device is placed outside of the charging area
- When the vehicle is near a TV tower, electric power plant, fuel station, radio station, large display, airport, or other facility that generates strong radio waves or electrical noise
- The electronic key is not inside the vehicle
- When the any of the following objects, with a thickness of 0.08 in. (2 mm) or more, are between the charging surface of a portable device and the charging area:
  - Thick cases or covers
  - A case or cover attached with an uneven or tilted surface, so that the charging side is not flat
  - Thick decorations
  - Accessories, such as finger rings, straps, etc.
- When there is a gap between the charging side of the portable device and the charge area due to a protrusion such as a camera on the charging side of the portable device.
- When the portable device is in contact with, or is covered by any of the following metallic objects:
  - Cards covered with metal, such as aluminum foil
  - Cigarette boxes that have aluminum foil inside
  - Metallic wallets or bags
  - Coins
  - Heat packs
  - Recorded media such as CDs and DVDs
  - Metallic decorations

- Metallic cases or covers
- Casing which has magnet in it on the charging side of the portable device
- When wireless keys (that emit radio waves) other than those of your vehicle are being used nearby
- When 2 or more portable devices are placed on the charging tray at the same time

In situations other than above, if the wireless charger does not operate properly or the operation indicator light blinks continuously, the wireless charger may be malfunctioning.

Contact your Lexus dealer.

#### ■ If the smartphone OS has been updated

If the smartphone OS has been updated to a newer version, its charging specifications may have changed significantly. For details, check the information on the manufacturer's website.



### WARNING

#### ■ Caution while driving

When charging a portable device while driving, for safety reasons, the driver should not operate the portable device.

#### ■ Precautions for when driving

Do not charge small, lightweight portable devices, such as wireless earbuds, while driving. Lightweight devices may fly off of the charging tray, possibly leading to an accident.

#### ■ Caution regarding interference with electronic devices

People with implantable cardiac pacemakers, cardiac resynchronization therapy pacemakers or implantable cardioverter defibrillators, as well as any other electrical medical device, should consult their physician about the usage of the wireless charger.

Operations of the wireless charger may have an affect on medical devices.

#### ■ To prevent damage or burns

Observe the following precautions.

Failure to do so may result in the possibility of fire, equipment failure or damage, or burns due to heat.

- Do not put any metallic objects between the charging area and the portable device while charging.
- Do not attach metallic objects, such as aluminum stickers, to the charging area.
- Do not charge portable devices with aluminum stickers or other metallic objects attached to the side which touches the charging area.
- Do not store items on the wireless charger instead of in an auxiliary box.
- Do not apply force or impact to the wireless charger.
- Do not disassemble, modify or remove the wireless charger.
- Do not attempt to charge portable devices which are not compatible with the Qi wireless charging standard.
- Do not allow magnetic objects to come near the wireless charger.
- Do not perform charging if the charging area is dirty.
- When not using the wireless charger, to prevent foreign matter or liquids from contacting it, make sure to close the lid.
- Keep the lid open while charging is taking place.
- Do not cover the wireless charger with a cloth or other object while charging.

 NOTICE

■ **To prevent failure or damage to data**

- Do not place magnetic cards, such as a credit card, or magnetic recording media, close to the wireless charger while charging. Otherwise, data may be erased due to the influence of magnetism. Additionally, do not bring precision instruments such as wrist watches, close to the wireless charger, as such objects may malfunction.
- Do not perform charging with a contactless smart card, such as a transportation system IC card, between the charging surface of a portable device and the charging area. The IC chip in the card may become extremely hot, possibly damaging the portable device or smart card.  
Be extra careful to not charge a portable device with a case or cover which a contactless smart card can be inserted.
- Do not leave portable devices in the cabin. The temperature inside the cabin may become high when parked in the sun, and cause damage to the device.

■ **When the OS of a smartphone has been updated**

When the OS version of a smartphone has been changed, the charging specifications may have changed. If the WPC compatibility version is changed, the rapid charging function may no longer be able to be used. For details, check for information on the website for the smartphone manufacturer.

■ **To prevent 12-volt battery discharge**

Do not use the wireless charger for a long period of time with the hybrid system stopped.

## Armrest

Pull the armrest down for use.

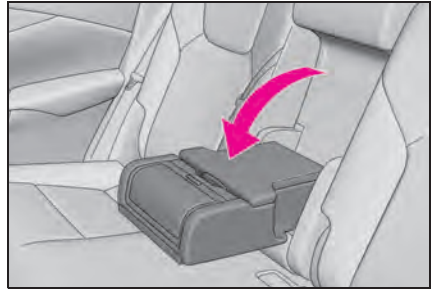

 NOTICE

■ **To prevent damage to the armrest**

Do not apply too much load on the armrest.

## Assist grips

An assist grip installed on the ceiling can be used to support your body while sitting on the seat.



 WARNING

■ **Assist grip**

Do not use the assist grip when getting in or out of the vehicle or rising from your seat.

 NOTICE

■ **To prevent damage to the assist grip**

Do not hang any heavy object or put a heavy load on the assist grip.

## Coat hooks

The coat hooks are provided with the rear assist grips.



### WARNING

#### ■ Items that must not be hung on the hook

Do not hang coat hangers or other hard or sharp objects on the hook. If the SRS curtain shield airbags deploy, these items may become projectiles, causing death or serious injury.

## Power outlets (12 VDC)

Please use as a power supply for electronic goods that use less than 12 VDC/10 A (power consumption of 120 W).

When connecting multiple devices, make sure that the total power consumption of all the connected devices is less than 120 W.

► Inside the console box

Open the lid.

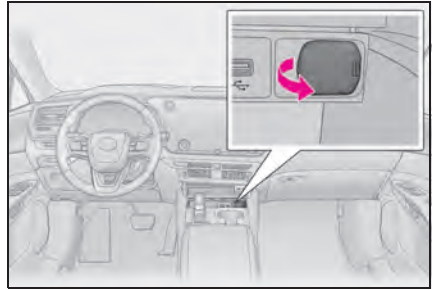

► In the luggage compartment

Open the lid.

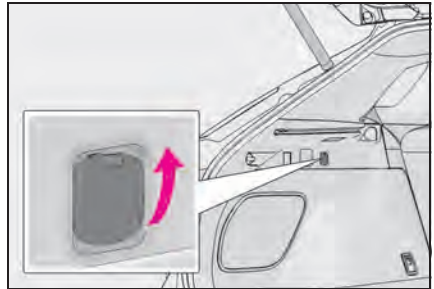

#### ■ The power outlet can be used when

The power switch is in ACC or ON.

#### ■ When stopping the hybrid system

Disconnect electrical devices with charging functions, such as mobile battery packs. If such devices are left connected, the hybrid system may not stop normally.



### NOTICE

#### ■ To avoid damaging the power outlet

Install the cap or close the lid when the power outlets is not in use.

Foreign objects or liquids that enter the power outlet may cause a short circuit.

#### ■ To prevent 12-volt battery discharge

Do not use the power outlet longer than necessary when the hybrid system is not running.

## Sun visors

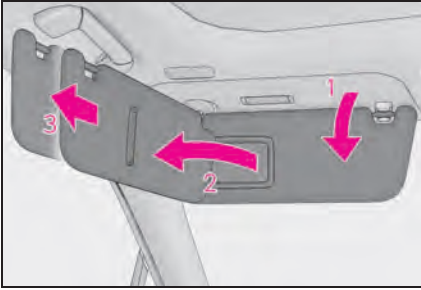

- 1 To set the visor in the forward position, flip it down.
- 2 To set the visor in the side position, flip down, unhook, and swing it to the side.
- 3 To use the side extender, place the visor in the side position, then slide it backward.

## Vanity mirrors

Slide the cover to open.

The light turns on when the cover is opened.

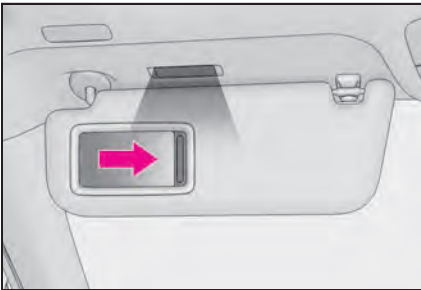

### ■ To prevent 12-volt battery discharge

If the vanity lights remain on when the power switch is turned off, the lights will go off automatically after 20 minutes.

### ⚠ NOTICE

- To prevent the 12-volt battery from being discharged

Do not leave the vanity lights on for extended periods while the hybrid system is off.

## Rear door sunshades (if equipped)

Pull the sunshade up using the tab and hook the sunshade on to the anchors.

To lower the sunshade, pull it up slightly using the tab, unhook it from the anchors, and lower it slowly.

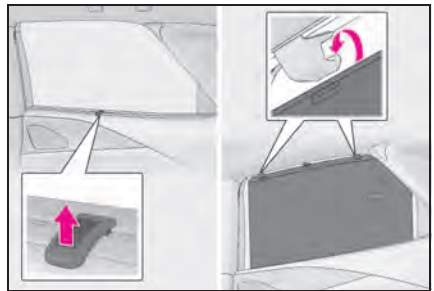

### ⚠ WARNING

- Closing the rear door sunshade

When a rear door sunshade is in use, do not put fingers, etc. on the anchors or in the groove of the rear door sunshade. Otherwise, a finger, etc. may get caught, possibly causing an injury.

### ⚠ NOTICE

- To ensure normal operation of the sunshade

- Do not put anything in an area where it may interfere with the operation of a rear door sunshade.

**NOTICE**

- To prevent damage to the rear door sunshades, do not apply excessive load or attach items to the rear door sunshades.

**Using the power outlets (1500 W)\***

\*: If equipped

The system allows the on-board use of electric devices which operate on 120 VAC and have a combined power consumption of 1500 W or less.

**Precautions for using the power outlets while parked**

Observe the following precautions before starting the power supply:

- As the engine may operate while the system is operating, avoid areas with poor ventilation, such as a garage. Park the vehicle in a well ventilated place.
- Park the vehicle on a solid and level place.
- Check that the hood is closed.
- Check that the parking brake is engaged.
- Check that the P shift position is selected.
- Check that the power switch is off.
- Note that the alarm system cannot be enabled during the Power supply. For theft prevention, do not leave valuable items, etc. in the cabin or luggage compartment.

## Names of parts

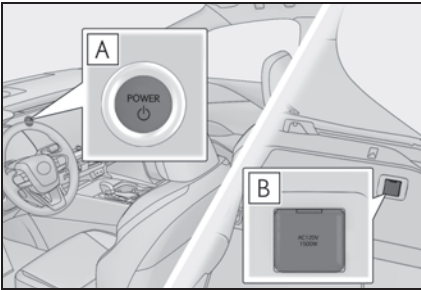

**A** Power switch (→P.208)

**B** In the luggage compartment

## Using the power outlets (1500 W)

- 1 Check that the parking brake is engaged. securely depress the brake pedal, and press the power switch. (→P.208)
- 2 Check that the “READY” indicator is illuminated, and select the shortcut switch on the center display.
- 3 Touch “Power outlet 1500W”.

The power outlets are turned on/off each time “Power outlet 1500W” is touched.

- 4 Open the lid, and fully and securely insert the plug of the device into the power outlet.

## Stopping the use of the power outlets (1500 W)

- 1 Turn the connected device(s) off.
- 2 Select the shortcut switch on the center display.
- 3 Touch “Power outlet 1500W” to turn it off.

- 4 Disconnect each plug from the power outlets.
- 5 Close the lid of each power outlet.

## Connecting a device

### ■ When connecting a device

Make sure to read the instruction manual which came with a device and observe warnings on the device.

Before connecting a device to the power outlet, make sure that the device is turned off.

- 1 Open the lid, and fully and securely insert the plug of the device into the power outlet.

Do not leave the plug halfway inserted.

In the following situations, use cable extension, etc. and connect the plug securely to the power outlet:

- When the plug of a device is too large to allow it to be inserted fully and securely into the power outlet.
- When the plug of a device is heavy, possibly causing it to come off the power outlet.

If the device to be used has a ground wire, use a conversion adapter available on the market and connect the ground wire to the ground terminal of the conversion adapter.

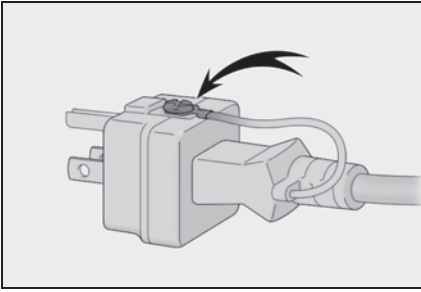

### ■ Power outlets

- With these power outlets, use devices which operate on 120 VAC and have a combined maximum power consumption of 1500 W or less. If a device is connected and the power consumption is exceeded, a protection circuit may be activated and the power supply function may be stopped.
- Some of the devices that consume a large amount of power, such as an electric grille, may require the exclusive use of the power outlets. When such a device is connected, do not connect other device(s) to the power outlets.
- When multiple devices are connected, depending on the device, a connected device may not operate properly. For such a device, use exclusively the power outlets.
- When a power outlet is being used, depending on the device to be used, the current flow may be high and the initial peak wattage may exceed 1500 W.
- When a power outlet is being used, depending on the device to be used, it may cause interference with TV and radio broadcasts.
- While a power outlet is being used, a cooling fan sound may be heard from near a luggage compartment. This does not indicate a malfunction.

### ■ Devices which may not operate correctly

The following devices may not operate properly even if the combined power consumption is 1500 W or less:

- Devices with high initial peak wattage

- Devices requiring larger amount of power supply than the power consumption specified in its instruction manual
- Measuring devices that process precise data
- Devices that require an extremely stable power supply
- Devices that require a constant power supply from the power outlet, such as a device with a timer.

### ■ When the power outlets are used while the vehicle is parked or stopped

- The doors cannot be locked/unlocked using the smart access system with push-button start.
- The doors cannot be locked/unlocked using an electronic key. The doors can only be locked/unlocked using a mechanical key. (→P.549)
- When a door is opened/closed, a buzzer may sound or “Key not detected Check key location” may be displayed on the multi-information display. Check that an electronic key is carried with you.
- When the surrounding area becomes dark while the power supply is being performed, the headlights, etc. will come on automatically.

To turn the lights off: →P.232



### WARNING

#### ■ For safe use

Observe the following precautions. Failure to do so may lead to an accident, resulting in death or serious injury.

- Do not allow children or other people not used to the operation to perform the power supply by themselves.
- Do not disconnect the plug of a device while your hands are wet or insert a pin or other object into the power outlet. Also, if a liquid or snow is on the power outlet, dry the outlet before using it.

**WARNING**

- Do not attempt to modify, disassemble, or repair a Power outlet. For information on repairs, contact your Lexus dealer.
- Keep the power outlets free of dust and foreign matter. Also, make sure to clean the power outlets periodically.
- Hold the plug body to plug in/out of a power outlet. Do not touch the plug blades. Do not pull on a cord for unplugging, as otherwise the plug or cord may be damaged.
- Stop the use immediately if abnormal heat is observed on a cord or power outlet. To prevent the cord or power outlet from becoming hot, observe the following precautions:
  - Do not connect 2 or more multi-point outlet adapters, such as dual adapters.

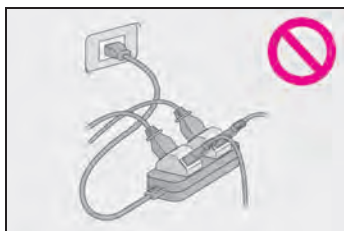

- When an extension cord reel is used, make sure to draw the whole cord out of the reel.
- If the device to be used has a ground wire, use a conversion adapter available on the market and connect the ground wire to the ground terminal of the conversion adapter.
- If the plug of a device fits loosely in a power outlet, even though it is fully inserted, replace the power outlet. For information on replacement, contact your Lexus dealer.

**■ Devices to be connected**

- Make sure to read any instruction manual which came with a device and observe any warnings on the device.
  - Do not connect a device to a power outlet if the device is malfunctioning or its plug is damaged.
  - Otherwise, the device may be further malfunctioning, especially when the outside temperature is high or low.
  - Devices requiring to be installed on a level place may not operate properly.
  - Do not use devices, other than waterproof devices, in a place where water, such as rain, is splashed over or where it is humid.
  - Do not use a device that has been or likely to have been merged in water or absorbed water within.
  - Depending on the vehicle condition, the power supply function may be temporarily stopped.
- When the power outlets are used while the vehicle is parked or stopped**
- The power outlets are designed to be connected to electric devices, such as lighting devices. Do not use them as a generator that supplies power to a house, etc. Also, when they are to be used on an emergency power supply device for homes, such as an exclusive device having connection to an external power source, or a device whose power supply circuit for external power source is separate from electric wiring of power companies, consult with the manufacturer or a retailer of the device.
  - When using a power outlet, make sure to securely engage the parking brake and shift the shift position to P. Otherwise, the vehicle may move, possibly leading to an accident.

**WARNING**

- When using a power outlet, do not move away from the vehicle.
- Do not perform rapid charging during weather when lightning may occur. Stop supplying power if lightning is observed during power supply.
- Do not use the power outlets if the vehicle has a vehicle cover installed.
- Take due care when you sleep in the vehicle while using devices such as an electric heater. The power supply system may stop automatically, possibly resulting in unintended stoppage of the connected device.
- Do not use a power outlet when the vehicle is parked on a slanted place or a slope. When a power outlet is being used, do not move the vehicle or cause it to be inclined.
- Observe the following precautions when a connected cord is to be brought outside the vehicle:
  - Take due care for not allowing rain to enter.  
If the power outlet are wet with rain-drops, dry them before use.
  - Do not have cords pinched in a window or door.
  - Allow slack in a connected cord. Do not cause it to be extraordinary tense.

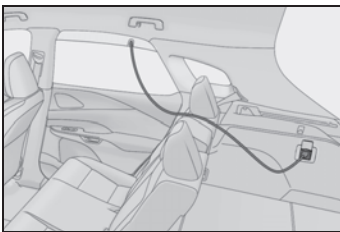

- Do not start off the vehicle by mistake.
- Do not refuel or wash the vehicle when using a power outlet.

- Make sure that the hood is closed. As the engine will start automatically depending on the condition of the vehicle, make sure that nothing is left near or contacting the exhaust pipes. Also, do not put your head or hands anywhere inside the engine compartment. The cooling fans may operate suddenly. Keep hands and clothing (especially a tie, scarf, muffler, etc.) away from the fans as they may get caught in a fan, resulting in serious injury.
- Do not stop the vehicle near objects which burn easily. If the exhaust system is extremely hot, it may cause a fire.
- If the charge level of the hybrid battery (traction battery) becomes low, the gasoline engine will operate automatically. When using a power outlet in an area with poor ventilation, such as a garage, or an enclosed area (covered with snow), to prevent the exhaust gasses from accumulating and causing a lack of oxygen, make sure to properly install and use an air supply/exhaust device. Do not use the power outlets if such a device cannot be installed.

**■ Use of a power outlet while driving**

- In situations such as the following, do not use an electric device while driving. Also, do not use a device if it cannot be secured within the vehicle.
  - When a device is likely to distract the driver and be a hindrance to safe driving, such as a TV, video/DVD player, etc.
  - When an inadequately secured device is likely to fall over in case of sudden braking or an accident
  - When a device is likely to cause fire if it falls or generates heat
  - When a device is likely to cause burns, such as a toaster, microwave, electric heater, electric kettle, coffee maker, etc.

**WARNING**

- When a device is likely to fall under the pedals and prevent the brake pedal from being depressed, such as a hair dryer, AC adapter, mouse, etc.
- Do not use devices which produce steam while the windows are closed. Doing so may cause the windows to fog up, reducing visibility and making it difficult to drive safely. Also, the steam may damage or negatively affect other devices. If the device must be used, stop the vehicle and open the windows before use.

**NOTICE****■ To avoid short circuit or malfunction**

Observe the following precautions. Failure to do so may lead to the power outlets not operating correctly or damage to the vehicle or a connected device.

- Do not set a toaster or other device which generates heat near the interior components or on a seat. Heat may cause these parts to melt or burn.
- Do not use devices which are sensitive to vibration or heat in the vehicle. These devices may malfunction due to vibration while driving or heat while the vehicle is parked in the sun.
- When not using a power outlet, make sure to close the lid. If foreign matter or a liquid enters the power outlet, it may cause a malfunction or short circuit.

**If the power outlets (1500 W) cannot be used**

If the power supply does not start even though the correct steps are followed, check each of the following:

**If the power outlets (1500 W) cannot be used**

Cause	Remedy
The traction battery may be too hot, such as when the outside temperature is high, etc.	Move the vehicle to a shaded place, etc. or use the air conditioning system to cool down the cabin. After a while, touch "Power outlet 1500 W" again.
The traction battery may be too cold, such as when the outside temperature is low, etc.	Drive the vehicle for a while or use the air conditioning system to warm up the cabin. After a while, touch "Power outlet 1500 W" again.
A connect device does not operate.	Disconnect the plug of each device from the power outlets, check that the devices are not malfunctioning, reconnect the devices, and then touch "Power outlet 1500 W" again. Refer to the instruction manual of the device.

Cause	Remedy
The combined power consumption of connected device(s) exceeds 1500 W.	Disconnect the plug of each device from the power outlets, check that the combined power consumption of all devices to be connected to the power outlets is 1500 W or below, reconnect the devices, and then touch "Power outlet 1500 W" again.
The power outlets have a short circuit.	Disconnect the plug of each device from the power outlets, check the following, and then touch "Power outlet 1500 W" again. <ul style="list-style-type: none"> <li>• If a pin or other object is not inserted</li> <li>• If a liquid or snow is not on the power outlets</li> <li>• If the power outlets are free of dust or foreign matter</li> </ul>

## Garage door opener

The garage door opener can be programmed using the HomeLink<sup>®</sup> to operate garage doors, gates, entry doors, door locks, home lighting systems, security systems, and other devices.

### ■ HomeLink<sup>®</sup> programming procedure

The programming procedures can also be found at the following URL.

Website: [www.homelink.com/lexus](http://www.homelink.com/lexus)



For support, contact customer support at the following.

Help Line: 1-800-355-3515

## System components

The HomeLink<sup>®</sup> wireless control system in your vehicle has 3 buttons which can be programmed to operate 3 different devices. Refer to the programming methods on the following pages to determine the method which is appropriate for the device.

- ▶ Vehicles with auto anti-glare inside rear view mirror

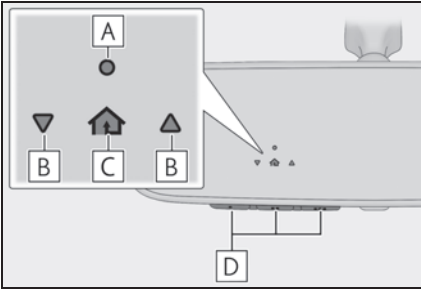

- A** HomeLink® indicator light
- B** Garage door operation indicators
- C** HomeLink® icon  
Illuminates while HomeLink® is operating.
- D** Buttons

- ▶ Vehicles with Digital Rearview Mirror

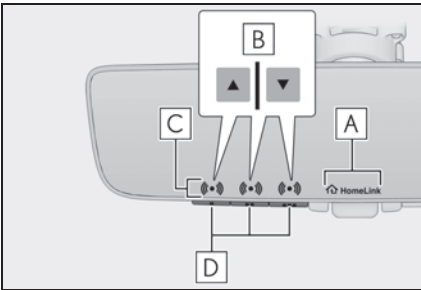

- A** HomeLink® logo  
Appears while HomeLink® is operating. When the menu button (→P.157) is pressed, the logo disappears even while the HomeLink® is operating.
- B** Garage door operation indicators
- C** HomeLink® indicator light  
Illuminates above each button selected.
- D** Buttons

### ■ Codes stored in the HomeLink® memory

- The registered codes are not erased even if the 12-volt battery cable is disconnected.
- If learning failed when registering a different code to a HomeLink® button that already has a code registered to it, the already registered code will not be erased.

### ⚠ WARNING

#### ■ When programming a garage door or other remote control device

The garage door or other device may operate, so ensure people and objects are out of danger to prevent potential harm.

#### ■ Conforming to federal safety standards

Do not use the HomeLink® compatible transceiver with any garage door opener or device that lacks safety stop and reverse features as required by federal safety standards.

This includes any garage door that cannot detect an interfering object. A door or device without these features increases the risk of death or serious injury.

#### ■ When operating or programming HomeLink®

Never allow a child to operate or play with the HomeLink® buttons.

### Programming the HomeLink®

#### ■ Before programming HomeLink®

- During programming, it is possible that garage doors, gates, or other devices may operate. For this rea-

son, make sure that people and objects are clear of the garage door or other devices to prevent injury or other potential harm.

- It is recommended that a new battery be placed in the remote control transmitter for more accurate programming.
- Garage door opener motors manufactured after 1995 may be equipped with rolling code protection. If this is the case, you may need a stepladder or other sturdy, safe device to reach the “Learn” or “Smart” button on the garage door opener motor.

### ■ Programming HomeLink®

Steps **1** through **3** must be performed within 60 seconds, otherwise the HomeLink® indicator light will stop flashing and programming will not be successfully completed.

- 1** Press and release the HomeLink® button you want to program and check that the HomeLink® indicator light flashes (orange).
- 2** Point the remote control transmitter for the device at the rear view mirror, 1 to 3 in. (25 to 75 mm) from the HomeLink® buttons.

Keep the HomeLink® indicator light in view while programming.

- ▶ Vehicles with auto anti-glare inside rear view mirror

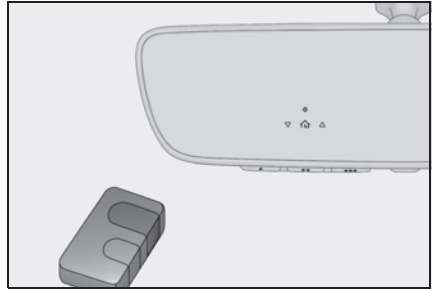

- ▶ Vehicles with Digital Rearview Mirror

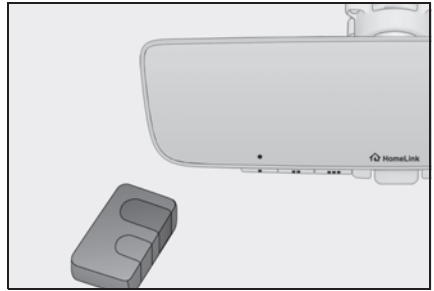

- 3** Program a device.

- ▶ Vehicles with auto anti-glare inside rear view mirror



▶ Vehicles with Digital Rearview Mirror

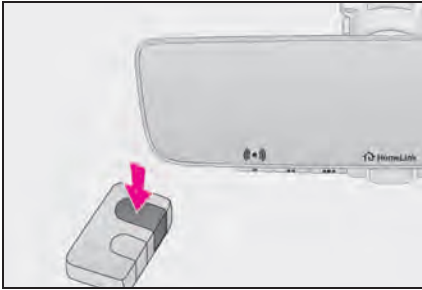

▶ Programming a device other than an entry gate (for U.S.A. owners)

Press and hold the remote control transmitter button until the HomeLink<sup>®</sup> indicator light changes from slowly flashing orange to rapidly flashing green (rolling code) or continuously lit green (fixed code), then release the button.

▶ Programming an entry gate (for U.S.A. owners)/Programming a device in the Canadian market

Press and release the remote control transmitter button at 2 second intervals, repeatedly, until the HomeLink<sup>®</sup> indicator light changes from slowly flashing (orange) to rapidly flashing (green) (rolling code) or continuously lit (green) (fixed code).

4 Test the HomeLink<sup>®</sup> operation by pressing the newly programmed button and observing the indicator light:

- HomeLink<sup>®</sup> indicator light illuminates: Programming of a fixed code device has completed. The garage door or other device should operate

when a HomeLink<sup>®</sup> button is pressed and released.

- HomeLink<sup>®</sup> indicator light flashes rapidly: The garage door opener motor or other device is equipped with a rolling code. To complete programming, firmly press and hold the HomeLink<sup>®</sup> button for 2 seconds then release it.

- If the garage door or other device does not operate, proceed to “Programming a rolling code system”.

5 Repeat the steps above to program another device for any of the remaining HomeLink<sup>®</sup> buttons.

■ Programming a rolling code system

Two or more people may be necessary to complete rolling code programming.

1 Locate the “Learn” or “Smart” button on the garage door opener motor in the garage.

This button can usually be found where the hanging antenna wire is attached to the unit. The name and color of the button may vary by manufacturer. Refer to the owner’s manual supplied with the garage door opener motor for details.

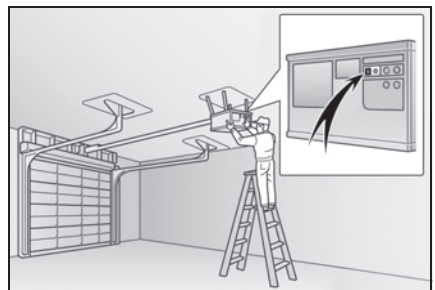

- 2** Press and release the “Learn” or “Smart” button.  
Perform **3** within 30 seconds after performing **2**.

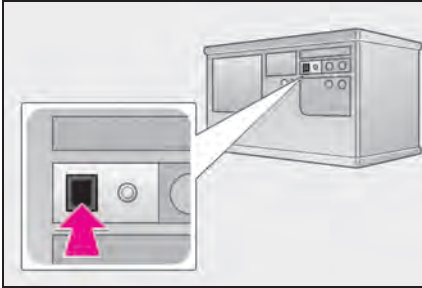

- 3** Press and hold the desired HomeLink<sup>®</sup> button (inside the vehicle) for 2 seconds and release it. Repeat this sequence (press/hold/release) up to 3 times to complete programming. If the garage door opener motor operates when the HomeLink<sup>®</sup> button is pressed, the garage door opener motor recognizes the HomeLink<sup>®</sup> signal.

- ▶ Vehicles with auto anti-glare inside rear view mirror



- ▶ Vehicles with Digital Rearview Mirror



- **Enabling 2-way communication with a garage door (only available for compatible devices)**

When enabled, 2-way communication allows you to check the status of the opening and closing of a garage door through indicators in your vehicle.

2-way communication is only available if the garage door opener motor used is a compatible device. (To check device compatibility, refer to [www.homelink.com](http://www.homelink.com).)

- 1** Within 5 seconds after programming the garage door opener has been completed, if the garage door opener motor is trained to HomeLink<sup>®</sup>, both garage door operation indicators will flash rapidly (green) and the light on the garage door opener motor will blink twice, indicating that 2-way communication is enabled.

If the indicators do not flash, perform **2** and **3** within the first 10 presses of the HomeLink<sup>®</sup> button after programming has been completed.

- 2** Press a programmed HomeLink<sup>®</sup> button to operate a garage door.

- 3 Within 1 minute of pressing the HomeLink<sup>®</sup> button, after the garage door operation has stopped, press the “Learn” or “Smart” button on the garage door opener motor. Within 5 seconds of the establishment of 2-way communication with the garage door opener, both garage door operation indicators in the vehicle will flash rapidly (green) and the light on the garage door opener motor will blink twice, indicating that 2-way communication is enabled.

### ■ Reprogramming a single HomeLink<sup>®</sup> button

When the following procedure is performed, buttons which already have devices registered to them can be overwritten:

- 1 Press and hold the desired HomeLink<sup>®</sup> button.
- 2 When the HomeLink<sup>®</sup> indicator starts flashing orange, release the HomeLink<sup>®</sup> button and perform “Programming HomeLink<sup>®</sup>” 1 (it takes 20 seconds for the HomeLink<sup>®</sup> indicator to start flashing).

### ■ Before programming

- Install a new battery in the transmitter.
- The battery side of the transmitter must be pointed away from the HomeLink<sup>®</sup> buttons.

## Operating HomeLink<sup>®</sup>

Press the appropriate HomeLink<sup>®</sup> button. The HomeLink<sup>®</sup> indicator light should turn on.

The status of the opening and closing of a garage door is shown by the indicators.

- ▶ Vehicles with auto anti-glare inside rear view mirror

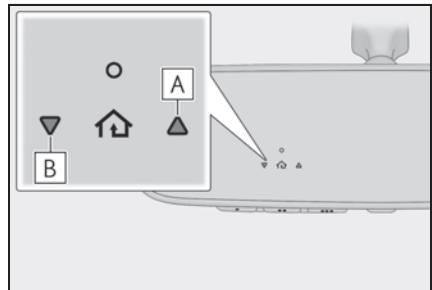

**A** Opening

**B** Closing

- ▶ Vehicles with Digital Rearview Mirror

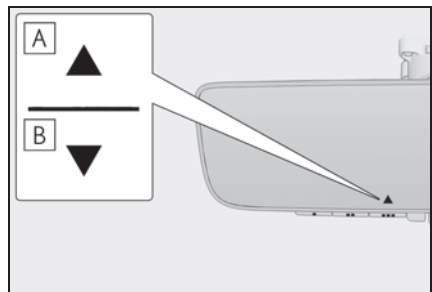









**A** Opening

**B** Closing

This function is only available if the garage door opener motor used is a compatible device. (To check device compatibility, refer to [www.homelink.com](http://www.homelink.com).)

Color	Status
Orange (flashing)	Currently opening/closing
Green	Opening/closing has completed
Red (flashing)	Feedback signals cannot be received

The indicators can operate within approximately 820 ft. (250 m) of the garage door. However, if there are obstructions between the garage door and the vehicle, such as houses and trees, feedback signals from the garage door may not be received.

To recall the previous door operation status, press and release either HomeLink® buttons  and  or  and  (vehicles with auto anti-glare inside rear view mirror),  and  or  and  (vehicles with Digital Rearview Mirror), simultaneously. The last recorded status will be displayed for 3 seconds.

### Erasing the entire HomeLink® memory (all three codes)

Press and hold the 2 outside buttons for 10 seconds until the HomeLink® indicator light changes from continuously lit (orange) to rapidly flashing (green).

If you sell your vehicle, be sure to erase the programs stored in the HomeLink® memory.

- ▶ Vehicles with auto anti-glare inside rear view mirror

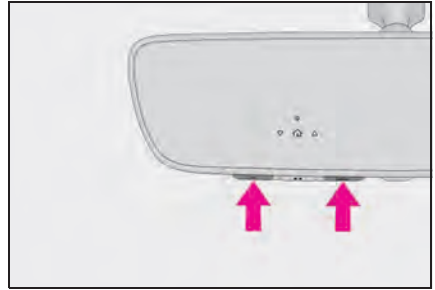

- ▶ Vehicles with Digital Rearview Mirror



**6-1. Maintenance and care**

Cleaning and protecting the vehicle exterior ..... **458**

Cleaning and protecting the vehicle interior ..... **461**

**6-2. Maintenance**

Maintenance requirements ..... **464**

General maintenance ..... **465**

Emission inspection and maintenance (I/M) programs ..... **468**

**6-3. Do-it-yourself maintenance**

Do-it-yourself service precautions ..... **469**

Hood..... **471**

Positioning a floor jack..... **471**

Engine compartment..... **473**

12-volt battery..... **481**

Tires ..... **483**

Tire inflation pressure..... **493**

Wheels..... **495**

Air conditioning filter..... **496**

Cleaning the hybrid battery (traction battery) air intake vents ..... **498**

Electronic key battery ..... **501**

Checking and replacing fuses ..... **503**

Headlight aim..... **505**

Light bulbs..... **506**

## Cleaning and protecting the vehicle exterior

Perform cleaning in a manner appropriate to each component and its material.

### Cleaning instructions

- Working from top to bottom, liberally apply water to the vehicle body, wheel wells and underside of the vehicle to remove any dirt and dust.
- Wash the vehicle body using a sponge or soft cloth, such as a chamois.
- For hard-to-remove marks, use car wash soap and rinse thoroughly with water.
- Wipe away any water.
- Wax the vehicle when the water-proof coating deteriorates.

If water does not bead on a clean surface, apply wax when the vehicle body is cool.

#### ■ Self-restoring coat

The vehicle body has a self-restoring coating that is resistant to small surface scratches caused in a car wash etc.

- The coating lasts for 5 to 8 years from when the vehicle is delivered from the plant.
- The restoration time differs depending on the depth of the scratch and outside temperature.  
The restoration time may become shorter when the coating is warmed by applying warm water.
- Deep scratches caused by keys, coins, etc. cannot be restored.
- Do not use wax that contains abrasives.

#### ■ Automatic car washes

- Before washing the vehicle:
  - Fold the mirrors
  - Turn off the power back door

Start washing from the front of the vehicle. Extend the mirrors before driving.

- Brushes used in automatic car washes may scratch the vehicle surface, parts (wheel, etc.) and harm your vehicle's paint.
- Rear spoiler may not be washable in some automatic car washes. There may also be an increased risk of damage to vehicle.
- When the shift position needs to be held in N, refer to P.219, 225.

#### ■ High pressure car washes

As water may enter the cabin, do not bring the nozzle tip near the gaps around the doors or perimeter of the windows, or spray these areas continuously.

#### ■ When using a car wash

If the door handle becomes wet while the electronic key is within the effective range, the door may lock and unlock repeatedly. In that case, follow the following correction procedures to wash the vehicle:

- Place the key in a position 6 ft. (2 m) or more separate from the vehicle while the vehicle is being washed. (Take care to ensure that the key is not stolen.)
- Set the electronic key to battery-saving mode to disable the smart access system with push-button start. (→P.140)

#### ■ Wheels and wheel ornaments (vehicles without matte painted wheels)

- Remove any dirt immediately by using a neutral detergent.
- Wash detergent off with water immediately after use.
- To protect the paint from damage, make sure to observe the following precautions.
  - Do not use acidic, alkaline or abrasive detergent
  - Do not use hard brushes
  - Do not use detergent on the wheels when they are hot, such as after driving or park-

ing in hot weather

### ■ Wheels and wheel ornaments (vehicles with matte painted wheels)

A different set of care is necessary for matte painted wheels and wheel ornaments. Contact your Lexus dealer for details.

- Remove any dirt with water immediately. If the wheels are excessively dirty, use diluted neutral detergent.
- When using detergent, make sure to wash it off with water immediately. Then use a soft cloth to wipe off the water.
- Use a sponge or soft cloth to remove the dirt by hand.
- To prevent the matte paint from being damaged or glossy, make sure to observe the following precautions:
  - Do not apply any coatings or wax.
  - Do not use acidic, alkaline or abrasive detergents.
  - When using tire cleaners or tire wax, do not allow them to be applied to the wheels.
  - Do not scrub or polish the wheels using a brush or dry cloth, etc.
  - When using an automatic car wash, do not select the wheel brush function.
  - Do not use a high pressure washer or steam cleaner.
  - Do not use detergent on the wheels when they are hot, such as after driving or parking in hot weather.

### ■ Brake pads and calipers

Rust may form if the vehicle is parked with wet brake pads or disc rotors, causing them to stick. Before parking the vehicle after it is washed, drive slowly and apply the brakes several times to dry the parts.

### ■ Brake caliper coating (F SPORT models)

- When using detergent, use neutral detergent. Do not use hard brushes or abrasive cleaners, as they will damage the coating.
- Do not use detergent on the brake calipers when they are hot.
- Wash detergent off immediately after use.

### ■ Bumpers

Do not scrub with abrasive cleaners.

### ■ Front side windows water-repellent coating

The following precautions can extend the effectiveness of the water-repellent coating.

- Remove any dirt, etc. from the front side windows regularly.
- Do not allow dirt and dust to accumulate on the windows for a long period. Clean the windows with a soft, damp cloth as soon as possible.
- Do not use wax or glass cleaners that contain abrasives when cleaning the windows.
- Do not use any metallic objects to remove condensation build up.

### ■ Plated portions

If dirt cannot be removed, clean the parts as follows:

- Use a soft cloth dampened with an approximately 5% solution of neutral detergent and water to clean the dirt off.
- Wipe the surface with a dry, soft cloth to remove any remaining moisture.
- To remove oily deposits, use alcohol wet wipes or a similar product.



### WARNING

#### ■ When washing the vehicle

Do not apply water to the inside of the engine compartment. Doing so may cause the electrical components, etc. to catch fire.

#### ■ When cleaning the windshield

Set the wiper switch to off. If the switch is in "AUTO", the wipers may operate unexpectedly in the following situations, and may result in hands being caught or other serious injuries and cause damage to the wiper blades.

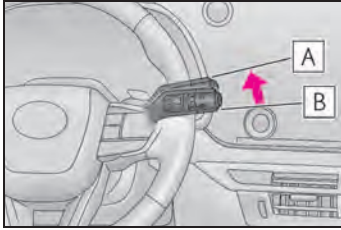
**WARNING****A** Off**B** AUTO

- When the upper part of the windshield where the raindrop sensor is located is touched by hand
- When a wet rag or similar is held close to the raindrop sensor
- If something bumps against the windshield
- If you directly touch the raindrop sensor body or if something bumps into the raindrop sensor

**■ Precautions regarding the exhaust pipe**

Exhaust gasses cause the exhaust pipe to become quite hot. When washing the vehicle, be careful not to touch the pipe until it has cooled sufficiently, as touching a hot exhaust pipe can cause burns.

**■ Precaution regarding the front and rear bumpers**

If the paint of the front or rear bumper is chipped or scratched, the following systems may not function correctly. If this occurs, consult your Lexus dealer.

- Lexus Safety System + 3
- BSM (Blind Spot Monitor)
- Safe Exit Assist
- Intuitive parking assist
- RCTA (Rear cross traffic alert)

- PKSB (Parking Support Brake) (if equipped)

**NOTICE**

- **To prevent paint deterioration and corrosion on the body and components (aluminum wheels, etc.)**
- Wash the vehicle immediately in the following cases:
  - After driving near the sea coast
  - After driving on salted roads
  - If coal tar or tree sap is present on the paint surface
  - If dead insects, insect droppings or bird droppings are present on the paint surface
  - After driving in an area contaminated with soot, oily smoke, mine dust, iron powder or chemical substances
  - If the vehicle becomes heavily soiled with dust or mud
  - If liquids such as benzene and gasoline are spilled on the paint surface
- If the paint is chipped or scratched, have it repaired immediately.
- To prevent the wheels from corroding, remove any dirt and store in a place with low humidity when storing the wheels.
- **Cleaning the exterior lights**
- Wash carefully. Do not use organic substances or scrub with a hard brush. This may damage the surfaces of the lights.
- Do not apply wax to the surfaces of the lights. Wax may cause damage to the lenses.

**NOTICE****■ When using an automatic car wash**

Set the wiper switch to the off position. If the wiper switch is in "AUTO", the wipers may operate and the wiper blades may be damaged.

**■ When using a high pressure car wash**

● When washing the vehicle, do not spray the camera or its surrounding area directly with a high pressure washer. Shock applied from high pressure water may cause the device to not operate normally.

● Do not spray water directly on the radar which is equipped behind the emblem. Otherwise it may cause the device to be damaged.

● Do not bring the nozzle tip close to boots (rubber or resin manufactured cover), connectors or the following parts. The parts may be damaged if they come into contact with high-pressure water.

- Traction related parts
- Steering parts
- Suspension parts
- Brake parts

● Keep the cleaning nozzle at least 11.9 in. (30 cm) away from the vehicle body. Otherwise resin section, such as moldings and bumpers, may be deformed and damaged.

Also, do not continuously hold the nozzle in the same place.

● Do not spray the lower part of the windshield continuously.

If water enters the air conditioning system intake located near the lower part of the windshield, the air conditioning system may not operate correctly.

● Do not wash the underside of the vehicle using a high pressure car washer.

**Cleaning and protecting the vehicle interior**

**Perform cleaning in a manner appropriate to each component and its material.**

**Protecting the vehicle interior**

- Remove dirt and dust using a vacuum cleaner. Wipe dirty surfaces with a cloth dampened with lukewarm water.
- If dirt cannot be removed, wipe it off with a soft cloth dampened with neutral detergent diluted to approximately 1%.  
Wring out any excess water from the cloth and thoroughly wipe off remaining traces of detergent and water.

**■ Shampooing the carpets**

There are several commercial foaming-type cleaners available. Use a sponge or brush to apply the foam. Rub in overlapping circles. Do not use water. Wipe dirty surfaces and let them dry. Excellent results are obtained by keeping the carpet as dry as possible.

**■ Handling the seat belts**

Clean with mild soap and lukewarm water using a cloth or sponge. Also check the belts periodically for excessive wear, fraying or cuts.

**WARNING****Water in the vehicle**

- Do not splash or spill liquid in the vehicle, such as on the floor, in the hybrid battery (traction battery) air vents, and in the luggage compartment. (→P.80) Doing so may cause the hybrid battery, electrical components, etc. to malfunction or catch fire.
- Do not get any of the SRS components or wiring in the vehicle interior wet. (→P.32)  
An electrical malfunction may cause the airbags to deploy or not function properly, resulting in death or serious injury.
- Vehicles with wireless charger: Do not let the wireless charger (→P.435) get wet. Failure to do so may cause the charger to become hot and cause burns or could cause electric shock resulting in death or serious injury.

**Cleaning the interior (especially instrument panel)**

Do not use polish wax or polish cleaner. The instrument panel may reflect off the windshield, obstructing the driver's view and leading to an accident, resulting in death or serious injury.

**NOTICE****Cleaning detergents**

- Do not use the following liquids, as they may discolor the vehicle interior or cause streaks or damage to painted surfaces:
  - Areas other than the seats and steering wheel: Organic substances such as benzene or gasoline, alkaline or acidic solutions, dye, and bleach
  - Seats: Alkaline or acidic solutions, such as thinner, benzene, and alcohol

- Steering wheel: Organic substances, such as thinner, and cleaner that contains alcohol

- Do not use polish wax or polish cleaner. The instrument panel's or other interior part's painted surface may be damaged.

**Preventing damage to leather surfaces**

Observe the following precautions to avoid damage to and deterioration of leather surfaces:

- Remove any dust or dirt from leather surfaces immediately.
- Do not expose the vehicle to direct sunlight for extended periods of time. Park the vehicle in the shade, especially during summer.
- Do not place items made of vinyl, plastic, or containing wax on the upholstery, as they may stick to the leather surface if the vehicle interior heats up significantly.

**Water on the floor**

Do not wash the vehicle floor with water. Vehicle systems such as the audio system may be damaged if water comes into contact with electrical components such as the audio system above or under the floor of the vehicle. Water may also cause the body to rust.

**When cleaning the inside of the windshield**

Do not allow glass cleaner to contact the lens. Also, do not touch the lens. (→P.253)

**NOTICE**

**■ Cleaning the inside of the rear window**

- Do not use glass cleaner to clean the rear window, as this may cause damage to the rear window defogger heater wires or antenna. Use a cloth dampened with lukewarm water to gently wipe the window clean. Wipe the window in strokes running parallel to the heater wires or antenna.
- Be careful not to scratch or damage the heater wires or antenna.

- Wipe it off with a soft cloth dampened with neutral detergent diluted to approximately 1%.
- Wring out any excess water from the cloth and thoroughly wipe off remaining traces of detergent and water.

### Cleaning the leather areas

- Remove dirt and dust using a vacuum cleaner.
- Wipe off any excess dirt and dust with a soft cloth dampened with diluted detergent.

Use a diluted water solution of approximately 5% neutral wool detergent.

- Wring out any excess water from the cloth and thoroughly wipe off all remaining traces of detergent.
- Wipe the surface with a dry, soft cloth to remove any remaining moisture. Allow the leather to dry in a shaded and ventilated area.

### ■ Caring for leather areas

Lexus recommends cleaning the interior of the vehicle at least twice a year to maintain the quality of the vehicle's interior.

### Cleaning the synthetic leather areas

- Remove dirt and dust using a vacuum cleaner.

## Maintenance requirements

To ensure safe and economical driving, day-to-day care and regular maintenance are essential. It is the owner's responsibility to perform regular checks. Lexus recommends the following maintenance:

### ■ Repair and replacement

It is recommended that genuine Lexus parts be used for repairs to ensure performance of each system. If non-Lexus parts are used in replacement or if a repair shop other than a Lexus dealer performs repairs, confirm the warranty coverage.

### ■ Allow inspection and repairs to be performed by a Lexus dealer

- Lexus technicians are well-trained specialists and are kept up to date with the latest service information. They are well informed about the operation of all systems on your vehicle.
- Keep a copy of the repair order. It proves that the maintenance that has been performed is under warranty coverage. If any problem should arise while your vehicle is under warranty, your Lexus dealer will promptly take care of it.



### WARNING

#### ■ If your vehicle is not properly maintained

Improper maintenance could result in serious damage to the vehicle and possible death or serious injury.

#### ■ Handling of the 12-volt battery

- Engine exhaust, some of its constituents, and a wide variety of automobile components contain or emit chemicals known to the State of California to cause cancer and birth defects and other reproductive harm. Work in a well ventilated area.

- Oils, fuels and fluids contained in vehicles as well as waste produced by component wear contain or emit chemicals known to the State of California to cause cancer and birth defects or other reproductive harm. Avoid exposure and wash any affected area immediately.
- 12-volt battery posts, terminals and related accessories contain lead and lead compounds which are known to cause brain damage. Wash your hands after handling. (→P.481)

## General maintenance

General maintenance should be performed on a daily basis. This can be done by yourself or by a Lexus dealer.

## Scheduled maintenance

Scheduled maintenance should be performed at specified intervals according to the maintenance schedule.

For details about maintenance items and schedules, refer to the "Warranty and Service Guide", "Owner's Manual Supplement" or "Scheduled Maintenance".

### ■ Resetting the message indicating maintenance is required

After the required maintenance is performed according to the maintenance schedule, please reset the message. To reset the message, follow the procedures described below:

- 1 Select  on the center display.
- 2 Select "Vehicle customize".
- 3 Select "Utility".
- 4 Select "Scheduled maintenance".
- 5 Select "Reset".

"The data has been reset" will be displayed

on the center display when the reset procedure has been completed.

### Do-it-yourself maintenance

You can perform some maintenance procedures by yourself.

Please be aware that do-it-yourself maintenance may affect warranty coverage.

The use of Lexus repair manuals is recommended.

For details about warranty coverage, refer to the separate "Owner's Guide", "Warranty and Service Guide", "Owner's Manual Supplement" or "Warranty Booklet".

## General maintenance

Listed below are the general maintenance items that should be performed at the intervals specified in the "Warranty and Service Guide" or "Owner's Manual Supplement". It is recommended that any problem you notice should be brought to the attention of your Lexus dealer or qualified service shop for advice.

### WARNING

#### ■ If the hybrid system is operating

Turn the hybrid system off and ensure that there is adequate ventilation before performing maintenance checks.

## Engine compartment

Items	Check points
Brake fluid	Is the brake fluid at the correct level? (→P.479)
Engine/inter-cooler/power control unit coolant	Is the engine/inter-cooler/power control unit coolant at the correct level? (→P.477)
Engine oil	Is the engine oil at the correct level? (→P.474)
Exhaust system	There should not be any fumes or strange sounds.

Items	Check points
Radiator, condenser and inter-cooler radiator	The radiator, condenser and inter-cooler radiator should be free from foreign objects. (→P.479)
Washer fluid	Is there sufficient washer fluid? (→P.480)

### Luggage compartment

Items	Check points
12-volt battery	Check the connections. (→P.481)

### Vehicle interior

Items	Check points
Accelerator pedal	<ul style="list-style-type: none"> <li>The accelerator pedal should move smoothly (without uneven pedal effort or catching).</li> </ul>
Hybrid transmission "Park" mechanism	<ul style="list-style-type: none"> <li>When parked on a slope and the shift position is in P, is the vehicle securely stopped?</li> </ul>
Brake pedal	<ul style="list-style-type: none"> <li>Does the brake pedal move smoothly?</li> <li>Does the brake pedal have appropriate clearance from the floor?</li> <li>Does the brake pedal have the correct amount of free play?</li> </ul>

Items	Check points
Brakes	<ul style="list-style-type: none"> <li>The vehicle should not pull to one side when the brakes are applied.</li> <li>The brakes should work effectively.</li> <li>The brake pedal should not feel spongy.</li> <li>The brake pedal should not get too close to the floor when the brakes are applied.</li> </ul>
Head restraints	<ul style="list-style-type: none"> <li>Do the head restraints move smoothly and lock securely?</li> </ul>
Indicators/buzzers	<ul style="list-style-type: none"> <li>Do the indicators and buzzers function properly?</li> </ul>
Lights	<ul style="list-style-type: none"> <li>Do all the lights come on?</li> <li>Are the headlights aimed correctly? (→P.505)</li> </ul>
Parking brake	<ul style="list-style-type: none"> <li>Does the parking brake switch operate normally?</li> <li>When parked on a slope and the parking brake is on, is the vehicle securely stopped?</li> </ul>
Seat belts	<ul style="list-style-type: none"> <li>Do the seat belts operate smoothly?</li> <li>The seat belts should not be damaged.</li> </ul>

Items	Check points
Seats	<ul style="list-style-type: none"> <li>• Do the seat controls operate properly?</li> </ul>
Steering wheel	<ul style="list-style-type: none"> <li>• Does the steering wheel rotate smoothly?</li> <li>• Does the steering wheel have the correct amount of free play?</li> <li>• There should not be any strange sounds coming from the steering wheel.</li> </ul>

### Vehicle exterior

Items	Check points
Doors	<ul style="list-style-type: none"> <li>• Do the doors operate smoothly?</li> </ul>
Engine hood	<ul style="list-style-type: none"> <li>• Does the engine hood lock system work properly?</li> </ul>
Fluid leaks	<ul style="list-style-type: none"> <li>• There should not be any signs of fluid leakage after the vehicle has been parked.</li> </ul>

Items	Check points
Tires	<ul style="list-style-type: none"> <li>• Is the tire inflation pressure correct?</li> <li>• The tires should not be damaged or excessively worn.</li> <li>• Have the tires been rotated according to the maintenance schedule?</li> <li>• The wheel bolts should not be loose.</li> </ul>
Windshield wipers/rear window wiper	<ul style="list-style-type: none"> <li>• The wiper blades should not show any signs of cracking, splitting, wear, contamination or deformation.</li> <li>• The wiper blades should clear the windshield/rear window without streaking or skipping.</li> </ul>

## Emission inspection and maintenance (I/M) programs

Some states have vehicle emission inspection programs which include OBD (On Board Diagnostics) checks. The OBD system monitors the operation of the emission control system.

### If the malfunction indicator lamp comes on

The OBD system determines that a problem exists somewhere in the emission control system. Your vehicle may not pass the I/M test and may need to be repaired. Contact your Lexus dealer to service the vehicle.

### Your vehicle may not pass the I/M test in the following situations:

- When the 12-volt battery is disconnected or discharged

Readiness codes that are set during ordinary driving are erased.

Also, depending on your driving habits, the readiness codes may not be completely set.

- When the fuel tank cap is loose

The malfunction indicator lamp comes on indicating a temporary malfunction and your vehicle may not pass the I/M test.

### When the malfunction indicator lamp still remains on after several driving trips

The error code in the OBD system will not be cleared unless the vehicle is driven 40 or more times.

### If your vehicle does not pass the I/M test

Contact your Lexus dealer to prepare the vehicle for re-testing.

## Do-it-yourself service precautions

If you perform maintenance by yourself, be sure to follow the correct procedure as given in these sections.

## Maintenance

Items	Parts and tools
12-volt battery condition (→P.481)	<ul style="list-style-type: none"> <li>• Grease</li> <li>• Conventional wrench (for terminal clamp bolts)</li> </ul>
Brake fluid level (→P.479)	<ul style="list-style-type: none"> <li>• FMVSSNo.116 DOT 3 or SAE J1703 brake fluid</li> <li>• FMVSSNo.116 DOT 4 or SAE J1704 brake fluid</li> <li>• Rag or paper towel</li> <li>• Funnel (used only for adding brake fluid)</li> </ul>

Items	Parts and tools
Engine/inter-cooler/power control coolant level (→P.477)	<ul style="list-style-type: none"> <li>• “Toyota Super Long Life Coolant” or a similar high quality ethylene glycol-based non-silicate, non-amine, non-nitrite and non-borate coolant with long-life hybrid organic acid technology</li> <li>For the U.S.A.: “Toyota Super Long Life Coolant” is pre-mixed with 50% coolant and 50% deionized water.</li> <li>For Canada: “Toyota Super Long Life Coolant” is pre-mixed with 55% coolant and 45% deionized water.</li> <li>• Funnel (used only for adding coolant)</li> </ul>
Engine oil level (→P.474)	<ul style="list-style-type: none"> <li>• “Toyota Genuine Motor Oil” or equivalent</li> <li>• Rag or paper towel</li> <li>• Funnel (used only for adding engine oil)</li> </ul>
Fuses (→P.503)	<ul style="list-style-type: none"> <li>• Fuse with same amperage rating as original</li> </ul>
Headlight aim (→P.505)	<ul style="list-style-type: none"> <li>• Phillips-head screwdriver</li> </ul>
Light bulbs (→P.506)	<ul style="list-style-type: none"> <li>• Bulb with same number and wattage rating as original</li> </ul>

Items	Parts and tools
Radiator, condenser and inter-cooler radiator (→P.479)	—
Tire inflation pressure (→P.493)	<ul style="list-style-type: none"> <li>• Tire pressure gauge</li> <li>• Compressed air source</li> </ul>
Washer fluid (→P.480)	<ul style="list-style-type: none"> <li>• Water or washer fluid containing anti-freeze (for winter use)</li> <li>• Funnel (used only for adding water or washer fluid)</li> </ul>



### WARNING

The engine compartment contains many mechanisms and fluids that may move suddenly, become hot, or become electrically energized. To avoid death or serious injury, observe the following precautions.

#### ■ When working on the engine compartment

- Make sure that the "ACCESSORY" or "IGNITION ON" on the multi-information display and the "READY" indicator are both off.
- Keep hands, clothing and tools away from the moving fan.
- Be careful not to touch the engine, power control unit, radiator, exhaust manifold, etc. right after driving as they may be hot. Oil and other fluids may also be hot.
- Do not leave anything that may burn easily, such as paper and rags, in the engine compartment.

#### ■ When working near the electric cooling fan or radiator grille

Be sure the power switch is off. With the power switch in ON, the electric cooling fan may automatically start to run if the air conditioning is on and/or the coolant temperature is high. (→P.479)

#### ■ Safety glasses

Wear safety glasses to prevent flying or falling material, fluid spray, etc. from getting in your eyes.



### NOTICE

#### ■ If you remove the air cleaner filter

Driving with the air cleaner filter removed may cause excessive engine wear due to dirt in the air.

## Hood

### Opening the hood

- 1 Pull the hood lock release lever.

The hood will pop up slightly.

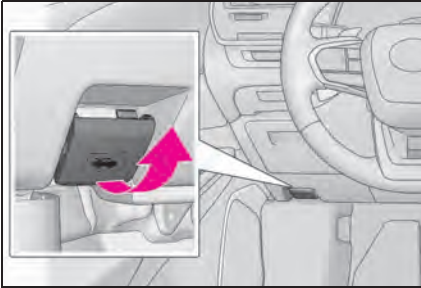

- 2 Pull up the auxiliary catch lever and lift the hood.

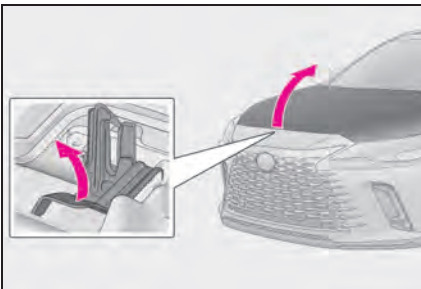

### **⚠** WARNING

#### ■ When the hood is open (RX500h)

Even if the power switch is turned off, the cooling fan may continue to operate for a short time. When the cooling fan is rotating, do not touch or approach the inside of the engine compartment.

#### ■ Pre-driving check

Check that the hood is fully closed and locked.  
If the hood is not locked properly, it may open while the vehicle is in motion and cause an accident, which may result in death or serious injury.

### Positioning a floor jack

When using a floor jack, follow the instructions in the manual provided with the jack and perform the operation safely.

When raising your vehicle with a floor jack, position the jack correctly. Improper placement may damage your vehicle or cause injury.

### Location of the jack point

#### ■ Front

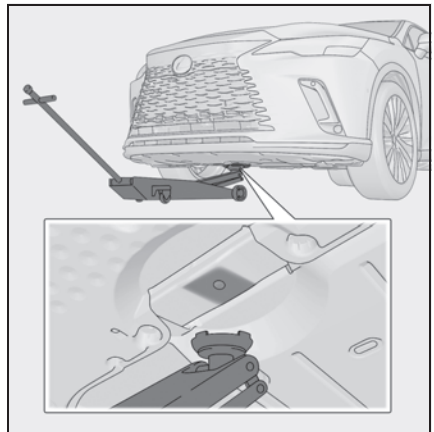

## ■ Rear

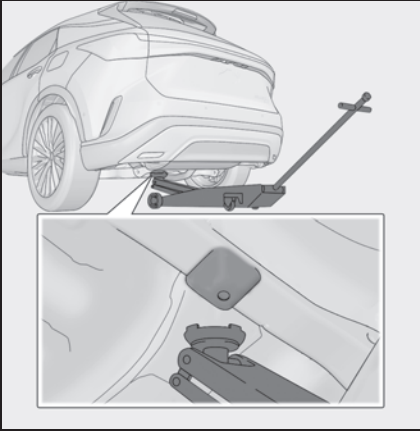

## Engine compartment

### Components

#### ► RX500h

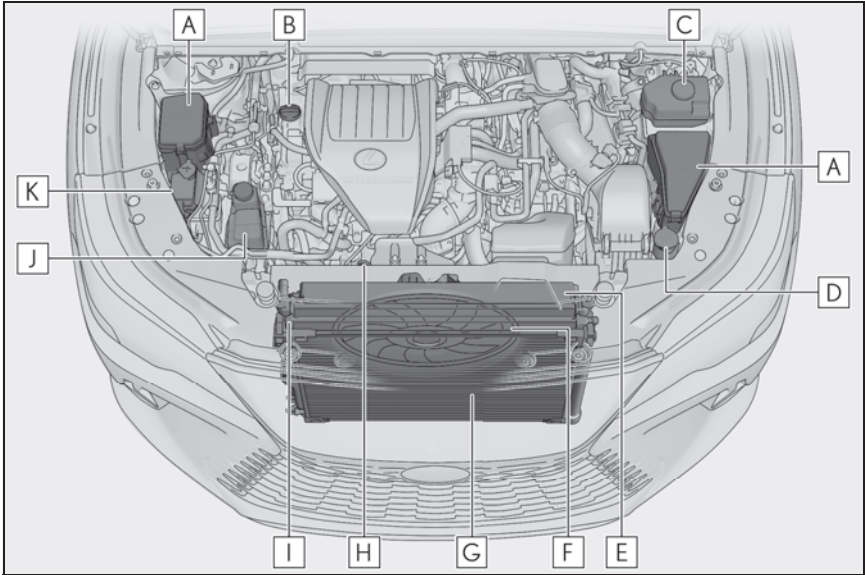

- A** Fuse boxes (→P.503)
- B** Engine oil filler cap (→P.476)
- C** Brake fluid reservoir (→P.479)
- D** Washer fluid tank (→P.480)
- E** Radiator (→P.479)
- F** Electric cooling fan
- G** Condenser (→P.479)
- H** Engine oil level dipstick (→P.474)
- I** Intercooler radiator (→P.479)
- J** Intercooler/Power control unit coolant reservoir (→P.477)
- K** Engine coolant reservoir (→P.477)

## ▶ RX350h

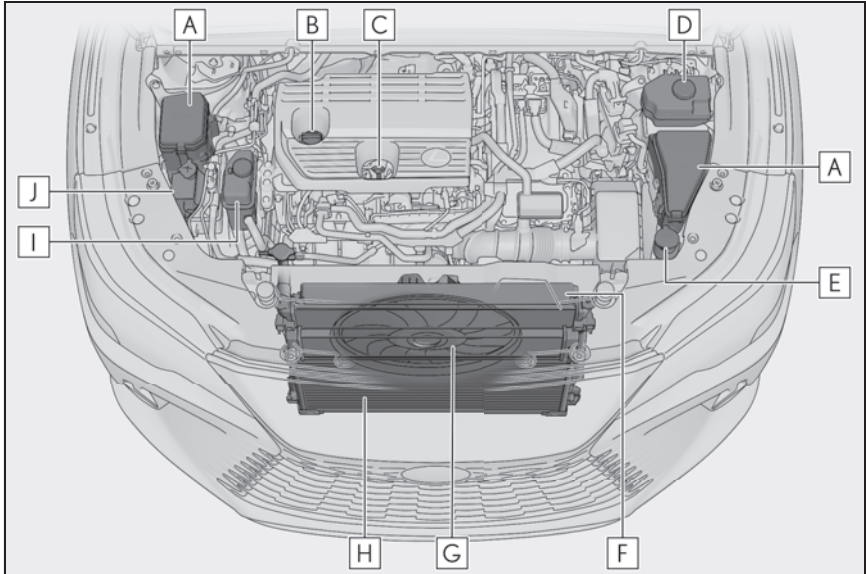

**A** Fuse boxes (→P.503)

**B** Engine oil filler cap (→P.476)

**C** Engine oil level dipstick (→P.474)

**D** Brake fluid reservoir (→P.479)

**E** Washer fluid tank (→P.480)

**F** Radiator (→P.479)

**G** Electric cooling fan

**H** Condenser (→P.479)

**I** Power control unit coolant reservoir (→P.477)

**J** Engine coolant reservoir (→P.477)

#### ■ 12-volt battery

→P.481

### Checking the engine oil

With the engine at operating temperature and turned off, check the oil level on the dipstick.

- 1 Park the vehicle on level ground. After warming up the engine and turning off the hybrid system, wait about 5 minutes for the oil to drain back into the bottom of the engine.
- 2 Holding a rag under the end, pull the dipstick out.

## ▶ RX500h

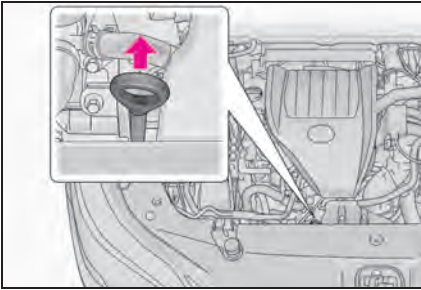

## ▶ RX350h

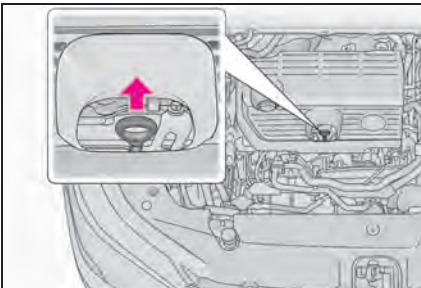

- 3 Wipe the dipstick clean.
- 4 Reinsert the dipstick fully.
- 5 Holding a rag under the end, pull the dipstick out and check whether the oil level is above low level mark.

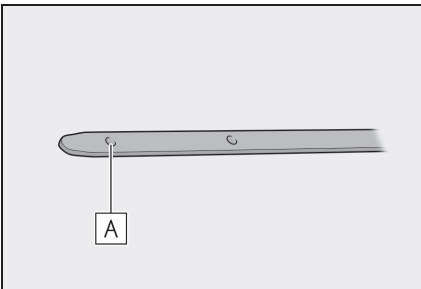
**A** Low level mark

The shape of the dipstick may differ depending on the type of vehicle or engine.

- 6 Wipe the dipstick and reinsert it fully.

## ■ Engine oil consumption

A certain amount of engine oil will be consumed while driving. In the following situations, oil consumption may increase, and engine oil may need to be refilled in between oil maintenance intervals.

- When the engine is new, for example directly after purchasing the vehicle or after replacing the engine
- If low quality oil or oil of an inappropriate viscosity is used
- When driving at high engine speeds or with a heavy load, when towing <sup>\*</sup>, or when driving while accelerating or decelerating frequently
- When leaving the engine idling for a long time, or when driving frequently through heavy traffic

<sup>\*</sup>: Vehicles with towing package

## ■ Engine oil level rise

If the vehicle is repeatedly driven without the engine warmed up, moisture caused by dew condensation inside the engine or fuel which did not burn mixes into the engine oil, resulting in a rise in engine oil level. However, this is not a malfunction.

For example, the engine become difficult to be warmed up in the following situations.

- When driving a short distance
- When driving at a low speed
- When the outside temperature is low

When checking the engine oil, make sure that the engine is warmed up. If the engine oil level exceeds the refill upper limit mark, contact your Lexus dealer.

 NOTICE

 **To prevent serious engine damage**

Check the oil level on a regular basis.

## Adding engine oil

### ■ Checking the oil type and preparing the item needed

Make sure to check the oil type and prepare the items needed before adding oil.

- Engine oil selection  
→P.572
- Oil quantity (Low level mark → Refill upper limit mark)  
1.6 qt. (1.5 L, 1.3 Imp. qt.)
- Item  
Clean funnel

### ■ Adding engine oil

If the oil level is below or near the low level mark, add engine oil of the same type as that already in the engine.

#### ▶ RX500h

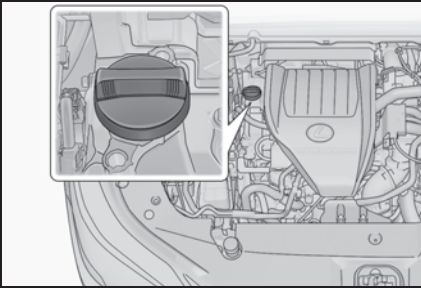

#### ▶ RX350h

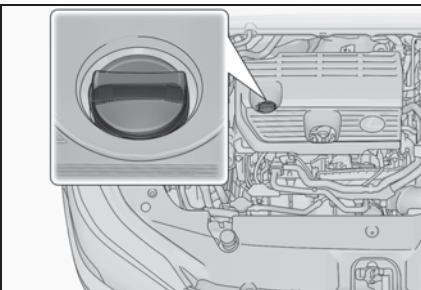

- 1 Remove the oil filler cap by turning it counterclockwise.
- 2 Add engine oil slowly, checking the dipstick.

Make sure that the oil level does not exceed the refill upper limit mark and is between the low level mark and refill upper limit mark.

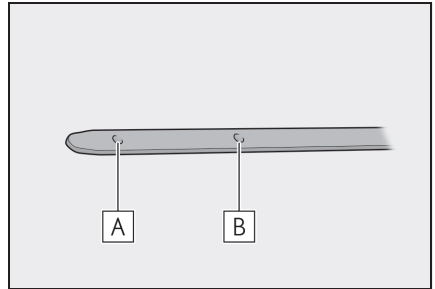

**A** Low level mark

**B** Refill upper limit mark

The shape of the dipstick may differ depending on the type of vehicle or engine.

- 3 Install the oil filler cap by turning it clockwise.

### ■ After changing the engine oil

After the engine oil has been replaced, the engine oil maintenance data should be reset. Perform the following procedures:

- 1 Select  on the center display.
- 2 Select "Vehicle customize".
- 3 Select "Utility".
- 4 Select "Oil maintenance".
- 5 Select "Reset".

"The data has been reset" will be displayed on the center display when the reset procedure has been completed.

### WARNING

#### ■ Used engine oil

- Used engine oil contains potentially harmful contaminants which may cause skin disorders such as inflammation and skin cancer, so care should be taken to avoid prolonged and repeated contact. To remove used engine oil from your skin, wash thoroughly with soap and water.
- Dispose of used oil and filters only in a safe and acceptable manner. Do not dispose of used oil and filters in household trash, in sewers or onto the ground.  
Call your Lexus dealer, service station or auto parts store for information concerning recycling or disposal.
- Do not leave used engine oil within the reach of children.

### NOTICE

#### ■ When replacing the engine oil

- Be careful not to spill engine oil on the vehicle components.
- Avoid overfilling, or the engine could be damaged.
- Check the oil level on the dipstick every time you refill the vehicle.
- Be sure the engine oil filler cap is properly tightened.

#### ■ If oil is spilled on the engine cover

To prevent the engine cover from being damaged, remove any engine oil from the engine cover as soon as possible using a neutral detergent. Do not use an organic solvent such as brake cleaner.

## Checking the coolant

### ■ Engine coolant reservoir

The coolant level is satisfactory if it is

between the “FULL” and “LOW” lines on the reservoir when the hybrid system is cold.

#### ▶ RX500h

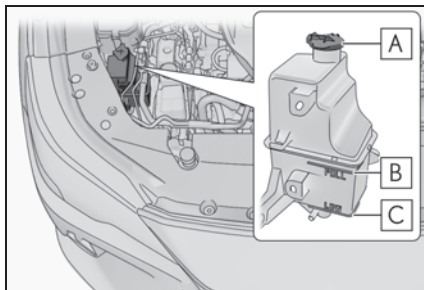

**A** Reservoir cap

**B** “FULL” line

**C** “LOW” line

If the level is on or below the “LOW” line, add coolant up to the “FULL” line.  
(→P.560)

#### ▶ RX350h

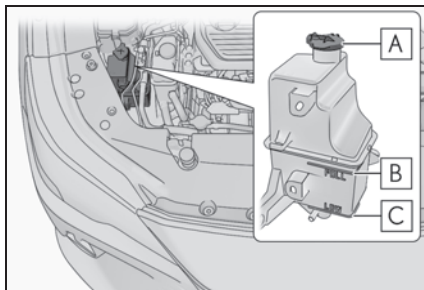

**A** Reservoir cap

**B** “FULL” line

**C** “LOW” line

If the level is on or below the “LOW” line, add coolant up to the “FULL” line.  
(→P.560)

### ■ Intercooler/Power control unit coolant reservoir (RX500h)

The coolant level is satisfactory if it is

between the “MAX” and “MIN” lines on the reservoir when the engine is cold.

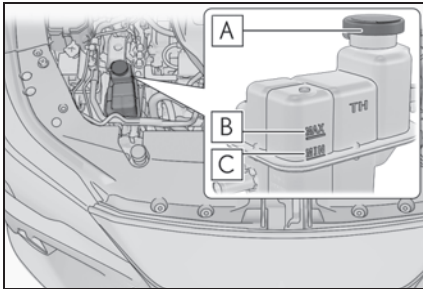

**A** Reservoir cap

**B** “MAX” line

**C** “MIN” line

If the level is on or below the “MIN” line, add coolant up to the “MAX” line. (→P.560)

#### ■ Power control unit coolant reservoir (RX350h)

The coolant level is satisfactory if it is between the “FULL” and “LOW” lines on the reservoir when the hybrid system is cold.

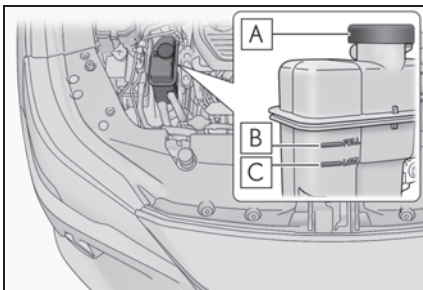

**A** Reservoir cap

**B** “FULL” line

**C** “LOW” line

If the level is on or below the “LOW” line, add coolant up to the “FULL” line. (→P.560)

#### ■ Coolant selection

Only use “Toyota Super Long Life Coolant” or a similar high quality ethylene glycol based non-silicate, non-amine, non-nitrite, and non-borate coolant with long-life hybrid organic acid technology.

U.S.A.:

“Toyota Super Long Life Coolant” is a mixture of 50% coolant and 50% deionized water. (Minimum temperature: -31°F [-35°C])

Canada:

“Toyota Super Long Life Coolant” is a mixture of 55% coolant and 45% deionized water. (Minimum temperature: -44°F [-42°C])

For more details about coolant, contact your Lexus dealer.

#### ■ If the coolant level drops within a short time of replenishing

Visually check the radiator, hoses, engine/power control unit coolant reservoir caps, drain cock and water pump. If you cannot find a leak, have your Lexus dealer test the cap and check for leaks in the cooling system.

#### ⚠ WARNING

##### ■ When the hybrid system is hot

Do not remove the engine/inter-cooler\*/power control unit coolant reservoir caps and radiator cap.

The cooling system may be under pressure and may spray hot coolant if the cap is removed, causing serious injuries, such as burns.

\* : RX500h only

**NOTICE****When adding coolant**

Coolant is neither plain water nor straight antifreeze. The correct mixture of water and antifreeze must be used to provide proper lubrication, corrosion protection and cooling. Be sure to read the antifreeze or coolant label.

**If you spill coolant**

Be sure to wash it off with water to prevent it from damaging parts or paint.

**Checking the radiator, condenser and intercooler radiator \***

\*: RX500h only

Check the radiator, condenser and intercooler radiator (RX500h only) and clear away any foreign objects. If either of the above parts is extremely dirty or you are not sure of their condition, have your vehicle inspected by your Lexus dealer.

**WARNING****When the hybrid system is hot**

Do not touch the radiator, condenser or intercooler radiator \* as they may be hot and cause serious injuries, such as burns.

\*: RX500h only

**Checking and adding the brake fluid****Checking fluid level**

The brake fluid level should be between the “MAX” and “MIN” lines on the tank.

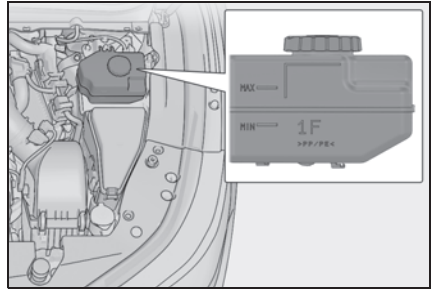
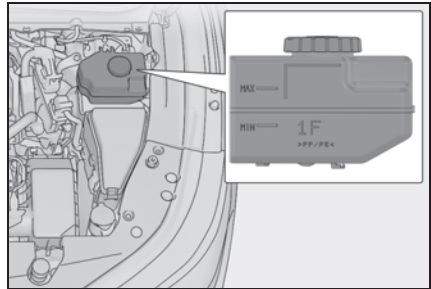
**RX500h****RX350h****Adding fluid**

Make sure to check the fluid type and prepare the necessary item.

**Fluid type**

FMVSS No.116 DOT 3 or SAE J1703  
brake fluid

FMVSS No.116 DOT 4 or SAE J1704  
brake fluid

**Item**

Clean funnel

**Brake fluid can absorb moisture from the air**

Excess moisture in the brake fluid can cause a dangerous loss of braking efficiency. Use only newly opened brake fluid.

### ⚠ WARNING

#### ■ When filling the reservoir

Take care as brake fluid can harm your hands and eyes and damage painted surfaces.

If fluid gets on your hands or in your eyes, flush the affected area with clean water immediately.

If you still experience discomfort, see a doctor.

### ⚠ NOTICE

#### ■ If the fluid level is low or high

It is normal for the brake fluid level to go down slightly as the brake pads wear out or when the fluid level in the accumulator is high.

If the reservoir needs frequent refilling, there may be a serious problem.

## Washer fluid

If any washer does not work or the warning message appears on the multi-information display, the washer tank may be empty. Add washer fluid.

### ▶ RX500h

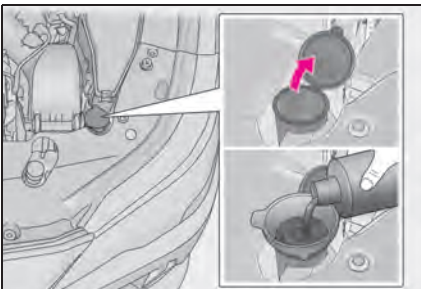

### ▶ RX350h

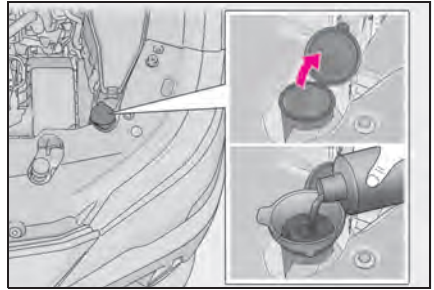

### ⚠ WARNING

#### ■ When adding washer fluid

Do not add washer fluid when the hybrid system is hot or operating as washer fluid contains alcohol and may catch fire if spilled on the engine, etc.

### ⚠ NOTICE

#### ■ Do not use any fluid other than washer fluid

Do not use soapy water or engine anti-freeze instead of washer fluid.

Doing so may cause streaking on the vehicle's painted surfaces, as well as damaging the pump leading to problems of the washer fluid not spraying.

#### ■ Diluting washer fluid

Dilute washer fluid with water as necessary.

Refer to the freezing temperatures listed on the label of the washer fluid bottle.

## 12-volt battery

### Location

The 12-volt battery is located in the right-hand side of luggage compartment.

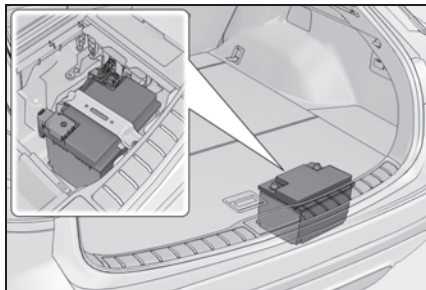

### ■ Before recharging

When recharging, the 12-volt battery produces hydrogen gas which is flammable and explosive. Therefore, observe the following precautions before recharging:

- If recharging with the 12-volt battery installed on the vehicle, be sure to disconnect the ground cable.
- Make sure the power switch on the charger is off when connecting and disconnecting the charger cables to the 12-volt battery.

### ■ After recharging/reconnecting the 12-volt battery

- Unlocking the doors using the smart access system with push-button start may not be possible immediately after reconnecting the 12-volt battery. If this happens, use the wireless remote control or the mechanical key to lock/unlock the doors.
- Start the hybrid system with the power switch in ACC. The hybrid system may not start with the power switch turned off. However, the hybrid system will operate normally from the second attempt.
- The power switch mode is recorded by the vehicle. If the 12-volt battery is disconnected and reconnected, the vehicle

will return the power switch mode to the status it was in before the 12-volt battery was disconnected. Make sure to turn off the power switch before disconnecting the 12-volt battery. Take extra care when connecting the 12-volt battery if the power switch mode prior to the 12-volt battery being disconnected is unknown.

If the system will not start even after multiple attempts at all the methods above, contact your Lexus dealer.

### ⚠ WARNING

#### ■ Chemicals in the 12-volt battery

The 12-volt battery contains poisonous and corrosive sulfuric acid and may produce hydrogen gas which is flammable and explosive. To reduce the risk of death or serious injury, take the following precautions while working on or near the 12-volt battery:

- Do not cause sparks by touching the 12-volt battery terminals with tools.
- Do not smoke or light a match near the 12-volt battery.
- Avoid contact with eyes, skin and clothes.
- Never inhale or swallow electrolyte.
- Wear protective safety glasses when working near the 12-volt battery.
- Keep children away from the 12-volt battery.

#### ■ Where to safely charge the 12-volt battery

Always charge the 12-volt battery in an open area. Do not charge the 12-volt battery in a garage or closed room where there is insufficient ventilation.

#### ■ How to recharge the 12-volt battery

Only perform a slow charge (5 A or less). The 12-volt battery may explode if charged at a quicker rate.

### WARNING

#### ■ Emergency measures regarding electrolyte

- If electrolyte gets in your eyes  
Flush your eyes with clean water for at least 15 minutes and get immediate medical attention. If possible, continue to apply water with a sponge or cloth while traveling to the nearest medical facility.
- If electrolyte gets on your skin  
Wash the affected area thoroughly. If you feel pain or burning, get medical attention immediately.
- If electrolyte gets on your clothes  
It can soak through clothing on to your skin. Immediately take off the clothing and follow the procedure above if necessary.
- If you accidentally swallow electrolyte  
Drink a large quantity of water or milk. Get emergency medical attention immediately.

#### ■ When replacing the 12-volt battery

Use a 12-volt battery designed for this vehicle. Failure to do so may cause gas (hydrogen) to enter the passenger compartment, causing a fire or explosion.

For replacement of the 12-volt battery, contact your Lexus dealer.

#### ■ When handling the 12-volt battery

→P.559

### NOTICE

#### ■ When recharging the 12-volt battery

Never recharge the 12-volt battery while the hybrid system is operating. Also, be sure all accessories are turned off.

### Removing the 12-volt battery cover

- 1 Open the deck board. (→P.433)
- 2 Remove the 12-volt battery cover.

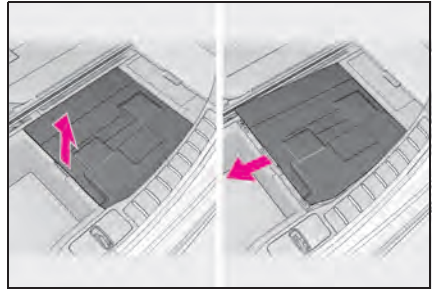

### Exterior

Make sure that the 12-volt battery terminals are not corroded and that there are no loose connections, cracks, or loose clamps.

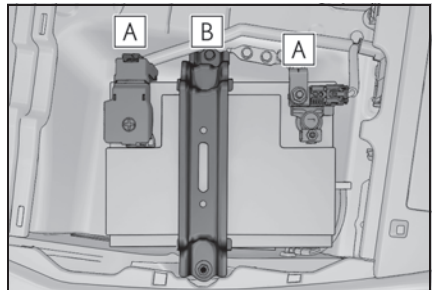

**A** Terminals

**B** Hold-down clamp

## Tires

Replace or rotate tires in accordance with maintenance schedules and treadwear.

### Checking tires

Check if the treadwear indicators are showing on the tires. Also check the tires for uneven wear, such as excessive wear on one side of the tread.

Check the spare tire condition and pressure if not rotated.

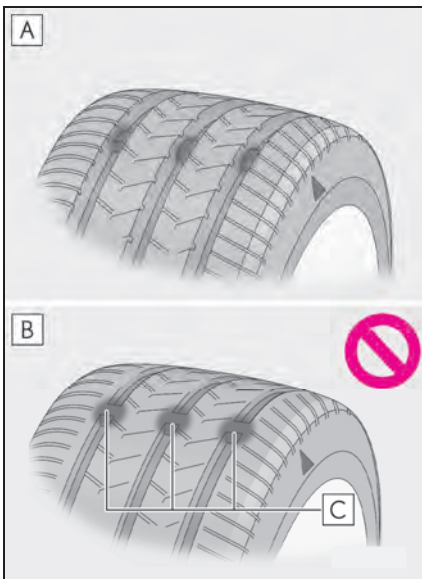

**A** New tread

**B** Worn tread

**C** Treadwear indicator

The location of treadwear indicators is shown by a “TWI” or “ $\Delta$ ” mark, etc., molded into the sidewall of each tire. Replace the tires if the treadwear indicators are showing on a tire.

### When to replace your vehicle's tires

Tires should be replaced if:

- The treadwear indicators are showing on a tire.
- You have tire damage such as cuts, splits, cracks deep enough to expose the fabric, and bulges indicating internal damage.
- A tire goes flat repeatedly or cannot be properly repaired due to the size or location of a cut or other damage.

If you are not sure, consult with your Lexus dealer.

### Tire life

Any tire over 6 years old must be checked by a qualified technician even if it has seldom or never been used or damage is not obvious.

### Maximum load of tire

Check that the number given by dividing the maximum load by 1.10 of the replacement tire is greater than 1/2 of the Gross Axle Weight Ratings (GAWR) of either the front axle or the rear axle, whichever is greater.

For the GAWR, see the Certification Label. For the maximum load of the tire, see the load limit at maximum cold tire inflation pressure mentioned on the sidewall of the tire. (→P.581)

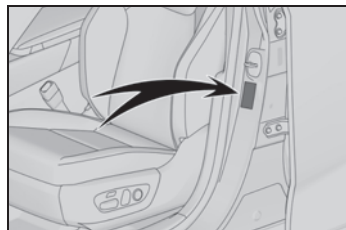

### Tire types

- Summer tires

Summer tires are high-speed performance tires best suited to highway driving under dry conditions. Since summer tires do not have the same traction performance as snow tires, summer tires are inadequate for driving on snow-covered or icy roads. For driving on snow-covered roads or icy

roads, the use of snow tires is recommended. When installing snow tires, be sure to replace all four tires.

● All season tires

All season tires are designed to provide better traction in snow and to be adequate for driving in most winter conditions as well as for use year-round. All season tires, however, do not have adequate traction performance compared with snow tires in heavy or loose snow. Also, all season tires fall short in acceleration and handling performance compared with summer tires in highway driving.

● Snow tires

For driving on snow-covered roads or icy roads, we recommend using snow tires. If you need snow tires, select tires of the same size, construction and load capacity as the originally installed tires. Since your vehicle has radial tires as original equipment, make sure your snow tires also have radial construction. Do not install studded tires without first checking local regulations for possible restrictions. Snow tires should be installed on all wheels.

(→P.402)

■ If the tread on snow tires wears down below 0.16 in. (4 mm)

The effectiveness of the tires as snow tires is lost.



**WARNING**

■ When inspecting or replacing tires

Observe the following precautions to prevent accidents. Failure to do so may cause damage to parts of the drive train as well as dangerous handling characteristics, which may lead to an accident resulting in death or serious injury.

- Do not mix tires of different makes, models or tread patterns. Also, do not mix tires of remarkably different treadwear.
- Do not use tire sizes other than those recommended by Lexus.
- Do not mix differently constructed tires (radial, bias-belted or bias-ply tires).
- Do not mix summer, all season and snow tires.
- Do not use tires that have been used on another vehicle. Do not use tires if you do not know how they were used previously.
- Do not tow if your vehicle has a spare tire installed.



**NOTICE**

■ Driving on rough roads

Take particular care when driving on roads with loose surfaces or potholes. These conditions may cause losses in tire inflation pressure, reducing the cushioning ability of the tires. In addition, driving on rough roads may cause damage to the tires themselves, as well as the vehicle's wheels and body.

■ If tire inflation pressure of each tire becomes low while driving

Do not continue driving, or your tires and/or wheels may be ruined.

**Tire rotation**

Rotate the tires in the order shown.

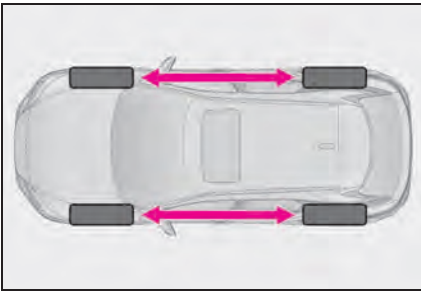

To equalize tire wear and extend tire life, Lexus recommends that tire rotation is carried out at the same interval as tire inspection.

Make sure to perform wheel position registration procedure after rotating the tires. (→P.487)

### Tire pressure warning system

Your vehicle is equipped with a tire pressure warning system that uses tire pressure warning valves and transmitters to detect low tire inflation pressure before serious problems arise.

The tire pressure warning system of this vehicle adopts a 2-type warning system. (→P.520)

- ▶ Multi-information display (vehicles without a head-up display)

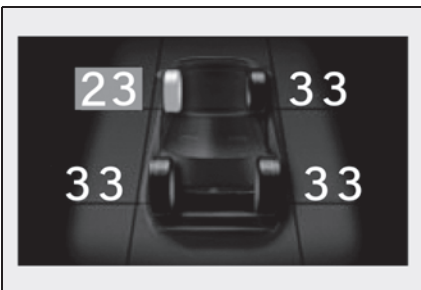

- ▶ Multi-information display (vehicles with a head-up display)

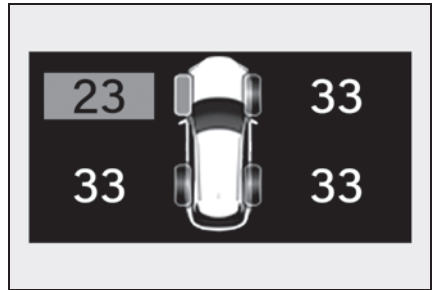

- ▶ Center display

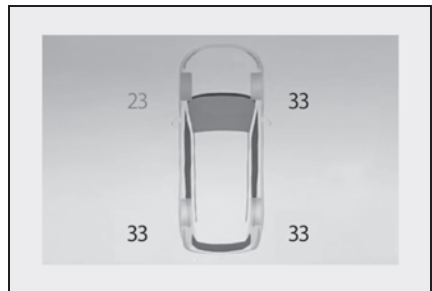

- When “Adjust Pressure” is displayed on the multi-information display (Normal Warning)

A warning with the tire pressure warning light and warning buzzer when there is an unknown level of low tire pressure with the appearance of the tire due to natural air leakage as well as the pressure lowering due to changes in the pressure according to the outside temperature.

- When “Immediately Check tire when Safe” is displayed on the multi-information display (Emergency Warning)

A warning with the tire pressure warning light and warning buzzer when there is a known level of low tire pressure with the appearance of the tire due to pressure suddenly lowering.

However, the system may not be able to

detect sudden tire ruptures (bursting, etc.).

- The tire pressure detected by the tire pressure warning system can be displayed on the center display. (→P.110)

### ■ Routine tire inflation pressure checks

The tire pressure warning system does not replace routine tire inflation pressure checks. Make sure to check tire inflation pressure as part of your routine of daily vehicle checks.

#### ■ Tire inflation pressure

- It may take a few minutes to display the tire inflation pressure after the power switch is turned to ON. It may also take a few minutes to display the tire inflation pressure after inflation pressure has been adjusted.
- Tire inflation pressure changes with temperature. The displayed values may also be different from the values measured using a tire pressure gauge.

#### ■ Situations in which the tire pressure warning system may not operate properly

- In the following cases, the tire pressure warning system may not operate properly.
  - If non-genuine Lexus wheels are used.
  - A tire has been replaced with a tire that is not an OE (Original Equipment) tire.
  - A tire has been replaced with a tire that is not of the specified size.
  - Tire chains, etc. are equipped.
  - If a window tint that affects the radio wave signals is installed.
  - If there is a lot of snow or ice on the vehicle, particularly around the wheels or wheel housings.
  - If the tire inflation pressure is extremely higher than the specified level.
  - If tires not equipped with tire pressure warning valves and transmitters are used.
  - If the ID code on the tire pressure warning valves and transmitters is not registered in the tire pressure warning computer.
- Performance may be affected in the fol-

lowing situations.

- Near a TV tower, electric power plant, gas station, radio station, large display, airport or other facility that generates strong radio waves or electrical noise
- When carrying a portable radio, cellular phone, cordless phone or other wireless communication device
- If tire position information is not correctly displayed due to the radio wave conditions, the display may be corrected by changing the location of the vehicle as the radio wave conditions may change.
- When the vehicle is parked, the time taken for the warning to start or go off could be extended.
- When tire inflation pressure declines rapidly for example when a tire has burst, the warning may not operate.

### Installing tire pressure warning valves and transmitters

When replacing tires or wheels, tire pressure warning valves and transmitters must also be installed.

When new tire pressure warning valves and transmitters are installed, new ID codes must be registered in the tire pressure warning computer. (→P.490)

#### ■ Replacing tires and wheels

If the ID code of the tire pressure warning valve and transmitter is not registered, the tire pressure warning system will not work properly. In this case, after driving for about 20 minutes, the tire pressure warning light blinks for 1 minute and stays on to indicate a system malfunction.

**NOTICE****■ Repairing or replacing tires, wheels, tire pressure warning valves, transmitters and tire valve caps**

- When removing or fitting the wheels, tires or the tire pressure warning valves and transmitters, contact your Lexus dealer as the tire pressure warning valves and transmitters may be damaged if not handled correctly.
- Make sure to install the tire valve caps. If the tire valve caps are not installed, water could enter the tire pressure warning valves, corrode the valve, and cause sticking and air leaks.
- When replacing tire valve caps, do not use tire valve caps other than those specified. The cap may become stuck.

**Registering the position of each wheel****■ When to register the position of each wheel**

It is necessary to register the position of each wheel after performing a tire rotation.

Wheel position registration can be performed by oneself. Wheel position registration is performed by driving forward with moderate left and right turns. However, depending on the driving conditions and driving environment, registration may take some time to complete.

**■ Registering the position of each wheel**

- 1 Park the vehicle in a safe place, turn the power switch off and wait 15 minutes or more.
- 2 Start the hybrid system.

The wheel position registration procedure cannot be performed while the vehicle is moving.

- 3 Select  on the center display.
- 4 Select "Vehicle customize".
- 5 Select "Tire pressure".
- 6 Select "Tire rotation".
- 7 Select "Continue".

A message indicating that wheel position registration is being performed will be displayed on the multi-information display. "---" will be displayed for the tire inflation pressure of each tire and wheel position registration will begin.

- 8 Drive straight (with occasional left and right turns) at approximately 25 mph (40 km/h) or more for approximately 10 to 30 minutes.

When wheel position registration is complete, a message indicating that registration has been completed and the inflation pressure of each tire will be displayed on the multi-information display.

Even if it is not possible to drive continuously at approximately 25 mph (40 km/h) or more, registration can be completed by driving for a long time. However, if registration does not complete after driving for 1 hour or more, park the vehicle in a safe place and leave it with the power switch in ON for approximately 15 minutes or more, and then perform the driving procedure again.

**■ When performing wheel position registration**

- Normally, wheel position registration can be completed within approximately 30 minutes.
  - Wheel position registration is performed while driving at a vehicle speed of approximately 25 mph (40 km/h) or more.
- Wheel position registration procedure**
- If the power switch is turned off while reg-

istering the wheel position, the next time the power switch is turned to ON, the wheel position registration will resume and it will not be necessary to restart the procedure.

- While the position of each wheel is being determined and the inflation pressures are not being displayed, if the inflation pressure of a tire drops, the tire pressure warning light will come on.
- **If the wheel position cannot be registered easily**
- In the following situations, wheel position registration may take longer than usual to be completed or may not be possible.
  - Vehicle is not driven at approximately 25 mph (40 km/h) or more
  - Vehicle is driven on unpaved roads
- If wheel position registration does not complete after driving for 1 hour or more, park the vehicle in a safe place for approximately 15 minutes and then drive the vehicle again.
- If the vehicle is reversed during wheel position registration, all data collected until then will be cleared. Perform driving again.

### Setting the tire pressure

#### ■ When you need to setting the tire pressure

In the following situations, it will be necessary to perform the tire inflation pressure setting procedure of the tire pressure warning system.

- When the specified tire inflation pressure has changed, such as due to carried load, etc.
- When the tire inflation pressure is changed such as when the tire size is changed.

If the tire inflation pressure has been adjusted to the specified level, perform

the tire inflation setting procedure by selecting specified inflation pressure on the center display. (→P.488)

When the tire inflation pressure is to be other than specified, such as when tires other than the specified size are used, etc., set the tire inflation pressure using the current pressure. Make sure to adjust the tire inflation pressure of each tire to the appropriate level before performing tire pressure setting. The tire pressure warning system operates based on this tire inflation pressure. (→P.489)

#### ■ Setting by selecting a specified tire inflation pressure

1 Start the hybrid system.

The tire inflation pressure cannot be set while the vehicle is moving.

2 Select  on the center display.

3 Select "Vehicle customize".

4 Select "Tire pressure".

5 Select "Set indicated air pressure" and then select the desired front and rear tire pressures.

6 Select "OK".

The tire pressure warning light will slowly blink 3 times.

After setting the tire inflation pressure, a message indicating that setting has been completed will be displayed on the

multi-information display.

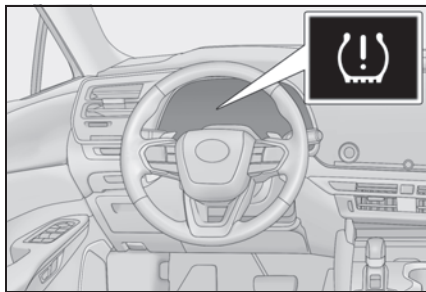

### ■ Setting using the current tire inflation pressure

- 1 Adjust the tire inflation pressure of each tire to the appropriate level.

Make sure to adjust the tire inflation pressure with the tires cold.

- 2 Start the hybrid system.

The tire inflation pressure cannot be set while the vehicle is moving.

- 3 Select  on the center display.
- 4 Select "Vehicle customize".
- 5 Select "Tire pressure".
- 6 Select "Set current air pressure".
- 7 Select "Continue".

The tire pressure warning light will slowly blink 3 times and a message indicating that tire inflation pressure is being set will be displayed on the multi-information display.

After setting the tire inflation pressure, a message indicating that setting has been completed will be displayed on the multi-information display.

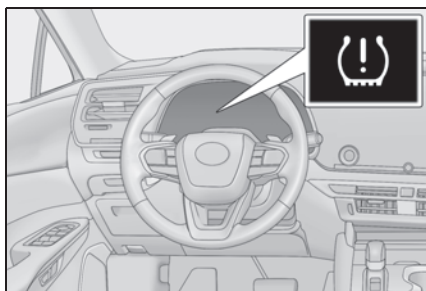

### ■ Warning performance of the tire pressure warning system (Setting using the current tire inflation pressure)

- When performing the tire pressure setting using the current tire inflation pressure, the warning timing of the tire pressure warning system will vary according to the conditions under which tire pressure setting was performed. Therefore, a warning may be output even if the tire inflation pressure drops slightly or if the tire inflation pressure increases above that when the tire inflation pressure was set.

- Make sure to perform the tire pressure setting procedure after adjusting the tire inflation pressure. Also, make sure the tires are cold before performing the tire pressure setting procedure or adjusting the tire inflation pressure.

### ■ Tire inflation pressure setting procedure (Setting using the current tire inflation pressure)

- If the power switch is turned off while setting the tire inflation pressure, the next time the power switch is turned to ON, the setting procedure will resume and it will not be necessary to restart the procedure.
- If the tire inflation pressure setting procedure is started unnecessarily, adjust the tire inflation pressure to the specified level with the tires cold and then perform setting by selecting a specified tire inflation pressure, or perform the tire inflation pressure setting procedure with the current tire inflation pressure.

### ■ If the tire inflation pressure cannot be set easily

- Normally, it takes approximately 3 minutes to complete the setting procedure to the current tire inflation pressure.
- If the tire pressure warning light does not blink 3 times when starting the tire inflation pressure setting procedure, the procedure may not have started. Perform the procedure again from the beginning.
- If tire inflation pressure setting procedure cannot be completed after performing

the above procedure, contact your Lexus dealer.



## WARNING

### ■ When setting using the current tire inflation pressure

Make sure to adjust the tire inflation pressure of each tire to the appropriate level before performing tire pressure setting. Otherwise, the tire pressure warning light may not illuminate even if the tire inflation pressure drops or may illuminate even though the tire inflation pressure is normal.

## Registering ID codes

### ■ When to register ID codes

The tire pressure warning valve and transmitter is equipped with a unique ID code. When new tire pressure warning valves and transmitters are installed, new ID codes must be registered in the tire pressure warning computer.

### ■ How to registration ID code

Before performing ID code registration, make sure that no wheels with tire pressure warning valve and transmitters installed are near the vehicle.

- 1 Park the vehicle in a safe place, turn the power switch off and wait 15 minutes or more.
- 2 Start the hybrid system.

The ID code registration procedure cannot be performed while the vehicle is moving.

- 3 Select  on the center display.
- 4 Select "Vehicle customize".
- 5 Select "Tire pressure".

- 6 Check if the desired wheel set ("Set 1" or "Set 2") is displayed.

ID codes will be registered to the displayed wheel set.

To change the wheel set to be registered, select the displayed set, and then select the wheel set you wish to register.

If ID codes have already been registered for that wheel set, the tire pressure warning light will slowly blink 3 times, and a message indicating that change is occurring will be displayed on the multi-information display.



- 7 Select "New tire registration".

- 8 Select "Continue".

The tire pressure warning light will slowly blink 3 times and a message indicating that ID code registration is being performed will be displayed on the multi-information display. Wheel set changing will be canceled and registration will begin.

When registration is being performed, the tire pressure warning light will blink for approximately 1 minute then illuminate and "---" will be displayed for the inflation pressure of each tire on the multi-information display.



- 9 Drive straight (with occasional left and right turns) at approximately 25 mph (40 km/h) or more for approximately 10 to 30 minutes.

When registration is complete, the tire pressure warning light will turn off and a message indicating that registration has been completed will be displayed on the multi-information display.

Registration may take longer than normal to complete if the vehicle speed cannot be maintained at approximately 25 mph (40 km/h) or more. If registration cannot be completed after driving for 1 hour or more, perform the registration procedure again from the beginning.

- 10 If the tire inflation pressure of the wheel set installed differs from that of the previous set, it will be necessary to perform the tire inflation pressure setting procedure of the tire pressure warning system. (→P.488)

If the specified tire inflation pressure is the same, it will not be necessary to perform the tire inflation pressure setting procedure.

#### ■ When registering ID codes

- Normally, wheel position registration can be completed within approximately 30 minutes.
- ID code registration is performed while driving at a vehicle speed of approximately 25 mph (40 km/h) or more.
- ID codes can be registered by yourself, but depending on the driving conditions and driving environment, registration may take some time to complete.
- When using a wheel set which all of the ID codes have already been registered, the wheel set can be changed in a short amount of time. (→P.491)

#### ■ If ID codes are not registered easily

- In the following situations, ID code registration may take longer than usual to be

completed or may not be possible.

- When the vehicle has not been parked for approximately 15 minutes or more before being driven
  - Vehicle is not driven at approximately 25 mph (40 km/h) or more
  - Vehicle is driven on unpaved roads
  - Vehicle is driven near other vehicles and system cannot recognize tire pressure warning valve and transmitters of your vehicle over those of other vehicles
  - Wheel with tire pressure warning valve and transmitter installed is inside or near the vehicle
- If the vehicle is reversed during registration, all data collected until then will be cleared. Perform driving again.
  - If registration does not complete after driving for 1 hour or more, perform the ID code registration procedure again from the beginning.
  - If the tire pressure warning light does not blink 3 times when starting ID code registration procedure, the procedure may not have started. Perform the procedure again from the beginning.
  - If the ID codes cannot be registered even when performing the above procedure, contact your Lexus dealer.

### Canceling ID code registration

To cancel ID code registration after it has been started, select “New tire registration” again on the center display.

If ID code registration has been canceled, the tire pressure warning light will turn off.

If the warning light does not turn off, ID code registration may not have been cancelled correctly. To cancel registration, select “New tire registration” again on the center display.

### Selecting wheel set

Your vehicle is equipped with a tire pressure warning system with a func-

tion to register two sets of ID codes. This allows for registration of a second wheel set, for example a winter set.

- The wheel set can be changed only if a second wheel set has been registered to the system. If a second wheel set has not been registered, “Set 2 (Unregistered)” will be displayed and it will not be possible to change to the selected wheel set.

ID codes can be registered by yourself. (→P.490)

- Only a change between both registered wheel set is possible, mixing between these wheel sets is not supported.
- While registering ID codes, it may not be possible to change between wheel sets normally. Cancel registration before changing between wheel sets.

### ■ Changing ID codes between different wheel sets

- 1 Install the desired wheel set.
- 2 Select  on the center display.
- 3 Select “Vehicle customize”.
- 4 Select “Tire pressure”.
- 5 Select the wheel set (“Set 1” or “Set 2”) displayed for the set selection setting.
- 6 Select the wheel set you wish to register, and then select “OK”.

The tire pressure warning light will slowly blink 3 times, a message indicating that change is occurring will be displayed, and the wheel set change will begin.

Wheel set change will begin and the tire pressure warning light will blink for 1 min-

ute and then illuminate. Also, while the change is being performed, “---” will be displayed for the tire inflation pressure of each tire on the multi-information display.

After approximately 2 minutes, the wheel set change will complete, the tire pressure warning light will turn off, and a completion message will be displayed on the multi-information display.

If changing does not complete after approximately 4 minutes, a message indicating that the change could not be completed will be displayed.

Check which wheel set is installed and perform the change procedure again from the beginning.

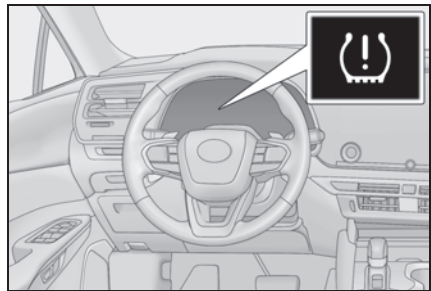

- 7 If the specified tire inflation pressure of the wheel set installed differs from that of the previous set, it will be necessary to perform the tire inflation pressure setting procedure of the tire pressure warning system. (→P.488)

If the specified tire inflation pressure is the same, it will not be necessary to perform the tire inflation pressure setting procedure.

- 8 Register the position of each wheel. (→P.487)

## Tire inflation pressure

### Checking the specified tire inflation pressure

The recommended cold tire inflation pressure and tire size are displayed on the tire and loading information label. (→P.576)



TIRE AND LOADING INFORMATION			RENSEIGNEMENTS SUR LES PNEUS ET LE CHARGEMENT		
SEATING CAPACITY: TOTAL X FRONT Y REAR Z The combined weight of occupants and cargo should never exceed 1111 kg or 2444 lb.			NOMBRE DE PLACES : TOTAL X AVANT Y ARRIÈRE Z Le poids total des occupants et du chargement ne doit jamais dépasser 1111 kg ou 2444 lb.		
TIRE	SIZE	COLD TIRE PRESSURE	PNEU	DIMENSIONS	PRESSION DES PNEUS À FROID
FRONT	XXXXXXRXX	XXXXPa, XXPSI	AVANT	XXXXXXRXX	XXXXPa, XXPSI
REAR	XXXXXXRXX	XXXXPa, XXPSI	ARRIÈRE	XXXXXXRXX	XXXXPa, XXPSI
SPARE	TXXXXXXRXX	XXXXPa, XXPSI	DE SECOURS	TXXXXXXRXX	XXXXPa, XXPSI
SEE OWNERS MANUAL FOR ADDITIONAL INFORMATION			VOIR LE MANUEL DE L'USAGER POUR PLUS DE RENSEIGNEMENTS		

### Inspection and adjustment procedure

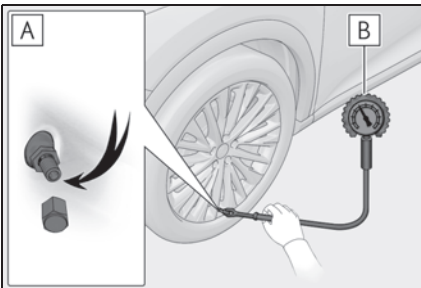

**A** Tire valve

**B** Tire pressure gauge

- 1 Remove the tire valve cap.
- 2 Press the tip of the tire pressure gauge onto the tire valve.
- 3 Read the pressure using the gauge gradations.
- 4 If the tire inflation pressure is not at the recommended level, adjust the pressure.  
If you add too much air, press the center of the valve to deflate.
- 5 After completing the tire inflation pressure measurement and adjustment, apply soapy water to the valve and check for leakage.
- 6 Put the tire valve cap back on.

#### ■ Tire inflation pressure check interval

You should check tire inflation pressure every two weeks, or at least once a month. Do not forget to check the spare.

#### ■ Effects of incorrect tire inflation pressure

Driving with incorrect tire inflation pressure may result in the following:

- Reduced fuel economy
- Reduced driving comfort and poor handling
- Reduced tire life due to wear
- Reduced safety
- Damage to the drive train

If a tire needs frequent inflating, have it checked by your Lexus dealer.

#### ■ Instructions for checking tire inflation pressure

When checking tire inflation pressure, observe the following:

- Check only when the tires are cold.  
If your vehicle has been parked for at least 3 hours or has not been driven for more than 1 mile or 1.5 km, you will get an accurate cold tire inflation pressure read-

ing.

- Always use a tire pressure gauge. It is difficult to judge if a tire is properly inflated based only on its appearance.
- It is normal for the tire inflation pressure to be higher after driving as heat is generated in the tire. Do not reduce tire inflation pressure after driving.
- Never exceed the vehicle capacity weight. Passengers and luggage weight should be placed so that the vehicle is balanced.



### WARNING

#### ■ Proper inflation is critical to save tire performance

Keep your tires properly inflated. If the tires are not properly inflated, the following conditions may occur which could lead to an accident resulting in death or serious injury:

- Excessive wear
- Uneven wear
- Poor handling
- Possibility of blowouts resulting from overheated tires
- Air leaking from between tire and wheel
- Wheel deformation and/or tire damage
- Greater possibility of tire damage while driving (due to road hazards, expansion joints, sharp edges in the road, etc.)



### NOTICE

#### ■ When inspecting and adjusting tire inflation pressure

Be sure to put the tire valve caps back on. If a valve cap is not installed, dirt or moisture may get into the valve and cause an air leak, resulting in decreased tire inflation pressure.

## Wheels

If a wheel is bent, cracked or heavily corroded, it should be replaced. Otherwise, the tire may separate from the wheel or cause a loss of handling control.

### Wheel selection

When replacing wheels, care should be taken to ensure that they are equivalent to those removed in load capacity, diameter, rim width and inset\*.

Replacement wheels are available at your Lexus dealer.

\*: Conventionally referred to as offset.

Lexus does not recommend using the following:

- Wheels of different sizes or types
- Used wheels
- Bent wheels that have been straightened

### When replacing wheels

The wheels of your vehicle are equipped with tire pressure warning valves and transmitters that allow the tire pressure warning system to provide advance warning in the event of a loss in tire inflation pressure. Whenever wheels are replaced, tire pressure warning valves and transmitters must be installed. (→P.486)



## WARNING

### When replacing wheels

- Do not use wheels that are a different size from those recommended in the Owner's Manual, as this may result in a loss of handling control.
- Never use an inner tube in a leaking wheel which is designed for a tubeless tire. Doing so may result in an accident, causing death or serious injury.
- Use the correct wheel bolts for the wheels to be installed. For details, contact your Lexus dealer.

### Wheel bolts

Observe the following precautions to reduce the risk of death or serious injury:

- Do not over tighten.
- Never use oil or grease on the wheel bolts. Oil and grease may cause the wheel bolts to be excessively tightened, leading to bolt or disc wheel damage. In addition, the oil or grease can cause the wheel bolts to loosen and the wheel may fall off, causing a serious accident. Remove any oil or grease from the wheel bolts.
- If there are any cracks or deformations in the wheel bolts, or if the surface treatment becomes worn, have the wheel bolts replaced at your Lexus dealer. Failure to follow these precautions could cause the wheel bolts to loosen and the tire to fall off, resulting in death or serious injury.

### Use of defective wheels prohibited

Do not use cracked or deformed wheels. Doing so could cause the tire to leak air during driving, possibly causing an accident.



## NOTICE

- **Replacing tire pressure warning valves and transmitters**
- Because tire repair or replacement may affect the tire pressure warning valves and transmitters, make sure to have tires serviced by your Lexus dealer or other qualified service shop. In addition, make sure to purchase your tire pressure warning valves and transmitters at your Lexus dealer.
- Ensure that only genuine Lexus wheels are used on your vehicle. Tire pressure warning valves and transmitters may not work properly with non-genuine wheels.

### Aluminum wheel precautions

- Use only Lexus wheel bolts and wrenches designed for use with your aluminum wheels.
- When rotating, repairing or changing your tires, check that the wheel bolts are still tight after driving 621 miles (1000 km).
- Be careful not to damage the aluminum wheels when using tire chains.
- Use only Lexus genuine balance weights or equivalent and a plastic or rubber hammer when balancing your wheels.

### Air conditioning filter

The air conditioning filter must be changed regularly to maintain air conditioning efficiency.

### Removing the air conditioning filter

- 1 Turn the power switch off.
- 2 Open the glove box. Slide off the damper.

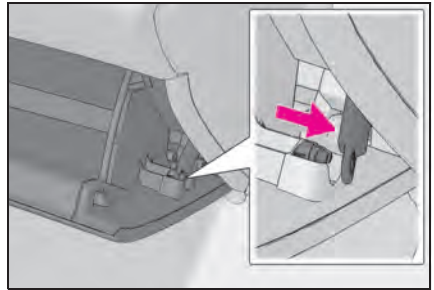

- 3 Push in the glove box on the vehicle's outer side to disconnect the claws. Then pull out the glove box and disconnect the lower claws.

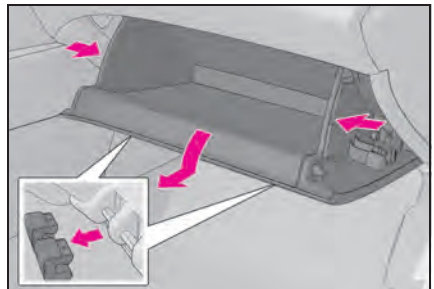

- 4 Unlock the filter cover (A), pull the filter cover out of the claws (B), and remove the filter cover.

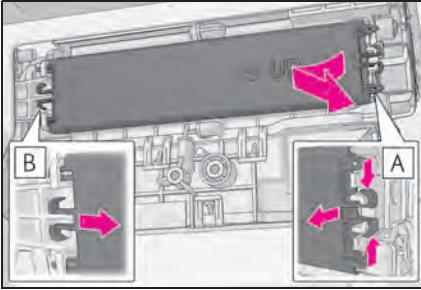

- 5 Remove the filter case.

There may be foreign objects on top of the air conditioning filter.

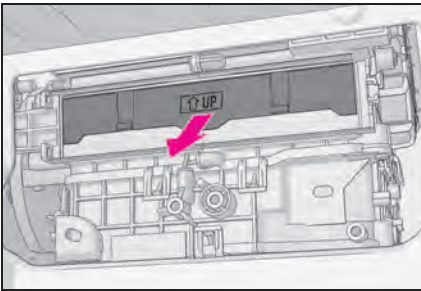

- 6 Remove the air conditioning filter from the filter case and replace it with a new one.

The "↑ UP" marks shown on the filter and the filter case should be pointing up.

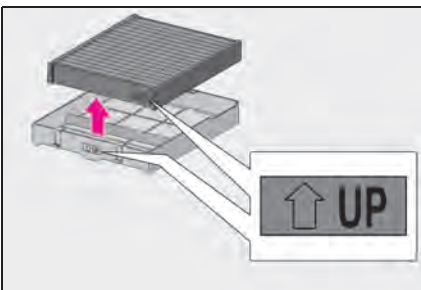

#### ■ Checking interval

Inspect and replace the air conditioning fil-

ter according to the maintenance schedule. In dusty areas or areas with heavy traffic flow, early replacement may be required. (For scheduled maintenance information, please refer to the "Owner's Manual Supplement" or "Scheduled Maintenance".)

#### ■ If air flow from the vents decreases dramatically

The filter may be clogged. Check the filter and replace if necessary.

#### ■ Air conditioning filter with deodorizing function

When fragrances are placed in your vehicle, the deodorizing effect may become significantly weakened in a short period. When an air conditioning odor comes out continuously, replace the air conditioning filter.

#### ⚠ NOTICE

##### ■ When using the air conditioning system

Make sure that a filter is always installed. Using the air conditioning system without a filter may cause damage to the system.

##### ■ To prevent damage to the filter cover

When moving the filter cover in the direction of arrow to release the fitting, pay attention not to apply excessive force to the claws. Otherwise, the claws may be damaged.

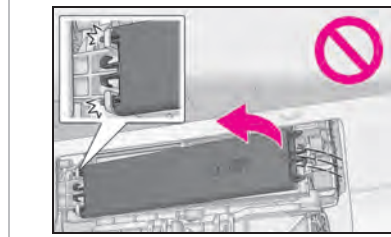

## Cleaning the hybrid battery (traction battery) air intake vents

To prevent the fuel economy from being affected, visually inspect the hybrid battery (traction battery) air intake vents periodically for dust and clogs.

If it is dusty or clogged or if “Maintenance Required for Traction Battery Cooling Parts See Owner’s Manual” is displayed on the multi-information display, clean the air intake vent using the following procedures:

### ■ Scheduled maintenance of the air intake vent is necessary when

In some situations such as when the vehicle is used frequently or in heavy traffic or dusty areas, the air intake vent may need to be cleaned more regularly. For details, refer to the “Warranty and Service Guide”, “Owner’s Manual Supplement” or “Scheduled Maintenance”.

### ■ Cleaning the air intake vent

Improper handling of the air intake vent cover and filter may result in damage to them. If you have any concerns about cleaning the filter, contact your Lexus dealer.



#### NOTICE

- If “Maintenance Required for Traction Battery Cooling Parts See Owner’s Manual” is displayed on the multi-information display

Clean the air intake vent immediately.

If the vehicle is continuously driven with the warning message displayed, it may cause a malfunction or output restriction of the hybrid battery (traction battery).

## Cleaning procedure

- 1 Turn the power switch off.
- 2 Using a Phillips screwdriver, remove the clip.

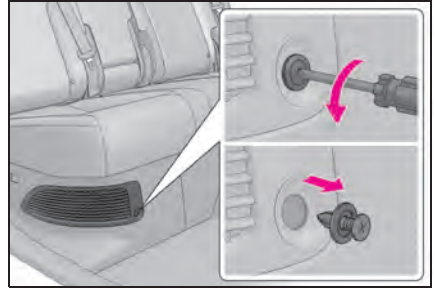

- 3 Remove the air intake vent cover.

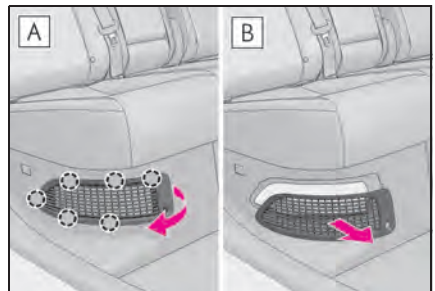

- A Pull the cover as shown in the illustration to disengage the 6 claws, starting from the claw in the upper right corner.
  - B Pull the cover toward the front of the vehicle to remove it.
- 4 Remove the filter from the air intake vent cover.

If dust has accumulated on the air intake vent cover, remove the dust with a vacuum

cleaner, etc.

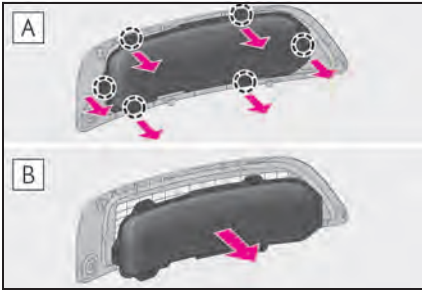

**A** Disengage the 6 claws as shown in the illustration.

**B** Remove the filter from the cover.

**5** Remove the dust and sand from the filter.

Using a vacuum cleaner, etc., absorb dust and sand from the filter by profiling the nozzle lightly along the fold.

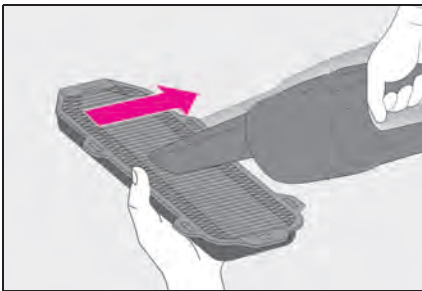

**6** Hold the filter to the light and check if it is not clogged.

If the dust or sand cannot be removed completely, contact your Lexus dealer.

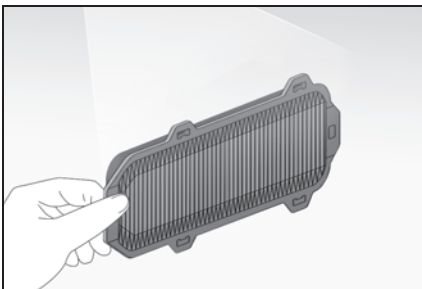

**7** Reinstall the filter to the cover.

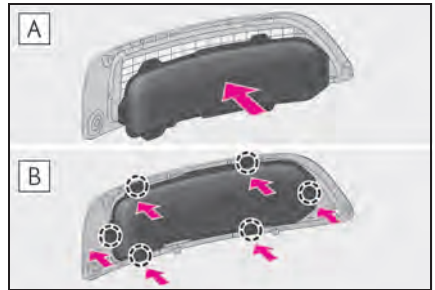

**A** Install the filter to the cover.

**B** Engage the filter to the 6 claws as shown in the illustration.

Make sure that the filter is not crooked or deformed when installing it.

**8** Install the air intake vent cover.

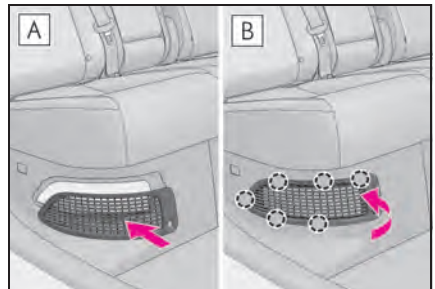

**A** Insert the tab of the cover as shown in the illustration.

**B** Push the cover to engage the 6 claws.

**9** Install the clip.

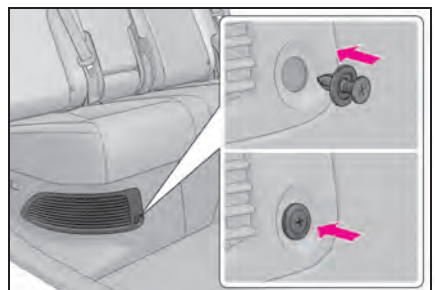

► If “Maintenance Required for Traction Battery Cooling Parts See Owner’s Manual” was displayed on the multi-information display

**10** Start the hybrid system and check that the warning message is no longer displayed.

It may be necessary to drive the vehicle for approximately 20 minutes before the warning message is displayed again then disappears.

If the warning message does not disappear after some time, have the vehicle inspected by your Lexus dealer.

■ **If the dust or sand on the filter cannot be removed**

It is recommended to use a vacuum cleaner with plastic brushes.



**WARNING**

■ **When cleaning the air intake vent**

- Do not use water or other liquids to clean the air intake vent. If water is applied to the hybrid battery (traction battery) or other components, a malfunction or fire may occur.
- Before cleaning the air intake vents, make sure to turn the power switch off to stop the hybrid system.
- Do not put a hand or leg in the air intake vent. If it is caught in a cooling fan, or if it touches a high voltage part that results in an electric shock, death or serious injuries may result.



**NOTICE**

■ **When cleaning the air intake vent**

Do not use an air blow gun, etc. Dust may be blown out, possibly causing a malfunction or output restriction of the hybrid battery (traction battery).

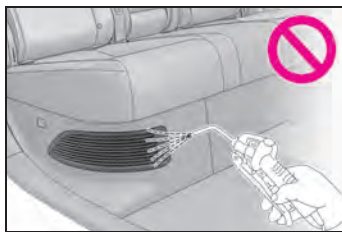

■ **To prevent damage to the vehicle**

Observe the following precautions:

- Do not allow liquid or foreign matter to enter the air intake vent.
- Make sure to reinstall the filter and cover to their original positions after cleaning.
- Do not install anything to the air intake vent other than the exclusive filter for this vehicle or use the vehicle without the filter installed.

■ **To prevent damage to the filter**

Observe the following precautions. If the filter is damaged, have it replaced with a new filter by your Lexus dealer.

- Do not use an air blow gun, etc.
- Do not press hard a vacuum cleaner, etc. against the filter.
- Do not use a hard brush, such as a metal brush.
- Do not break the fold of the filter.

## Electronic key battery

Replace the battery with a new one if it is depleted.

As the key may be damaged if the following procedure is not performed properly, it is recommended that key battery replacement be performed by your Lexus dealer.

### ■ If the electronic key battery is depleted

The following symptoms may occur:

- The smart access system with push-button start and wireless remote control will not function properly.
- The operational range will be reduced.

### You will need the following items:

- Flathead screwdriver
- Small flathead screwdriver
- Lithium battery CR2032

### ■ Use a CR2032 lithium battery

- Batteries can be purchased at your Lexus dealer, local electrical appliance shops or camera stores.
- Replace only with the same or equivalent type recommended by the manufacturer.
- Dispose of used batteries according to the local laws.

## Replacing the battery

- 1 Take out the mechanical key.

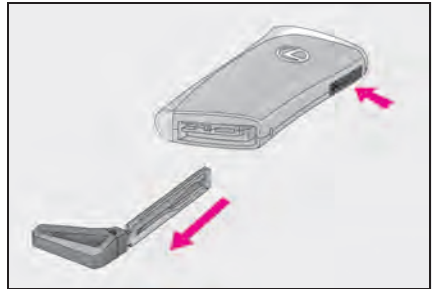

- 2 Remove the cover.

To prevent damage to the key, cover the tip of the flathead screwdriver with a tape.

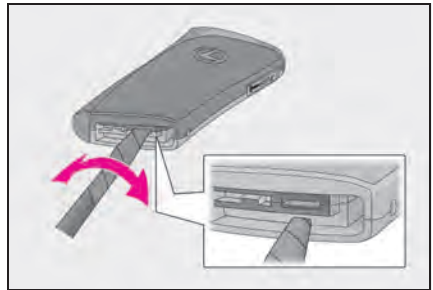

- 3 Remove the depleted battery.

Insert a new battery with the "+" terminal facing up.

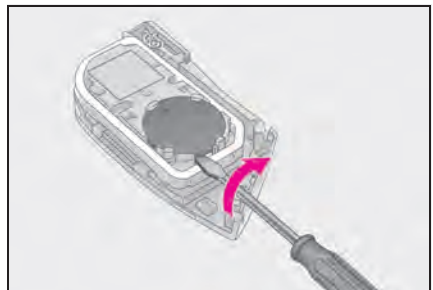

**WARNING****■ Battery precautions**

Observe the following precautions. Failure to do so may result in death or serious injury.

- Do not swallow the battery. Doing so may cause chemical burns.
  - A coin battery or button battery is used in the electronic key. If a battery is swallowed, it may cause severe chemical burns in as little as 2 hours and may result in death or serious injury.
  - Keep away new and removed batteries from children.
  - If the cover cannot be firmly closed, stop using the electronic key and stow the key in the place where children cannot reach, and then contact your Lexus dealer.
  - If you accidentally swallow a battery or put a battery into a part of your body, get emergency medical attention immediately.
- To prevent battery explosion or leakage of flammable liquid or gas**
- Replace the battery with a new battery of the same type. If a wrong type of battery is used, it may explode.
  - Do not expose batteries to extremely low pressure due to high altitude or extremely high temperatures.
  - Do not burn, break or cut a battery.

**■ For normal operation after replacing the battery**

Observe the following precautions to prevent accidents:

- Always work with dry hands. Moisture may cause the battery to rust.
- Do not touch or move any other component inside the remote control.
- Do not bend either of the battery terminals.

**NOTICE****■ When replacing the battery**

Use a flathead screwdriver of appropriate size. Applying excessive force may deform or damage the cover.

## Checking and replacing fuses

If any of the electrical components do not operate, a fuse may have blown. If this happens, check and replace the fuses as necessary.

### Checking and replacing fuses

1 Turn the power switch off.

2 Open the fuse box cover.

▶ Engine compartment

Push in the claw and remove the lid.

• Type A

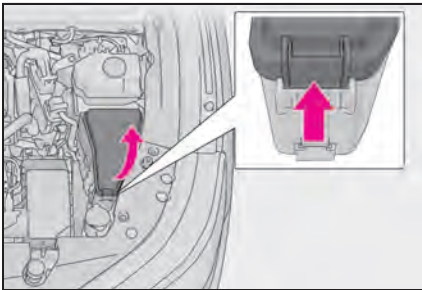

• Type B

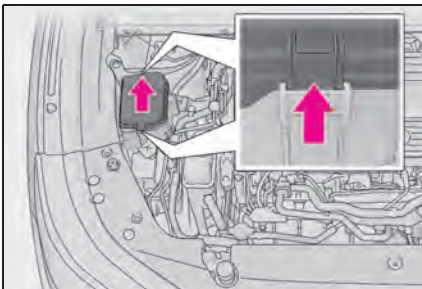

▶ Driver's side instrument panel

Remove the lid.

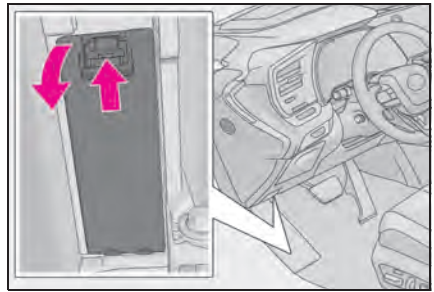

▶ Luggage compartment

Secure the deck board using the hook.  
(→P.433)

Remove the side board and cover.

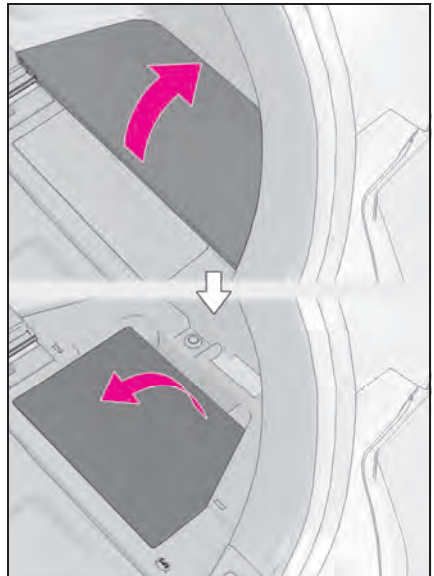

Push in the claw and remove the lid.



- 3** Remove the fuse with the pullout tool.  
Only some fuses can be removed using the pullout tool.

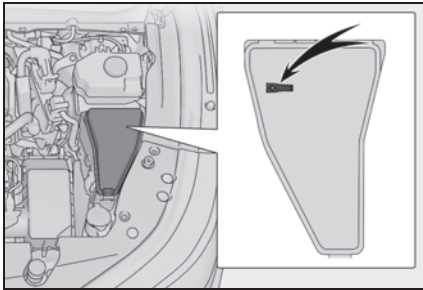

- 4** Check if the fuse is blown.

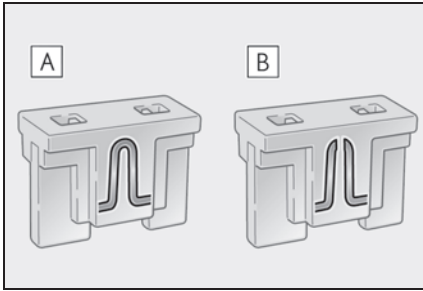

**A** Normal fuse

**B** Blown fuse

Replace the blown fuse with a new fuse of an appropriate amperage rating. The amperage rating can be found on the fuse box lid.

Many types of fuse are used on this vehicle. This illustration shows a common type of fuse used on this vehicle.

#### ■ After a fuse is replaced

- If the lights do not turn on even after the fuse has been replaced, a bulb may need replacement. (→P.506)
- If the replaced fuse blows again, have the vehicle inspected by your Lexus dealer.

#### ■ If there is an overload in a circuit

The fuses are designed to blow, protecting

the wiring harness from damage.

#### ■ When replacing light bulbs

Lexus recommends that you use genuine Lexus products designed for this vehicle. Because certain bulbs are connected to circuits designed to prevent overload, non-genuine parts or parts not designed for this vehicle may be unusable.

### ⚠ WARNING

#### ■ To prevent system breakdowns and vehicle fire

Observe the following precautions. Failure to do so may cause damage to the vehicle, and possibly a fire or injury.

- Never use a fuse of a higher amperage rating than that indicated, or use any other object in place of a fuse.
- Always use a genuine Lexus fuse or equivalent. Never replace a fuse with a wire, even as a temporary fix.
- Do not modify the fuses or fuse boxes.

#### ■ Fuse box near the power control unit

Never check or replace the fuses as there are high voltage parts and wiring near the fuse box.

Doing so may cause electric shock, resulting in death or serious injury.

### ⚠ NOTICE

#### ■ Before replacing fuses

Have the cause of electrical overload determined and repaired by your Lexus dealer as soon as possible.

## Headlight aim

### Vertical movement adjusting bolts

- ▶ Vehicles without single-beam headlights

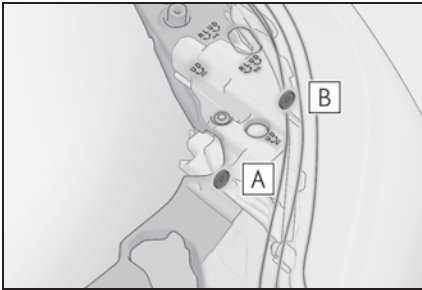

- A** Adjustment bolt A
- B** Adjustment bolt B

- ▶ Vehicles with single-beam headlights

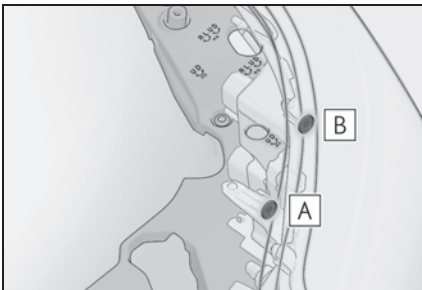

- A** Adjustment bolt A
- B** Adjustment bolt B

### Before checking the headlight aim

- 1 Make sure the vehicle has a full tank of gasoline and the area around the headlight is not deformed.

- 2 Park the vehicle on level ground.
- 3 Sit in the driver's seat.
- 4 Bounce the vehicle several times.

### Adjusting the headlight aim

- 1 Using a phillips-head screwdriver, turn bolt A in either direction.

Remember the turning direction and the number of turns.

- ▶ Vehicles without single-beam headlights



- ▶ Vehicles with single-beam headlights

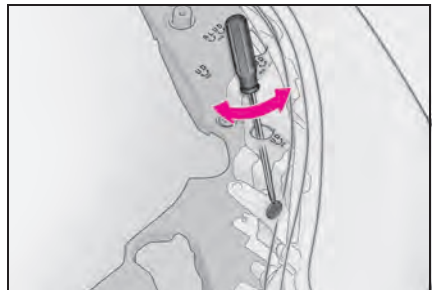

- 2 Turn bolt B the same number of turns and in the same direction as step 1.

If the headlight cannot be adjusted using this procedure, take the vehicle to your Lexus dealer to adjust the headlight aim.

- ▶ Vehicles without single-beam head-lights

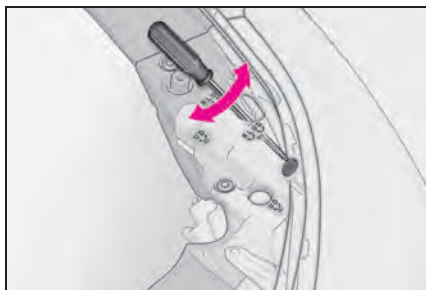

- ▶ Vehicles with single-beam head-lights

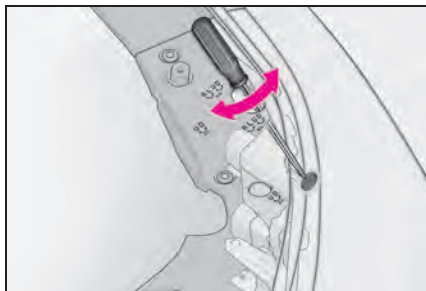

## Light bulbs

You may replace the following bulbs by yourself. The difficulty level of replacement varies depending on the bulb. If necessary bulb replacement seems difficult to perform, contact your Lexus dealer.

For more information about replacing other light bulbs, contact your Lexus dealer.

## Preparing for light bulb replacement

Check the wattage of the light bulb to be replaced. (→P.578)

## Canceling the power back door system

→P.138

## Bulb locations

### ■ Front

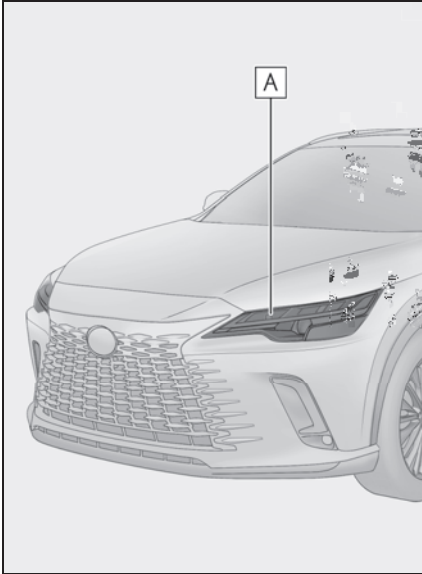

**A** Front turn signal light (bulb type)

### ■ Replacing the following bulbs

If any of the lights listed below has burnt out, have it replaced by your Lexus dealer.

- Headlight
- Parking lights and daytime running lights
- Front turn signal lights (LED type)
- Front side marker lights
- Front fog lights
- Cornering lights (if equipped)
- Side turn signal lights
- Stop/tail lights
- Back-up lights
- Rear turn signal light

- Rear side marker lights
- High mounted stoplight
- License plate lights
- Outer foot lights

### ■ LED Lights

The lights other than the front turn signal lights (bulb type) each consist of a number of LEDs. If any of the LEDs burn out, take your vehicle to your Lexus dealer to have the light replaced.

### ■ Condensation build-up on the inside of the lens

Temporary condensation build-up on the inside of the headlight lens does not indicate a malfunction. Contact your Lexus dealer for more information in the following situations:

- Large drops of water have built up on the inside of the lens.
- Water has built up inside the headlight.

### ■ When replacing light bulbs

→P.504

## Replacing light bulbs

### ■ Front turn signal lights (bulb type)

- 1 Turn the bulb base counterclockwise and remove it.

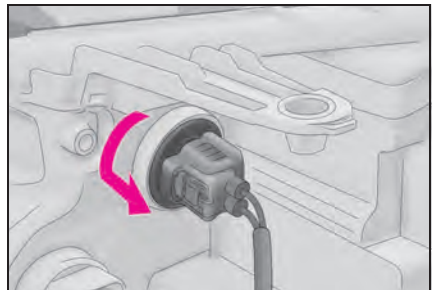

## 2 Remove the light bulb.

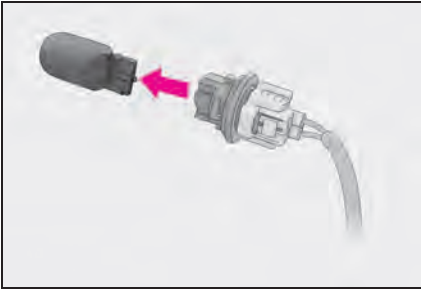

## 3 Install a new light bulb and then install the bulb base to the light unit by inserting it and turning it clockwise.

After installing the bulb base, wiggle it lightly to make sure it is securely installed and turn the lights on to visually check that there is no light leaking from between the bulb base and light unit.

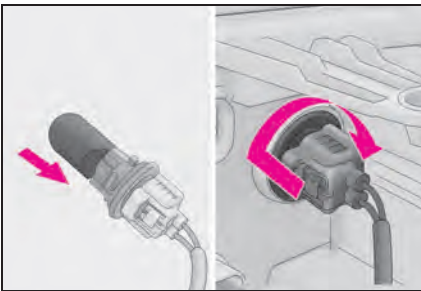

### WARNING

#### ■ To prevent injury

Before performing any light bulb replacement procedure, be sure to turn the power switch off. Failure to do so may result in burns from hot components or a part of your body may get caught on an operating component, possibly causing serious injury.

#### ■ Replacing light bulbs

- Turn off the lights. Do not attempt to replace the bulb immediately after turning off the lights. The bulbs become very hot and may cause burns.
  - Do not touch the glass portion of the light bulb with bare hands. When it is unavoidable to hold the glass portion, use and hold with a clean dry cloth to avoid getting moisture and oils on the bulb. Also, if the bulb is scratched or dropped, it may blow out or crack.
  - Fully install light bulbs and any parts used to secure them. Failure to do so may result in heat damage, fire, or water entering the headlight unit. This may damage the headlights or cause condensation to build up on the lens.
  - Do not attempt to repair or disassemble the light bulbs, connectors, electric circuits or component parts. Doing so may result in death or serious injury due to electric shock.
- #### ■ To prevent damage or fire
- Make sure bulbs are fully seated and locked.
  - Check the wattage of the bulb before installing to prevent heat damage.

## When trouble arises

## 7

## 7-1. Essential information

- Emergency flashers..... **510**
- If your vehicle has to be stopped in an emergency..... **510**
- If the vehicle is submerged or water on the road is rising .... **511**

## 7-2. Steps to take in an emergency

- If your vehicle needs to be towed ..... **513**
- If you think something is wrong ..... **514**
- If a warning light turns on or a warning buzzer sounds ..... **516**
- If a warning message is displayed ..... **526**
- If you have a flat tire..... **539**
- If the hybrid system will not start ..... **547**
- If you lose your keys ..... **548**
- If the electronic key does not operate properly ..... **549**
- If a door cannot be opened using the door opener switch..... **551**
- If the 12-volt battery is discharged ..... **553**
- If your vehicle overheats ..... **560**
- If the vehicle becomes stuck ..... **565**

## Emergency flashers

The emergency flashers are used to warn other drivers when the vehicle has to be stopped on the road due to a breakdown, etc.

### Operating instructions

Press the switch.

All the turn signal lights will flash. To turn them off, press the switch once again.

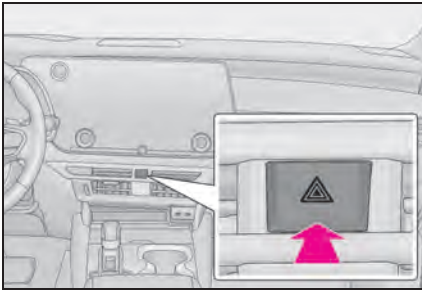

### Emergency flashers

- If the emergency flashers are used for a long time while the hybrid system is not operating (while the "READY" indicator is not illuminated), the 12-volt battery may discharge.
- If any of the SRS airbags deploy (inflate) or in the event of a strong rear impact, the emergency flashers will turn on automatically. The emergency flashers will turn off automatically after operating for approximately 20 minutes. To manually turn the emergency flashers off, press the switch twice. (The emergency flashers may not turn on automatically depending on the force of the impact and conditions of the collision.)

## If your vehicle has to be stopped in an emergency

Only in an emergency, such as if it becomes impossible to stop the vehicle in the normal way, stop the vehicle using the following procedure:

### Stopping the vehicle

- 1 Steadily step on the brake pedal with both feet and firmly depress it.

Do not pump the brake pedal repeatedly as this will increase the effort required to slow the vehicle.

- 2 Shift the shift position to N.
  - ▶ If the shift position is shifted to N
- 3 After slowing down, stop the vehicle in a safe place by the road.
- 4 Stop the hybrid system.
  - ▶ If the shift position cannot be shifted to N
- 3 Keep depressing the brake pedal with both feet to reduce vehicle speed as much as possible.
- 4 To stop the hybrid system, press and hold the power switch for 2 consecutive seconds or more, or

press it briefly 3 times or more in succession.

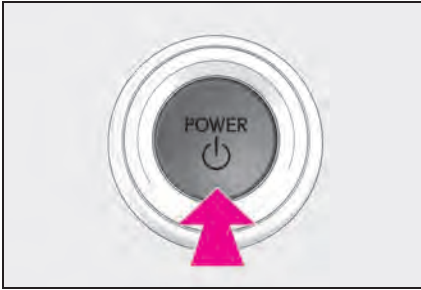

- 5 Stop the vehicle in a safe place by the road.

### WARNING

#### ■ If the hybrid system has to be turned off while driving

Power assist for the steering wheel will be lost, making the steering wheel heavier to turn. Decelerate as much as possible before turning off the hybrid system.

### If the vehicle is submerged or water on the road is rising

This vehicle is not designed to be able to drive on roads that are deeply flooded with water. Do not drive on roads where the roads may be submerged or the water may be rising. It is dangerous to remain in the vehicle, if it anticipated that the vehicle will be flooded or set a drift. Remain calm and follow the following.

- If the door can be opened, open the door and exit the vehicle.
- If the door can not be opened, open the window using the power window switch and ensure an escape route.
- If the window can be opened, exit the vehicle through the window.
- If the door and window cannot be opened due to the rising water, remain calm, wait until the water level inside the vehicle rises to the point that the water pressure inside of the vehicle equals the water pressure outside of the vehicle and then open the door after waiting for the rising water to enter the vehicle, and exit the vehicle. When the outside water level exceeds half the height of the door, the door cannot be opened from the inside due to water pressure.

#### ■ Water level exceeds the floor

When the water level exceeds the floor and time has passed, the electrical equipment will get damaged, the power windows will

not operate, the engine and motor stop, and the vehicle may not be able to get moving.

### ■ Using an emergency escape hammer<sup>\*1</sup>

Laminated glass<sup>\*2</sup> is used in the windshield and the windows on this vehicle.

Laminated glass cannot be shattered with an emergency hammer<sup>\*1</sup>.

<sup>\*1</sup>: Contact your Lexus dealer or aftermarket accessory manufacturer for further information about an emergency hammer.

<sup>\*2</sup>: If equipped

### ■ How to distinguish laminated glass

When looking from the cross-sectional view point, laminated glass is two sheets of glass pasted together.

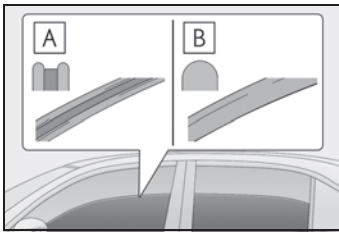

**A** Laminated glass

**B** Tempered glass



## WARNING

### ■ Caution while driving

Do not drive on roads where the roads may be submerged or the water may be rising. Otherwise the vehicle may be damaged and cannot move, as well as become flooded and set a drift, which may lead to death.

## If your vehicle needs to be towed

If towing is necessary, we recommend having your vehicle towed by your Lexus dealer or commercial towing service, using a wheel-lift type truck or flatbed truck.

Use a safety chain system for all towing, and abide by all state/provincial and local laws.

### Towing with a wheel-lift type truck

- ▶ From the front

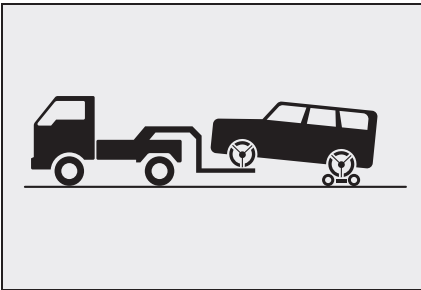

Use a towing dolly under the rear wheels.

- ▶ From the rear

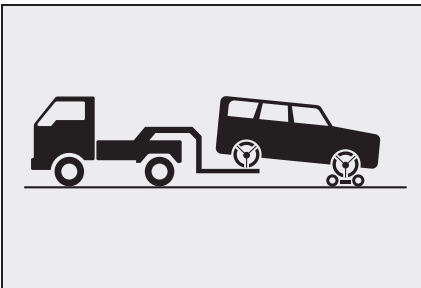

Use a towing dolly under the front wheels.

### ⚠ WARNING

Observe the following precautions. Failure to do so may result in death or serious injury.

#### ■ When towing the vehicle

Be sure to transport the vehicle with all four wheels raised off the ground. If the vehicle is towed with the tires contacting the ground, the drivetrain or related parts may be damaged, the vehicle may fly off the truck, or electricity generated by the operation of the motor may cause a fire to occur depending on the nature of the damage or malfunction.

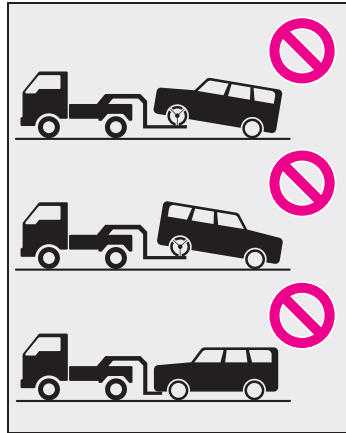

### ⚠ NOTICE

#### ■ To prevent damage to the vehicle when towing using a wheel-lift type truck

- Do not tow the vehicle from the rear when the power switch is off. The steering lock mechanism is not strong enough to hold the front wheels straight.
- When raising the vehicle, ensure adequate ground clearance for towing at the opposite end of the raised vehicle. Without adequate clearance, the vehicle could be damaged while being towed.

**NOTICE**

### ■ Towing with a sling-type truck

Do not tow with a sling-type truck to prevent body damage.

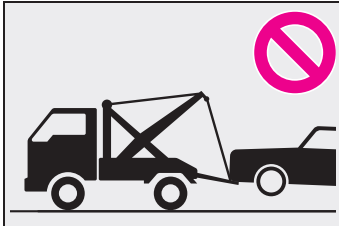

### Using a flatbed truck

When using a flat-bed truck to transport the vehicle, use tire strapping belts. Refer to the owner's manual of the flat-bed truck for the tire strapping method.

In order to suppress vehicle movement during transportation, set the parking brake and turn the power switch off.

**NOTICE**

### ■ To prevent damage to the vehicle during emergency towing

Do not secure cables or chains to the suspension components.

## If you think something is wrong

If you notice any of the following symptoms, your vehicle probably needs adjustment or repair. Contact your Lexus dealer as soon as possible.

### Visible symptoms

- Fluid leaks under the vehicle (Water dripping from the air conditioning after use is normal.)
- Flat-looking tires or uneven tire wear
- Engine coolant temperature gauge continually points higher than normal

### Audible symptoms

- Changes in exhaust sound
- Excessive tire squeal when cornering
- Strange noises related to the suspension system
- Pinging or other noises related to the hybrid system

### Operational symptoms

- Engine missing, stumbling or running roughly
- Appreciable loss of power
- Vehicle pulls heavily to one side when braking



- Vehicle pulls heavily to one side when driving on a level road
- Loss of brake effectiveness, spongy feeling, pedal almost touches the floor

## If a warning light turns on or a warning buzzer sounds



Calmly perform the following actions if any of the warning lights comes on or flashes. If a light comes on or flashes, but then goes off, this does not necessarily indicate a malfunction in the system. However, if this continues to occur, have the vehicle inspected by your Lexus dealer.

### Actions to the warning lights or warning buzzers

#### ■ Brake system warning light (warning buzzer)

Warning light	Details/Actions
 <p><b>BRAKE</b> (U.S.A.) or  (red) (Canada)</p>	<p>Indicates that:</p> <ul style="list-style-type: none"> <li>● The brake fluid level is low; or</li> <li>● The brake system is malfunctioning</li> </ul> <p>→ <b>Immediately stop the vehicle in a safe place and contact your Lexus dealer. Continuing to drive the vehicle may be dangerous.</b></p>

#### ■ Brake system warning light (warning buzzer)

Warning light	Details/Actions
 <p> (yellow)</p>	<p>Indicates a malfunction in:</p> <ul style="list-style-type: none"> <li>● The regenerative braking system;</li> <li>● The electronically controlled brake system; or</li> <li>● The parking brake system</li> </ul> <p>→ <b>Have the vehicle inspected by your Lexus dealer immediately.</b></p>

#### ■ High coolant temperature warning light\* (warning buzzer)

Warning light	Details/Actions
	<p>Indicates that the engine coolant temperature is too high</p> <p>→ <b>Immediately stop the vehicle in a safe place.</b> <b>Handling method (→P.560)</b></p>

\*: This light illuminates on the multi-information display.

### ■ Hybrid system overheat warning light\* (warning buzzer)

Warning light	Details/Actions
	Indicates the hybrid system has overheated → <b>Stop the vehicle in a safe place.</b> Handling method (→P.562)

\*: This light illuminates on the multi-information display.

### ■ Charging system warning light\* (warning buzzer)

Warning light	Details/Actions
	Indicates a malfunction in the vehicle's charging system → <b>Immediately stop the vehicle in a safe place and contact your Lexus dealer.</b>



\*: This light illuminates on the multi-information display.

### ■ Low engine oil pressure warning light\* (warning buzzer)

Warning light	Details/Actions
	Indicates that the engine oil pressure is too low → <b>Immediately stop the vehicle in a safe place and contact your Lexus dealer.</b>

\*: This light illuminates on the multi-information display.



### ■ Malfunction indicator lamp

Warning light	Details/Actions
 (U.S.A.) or  (Canada)	Indicates a malfunction in: <ul style="list-style-type: none"> <li>● The hybrid system;</li> <li>● The electronic engine control system;</li> <li>● The electronic throttle control system; or</li> <li>● RX500h: The electronic transmission control system</li> </ul> → <b>Immediately stop the vehicle in a safe place and contact your Lexus dealer.</b>

### ■ SRS warning light (warning buzzer)

Warning light	Details/Actions
	<p>Indicates a malfunction in:</p> <ul style="list-style-type: none"> <li>● The SRS airbag system; or</li> <li>● The seat belt pretensioner system</li> </ul> <p>→ <b>Have the vehicle inspected by your Lexus dealer immediately.</b></p>

### ■ ABS warning light (warning buzzer)



Warning light	Details/Actions
 (U.S.A.) or  (Canada)	<p>Indicates a malfunction in:</p> <ul style="list-style-type: none"> <li>● The ABS; or</li> <li>● The brake assist system</li> </ul> <p>→ <b>Have the vehicle inspected by your Lexus dealer immediately.</b></p>

### ■ Inappropriate pedal operation warning light\* (warning buzzer)

Warning light	Details/Actions
	<p>When a buzzer sounds:</p> <ul style="list-style-type: none"> <li>● Brake Override System is malfunctioning</li> <li>● Drive-Start Control is malfunctioning</li> <li>● Drive-Start Control is operating</li> <li>● PKSB (Parking Support Brake) (if equipped) is operating</li> </ul> <p>→ <b>Follow the instructions displayed on the multi-information display.</b></p> <p>When a buzzer does not sound:</p> <p>Brake Override System is operating</p> <p>→ <b>Release the accelerator pedal and depress the brake pedal.</b></p>

\*: This light illuminates on the multi-information display.

### ■ Electric power steering system warning light (warning buzzer)

Warning light	Details/Actions
 (red) or  (yellow)	Indicates a malfunction in the EPS (Electric Power Steering) system → <b>Have the vehicle inspected by your Lexus dealer immediately.</b>

### ■ Low fuel level warning light

Warning light	Details/Actions
	Indicates that remaining fuel is approximately 2.6 gal. (10.0 L, 2.2 Imp. gal.) or less → <b>Refuel the vehicle.</b>

### ■ Driver's and front passenger's seat belt reminder light (warning buzzer)\*

Warning light	Details/Actions
	Warns the driver and/or front passenger to fasten their seat belts → <b>Fasten the seat belt.</b> <b>If the front passenger's seat is occupied, the front passenger's seat belt also needs to be fastened to make the warning light (warning buzzer) turn off.</b>



\*: Driver's seat belt warning buzzer:

The driver's seat belt warning buzzer sounds to alert the driver that his or her seat belt is not fastened. Once the power switch is turned to ON, the buzzer sounds. If the seat belt is still unfastened, the buzzer sounds intermittently for a certain period of time after the vehicle reaches a certain speed.

Front passenger's seat belt warning buzzer:

The front passenger's seat belt warning buzzer sounds to alert the front passenger that his or her seat belt is not fastened. If the seat belt is unfastened, the buzzer sounds intermittently for a certain period of time after the vehicle reaches a certain speed.

### ■ Rear passengers' seat belt reminder light (warning buzzer)\*

Warning light	Details/Actions
 (Vehicles without a head-up display)	<p>Warns the rear passengers to fasten their seat belts → <b>Fasten the seat belt.</b></p>
 (Vehicles with a head-up display)	

\* : Rear passengers' seat belt warning buzzer:

The rear passengers' seat belt warning buzzer sounds to alert the rear passenger that his or her seat belt is not fastened. If the seat belt is unfastened, the buzzer sounds intermittently for a certain period of time, after the seat belt is fastened and unfastened and the vehicle reaches a certain speed.

### ■ Tire pressure warning light (warning buzzer)

Warning light	Details/Actions
	<p>When the light comes on (a buzzer sounds):</p> <ul style="list-style-type: none"> <li>● Low tire inflation pressure from natural causes → <b>After the temperature of the tires has lowered sufficiently, check the inflation pressure of each tire and adjust them to the specified level.</b></li> <li>● Low tire inflation pressure from flat tire → <b>Immediately stop the vehicle in a safe place and perform the necessary actions.</b></li> </ul> <p>When the light comes on after blinking for approximately 1 minute (a buzzer does not sound):</p> <p>Malfunction in the tire pressure warning system → <b>Have the system checked by your Lexus dealer.</b></p>

### ■ Intuitive parking assist OFF indicator (warning buzzer)

Warning light	Details/Actions
 (if equipped)	<p>Indicates a malfunction in the intuitive parking assist function → <b>Have the vehicle inspected by your Lexus dealer immediately.</b></p> <p>Indicates that the system is temporarily unavailable, possibly due to a sensor being dirty or covered with ice, etc. → <b>Follow the instructions displayed on the multi-information display.</b> (→P.330)</p>

### ■ PCS warning light (warning buzzer)

Warning light	Details/Actions
	<p>Indicates a malfunction in the PCS (Pre-Collision System).</p> <p>→ Follow the instructions displayed on the multi-information display.</p> <p>If the PCS (Pre-Collision System) or VSC (Vehicle Stability Control) system is disabled, the PCS warning light will illuminate.</p>

### ■ LTA indicator (warning buzzer)

Warning light	Details/Actions
	<p>Indicates a malfunction in the LTA (Lane Tracing Assist).</p> <p>→ Follow the instructions displayed on the multi-information display.</p>

### ■ LDA indicator (warning buzzer)

Warning light	Details/Actions
	<p>Indicates a malfunction in the LDA (Lane Departure Alert).</p> <p>→ Follow the instructions displayed on the multi-information display.</p>

### ■ PDA indicator (warning buzzer)

Warning light	Details/Actions
	<p>Indicates a malfunction in the PDA (Proactive Driving Assist).</p> <p>→ Follow the instructions displayed on the multi-information display.</p>

### ■ Dynamic radar cruise control indicator (warning buzzer)

Warning light	Details/Actions
	<p>Indicates a malfunction in the dynamic radar cruise control.</p> <p>→ Follow the instructions displayed on the multi-information display.</p>

### ■ Cruise control indicator (warning buzzer)

Warning light	Details/Actions
	<p>Indicates a malfunction in the cruise control.</p> <p>→ Follow the instructions displayed on the multi-information display.</p>

### ■ Driving assist information indicator



Warning light	Details/Actions
	<p>Indicates either of the following systems may be malfunctioning.</p> <ul style="list-style-type: none"> <li>● PCS (Pre-Collision System)</li> <li>● LDA (Lane Departure Alert)</li> </ul> <p>→ <b>Follow the instructions displayed on the multi-information display.</b></p> <p>Indicates one of the following systems is malfunctioning or disabled.</p> <ul style="list-style-type: none"> <li>● PKSB (Parking Support Brake)*</li> <li>● RCD (Rear Camera Detection)*</li> <li>● BSM (Blind Spot Monitor)</li> <li>● RCTA (Rear cross traffic alert)</li> <li>● Safe Exit Assist</li> </ul> <p>→ <b>Follow the instructions displayed on the multi-information display.</b></p>

\*: If equipped

### ■ Slip indicator

Warning light	Details/Actions
 <p>(illuminates)</p>	<p>Indicates a malfunction in:</p> <ul style="list-style-type: none"> <li>● The VSC system;</li> <li>● The TRAC system;</li> <li>● The Trailer Sway Control;</li> <li>● The Trail Mode function; or</li> <li>● The hill-start assist control system</li> </ul> <p>→ <b>Have the vehicle inspected by your Lexus dealer immediately.</b></p>

### ■ Parking brake indicator (warning buzzer)

Warning light	Details/Actions
 <p>(flashes) (U.S.A.)</p> <p>or</p>  <p>(flashes) (Canada)</p>	<p>It is possible that the parking brake is not fully engaged or released</p> <p>→ <b>Operate the parking brake switch once again.</b></p> <p>This light comes on the parking brake is not released. If the light turns off after the parking brakes is fully released, the system is operating normally.</p> <p>Indicates a malfunction in the parking brake system</p> <p>→ <b>Have the vehicle inspected by your Lexus dealer immediately.</b></p>

## ■ Brake hold operated indicator (warning buzzer)

Warning light	Details/Actions
	Indicates a malfunction in the brake hold system → <b>Have the vehicle inspected by your Lexus dealer immediately.</b>

### ■ Warning buzzer

In some cases, the buzzer may not be heard due to being in a noisy location or audio sound.

### ■ Front passenger detection sensor, seat belt reminder and warning buzzer

- If luggage is placed on the front passenger seat, the front passenger detection sensor may cause the warning light to flash and the warning buzzer to sound even if a passenger is not sitting in the seat.
- If a cushion is placed on the seat, the sensor may not detect a passenger, and the warning light may not operate properly.

### ■ SRS warning light

This warning light indicates problems with the following:

- Airbag sensor assembly
- Front impact sensors
- Side impact sensors (front door)
- Side impact sensors (front)
- Front passenger occupant classification sensors
- Driver's seat position sensor
- Front passenger's seat belt buckle switch
- "AIR BAG ON" indicator light
- "AIR BAG OFF" indicator light
- Seat belt pretensioners
- SRS airbags
- SRS system related wiring harnesses and power sources

### ■ If the malfunction indicator lamp comes on while driving

First check the following:

- Is the fuel tank empty?

If it is, fill the fuel tank immediately.

- Is the fuel tank cap loose?  
If it is, tighten it securely.

The light will go off after several driving trips.

If the light does not go off even after several trips, contact your Lexus dealer as soon as possible.

### ■ Electric power steering system warning light (warning buzzer)

When the 12-volt battery charge becomes insufficient or the voltage temporarily drops, the electric power steering system warning light may come on and the warning buzzer may sound.

### ■ When the tire pressure warning light comes on

Inspect the tires to check if a tire is punctured.

If a tire is punctured: →P.539

If none of the tires are punctured:  
Turn the power switch off then turn it to ON.  
Check if the tire pressure warning light comes on or blinks.

- ▶ If the tire pressure warning light blinks for approximately 1 minute then stays on

There may be a malfunction in the tire pressure warning system. Have the vehicle inspected by your Lexus dealer immediately.

- ▶ If the tire pressure warning light comes on

After the temperature of the tires has lowered sufficiently, check the inflation pressure of each tire and adjust them to the specified level.

If the warning light does not turn off even after several minutes have elapsed, check that the inflation pressure of each tire is at the specified level and perform the tire

inflation pressure setting procedure.  
(→P.488)

If the warning light does not turn off even after several minutes have elapsed since performing the tire inflation pressure setting procedure, have the vehicle inspected by your Lexus dealer immediately.

■ **The tire pressure warning light may come on due to natural causes**

The tire pressure warning light may come on due to natural causes such as natural air leaks and tire inflation pressure changes caused by temperature. In this case, adjusting the tire inflation pressure will turn off the warning light (after a few minutes).

■ **When a tire is replaced with a spare tire**

The spare tire is not equipped with a tire pressure warning valve and transmitter. If a tire goes flat, the tire pressure warning light will not turn off even though the flat tire has been replaced with the spare tire. Replace the spare tire with the repaired tire and adjust the tire inflation pressure. The tire pressure warning light will go off after a few minutes.

■ **Conditions that the tire pressure warning system may not function properly**

→P.486



**WARNING**

■ **If both the ABS and the brake system warning lights remain on**

Stop your vehicle in a safe place immediately and contact your Lexus dealer. The vehicle will become extremely unstable during braking, and the ABS system may fail, which could cause an accident resulting in death or serious injury.

■ **When the electric power steering system warning light comes on**

When the light comes on yellow, the assist to the power steering is restricted. When the light comes on red, the assist to the power steering is lost and handling operations of the steering wheel become extremely heavy. When steering wheel operations are heavier than usual, grip the steering wheel firmly and operate it using more force than usual.

■ **If the tire pressure warning light comes on**

Be sure to observe the following precautions.

Failure to do so could cause a loss of vehicle control and result in death or serious injury.

- Stop your vehicle in a safe place as soon as possible. Adjust the tire inflation pressure immediately.
- If the tire pressure warning light comes on even after tire inflation pressure adjustment, it is probable that you have a flat tire. Check the tires. If a tire is flat, change it with the spare tire and have the flat tire repaired by the nearest Lexus dealer.
- Avoid abrupt maneuvering and braking. If the vehicle tires deteriorate, you could lose control of the steering wheel or the brakes.
- **If a blowout or sudden air leakage should occur**

The tire pressure warning system may not activate immediately.

**WARNING****■ Maintenance of the tires**

Each tire, including the spare (if provided), should be checked monthly when cold and inflated to the inflation pressure recommended by the vehicle manufacturer on the vehicle placard or tire inflation pressure label (tire and load information label). (If your vehicle has tires of a different size than the size indicated on the vehicle placard or tire inflation pressure label [tire and load information label], you should determine the proper tire inflation pressure for those tires.)

As an added safety feature, your vehicle has been equipped with a tire pressure monitoring system (TPMS-tire pressure warning system) that illuminates a low tire pressure telltale (tire pressure warning light) when one or more of your tires is significantly under-inflated. Accordingly, when the low tire pressure telltale (tire pressure warning light) illuminates, you should stop and check your tires as soon as possible, and inflate them to the proper pressure. Driving on a significantly under-inflated tire causes the tire to overheat and can lead to tire failure. Under-inflation also reduces fuel efficiency and tire tread life, and may affect the vehicle's handling and stopping ability.

Please note that the TPMS (tire pressure warning system) is not a substitute for proper tire maintenance, and it is the driver's responsibility to maintain correct tire pressure, even if under-inflation has not reached the level to trigger illumination of the TPMS low tire pressure telltale (tire pressure warning light).

Your vehicle has also been equipped with a TPMS (tire pressure warning system) malfunction indicator to indicate when the system is not operating properly. The TPMS (tire pressure warning system) malfunction indicator is combined with the low tire pressure telltale (tire pressure warning light). When the system detects a malfunction, the telltale will flash for approximately one minute and then remain continuously illuminated. This sequence will continue upon subsequent vehicle start-ups as long as the malfunction exists. When the malfunction indicator is illuminated, the system may not be able to detect or signal low tire pressure as intended.

TPMS (tire pressure warning system) malfunctions may occur for a variety of reasons, including the installation of replacement or alternate tires or wheels on the vehicle that prevent the TPMS (tire pressure warning system) from functioning properly. Always check the TPMS (tire pressure warning system) malfunction telltale after replacing one or more tires or wheels on your vehicle to ensure that the replacement or alternate tires and wheels allow the TPMS (tire pressure warning system) to continue to function properly.

**NOTICE****■ To ensure the tire pressure warning system operates properly**

Do not install tires with different specifications or makers, as the tire pressure warning system may not operate properly.

## If a warning message is displayed

The multi-information display shows warnings for system malfunctions and incorrectly performed operations, and messages that indicate a need for maintenance.

When a message is displayed, perform the appropriate corrective action for the message.

If a warning message is displayed again after the appropriate actions have been performed, contact your Lexus dealer.

Additionally, if a warning light comes on or flashes at the same time that a warning message is displayed, take the appropriate corrective action for the warning light. (→P.516)

---

### ■ Warning messages

The warning messages explained below may differ from the actual messages according to operation conditions and vehicle specifications.

### ■ Warning buzzer

In some cases, the buzzer may not be heard due to being in a noisy location or audio sound.

## Messages and warnings

### ■ If “Engine Oil Level Low Add or Replace” is displayed

Cause	Actions
The engine oil level may be low.	<p>Check the level of the engine oil, and add engine oil if necessary. (→P.476)</p> <p>This message may be displayed if the vehicle is stopped on a slope. Move the vehicle to a level surface and check if the message disappears.</p>

### ■ If “Hybrid System Stopped Steering Power Low” is displayed

Cause	Actions
This message is displayed if the hybrid system is stopped while driving.	When steering wheel operations are heavier than usual, grip the steering wheel firmly and operate it using more force than usual.

### ■ If “Power Reduced to Lower Engine Temp” is displayed (RX500h)

Cause	Actions
<p>This message may be displayed when the engine coolant temperature is high.</p> <p>At that time, the engine power output is reduced until the temperature decreases to the specified level.</p>	<p>It is still possible to continue driving normally, meanwhile the acceleration performance or vehicle speed may be lowered.</p> <p>After driving for a while and the engine coolant temperature is dropped, this message will disappear and engine power output will resume once the engine coolant temperature has decreased to normal.</p> <p>If after driving for a while the message does not disappear or it comes on and off frequently, contact your Lexus dealer.</p>

### ■ If “Auto Power OFF to Conserve Battery” is displayed

Cause	Actions
Power was turned off due to the automatic power off function.	Next time when starting the hybrid system, operate the hybrid system for approximately 5 minutes to recharge the 12-volt battery.

■ If “Shift is in N Release Accelerator Before Shifting” is displayed

Cause	Actions
The accelerator pedal has been depressed when the shift position is in N.	Release the accelerator pedal and change the shift position to D or R.

■ If “Press brake when vehicle is stopped Hybrid system may overheat” is displayed

Cause	Actions
The message may be displayed when the accelerator pedal is depressed to hold the vehicle while the vehicle is stopped on an incline, etc.	The hybrid system may overheat. Release the accelerator pedal and depress the brake pedal.

■ If “12-Volt Battery Charging System Malfunction Stop in a Safe Place See Owner’s Manual” is displayed

Cause	Actions
It may indicate a malfunction.	Immediately stop the vehicle and contact your Lexus dealer. Continuing to drive the vehicle may be dangerous.

■ If “Traction battery needs to be protected. Shift into P to restart.” is displayed (RX350h)

Cause	Actions
This message is displayed when the hybrid battery (traction battery) charge has become extremely low because the vehicle has been left with the N shift position selected for a certain amount of time.	When operating the vehicle, shift to P and restart the hybrid system.

■ If “Traction battery needs to be protected. Refrain from the use of N position.” is displayed (RX350h)

Cause	Actions
This message may be displayed when the shift position is in N.	As the hybrid battery (traction battery) cannot be charged when the shift position is in N, shift the shift position to P when the vehicle is stopped.

■ If “Hybrid System Overheated Output Power Reduced” is displayed

Cause	Actions
This message may be displayed when driving under severe operating conditions. (For example, when driving up a long steep hill.)	→P.560

■ If “Tire Set Switching Incomplete Try Tire Set Registration Again See Owner’s Manual” is displayed

Cause	Actions
The wheel set change could not be completed.	Check which wheel set is installed and perform the change procedure again from the beginning.

■ If “Headlight System Malfunction Visit Your Dealer” is displayed

Cause	Actions
<p>The following systems may be malfunctioning.</p> <ul style="list-style-type: none"> <li>• The LED headlight system</li> <li>• The automatic headlight leveling system *</li> <li>• AHB (Automatic High Beam) *</li> <li>• AHS (Adaptive High-beam System) *</li> </ul>	Have the vehicle inspected by your Lexus dealer immediately.

\*: If equipped

■ If “Engine Coolant Temp High Stop in a Safe Place See Owner’s Manual” is displayed

Actions
→P.560

■ If “Access System with Elec.Key malfunction See owner’s manual” is displayed

Cause	Actions
It may indicate a malfunction.	Have the vehicle checked by your Lexus dealer immediately.

■ If “Braking Power Low Stop in a Safe Place See Owner’s Manual” is displayed

Cause	Actions
It may indicate a malfunction.	Immediately stop the vehicle and contact your Lexus dealer. Continuing to drive the vehicle may be dangerous.

■ If “Oil pressure low Stop in a safe place See owner’s manual” is displayed

Cause	Actions
It may indicate a malfunction.	Immediately stop the vehicle and contact your Lexus dealer. Continuing to drive the vehicle may be dangerous.

■ If “High Power Consumption Power to Climate Temporarily Limited” is displayed

Cause	Actions
If this message is displayed frequently, there is a possible malfunction relating to the charging system or the 12-volt battery may be deteriorating.	Have the vehicle checked by your Lexus dealer.

■ If a message that indicates the need for visiting your Lexus dealer is displayed

Cause	Actions
The system or part shown on the multi-information display is malfunctioning.	Have the vehicle inspected by your Lexus dealer immediately.

■ If “Maintenance Required for Traction Battery Cooling Parts See Owner’s Manual” is displayed

Cause	Actions
The air intake vent or filter of the hybrid battery (traction battery) may be clogged, the air intake vent may be blocked, or there may be a gap in the duct.	<ul style="list-style-type: none"> <li>• If the air intake vent or filter of the hybrid battery (traction battery) is dirty, clean them. (→P.498)</li> <li>• If the warning message is shown when the air intake vent and filter the hybrid battery (traction battery) are not dirty, have the vehicle inspected at your Lexus dealer.</li> </ul>

■ If “Shift System Malfunction Shifting Unavailable Drive to a Safe Place and Stop” is displayed

Cause	Actions
There is a malfunction in the shift control system.	Have the vehicle inspected by your Lexus dealer immediately.

■ If “Shift System Malfunction Driving Unavailable” is displayed

Cause	Actions
There is a malfunction in the shift control system.	Have the vehicle inspected by your Lexus dealer immediately.

■ If a message that indicates the need for the shift lever operation is displayed

Cause	Actions
To prevent the shift lever from being operated incorrectly or the vehicle from moving unexpectedly, a message that requires shifting the shift position may be displayed on the multi-information display.	Follow the instruction of the message and shift the shift position.

■ If “Shift System Malfunction Apply Parking Brake Securely When Parking See Owner’s Manual” is displayed

Cause	Actions
It may indicate a malfunction.	Have the vehicle inspected by your Lexus dealer immediately.

■ If “P Switch Malfunction Apply Parking Brake Securely When Parking See Owner’s Manual” is displayed

Cause	Actions
It may indicate a malfunction.	Have the vehicle inspected by your Lexus dealer immediately.

■ If “Shift System Unavailable Apply Parking Brake Securely When Parking See Owner’s Manual” is displayed

Cause	Actions
It may indicate a malfunction.	Have the vehicle inspected by your Lexus dealer immediately.

■ If “Shift System Malfunction See Owner’s Manual” is displayed

Cause	Actions
It may indicate a malfunction.	Have the vehicle inspected by your Lexus dealer immediately.







■ If “Shift System Malfunction Stop in a Safe Place See Owner’s Manual” is displayed

Cause	Actions
It may indicate a malfunction.	Have the vehicle inspected by your Lexus dealer immediately.

■ If “Battery Low Shifting Unavailable See Owner’s Manual” is displayed







Cause	Actions
It may indicate a malfunction.	Have the vehicle inspected by your Lexus dealer immediately.

■ If “System Malfunction Visit Your Dealer” is displayed

Cause	Actions
<p>Indicates one of the following systems is disabled.</p> <ul style="list-style-type: none"> <li>• PCS (Pre-Collision System)</li> <li>• LDA (Lane Departure Alert)</li> <li>• LTA (Lane Tracing Assist)</li> <li>•  LCA (Lane Change Assist)*</li> <li>• AHB (Automatic High Beam)*</li> <li>• AHS (Adaptive High-beam System)*</li> <li>• Dynamic radar cruise control system</li> <li>•  RSA (Road Sign Assist)*</li> <li>• PDA (Proactive Driving Assist)</li> <li>•  BSM (Blind Spot Monitor)</li> <li>•  RCTA (Rear Cross Traffic Alert)</li> <li>•  Safe Exit Assist</li> <li>• Intuitive parking assist*</li> <li>•  PKSB (Parking Support Brake)*</li> <li>•  RCD (Rear camera detection)*</li> </ul>	Have the vehicle inspected by your Lexus dealer immediately.



\*: If equipped

## ■ If “System Stopped See Owner’s Manual” is displayed

Cause	Actions
<p>Indicates one of the following systems is disabled.</p> <ul style="list-style-type: none"> <li>• PCS (Pre-Collision System)</li> <li>• LDA (Lane Departure Alert)</li> <li>• LTA (Lane Tracing Assist)</li> <li>•  LCA (Lane Change Assist)*</li> <li>• AHB (Automatic High Beam)*</li> <li>• AHS (Adaptive High-beam System)*</li> <li>• Dynamic radar cruise control system</li> <li>•  RSA (Road Sign Assist)*</li> <li>• PDA (Proactive Driving Assist)</li> <li>•  BSM (Blind Spot Monitor)</li> <li>•  RCTA (Rear Cross Traffic Alert)</li> <li>•  Safe Exit Assist</li> <li>• Intuitive parking assist*</li> <li>•  PKSB (Parking Support Brake)*</li> <li>•  RCD (Rear camera detection)*</li> </ul>	<p>Follow the following correction methods.</p> <ul style="list-style-type: none"> <li>• Check the voltage of the 12-volt battery</li> <li>• Check the sensors that the Lexus Safety System+ 3 uses for foreign matter covering them. Remove them if any. (→P.253)</li> <li>• Vehicles with RCD: Check if the back door is open.</li> </ul>
<p>Indicates the sensors may not be operating properly. (→P.257, 322, 327, 330, 340, 343, 352, 353, 354, 356)</p>	<ul style="list-style-type: none"> <li>• Check the rear bumper around the sensors used by the BSM, RCTA, or Safe Exit Assist for foreign matter covering them. Remove them if any. (→P.319, 325)</li> <li>• Check the sensors including camera sensors used by the Intuitive parking assist*, PKSB*, or RCD* for foreign matter covering them. Remove them if any. (→P.328)</li> <li>• When problems are solved and the sensors are operational, this indication may disappear by itself.</li> </ul>



\*: If equipped

■ If “System Stopped Front Camera Low Visibility See Owner’s Manual” is displayed

Cause	Actions
<p>Indicates one of the following systems is disabled.</p> <ul style="list-style-type: none"> <li>• PCS (Pre-Collision System)</li> <li>• LDA (Lane Departure Alert)</li> <li>• LTA (Lane Tracing Assist)</li> <li>•  LCA (Lane Change Assist)*</li> <li>• AHB (Automatic High Beam)*</li> <li>• AHS (Adaptive High-beam System)*</li> <li>• Dynamic radar cruise control system</li> <li>•  RSA (Road Sign Assist)*</li> <li>• PDA (Proactive Driving Assist)</li> </ul>	<p>Follow the following correction methods.</p> <ul style="list-style-type: none"> <li>• Using the windshield wipers, remove the dirt or foreign matter from the windshield.</li> <li>• Using the air conditioning system, defog the windshield.</li> <li>• Close the hood, remove any stickers, etc. to clear the obstruction in front of the front camera.</li> </ul>

\*: If equipped

■ If “System Stopped Front Camera Out of Temperature Range Wait until Normal Temperature” is displayed

Cause	Actions
<p>Indicates one of the following systems is disabled.</p> <ul style="list-style-type: none"> <li>• PCS (Pre-Collision System)</li> <li>• LDA (Lane Departure Alert)</li> <li>• LTA (Lane Tracing Assist)</li> <li>•  LCA (Lane Change Assist)*</li> <li>• AHB (Automatic High Beam)*</li> <li>• AHS (Adaptive High-beam System)*</li> <li>• Dynamic radar cruise control system</li> <li>•  RSA (Road Sign Assist)*</li> <li>• PDA (Proactive Driving Assist)</li> </ul>	<p>Follow the following correction methods.</p> <ul style="list-style-type: none"> <li>• If the front camera is hot, such as after the vehicle is parked in the sun, use the air conditioning system to decrease the temperature around the front camera</li> <li>• If a sunshade was used when the vehicle was parked, depending on its type, the sunlight reflected from the surface of the sunshade may cause the temperature of the front camera to become excessively high</li> <li>• If the front camera is cold, such as after the vehicle is parked in an extremely cold environment, use the air conditioning system to increase the temperature around the front camera</li> </ul>

\*: If equipped

### ■ If “System Stopped Front Radar Sensor Blocked Clean Radar Sensor” is displayed

Cause	Actions
<p>Indicates one of the following systems is disabled.</p> <ul style="list-style-type: none"> <li>• PCS (Pre-Collision System)</li> <li>• LDA (Lane Departure Alert)</li> <li>• LTA (Lane Tracing Assist)</li> <li>•  LCA (Lane Change Assist)*</li> <li>• AHB (Automatic High Beam)*</li> <li>• AHS (Adaptive High-beam System)*</li> <li>• Dynamic radar cruise control system</li> <li>• PDA (Proactive Driving Assist)</li> </ul>	<p>Follow the following correction methods.</p> <ul style="list-style-type: none"> <li>• Check if there is any foreign matter attached to the radar sensor or radar sensor cover and clean them if necessary. (→P.254)</li> <li>• This message may be displayed when driving in an open area with few nearby vehicles or structures, such as a desert, grasslands, suburbs, etc.</li> </ul> <p>The message may be cleared by driving the vehicle in an area with structures, vehicles, etc. nearby.</p>

\*: If equipped

### ■ If “System Stopped Front Radar Sensor Out of Temperature Range Wait until Normal Temperature” is displayed

Cause	Actions
<p>Indicates one of the following systems is disabled.</p> <ul style="list-style-type: none"> <li>• PCS (Pre-Collision System)</li> <li>• LDA (Lane Departure Alert)</li> <li>• LTA (Lane Tracing Assist)</li> <li>•  LCA (Lane Change Assist)*</li> <li>• AHB (Automatic High Beam)*</li> <li>• AHS (Adaptive High-beam System)*</li> <li>• Dynamic radar cruise control system</li> <li>• PDA (Proactive Driving Assist)</li> </ul>	<p>The temperature of the radar sensor is outside of the operating range. Wait for the temperature to become appropriate.</p>

\*: If equipped

■ If “System Stopped Front Radar In Self Calibration See Owner’s Manual” is displayed

Cause	Actions
<p>Indicates one of the following systems is disabled.</p> <ul style="list-style-type: none"> <li>• PCS (Pre-Collision System)</li> <li>• LDA (Lane Departure Alert)</li> <li>• LTA (Lane Tracing Assist)</li> <li>•  LCA (Lane Change Assist)*</li> <li>• AHB (Automatic High Beam)*</li> <li>• AHS (Adaptive High-beam System)*</li> <li>• Dynamic radar cruise control system</li> <li>• PDA (Proactive Driving Assist)</li> </ul>	<p>Follow the following correction methods.</p> <ul style="list-style-type: none"> <li>• Check if there is any foreign matter attached to the radar sensor or radar sensor cover and clean them if necessary. (→P.254)</li> <li>• The radar sensor may be misaligned and will be adjusted automatically while driving. Continue driving for a while.</li> </ul>

\* : If equipped

■ If “Driver Monitor Out of Temperature Range Wait until Normal Temperature” is displayed (on some models)

Cause	Actions
<p>Indicates one of the following systems is disabled.</p> <ul style="list-style-type: none"> <li>• Driver monitor</li> <li>• Traffic Jam Assist</li> </ul>	<p>The temperature of the driver monitor camera is outside of the operating range. Wait for the temperature to become appropriate.</p>

■ If “Unavailable Activation Condition not Satisfied See Owner’s Manual” is displayed (on some models)

Cause	Actions
<p> The LCA function cannot be used as the operating conditions have not been met. (P.276)</p>	<p>Operate the turn signal lever again after all of the operating conditions are met.</p>



■ If “Cruise Control Unavailable See Owner’s Manual” is displayed

Cause	Actions
<p>Indicates one of the following systems is disabled.</p> <ul style="list-style-type: none"> <li>• Dynamic radar cruise control</li> <li>• Cruise control</li> </ul> <p>A message is displayed when the driving assist switch is pushed repeatedly.</p>	<p>Press the driving assist switch quickly and firmly.</p>

■ If “Driver Monitor Unavailable See Owner’s Manual” is displayed (on some models)

Cause	Actions
The lens of the driver monitor camera may be dirty.	When there is dirt on the camera lens, clean it with a dry, soft cloth so as to not damage it.

■ If “Parking Assist Unavailable Low Visibility See Owner’s Manual” is displayed (on some models)

Cause	Actions
Indicates one of the following systems is disabled. <ul style="list-style-type: none"> <li>•  PKSB (Parking Support Brake)</li> <li>•  RCD (Rear camera detection)</li> </ul>	Remove any dirt or foreign matter from the rear cameras.

■ If “Check Engine” is displayed

Cause	Actions
It may indicate a malfunction.	Have the vehicle inspected by your Lexus dealer immediately.

■ If “Hybrid System Malfunction” is displayed

Cause	Actions
It may indicate a malfunction.	Have the vehicle inspected by your Lexus dealer immediately.

■ If “Accelerator System Malfunction” is displayed

Cause	Actions
It may indicate a malfunction.	Have the vehicle inspected by your Lexus dealer immediately.

■ If “Traction battery system malfunction” is displayed

Cause	Actions
It may indicate a malfunction.	Have the vehicle inspected by your Lexus dealer immediately.

**■ If “Hybrid System Stopped” is displayed**

Cause	Actions
The vehicle may have run out of fuel.	Stop the vehicle in a safe place and, if the fuel level is low, refuel the vehicle.

**■ If “Engine stopped No Fuel” is displayed**

Cause	Actions
The vehicle may have run out of fuel.	Stop the vehicle in a safe place and, if the fuel level is low, refuel the vehicle.

## If you have a flat tire

Your vehicle is equipped with a spare tire. The flat tire can be replaced with the spare tire.

For details about tires: →P.483



### WARNING

#### ■ If you have a flat tire

Do not continue driving with a flat tire. Driving even a short distance with a flat tire can damage the tire and the wheel beyond repair, which could result in an accident.

## Before jacking up the vehicle

- Stop the vehicle in a safe place on a hard, flat surface.
- Set the parking brake.
- Shift the shift position to P.
- Stop the hybrid system.
- Turn on the emergency flashers. (→P.510)

## Location of the spare tire, jack and tools

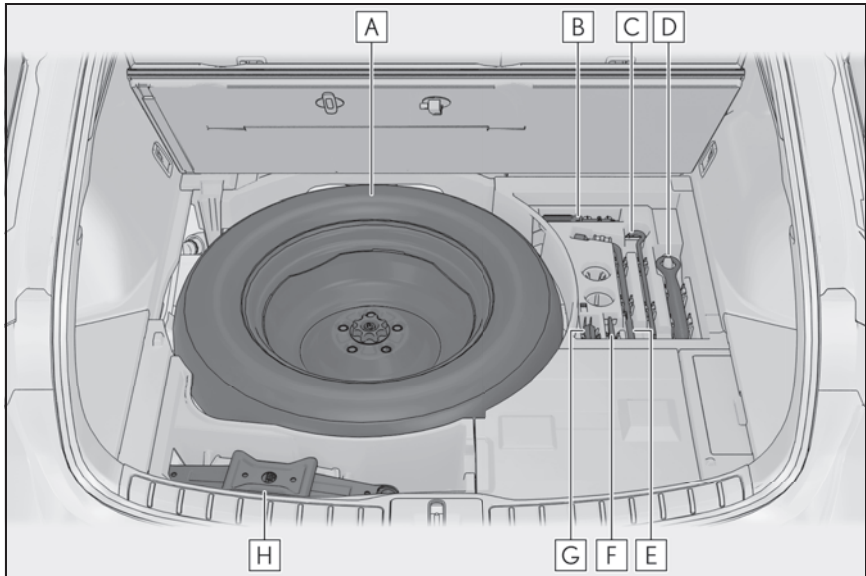

- A** Spare tire
- B** Screwdriver
- C** Jack handle
- D** Towing eyelet
- E** Wheel bolt wrench
- F** Guide pin
- G** Wheel bolt socket
- H** Jack

### **!** WARNING

#### ■ Using the tire jack

Observe the following precautions. Improper use of the tire jack may cause the vehicle to suddenly fall off the jack, leading to death or serious injury.

- Do not use the tire jack for any purpose other than replacing tires or installing and removing tire chains.

- Only use the tire jack that comes with this vehicle for replacing a flat tire. Do not use it on other vehicles, and do not use other tire jacks for replacing tires on this vehicle.
- Put the jack properly in its jack point.
- Do not put any part of your body under the vehicle while it is supported by the jack.
- Do not start the hybrid system or drive the vehicle while the vehicle is supported by the jack.

**⚠ WARNING**

- Do not raise the vehicle while someone is inside.
- When raising the vehicle, do not put an object on or under the jack.
- Do not raise the vehicle to a height greater than that required to replace the tire.
- Use a jack stand if it is necessary to get under the vehicle.
- When lowering the vehicle, make sure that there is no-one near the vehicle. If there are people nearby, warn them vocally before lowering.

**■ Replacing a flat tire for vehicles with power back door**

In cases such as when replacing tires, make sure to cancel the power back door system (→P.138). Failure to do so may cause the back door to operate unintentionally if the power back door switch is accidentally touched, resulting in hands and fingers being caught and injured.

**Taking out the jack**

- 1 Secure the deck board using the hook. (→P.433)
- 2 Take out the jack.

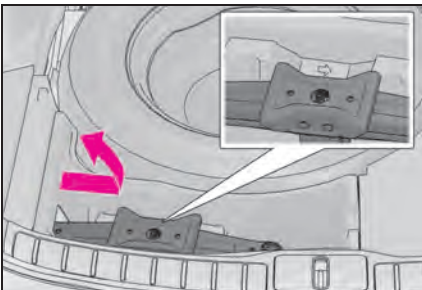
**Taking out the spare tire**

- 1 Secure the deck board using the hook. (→P.433)
- 2 Loosen the center fastener that secures the spare tire.

**⚠ WARNING****■ When storing the spare tire**

Be careful not to catch fingers or other body parts between the spare tire and the body of the vehicle.

**Replacing a flat tire**

- 1 Chock the tires.

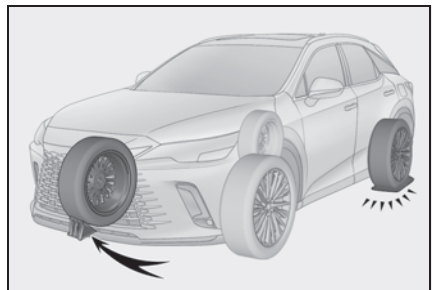

Flat tire	Wheel chock positions
Front left-hand side	Behind the rear right-hand side tire
Front right-hand side	Behind the rear left-hand side tire

Flat tire	Wheel chock positions
Rear left-hand side	In front of the front right-hand side tire
Rear right-hand side	In front of the front left-hand side tire

- 2** Using a wheel bolt wrench, slightly loosen the wheel bolts (approximately one turn).

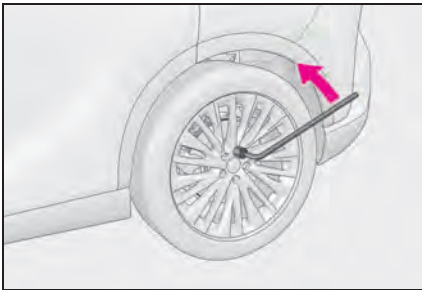

- 3** Turn the tire jack portion **A** by hand until the notch of the jack is in contact with the jack point.

The jack point guides are located under the rocker panel. They indicate the jack point positions.

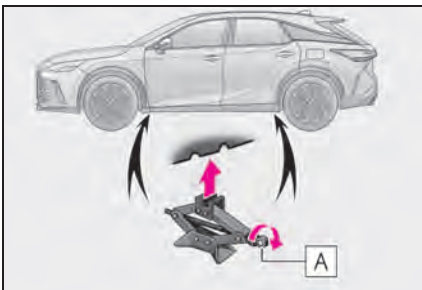

- 4** Install the wheel bolt wrench to the jack handle.

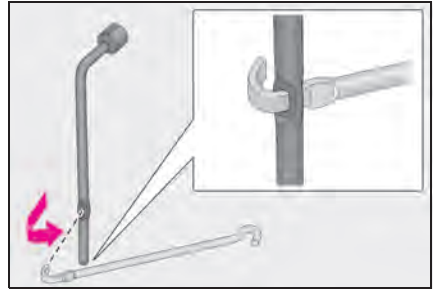

- 5** Raise the vehicle until the tire is slightly raised off the ground.

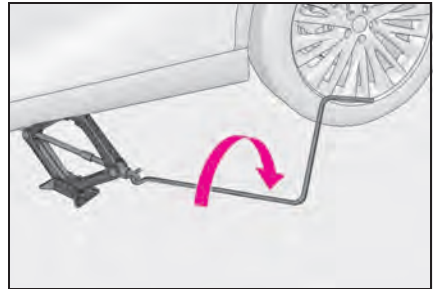

- 6** Remove the uppermost wheel bolt and install the guide pin **A** by hand.

Turn the guide pin clockwise to tighten it until it stops.

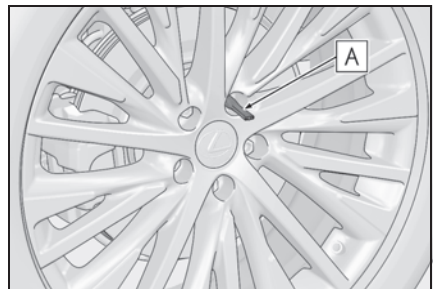

- 7** Remove all the wheel bolts and the tire.

When resting the tire on the ground, place the tire so that the wheel design faces up to

avoid scratching the wheel surface.

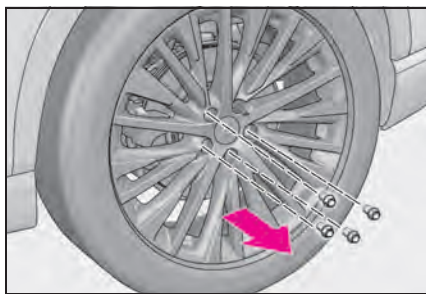

### ⚠ WARNING

#### ■ Replacing a flat tire

Do not touch the disc wheels or the area around the brakes immediately after the vehicle has been driven. After the vehicle has been driven the disc wheels and the area around the brakes will be extremely hot. Touching these areas with hands, feet or other body parts while changing a tire, etc. may result in burns.

### Installing the spare tire

- 1 Remove any dirt or foreign matter from the wheel contact surfaces and wheel bolts.

If foreign matter is on the wheel contact surface, the wheel bolts may loosen while the vehicle is in motion, causing the tire to come off.

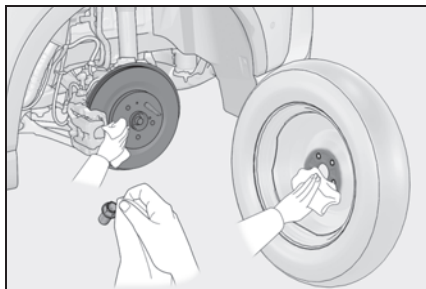

- 2 Align a wheel bolt hole on the spare tire with the guide pin, and set the spare tire on the guide pin.

Securely set the spare tire so that its wheel is touching the contact surface.

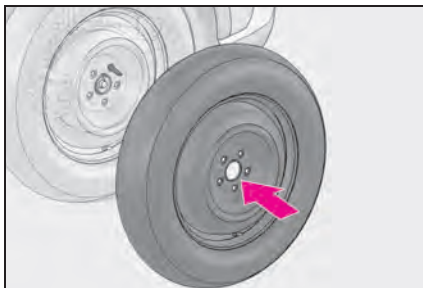

- 3 Loosely tighten each wheel bolt by hand or using a wheel bolt socket

**A.**

Push the spare tire to prevent it from falling.

Do not use the wheel bolt socket for anything other than loosely tightening the wheel bolts by hand.

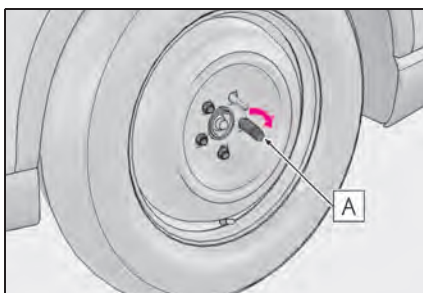

- 4 Remove the guide pin and loosely tighten the wheel bolt as in step 3.

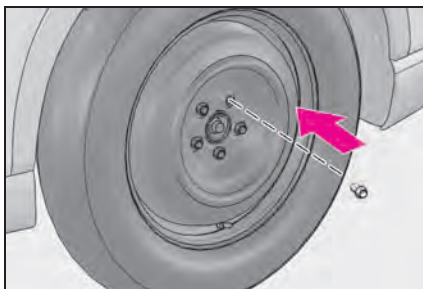

## 5 Lower the vehicle.

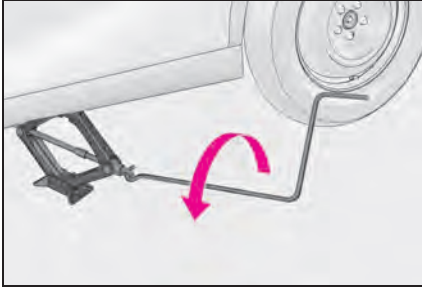

## 6 Securely tighten the wheel bolts two or three times in the order shown in the illustration using a wheel bolt wrench.

Tightening torque:  
103 ft•lbf (140 N•m, 14.3 kgf•m)

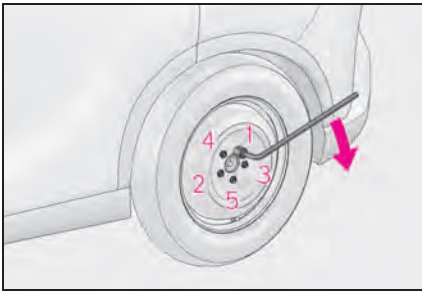

## 7 Stow the flat tire, tire jack and all tools.

### ■ The spare tire

- The spare tire is identified by the label "TEMPORARY USE ONLY" on the tire sidewall.
- Use the spare tire temporarily, and only in an emergency.
- Make sure to check the tire inflation pressure of the spare tire. (→P.576)

### ■ When using the spare tire

As the spare tire is not equipped with a tire pressure warning valve and transmitter, low inflation pressure of the spare tire will not be indicated by the tire pressure warning system. Also, if you replace the spare tire after the tire pressure warning light comes on,

the light remains on.

### ■ When the spare tire is equipped

The vehicle becomes lower when driving with the spare tire compared to when driving with standard tires.

### ■ If you have a flat front tire on a road covered with snow or ice

Install the spare tire on one of the rear wheels of the vehicle. Perform the following steps and fit tire chains to the front tires:

- 1 Replace a rear tire with the spare tire.
- 2 Replace the flat front tire with the tire removed from the rear of the vehicle.
- 3 Fit tire chains to the front tires.

## ⚠ WARNING

### ■ Installing the spare tire

Failure to follow these precautions could cause the wheel bolts to loosen and the tire to fall off, resulting in death or serious injury.

- The contact surfaces of the wheel bolt and wheel are designed specifically to fit together. When using wheels that were installed when the vehicle was shipped from the factory, use specialized Lexus genuine wheel bolts. Do not use wheel bolts designed for other models, model years or types even if they are Lexus genuine parts. If the vehicle does not have wheels that were installed to the vehicle when it was shipped from the factory, the factory-installed wheel bolts may not be appropriate for the wheel. Contact either the retailer where the wheels were purchased or the manufacturer of the wheels for proper installation advice.

## ⚠ WARNING

- Never apply oil or grease to the wheel bolts or their contact surface on the wheel **A**. Doing so may cause the wheel bolts to be tightened excessively, leading to damage to the wheel bolts, the threaded portion the wheel bolts install to **B**, or the wheel. Remove any oil or grease that has adhered when installing the wheel bolts.

### ▶ Steel wheel

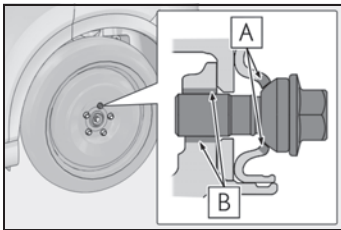

### ▶ Aluminum wheel

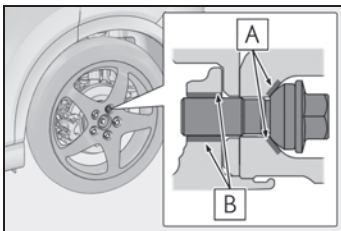

- After replacing a tire, check the tightening torque as soon as possible.
- Do not attach a heavily damaged wheel ornament, as it may fly off the wheel while the vehicle is moving.
- If a wheel bolt hole in a wheel or the threads of a wheel bolt or the wheel hub are deformed, cracked, rusty or otherwise damaged, have the vehicle inspected by your Lexus dealer.

## ■ When tightening the wheel bolts

Do not tighten the wheel bolts excessively. Doing so may cause the wheel bolts, the threads of the wheel hub, or the wheel to be damaged.

## ■ Guide pin

When removing or installing a tire, make sure to use the guide pin. Also, the guide pin is made of resin. It may be damaged if the wheel is placed anywhere other than **A** or if a large amount of force is applied to the guide pin.

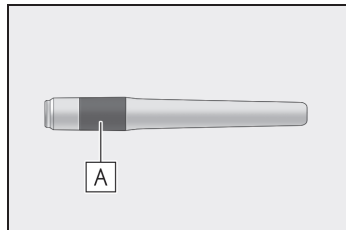

## ■ When using the spare tire

- Remember that the spare tire provided is specifically designed for use with your vehicle. Do not use your spare tire on another vehicle.
- Do not use more than one spare tire simultaneously.
- Replace the spare tire with a standard tire as soon as possible.
- Avoid sudden acceleration, abrupt steering, sudden braking and shifting operations that cause sudden engine braking.

## ■ When the spare tire is attached

The vehicle speed may not be correctly detected, and the following systems may not operate correctly:

- ABS & Brake assist
- VSC
- TRAC

**WARNING**

- Trailer Sway Control
- EPS
- VDIM (if equipped)
- Adaptive Variable Suspension System (if equipped)
- Dynamic radar cruise control
- PCS (Pre-Collision System)
- LTA (Lane Tracing Assist)
- LDA (Lane Departure Alert)
- RSA (Road Sign Assist) (if equipped)
- Automatic High Beam (if equipped)
- AHS (Adaptive High-beam System) (if equipped)
- Tire pressure warning system
- Intuitive parking assist
- PKSB (Parking Support Brake) (if equipped)
- Lexus parking assist monitor (if equipped)
- Panoramic view monitor (if equipped)
- BSM (Blind Spot Monitor)
- RCTA (Rear cross traffic alert)
- Automatic Rear Flashing Hazard Lights
- Safe Exit Assist (with door opening control)
- Navigation system (if equipped)

Also, not only can the following system not be utilized fully, but it may even negatively affect the drive-train components:

- E-Four<sup>\*1</sup>/DIRECT4<sup>\*2</sup> (Electronic AWD system)

<sup>\*1</sup>: RX350h

<sup>\*2</sup>: RX500h

■ **Speed limit when using the spare tire**

Do not drive at speeds in excess of 50 mph (80 km/h) when a spare tire is installed on the vehicle.

The spare tire is not designed for driving at high speeds. Failure to observe this precaution may lead to an accident causing death or serious injury.

■ **After using the tools and jack**

Before driving, make sure all the tools and jack are securely in place in their storage location to reduce the possibility of personal injury during a collision or sudden braking.

**NOTICE**

■ **Be careful when driving over bumps with the spare tire installed on the vehicle**

The vehicle becomes lower when driving with the spare tire compared to when driving with standard tires. Be careful when driving over uneven road surfaces.

■ **Driving with tire chains and the spare tire**

Do not fit tire chains to the spare tire. Tire chains may damage the vehicle body and adversely affect driving performance.

■ **When replacing the tires**

When removing or fitting the wheels, tires or the tire pressure warning valve and transmitter, contact your Lexus dealer as the tire pressure warning valve and transmitter may be damaged if not handled correctly.

## If the hybrid system will not start

Reasons for the hybrid system not starting vary depending on the situation. Check the following and perform the appropriate procedure:

### The hybrid system will not start even though the correct starting procedure is being followed. (→P.208)

One of the following may be the cause of the problem:

- The electronic key may not be functioning properly. (→P.549)
- There may not be sufficient fuel in the vehicle's tank.  
Refuel the vehicle.
- There may be a malfunction in the immobilizer system. (→P.82)
- There may be a malfunction in the shift control system.\* (→P.210, 527)
- There may be a malfunction in the steering lock system.
- The hybrid system may be malfunctioning due to an electrical problem such as electronic key battery depletion or a blown fuse. However, depending on the type of malfunction, an interim measure is available to start the hybrid system. (→P.547)
- There is a possibility that the temperature of the hybrid battery (traction battery) is extremely low (approximately below  $-22^{\circ}\text{F}$

$[-30^{\circ}\text{C}]$ ). (→P.209)

- \* It may not be possible to shift the shift position from P.

### The interior lights and headlights are dim, or the horn does not sound or sounds at a low volume.

One of the following may be the cause of the problem:

- The 12-volt battery may be discharged. (→P.553)
- The 12-volt battery terminal connections may be loose or corroded. (→P.481)

### The interior lights and headlights do not turn on, or the horn does not sound.

One of the following may be the cause of the problem:

- One or both of the 12-volt battery terminals may be disconnected. (→P.481)
- The 12-volt battery may be discharged. (→P.553)

Contact your Lexus dealer if the problem cannot be repaired, or if repair procedures are unknown.

### Starting the hybrid system in an emergency

When the hybrid system does not start, the following steps can be used as an interim measure to start the hybrid system if the power switch is functioning

normally.

Do not use this starting procedure except in cases of emergency.

- 1 Pull the parking brake switch to check that the parking brake is set. (→P.226)

Parking brake indicator will come on.

- 2 Turn the power switch to ACC.<sup>\*1,\*2</sup>
- 3 Press and hold the power switch for about 15 seconds while depressing the brake pedal firmly.

Even if the hybrid system can be started using the above steps, the system may be malfunctioning. Have the vehicle inspected by your Lexus dealer.

\*1: ACC mode can be enabled/disabled on the customize menu. (→P.590)

\*2: When ACC is disabled, turn the power switch to ON then OFF, and start the hybrid system as described in P.550 within 5 seconds.

## If you lose your keys

New genuine mechanical keys can be made by your Lexus dealer using another mechanical key and the key number stamped on your key number plate.

Keep the plate in a safe place such as your wallet, not in the vehicle.



### NOTICE

#### ■ When an electronic key is lost

If the electronic key remains lost, the risk of vehicle theft increases significantly. Visit your Lexus dealer immediately with all remaining electronic keys that were provided with your vehicle.

## If the electronic key does not operate properly

If communication between the electronic key and vehicle is interrupted (→P.141) or the electronic key cannot be used because the battery is depleted, the smart access system with push-button start and wireless remote control cannot be used. In such cases, the doors can be opened and the hybrid system can be started by following the procedure below.

### ■ When the electronic key does not work properly

- Check on the center display if the smart access system with push-button start is enabled. If disabled, change to enable the smart access system with push-button start.
- Check if battery-saving mode is set. If it is set, cancel the function. (→P.140)
- The electronic key function may be suspended. (→P.114)

### ⚠ NOTICE

#### ■ In case of a smart access system with push-button start malfunction or other key-related problems

Take your vehicle with all the electronic keys provided with your vehicle to your Lexus dealer.

## Locking and unlocking the doors

Use the mechanical key (→P.116) in order to perform the following operations:

- 1 Insert a plastic card, etc. into the gap in the door handle to pry up the cover.

To avoid damage, do not apply excessive force to the cover.

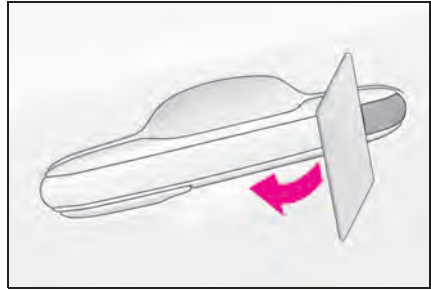

- 2 Remove the cover by pressing it on the rear.

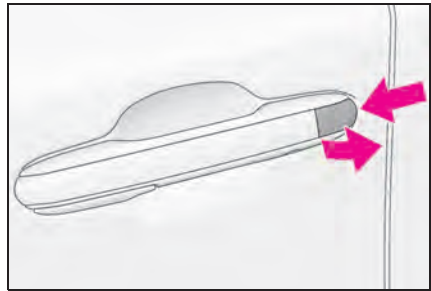

- 3 Use the mechanical key in order to perform the following operations:

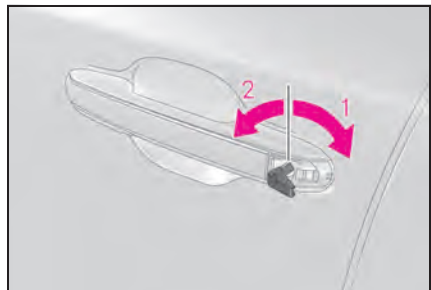

- 1 Unlocks all the doors  
Turning the key rearward unlocks the driver's door. Turning the key again unlocks the other doors.
- 2 Locks all the doors

### ■ Key linked functions

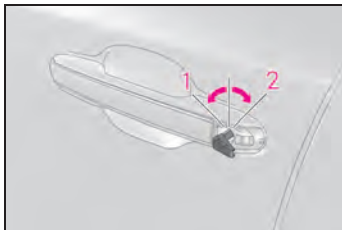

- 1 Closes the windows and the moon roof\* or panoramic moon roof\* (turn and hold)
- 2 Opens the windows and the moon roof\* or panoramic moon roof\* (turn and hold)

These settings must be customized at your Lexus dealer.

\*: If equipped

### ⚠ WARNING

■ When using the mechanical key and operating the power windows or the moon roof\* or panoramic moon roof\*

\*: If equipped

Operate the power window or the moon roof or panoramic moon roof after checking to make sure that there is no possibility of any passenger having any of their body parts caught in the window or the moon roof or panoramic moon roof. Also, do not allow children to operate the mechanical key. It is possible for children and other passengers to get caught in the power window or the moon roof or panoramic moon roof.

### Starting the hybrid system

- 1 Ensure that the shift position is in P and depress the brake pedal.
- 2 Touch the Lexus emblem side of the electronic key to the power switch.

When the electronic key is detected, a buzzer will sound and the power switch mode will change to ON.

When the smart access system with push-button start is deactivated in customization setting, the power switch will turn to ACC.

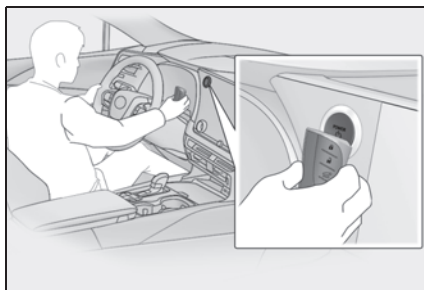

- 3 Firmly depress the brake pedal and check that  is shown on the multi-information display.
- 4 Press the power switch shortly and firmly.

In the event that the hybrid system still cannot be started, contact your Lexus dealer.

### ■ Stopping the hybrid system

Shift the shift lever to P, set the parking brake, and press the power switch as you normally do when stopping the hybrid system.

### ■ Replacing the key battery

As the above procedure is a temporary measure, it is recommended that the electronic key battery be replaced immediately when the battery is depleted. (→P.501)

### ■ Changing power switch modes

Release the brake pedal and press the power switch in step 3 above. The hybrid system does not start and modes will be changed each time the switch is pressed. (→P.211)

## If a door cannot be opened using the door opener switch

If a door cannot be opened using the door opener switch, it can be opened using a manual release handle.

### NOTICE

#### ■ Operating a manual release handle

Normally, the manual release handles cannot be used to open the doors. To enable manual release handle operation, perform the following. If the following is not performed and/or a manual release handle is operated with force, it may deform or be damaged.

### Opening a door using the manual release handle

#### ■ Opening a door using the manual release handle from outside the vehicle

Pull the manual release handle **A** to open the door.

Normally, the manual release handles cannot be used to open the doors.

To open a door, enable manual release handle operation. (→P.552)

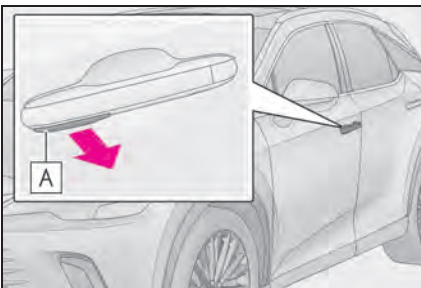

#### ■ Opening a door using the manual release handle from inside the vehicle

Pull the manual release handle **A** twice to open the door.

Pulling the handle once will enable operation. Pulling the handle again will open the door.

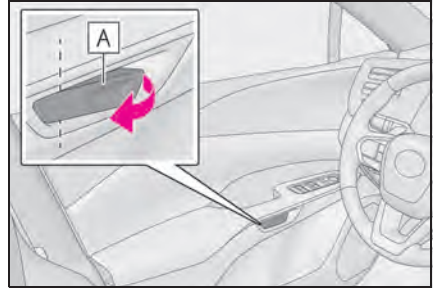

#### ■ Manual release handle operating conditions

##### ● When the vehicle is involved in a collision

The manual release handle may not become operable depending on the force of the impact and conditions of the collision.

##### ● When the 12-volt battery voltage drops slowly while a door was unlocked

It may not work depending on how it is lowered.

##### ● When manual release handle operation is enabled from inside the vehicle



##### ● When manual release handle operation is enabled from outside the vehicle using the mechanical key

### ■ Enabling outside manual release handle operation using the mechanical key

Operation of a manual release handle can be enabled by unlocking a door with the mechanical key.

- 1 Insert a plastic card, etc. into the gap in the door handle to pry up the cover.

To avoid damage, do not apply excessive force to the cover.

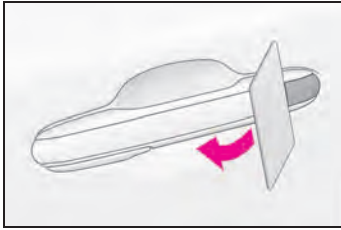

- 2 Remove the cover by pressing it on the rear.

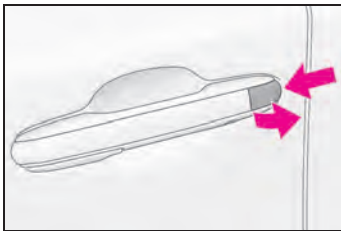

- 3 Using the mechanical key, turn the lock cylinder to the unlock side to enable the manual release handle operation.

The mechanical key can only be inserted in one direction, as the key only has a groove on one side.

If the key cannot be inserted in a lock cylinder, turn it over and re-attempt to insert it.

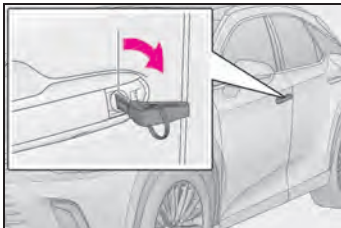

### ■ Conditions which manual release handle operation is disabled

- Normally, operation of the outside manual release handles is disabled, and they

cannot be used to open the doors.

When operation is enabled by operating a manual release handle or using a mechanical key, operation will be disabled automatically if the door is opened using the door opener switch or locked.

- Operation of the inside manual release handles is disabled when the power switch is in ON, and they cannot be used to open the doors.

When operation is enabled by operating a manual release handle or using a mechanical key, operation will be disabled automatically if the door is opened using the door opener switch or locked.

- To prevent a door from being opened accidentally, when the power switch is in ON, after an inside manual release handle is operated once, operation will automatically be disabled after approximately 1 second.

## If the 12-volt battery is discharged

The following procedures may be used to start the hybrid system if the vehicle's 12-volt battery is discharged.

You can also call your Lexus dealer or a qualified repair shop.

## Restarting the hybrid system

If you have a set of jumper (or booster) cables and a second vehicle with a 12-volt battery, you can jump start your vehicle by following the steps below.

- 1 Confirm that the electronic key is being carried.

When connecting the jumper (or booster) cables, depending on the situation, the alarm may activate and doors locked. (→P.84)

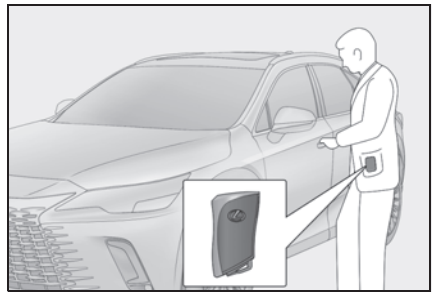

- 2 Open the hood (→P.471) and fuse box cover.

▶ RX500h

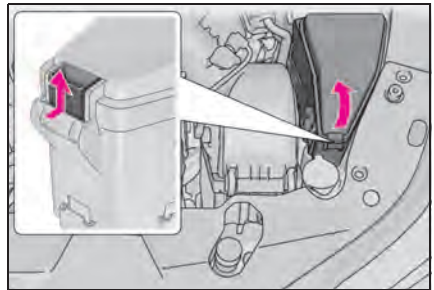

## ▶ RX350h

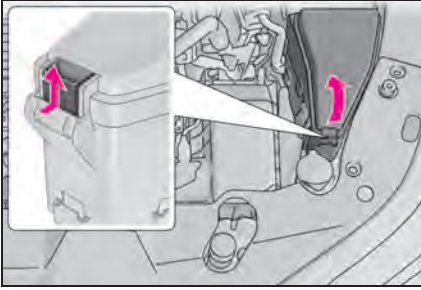

- 3** Open the exclusive jump starting terminal cover.

## ▶ RX500h

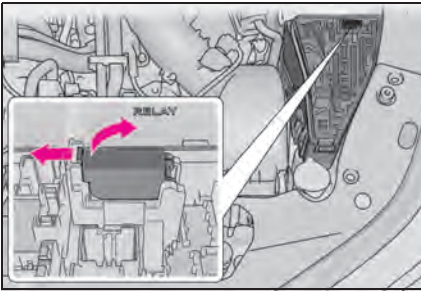

## ▶ RX350h

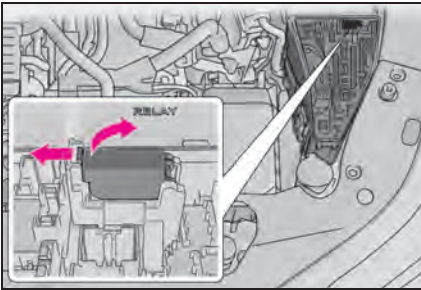

- 4 Connect a positive jumper cable clamp to **A** on your vehicle and connect the clamp on the other end of the positive cable to **B** on the second vehicle. Then, connect a negative cable clamp to **C** on the second vehicle and connect the clamp at the other end of the negative cable to **D**.

► RX500h

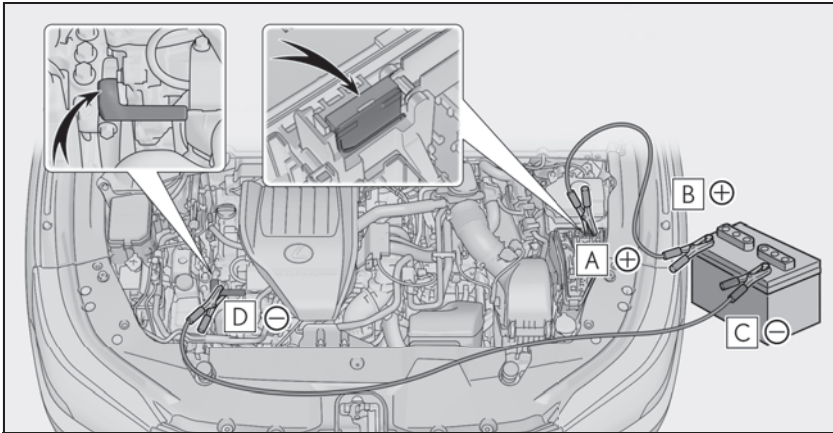

- A** Exclusive jump starting terminal (your vehicle)  
**B** Positive (+) battery terminal (second vehicle)  
**C** Negative (-) battery terminal (second vehicle)  
**D** Solid, stationary, unpainted metallic point away from the exclusive jump starting terminal and any moving parts as shown in the illustration

► RX350h

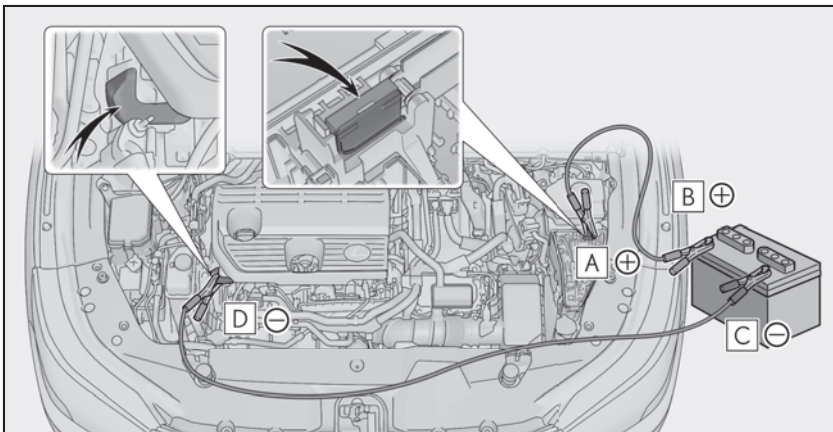

- A** Exclusive jump starting terminal (your vehicle)

- B** Positive (+) battery terminal (second vehicle)
  - C** Negative (-) battery terminal (second vehicle)
  - D** Solid, stationary, unpainted metallic point away from the exclusive jump starting terminal and any moving parts as shown in the illustration
- 5** Start the engine of the second vehicle. Increase the engine speed slightly and maintain at that level for approximately 5 minutes to recharge the 12-volt battery of your vehicle.
  - 6** Open and close any of the doors of your vehicle with the power switch off.
  - 7** Maintain the engine speed of the second vehicle and start the hybrid system of your vehicle by turning the power switch to ON.
  - 8** Make sure the “READY” indicator comes on. If the indicator light does not come on, contact your Lexus dealer.
  - 9** Once the hybrid system has started, remove the jumper cables in the exact reverse order from which they were connected.
  - 10** Close the exclusive jump starting terminal cover, and reinstall the fuse box cover to its original position.

Once the hybrid system starts, have the vehicle inspected at your Lexus dealer as soon as possible.

#### ■ Starting the hybrid system when the 12-volt battery is discharged

The hybrid system cannot be started by push-starting.

#### ■ If the doors cannot be unlocked using the smart access system with push-button start or wireless remote control

The doors can be opened by enabling its respective manual release handle operation. (→P.552)

#### ■ Locking the doors after the 12-volt battery was discharged

The doors cannot be locked using the smart access system with push-button start or wireless remote control.

By locking the door using the mechanical key, the operation of the manual release handle can be disabled.

#### ► Driver’s door

- 1** Insert a plastic card, etc. into the gap in the door handle to pry up the cover.

To avoid damage, do not apply excessive force to the cover.

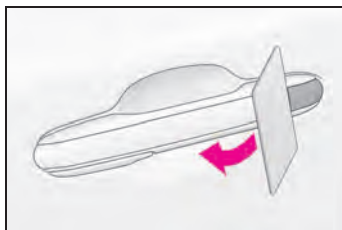

- 2** Remove the cover by pressing it on the rear.

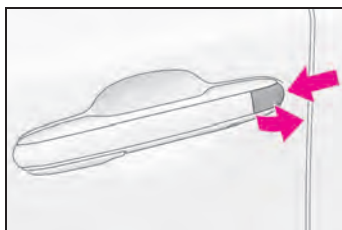

- 3 Using the mechanical key, turn the lock cylinder to the unlock side to enable the manual release handle operation.

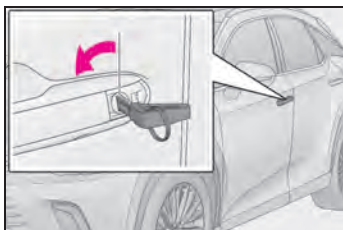

- 4 Check that the door cannot be opened.

► Doors other than the driver's door

- 1 Open the door. Using the mechanical key, slide the cover in the direction shown in the illustration.

To avoid damage, do not apply excessive force to the cover.

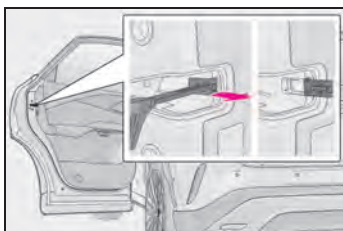

- 2 Insert the mechanical key into the opening.

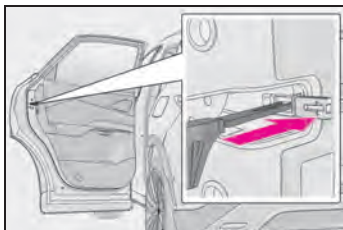

- 3 Remove the mechanical key and slide the cover back to its original position.

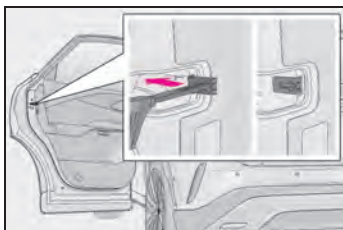

- 4 Check that all of the doors cannot be opened.

■ **To prevent 12-volt battery discharge**

- Turn off the headlights and the audio system while the hybrid system is off.
- Turn off any unnecessary electrical components when the vehicle is running at a low speed for an extended period, such as in heavy traffic.

■ **When the 12-volt battery is removed or discharged**

- Information stored in the ECU is cleared. When the 12-volt battery is depleted, have the vehicle inspected at your Lexus dealer.
- Some systems may require initialization. (→P.606)

■ **When removing the 12-volt battery terminals**

- When the 12-volt battery terminals are removed, the information stored in the ECU is cleared. Before removing the 12-volt battery terminals, contact your Lexus dealer.
- If a 12-volt battery terminal is disconnected, the doors will not be able to be opened using the door opener switches and the electronic key may become trapped in the vehicle

To prevent the electronic key (mechanical key) from being locked inside the vehicle, make sure to remove it from the vehicle before disconnecting a 12-volt battery terminal.



- If the electronic key (mechanical key) is to be left in the vehicle, make sure to open a window so an inside manual release handle can be operated.

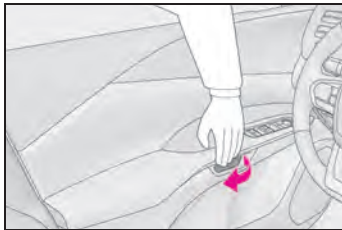

### ■ Charging the 12-volt battery

The electricity stored in the 12-volt battery will discharge gradually even when the vehicle is not in use, due to natural discharge and the draining effects of certain electrical appliances. If the vehicle is left for a long time, the 12-volt battery may discharge, and the hybrid system may be unable to start. (The 12-volt battery recharges automatically while the hybrid system is operating.)

### ■ When recharging or replacing the 12-volt battery

- In some cases, it may not be possible to unlock the doors using the smart access system with push-button start when the 12-volt battery is discharged. Use the wireless remote control or the mechanical key to lock or unlock the doors.
- The hybrid system may not start on the first attempt after the 12-volt battery has recharged but will start normally after the second attempt. This is not a malfunction.
- The power switch mode is memorized by the vehicle. When the 12-volt battery is reconnected, the system will return to the mode it was in before the 12-volt battery was discharged. Before disconnecting the 12-volt battery, turn the power switch off.  
If you are unsure what mode the power switch was in before the 12-volt battery discharged, be especially careful when reconnecting the 12-volt battery.
- If the 12-volt battery discharges, it may not be possible to shift the shift position to other positions. In this case, the vehicle cannot be towed without lifting both front wheels because the front wheels will be locked.
- Some systems may require initialization. (→P.606)

### ■ When replacing the 12-volt battery

- Use a Central Degassing type 12-volt battery (European Regulations).
- RX500h: Use a 12-volt battery that the case size is same as the previous one (LN3), 20 hour rate capacity (20HR) is equivalent (70Ah) or greater, and performance rating (CCA) is equivalent (603A) or greater.
- RX350h: Use a 12-volt battery that the case size is same as the previous one (LN2), 20 hour rate capacity (20HR) is equivalent (60Ah) or greater, and performance rating (CCA) is equivalent (563A) or greater.
- If the sizes differ, the 12-volt battery cannot be properly secured.
- If the 20 hour rate capacity is low, even if the time period where the vehicle is not used is a short time, the 12-volt battery may discharge and the hybrid system may not be able to start.
- Use a 12-volt battery with a handle. If a 12-volt battery without a handle is used, removal is more difficult.
- After replacing, firmly attach the following items to the exhaust hole of the 12-volt battery.
  - Use the exhaust hose that was attached to the 12-volt battery before replacing and confirm that it is firmly connected to the hole section of the vehicle.
  - Use the exhaust hole plug included with the 12-volt battery replaced or the one installed on the 12-volt battery prior to the replacement. (Depending on the 12-volt battery to be replaced, the exhaust hole may be plugged.)

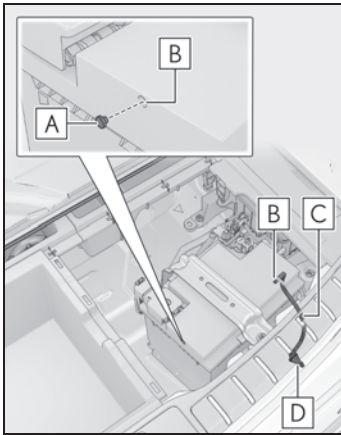

- A** Exhaust hole plug
- B** Exhaust hole
- C** Exhaust hose
- D** Hole section of the vehicle

For details, consult your Lexus dealer.



## WARNING

### ■ When removing the 12-volt battery terminals

Always remove the negative (-) terminal first. If the positive (+) terminal contacts any metal in the surrounding area when the positive (+) terminal is removed, a spark may occur, leading to a fire in addition to electrical shocks and death or serious injury.

### ■ Avoiding 12-volt battery fires or explosions

Observe the following precautions to prevent accidentally igniting the flammable gas that may be emitted from the 12-volt battery:

- Make sure each jumper cable is connected to the correct terminal and that it is not unintentionally in contact with any other than the intended terminal.

- Do not allow the other end of the jumper cable connected to the “+” terminal to come into contact with any other parts or metal surfaces in the area, such as brackets or unpainted metal.
- Do not allow the + and - clamps of the jumper cables to come into contact with each other.
- Do not smoke, use matches, cigarette lighters or allow open flame near the 12-volt battery.

### ■ 12-volt battery precautions

The 12-volt battery contains poisonous and corrosive acidic electrolyte, while related parts contain lead and lead compounds. Observe the following precautions when handling the 12-volt battery:

- When working with the 12-volt battery, always wear safety glasses and take care not to allow any battery fluids (acid) to come into contact with skin, clothing or the vehicle body.
- Do not lean over the 12-volt battery.
- In the event that battery fluid comes into contact with the skin or eyes, immediately wash the affected area with water and seek medical attention. Place a wet sponge or cloth over the affected area until medical attention can be received.
- Always wash your hands after handling the 12-volt battery support, terminals, and other battery-related parts.
- Do not allow children near the 12-volt battery.

### ■ After recharging the 12-volt battery

Have the 12-volt battery inspected at your Lexus dealer as soon as possible. If the 12-volt battery is deteriorating, continued use may cause the 12-volt battery to emit a malodorous gas, which may be detrimental to the health of passengers.

**WARNING****■ When replacing the 12-volt battery**

- When the vent plug and indicator are close to the hold down clamp, the battery fluid (sulfuric acid) may leak.
- For information regarding 12-volt battery replacement, contact your Lexus dealer.
- After replacing, securely attach the exhaust hose and exhaust hole plug to the exhaust hole of the replaced 12-volt battery. If not properly installed, gases (hydrogen) may leak into the vehicle interior, and there is the possible danger of the gas igniting and exploding.

**■ When disconnecting the 12-volt battery**

Do not disconnect the negative (-) terminal on the body side. The disconnected negative (-) terminal may touch the positive (+) terminal, which may cause a short and result in death or serious injury.

**NOTICE****■ When handling jumper cables**

When connecting the jumper cables, ensure that they do not become entangled in the cooling fan or belt.

**■ To prevent damaging the vehicle**

The exclusive jump starting terminal is to be used when charging the 12-volt battery from another vehicle in an emergency. It cannot be used to jump start another vehicle.

**If your vehicle overheats****The following may indicate that your vehicle is overheating.**

- The engine coolant temperature gauge (→P.90) is in the red zone or a loss of hybrid system power is experienced. (For example, the vehicle speed does not increase.)
- “Engine Coolant Temp High Stop in a Safe Place See Owner’s Manual” or “Hybrid System Overheated Output Power Reduced” is shown on the multi-information display.
- Steam comes out from under the hood.

**Correction procedures**

- ▶ “Engine Coolant Temp High Stop in a Safe Place See Owner’s Manual” is shown on the multi-information display
- 1 Stop the vehicle in a safe place and turn off the air conditioning system, and then stop the hybrid system.
  - 2 If you see steam: Carefully lift the hood after the steam subsides.  
If you do not see steam: Carefully lift the hood.
  - 3 After the hybrid system has cooled down sufficiently, inspect the hoses and radiator core (radiator) for any leaks.

## ▶ RX500h

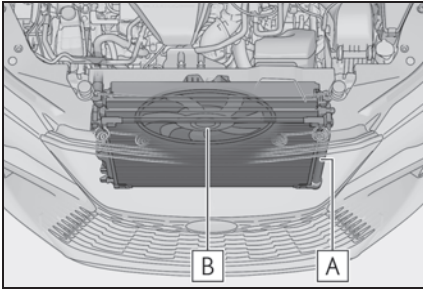

**A** Radiator

**B** Cooling fan

If a large amount of coolant leaks, immediately contact your Lexus dealer.

## ▶ RX350h

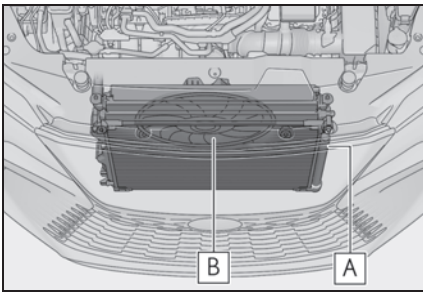

**A** Radiator

**B** Cooling fan

If a large amount of coolant leaks, immediately contact your Lexus dealer.

- 4 The coolant level is satisfactory if it is between the “MAX”/“FULL” and “MIN”/“LOW” lines on the reservoir.

## ▶ Engine (RX500h)

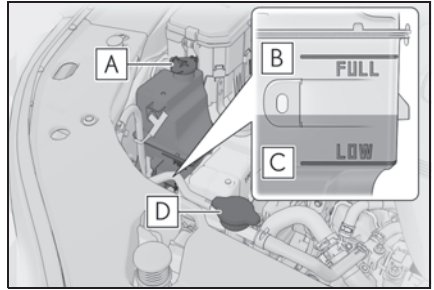

**A** Reservoir

**B** “FULL” line

**C** “LOW” line

**D** Radiator cap

## ▶ Engine (RX350h)

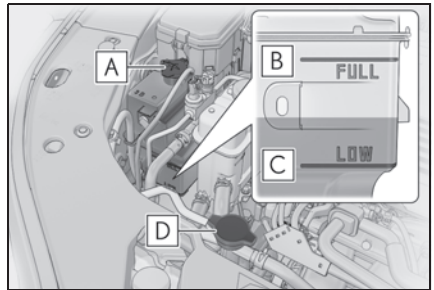

**A** Reservoir

**B** “FULL” line

**C** “LOW” line

**D** Radiator cap

## ▶ Intercooler (RX500h only)



- A** Reservoir
- B** "MAX" line
- C** "MIN" line

**5** Add coolant if necessary.

Water can be used in an emergency if coolant is unavailable.

► Engine (RX500h)

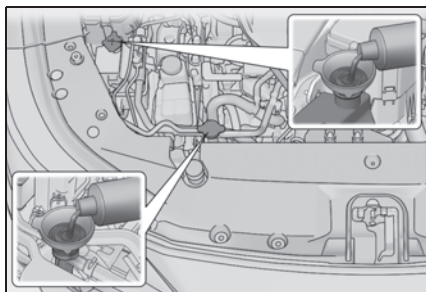

► Engine (RX350h)

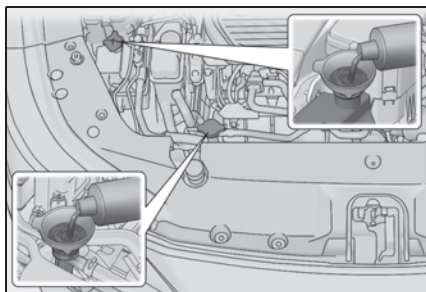

► Intercooler (RX500h only)

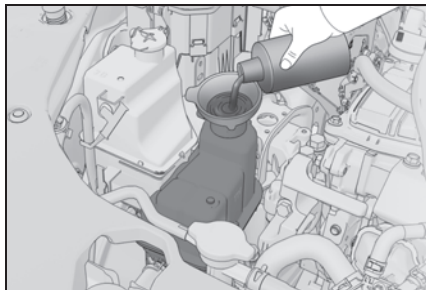

**6** Start the hybrid system and turn the air conditioning system on to check that the radiator cooling fan oper-

ate and to check for coolant leaks from the radiator or hoses.

The fan operate when the air conditioning system is turned on immediately after a cold start. Confirm that the fan is operating by checking the fan sound and air flow. If it is difficult to check these, turn the air conditioning system on and off repeatedly. (The fan may not operate in freezing temperatures.)

- 7** If the fan is not operating:  
Stop the hybrid system immediately and contact your Lexus dealer.
- If the fan is operating:  
Have the vehicle inspected at the nearest Lexus dealer.
- 8** Check if "Engine Coolant Temp High Stop in a Safe Place See Owner's Manual" is shown on the multi-information display.

If the message does not disappear:  
Stop the hybrid system and contact your Lexus dealer.

If the message is not displayed:  
Have the vehicle inspected at the nearest Lexus dealer.

- If "Hybrid System Overheated Output Power Reduced" is shown on the multi-information display
- 1** Stop the vehicle in a safe place.
  - 2** Stop the hybrid system and carefully lift the hood.
  - 3** After the hybrid system has cooled down, inspect the hoses and radiator core (radiator) for any leaks.

## ▶ RX500h

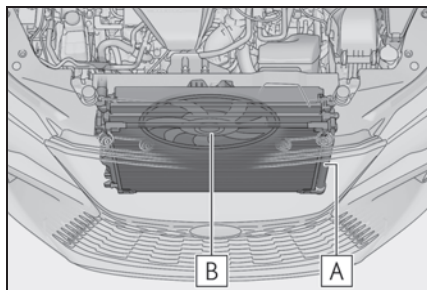

**A** Radiator

**B** Cooling fan

If a large amount of coolant leaks, immediately contact your Lexus dealer.

## ▶ RX350h

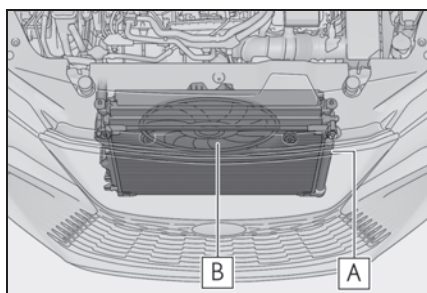

**A** Radiator

**B** Cooling fan

If a large amount of coolant leaks, immediately contact your Lexus dealer.

- 4** The coolant level is satisfactory if it is between the "MAX"/"FULL" and "MIN"/"LOW" lines on the reservoir.

## ▶ RX500h

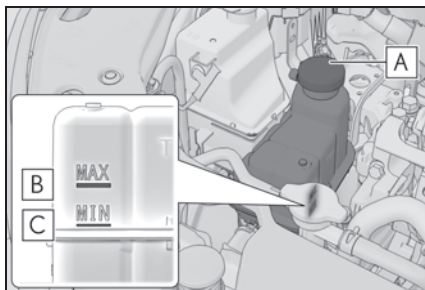

**A** Reservoir

**B** "MAX" line

**C** "MIN" line

## ▶ RX350h

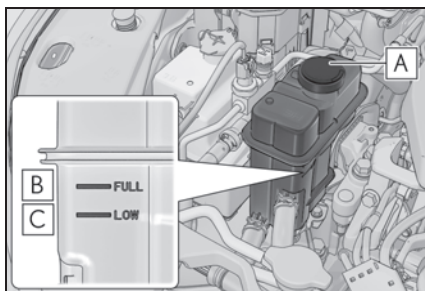

**A** Reservoir

**B** "FULL" line

**C** "LOW" line

- 5** Add coolant if necessary.

Water can be used in an emergency if coolant is unavailable.

## ▶ RX500h

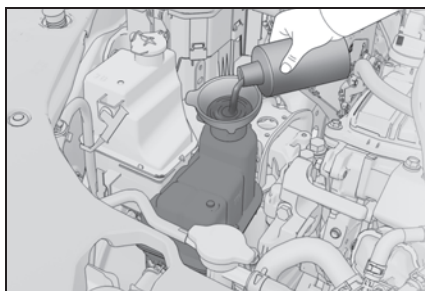

## ▶ RX350h

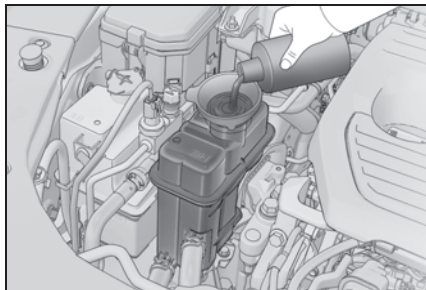

- 6 Start the hybrid system and check if “Hybrid System Overheated Output Power Reduced” is shown on the multi-information display. If the message does not disappear: Stop the hybrid system and contact your Lexus dealer. If the message is not displayed: Have the vehicle inspected at the nearest Lexus dealer.

 **WARNING**

■ **When inspecting under the hood of your vehicle**

Observe the following precautions. Failure to do so may result in serious injury such as burns.

- If steam is seen coming from under the hood, do not open the hood until the steam has subsided. The engine compartment may be very hot.
- RX350h: After the hybrid system has been turned off, check that the “READY” indicator is off. When the hybrid system is operating, the gasoline engine may automatically start, or the cooling fan may suddenly operate even if the gasoline engine stops. Do not touch or approach rotating parts such as the fan, which may lead to fingers or clothing (especially a tie, a scarf or a muffler) getting caught, resulting in serious injury.

- RX500h: After the hybrid system has been turned off, check that the “READY” indicator is off. When the hybrid system is operating, the gasoline engine may automatically start, or the cooling fan may suddenly operate even if the gasoline engine stops. Also, the cooling fan may operate for a while after turning off the hybrid system. Do not touch or approach rotating parts such as the fan, which may lead to fingers or clothing (especially a tie, a scarf or a muffler) getting caught, resulting in serious injury.
- Do not loosen the radiator cap and the coolant reservoir caps while the hybrid system and radiator are hot. High temperature steam or coolant could spray out.

 **NOTICE**

■ **When adding engine/power control unit coolant**

Add coolant slowly after the hybrid system has cooled down sufficiently. Adding cool coolant to a hot hybrid system too quickly can cause damage to the hybrid system.

■ **To prevent damage to the cooling system**

Observe the following precautions:

- Avoid contaminating the coolant with foreign matter (such as sand or dust, etc.).
- Do not use any coolant additive.

## If the vehicle becomes stuck

Carry out the following procedures if the tires spin or the vehicle becomes stuck in mud, dirt or snow:

### Recovering procedure

- 1 Stop the hybrid system. Set the parking brake and shift the shift position to P.
- 2 Remove the mud, snow or sand from around the front wheels.
- 3 Place wood, stones or some other material under the front wheels to help provide traction.
- 4 Restart the hybrid system.
- 5 Shift the shift position to D or R and release the parking brake. Then, while exercising caution, depress the accelerator pedal.

#### ■ When it is difficult to free the vehicle

Press  to turn off TRAC.

#### ► RX500h

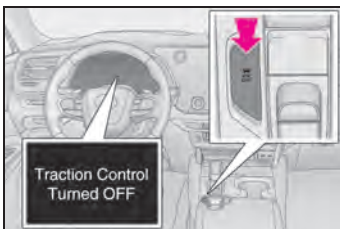

#### ► RX350h

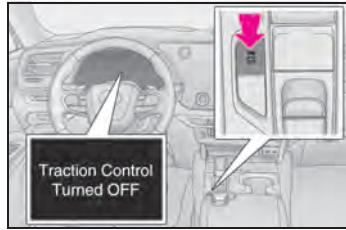

### ⚠ WARNING

#### ■ When attempting to free a stuck vehicle

If you choose to push the vehicle back and forth to free it, make sure the surrounding area is clear to avoid striking other vehicles, objects or people. The vehicle may also lunge forward or lunge back suddenly as it becomes free. Use extreme caution.

#### ■ When shifting the shift position

Be careful not to shift the shift position with the accelerator pedal depressed. This may lead to unexpected rapid acceleration of the vehicle that may cause an accident resulting in death or serious injury.

### ⚠ NOTICE

#### ■ To avoid damage to the transmission and other components

- Avoid spinning the front wheels and depressing the accelerator pedal more than necessary.
- If the vehicle remains stuck even after these procedures are performed, the vehicle may require towing to be freed.



**8-1. Specifications**

Maintenance data (fuel, oil level,  
etc.) .....568

Fuel information.....579

Tire information.....581

**8-2. Customization**

Customizable features.....590

**8-3. Initialization**

Items to initialize .....606

## Maintenance data (fuel, oil level, etc.)

### Dimensions and weight

Overall length	192.5 in. (4890 mm)	
Overall width	75.6 in. (1920 mm)	
Overall height <sup>*1</sup>	67.3 in. (1710 mm)	
Wheelbase	112.2 in. (2850 mm)	
Tread	Front	64.9 in. (1649.5 mm)
	Rear	65.6 in. (1666.9 mm) <sup>*2</sup> 65.7 in. (1667.9 mm) <sup>*3</sup>
Vehicle capacity weight (Occupants + luggage)	1110 lb. (505 kg)	
Trailer Weight Rating <sup>*4</sup> (Trailer weight + cargo weight)	3500 lb. (1588 kg)	

<sup>\*1</sup>: Unladen vehicle

<sup>\*2</sup>: RX350h

<sup>\*3</sup>: RX500h

<sup>\*4</sup>: Vehicles with towing package

### Seating capacity

Seating capacity	5 (Front 2, Rear 3)
------------------	---------------------

### Vehicle identification

■ **Vehicle identification number** of the instrument panel.

The vehicle identification number (VIN) is the legal identifier for your vehicle. This is the primary identification number for your Lexus. It is used in registering the ownership of your vehicle.

This number is stamped on the top left

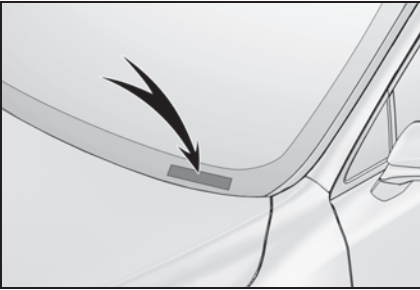

This number is also on the Certification Label.



### ■ Engine number

The engine number is stamped on the

engine block as shown.

### ► RX350h

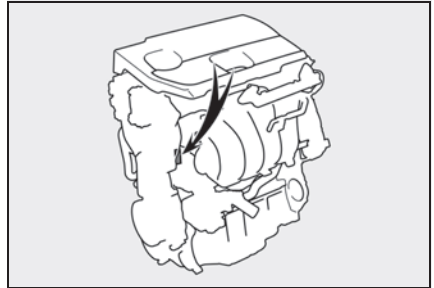

### ► RX500h



## Engine

### ► RX350h

Model	A25A-FXS
Type	4-cylinder in line, 4-cycle, gasoline
Bore and stroke	3.44 × 4.07 in. (87.5 × 103.4 mm)
Displacement	151.8 cu. in. (2487 cm <sup>3</sup> )
Valve clearance (engine cold)	Automatic adjustment

### ► RX500h

Model	T24A-FTS
Type	4-cylinder in line, 4-cycle, gasoline (with turbocharger)
Bore and stroke	3.44 × 3.92 in. (87.5 × 99.5 mm)

Displacement	146.0 cu. in. (2393 cm <sup>3</sup> )
Valve clearance (engine cold)	Automatic adjustment
Drive belt tension	Automatic adjustment

## Fuel

Fuel type	Unleaded gasoline only
Octane Rating	<p>► RX350h 91AKI (Research Octane Number 96) or higher [recommended]</p> <p>87AKI (Research Octane Number 91) or higher [minimum]</p> <p>► RX500h 91AKI (Research Octane Number 96) or higher</p>
Fuel tank capacity (Reference)	17.2 gal. (65 L, 14.3 Imp. gal.)

## Electric motor (traction motor) (RX350h)

### ► Front

Type	Permanent magnet synchronous motor
Maximum output	134 kW
Maximum torque	199 ft•lbf (270 N•m, 27.5 kgf•m)

### ► Rear

Type	Permanent magnet synchronous motor
Maximum output	40 kW
Maximum torque	89 ft•lbf (121 N•m, 12.3 kgf•m)

## Electric motor (traction motor) (RX500h)

### ► Front

Type	Permanent magnet synchronous motor
------	------------------------------------

Maximum output	64 kW
Maximum torque	215 ft•lbf (292 N•m, 29.8 kgf•m)

## ▶ Rear

Type	Permanent magnet synchronous motor
Maximum output	75.9 kW
Maximum torque	124 ft•lbf (168.5 N•m, 17.2 kgf•m)

**Hybrid battery (traction battery)**

## ▶ RX350h

Type	Nickel-Metal hydride battery
Voltage	1.2 V/cell
Capacity	5 Ah
Quantity	216 cells
Nominal voltage	259.2 V

## ▶ RX500h

Type	Nickel-Metal hydride battery
Voltage	1.2 V/cell
Capacity	5 Ah
Quantity	240 cells
Nominal voltage	288 V

**Lubrication system**■ Oil capacity (Drain and refill—reference<sup>\*</sup>)

## ▶ RX350h

With filter	4.8 qt. (4.5 L, 4.0 Imp. qt.)
Without filter	4.4 qt. (4.2 L, 3.7 Imp. qt.)

## ▶ RX500h

With filter	5.6 qt. (5.3 L, 4.7 Imp. qt.)
Without filter	5.3 qt. (5.0 L, 4.4 Imp. qt.)

\*: The engine oil capacity is a reference quantity to be used when changing the engine oil. When actually adding the engine oil, make sure that the oil level is

between the low level mark and refill upper limit mark (→P.476). Warm up the engine and turn off the hybrid system, wait about 5 minutes, and check the oil level on the dipstick.

### ■ Engine oil selection (RX350h)

“Toyota Genuine Motor Oil” is used in your Lexus vehicle. Use Lexus approved “Toyota Genuine Motor Oil” or equivalent to satisfy the following grade and viscosity.

Oil grade: ILSAC GF-6B multigrade engine oil

Recommended viscosity: SAE OW-16

SAE OW-16 is the best choice for good fuel economy and good starting in cold weather.

If SAE OW-16 is not available, SAE OW-20 oil may be used. However, it must be replaced with SAE OW-16 at the next oil change.

- The 16 in OW-16 indicates the viscosity characteristic of the oil when the oil is at high temperature. An oil with a higher viscosity (one with a higher value) may be better suited if the vehicle is operated at high speeds, or under extreme load conditions.

How to read oil container label:

API registered marks is added to some oil containers to help you select the oil you should use.



### ■ Engine oil selection (RX500h)

“Toyota Genuine Motor Oil” is used in your Lexus vehicle. Use Lexus approved “Toyota Genuine Motor Oil” or equivalent to satisfy the following grade and viscosity.

Oil grade: ILSAC GF-6A multigrade engine oil

Recommended viscosity: SAE OW-20

SAE OW-20 is the best choice for good fuel economy and good starting in cold weather.

If SAE OW-20 is not available, SAE 5W-20 oil may be used. However, it must be replaced with SAE OW-20 at the next oil change.

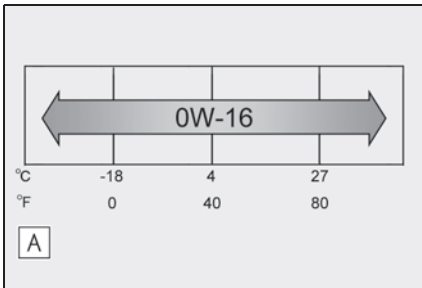

#### A Outside temperature

Oil viscosity (OW-16 is explained here as an example):

- The OW in OW-16 indicates the characteristic of the oil which allows cold startability. Oils with a lower value before the W allow for easier starting of the engine in cold weather.

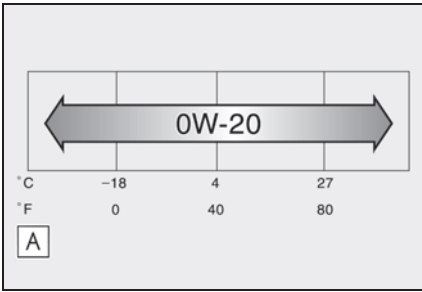

**A** Outside temperature

Oil viscosity (0W-20 is explained here as an example):

- The 0W in 0W-20 indicates the characteristic of the oil which allows cold startability. Oils with a lower value before the W allow for easier starting of the engine in cold weather.
- The 20 in 0W-20 indicates the viscosity characteristic of the oil when the oil is at high temperature. An oil

with a higher viscosity (one with a higher value) may be better suited if the vehicle is operated at high speeds, or under extreme load conditions.

How to read oil container label:

The International Lubricant Specification Advisory Committee (ILSAC) Certification Mark is added to some oil containers to help you select the oil you should use.



**Cooling system**

Capacity *	RX350h	<ul style="list-style-type: none"> <li>▶ Gasoline engine 8.7 qt. (8.2 L, 7.2 Imp. qt.)</li> <li>▶ Power control unit 2.1 qt. (2.0 L, 1.8 Imp. qt.)</li> </ul>
	RX500h	<ul style="list-style-type: none"> <li>▶ Gasoline engine 9.9 qt. (9.4 L, 8.3 Imp. qt.)</li> <li>▶ Intercooler/Power control unit 5.6 qt. (5.3 L, 4.7 Imp. qt.)</li> </ul>
Coolant type	<p>Use either of the following:</p> <ul style="list-style-type: none"> <li>• "Toyota Super Long Life Coolant"</li> <li>• Similar high-quality ethylene glycol-based non-silicate, non-amine, non-nitrite, and non-borate coolant with long-life hybrid organic acid technology</li> </ul> <p>Do not use plain water alone.</p>	

\*: The coolant capacity is a reference quantity.

If replacement is necessary, contact your Lexus dealer.

### Ignition system (spark plug)

Make	RX350h	DENSO FC16HR-Q8
	RX500h	NGK DILZKAR8E7H
Gap	RX350h	0.03 in. (0.8 mm)
	RX500h	0.03 in. (0.7 mm)



#### NOTICE

##### ■ Iridium-tipped spark plugs

Use only iridium-tipped spark plugs. Do not adjust the spark plug gap.

### Electrical system (12-volt battery)

Open voltage at 68°F (20°C):	12.0 V or higher (Turn the power switch off and turn on the headlights for 30 seconds.)
Charging rates: Slow charge	5 A max.

### Transmission

Fluid capacity *	RX350h	4.6 qt. (4.4 L, 3.9 Imp. qt.)
	RX500h	6.8 qt. (6.4 L, 5.6 Imp. qt.)
Fluid type	Toyota Genuine ATF WS	

\*: The fluid capacity is a reference quantity.  
If replacement is necessary, contact your Lexus dealer.



#### NOTICE

##### ■ Transmission fluid type

Using transmission fluid other than the above type may cause abnormal noise or vibration, or ultimately damage the transmission of your vehicle.

**Rear differential (rear electric motor) (RX350h)**

Fluid capacity *	1.8 qt. (1.7 L, 1.5 Imp. qt.)
Fluid type	Toyota Genuine ATF WS

\*: The fluid capacity is a reference quantity.  
If replacement is necessary, contact your Lexus dealer.

**NOTICE****■ Rear differential fluid type**

Using differential fluid other than the above type may cause abnormal noise or vibration, or ultimately damage the differential of your vehicle.

**Rear transaxle (rear electric motor) (RX500h)**

Fluid capacity *	3.2 qt. (3.1 L, 2.7 Imp. qt.)
Fluid type	e-Transaxle Fluid TE

\*: The fluid capacity is a reference quantity.  
If replacement is necessary, contact your Lexus dealer.

**NOTICE****■ Rear transaxle fluid type**

Using transaxle fluid other than the above type may cause abnormal noise or vibration, or ultimately damage the transaxle of your vehicle.

**Brakes**

Pedal clearance * <sup>1</sup>	4.8 in. (122 mm) Min.
Pedal free play	0.04—0.24 in. (1—6 mm)
Brake pad wear limit	0.04 in. (1.0 mm)
Parking brake indicator * <sup>2</sup>	When pushing the parking brake switch for 1 to 2 seconds: turns off When pulling the parking brake switch for 1 to 2 seconds: comes on
Fluid type	FMVSS No. 116 DOT 3 or SAE J1703 FMVSS No. 116 DOT 4 or SAE J1704

\*<sup>1</sup>: Minimum pedal clearance when depressed with a force of 67.5 lbf (300 N, 30.6 kgf)

while the hybrid system is operating.

\*2: Make sure to confirm that the brake warning light (yellow) does not illuminate. (If the brake warning light illuminates, refer to P.516.)

## Steering

Free play	Less than 0.59 in. (15 mm)
-----------	----------------------------

## Tires and wheels

### ► Type A

Tire size	235/60R19 103V, T165/90D18 107M (spare)
Tire inflation pressure (Recommended cold tire inflation pressure)	<p>► Front 33 psi (230 kPa, 2.3 kgf/cm<sup>2</sup> or bar)</p> <p>► Rear 33 psi (230 kPa, 2.3 kgf/cm<sup>2</sup> or bar)</p> <p>► Spare 60 psi (420 kPa, 4.2 kgf/cm<sup>2</sup> or bar)</p> <p>Driving at high speeds (above 100 mph [160 km/h]) (in countries where such speeds are permitted by law)</p> <p>Add 5 psi (30 kPa, 0.3 kgf/cm<sup>2</sup> or bar) to the front and rear tires. Never exceed the maximum cold tire inflation pressure indicated on the tire sidewall.</p>
Wheel size	19 × 8J, 18 × 4T (spare)
Wheel bolt torque	103 ft•lbf (140 N•m, 14.3 kgf•m)

## ► Type B

Tire size	235/60R19 103V, T165/70D20 119M (spare)
Tire inflation pressure (Recommended cold tire inflation pressure)	<p>► Front</p> <p>33 psi (230 kPa, 2.3 kgf/cm<sup>2</sup> or bar)</p> <p>► Rear</p> <p>33 psi (230 kPa, 2.3 kgf/cm<sup>2</sup> or bar)</p> <p>► Spare</p> <p>60 psi (420 kPa, 4.2 kgf/cm<sup>2</sup> or bar)</p> <p>Driving at high speeds (above 100 mph [160 km/h]) (in countries where such speeds are permitted by law)</p> <p>Add 5 psi (30 kPa, 0.3 kgf/cm<sup>2</sup> or bar) to the front and rear tires. Never exceed the maximum cold tire inflation pressure indicated on the tire sidewall.</p>
Wheel size	19 × 8J, 20 × 4T (spare)
Wheel bolt torque	103 ft•lbf (140 N•m, 14.3 kgf•m)

## ► Type C

Tire size	235/50R21 101V, T165/90D18 107M (spare)
Tire inflation pressure (Recommended cold tire inflation pressure)	<p>► Front</p> <p>33 psi (230 kPa, 2.3 kgf/cm<sup>2</sup> or bar)</p> <p>► Rear</p> <p>33 psi (230 kPa, 2.3 kgf/cm<sup>2</sup> or bar)</p> <p>► Spare</p> <p>60 psi (420 kPa, 4.2 kgf/cm<sup>2</sup> or bar)</p> <p>Driving at high speeds (above 100 mph [160 km/h]) (in countries where such speeds are permitted by law)</p> <p>Add 8 psi (50 kPa, 0.5 kgf/cm<sup>2</sup> or bar) to the front and rear tires. Never exceed the maximum cold tire inflation pressure indicated on the tire sidewall.</p>
Wheel size	21 × 8J, 18 × 4T (spare)
Wheel bolt torque	103 ft•lbf (140 N•m, 14.3 kgf•m)

## ► Type D

Tire size	235/50R21 101V, T165/70D20 119M (spare)
Tire inflation pressure (Recommended cold tire inflation pressure)	<p>► Front 33 psi (230 kPa, 2.3 kgf/cm<sup>2</sup> or bar)</p> <p>► Rear 33 psi (230 kPa, 2.3 kgf/cm<sup>2</sup> or bar)</p> <p>► Spare 60 psi (420 kPa, 4.2 kgf/cm<sup>2</sup> or bar)</p> <p>Driving at high speeds (above 100 mph [160 km/h]) (in countries where such speeds are permitted by law)</p> <p>Add 8 psi (50 kPa, 0.5 kgf/cm<sup>2</sup> or bar) to the front and rear tires. Never exceed the maximum cold tire inflation pressure indicated on the tire sidewall.</p>
Wheel size	21 × 8J, 20 × 4T (spare)
Wheel bolt torque	103 ft•lbf (140 N•m, 14.3 kgf•m)

## ► Type E

Tire size	235/50R21 101W, T165/70D20 119M (spare)
Tire inflation pressure (Recommended cold tire inflation pressure)	<p>► Front 33 psi (230 kPa, 2.3 kgf/cm<sup>2</sup> or bar)</p> <p>► Rear 33 psi (230 kPa, 2.3 kgf/cm<sup>2</sup> or bar)</p> <p>► Spare 60 psi (420 kPa, 4.2 kgf/cm<sup>2</sup> or bar)</p> <p>Driving at high speeds (above 100 mph [160 km/h]) (in countries where such speeds are permitted by law)</p> <p>Add 6 psi (40 kPa, 0.4 kgf/cm<sup>2</sup> or bar) to the front and rear tires. Never exceed the maximum cold tire inflation pressure indicated on the tire sidewall.</p>
Wheel size	21 × 8J, 20 × 4T (spare)
Wheel bolt torque	103 ft•lbf (140 N•m, 14.3 kgf•m)

## Light bulbs

	Light bulbs	Bulb No.	W	Type
Exterior	Front turn signal lights (bulb type)	WY21W	21	A

A: Wedge base bulbs (amber)

## Fuel information

You must only use unleaded gasoline.

**RX350h:** Recommended to use premium unleaded gasoline with octane rating of 91 (Research Octane Number of 96) or higher for optimum engine performance. You may use unleaded gasoline with octane rating as low as 87 (Research Octane Number of 91). In this case, engine performance may be decreased. Use of octane rating unleaded gasoline with an octane rating lower than 87 may result in engine knocking. Persistent knocking can lead to engine damage.

**RX500h:** Select premium unleaded gasoline with an octane rating of 91 (Research Octane Number 96) or higher required for optimum engine performance and fuel economy. If the octane rating is less than 91, damage to the engine may occur and may void the vehicle warranty.

At minimum, the gasoline you use should meet the specifications of ASTM D4814 in the U.S.A.

### Gasoline quality

In very few cases, driveability problems may be caused by the brand of gasoline you are using. If driveability problems persist, try changing the brand of gasoline. If this does not correct the problem, consult your Lexus dealer.

### Recommendation of the use of gasoline containing detergent additives

- Lexus recommends the use of gasoline that contains detergent additives to avoid the build-up of engine deposits.
- All gasoline sold in the U.S.A. contains minimum detergent additives to clean and/or keep clean intake systems, per EPA's lowest additives concentration program.
- Lexus strongly recommends the use of Top Tier Detergent Gasoline. For more information on Top Tier Detergent Gasoline and a list of marketers, please go to the official website [www.toptiergas.com](http://www.toptiergas.com).

### Recommendation of the use of low emissions gasoline

Gasolines containing oxygenates such as ethers and ethanol, as well as reformulated gasolines, are available in some cities. These fuels are typically acceptable for use, providing they meet other fuel requirements.

Lexus recommends these fuels, since the formulations allow for reduced vehicle emissions.

### Non-recommendation of the use of blended gasoline

- Use only gasoline containing up to 15% ethanol.  
DO NOT use any flex-fuel or gasoline that could contain more than 15% ethanol, including from any pump labeled E30 (30% ethanol **[A]**), E50 (50% ethanol **[B]**), E85 (85% ethanol **[C]**) (which are only some examples of fuel containing more than 15% ethanol).

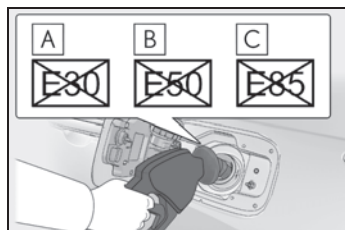

- **RX350h:** If you use gasohol in your vehicle, be sure that it has an octane rating no lower than 87.

- **RX500h:** If you use gasohol in your vehicle, be sure that it has an octane rating no lower than 91.
- Lexus does not recommend the use of gasoline containing methanol.
- **Non-recommendation of the use of gasoline containing MMT**

Some gasoline contains an octane enhancing additive called MMT (Methylcyclopentadienyl Manganese Tricarbonyl).

Lexus does not recommend the use of gasoline that contains MMT. If fuel containing MMT is used, your emission control system may be adversely affected.

The malfunction indicator lamp on the instrument cluster may come on. If this happens, contact your Lexus dealer for service.

#### ■ If your engine knocks

- Consult your Lexus dealer.
- You may occasionally notice light knocking for a short time while accelerating or driving uphill. This is normal and there is no need for concern.

#### ■ When refueling with gasohol

Take care not to spill gasohol. It can damage your vehicle's paint.

#### ■ Fuel-related poor driveability

If poor driveability (poor hot starting, vaporization, engine knocking, etc.) is encountered after using a different type of fuel, discontinue the use of that type of fuel.



#### NOTICE

##### ■ Notice on fuel quality

- Do not use improper fuels. If improper fuels are used, the engine will be damaged.
- Do not use leaded gasoline. Leaded gasoline can cause damage to your vehicle's three-way catalytic converters causing the emission control system to malfunction.
- Do not use gasohol other than the type previously stated. Other gasohol may cause fuel system damage or vehicle performance problems.
- Using unleaded gasoline with an octane number or rating lower than the level previously stated may cause persistent heavy knocking. At worst, this may lead to engine damage and will void the vehicle warranty.

## Tire information

### Typical tire symbols

#### ► Full-size tire

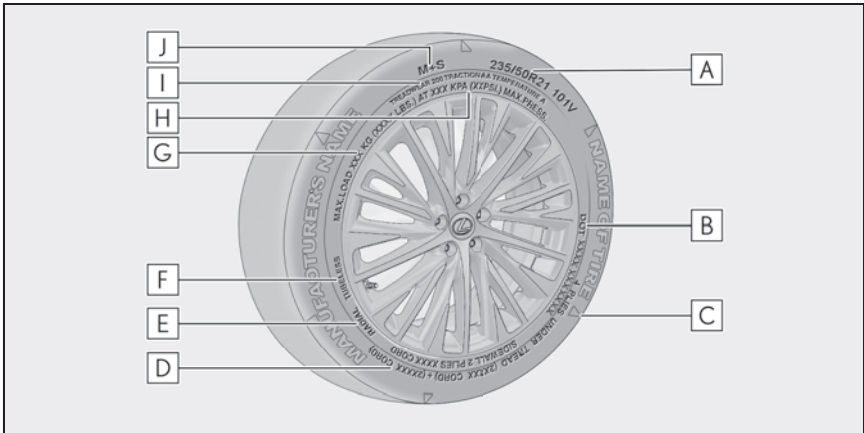

#### ► Compact spare tire

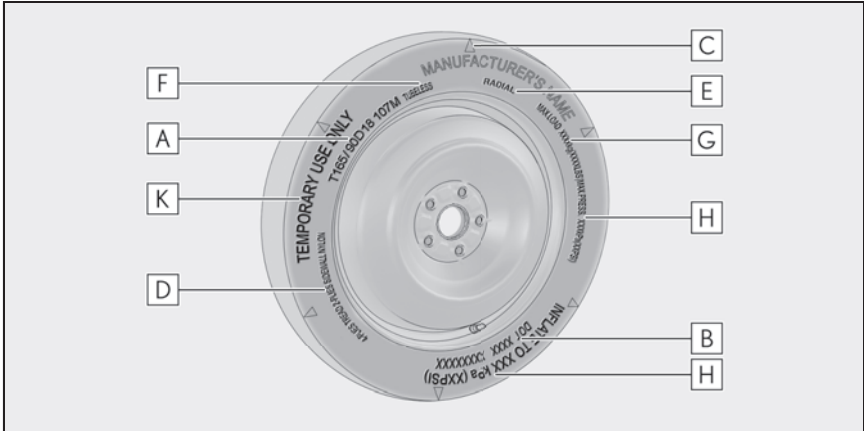

- A** Tire size (→P.583)
- B** DOT and Tire Identification Number (TIN) (→P.582)
- C** Location of treadwear indicators (→P.483)
- D** Tire ply composition and materials

Ply is layers of rubber-coated parallel cords. Cords are the strands which form the plies in a tire.

- E** Radial tires or bias-ply tires

A radial tire has "RADIAL" on the sidewall. A tire not marked "RADIAL" is a bias-ply tire.

**F** TUBELESS or TUBE TYPE

A tubeless tire does not have a tube and air is directly put into the tire. A tube type tire has a tube inside the tire and the tube maintains the air pressure.

**G** Load limit at maximum cold tire inflation pressure (→P.483)

**H** Maximum cold tire inflation pressure (→P.576)

This means the pressure to which a tire may be inflated.

**I** Uniform tire quality grading

For details, see "Uniform Tire Quality Grading" that follows.

**J** Summer tires or all season tires (→P.483)

An all season tire has "M+S" on the sidewall. A tire not marked "M+S" is a summer tire.

**K** "TEMPORARY USE ONLY"

A compact spare tire is identified by the phrase "TEMPORARY USE ONLY" molded on its sidewall. This tire is designed for temporary emergency use only.

### Typical DOT and Tire Identification Number (TIN)

► Type A

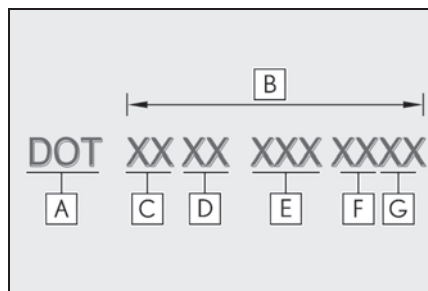

**A** DOT symbol\*

**B** Tire Identification Number (TIN)

**C** Tire manufacturer's identification mark

**D** Tire size code

**E** Manufacturer's optional tire type code (3 or 4 letters)

**F** Manufacturing week

**G** Manufacturing year

\*: The DOT symbol certifies that the tire conforms to applicable Federal Motor Vehicle Safety Standards.

► Type B

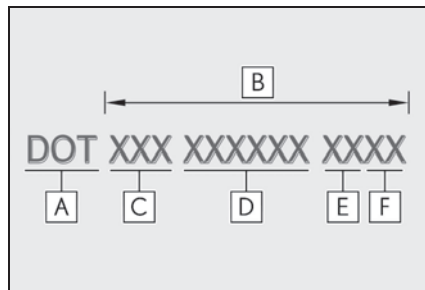

**A** DOT symbol\*

**B** Tire Identification Number (TIN)

**C** Tire manufacturer's identification mark

**D** Manufacturer's code

**E** Manufacturing week

**F** Manufacturing year

\*: The DOT symbol certifies that the tire conforms to applicable Federal Motor

Vehicle Safety Standards.

## Tire size

### ■ Typical tire size information

The illustration indicates typical tire size.

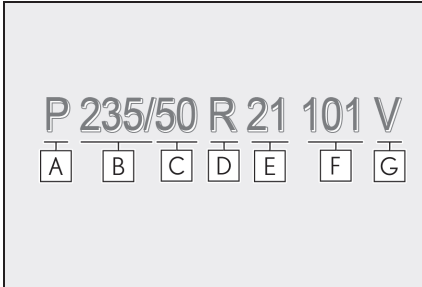

- A** Tire use (P = Passenger car, T = Temporary use)
- B** Section width (millimeters)
- C** Aspect ratio (tire height to section width)
- D** Tire construction code (R = Radial, D = Diagonal)
- E** Wheel diameter (inches)
- F** Load index (2 digits or 3 digits)
- G** Speed symbol (alphabet with one letter)

### ■ Tire dimensions

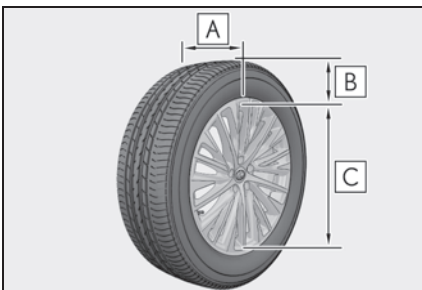

- A** Section width

- B** Tire height
- C** Wheel diameter

## Tire section names

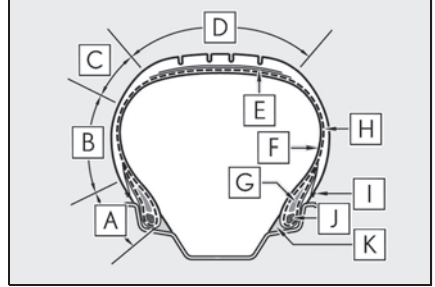

- A** Bead
- B** Sidewall
- C** Shoulder
- D** Tread
- E** Belt
- F** Inner liner
- G** Reinforcing rubber
- H** Carcass
- I** Rim lines
- J** Bead wires
- K** Chafer

## Uniform Tire Quality Grading

This information has been prepared in accordance with regulations issued by the National Highway Traffic Safety Administration of the U.S. Department of Transportation.

It provides the purchasers and/or prospective purchasers of Lexus vehicles with information on uniform tire quality grading.

Your Lexus dealer will help answer any questions you may have as you read this information.

### ■ DOT quality grades

All passenger vehicle tires must conform to Federal Safety Requirements in addition to these grades. Quality grades can be found where applicable on the tire sidewall between tread shoulder and maximum section width.

For example: Treadwear 200 Traction AA Temperature A

### ■ Treadwear

The treadwear grade is a comparative rating based on the wear rate of the tire when tested under controlled conditions on a specified government test course.

For example, a tire graded 150 would wear one and a half (1 - 1/2) times as well on the government course as a tire graded 100. The relative performance of tires depends upon the actual conditions of their use. Performance may differ significantly from the norm due to variations in driving habits, service practices and differences in road characteristics and climate.

### ■ Traction AA, A, B, C

The traction grades, from highest to lowest, are AA, A, B and C, and they represent the tire's ability to stop on wet pavement as measured under controlled conditions on specified government test surfaces of asphalt and concrete.

A tire marked C may have poor traction performance.

Warning: The traction grade assigned to this tire is based on braking (straight

ahead) traction tests and does not include cornering (turning) traction.

### ■ Temperature A, B, C

The temperature grades are A (the highest), B, and C, representing the tire's resistance to the generation of heat and its ability to dissipate heat when tested under controlled conditions on a specified indoor laboratory test wheel.

Sustained high temperature can cause the material of the tire to degenerate and reduce tire life, and excessive temperature can lead to sudden tire failure.

Grade C corresponds to a level of performance which all passenger car tires must meet under the Federal Motor Vehicle Safety Standard No. 109.

Grades B and A represent higher levels of performance on the laboratory test wheel than the minimum required by law.

Warning: The temperature grades of a tire assume that it is properly inflated and not overloaded.

Excessive speed, underinflation, or excessive loading, either separately or in combination, can cause heat buildup and possible tire failure.

## Glossary of tire terminology

Tire related term	Meaning
Cold tire inflation pressure	Tire pressure when the vehicle has been parked for three hours or more, or has not been driven more than 1 mile or 1.5 km under that condition
Maximum inflation pressure	The maximum cold inflated pressure to which a tire may be inflated, shown on the sidewall of the tire
Recommended inflation pressure	Cold tire inflation pressure recommended by a manufacturer
Accessory weight	The combined weight (in excess of those standard items which may be replaced) of hybrid transmission, power steering, power brakes, power windows, power seats, radio and heater, to the extent that these items are available as factory-installed equipment (whether installed or not)
Curb weight	The weight of a motor vehicle with standard equipment, including the maximum capacity of fuel, oil and coolant, and if so equipped, air conditioning and additional weight optional engine
Maximum loaded vehicle weight	The sum of: (a) Curb weight (b) Accessory weight (c) Vehicle capacity weight (d) Production options weight
Normal occupant weight	150 lb. (68 kg) times the number of occupants specified in the second column of Table 1* that follows
Occupant distribution	Distribution of occupants in a vehicle as specified in the third column of Table 1* below
Production options weight	The combined weight of installed regular production options weighing over 5 lb. (2.3 kg) in excess of the standard items which they replace, not previously considered in curb weight or accessory weight, including heavy duty brakes, ride levelers, roof rack, heavy duty 12-volt battery, and special trim

Tire related term	Meaning
Rim	A metal support for a tire or a tire and tube assembly upon which the tire beads are seated
Rim diameter (Wheel diameter)	Nominal diameter of the bead seat
Rim size designation	Rim diameter and width
Rim type designation	The industry manufacturer's designation for a rim by style or code
Rim width	Nominal distance between rim flanges
Vehicle capacity weight (Total load capacity)	The rated cargo and luggage load plus 150 lb. (68 kg) times the vehicle's designated seating capacity
Vehicle maximum load on the tire	The load on an individual tire that is determined by distributing to each axle its share of the maximum loaded vehicle weight, and dividing by two
Vehicle normal load on the tire	The load on an individual tire that is determined by distributing to each axle its share of curb weight, accessory weight, and normal occupant weight (distributed in accordance with Table 1* below), and dividing by two
Weather side	The surface area of the rim not covered by the inflated tire
Bead	The part of the tire that is made of steel wires, wrapped or reinforced by ply cords and that is shaped to fit the rim
Bead separation	A breakdown of the bond between components in the bead
Bias ply tire	A pneumatic tire in which the ply cords that extend to the beads are laid at alternate angles substantially less than 90 degrees to the centerline of the tread
Carcass	The tire structure, except tread and sidewall rubber which, when inflated, bears the load
Chunking	The breaking away of pieces of the tread or sidewall
Cord	The strands forming the plies in the tire
Cord separation	The parting of cords from adjacent rubber compounds

Tire related term	Meaning
Cracking	Any parting within the tread, sidewall, or innerliner of the tire extending to cord material
CT	A pneumatic tire with an inverted flange tire and rim system in which the rim is designed with rim flanges pointed radially inward and the tire is designed to fit on the underside of the rim in a manner that encloses the rim flanges inside the air cavity of the tire
Extra load tire	A tire designed to operate at higher loads and at higher inflation pressures than the corresponding standard tire
Groove	The space between two adjacent tread ribs
Innerliner	The layer(s) forming the inside surface of a tubeless tire that contains the inflating medium within the tire
Innerliner separation	The parting of the innerliner from cord material in the carcass
Intended outboard sidewall	(a) The sidewall that contains a whitewall, bears white lettering, or bears manufacturer, brand, and/or model name molding that is higher or deeper than the same molding on the other sidewall of the tire, or  (b) The outward facing sidewall of an asymmetrical tire that has a particular side that must always face outward when mounted on a vehicle
Light truck (LT) tire	A tire designated by its manufacturer as primarily intended for use on lightweight trucks or multipurpose passenger vehicles
Load rating	The maximum load that a tire is rated to carry for a given inflation pressure
Maximum load rating	The load rating for a tire at the maximum permissible inflation pressure for that tire
Maximum permissible inflation pressure	The maximum cold inflation pressure to which a tire may be inflated
Measuring rim	The rim on which a tire is fitted for physical dimension requirements
Open splice	Any parting at any junction of tread, sidewall, or innerliner that extends to cord material

Tire related term	Meaning
Outer diameter	The overall diameter of an inflated new tire
Overall width	The linear distance between the exteriors of the sidewalls of an inflated tire, including elevations due to labeling, decorations, or protective bands or ribs
Passenger car tire	A tire intended for use on passenger cars, multipurpose passenger vehicles, and trucks, that have a gross vehicle weight rating (GVWR) of 10,000 lb. or less.
Ply	A layer of rubber-coated parallel cords
Ply separation	A parting of rubber compound between adjacent plies
Pneumatic tire	A mechanical device made of rubber, chemicals, fabric and steel or other materials, that, when mounted on an automotive wheel, provides the traction and contains the gas or fluid that sustains the load
Radial ply tire	A pneumatic tire in which the ply cords that extend to the beads are laid at substantially 90 degrees to the centerline of the tread
Reinforced tire	A tire designed to operate at higher loads and at higher inflation pressures than the corresponding standard tire
Section width	The linear distance between the exteriors of the sidewalls of an inflated tire, excluding elevations due to labeling, decoration, or protective bands
Sidewall	That portion of a tire between the tread and bead
Sidewall separation	The parting of the rubber compound from the cord material in the sidewall
Snow tire	A tire that attains a traction index equal to or greater than 110, compared to the ASTM E-1136 Standard Reference Test Tire, when using the snow traction test as described in ASTM F-1805-00, Standard Test Method for Single Wheel Driving Traction in a Straight Line on Snow-and Ice-Covered Surfaces, and which is marked with an Alpine Symbol (  ) on at least one sidewall

Tire related term	Meaning
Test rim	The rim on which a tire is fitted for testing, and may be any rim listed as appropriate for use with that tire
Tread	That portion of a tire that comes into contact with the road
Tread rib	A tread section running circumferentially around a tire
Tread separation	Pulling away of the tread from the tire carcass
Treadwear indicators (TWI)	The projections within the principal grooves designed to give a visual indication of the degrees of wear of the tread
Wheel-holding fixture	The fixture used to hold the wheel and tire assembly securely during testing

\*: Table 1-Occupant loading and distribution for vehicle normal load for various designated seating capacities

Designated seating capacity, Number of occupants	Vehicle normal load, Number of occupants	Occupant distribution in a normally loaded vehicle
2 through 4	2	2 in front
5 through 10	3	2 in front, 1 in second seat
11 through 15	5	2 in front, 1 in second seat, 1 in third seat, 1 in fourth seat
16 through 20	7	2 in front, 2 in second seat, 2 in third seat, 1 in fourth seat

## Customizable features



Your vehicle includes a variety of electronic features that can be personalized to suit your preferences. The settings of these features can be changed by using the center display or at your Lexus dealer.

Some of the customizable features are changed in conjunction with the settings of My Settings. (→P.182)

## Customizing vehicle features

### ■ To change setting with

- 1 Select  on the center display.
- 2 Select “Vehicle customize” or “Driving assist”.
- 3 Select the item to change the settings of from the list.

For functions that can be turned on/off, select  (ON)/  (OFF).

For functions whose level can be adjusted, such as volume, sensor sensitivity, etc., slide the icon on the bar.

### ■ To change setting with

- 1 Select  on the center display.
- 2 Select “Driving assist”.

## Customizable Features

Some function settings are changed simultaneously with other functions being customized. Contact your Lexus dealer for further details.

- A** Settings that can be changed using the center display
- B** Settings that can be changed by your Lexus dealer

- 3 Select the item to change the settings of from the list.

Each time the switch is selected, the setting will be enabled/disabled.

When enabling is selected, the item display will be emphasized.

### ■ During customization

Stop the vehicle in a safe place, apply the parking brake, and shift the shift position to P. Also, to prevent 12-volt battery discharge, leave the hybrid system operating while customizing the features.

### ■ Using the icon

Some vehicle customize settings can also be changed through the  icon.

### WARNING

#### ■ During customization

As the hybrid system needs to be operating during customization, ensure that the vehicle is parked in a place with adequate ventilation. In a closed area such as a garage, exhaust gases including harmful carbon monoxide (CO) may collect and enter the vehicle. This may lead to death or a serious health hazard.

### NOTICE

#### ■ During customization

To prevent 12-volt battery discharge, ensure that the hybrid system is operating while customizing features.

Definition of symbols: ○ = Available, – = Not available

### ■ Gauges, meters and multi-information display (→P.86, 90, 104)

The language, units of measure, etc. of some items displayed on the meter or multi-information display will be changed according to settings on the center display. Refer to “MULTIMEDIA OWNER’S MANUAL”.

Function	Default setting	Customized setting	A	B
Meter display type *1	Type 1	Type 2	○	–
		Type 3		
Tachometer setting	Change according to driving mode	Always tachometer	○	–
		Always Hybrid System Indicator		
EV indicator *1	On	Off	○	–
Rev indicator *2	4000 rpm *3 5000 rpm *4	2000 - 6000 rpm *3	○	–
		2000 - 6200 rpm *4		
		Off		
Rev peak *2	On	Off	○	–
Suggestion function *1	On	On (when the vehicle is stopped)	○	–
		Off		
Stop light indicator	On	Off	○	–

\*1: This setting changes in accordance with My Settings

\*2: F SPORT models

\*3: RX350h

\*4: RX500h

### ■ Head-up Display \*1 (→P.101)

Function	Default setting	Customized setting	A	B
Head-up display *2	On	Off	○	–
Head-up display type *2	Standard	Full	○	–
		Minimum		

\*1: If equipped

\*2: This setting changes in accordance with My Settings

### ■ Steering wheel switches (vehicles with a head-up display) (→P.104)

Function	Default setting	Customized setting	A	B
Right steering wheel switch favorite functions*	Display control	Driving mode select switch	○	-
		Custom		
Left steering wheel switch favorite functions*	Audio	Climate	○	-
		Custom		
Switch sensor high sensitivity mode (winter glove mode)*	Off	On	○	-
Sensitivity for starting display	Standard	High	-	○
		OFF		
Time-out period	Standard	Short	-	○
		Long		

\*: This setting changes in accordance with My Settings

### ■ Door lock (→P.119, 549)

Function	Default setting	Customized setting	A	B
Door lockswitch indicatorillumination time	30 seconds	60 seconds	-	○
		600 seconds		
		1200 seconds		
Inside door opener switch operation adjustment (door opening function adjustment)	Short	Mid	-	○
		Long		
Multi-information display/buzzer operation when a door opener switch inside the vehicle is operated	On	Off	-	○

Function	Default setting	Customized setting	A	B
Inside/outside door opener switch operating method	Unlatch while Pushing switch	0.6 Seconds	-	○
		Operating from inside the cabin: 0.6 Seconds		
		Operating from outside: Unlatch while Pushing switch		
		Operating from inside the cabin: Unlatch while Pushing switch		
		Operating from outside: 0.6 Seconds		
Unlocking using a mechanical key	Driver's door unlocked in one step, all doors unlocked in two step	All doors unlocked in one step	-	○
Shift position linked door locking function*	On	Off	○	○
Automatic door unlocking function*	Shift position linked door unlocking operation	OFF	○	○
		Driver's door linked door unlocking operation		

\*: This setting changes in accordance with My Settings

### ■ Power back door (→P.124)

Function	Default setting	Customized setting	A	B
Power back door	On	Off	○	-
Power back door opening position	5	1 to 5	○	-
		User setting* <sup>1</sup>		
Buzzer volume	Level 3	Level 1	○	-
		Level 2		
Kick sensor* <sup>2</sup>	On	Off	○	-
Kick operation buzzer* <sup>2</sup>	Off	On	-	○

Function	Default setting	Customized setting	A	B
The function that validates the  switch of the wireless remote control when locking the door	On	Off	-	<input type="radio"/>
Close & lock (walk away) function	On	Off	-	<input type="radio"/>
Hands free close & lock function <sup>*2</sup>	Off	On	-	<input type="radio"/>

<sup>\*1</sup>: Configured by operating the  switch of the lower back door.

<sup>\*2</sup>: If equipped

### ■ Smart access system with push-button start and wireless remote control (→P.119, 139)

Function	Default setting	Customized setting	A	B
Operation buzzer volume <sup>*</sup>	5	Off	<input type="radio"/>	<input type="radio"/>
		1 to 7		
Operation signal (Emergency flashers) <sup>*</sup>	On	Off	<input type="radio"/>	<input type="radio"/>
Time elapsed before automatic door lock function is activated if door is not opened after being unlocked <sup>*</sup>	60 seconds	Off	<input type="radio"/>	<input type="radio"/>
		30 seconds		
		120 seconds		
Open door warning buzzer	On	Off	-	<input type="radio"/>

<sup>\*</sup>: This setting changes in accordance with My Settings

### ■ Smart access system with push-button start (→P.119, 139)

Function	Default setting	Customized setting	A	B
Smart access system with push-button start	On	Off	<input type="radio"/>	-
The doors that are unlocked using the smart access system with push-button start can be selected	Driver's door	All the doors	<input type="radio"/>	<input type="radio"/>

Function	Default setting	Customized setting	A	B
Number of consecutive door lock operations	2 times	As many as desired	–	○
Time elapsed before unlocking all the door when gripping and holding the driver's door handle	2 seconds	Off	–	○
		1.5 seconds		
		2.5 seconds		

### ■ Wireless remote control (→P.114, 119, 124)

Function	Default setting	Customized setting	A	B
Unlocking operation *	Driver's door unlocked in one step, all doors unlocked in two step	All doors unlocked in one step	○	○
Panic function	On	Off	–	○
Power back door unlocking operation	Press and hold (short)	One short press	–	○
		Push twice		
		Press and hold (long)		
		Off		
Locking operation when door opened*	On	Off	○	○

\* : This setting changes in accordance with My Settings

### ■ Driving position memory\*<sup>1</sup> (→P.178)

Function	Default setting	Customized setting	A	B
Driver's seat movement when exiting the vehicle* <sup>2</sup>	Standard	Off	○	○
		Partial		
Driver's seat upward movement when exiting the vehicle* <sup>2</sup>	Standard	Off	○	○
		Partial		
Steering wheel movement	Tilt only	Telescopic only	○	–
		Tilt and telescopic		
		Off		

\*<sup>1</sup>: If equipped

\*2: This setting changes in accordance with My Settings

### ■ Outside rear view mirrors (→P.166)

Function	Default setting	Customized setting	A	B
Automatic mirror folding and extending operation	Linked to the locking/unlocking of the doors	Off	-	○
		Linked to operation of the power switch		

### ■ Power windows, and moon roof\* or panoramic moon roof\* (→P.169, 171, 174)

Function	Default setting	Customized setting	A	B
Mechanical key linked operation	Off	On	-	○
Wireless remote control linked operation	Off	On (open only)	-	○

\*: If equipped

### ■ Moon roof\* or panoramic moon roof\* (→P.171, 174)

Function	Default setting	Customized setting	A	B
Linked operation of components when mechanical key is used (open only)	Slide only	Tilt only	-	○
Linked operation of components when wireless remote control is used	Slide only	Tilt only	-	○

\*: If equipped

### ■ Automatic light control system (→P.232)

Function	Default setting	Customized setting	A	B
Light sensor sensitivity*	Standard	-2 to 2	○	○
Time elapsed before headlights automatically turn off after doors are closed*	30 seconds	Off	○	○
		60 seconds		
		90 seconds		
Windshield wiper linked headlight illumination	On	Off	-	○

\*: This setting changes in accordance with My Settings

### ■ Lights (→P.232)

Function	Default setting	Customized setting	A	B
Daytime running lights * <sup>1</sup>	On	Off * <sup>2</sup>	<input type="radio"/>	–
Welcome lighting	On	Off	–	<input type="radio"/>

\*<sup>1</sup>: This setting changes in accordance with My Settings

\*<sup>2</sup>: Except for Canada

### ■ Adaptive High-beam System \*<sup>1</sup> (→P.234)

Function	Customized setting	A	B
Adaptive High-beam System	ON/OFF * <sup>2</sup>	–	<input type="radio"/>
Brightness and illuminated area adjustment of the high beams according to the vehicle speed	9 mph (15 km/h) / 19 mph (30 km/h) / 50 mph (80 km/h)	–	<input type="radio"/>
Projection distance adjustment of the low beams according to the distance to a preceding vehicle	ON/OFF	–	<input type="radio"/>
Upper level high beam light distribution control	ON/OFF	–	<input type="radio"/>

\*<sup>1</sup>: If equipped

\*<sup>2</sup>: The headlights will operate under Automatic High Beam control. (→P.237)

### ■ Pre-Collision System (→P.261)

Function	Customized setting	A	B
Pre-Collision System	ON/OFF	<input type="radio"/>	–
Warning timing *	Later/Default/Earlier	<input type="radio"/>	–

\*: This setting changes in accordance with My Settings

### ■ Front Cross Traffic Alert \*<sup>1</sup> (→P.290)

Function	Customized setting	A	B
Front Cross Traffic Alert	ON/OFF	<input type="radio"/>	–
Alert timing * <sup>2</sup>	Later/Default/Earlier	<input type="radio"/>	–

\*<sup>1</sup>: If equipped

\*2: This setting changes in accordance with My Settings

### ■ Lane Departure Alert system (→P.279)

Function	Customized setting	A	B
Lane Departure Alert system *	ON/OFF	<input type="radio"/>	–
Alert timing *	Default/Earlier	<input type="radio"/>	–
Alert options *	Vibration/Audible	<input type="radio"/>	–

\*: This setting changes in accordance with My Settings

### ■ Lane Change Assist<sup>\*1</sup> (→P.276)

Function	Customized setting	A	B
Lane Change Assist <sup>*2</sup>	ON/OFF	<input type="radio"/>	–

\*1: If equipped

\*2: This setting changes in accordance with My Settings

### ■ Dynamic Radar Cruise Control (→P.295)

Function	Customized setting	A	B
Extended Resume Time *	ON/OFF	<input type="radio"/>	–
Acceleration setting *	High/Mid/Low	<input type="radio"/>	–
Guide message *	ON/OFF	<input type="radio"/>	–
Curve speed reduction *	High/Mid/Low/OFF	<input type="radio"/>	–

\*: This setting changes in accordance with My Settings

### ■ Proactive Driving Assist (→P.285)

Function	Customized setting	A	B
Proactive Driving Assist *	ON/OFF	<input type="radio"/>	–
Support sensitivity *	Low/Mid/High	<input type="radio"/>	–
Steering Assist *	ON/OFF	<input type="radio"/>	–
Deceleration Assist *	ON/OFF	<input type="radio"/>	–
Obstacle Anticipation Assist *	ON/OFF	<input type="radio"/>	–

\*: This setting changes in accordance with My Settings

### ■ Road Sign Assist<sup>\*1</sup>(→P.293)

Function	Customized setting	A	B
Road Sign Assist <sup>*2</sup>	ON/OFF	<input type="radio"/>	–
Excess speed notification method <sup>*2</sup>	None/Visual/Visual and Audible	<input type="radio"/>	–
Other notifications method <sup>*2</sup>	None/Visual/Visual and Audible	<input type="radio"/>	–
Excess speed notification level <sup>*2</sup>	5 mph (10 km/h) / 3 mph (5 km/h) / 1 mph (2 km/h)	<input type="radio"/>	–

\*1: If equipped

\*2: This setting changes in accordance with My Settings

### ■ Driver break suggestion (→P.281)

Function	Customized setting	A	B
Driver break suggestion	ON/OFF	<input type="radio"/>	–

### ■ Traffic Jam Assist<sup>\*1</sup>(→P.313)

Function	Customized setting	A	B
Traffic Jam Assist <sup>*2</sup>	ON/OFF	<input type="radio"/>	–
Driver Monitor Camera Recording <sup>*2</sup>	ON/OFF	<input type="radio"/>	–

\*1: If equipped

\*2: This setting changes in accordance with My Settings

### ■ Driver monitor<sup>\*1</sup>(→P.259)

Function	Customized setting	A	B
Warning function <sup>*2</sup>	ON/OFF	<input type="radio"/>	–

\*1: If equipped

\*2: This setting changes in accordance with My Settings

### ■ BSM (Blind Spot Monitor) (→P.319)

Function	Default setting	Customized setting	A	B
BSM (Blind Spot Monitor)	On	Off	<input type="radio"/>	—
Outside rear view mirror indicator brightness *	Bright	Dim	<input type="radio"/>	—
Alert timing for presence of approaching vehicle (sensitivity) *	Intermediate	Early	<input type="radio"/>	—
		Late		
Buzzer warning *	ON	OFF	<input type="radio"/>	—

\*: This setting changes in accordance with My Settings

### ■ Intuitive parking assist \*1 (→P.328)

Function	Default setting	Customized setting	A	B
Intuitive parking assist *2	ON	OFF	<input type="radio"/>	—
Buzzer volume of Intuitive parking assist when operating *2,3	Level 2	Level 1	<input type="radio"/>	<input type="radio"/>
		Level 3		

\*1: If equipped

\*2: This setting changes in accordance with My Settings

\*3: The sound volume is linked among the intuitive parking assist, RCTA, and RCD.

### ■ RCTA (Rear cross traffic alert) function (→P.337)

Function	Default setting	Customized setting	A	B
RCTA (Rear cross traffic alert) function	On	Off	<input type="radio"/>	—
Buzzer volume of RCTA when operating *1,2	Level 2	Level 1	<input type="radio"/>	—
		Level 3		

\*1: The sound volume is linked among the intuitive parking assist, RCTA, and RCD.

\*2: This setting changes in accordance with My Settings

### ■ RCD (Rear Camera Detection) function\* (→P.342)

Function	Default setting	Customized setting	A	B
RCD (Rear Camera Detection) function	On	Off	<input type="radio"/>	–

\*: If equipped

### ■ PKSB (Parking Support Brake)<sup>\*1</sup> (→P.345)

Function	Default setting	Customized setting	A	B
PKSB (Parking Support Brake) function <sup>*2</sup>	On	Off	<input type="radio"/>	–

<sup>\*1</sup>: If equipped

<sup>\*2</sup>: This setting changes in accordance with My Settings

### ■ Lexus Teammate Advanced Park<sup>\*1,2</sup> (→P.356)

Function	Default setting	Customized setting	A	B
Remote Park <sup>*1</sup>	On	Off	<input type="radio"/>	–
Vehicle speed during operation	Normal	Slow	<input type="radio"/>	–
		Fast		
Distance to objects	Normal	Far	<input type="radio"/>	–
Preferred parking method	Parallel	Perpendicular	<input type="radio"/>	–
Preferred parking direction	Forward	Reverse	<input type="radio"/>	–
Preferred exit direction (perpendicular)	Right	Left	<input type="radio"/>	–
Preferred exit direction (parallel)	Left	Right	<input type="radio"/>	–
Camera view when parking	Normal	Wide	<input type="radio"/>	–
Camera view when exiting	Wide	Normal	<input type="radio"/>	–
Parking path adjustment	0 (Centered)	-3 (Inward) to 3 (Outward)	<input type="radio"/>	–
Road width adjustment	Normal	Slightly narrow	<input type="radio"/>	–
		Narrow		

Function	Default setting	Customized setting	A	B
Park position adjustment (forward)	0 (Centered)	-3 (Rearward) to 3 (Frontward)	<input type="radio"/>	-
Park position adjustment (reverse)	0 (Centered)	-3 (Rearward) to 3 (Frontward)	<input type="radio"/>	-
Rear accessory setting	Off	3.9 in. (10 cm)	<input type="radio"/>	-
		7.9 in. (20 cm)		
		11.8 in. (30 cm)		
		15.7 in. (40 cm)		
Clear registered parking space	-	-	<input type="radio"/>	-

\*1: If equipped

\*2: This settings can be changed on the Advanced Park guidance screen. (→P.365)

### ■ Safe Exit Assist (→P.323)

Function	Default setting	Customized setting	A	B
Safe Exit Assist	On	Off	<input type="radio"/>	-
Outside rear view mirrors display*	On	Off	<input type="radio"/>	-
Detection sensitivity*	Middle	High	<input type="radio"/>	-
		Low		

\*: This setting changes in accordance with My Settings

### ■ ASC (Active Sound Control) (RX500h) (→P.231)

Function	Default setting	Customized setting	A	B
ASC (Active Sound Control) volume	Medium	High	<input type="radio"/>	-
		Low		
		Off		

### ■ Driving mode select switch (→P.390)

Function	Default setting	Customized setting	A	B
Powertrain control in customized mode	Normal	Power	<input type="radio"/>	-
		Eco		

Function	Default setting	Customized setting	A	B
Steering control in customized mode	Normal	Sport	<input type="radio"/>	–
Suspension control in customized mode*	Normal	Sport	<input type="radio"/>	–
Air conditioning operation in customized mode	Normal	Eco	<input type="radio"/>	–

\*: If equipped

### ■ Power switch (→P.208)

Function	Customized setting	A	B
ACC customization Enabling/Disabling ACC mode	On/Off	<input type="radio"/>	<input type="radio"/>

### ■ Rear seat reminder (→P.121)

Function	Default setting	Customized setting	A	B
Rear seat reminder function*	On	Off	<input type="radio"/>	–

\*: This setting changes in accordance with My Settings

### ■ Front automatic air conditioning system (→P.411)

Function	Default setting	Customized setting	A	B
Switching between outside air and recirculated air mode linked to "AUTO" switch operation* <sup>1</sup>	On	Off	<input type="radio"/>	<input type="radio"/>
A/C auto switch operation* <sup>1</sup>	On	Off	<input type="radio"/>	<input type="radio"/>
Exhaust gas sensor sensitivity* <sup>1</sup> , * <sup>2</sup>	Standard	-3 to 3	<input type="radio"/>	<input type="radio"/>
		Off		

\*<sup>1</sup>: This setting changes in accordance with My Settings

\*<sup>2</sup>: If equipped

### ■ Seat heaters/seat ventilators <sup>\*1</sup>(→P.422)

Function	Default setting	Customized setting	A	B
Driver's seat temperature preference in automatic mode <sup>*2</sup>	Standard	-2 (cooler) to 2 (warmer)	<input type="radio"/>	<input type="radio"/>
Front passenger's seat temperature preference in automatic mode <sup>*2</sup>	Standard	-2 (cooler) to 2 (warmer)	<input type="radio"/>	<input type="radio"/>

<sup>\*1</sup>: If equipped

<sup>\*2</sup>: This setting changes in accordance with My Settings

### ■ Heated steering wheel <sup>\*1</sup>(→P.422)

Function	Default setting	Customized setting	A	B
Steering wheel heating preference in automatic mode <sup>*2</sup>	Standard	-2 (low) to 2 (high)	<input type="radio"/>	<input type="radio"/>

<sup>\*1</sup>: If equipped

<sup>\*2</sup>: This setting changes in accordance with My Settings

### ■ Illumination (→P.424)

Function	Default setting	Customized setting	A	B
Time elapsed before the interior lights turn off <sup>*1</sup>	15 seconds	Off	<input type="radio"/>	-
		7.5 seconds		
		30 seconds		
Operation after the power switch is turned off	On	Off	-	<input type="radio"/>
Operation when you approach the vehicle with the electronic key on your person	On	Off	-	<input type="radio"/>
Operation when the doors are unlocked	On	Off	-	<input type="radio"/>
Footwell lights	On	Off	-	<input type="radio"/>
Door-trim ornament lights <sup>*2</sup> , inside handle lights and front tray light	On	Off	-	<input type="radio"/>

Function	Default setting	Customized setting	A	B
Time elapsed before the outer foot lights turn off <sup>*1</sup>	15 seconds	Off	○	-
		7.5 seconds		
		30 seconds		
Operation of the outer foot lights when you approach the vehicle with the electronic key on your person	On	Off	-	○
Operation of the outer foot lights when the doors are unlocked	On	Off	-	○
Operation of the outer foot lights when a door is opened	On	Off	-	○
Fading out of the outer foot lights when they turn off	Long	Short	-	○
Operation of interior lights and outer foot lights after the doors are locked	On	Off	-	○
Color selection <sup>*1,2</sup>	Silky white	Custom	○	-
Brightness control <sup>*1</sup>	5	9 to 1	○	-
		Off		

<sup>\*1</sup>: This setting changes in accordance with My Settings

<sup>\*2</sup>: If equipped

### ■ Vehicle customization

- When the doors remain closed after unlocking the doors and the timer activated automatic door lock function activates, signals will be generated in accordance with the operation buzzer volume and operational signal (Emergency flashers) function settings.

## Items to initialize

The following items must be initialized for normal system operation after such cases as the 12-volt battery being reconnected, or maintenance being performed on the vehicle:

### List of items to initialize

Item	When to initialize	Reference
Message indicating maintenance is required (U.S.A. only)	<ul style="list-style-type: none"> <li>• After the maintenance is performed</li> </ul>	P.464
Tire pressure warning system	<ul style="list-style-type: none"> <li>• When the specified tire inflation pressure has changed, such as due to carried load, etc.</li> <li>• When the tire inflation pressure is changed such as when the tire size is changed.</li> </ul>	P.488
Oil maintenance	<ul style="list-style-type: none"> <li>• After the maintenance is performed</li> </ul>	P.476
Power back door	<ul style="list-style-type: none"> <li>• After reconnecting or changing the 12-volt battery</li> </ul>	P.134

**9-1. For owners**

- Reporting safety defects for U.S. owners ..... **608**
- Reporting safety defects for Canadian owners ..... **608**
- Seat belt instructions for Canadian owners (in French) ..... **609**
- SRS airbag instructions for Canadian owners (in French) ..... **610**
- Headlight aim instructions for Canadian owners (in French) ..... **615**

## Reporting safety defects for U.S. owners

If you believe that your vehicle has a defect which could cause a crash or could cause injury or death, you should immediately inform the National Highway Traffic Safety Administration (NHTSA) in addition to notifying the Lexus Division of Toyota Motor Sales, U.S.A., Inc. (Toll-free: 1-800-25-LEXUS).

If NHTSA receives similar complaints, it may open an investigation, and if it finds that a safety defect exists in a group of vehicles, it may order a recall and remedy campaign. However, NHTSA cannot become involved in individual problems between you, your dealer, or Lexus Division of Toyota Motor Sales, U.S.A., Inc.

To contact NHTSA, you may call the Vehicle Safety Hotline toll-free at 1-888-327-4236 (TTY: 1-800-424-9153); go to <http://www.safercar.gov>; or write to: Administrator, NHTSA, 1200 New Jersey Ave. SE., Washington, DC 20590. You can also obtain other information about motor vehicle safety from <http://www.safercar.gov>.

## Reporting safety defects for Canadian owners

Canadian customers who wish to report a safety-related defect to Transport Canada, Defects Investigations and Recalls, may telephone the toll-free hotline 1-800-333-0510, mail Transport Canada - ASFAD, 330 Sparks Street, Ottawa, ON, K1A 0N5, or complete the online form at <https://www.tc.gc.ca/recalls>.

## Seat belt instructions for Canadian owners (in French)

The following is a French explanation of seat belt instructions extracted from the seat belt section in this manual.

See the seat belt section for more detailed seat belt instructions in English.

### Utilisation correcte des ceintures de sécurité



- Déroulez la sangle diagonale de telle sorte qu'elle passe bien sur l'épaule, sans pour autant être en contact avec le cou ou glisser de l'épaule.
- Placez la sangle abdominale le plus bas possible sur les hanches.
- Réglez la position du dossier de siège. Asseyez-vous le dos droit et caliez-vous bien dans le siège.
- Ne vrillez pas la ceinture de sécurité.

## Entretien et soin

### ■ Traitement des ceintures de sécurité

Nettoyez avec un chiffon ou une éponge humidifiés avec de l'eau savonneuse tiède. Vérifiez régulièrement que les ceintures ne sont pas usées, effilochées ou entaillées excessivement.



### AVERTISSEMENT

#### ■ Détérioration et usure des ceintures de sécurité

Inspectez le système de ceintures de sécurité régulièrement. Contrôlez l'absence de coupures, d'effilochages et de pièces desserrées. N'utilisez pas une ceinture de sécurité endommagée avant qu'elle ne soit remplacée. Une ceinture de sécurité endommagée ne permet pas de protéger un occupant de blessures graves ou mortelles.

## SRS airbag instructions for Canadian owners (in French)

The following is a French explanation of SRS airbag instructions extracted from the SRS airbag section in this manual.

See the SRS airbag section for more detailed SRS airbag instructions in English.

### Système de coussins gonflables SRS

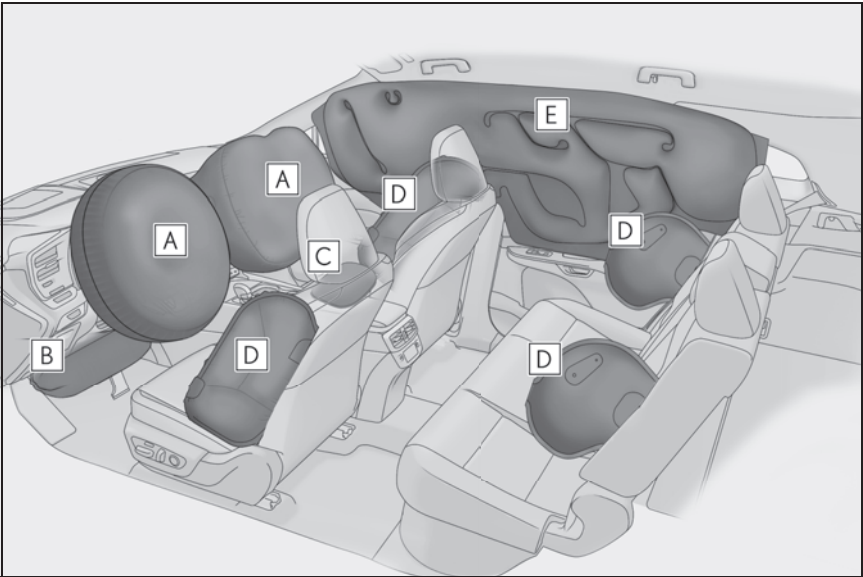

**A** Coussin gonflable conducteur/coussin gonflable du passager avant SRS

Contribuent à réduire l'impact au niveau de la tête et du thorax du conducteur et du passager avant

**B** Coussin gonflable de genoux SRS

Contribue à réduire l'impact subi par le conducteur

**C** Coussins gonflables de coussin de siège SRS

- Contribue à réduire l'impact subi par le passager avant

**D** Coussins gonflables latéraux SRS

- Contribuent à réduire l'impact au niveau du thorax des occupants des sièges avant
- Contribuent à réduire l'impact au niveau du thorax des occupants des sièges arrière latéraux

**E** Coussins gonflables rideaux SRS

- Contribuent à réduire l'impact au niveau de la tête des occupants des sièges avant et des sièges arrière latéraux

- Peut contribuer à empêcher les occupants d'être éjectés du véhicule en cas de tonneau

Votre véhicule est équipé de COUSSINS GONFLABLES INTELLIGENTS conçus selon les normes de sécurité américaines applicables aux véhicules à moteur (FMVSS208). L'ensemble des capteurs de coussins gonflables (ECU) régule le déploiement des coussins gonflables sur la base des informations qu'il reçoit des capteurs, etc., indiqués ci-dessus dans le schéma illustrant les composants du système. Parmi ces informations figurent la gravité du choc et l'occupation du véhicule par les passagers. Le déploiement rapide des coussins gonflables est obtenu au moyen d'une réaction chimique dans les dispositifs pyrotechniques, qui produit un gaz inoffensif permettant d'amortir le mouvement des occupants.



### AVERTISSEMENT

#### ■ Précautions relatives aux coussins gonflables SRS

Respectez les précautions suivantes. Le non-respect de ces précautions peut occasionner des blessures graves, voire mortelles.

- Le conducteur et tous les passagers doivent porter correctement leur ceinture de sécurité. Les coussins gonflables SRS sont des dispositifs supplémentaires à utiliser avec les ceintures de sécurité.

- Le coussin gonflable conducteur SRS se déploie avec une force considérable et peut occasionner des blessures graves, voire mortelles, tout particulièrement si le conducteur se trouve très près du coussin gonflable. L'autorité fédérale chargée de la sécurité routière aux États-Unis (NHTSA) conseille:

La zone à risque du coussin gonflable conducteur se situant dans les premiers 2 à 3 in. (50 à 75 mm) de déploiement, vous placer à 10 in. (250 mm) de votre coussin gonflable conducteur vous garantit une marge de sécurité suffisante. Cette distance est à mesurer entre le centre du volant et le sternum. Si votre position de conduite actuelle vous place à moins de 10 in. (250 mm) du coussin gonflable conducteur, vous pouvez changer votre position de conduite de plusieurs façons:

- Reculez votre siège le plus possible, de manière à pouvoir encore atteindre confortablement les pédales.

## ⚠ AVERTISSEMENT

- Inclinez légèrement le dossier de siège. Bien que les véhicules aient une conception différente, un grand nombre de conducteurs peuvent s'asseoir à une distance de 10 in. (251 mm), même avec le siège conducteur complètement avancé, simplement en inclinant un peu le dossier de siège. Si vous avez des difficultés à voir la route après avoir incliné le dossier de votre siège, utilisez un coussin ferme et antidérapant pour vous rehausser ou remontez le siège si votre véhicule est équipé de cette fonction.
- Si votre volant est réglable, inclinez-le vers le bas. Cela a pour effet d'orienter le coussin gonflable en direction de votre poitrine plutôt que de votre tête et de votre cou. Réglez votre siège selon les recommandations de la NHTSA, tout en conservant le contrôle du véhicule avec les pédales et le volant, et en préservant la vue des commandes du tableau de bord.
- Si vous attachez une rallonge de ceinture de sécurité à une boucle de ceinture de sécurité du passager avant sans l'attacher au pêne de la ceinture de sécurité, le système de coussins gonflables SRS détermine que le passager avant a attaché sa ceinture de sécurité, bien que la ceinture de sécurité ne soit pas bouclée. Dans ce cas, les coussins gonflables frontaux SRS du passager avant peuvent ne pas se déployer correctement lors d'une collision, pouvant occasionner des blessures graves, voire mortelles. Veillez à porter la ceinture de sécurité correctement en cas d'utilisation d'une rallonge de ceinture de sécurité.



- Le coussin gonflable frontal SRS se déploie avec une force considérable et peut occasionner des blessures graves, voire mortelles, tout particulièrement si le passager avant se trouve très près du coussin gonflable. Le siège du passager avant doit être éloigné le plus possible du coussin gonflable, avec le dossier réglé de façon à ce que le passager avant soit assis bien droit dans le siège.
- Les nourrissons et les enfants qui ne sont pas correctement assis et/ou attachés peuvent être grièvement blessés ou tués par le déploiement d'un coussin gonflable. Un nourrisson ou un enfant trop petit pour utiliser une ceinture de sécurité doit être correctement attaché au moyen d'un siège de sécurité enfant. Lexus recommande vivement d'installer tous les nourrissons et enfants sur les sièges arrière du véhicule et de prévoir pour eux des systèmes de retenue adaptés. Les sièges arrière sont plus sûrs pour les nourrissons et les enfants que le siège du passager avant. (→P.45)
- Ne vous asseyez pas sur le bord du siège et ne vous appuyez pas contre la planche de bord.

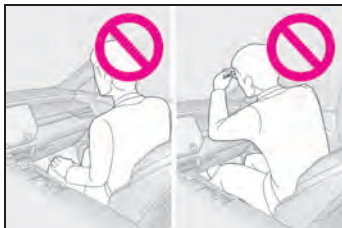

- Ne laissez pas un enfant rester debout devant le coussin gonflable passager avant SRS ou s'asseoir sur les genoux du passager avant.

## ⚠ AVERTISSEMENT

- Les occupants des sièges avant ne doivent en aucun cas tenir d'objets sur leurs genoux.



- Ne vous appuyez pas contre la porte, le rail latéral de toit ou les montants avant, latéraux ou arrière.



- Ne laissez personne s'agenouiller sur un siège en appui contre la porte ou sortir la tête ou les mains à l'extérieur du véhicule.



- Ne fixez rien et ne posez rien sur des emplacements tels que la planche de bord, la garniture du volant et la partie inférieure du tableau de bord.



- Ne fixez rien à des emplacements tels que les portes, la vitre du pare-brise, les vitres latérales, les montants avant ou arrière, des rails latéraux de toit et des poignées de maintien.



- Ne suspendez aucun cintre ou objet dur aux crochets à vêtements. Ces éléments peuvent se transformer en projectiles si les coussins gonflables rideaux SRS se déploient, le choc pouvant entraîner des blessures graves, voire mortelles.
- Si un cache en vinyle est fixé sur la zone où le coussin gonflable de genoux SRS se déploie, veillez à le retirer.



## AVERTISSEMENT

- N'utilisez aucun accessoire de siège recouvrant les zones de déploiement des coussins gonflables SRS, car il risque de gêner le déploiement des coussins gonflables SRS. De tels accessoires peuvent empêcher les coussins gonflables SRS de se déployer correctement, peuvent désactiver le système ou entraîner le déploiement involontaire des coussins gonflables SRS, ce qui peut éventuellement occasionner des blessures graves, voire mortelles.
- Évitez de faire subir des chocs ou des pressions excessives aux composants des systèmes de coussins gonflables SRS, aux portes avant ou à leur zone adjacente.  
En effet, cela pourrait entraîner un dysfonctionnement des coussins gonflables SRS.
- Ne touchez aucun composant des coussins gonflables SRS immédiatement après leur déploiement (gonflage), car ils peuvent être chauds.
- Si vous avez des difficultés à respirer après le déploiement des coussins gonflables SRS, ouvrez une porte ou une vitre pour faire entrer de l'air frais, ou bien descendez du véhicule si cela ne présente pas de danger. Essayez tout résidu dès que possible afin d'éviter d'éventuelles irritations de la peau.
- Si une zone renfermant un coussin gonflable SRS est endommagée ou craquelée, faites-la remplacer par votre concessionnaire Lexus.

- Ne placez rien sur le siège du passager avant, comme un coussin par exemple. Cela a pour conséquence de répartir le poids du passager sur toute la surface du siège, ce qui empêche le capteur de détecter correctement le poids du passager. En conséquence, les coussins gonflables frontaux SRS du siège du passager avant risquent de ne pas se déployer en cas de collision.

## ■ Modification et mise au rebut des composants du système de coussins gonflables SRS

Ne mettez pas votre véhicule au rebut et ne procédez à aucune des modifications suivantes sans consulter votre concessionnaire Lexus. Les coussins gonflables SRS peuvent ne pas fonctionner correctement ou se déployer involontairement, ce qui peut provoquer des blessures graves, voire mortelles.

- Dépose, repose, démontage ou réparation des coussins gonflables SRS
- Réparation, dépose ou modification des pièces suivantes ou de leurs alentours
  - Volant
  - Tableau de bord
  - Planche de bord
  - Sièges
  - Garnissage des sièges
  - Montants avant
  - Montants latéraux
  - Montants arrière
  - Rails latéraux de toit
  - Panneaux de portes avant
  - Garniture de porte avant
  - Haut-parleurs de porte avant



## AVERTISSEMENT

- Modifications des panneaux de portes avant (par exemple, perçage de trous dans les panneaux)
- Réparation ou modification des pièces suivantes ou de leurs alentours
  - Aile avant
  - Pare-chocs avant
  - Côtés de l'intérieur du véhicule
- Installation des pièces suivantes ou accessoires
  - Pare-buffle ou pare-kangourou
  - Chasse-neige
  - Treuils
  - Porte-bagages de toit
- Modifications de la suspension du véhicule
- Installation d'appareils électroniques tels que les émetteurs/récepteurs radios mobiles et les lecteurs CD
- Modifications apportées à votre véhicule pour les personnes atteintes d'un handicap physique

## Headlight aim instructions for Canadian owners (in French)

The following is a French explanation of headlight aim instructions from the headlight aim section in this manual.

### Boulons de réglage du mouvement vertical

- Véhicules sans phares à faisceau unique

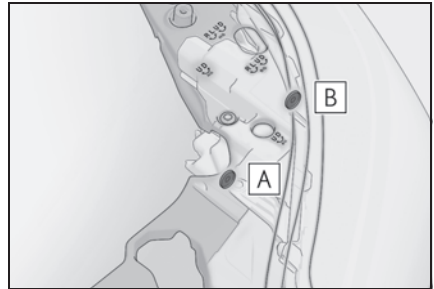

**A** Boulon de réglage A

**B** Boulon de réglage B

- Véhicules avec phares à faisceau unique

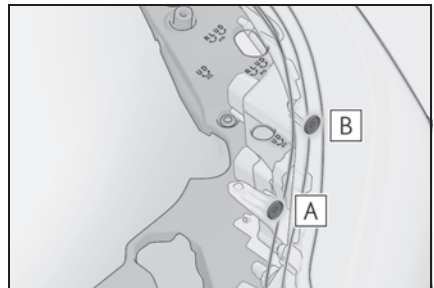

**A** Boulon de réglage A

**B** Boulon de réglage B

## Avant de vérifier le réglage des phares

- 1 Vérifiez que le réservoir de carburant du véhicule est plein et que la zone autour des phares n'est pas déformée.
- 2 Stationnez le véhicule sur une surface plane.
- 3 Installez-vous dans le siège conducteur.
- 4 Balancez le véhicule plusieurs fois.

## Réglage du faisceau des phares

- 1 À l'aide d'un tournevis cruciforme, tournez le boulon A dans n'importe quel sens.

Mémorisez le sens dans lequel vous avez tourné et le nombre de tours.

- ▶ Véhicules sans phares à faisceau unique

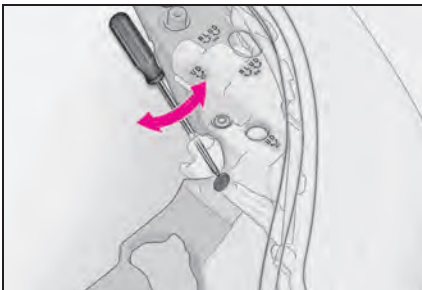

- ▶ Véhicules avec phares à faisceau unique

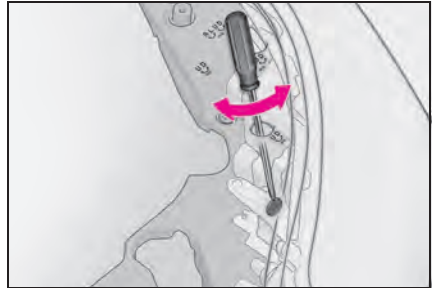

- 2 Tournez le boulon B du même nombre de tours dans le même sens qu'à l'étape 1.

Si vous n'arrivez pas à régler le phare en procédant de la sorte, confiez le véhicule à votre concessionnaire Lexus pour qu'il règle le faisceau des phares.

- ▶ Véhicules sans phares à faisceau unique

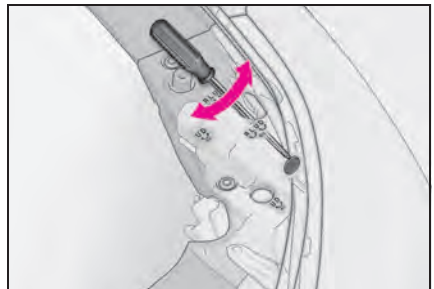

- ▶ Véhicules avec phares à faisceau unique

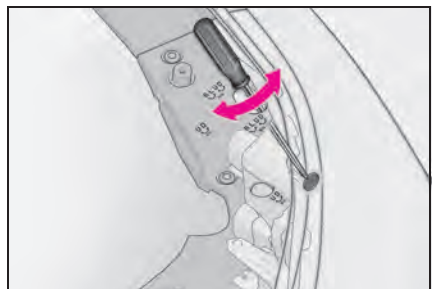

# Index

What to do if... (Troubleshooting) .....	<b>618</b>
Alphabetical Index.....	<b>620</b>

## What to do if... (Troubleshooting)

If you have a problem, check the following before contacting your Lexus dealer.

### The doors cannot be locked, unlocked, opened or closed



#### You lose your keys

- If you lose your mechanical keys, new genuine mechanical keys can be made by your Lexus dealer. (→P.548)
- If you lose your electronic keys, the risk of vehicle theft increases significantly. Contact your Lexus dealer immediately. (→P.548)



#### The electronic key does not operate properly

- Is the electronic key battery weak or depleted? (→P.501)



#### The doors cannot be locked or unlocked

- Is the power switch in ON?

When locking the doors, turn the power switch off. (→P.211)

- Is the electronic key left inside the vehicle?

When locking the doors, make sure that you have the electronic key on your person.

- The function may not operate prop-

erly due to the condition of the radio wave. (→P.141)



#### The rear door cannot be opened

- Is the child-protector lock set?

The rear door cannot be opened from inside the vehicle when the lock is set. Open the rear door from outside and then unlock the child-protector lock. (→P.123)

### If you think something is wrong



#### The hybrid system does not start

- Did you press the power switch while firmly depressing the brake pedal? (→P.208)
- Is the electronic key anywhere detectable inside the vehicle? (→P.140)
- Is the electronic key battery weak or depleted?

In this case, the hybrid system can be started in a temporary way. (→P.550)

- Is the 12-volt battery discharged? (→P.553)



#### The windows do not open or close by operating the power window switches

- Is the window lock switch pressed?

The power window except for the one at the driver's seat cannot be operated if the window lock switch is pressed. (→P.171)



The power switch is turned off automatically

- The auto power off function will be operated if the vehicle is left in ACC or ON (the hybrid system is not operating) for a period of time. (→P.211)



A warning buzzer sounds during driving

- The seat belt reminder light is flashing

Are the driver and the passengers wearing the seat belts? (→P.519, 520)

- The parking brake indicator is on  
Is the parking brake released? (→P.226)

Depending on the situation, other types of warning buzzer may also sound. (→P.516, 526)



An alarm is activated and the horn sounds

- Did anyone inside the vehicle open a door during setting the alarm?

The sensor detects it and the alarm sounds. (→P.83)

Do one of the following to deactivate or stop the alarms:

- Unlock the doors.
- Turn the power switch to ACC or ON, or start the hybrid system. (The alarm will be deactivated or stopped after a few seconds.)



A warning buzzer sounds when leaving the vehicle

- Is the message displayed on the multi-information display?

Check the message on the multi-information display. (→P.526)



A warning light turns on or a warning message is displayed

- When a warning light turns on or a warning message is displayed, refer to P.516, 526.

## When a problem has occurred



If you have a flat tire

- Stop the vehicle in a safe place and replace the flat tire with the spare tire. (→P.539)



The vehicle becomes stuck

- Try the procedure for when the vehicle becomes stuck in mud, dirt, or snow. (→P.565)

# Alphabetical Index

## A

A/C	
Air conditioning filter .....	496
Front automatic air conditioning system .....	411
Front seat concentrated airflow mode (S-Flow) .....	414
Rear air conditioning system .....	420
ABS (Anti-lock Brake System) .....	393
Warning light .....	518
ACA (Active Cornering Assist) .....	394
Active Cornering Assist (ACA) .....	394
Adaptive High-beam System .....	234
Adaptive Variable Suspension System .....	394
Advanced Park .....	356
AHS (Adaptive High-beam System) ..	234
Air conditioning filter .....	496
Air conditioning system	
Air conditioning filter .....	496
Front automatic air conditioning system .....	411
Front seat concentrated airflow mode (S-Flow) .....	414
Rear air conditioning system .....	420
Airbags	
Airbag operating conditions .....	33, 34
Airbag precautions for your child .....	35
Correct driving posture .....	27
Curtain shield airbag precautions .....	35
Front passenger occupant classification system .....	39
General airbag precautions .....	35
Modification and disposal of airbags ..	38
Side airbag precautions .....	35
Side and curtain shield airbags precautions .....	35
SRS airbags .....	32
SRS warning light .....	518
Alarm .....	83
Warning buzzer .....	516
Anchor brackets .....	51, 63

Antennas (smart access system with push-button start) .....	139
Anti-lock Brake System (ABS) .....	393
Warning light .....	518
Approach warning .....	302
Armrest .....	441
Assist grips .....	441
Audio system-linked display .....	110
Automatic headlight leveling system ..	233
Automatic light control system .....	232
Automatic transmission .....	214
M mode .....	218
Paddle shift switches .....	217, 218
Auxiliary boxes .....	430
Average fuel economy .....	105
Average vehicle speed .....	105
AWD Control .....	109

## B

Back door .....	124
Back-up light	
Wattage .....	578
Back-up lights	
Replacing light bulbs .....	507
Battery (12-volt battery)	
Battery checking .....	481
If the 12-volt battery is discharged ..	553
Preparing and checking before winter .....	402
Replacing .....	558
Warning light .....	517
Battery (traction battery) .....	77
Blind Spot Monitor (BSM) .....	319
Boost gauge .....	107
Bottle holders .....	429
Brake	
Brake hold .....	229
Fluid .....	479, 575
Parking brake .....	226
Regenerative braking .....	74
Warning light .....	516
Brake assist .....	393

Break-in tips.....	188
Brightness control	
Instrument panel light control.....	97
BSM (Blind Spot Monitor).....	319
Buzzer	
Driver monitor.....	259

## C

Camera	
Driver monitor.....	259
Care	
Exterior.....	458
Interior.....	461
Seat belts.....	461
Wheels and wheel ornaments.....	458
Cargo capacity.....	193, 196
Cargo hooks.....	431
Cargo net hooks.....	431
Chains.....	403
Child restraint system	
Fixed with a LATCH system.....	58
Fixed with a seat belt.....	54
Front passenger occupant classification system.....	39
Points to remember.....	46
Riding with children.....	45
Types of child restraint system installation method.....	51
Using a top tether anchorage.....	65
Using an anchor bracket.....	63
Child safety	
12-volt battery precautions.....	481, 559
Airbag precautions.....	35
Child restraint system.....	51
Heated steering wheel and seat heater precautions.....	422
How your child should wear the seat belt.....	29
Moon roof precautions.....	173
Panoramic moon roof precautions....	176
Power back door precautions.....	124
Power window lock switch.....	171

Power window precautions.....	170
Rear door child-protectors.....	123
Seat belt extender precautions.....	30
Seat belt precautions.....	45
Child-protectors.....	123
Cleaning	
Exterior.....	458
Interior.....	461
Radar sensor.....	254
Seat belts.....	461
Wheels and wheel ornaments.....	458
Clock.....	90, 92
Coat hooks.....	442
Coin box.....	430
Condenser.....	479
Console box.....	428
Console box light.....	428
Cooling system.....	477
Engine overheating.....	560
Hybrid system overheating.....	562
Cornering lights.....	234
Replacing light bulbs.....	507
Cruise control	
Dynamic radar cruise control.....	295
Cup holders.....	428
Current fuel consumption.....	105
Curtain shield airbags.....	32
Customizable features.....	590

## D

Daytime running light system.....	232
Daytime running lights	
Replacing light bulbs.....	507
Deck board.....	433
Defogger	
Outside rear view mirrors.....	416
Rear window.....	416
Windshield.....	415, 416
Differential	
Rear differential oil.....	575
Digital Rear-view Mirror.....	157
Dimension.....	568

Dinghy towing..... 207  
**DIRECT4**..... 394  
**Display**  
 center display..... 104  
 Dynamic radar cruise control ..... 298  
 Head-up display ..... 101, 104  
 Intuitive parking assist..... 328  
 Multi-information display..... 98, 104  
 RCD (Rear Camera Detection)..... 342  
 RCTA ..... 337  
 Warning message..... 526  
**Distance until next engine oil change** ... 96  
**Do-it-yourself maintenance**..... 465  
**Door courtesy lights**..... 424  
 Wattage..... 578  
**Door lock**  
 Power back door..... 124  
 Side doors..... 119  
 Smart access system with push-button  
 start..... 139  
 Wireless remote control..... 115  
**Doors**  
 Automatic door locking and unlocking  
 system ..... 123  
 Door glasses..... 169  
 Door lock warning buzzer ..... 120  
 Outside rear view mirrors ..... 166  
 Rear door child-protectors ..... 123  
 Side doors..... 119  
**Drive distance**..... 105  
**Driver's seat position memory**  
 Driving position memory..... 178  
 Memory recall function ..... 180  
 Power easy access system..... 178  
**Drive-Start Control (DSC)**..... 192  
**Driving**  
 Break-in tips..... 188  
 Correct driving posture..... 27  
 Driving mode select switch ..... 390  
 Hybrid vehicle driving tips..... 400  
 Procedures ..... 187  
 Winter drive tips..... 402

Driving information display ..... 105  
 Driving position memory..... 178  
 Memory recall function..... 180  
 Power easy access system ..... 178  
**Driving range** ..... 105  
**Driving support system information** ..... 110  
**DRS (Dynamic Rear Steering)** ..... 394  
**DSC (Drive-Start Control)** ..... 192  
**Dynamic radar cruise control** ..... 295  
 Warning message..... 302  
**Dynamic Rear Steering (DRS)** ..... 394

## E

**ECB (Electronically Controlled Brake System)** ..... 393  
**Eco heat/cool** ..... 414  
**EDR (Event data recorder)**..... 9  
**E-Four** ..... 394  
**Elapsed time** ..... 105  
**Electric motor (traction motor)** ..... 72  
**Electric Power Steering (EPS)** ..... 394  
 Warning light ..... 519  
**Electronic key** ..... 114, 117  
 Battery-saving function..... 140  
 If the electronic key does not operate  
 properly..... 549  
 Replacing the battery..... 501  
**Electronic sunshade**  
 Jam protection function..... 175  
 Operation..... 174  
**Electronically Controlled Brake System (ECB)** ..... 393  
**Emergency Driving Stop System** ..... 311  
**Emergency flashers**..... 510  
**Emergency, in case of**  
 If a warning buzzer sounds..... 516  
 If a warning light turns on..... 516  
 If a warning message is displayed..... 526  
 If the 12-volt battery is discharged ... 553  
 If the electronic key does not operate  
 properly..... 549  
 If the hybrid system will not start ..... 547

- If the vehicle is submerged or water on the road is rising ..... 511
- If you have a flat tire ..... 539
- If you lose your keys ..... 548
- If you think something is wrong ..... 514
- If your vehicle becomes stuck ..... 565
- If your vehicle has to be stopped in an emergency ..... 510
- If your vehicle needs to be towed ..... 513
- If your vehicle overheats ..... 560
- Energy monitor** ..... 106
- Engine**
- ACCESSORY mode ..... 211
  - Compartment ..... 473
  - Engine switch ..... 208
  - Hood ..... 471
  - How to start the hybrid system ..... 208
  - Identification number ..... 569
  - If the hybrid system will not start ..... 547
  - If your vehicle has to be stopped in an emergency ..... 510
  - Ignition switch (power switch) ..... 208
  - Overheating ..... 560
  - Power switch ..... 208
  - Tachometer ..... 90, 92
- Engine coolant**
- Capacity ..... 573
  - Checking ..... 477
  - Preparing and checking before winter ..... 402
- Engine coolant temperature gauge** 90, 92
- Engine oil**
- Capacity ..... 571
  - Checking ..... 474
  - Preparing and checking before winter ..... 402
  - Warning light ..... 517
- Engine oil maintenance data** ..... 476
- Engine oil pressure gauge** ..... 107
- Engine oil temperature gauge** ..... 107
- Engine switch (power switch)** ..... 208
- If your vehicle has to be stopped in an emergency ..... 510
- EPS (Electric Power Steering)** ..... 394
- Warning light ..... 519
- EV drive mode** ..... 212
- EV indicator** ..... 74
- Event data recorder (EDR)** ..... 9

## F

- FCTA (Front Cross Traffic Alert)** ..... 290
- Fixed with an ISOFIX lower anchorage** 60
- Flat tire**
- Tire pressure warning system ..... 485
  - Vehicles with a spare tire ..... 539
- Floor mats** ..... 26
- Fluid**
- Brake ..... 575
  - Transmission ..... 574
  - Washer ..... 480
- Fog lights**
- Switch ..... 240
- Footwell lights** ..... 424
- Front automatic air conditioning system** 411
- Front Cross Traffic Alert (FCTA)** ..... 290
- Front fog lights**
- Replacing light bulbs ..... 507
- Front passenger occupant classification system** ..... 39
- Front seats**
- Adjustment ..... 144
  - Cleaning ..... 461
  - Correct driving posture ..... 27
  - Driving position memory ..... 178
  - Head restraints ..... 152
  - Memory recall function ..... 180
  - Power easy access system ..... 178
  - Seat heaters ..... 422
  - Seat position memory ..... 178
  - Seat ventilators ..... 422
- Front side marker light**
- Light switch ..... 232

Replacing light bulbs.....	507
<b>Front side marker lights</b>	
Wattage.....	578
<b>Front turn signal lights</b>	
Replacing light bulbs.....	507
Turn signal lever .....	226
Wattage.....	578
<b>Fuel</b>	
Capacity.....	570
Fuel gauge .....	90, 92
Information.....	579
Refueling .....	247
Type.....	570
Warning light.....	519
<b>Fuel consumption</b>	
Average fuel economy .....	105
Current fuel consumption.....	105
<b>Fuel filler door</b>	
Refueling .....	247
<b>Fuel gauge.....</b>	<b>90, 92</b>
<b>Fuses.....</b>	<b>503</b>

## G

Garage door opener .....	450
Gauges.....	90
Gear Position.....	108
G-force.....	107
Glove box.....	428
Glove box light.....	428
Grocery bag hooks .....	432

## H

Hands Free Power Back Door .....	128
Head restraints.....	152
Headlight aim.....	505
<b>Headlights</b>	
Adaptive High-beam System .....	234
Light switch.....	232
Replacing light bulbs.....	507
<b>Head-up display.....</b>	<b>101</b>
Driving information display area.....	101

Settings.....	102
<b>Heated steering wheel.....</b>	<b>422</b>
<b>Heaters</b>	
Front automatic air conditioning system .....	411
Heated steering wheel.....	422
Outside rear view mirrors.....	416
Rear air conditioning system .....	420
Seat heaters.....	422
<b>High mounted stoplight</b>	
Replacing light bulbs.....	507
<b>High-voltage components .....</b>	<b>77</b>
<b>Hill-start assist control.....</b>	<b>394</b>
<b>Hood</b>	
Open.....	471
<b>Hooks</b>	
Cargo hooks.....	431
Cargo net hooks.....	431
Coat hooks .....	442
Grocery bag hooks.....	432
Retaining hooks (floor mat).....	26
<b>Horn.....</b>	<b>155</b>
<b>Hybrid battery (traction battery)</b>	
Location.....	77
Specification .....	571
Warning message.....	81
<b>Hybrid battery (traction battery) air vents .....</b>	<b>80</b>
<b>Hybrid system.....</b>	<b>72</b>
Acoustic Vehicle Alerting System .....	75
Emergency shut off system.....	80
EV drive mode.....	212
High voltage components .....	77
Hybrid system precautions.....	77
If the hybrid system will not start .....	547
Overheating.....	562
Power (ignition) switch.....	208
Predictive efficient drive .....	75
Regenerative braking .....	74
Starting the hybrid system.....	208
<b>Hybrid System Indicator.....</b>	<b>95</b>

Hybrid transmission.....	220
Paddle shift switches.....	223, 224
S mode.....	224
Hybrid vehicle driving tips .....	400

## I

I/M test .....	468
Identification	
Engine .....	569
Vehicle.....	568
If your vehicle has to be stopped in an emergency .....	510
Ignition switch (power switch) .....	208
Auto power off function .....	211
Changing the power switch modes .....	211
If your vehicle has to be stopped in an emergency .....	510
Immobilizer system.....	82
Indicators .....	88
Initialization	
Items to initialize .....	606
Maintenance .....	464, 476
Power windows.....	169
Inside rear view mirror .....	156, 157
Instrument panel light control .....	97
Intercooler .....	479
Intercooler coolant	
Checking .....	477
Interior lights.....	424
Intuitive parking assist	
Function.....	328
Warning message.....	330
ISOFIX lower anchorage .....	60

## J

Jack	
Positioning a floor jack.....	471
Vehicle-equipped jack.....	540
Jack handle .....	540
Jam protection function	
Electronic sunshade.....	175

Moon roof .....	172
Panoramic moon roof.....	175
Power back door.....	131
Power windows.....	169
Rear seats .....	146

## K

Keyless entry	
Smart access system with push-button start .....	139
Wireless remote control.....	115
Keys	
Battery-saving function.....	140
Electronic key.....	114
If the electronic key does not operate properly .....	549
If you lose your keys .....	548
Key number plate .....	114
Keyless entry .....	115, 139
Mechanical key.....	114
Power switch.....	208
Replacing the battery.....	501
Warning buzzer .....	140
Wireless remote control.....	115
Knee airbags .....	32

## L

Lane change Assist (LCA).....	276
Lane Departure Alert (LDA) .....	279
Lane Tracing Assist (LTA)	
Operation.....	271
LATCH anchors .....	58
LCA (Lane change Assist).....	276
LDA (Lane Departure Alert) .....	279
Lever	
Auxiliary catch lever .....	471
Hood lock release lever .....	471
Shift lever.....	214, 220
Turn signal lever .....	226
Wiper lever .....	241
Lexus climate concierge .....	410

<b>Lexus Safety System + 3</b>	
AHS (Adaptive High-beam System).....	234
Driver monitor.....	259
Dynamic radar cruise control.....	295
Emergency Driving Stop System.....	311
FCTA (Front Cross Traffic Alert).....	290
LCA (Lane change Assist).....	276
LDA (Lane Departure Alert).....	279
LTA (Lane Tracing Assist).....	271
PCS (Pre-Collision System).....	261
PDA (Proactive driving assist).....	285
RSA (Road Sign Assist).....	293
Traffic Jam Assist.....	313
<b>Lexus Teammate Advanced Park.....</b>	<b>356</b>
<b>License plate lights</b>	
Light switch.....	232
Replacing light bulbs.....	507
<b>Light bulbs</b>	
Replacing.....	506
<b>Lights</b>	
Automatic High Beam system.....	237
Fog light switch.....	240
Front personal lights.....	425
Headlight switch.....	232
Interior lights.....	424, 425
Interior lights list.....	424
Rear personal lights.....	425
Replacing light bulbs.....	507
Turn signal lever.....	226
Vanity lights.....	443
Wattage.....	578
<b>LTA (Lane Tracing Assist)</b>	
Operation.....	271
<b>Luggage cover.....</b>	<b>432</b>

## M

### Maintenance

Do-it-yourself maintenance.....	469
General maintenance.....	465
Maintenance data.....	568
Maintenance requirements.....	464
<b>Malfunction indicator lamp.....</b>	<b>517</b>

<b>Max cool.....</b>	<b>415</b>
<b>Max heat.....</b>	<b>415</b>
<b>Meter</b>	
Clock.....	90, 92
Hybrid System Indicator.....	95
Indicators.....	88
Instrument panel light control.....	97
Meter control switches.....	104
Meters.....	90
Multi-information display.....	98
Warning lights.....	516
Warning message.....	526
<b>Mirrors</b>	
Digital Rear-view Mirror.....	157
Inside rear view mirror.....	156
Outside rear view mirror defoggers.....	416
Outside rear view mirrors.....	166
Vanity mirrors.....	443
<b>Moon roof</b>	
Door lock linked moon roof operation.....	172
Door lock linked panoramic moon roof operation.....	175
Jam protection function.....	172
Operation.....	171
<b>Multi-information display.....</b>	<b>98</b>
Audio system-linked display.....	110
AWD Control.....	109
Boost gauge.....	107
Drive information.....	105
Driving information display.....	105
Driving support system information.....	110
Dynamic radar cruise control.....	298
Energy monitor.....	106
Engine oil pressure gauge.....	107
Engine oil temperature gauge.....	107
Gear Position.....	108
G-force.....	107
Meter control switches.....	104
Navigation system-linked display.....	110
Pop-up display.....	98
Pop-up display information.....	111

Tire pressure .....	485
Warning message .....	526
<b>My Settings</b> .....	<b>182</b>

## N

Navigation system-linked display .....	110
Noise from under vehicle .....	6

## O

“ODO TRIP” switch .....	96
Odometer .....	96
Odometer and trip meter display	
Display items .....	96
“ODO TRIP” switch .....	96
Oil	
Engine oil .....	571
Rear differential oil .....	575
Rear transaxle oil .....	575
Opener	
Fuel filler door .....	247
Hood .....	471
Outer foot lights	
Location .....	424
Replacing light bulbs .....	507
Outside door handle lights .....	424
Outside rear view mirrors	
Adjustment .....	166
BSM (Blind Spot Monitor) .....	319
Folding .....	167
Linked mirror function when reversing .....	167
Mirror position memory .....	178
Outside rear view mirror defoggers .....	416
RCTA function .....	337
Safe Exit Assist .....	323
Outside temperature .....	90, 92
Overheating .....	560

## P

Paddle shift switches ...	217, 218, 223, 224
---------------------------	--------------------

Panic mode .....	116
Panoramic moon roof	
Jam protection function .....	175
Operation .....	174
Parking assist sensors (intuitive parking assist) .....	328
Parking brake	
Operation .....	226
Parking brake engaged warning buzzer .....	228
Warning light .....	522
Warning message .....	228
Parking lights	
Light switch .....	232
Replacing light bulbs .....	507
Parking Support Brake function (for rear-crossing vehicles) .....	352
Function .....	352
Parking Support Brake function (rear pedestrians) .....	353
Function .....	353
Parking Support Brake function (static objects) .....	350
Function .....	350
PCS (Pre-Collision System)	
Function .....	261
Warning light .....	521
PDA (Proactive driving assist) .....	285
Personal lights .....	424
PKSB (Parking Support Brake) .....	345
Pop-up display information .....	111
Power back door .....	124
Hands Free Power Back Door .....	128
Smart access system with push-button start .....	125
Power control unit .....	77
Power control unit coolant	
Capacity .....	573
Checking .....	477
Preparing and checking before winter .....	402
Power easy access system .....	178

Power outlets .....	442
Power outlets (1500 W) .....	444
Power steering (Electric power steering system) .....	394
Warning light .....	519
Power switch .....	208
Auto power off function .....	211
Changing the power switch modes .....	211
Power switch (engine switch)	
If your vehicle has to be stopped in an emergency .....	510
Power windows	
Door lock linked window operation .....	170
Jam protection function .....	169
Operation .....	169
Window lock switch .....	171
Pre-Collision System (PCS)	
Function .....	261
Warning light .....	521
Predictive efficient drive .....	75

## R

Radar cruise control (dynamic radar cruise control) .....	295
Radiator .....	479
RCD (Rear Camera Detection)	
Function .....	342
RCTA	
Function .....	337
RCTA function .....	338
Rear air conditioning system .....	420
Rear Cross Traffic Alert (RCTA) .....	337
Rear door sunshades .....	443
Rear seats .....	145
Adjustment .....	146
Folding down the rear seatbacks .....	146
Head restraints .....	152
Seat heaters .....	422
Rear side marker lights	
Light switch .....	232
Replacing light bulbs .....	507

Rear turn signal lights	
Replacing light bulbs .....	507
Turn signal lever .....	226
Wattage .....	578
Rear view mirror	
Digital Rear-view Mirror .....	157
Inside rear view mirror .....	156
Outside rear view mirrors .....	166
Rear window defogger .....	416
Rear window wiper .....	245
Refueling	
Capacity .....	570
Fuel types .....	570
Opening the fuel tank cap .....	247
Regenerative braking .....	73
Remote Connect .....	70
Replacing	
Electronic key battery .....	501
Fuses .....	503
Light bulbs .....	506
Tires .....	539
Resetting the message indicating maintenance is required .....	464
Rev indicator .....	94
Rev peak .....	94
Road Sign Assist (RSA) .....	293
RSA (Road Sign Assist) .....	293

## S

Safe Exit Assist .....	323
Safety Connect .....	67
Seat belt reminder light .....	519, 520
Seat belts .....	28
Automatic Locking Retractor .....	30
Child restraint system installation .....	51
Cleaning and maintaining the seat belt .....	461
Emergency Locking Retractor .....	30
How to wear your seat belt .....	29
How your child should wear the seat belt .....	29

- Pregnant women, proper seat belt use ..... 28
- Reminder light and buzzer ..... 519, 520
- Seat belt extender ..... 29
- Seat belt pretensioners ..... 31
- SRS warning light ..... 518
- Seat heaters** ..... 422
- Seat position memory** ..... 178
- Seat ventilators** ..... 422
- Seating capacity** ..... 196
- Seats**
  - Adjustment ..... 144, 146
  - Adjustment precautions ..... 144, 145
  - Child seats/child restraint system installation ..... 45
  - Cleaning ..... 461
  - Driving position memory ..... 178
  - Folding down the rear seatbacks ..... 146
  - Head restraints ..... 152
  - Power easy access system ..... 178
  - Properly sitting in the seat ..... 27
  - Seat heaters ..... 422
  - Seat position memory ..... 178
  - Seat ventilators ..... 422
- Sensor**
  - Automatic headlight system ..... 232
  - Automatic High Beam system ..... 237
  - Digital Rearview Mirror ..... 161
  - Inside rear view mirror ..... 156
  - Intuitive parking assist ..... 328
  - LDA (Lane Departure Alert with steering control) ..... 279
  - LTA (Lane Tracing Assist) ..... 271
  - Radar sensor ..... 253, 319, 325
  - Rain-sensing windshield wipers ..... 242
  - RCTA ..... 338
- Service Connect** ..... 71
- Service plug** ..... 77
- Service reminder message** ..... 464
- Shift lever**
  - Automatic transmission ..... 214
  - Hybrid transmission ..... 220
- Shift lever light** ..... 424
- Side airbags** ..... 32
- Side doors** ..... 119
- Side marker lights**
  - Light switch ..... 232
  - Replacing light bulbs ..... 507
- Side mirrors**
  - Adjustment ..... 166
  - BSM (Blind Spot Monitor) ..... 319
  - Folding ..... 167
  - Linked mirror function when reversing ..... 167
  - Mirror position memory ..... 178
  - RCTA function ..... 337
- Side turn signal lights**
  - Replacing light bulbs ..... 507
  - Turn signal lever ..... 226
- Side windows** ..... 169
- Smart access system with push-button start**
  - Antenna location ..... 139
  - Entry functions ..... 119, 125
  - Starting the hybrid system ..... 208
- Snow tires** ..... 402
- Spare tire** ..... 539
  - Storage location ..... 540
- Spark plug** ..... 574
- Specifications** ..... 568
- Speedometer** ..... 90, 92
- Steering wheel**
  - Adjustment ..... 155
  - Heated steering wheel ..... 422
  - Meter control switches ..... 104
  - Power easy access system ..... 178
  - Steering wheel position memory ..... 178
- Stop lights**
  - Replacing light bulbs ..... 507
- Storage features** ..... 427
- Stuck**
  - If the vehicle becomes stuck ..... 565
- Sun visors** ..... 443

**Sunshade**

- Panoramic moon roof.....174
- Roof.....172

**Switches**

- Advanced Park main switch.....364
- Automatic High Beam system.....237
- Brake Hold switch.....229
- Digital Rear-view Mirror control switches.....157
- Door lock switches.....121
- Driving mode select switch.....390
- Driving position memory switches....178
- Dynamic radar cruise control switch298
- Electronic sunshade switch.....174
- Emergency flashers switch.....510
- EV drive mode switch.....212
- Fog light switch.....240
- Garage door opener switches.....450
- Heated steering wheel switch.....422
- Ignition switch.....208
- Instrument panel light control switches.....97
- Intuitive parking assist switch.....329
- Light switches.....232
- Meter control switches.....104
- Moon roof switches.....171
- "ODO TRIP" switch.....96
- Outside rear view mirror switches....166
- Paddle shift switches 217, 218, 223, 224
- Panoramic moon roof switches.....174
- Parking brake switch.....226
- PKSB (Parking Support Brake) switch.....346
- Power switch.....208
- Power window switches.....169
- RCD (Rear Camera Detection) switch.....342
- RCTA switch.....337
- Seat heater switches.....422
- Seat ventilator switches.....422
- "SOS" button.....67

- Tilt and telescopic steering control switch.....155
- Vehicle-to-vehicle distance switch..298
- VSC OFF switch.....395
- Window lock switch.....171
- Windshield wiper and washer switch241

**T**

- Tachometer.....90, 92**
  - Rev indicator.....94
  - Rev peak.....94
- Tail lights**
  - Light switch.....232
  - Replacing light bulbs.....507
- The Secondary Collision Brake.....395**
- Theft deterrent system**
  - Alarm.....83
  - Immobilizer system.....82
- Tire inflation pressure**
  - Maintenance data.....576
  - Tire inflation pressure display function.....485
  - Warning light.....520
- Tire information.....581**
  - Glossary.....585
  - Size.....583
  - Tire identification number.....582
  - Uniform Tire Quality Grading.....583
- Tire pressure display.....485**
- Tire pressure warning system**
  - Function.....485
  - Installing tire pressure warning valves and transmitters.....486
  - Registering ID codes.....490
  - Registering the position of each wheel.....487
  - Selecting wheel set.....491
  - Setting the tire pressure.....488
  - Warning light.....520
- Tires**
  - Chains.....403
  - Checking.....483

If you have a flat tire.....539  
 Inflation pressure.....493  
 Information.....581  
 Replacing.....539  
 Rotating tires.....484  
 Size.....576  
 Snow tires.....402  
 Spare tire.....539  
 Tire inflation pressure display function  
 .....485  
 Tire pressure warning system.....485  
 Warning light.....520  
**Tools.....540**  
 Top tether anchorage.....65  
 Top tether strap.....63  
 Total load capacity.....568  
**Towing**  
 Dinghy towing.....207  
 Emergency towing.....513  
 Trailer towing.....197  
**TRAC (Traction Control).....394**  
**Traction battery (hybrid battery)**  
 Hybrid battery (traction battery) air vents  
 .....80  
 Location.....77  
 Specification.....571  
 Warning message.....81  
**Traction Control (TRAC).....394**  
**Traction motor (electric motor).....72**  
**Traffic Jam Assist.....313**  
**Trail Mode.....392**  
**Trailer Sway Control.....394**  
**Trailer towing.....197**  
**Transaxle**  
 Rear transaxle oil.....575  
**Transmission**  
 Automatic transmission.....214  
 Driving mode select switch.....390  
 Hybrid transmission.....220  
 M mode.....218  
 Paddle shift switches 217, 218, 223, 224  
 S mode.....224

**Trip meters.....96**  
**Turn signal lights**  
 Replacing light bulbs.....507  
 Turn signal lever.....226  
 Wattage.....578

## U

**USB charging ports.....434**

## V

**Vanity lights.....443**  
 Wattage.....578  
**Vanity mirrors.....443**  
**VDIM (Vehicle Dynamics Integrated Management).....394**  
**Vehicle data recording.....7**  
**Vehicle Dynamics Integrated Management (VDIM).....394**  
**Vehicle identification number.....568**  
**Vehicle Stability Control (VSC).....393**  
**Ventilators (seat ventilators).....422**  
**VSC (Vehicle Stability Control).....393**

## W

**Warning buzzers**  
 ABS.....518  
 Airbags.....518  
 Approach warning.....302  
 Brake system.....516  
 Charging system.....517  
 Cruise control.....521  
 Door lock.....120  
 Downshifting.....218, 219, 224  
 Dynamic radar cruise control.....521  
 Electric power steering.....519  
 High coolant temperature.....516  
 Hybrid system overheat.....517  
 Inappropriate pedal operation.....518  
 Intuitive parking assist.....334, 520  
 LDA (Lane Departure Alert).....521

- Low engine oil pressure.....517  
 LTA (Lane Tracing Assist).....271, 521  
 Open window .....170  
 PDA (Proactive Driving Assist) .....521  
 Pre-collision system .....521  
 Pre-collision warning.....261  
 Seat belt.....519, 520  
 Tire pressure .....520  
**Warning label .....77**  
**Warning lights.....516**  
   ABS .....518  
   Brake hold operated indicator .....523  
   Brake system .....516  
   Charging system .....517  
   Cruise control indicator .....521  
   Driving assist information indicator..522  
   Dynamic radar cruise control indicator  
     .....521  
   Electric power steering .....519  
   High coolant temperature .....516  
   Hybrid system overheat warning light  
     .....517  
   Inappropriate pedal operation warning  
     light.....518  
   Intuitive parking assist OFF indicator  
     .....520  
   LDA indicator.....521  
   Low engine oil pressure.....517  
   Low fuel level .....519  
   LTA indicator.....521  
   Malfunction indicator lamp.....517  
   Parking brake indicator.....522  
   PDA indicator.....521  
   Pre-collision system .....521  
   Seat belt reminder light .....519, 520  
   Slip indicator .....522  
   SRS.....518  
   Tire pressure .....520  
**Warning messages.....526**  
**Washer**  
   Adding .....480  
   Preparing and checking before winter  
     .....402  
   Switch.....241  
**Washing and waxing.....458**  
**Weight**  
   Cargo capacity .....193, 196  
   Load limits .....196  
   Weight.....568  
**Wheels.....495**  
   Size.....576  
**Window lock switch.....171**  
**Windows**  
   Power windows.....169  
   Rear window defogger.....416  
   Washer .....241  
**Windshield wipers**  
   Position.....243  
   Rain-sensing windshield wipers.....241  
**Winter driving tips.....402**  
**Wireless charger.....435**  
**Wireless remote control**  
   Battery-Saving Function.....140  
   Locking/Unlocking .....115  
   Replacing the battery.....501

---

**For information regarding the equipment listed below, refer to the "MULTIMEDIA OWNER'S MANUAL".**

- Voice control system
- Navigation system
- Audio/visual system
- Panoramic view monitor
- Lexus parking assist monitor

## Certifications

- ▶ Smart access system with push-button start

US

FCC ID:HYQ23ABN

FCC ID:HYQ14FLC

### NOTE:

This device complies with part 15 of the FCC Rules. Operation is subject to the following two conditions: (1) This device may not cause harmful interference, and (2) this device must accept any interference received, including interference that may cause undesired operation.

### FCC WARNING:

Changes or modifications not expressly approved by the party responsible for compliance could void the user's authority to operate the equipment.

### <For 14FLC>

The FCC ID is affixed inside the equipment. You can find the ID when replacing the battery.

00

**NOTE:**

This device contains licence-exempt transmitter(s)/receiver(s) that comply with Innovation, Science and Economic Development Canada's licence-exempt RSS(s).

Operation is subject to the following two conditions:

- (1) This device may not cause interference.
- (2) This device must accept any interference, including interference that may cause undesired operation of the device.

<For 14FLC>

The IC Certification number is affixed inside the equipment. You can find the number when replacing the battery.

**NOTE:**

L'émetteur/récepteur exempt de licence contenu dans le présent appareil est conforme aux CNR d'Innovation, Sciences et Développement économique Canada applicables aux appareils radio exempts de licence.

L'exploitation est autorisée aux deux conditions suivantes :

- (1) L'appareil ne doit pas produire de brouillage;
- (2) L'appareil doit accepter tout brouillage radioélectrique subi, même si le brouillage est susceptible d'en compromettre le fonctionnement.

<Pour 14FLC>

Le numéro d'accréditation IC est apposé à l'intérieur de l'appareil. Ce numéro est visible au remplacement de la pile.

FCC ID:HYQ17EAA

**NOTE**

This device complies with part 15 of the FCC Rules. Operation is subject to the following two conditions: (1) This device may not cause harmful interference, and (2) this device must accept any interference received, including interference that may cause undesired operation.

**FCC WARNING**

Changes or modifications not expressly approved by the party responsible for compliance could void the user's authority to operate the equipment.

**CAUTION : Radio Frequency Radiation Exposure**

This equipment complies with FCC radiation exposure limits set forth for an uncontrolled environment and meets the FCC radio frequency (RF) Exposure Guidelines. This equipment should be installed and operated keeping the radiator at least 20cm or more away from person's body.

Co-location: This transmitter must not be co-located or operated in conjunction with any other antenna or transmitter.

This device contains licence-exempt transmitter(s)/receiver(s) that comply with Innovation, Science and Economic Development Canada's licence-exempt RSS(s). Operation is subject to the following two conditions:

- (1) This device may not cause interference.
- (2) This device must accept any interference, including interference that may cause undesired operation of the device.

The antenna cannot be removed (and changed) by user.

**Co-location:** This transmitter must not be co-located or operated in conjunction with any other antenna or transmitter.

**CAUTION: Radio Frequency Radiation Exposure**

This equipment complies with ISED radiation exposure limits set forth for an uncontrolled environment and meets RSS-102 of the ISED radio frequency (RF) Exposure rules. This equipment should be installed and operated keeping the radiator at least 20 cm or more away from person's body.

L'émetteur/récepteur exempt de licence contenu dans le présent appareil est conforme aux CNR d'Innovation, Sciences et Développement économique Canada applicables aux appareils radio exempts de licence. L'exploitation est autorisée aux deux conditions suivantes :

- (1) L'appareil ne doit pas produire de brouillage;
- (2) L'appareil doit accepter tout brouillage radioélectrique subi, même si le brouillage est susceptible d'en compromettre le fonctionnement.

L'utilisateur n'est pas autorisé à retirer (ou modifier) l'antenne.

**Emplacement :** Cet émetteur ne doit pas être installé ou utilisé conjointement avec d'autres antennes ou émetteurs.

**ATTENTION : exposition aux radiofréquences**

Cet équipement est conforme aux limites d'exposition aux rayonnements d'ISDE établies pour un environnement non contrôlé ainsi que la norme CNR-102 de la réglementation d'ISDE relative à l'exposition aux radiofréquences (RF). Cet équipement doit être installé et utilisé avec un minimum de 20 cm de distance entre la source de rayonnement et le corps.

- Tire pressure warning system

FCC ID: PAXPMVE000

NOTE

This device complies with part 15 of the FCC Rules. Operation is subject to the following two conditions:

- (1) This device may not cause harmful interference, and
- (2) this device must accept any interference received, including interference that may cause undesired operation.

FCC WARNING

Changes or modifications not expressly approved by the party responsible for compliance could void the user's authority to operate the equipment.

FCC ID: PAXPMVE100

NOTE

This device complies with part 15 of the FCC Rules. Operation is subject to the following two conditions: (1) This device may not cause harmful interference, and (2) this device must accept any interference received, including interference that may cause undesired operation.

FCC WARNING

Changes or modifications not expressly approved by the party responsible for compliance could void the user's authority to operate the equipment.

NOTE

This device complies with Industry Canada licence-exempt RSS standard(s). Operation is subject to the following two conditions: (1) this device may not cause interference, and (2) this device must accept any interference, including interference that may cause undesired operation of the device.

NOTE

Le présent appareil est conforme aux CNR d'Industrie Canada applicables aux appareils radio exempts de licence. L'exploitation est autorisée aux deux conditions suivantes : (1) l'appareil ne doit pas produire de brouillage, et (2) l'utilisateur de l'appareil doit accepter tout brouillage radioélectrique subi, même si le brouillage est susceptible d'en compromettre le fonctionnement.

"Perchlorate Material – special handling may apply, See [www.dtsc.ca.gov/hazardouswaste/perchlorate](http://www.dtsc.ca.gov/hazardouswaste/perchlorate)."

► Millimeter wave radar sensor

FCC ID: HYQDNMWR011

D11 US 01

**NOTE:**

This device complies with part 15 of the FCC Rules. Operation is subject to the following two conditions: (1) This device may not cause harmful interference, and (2) this device must accept any interference received, including interference that may cause undesired operation.

**FCC WARNING:**

Changes or modifications not expressly approved by the party responsible for compliance could void the user's authority to operate the equipment.

US 01

**Radiofrequency radiation exposure Information:**

This equipment complies with FCC radiation exposure limits set forth for an uncontrolled environment. This equipment should be installed and operated with minimum distance of 20 cm between the radiator (antenna) and your body. This transmitter must not be co-located or operating in conjunction with any other antenna or transmitter.

US 02

FCC ID: HYQDNMWR011

D11 US 01

**NOTE:**

This device complies with part 15 of the FCC Rules. Operation is subject to the following two conditions: (1) This device may not cause harmful interference, and (2) this device must accept any interference received, including interference that may cause undesired operation.

**FCC WARNING:**

Changes or modifications not expressly approved by the party responsible for compliance could void the user's authority to operate the equipment.

US 01

**Radiofrequency radiation exposure Information:**

This equipment complies with FCC radiation exposure limits set forth for an uncontrolled environment. This equipment should be installed and operated with minimum distance of 20 cm between the radiator (antenna) and your body. This transmitter must not be co-located or operating in conjunction with any other antenna or transmitter.

US 02

**NOTE:**

This device contains licence-exempt transmitter(s)/receiver(s) that comply with Innovation, Science and Economic Development Canada's licence-exempt RSS(s). Operation is subject to the following two conditions:

- (1) This device may not cause interference.
- (2) This device must accept any interference, including interference that may cause undesired operation of the device.

This equipment complies with ISED radiation exposure limits set forth for an uncontrolled environment and meets RSS-102 of the ISED radio frequency (RF) Exposure rules. This equipment should be installed and operated keeping the radiator at least 20 cm or more away from person's body.

CA 01

**NOTE:**

L'émetteur/récepteur exempt de licence contenu dans le présent appareil est conforme aux CNR d'Innovation, Sciences et Développement économique Canada applicables aux appareils radio exempts de licence. L'exploitation est autorisée aux deux conditions suivantes :

- (1) L'appareil ne doit pas produire de brouillage;
- (2) L'appareil doit accepter tout brouillage radioélectrique subi, même si le brouillage est susceptible d'en compromettre le fonctionnement.

Cet équipement est conforme aux limites d'exposition aux rayonnements énoncées pour un environnement non contrôlé et respecte les règles d'exposition aux fréquences radioélectriques (RF) CNR-102 de l'ISDE. Cet équipement doit être installé et utilisé en gardant une distance de 20 cm ou plus entre le dispositif rayonnant et le corps.

CA 02

- ▶ Smart access system with push-button start and immobilizer system/Advanced Park (Remote Controlled)

FCC ID: NI4TMLF19D-2

US

**NOTE**

This device complies with part 15 of the FCC Rules. Operation is subject to the following two conditions: (1) This device may not cause harmful interference, and (2) this device must accept any interference received, including interference that may cause undesired operation.

**FCC WARNING**

Changes or modifications not expressly approved by the party responsible for compliance could void the user's authority to operate the equipment.

**NOTE**

CA

This device contains licence-exempt transmitter(s)/receiver(s) that comply with Innovation, Science and Economic Development Canada's licence-exempt RSS(s). Operation is subject to the following two conditions:

- (1) This device may not cause interference.
- (2) This device must accept any interference, including interference that may cause undesired operation of the device.

811

**NOTE**

CA

L'émetteur/récepteur exempt de licence contenu dans le présent appareil est conforme aux CNR d'Innovation, Sciences et Développement économique Canada applicables aux appareils radio exempts de licence. L'exploitation est autorisée aux deux conditions suivantes:

- (1) L'appareil ne doit pas produire de brouillage;
- (2) L'appareil doit accepter tout brouillage radioélectrique subi, même si le brouillage est susceptible d'en compromettre le fonctionnement.

811

## ► Safety Connect

FCC ID : BEJTL21BNN

This device complies with part 15 of the FCC Rules and RSS-Gen of IC Rules. Operation is subject to the following two conditions:

- (1) This device may not cause harmful interference, and
- (2) this device must accept any interference received, including interference that may cause undesired operation.

Changes or modifications not expressly approved by the manufacturer (or party responsible) for compliance could void the user's authority to operate the equipment.

This equipment complies with FCC RF Radiation exposure limits set forth for an uncontrolled environment. This device and its antenna must not be co-located or operating in conjunction with any other antenna or transmitter. This equipment should be installed and operated with a minimum distance of 20 cm between the radiator and your body

IC : 2703H-TL21BNN

IC Radiation Exposure Statement:

This equipment complies with IC radiation exposure limits set forth for an uncontrolled environment.

This equipment should be installed and operated with minimum distance 20 cm between the radiator & your body.

Operation is subject to the following two conditions:

- (1) This device may not cause interference.
- (2) This device must accept any interference, including interference that may cause undesired operation of the device.

**NOTE: THE MANUFACTURER IS NOT RESPONSIBLE FOR ANY RADIO OR TV INTERFERENCE CAUSED BY UNAUTHORIZED MODIFICATIONS TO THIS EQUIPMENT. SUCH MODIFICATIONS COULD VOID THE USER'S AUTHORITY TO OPERATE THE EQUIPMENT.**

IC : 2703H-TL21BNN

Avis d'Industrie Canada sur l'exposition aux rayonnements

Cet appareil est conforme aux limites d'exposition aux rayonnements d'Industrie Canada pour un environnement non contrôlé.

Il doit être installé de façon à garder une distance minimale de 20 centimètres entre la source de rayonnements et votre corps.

L'exploitation est autorisée aux deux conditions suivantes :

- 1.L'appareil ne doit pas produire de brouillage;
- 2.L'appareil doit accepter tout brouillage radioélectrique subi, même si le brouillage est susceptible d'en compromettre le fonctionnement.

**REMARQUE: LE FABRICANT N'EST PAS RESPONSABLE DES INTERFÉRENCES RADIOÉLECTRIQUES CAUSÉES PAR DES MODIFICATIONS NON AUTORISÉES APPORTÉES À CET APPAREIL. DE TELLES MODIFICATIONS POURRAIT ANNULER L'AUTORISATION ACCORDÉE À L'UTILISATEUR DE FAIRE FONCTIONNER L'APPAREIL.**

## ► Wireless charger

FCC ID : ACJ932AT2001

### NOTE:

This device complies with part 15 and part 18 of the FCC Rules. Operation is subject to the following two conditions: (1) This device may not cause harmful interference, and (2) this device must accept any interference received, including interference that may cause undesired operation.

### FCC CAUTION

Changes or modifications not expressly approved by the party responsible for compliance could void the user's authority to operate the equipment. This equipment has been tested and found to comply with the limits for a wireless power charger, pursuant to part 18 of the FCC Rules. This equipment generates, uses and can radiate radio frequency energy and,

if not installed and used in accordance with the instructions, may cause harmful interference to radio communications. However, there is no guarantee that interference will not occur in a particular installation. If this equipment does cause harmful interference to radio communications, which can be determined by turning the equipment off and on, the user is encouraged to try to correct the interference by one or more of the following measures:

- Reorient or relocate the receiving antenna.
- Increase the separation between the equipment and receiver.
- Connect the equipment into an outlet on a circuit different from that to which the receiver is connected.

This equipment complies with FCC radiation exposure limits set forth for an uncontrolled environment and meets the FCC radio frequency (RF) Exposure Guidelines. This equipment should be installed and operated keeping the radiator at least 20cm or more away from person's body.

**NOTE:**

This device contains licence-exempt transmitter(s)/receiver(s) that comply with Innovation, Science and Economic Development Canada's licence-exempt RSS(s). Operation is subject to the following two conditions: (1) This device may not cause interference. (2) This device must accept any interference, including interference that may cause undesired operation of the device.

L'émetteur/récepteur exempt de licence contenu dans le présent appareil est conforme aux CNR d'Innovation, Sciences et Développement économique Canada applicables aux appareils radio exempts de licence. L'exploitation est autorisée aux deux conditions suivantes :

- 1) L'appareil ne doit pas produire de brouillage;
- 2) L'appareil doit accepter tout brouillage radioélectrique subi, même si le brouillage est susceptible d'en compromettre le fonctionnement.

**CAUTION:**

This equipment complies with ISED radiation exposure limits set forth for an uncontrolled environment and meets RSS-102 of the ISED radio frequency (RF) Exposure rules. This equipment should be installed and operated keeping the radiator at least 20cm or more away from person's body.

Cet équipement est conforme aux limites d'exposition aux rayonnements énoncées pour un environnement non contrôlé et respecte les règles d'exposition aux fréquences radioélectriques (RF) CNR-102 de l'ISDE. Cet équipement doit être installé et utilisé en gardant une distance de 20 cm ou plus entre le radiateur et le corps humain.

► Blind Spot Monitor

Radiofrequency radiation exposure Information:

This equipment complies with FCC and IC radiation exposure limits set forth for an uncontrolled environment. This equipment should be installed and operated with minimum distance of 20 cm between the radiator and your body.

This transmitter must not be co-located or operating in conjunction with any other antenna or transmitter.

FCC Notice:

Changes or modifications not expressly approved by the party responsible for compliance could void the user's authority to operate the equipment.

C5-002

This device contains licence-exempt transmitter(s)/receiver(s) that comply with Innovation, Science and Economic Development Canada's licence-exempt RSS(s). Operation is subject to the following two conditions:

- (1) This device may not cause interference.
- (2) This device must accept any interference, including interference that may cause undesired operation of the device.

Radiofrequency radiation exposure information:

This equipment complies with radiation exposure limits set forth for an uncontrolled environment. This equipment should be installed and operated with minimum distance of 20 cm between the radiator and your body.

C5-003

L'émetteur/récepteur exempt de licence contenu dans le présent appareil est conforme aux CNR d'Innovation, Sciences et Développement économique Canada applicables aux appareils radio exempts de licence. L'exploitation est autorisée aux deux conditions suivantes :

- (1) L'appareil ne doit pas produire de brouillage;
- (2) L'appareil doit accepter tout brouillage radioélectrique subi, même si le brouillage est susceptible d'en compromettre le fonctionnement.

Informations sur l'exposition aux rayonnements radiofréquences:  
Cet équipement est conforme aux limites d'exposition aux rayonnements définies pour un environnement non contrôlé. Cet équipement doit être installé et utilisé avec un minimum de 20 cm de distance entre la source de rayonnement et votre corps.

C5-004

► Intuitive parking assist

Product name : Intuitive parking assist

Compliance statement : This device complies with part 18 of the FCC Rules.

Responsible Party : DENSO International America, Inc.

24777 Denso Drive, P.O. Box 5047, Southfield, Michigan 48033-5244, U.S.A.

<https://www.denso.com/us-ca/en/about-us/company-information/diam/>

This ISM device complies with Canadian ICES-001.

Cet appareil ISM est conforme à la norme NMB-001 du Canada.

► Garage door opener

This device complies with FCC rules part 15 and Innovation, Science, and Economic Development Canada RSS-210. Operation is subject to the following two conditions: (1) This device may not cause harmful interference, and (2) This device must accept any interference that may be received including interference that may cause undesired operation. **WARNING:** The transmitter has been tested and complies with FCC and ISED rules. Changes or modifications not expressly approved by the party responsible for compliance could void the user's authority to operate the device.

This equipment complies with FCC and ISED radiation exposure limits set forth for an uncontrolled environment. End Users must follow the specific operating instructions for satisfying RF exposure compliance. This transmitter must be at least 20 cm from the user and must not be co-located or operating in conjunction with any other antenna or transmitter.

This device complies with FCC rules part 15 and Innovation, Science, and Economic Development Canada RSS-210. Operation is subject to the following two conditions: (1) This device may not cause harmful interference, and (2) This device must accept any interference that may be received including interference that may cause undesired operation. WARNING: The transmitter has been tested and complies with FCC and ISSED rules. Changes or modifications not expressly approved by the party responsible for compliance could void the user's authority to operate the device.

This equipment complies with FCC and ISSED radiation exposure limits set forth for an uncontrolled environment. End Users must follow the specific operating instructions for satisfying RF exposure compliance. This transmitter must be at least 20 cm from the user and must not be co-located or operating in conjunction with any other antenna or transmitter.

Cet appareil est conforme aux règlements de la FCC, section 15, et au CNR-210 d'Innovation, Sciences et Développement économique Canada. Le fonctionnement est assujéti aux deux conditions suivantes : (1) cet appareil ne doit pas causer d'interférences nuisibles et (2) cet appareil doit accepter toute interférence reçue, y compris celle qui pourrait entraîner un dysfonctionnement. MISE EN GARDE : L'émetteur a subi des tests et est conforme aux règlements de la FCC et d'ISDE. Les changements ou modifications non approuvés explicitement par la partie responsable de la conformité pourraient rendre caduque l'autorisation de l'utilisateur de se servir du dispositif.

Cet appareil est conforme aux limites d'exposition aux radiations de la FCC et d'ISDE établies pour un environnement non contrôlé. Les utilisateurs finaux doivent respecter les instructions d'utilisation spécifiques pour satisfaire aux exigences de conformité aux expositions de RF. L'émetteur doit se trouver à 20 cm au minimum de l'utilisateur et ne doit pas être situé au même endroit que tout autre émetteur ou antenne ni fonctionner avec un autre émetteur ou antenne.

## GAS STATION INFORMATION

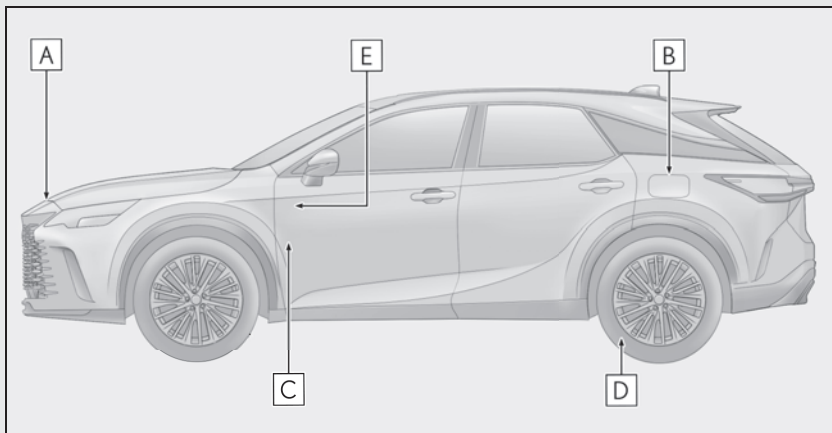

- A** Auxiliary catch lever (→P.471)
- B** Fuel filler door (→P.247)
- C** Hood lock release lever (→P.471)
- D** Tire inflation pressure (→P.576)
- E** Fuel filler door opener (→P.247)

Fuel tank capacity (Reference)	17.2 gal. (65 L, 14.3 Imp. gal.)	
Fuel type	Unleaded gasoline only	P.570 P.579
Cold tire inflation pressure		P.576
Engine oil capacity (Drain and refill — reference)		P.571
Engine oil type		P.571





Owner's Manual:  
Publication No. OM0E213U  
Part No. 01999-0E213  
Printed in the U.S.A 01-2212-00