

REVISIONS				
ECO	REV.	DESCRIPTION	DATE	APPROVED
	A	RELEASE FOR PRODUCTION	08-23-17	

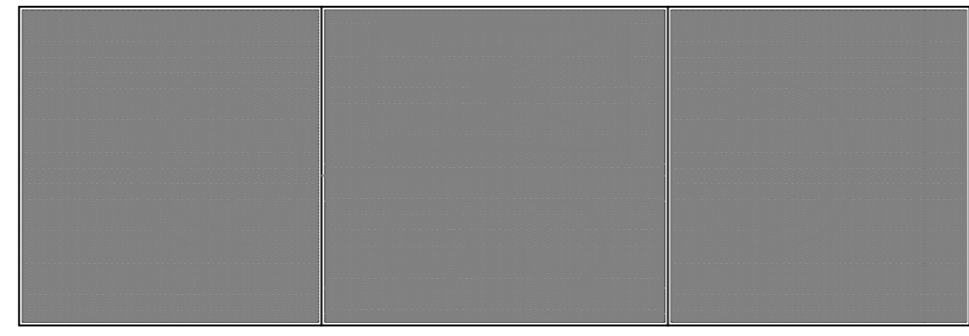
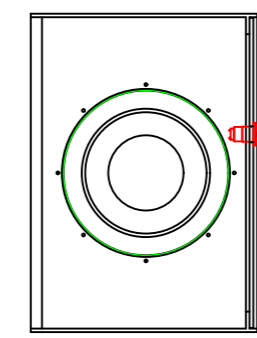
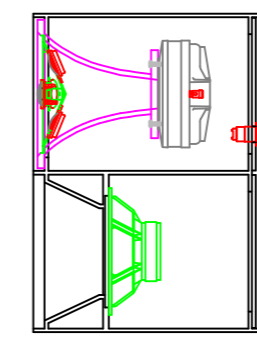
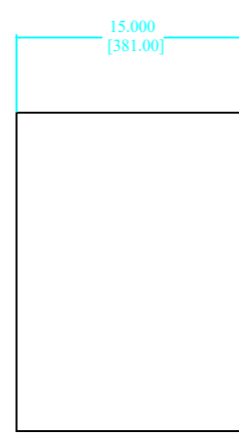
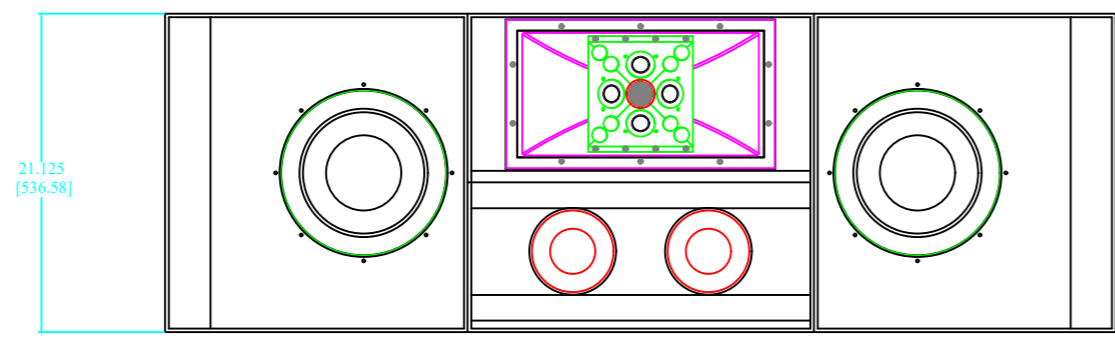
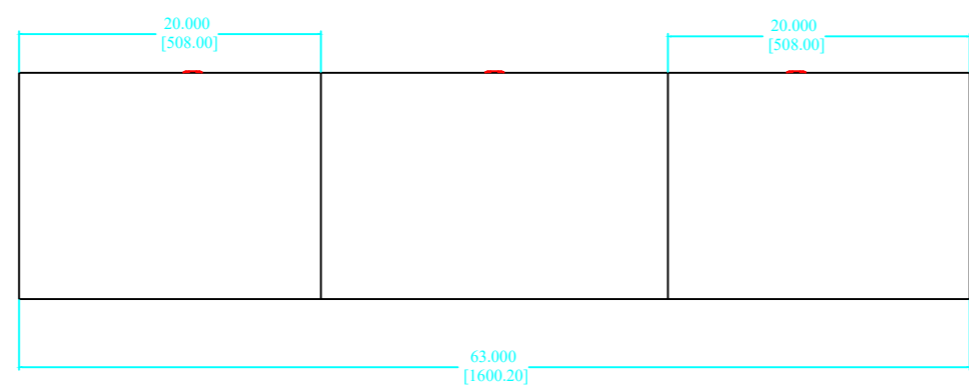
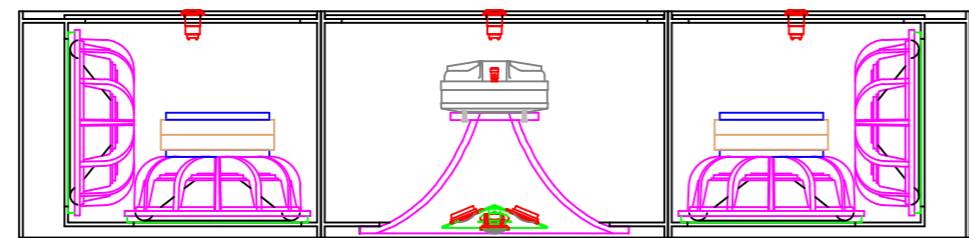
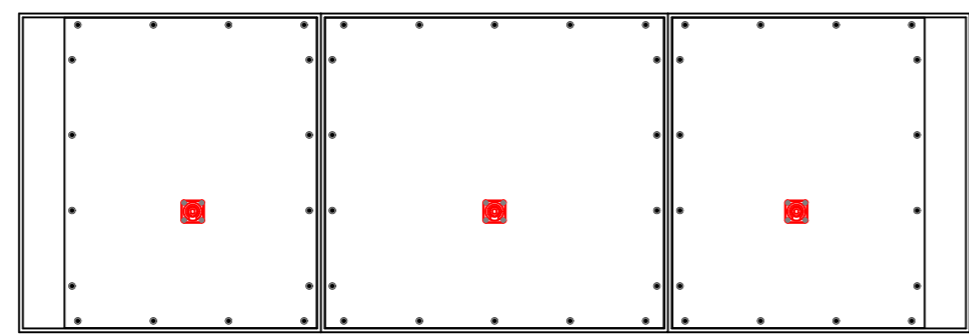

NOTES:
 1. MATERIAL: 0.25" THICK 5052 ALUMINUM UNLESS OTHERWISE SPECIFIED
 2. FINISH: TBD

JAMES LOUDSPEAKER
MAVERICK INTEGRATION CO.
 CUSTOM LR WITH BUILT IN DOUBLE 12" SUBWOOFER
 P/N: C-MQ84_S122BP DWR #: 170823-M01
 REVISED BY:
 DRAWN BY: M. PARK FILE:
 DATE: 08-23-17 SCALE:
 APPROVED:
 DRAFTING APPROVED:
DO NOT SCALE DRAWING
DRAWING NOT TO BE USED FOR CNC
 TOLERANCES: ANG: ± .5° FRACT: ± 1/32
 DECIMALS: .XX ± .01 .XXX ± .005
REVISION: A SHEET 1 OF 1